



Circulating Fluid Temperature Controller Refrigerated Thermo-cooler

Makes cooling water easily available, anytime, anywhere.

- Worldwide in voltage: Single phase 200 to 230 VAC, 50/60 Hz
- Compliant with standards:   
- Energy saving: Stop-idling function ($\pm 1^{\circ}\text{C}$ type)
Automatic facility-water-saving function (water-cooled)
- Environmentally friendly: RoHS compliant, Refrigerant R407C
- Selectable performance: Temperature stability $\pm 1^{\circ}\text{C}$ (Refrigerator ON/OFF control), $\pm 0.5^{\circ}\text{C}$ (Proportional valve PID control)
- Easy installation: No need for facility water (air-cooled), Caster, by-pass valve and strainer (water-cooled), Stainless steel drain pan available as standard equipment, No need for power supply for remote operation
- Easy maintenance: "Alarm code" display, Accessible from the front electric control panel

A variety of "Options" and "Optional Accessories" (Pages 9 to 14)

 NEW

 Newly added function

Options

- With ground fault circuit interrupter
- With communications function (RS-485)
- With communications function (RS-232C)
- With water leakage sensor
- With heater
- With automatic water supply function
- With external switch inlet
- Stainless steel wetted part for circulating fluid
- High-lift pump
- With DI control kit

Optional accessories

- Dustproof filter set
- By-pass piping set
- DI (Deionised water) filter
- Insulating material for DI (Deionised water) filter



- Cooling capacity (50 Hz):
0.9 kW / 1.9 kW / 4.5 kW (Air-cooled refrigeration / Water-cooled refrigeration)
- Temperature stability: $\pm 1^{\circ}\text{C}$ (Refrigerator ON/OFF control) /
 $\pm 0.5^{\circ}\text{C}$ (Proportional valve PID control)
- Temperature range setting: **5 to 35 $^{\circ}\text{C}$**

Series **HRGC**



CAT.EUS40-51B-UK

Energy Saving and Environmentally Friendly

Power consumption: Max. 74% reduction

When the circulating fluid reaches a certain preset temperature, the refrigerator stops temporarily (idling stop) and the temperature is adjusted even in processes where there is heat loading, performance is at least as good as that of inverter control.

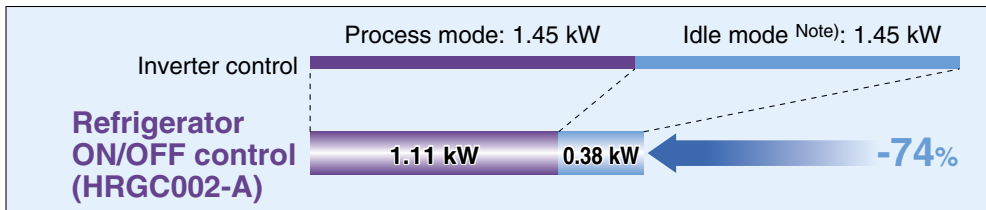

Note) Operating conditions: Process mode: Circulating fluid temperature 20°C, Heat load 2 kW
Idle mode: Circulating fluid temperature 20°C, Heat load 0 kW

- Reduced running cost
- Contribution to the environmental preservation

Refrigerant: Max. 35% reduction (SMC comparison)

Conventionally, reducing the amount of refrigerant gas has meant a reduction in cooling performance. Now, however, the use of an improved high-performance **heat exchanger** (Note) makes possible to reduce the volume of refrigerant used (refrigerant charge volume) without sacrificing cooling performance.

- More environmentally friendly

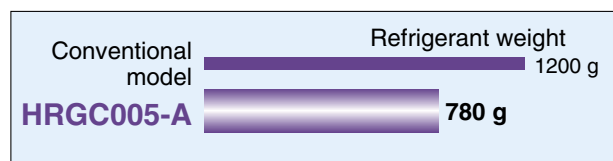

Note) HRGC005-A only

Selectable Performance

Temperature stability: $\pm 0.5^{\circ}\text{C}$ (Note 1) 3) $\pm 1.0^{\circ}\text{C}$ (Note 2) 3) (when a load is stable)

Two types of temperature control are provided: to $\pm 0.5^{\circ}\text{C}$ specifications using split flow from a three-way proportional valve, and simple temperature control to $\pm 1.0^{\circ}\text{C}$ specifications using the refrigerator ON/OFF mechanism. Choose the temperature stability that is right for your manufacturing process and method.

■ $\pm 0.5^{\circ}\text{C}$ type (HRGC002-A5)

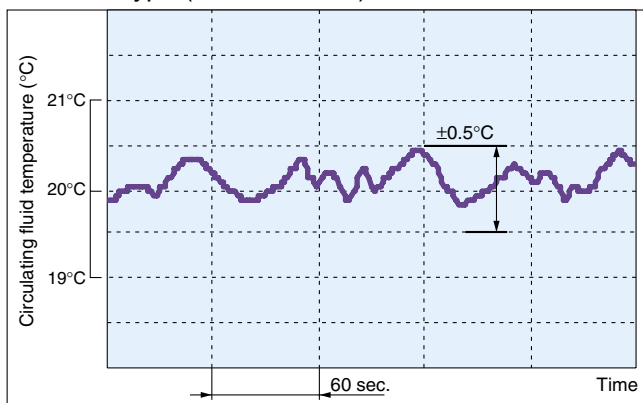

Note 1) HRGC001-□5 to HRGC005-□5 only

Note 2) HRGC001-□ to HRGC005-□

■ $\pm 1.0^{\circ}\text{C}$ type (HRGC002-A)

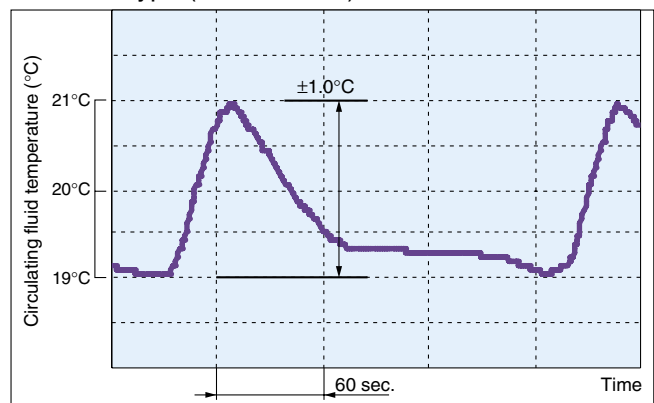

Note 3) The value shown applies to a stable load state with no outside interference.

Actual values may vary depending on the operating conditions.

Materials compatible with a wide variety of circulating fluids are used for wetted parts.

- Aqueous solution of 15% ethylene glycol
- Clear water, Deionised water (Note)

Note) Supply water with electrical conductivity of 1 $\mu\text{S}/\text{cm}$ or more.

However, the same level of electrical conductivity cannot be maintained.

Optional DI control kit (symbol Y) is available to keep electrical resistance. Refer to page 12 for details.

Easy Installation and Maintenance

Simple operation

Operation 1
Press the **START** button.

Operation 2
Adjust the temperature setting with the **UP/DOWN** keys.

Operation 3
Press the **STOP** button to shut down.
What could be easier?!

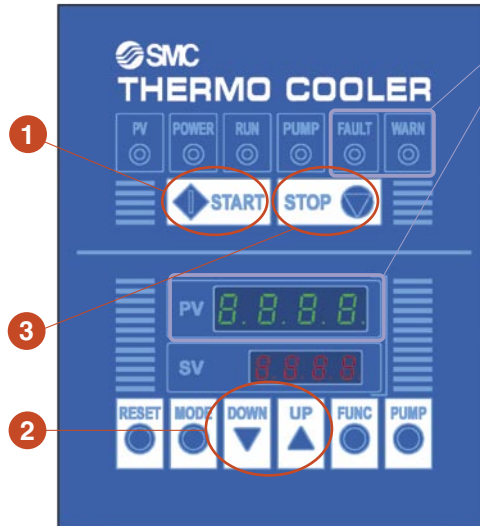

With alarm code indicators

Fault, warning and alarm code indicators for easy failure diagnosis

- Fault (FAULT) indicator (red LED)
- Warning (WARN) indicator (yellow LED)

Note) Refer to page 7 for operation display panel and alarms.

Contact input/output signal

Remote operation signal input

No need of power supply. Startup and shut-down can be remotely controlled.

Operation, shutdown, alarm signal output

Operation, shutdown, alarm signal can be output via the relay contact.

Easy maintenance

Components can be accessed from the front. The pump, refrigerator thermal relay and reset switch are located inside the electrical component enclosure.

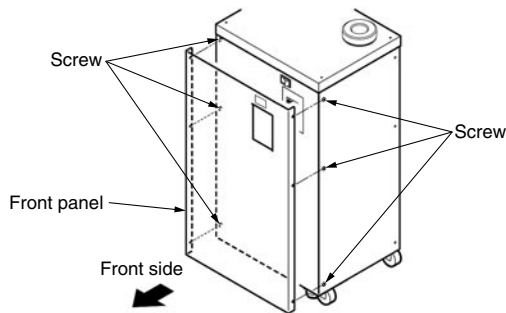

Options

- With ground fault circuit interrupter
 - With communications function (RS-485)
 - With communications function (RS-232C)
 - With water leakage sensor
 - With heater
 - With automatic water supply function
 - With external switch inlet
 - Stainless steel wetted part for circulating fluid
 - High-lift pump
 - With DI control kit
- (Refer to pages 9 to 12 for options.)

Optional accessories

Dustproof filters for the air-cooled refrigeration and by-pass piping set for preventing pressure increase are available. These improve durability and ease of use.
(Refer to pages 13 and 14 for optional accessories.)

Caster available as standard equipment

Can be used when the Thermo-cooler is carried onto the floor or moved to change the layout. Also, there is an adjuster which can be used as a stopper.

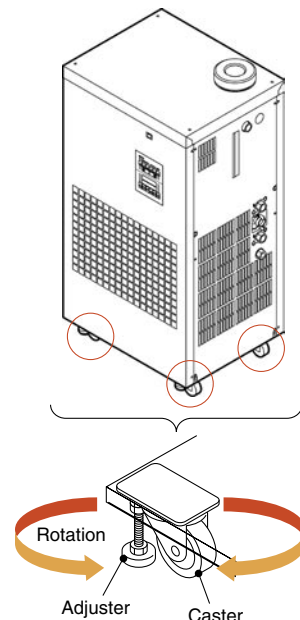

Air-Cooled Refrigeration

Air-cooled refrigeration

Unlike the water-cooled refrigeration, the air-cooled refrigeration does not require facility water, and it is easy to install alongside your equipment.

Communications

- **Communications function (RS-485, RS-232C)**
(Refer to pages 9 to 12 options.)
- **Contact input/output function**
(Refer to page 8.)

Application Examples

Semiconductor

Example: Temperature control of a chamber electrode

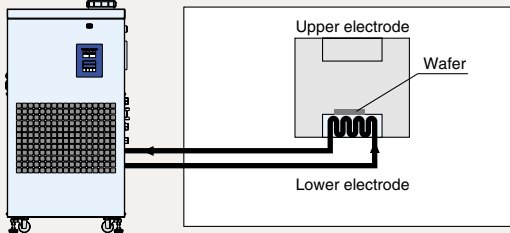

- Etching equipment
- Spatter equipment
- Cleaning equipment
- Coating equipment
- Dicing equipment
- Tester, etc.

Medical

Example: Blood preservation

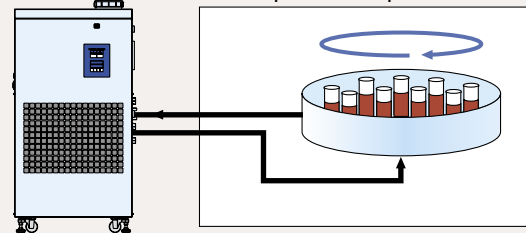

- X-ray instrument
- MRI
- Blood preservation equipment

Food

Example: Tofu (Bean curd) production

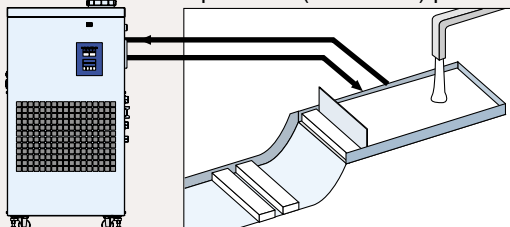

- Bottle-cleaning machine
 - Tofu (Bean curd) production equipment
 - Noodle-making machine, etc.
- Water temperature control for forming tofu by mixing the boiled soy-bean milk and bitter

Analysis

Example: Electronic microscope

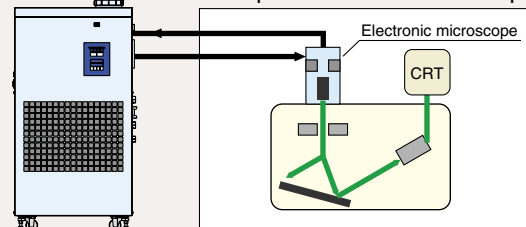

- Electron microscope
 - X-ray analytical instrument
 - Gas chromatography
 - Sugar level analytical instrument, etc.
- Prevents the distortion caused by the heat generated by the electron gun in an electronic microscope.

Machine tool

Example: Laser machining

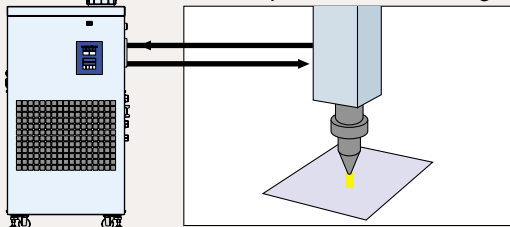

- Wire cutting
 - Grinder
 - Spot welding
 - Plasma welding
 - Laser machining, etc.
- Temperature-controlling the laser generating tube enables the laser wavelength to be optimised, improving the accuracy of the machined cross sectional area.

Printing

Example: Printing temperature control

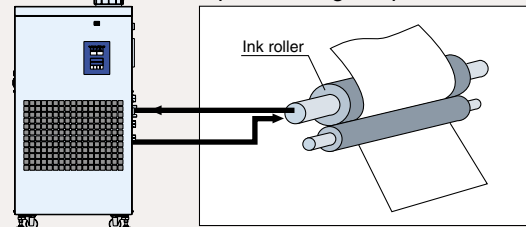

- Offset printing machine
 - Automatic developing machine
 - UV equipment, etc.
- Temperature-controlling the ink roller enables to control the evaporation amount and viscosity of an ink and optimise the tint of colours.

Moulding

Example: Injection moulding

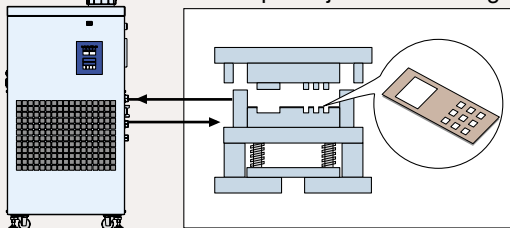

- Plastic moulding
 - Rubber moulding
 - Wire cable coating machine
 - Injection moulding, etc.
- Temperature-controlling the mold results in improved product quality.

Construction and Principles

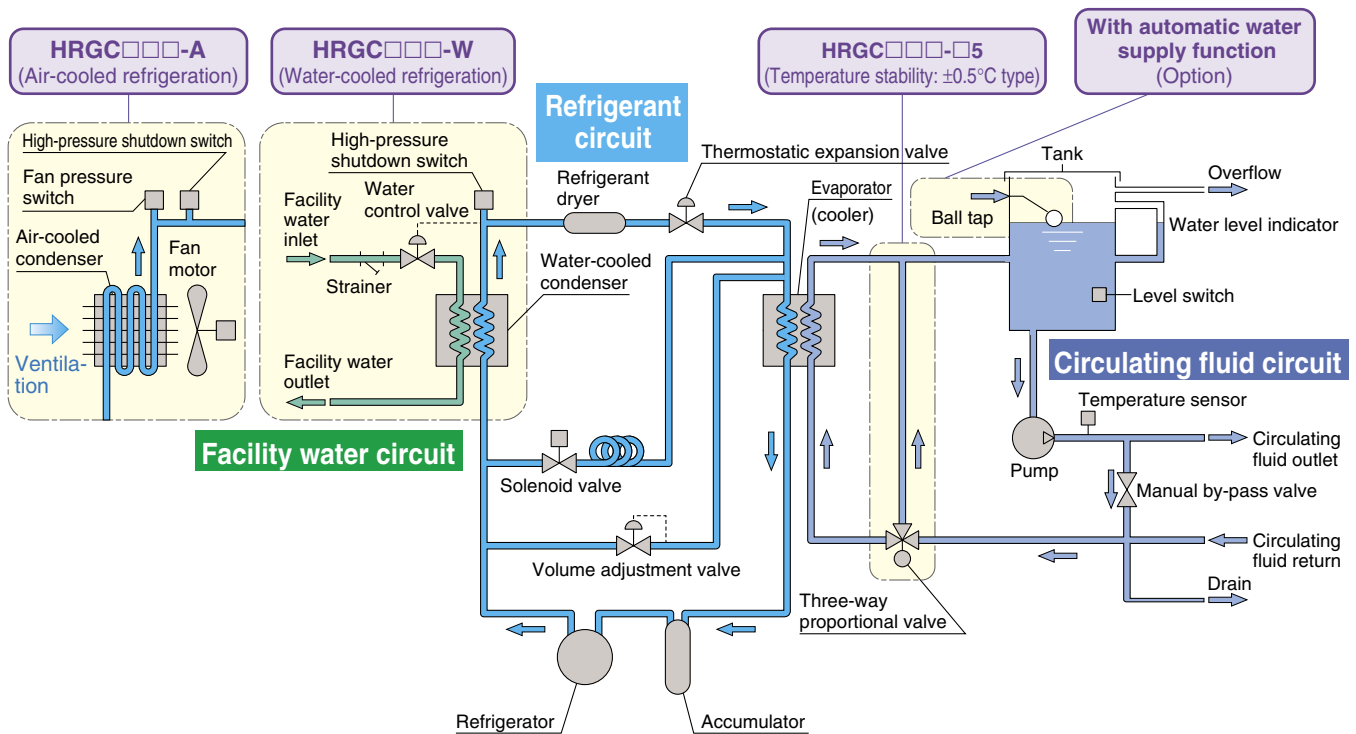

Circulating fluid circuit

With the circulating pump, the circulating fluid will be discharged to the customer's equipment side. After the circulating fluid cools the customer's equipment side, it heats up and returns to the Thermo-cooler.

Temperature stability: $\pm 0.5^{\circ}\text{C}$ type (HRGC□□□-□5)

If the temperature of the circulating fluid is higher than the preset temperature, the three-way proportional valve will return the circulating fluid to the cooler. If the temperature of the circulating fluid is lower than the preset temperature, the fluid will be returned directly to the tank.

When the temperature of the circulating fluid is nearly the same as the preset temperature, the temperature stabilises by split flow between the cooler and the tank.

Refrigerant circuit

High-temperature, high-pressure freon gas compressed by the refrigerator is made to release heat by the condenser, and turns to liquid. As the liquefied high-pressure freon passes through the thermostatic expansion valve, it expands and cools down; as it passes through the evaporator, heat is extracted from the circulating fluid and it evaporates.

The evaporated freon is once again sucked in and compressed by the refrigerator, and the above cycle is repeated.

When the circulating fluid is cooled sufficiently, the solenoid valve and volume adjustment valve open. These valves balance the refrigerant pressure and prevent freezing of the circulating fluid in excessively cold conditions.

Temperature stability: $\pm 1.0^{\circ}\text{C}$ type (HRGC□□□-□)

If the temperature of the circulating fluid is higher than the preset temperature, the refrigerator starts up, and the freon gas flows to the evaporator (cooler). This cools the circulating fluid. If the temperature of the circulating fluid is lower than the preset temperature, the refrigerator shuts down, and the flow of freon gas stops. At such times, the circulating fluid is not cooled, and the temperature rises.

Temperature stability is achieved by the refrigerator starting up and shutting down.

Facility water circuit

Cooling method: Water-cooled refrigeration (HRGC□□□-W)

When the freon gas is adequately liquefied and the circulating fluid is adequately cooled, the water control valve automatically closes the facility water circuit and adjusts the flow of facility water.

This method assures normal pressure in the refrigerator and reduces energy use by your facility water equipment.

CONTENTS

Series *HRGC*

Model Selection

- Guide to Model Selection Front matter 2
- Calculation of Required Cooling Capacity ... Front matter 3 to 4
- Precautions on Model Selection Front matter 4
- Circulating Fluid Typical Physical Property Values Front matter 4

● **Basic Model**

- How to Order/Specifications P.1 to 2
- Cooling Capacity/Pump Capacity/
Facility Water Flow Rate P.3
- Dimensions: Air-Cooled Refrigeration P.4
- Dimensions: Water-Cooled Refrigeration P.5
- Piping Connection and Installation Dimensions ... P.6
- Operation Panel Display P.7
- Alarm P.7
- Contact Input/Output Function P.8
- Other Features P.8

● **Options**

- With Ground Fault Circuit Interrupter P.9
- With Communications Function (RS-485) P.9
- With Water Leakage Sensor P.9
- With Heater P.9
- With Automatic Water Supply Function P.10
- With External Switch Inlet P.10
- Stainless Steel Wetted Part for Circulating Fluid ... P.11
- With Communications Function (RS-232C) P.11
- High-lift Pump P.12
- With DI Control Kit P.12

● **Optional Accessories**

- Dustproof Filter Set P.13
- By-pass Piping Set P.13
- DI (Deionised Water) Filter P.14
- Insulating Material for DI (Deionised Water) Filter ... P.14

Specific Product Precautions P.15 to 17

Safety Instructions Back cover

Series HRGC Model Selection

Guide to Model Selection

1. Which is best for you: a water-cooled refrigeration or an air-cooled refrigeration?

You should base your choice on the configuration of your equipment.

Thermo-cooler series refrigeration methods

Water-cooled refrigeration

Requires facility water equipment (cooling tower etc.) as well as electrical power supply. This type provides stable cooling performance year round, regardless of ambient temperature changes.

Air-cooled refrigeration

Only electrical power supply is needed.

Facility water equipment is not necessary, so the system is easy to install wherever you need it, when you need it.

(Note that ventilation or air conditioning is required to dissipate heat: for details, refer to page 15. Operating Environment / Storage Environment 3 on Specific Product Precautions 1.)

Example) Customer requirement: Air-cooled refrigeration

2. How much is the temperature in degrees centigrade for the circulating fluid?

Temperature range which can be set with the Thermo-cooler

5°C to 35°C

Example) Customer requirement: 20°C

3. What power supply frequency?

Thermo-cooler power supply frequency specifications

50 Hz, 60 Hz (common use)

Example) Customer requirement: 60 Hz

4. What is the kW for the required cooling capacity?

* To calculate the cooling capacity, refer to example 1 to 3.

Example) Customer requirement: 4.2 kW (Refer to example 1 (1).)

Selection

Example: Customer requirements 1 to 4

Cooling method : Air-cooled refrigeration
 Circulating fluid temperature: 20°C
 Power supply frequency : 60 Hz
 Required cooling capacity : 4.2 kW

Based on the results of 1 to 4, refer to the graph of cooling capacity of an air-cooled refrigeration Thermo-cooler at 60 Hz (page 3). On the same graph, plot the intersections between the customer's required temperature (20°C) and cooling capacity (4.2 kW).

[Cooling Capacity Graph] Cooling Method: Air-cooled Refrigeration, Power Supply Frequency: 60 Hz

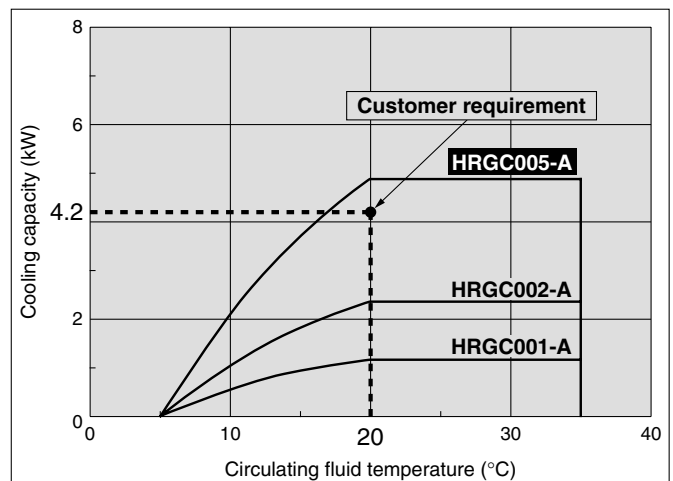

The point plotted in the graph is the requirement from your customer. Select the Thermo-cooler models exceeding this point. In this case, select the **HRGC005-A**.

Calculation of Required Cooling Capacity

Example 1: When the heat generation amount in the customer's equipment is known.

The heat generation amount can be determined based on the power consumption or output of the heat generating area — i.e. the area requiring cooling — within your facility.

(1) Derive the amount of heat generated from the power consumption.

Power consumption **P**: 3.5 [kW]

$$Q = P = 3.5 \text{ [kW]}$$

Cooling capacity = Considering a safety factor of 20%,
 $3.5 \text{ [kW]} \times 1.2 = 4.2 \text{ [kW]}$

(2) Derive the amount of heat generated from the power supply output.

Power supply output **VI**: 4.1 [kVA]

$$Q = P = V \times I \times \text{Power factor}$$

In this example, using a power factor of 0.85:

$$= 4.1 \text{ [kVA]} \times 0.85 = 3.5 \text{ [kW]}$$

Cooling capacity = Considering a safety factor of 20%,
 $3.5 \text{ [kW]} \times 1.2 = 4.2 \text{ [kW]}$

(3) Derive the amount of heat generated from the output.

Output (shaft power, etc.) **W**: 2.2 [kW]

$$Q = P = \frac{W}{\text{Efficiency}}$$

In this example, use an efficiency of 0.7:

$$= \frac{2.2}{0.7} = 3.14 \text{ [kW]}$$

Cooling capacity = Considering a safety factor of 20%,
 $3.14 \text{ [kW]} \times 1.2 \approx 3.8 \text{ [kW]}$

* The above examples calculate the heat generation amount based on the power consumption.

The actual heat generation amount may differ due to the structure of customer facilities.

Please be sure to check it carefully.

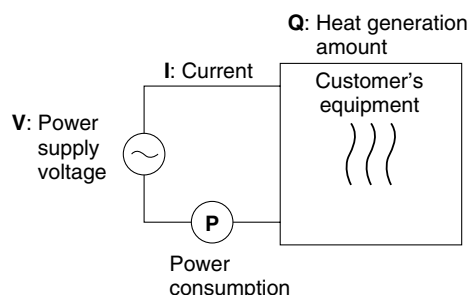

Example 2: When the heat generation amount in the customer's equipment is not known.

Obtaining the temperature difference between inlet and outlet by circulating the circulating fluid inside the

customer's equipment. equipment Q: Unknown [kW] ([kJ/s])
 Circulating fluid : Clear water*
 Circulating fluid flow rate (weight) q_m : (= $\rho \times q_v \div 60$) [kg/s]
 Circulating fluid density ρ : 1 [kg/dm³]
 Circulating fluid flow rate (volume) q_v : 25 [dm³/min]
 Circulating fluid specific heat capacity C : 4.2 [kJ/(kg·K)]
 Circulating fluid outlet temperature T₁ : 293 [K] (20 [°C])
 Circulating fluid return temperature T₂ : 295 [K] (22 [°C])
 Circulating fluid temperature difference ΔT : 2.0 [K] (= T₂ - T₁)
 Conversion factor: minutes to seconds : 60 [s/min]
 (SI units)

* Refer to front matter 4 for the typical physical property values of clear water or other circulating fluids.

$$Q = q_m \times C \times (T_2 - T_1)$$

$$= \frac{\rho \times q_v \times C \times \Delta T}{60}$$

$$= \frac{1 \times 25 \times 4.2 \times 2.0}{60}$$

$$= 3.50 \text{ [kJ/s]} \approx 3.5 \text{ [kW]}$$

Cooling capacity = Considering a safety factor of 20%,
 $3.5 \text{ [kW]} \times 1.2 = 4.2 \text{ [kW]}$

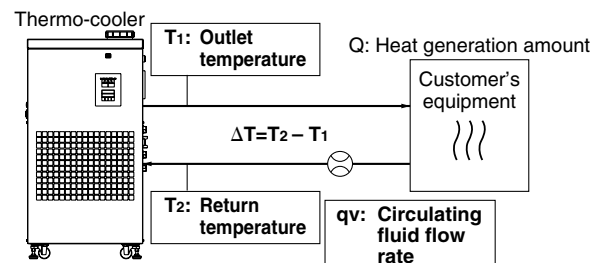

Example of the conventional measurement units (Reference)

Amount of heat generated by equipment Q : Unknown [kcal/h] → [kW]
 Circulating fluid : Clear water*
 Circulating fluid flow rate (weight) q_m : (= $\rho \times q_v \times 60$) [kgf/h]
 Circulating fluid weight: volume ratio γ : 1 [kgf/l]
 Circulating fluid flow rate (volume) q_v : 25 [l/min]
 Circulating fluid specific heat capacity C : 1.0 [kcal/(kgf·°C)]
 Circulating fluid outlet temperature T₁ : 20 [°C]
 Circulating fluid return temperature T₂ : 22 [°C]
 Circulating fluid temperature difference ΔT : 2.0 [°C] (= T₂ - T₁)
 Conversion factor: hours to minutes : 60 [min/h]
 Conversion factor: kcal/h to kW : 860 [(kcal/h)/kW]

$$Q = \frac{q_m \times C \times (T_2 - T_1)}{860}$$

$$= \frac{\gamma \times q_v \times 60 \times C \times \Delta T}{860}$$

$$= \frac{1 \times 25 \times 60 \times 1.0 \times 2.0}{860}$$

$$= \frac{3000 \text{ [kcal/h]}}{860}$$

$$\approx 3.5 \text{ [kW]}$$

Cooling capacity = Considering a safety factor of 20%,
 $3.5 \text{ [kW]} \times 1.2 = 4.2 \text{ [kW]}$

Model Selection

Calculation of Required Cooling Capacity

Example 3: When there is no heat generation, and when cooling the object below a certain temperature and period of time.

Heat dissipated by cooled substance (per unit time) Q : Unknown [kW] ([kJ/s])
 Cooled substance : Water
 Cooled substance weight m : (= ρ × V) [kg]
 Cooled substance density ρ : 1 [kg/dm³]
 Total volume of the object being cooled down V : 60 [dm³]
 Specific heat capacity of cooled substance C : 4.2 [kJ/(kg·K)]
 Temperature of cooled substance when cooling begins T₀ : 305 [K] (32 [°C])
 Cooled substance temperature after t hour T_t : 293 [K] (20 [°C])
 Cooling temperature difference ΔT : 12 [K] (=T₀ - T_t)
 Cooling time Δt : 900 [s] (= 15 [min])

* Refer to the lower right for the typical physical property value by circulating fluid.

$$Q = \frac{m \times C \times (T_t - T_0)}{\Delta t}$$

$$= \frac{\rho \times V \times C \times \Delta T}{\Delta t}$$

$$= \frac{1 \times 60 \times 4.2 \times 12}{900}$$

$$= 3.36 \text{ [kJ/s]} \approx 3.4 \text{ [kW]}$$

Cooling capacity = Considering a safety factor of 20%,

$$3.4 \text{ [kW]} \times 1.2 = \boxed{4.08 \text{ [kW]}}$$

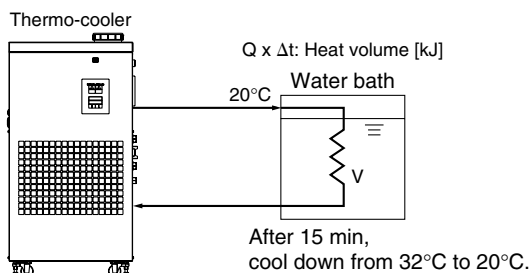

Note) This is the calculated value by changing the fluid temperature only.
 Thus, it varies substantially, depending on the water bath or piping shape.

Example of the conventional measurement units (Reference)

Heat dissipated by cooled substance (per unit time) Q : Unknown [kcal/h] → [kW]
 Cooled substance : Water
 Cooled substance weight m : (= ρ × V) [kgf]
 Cooled substance weight (volume ratio) γ : 1 [kgf/l]
 Total volume of the substance being cooled down V : 60 [l]
 Specific heat capacity of cooled substance C : 1.0 [kcal/(kgf·°C)]
 Temperature of cooled substance when cooling begins T₀ : 32 [°C]
 Cooled substance temperature after t hour T_t : 20 [°C]
 Cooling temperature difference ΔT : 12 [°C] (= T₀ - T_t)
 Cooling time Δt : 15 [min]
 Conversion factor: hours to minutes : 60 [min/h]
 Conversion factor: kcal/h to kW : 860 [(kcal/h)/kW]

$$Q = \frac{m \times C \times (T_t - T_0)}{\Delta t \times 860}$$

$$= \frac{\gamma \times V \times 60 \times C \times \Delta T}{\Delta t \times 860}$$

$$= \frac{1 \times 60 \times 60 \times 1.0 \times 12}{15 \times 860}$$

$$= \frac{2880 \text{ [kcal/h]}}{860} \approx 3.4 \text{ [kW]}$$

Cooling capacity = Considering a safety factor of 20%,

$$3.4 \text{ [kW]} \times 1.2 = \boxed{4.08 \text{ [kW]}}$$

Precautions on Model Selection

1. Heating capacity

If the circulating fluid is to be set at a higher temperature than room temperature, the circulating fluid will be heated due to heat generation of a pump in the Thermo-cooler. However, the Thermo-cooler has a lower heating capacity than a dedicated heater.

2. Pump capacity

<Circulating fluid flow>

Pump capacity varies depending on the model selected from the HRGC series. Also, circulating fluid flow varies depending on the circulating fluid discharge pressure. Consider the installation height difference between our cooler and a customer's equipment, and the piping resistance such as circulating fluid pipings, or piping size, or piping curves in the equipment. Confirm beforehand if the required flow is achieved using the pump capacity curves for each respective model.

<Circulating fluid discharge pressure>

Circulating fluid discharge pressure has the possibility to increase up to the maximum pressure in the pump capacity curves for the respective model. Confirm beforehand if the circulating fluid pipings or circulating fluid circuit of the customer's equipment are fully durable against this pressure.

Circulating Fluid Typical Physical Property Values

1. This catalogue uses the following values for density and specific heat capacity in calculating the required cooling capacity.

Density ρ : 1 [kg/dm³]
 (or, using conventional unit system, weight: volume ratio γ = 1 [kgf/l])
 Specific heat capacity C : 4.19 [kJ/(kg·K)]
 (or, using conventional unit system of units, 1 [kcal/(kgf·°C)])

2. Values for density and specific heat capacity change slightly according to temperature as shown in the below table. Use this as a reference. Note)

Water

Physical property value Temperature	Density ρ [kg/dm ³]	Specific heat C [kJ/(kg·K)]	Conventional unit system	
			Weight: volume ratio γ [kgf/l]	Specific heat C [kcal/(kgf·°C)]
5°C	1.00	4.20	1.00	1.00
10°C	1.00	4.19	1.00	1.00
15°C	1.00	4.19	1.00	1.00
20°C	1.00	4.18	1.00	1.00
25°C	1.00	4.18	1.00	1.00
30°C	1.00	4.18	1.00	1.00
35°C	0.99	4.18	0.99	1.00

Aqueous Solution of 15% Ethylene Glycol

Physical property value Temperature	Density ρ [kg/l]	Specific heat C [kJ/(kg·K)]	Conventional unit system	
			Weight: volume ratio γ [kgf/l]	Specific heat C [kcal/(kgf·°C)]
5°C	1.02	3.91	1.02	0.93
10°C	1.02	3.91	1.02	0.93
15°C	1.02	3.91	1.02	0.93
20°C	1.01	3.91	1.01	0.93
25°C	1.01	3.91	1.01	0.93
30°C	1.01	3.91	1.01	0.94
35°C	1.01	3.92	1.01	0.94

Note) The above shown are reference values.

Please contact circulating fluid manufacturers for details.

Thermo-cooler Series HRGC



How to Order

HRGC 001 - A -

Cooling capacity

001	Cooling capacity: 0.9/1.1 kW (50/60 Hz)
002	Cooling capacity: 1.9/2.3 kW (50/60 Hz)
005	Cooling capacity: 4.5/4.8 kW (50/60 Hz)

Cooling method

A	Air-cooled refrigerator type
W	Water-cooled refrigerator type

Temperature stability

—	±1.0°C
5	±0.5°C

Option

—	None
B	With ground fault circuit interrupter
C	With communications function (RS-485)
S	With communications function (RS-232C)
E	With leakage breaker
H	With heater
J	With automatic water supply function
K	With external switch inlet
M	Stainless steel wetted part for circulating fluid
T	High-lift pump
Y	With DI control kit

* Refer to pages 9 to 12 for the specifications of each option.

Piping thread type

—	Rc
F	G (PT-G conversion fitting is included)
N	NPT (PT-NPT conversion fitting is included)

Options and Combinations

Symbol <small>Note 1)</small>	B	C	S	E	H	J	K	M	T	Y
Options <small>Note 2)</small>	With ground fault circuit interrupter	<small>Note 3)</small> With communications function (RS-485)	<small>Note 3) Note 5)</small> With communications function (RS-232C)	With water leakage sensor	<small>Note 4)</small> With heater	With automatic water supply function	<small>Note 5)</small> With external switch inlet	<small>Note 4)</small> Stainless steel wetted part for circulating fluid	High-lift pump	<small>Note 4)</small> With DI control kit
Size										
HRGC001-□ (Temperature stability ±1.0°C)	●	●	●	●	●	●	●	●	●	●
HRGC001-□5 (Temperature stability ±0.5°C)	●	●	●	●	—	●	●	—	●	—
HRGC002-□ (Temperature stability ±1.0°C)	●	●	●	●	●	●	●	●	●	●
HRGC002-□5 (Temperature stability ±0.5°C)	●	●	●	●	—	●	●	—	●	—
HRGC005-□ (Temperature stability ±1.0°C)	●	●	●	●	●	●	●	●	—	●
HRGC005-□5 (Temperature stability ±0.5°C)	●	●	●	●	—	●	●	—	—	—

Note 1) When multiple options are combined, display symbols in alphabetical order.

Note 2) Refer to pages 9 to 12 for details of options.

Note 3) Option C (with communications function (RS-485)) and option S (with communications function (RS-232C)) cannot be combined.

Note 4) Option M (stainless steel wetted part for circulating fluid) and option Y (with DI control kit) cannot be combined.

When combined with option H (with heater), circulating-fluid temperature will be between 5°C and 35°C.

Note 5) Option K (with external switch inlet) and option S (with communications function (RS-232C)) cannot be combined.

Series HRGC

Specifications (Refer to the product specifications for details.)

HRGC001, 002, 005

Model		HRGC001		HRGC002		HRGC005	
Cooling method		Air-cooled refrigeration	Water-cooled refrigeration	Air-cooled refrigeration	Water-cooled refrigeration	Air-cooled refrigeration	Water-cooled refrigeration
Refrigerant		R407C (HFC)					
Control method		Refrigerator ON/OFF control or Proportional valve PID control					
Ambient temperature/humidity <small>Note 1)</small>		Temperature: 5 to 40°C, Humidity: 30 to 70%RH					
Circulating fluid system	Circulating fluid <small>Note 2)</small>	Clear water, Deionised water, Aqueous solution of 15% ethylene glycol					
	Circulating method	For externally sealed circuit					
	Temperature range setting <small>Note 1)</small> °C	5 to 35					
	Cooling capacity <small>Note 3)</small> (50/60 Hz) kW	0.9/1.1 (at 20°C)	0.9/1.1 (at 20°C)	1.9/2.3 (at 20°C)	1.9/2.3 (at 20°C)	4.5/4.8 (at 20°C)	4.5/4.8 (at 20°C)
	Heating capacity <small>Note 4)</small> kW	—	—	—	—	—	—
	Temperature stability <small>Note 5)</small> °C	±1.0 (Refrigerator ON/OFF control), ±0.5 (Proportional valve PID control)					
	Pump capacity <small>Note 6)</small> (50/60 Hz) MPa	0.13/0.18 (at 10 ℓ/min)				0.21/0.32 (at 23 ℓ/28 ℓ/min)	
	Rated flow <small>Note 7)</small> (50/60 Hz) ℓ/min	10/10				23/28	
	Tank capacity ℓ	Approx. 10				Approx. 20	
	Port size	Rc1/2					
Wetted parts material	Stainless steel, PPE, PVC, Copper brazing (Heat exchanger), Bronze, Brass						
Facility water system	Temperature range °C	—	5 to 32	—	5 to 32	—	5 to 32
	Pressure range MPa	—	0.3 to 0.5	—	0.3 to 0.5	—	0.3 to 0.5
	Required flow rate <small>Note 8)</small> (50/60 Hz) ℓ/min	—	10/12	—	10/12	—	27/28
	Port size	—	Rc1/2	—	Rc1/2	—	Rc1/2
	Wetted parts material	Stainless steel, PVC, Copper brazing (heat exchanger), Bronze, Brass					
Electrical system	Power supply	Single-phase 200 to 230 VAC 50/60 Hz Allowable voltage fluctuation ±10%					
	Applicable ground fault circuit interrupter capacity <small>Note 9)</small> A	15		15		30	
	Maximum operating current A	8.1	7.8	8.6	8.0	17.2	14.1
	Rated power consumption <small>Note 11)</small> (50/60 Hz) kW	0.76/0.82	0.68/0.73	1.13/1.20	0.89/0.98	2.07/2.23	1.76/1.83
	Remote operation signal input	Relay contact input (operates when the switch is closed, stops when the switch is opened)					
	Operation signal output	Relay contact output (switch closed when operating, switch open when stopped, switch open when shut down)					
	Alarm stop signal output	Relay contact output (switch closed when alarm is turned off, switch open when alarm is turned on, switch closed when shut down)					
	Alarm	Refer to page 7.					
Weight <small>Note 10)</small> kg	75	75	75	75	110	110	

Note 1) It should have no condensation.

During seasons or in locations where the ambient temperature is likely to fall below the freezing point, please consult SMC separately.

Note 2) If clear water is to be used, please use water that conforms to Clear Water Quality Standard of the Japan Refrigeration and Air Conditioning Industrial Association (JRA GL-02-1994 cooling water system - circulating type - make-up water).

Deionised water can be used only for supply water. Supply water with electrical conductivity of 1 μS/cm or more. (Electrical resistivity: 1 MΩ·cm or less) An optional DI control kit (symbol Y) is available to maintain electrical resistance. Refer to page 12 for details. If ethylene glycol aqueous solution is used, concentration must be 15%.

Note 3) ① Ambient temperature: 32°C, Facility water temperature: 25°C (water-cooled refrigeration), ② Circulating fluid temperature: 20°C,

③ Circulating fluid flow rate: Values at circulating fluid rated flow rate.

Note 4) Thermo-cooler specifications do not have heating capability.

(When heating capability is required, use a product with an optional heater (symbol H). Refer to page 9 for details.)

Note 5) Temperature at the Thermo-cooler outlet when the circulating fluid has a rated flow, and the facility water with the circulating fluid supply and return are directly connected. The installation environment, power supply and facility water should be stable within the specified range.

Note 6) Capacity of the Thermo-cooler outlet when the circulating fluid temperature is at 20°C.

Note 7) Required flow for cooling capacity or maintaining the temperature stability.

When used below the rated flow, open the standard manual by-pass valve and maintain a circulating fluid flow rate equivalent to the rated flow.

Also use the by-pass piping set sold separately.

Note 8) Required flow when a load is applied as shown in the cooling capacity when the facility water temperature is at 25°C.

Note 9) Purchase a ground fault circuit interrupter with current sensitivity of 30 mA separately. (Optional circuit breaker (symbol B) is also available. Refer to page 9.)

Note 10) Weight in the dry state, without circulating fluids.

Note 11) In case of refrigerator ON/OFF control. For other conditions, refer to Note 3).

Accessories (Enclosed)

Content	Applicable model
Eye bolts M12 (4 pcs.)	HRGC005
Y-type strainer (1 pc.)	Water-cooled type

• Eye bolts are included in HRGC005. (Not assembled)

• A Y-type strainer is included in the water cooled type. (Not assembled)

Cooling Capacity

HRGC001-A, HRGC001-W

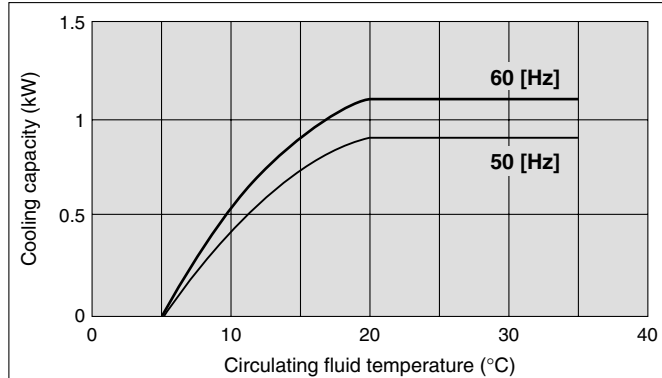

HRGC002-A, HRGC002-W

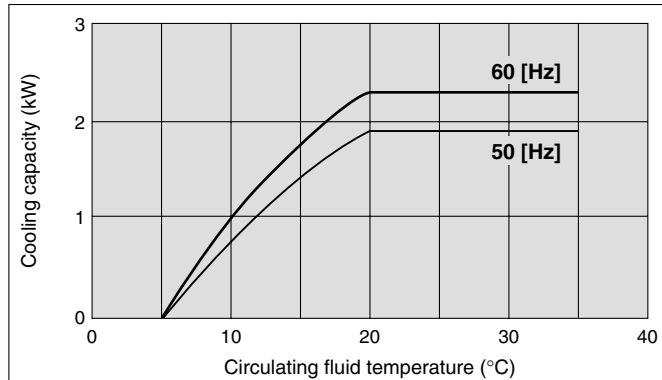

HRGC005-A, HRGC005-W

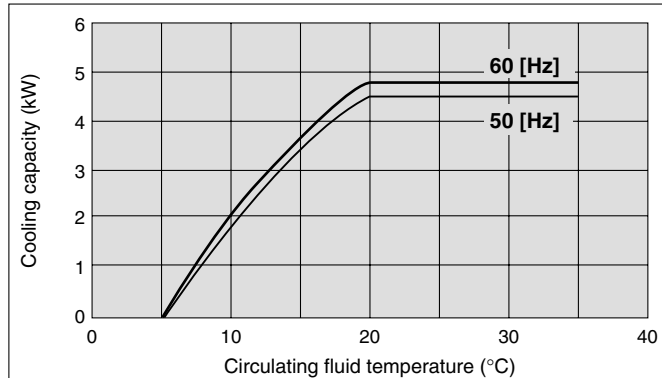

Pump Capacity

**HRGC001-A, HRGC001-W
HRGC002-A, HRGC002-W**

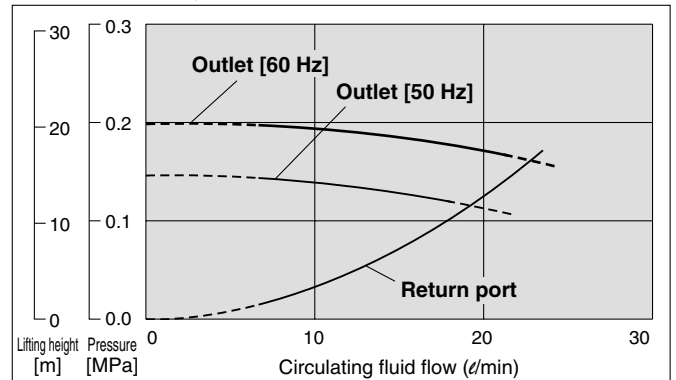

HRGC005-A, HRGC005-W

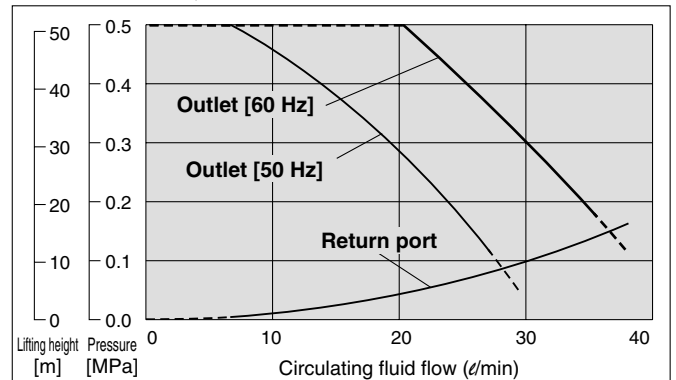

* For all common models, temperature stability will decline in the flow rate range where circulating fluid is deduced (dotted line).

Facility Water Flow Rate

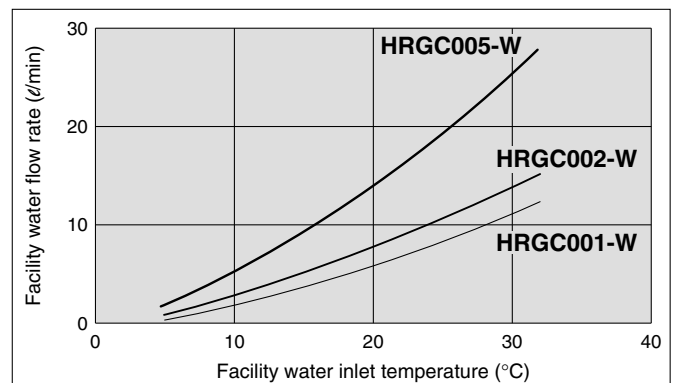

* This is the flow rate of facility water at the rated cooling capacity and circulating fluid flow, operating at 60 Hz.

Series HRGC

Dimensions: Air-Cooled Refrigeration

HRGC001-A □
HRGC002-A □

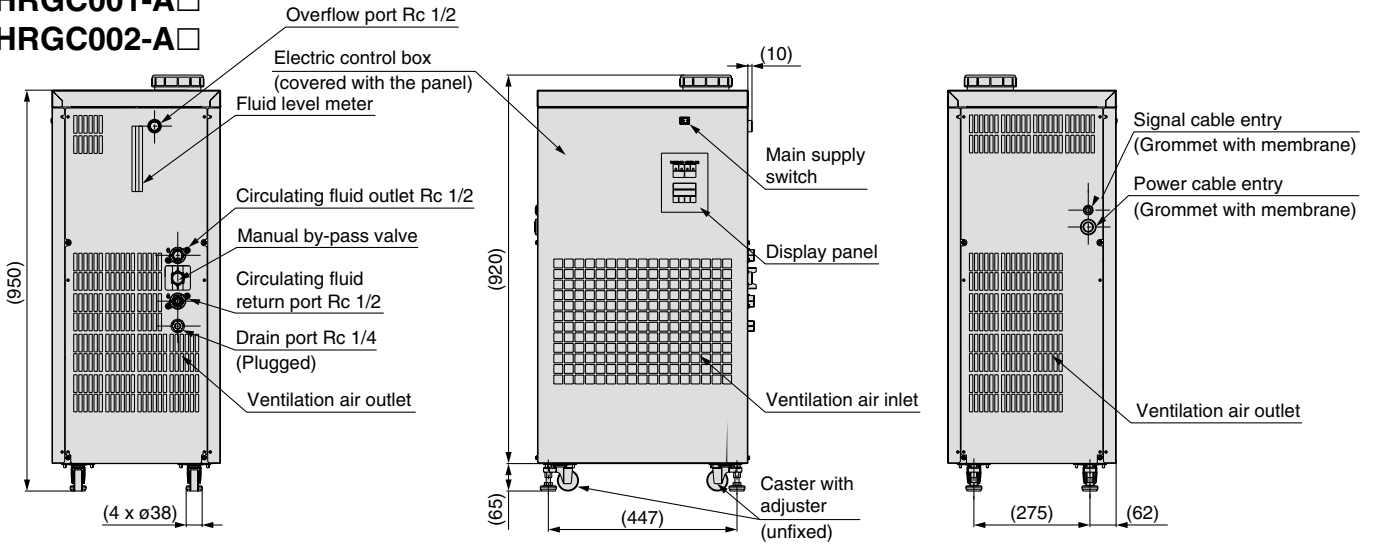

HRGC005-A □

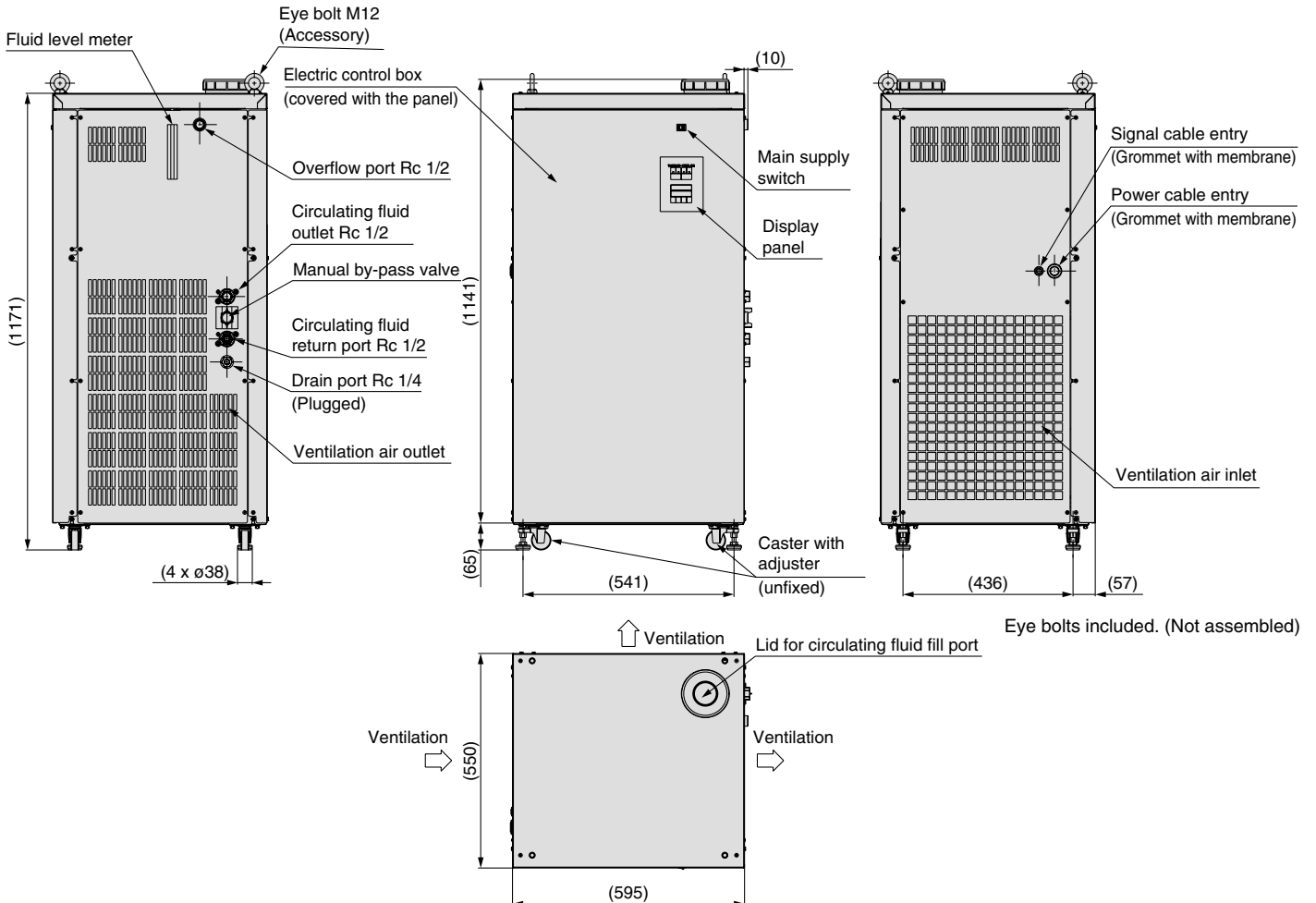

Dimensions: Water-Cooled Refrigeration

HRGC001-W □

HRGC002-W □

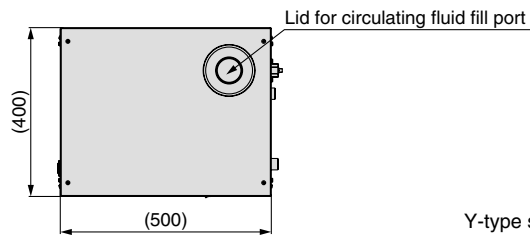
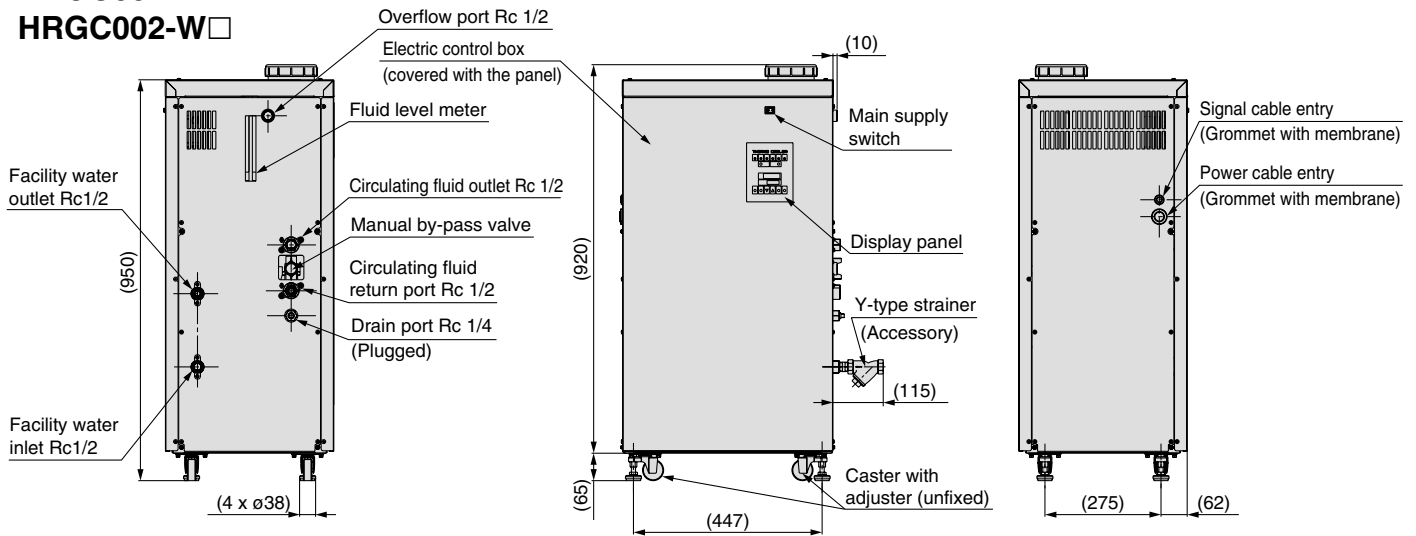

Y-type strainer included. (Not assembled)

HRGC005-W □

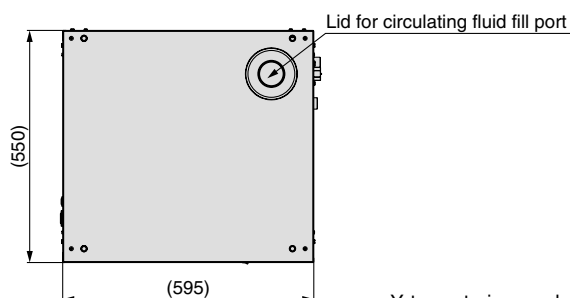
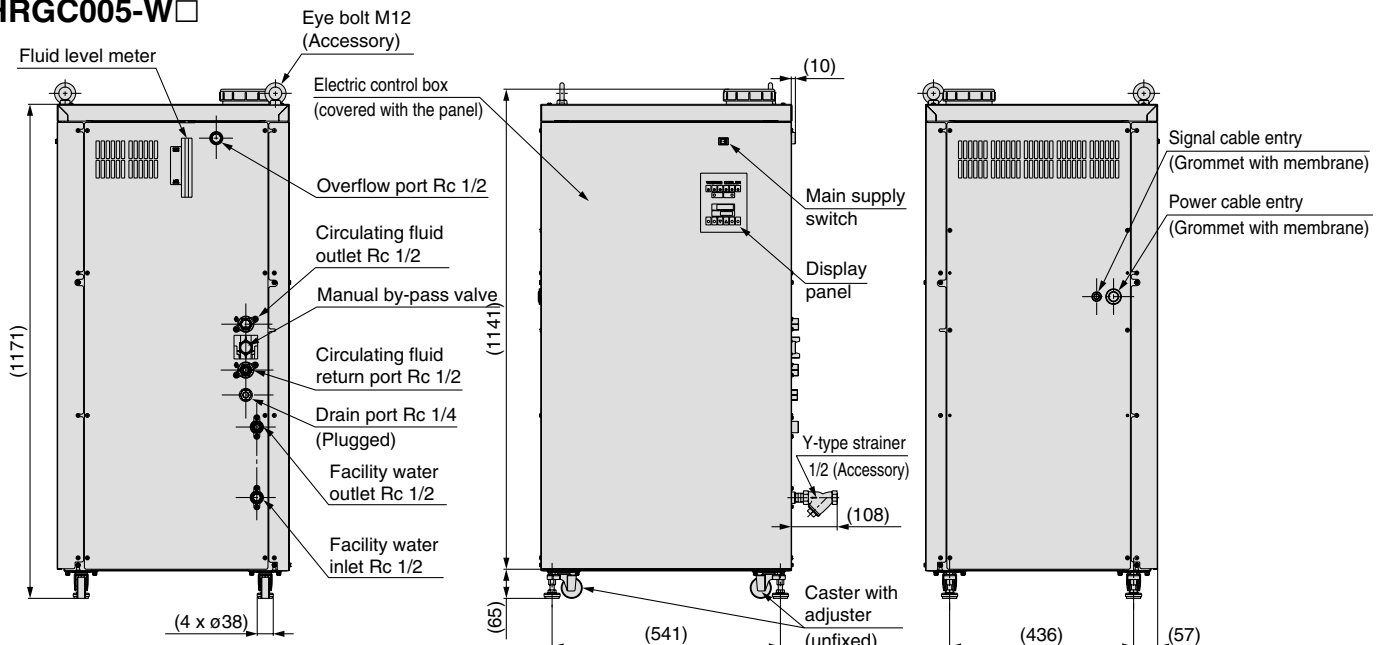

Y-type strainer and eye bolts included. (Not assembled)

Series HRGC

Piping Connection and Installation Dimensions

HRGC001, HRGC002

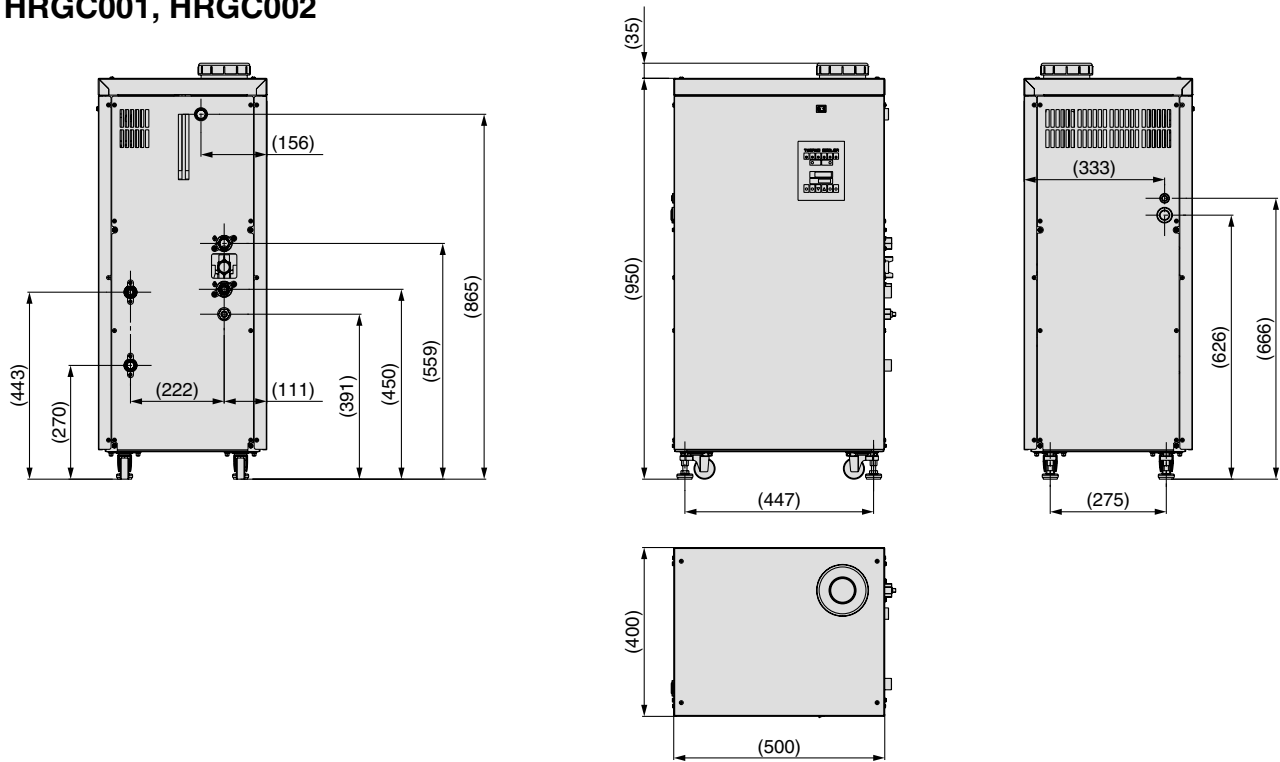

* Example figure: HRGC001-W

HRGC005

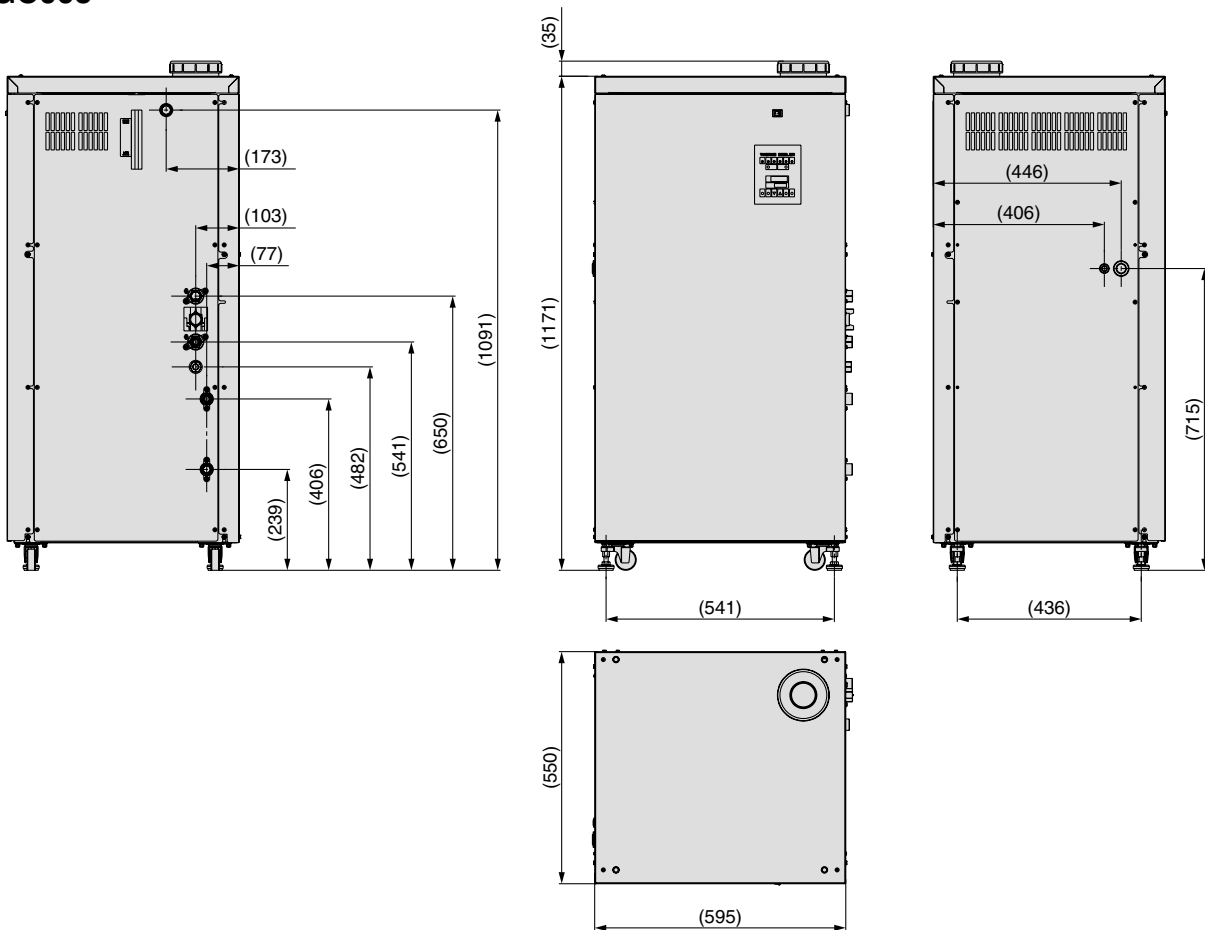

* Example figure: HRGC005-W

Operation Panel Display

HRGC001, HRGC002, HRGC005

The basic operation of this product is performed on the front operation display panel.

This operation display panel is common to all models.

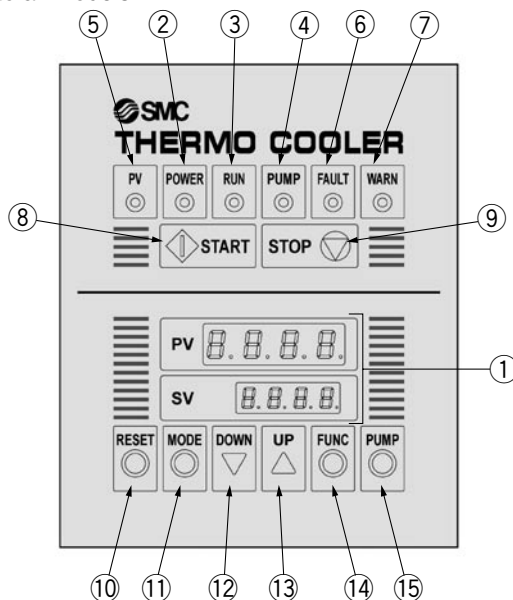

No.	Description	Function	
①	Digital display PV/SV	PV	Displays the circulating fluid temperature. Displays the alarm code when an alarm is active.
		SV	Displays the set temperature of the circulating fluid.
②	[POWER] indicator	Lights up when the power is supplied.	
③	[RUN] indicator	Lights up when the [START] key is pressed.	
④	[PUMP] indicator	Lights up when the pump is running.	
⑤	[PV] indicator	Lights up when the circulating fluid temperature is displayed.	
⑥	[FAULT] indicator	Lights up when the emergency error occurs, and stops the operation.	
⑦	[WARN] indicator	Lights up when the warning error occurs, and continues the operation.	
⑧	[START] key	Starts the operation.	
⑨	[STOP] key	Stops the operation.	
⑩	[RESET] key	Resets the alarm.	
⑪	[MODE] key	Changes settings such as the offset function, etc.	
⑫	[DOWN] key	Decreases the set temperature.	
⑬	[UP] key	Increases the set temperature.	
⑭	[FUNC] key	Changes the display between the circulating fluid temperature and optional functions.	
⑮	[PUMP] key	Operates the pump independently while pressed.	

Alarm/Alarm Indicators and Explanations of Alarms

The 6 basic temperature controller alarms are displayed on the PV of the operation display panel with their alarm codes, as well as the fault (FAULT) indicator (red LED) and warning (WARN) indicator (yellow LED).

When the source of the problem has been eliminated, the equipment must be restarted.

■ Explanations of Alarms (HRGC001/002/005)

Indicator	Alarm	Operation status	Main reason
[FAULT]	Low level of fluid in tank	Stop	Level switch activated because fluid level in tank fell below LOW.
	Rise in coolant pressure	Stop	Pressure switch activated because inadequate heat dissipation caused refrigerant pressure to rise.
	Circulating fluid temperature abnormally high	Stop	Temperature sensor activated because circulating fluid temperature became too high. (fixed at 40°C)
	Overload of pump	Stop	Circulation pump overload relay activated.
	Overload of refrigerator	Stop	Refrigerator overload relay activated.
[FAULT/WARN]	Abnormal circulating fluid temperature	Stop/Continue operation	Circulating fluid temperature is out of the customer's preset range.

Series HRGC

Contact Input/Output Function

The thermo-cooler is standard-equipped with terminals that allow remote start/stop, and enable output of an operation signal, abnormal status stop signal or alarm signal. These should be used for synchronising startup and shutdown with your other equipment, or when adding new warning lights or buzzers. However, the contact output volume is limited, so please add warning lights and/or buzzers for special relays (for amplification) if they are necessary.

Item		Specifications		
		HRGC001	HRGC002	HRGC005
Connector type		M3 terminal block		
Remote operation signal input	Signal type	Relay contact input (Remote start when the contact signal is closed, Remote stop when the contact signal is open.)		
	Input voltage range	24 VDC±10% (Power supply is provided on the Thermo-cooler side.)		
	Input current	Max. 35 mA		
	Terminal number	1 (24 VDC), 2 (24 VCOM)		
Abnormal status stop signal output	Signal type	Relay contact output (When fault error (FAULT) occurs: open)		
	Contact capacity	250 VAC, 1 A (Resistance load)		
	Terminal number	3, 4		
Operation signal output	Signal type	Relay contact output (When operating: closed)		
	Contact capacity	250 VAC, 1 A (Resistance load)		
	Terminal number	5, 6		
Warning signal output	Signal type	Relay contact output (When warning error (WARN) occurs: open)		
	Contact capacity	250 VAC, 1 A (Resistance load)		
	Terminal number	7, 8		
Communications function (RS-485) (Note)	Communication standard	EIA standard RS-485 compliant		
	Information orientation	Half duplex		
	Synchronisation method	Asynchronous communication		
	Terminal number	9, 10		
Circuit diagram		<p>Terminal block (14 poles)</p>		

Note) Serial communication is optional. Refer to "Options" on page 9.

Input/output signal connection location

Remove the front panel, and connect a signal cable to the terminal block inside the electrical component enclosure.

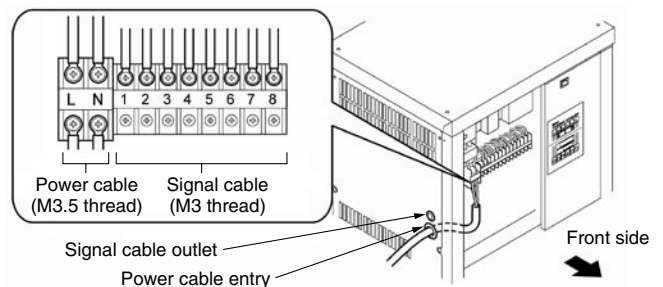

Other Features

Anti-freezing function

This function detects the circulating fluid temperature. If the temperature approaches the freezing point, e.g. in winter at night, the pump operates automatically and the heat generated by the pump warms the circulating fluid, preventing freezing.

Series HRGC Options

Note) Options have to be selected when ordering the Thermo-cooler. It is not possible to add them after purchasing the unit.

B Option symbol

With Ground Fault Circuit Interrupter

HRGC - - **B**

With ground fault circuit interrupter

In the event of a short circuit, overcurrent or overheating, the ground fault circuit interrupter will automatically shut off the power supply.

Breaker mounting location

Remove the front panel. The ground fault circuit interrupter is mounted inside the electrical component enclosure.

Option combination (○: Available, ×: Not available, ●: Possible, but specification needs to be modified partially.)

Symbol	5	B	C	E	H	J	K	M	S	T	Y
Options	Temperature stability ±0.5°C	With ground fault circuit interrupter	With communications function (RS-485)	With water leakage sensor	With heater	With automatic water supply function	With external switch inlet	Stainless steel wetted part for circulating fluid	With communications function (RS-232C)	High-lift pump	With DI control kit
Combination possibility with options	○	○	○	○	●	○	○	○	○	●	○

Applicable model	HRGC001- <input type="checkbox"/> <input type="checkbox"/> -B	HRGC002- <input type="checkbox"/> <input type="checkbox"/> -B	HRGC005- <input type="checkbox"/> <input type="checkbox"/> -B
Pole number	2		
Rated current sensitivity (mA)	30		
Rated shutdown current (A)	15/20 (Note)		30
Short circuit display method	Mechanical button		

Note) When option H or T is included.

C Option symbol

With Communications Function (RS-485)

HRGC - - **C**

With communications function (RS-485)

The communications function allows you to set (write) or monitor (read) the circulating fluid temperature.

<Writing> Circulating fluid temperature setting (SV)

<Readout> Circulating fluid present temperature (PV)
Circulating fluid temperature setting (SV)

Communication connection location

Remove the front panel, and connect your communication cable to the terminal block mounted inside the electrical component enclosure.

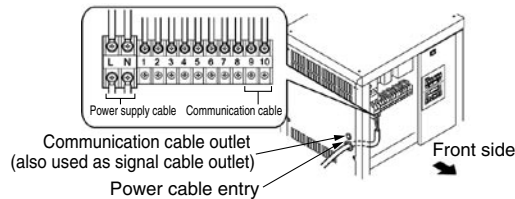

Option combination (○: Available, ×: Not available, ●: Possible, but specification needs to be modified partially.)

Symbol	5	B	C	E	H	J	K	M	S	T	Y
Options	Temperature stability ±0.5°C	With ground fault circuit interrupter	With communications function (RS-485)	With water leakage sensor	With heater	With automatic water supply function	With external switch inlet	Stainless steel wetted part for circulating fluid	With communications function (RS-232C)	High-lift pump	With DI control kit
Combination possibility with options	○	○	○	○	○	○	○	○	×	○	○

Applicable model	HRGC001- <input type="checkbox"/> <input type="checkbox"/> -C	HRGC002- <input type="checkbox"/> <input type="checkbox"/> -C	HRGC005- <input type="checkbox"/> <input type="checkbox"/> -C
Connector no.	9 (SD+), 10 (SD-)		
Connector type (on this product side)	M3 terminal block		
Standards	EIA standard RS-485 compliant		
Protocol	Special protocol: For details, refer to the Communications Specifications document.		

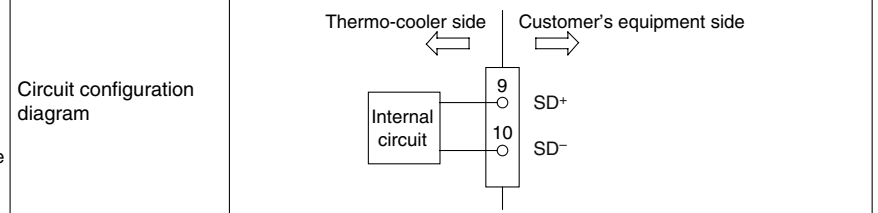

E Option symbol

With Water Leakage Sensor

HRGC - - **E**

With water leakage sensor

This built-in water leakage sensor can detect fluid leakage in the product and stop its operation.

Option combination (○: Available, ×: Not available, ●: Possible, but specification needs to be modified partially.)

Symbol	5	B	C	E	H	J	K	M	S	T	Y
Options	Temperature stability ±0.5°C	With ground fault circuit interrupter	With communications function (RS-485)	With water leakage sensor	With heater	With automatic water supply function	With external switch inlet	Stainless steel wetted part for circulating fluid	With communications function (RS-232C)	High-lift pump	With DI control kit
Combination possibility with options	○	○	○	○	○	○	○	○	○	○	○

Applicable model	HRGC001- <input type="checkbox"/> <input type="checkbox"/> -E	HRGC002- <input type="checkbox"/> <input type="checkbox"/> -E	HRGC005- <input type="checkbox"/> <input type="checkbox"/> -E
Water leakage detection method	Infrared reflection		
Water leakage detectable amount (l)	1 l or more		
Protection function	Activates if water leaks in the product or an abnormal stop occurs		

H Option symbol

With Heater

HRGC - - **H**

With heater

This built-in heater can heat up the circulating fluid and adjust it at high temperatures.

It can raise the circulating-fluid temperature quickly, even when the initial temperature is low in winter. It can be also used to heat the fluid.

Option combination (○: Available, ×: Not available, ●: Possible, but specification needs to be modified partially.)

Symbol	5	B	C	E	H	J	K	M	S	T	Y
Options	Temperature stability ±0.5°C	With ground fault circuit interrupter	With communications function (RS-485)	With water leakage sensor	With heater	With automatic water supply function	With external switch inlet	Stainless steel wetted part for circulating fluid	With communications function (RS-232C)	High-lift pump	With DI control kit
Combination possibility with options	×	○	○	○	○	○	○	●	○	○	●

Applicable model	HRGC001- <input type="checkbox"/> -H	HRGC002- <input type="checkbox"/> -H	HRGC005- <input type="checkbox"/> -H
Heater capacity	0.6 kW		
Temperature control method	Proportional valve PID control, heating and cooling control of heater P control, or refrigerator and heater ON/OFF control (Note 1)		
Temperature setting range	5 to 60°C or 5 to 35°C (Note 1)		5 to 35°C
Temperature stability	±1.0°C (Note 2)		
Protection function	Thermal fuse		

Note 1) When selecting option M or option Y

Note 2) Temperature stability ±0.5°C specifications cannot be selected.

Series HRGC

J Option symbol With Automatic Water Supply Function

HRGC ---**J**
● With automatic water supply function

By installing this at the automatic water supply inlet, the circulating fluid can be easily supplied to the product using a built-in ball tap for water supply.

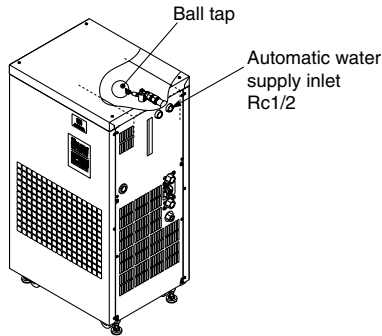

Option combination (○: Available, ×: Not available, ●: Possible, but specification needs to be modified partially.)

Symbol	5	B	C	E	H	J	K	M	S	T	Y
Options	Temperature stability ±0.5°C	With ground fault circuit interrupter	With communications function (RS-485)	With water leakage sensor	With heater	With automatic water supply function	With external switch inlet	Stainless steel wetted part to circulating fluid	With communications function (RS-232C)	High-lift pump	With DI control kit
Combination possibility with options	○	○	○	○	○	○	○	○	○	○	○

Applicable model	HRGC001- <input type="checkbox"/> - <input type="checkbox"/> - J	HRGC002- <input type="checkbox"/> - <input type="checkbox"/> - J	HRGC005- <input type="checkbox"/> - <input type="checkbox"/> - J
Water supply method	Built-in ball tap for automatic water supply		
Water supply pressure (MPa)	0.2 to 0.5		
Water supply capacity (l/min)	2 or more (at 0.2 MPa)		

K Option symbol With External Switch Inlet

HRGC ---**K**
● With external switch inlet

This can supply power to the external switches (flow switch, etc.) for alarms, and send signals indicating abnormalities from the switch to the product.

If an abnormality signal is input from the external switch, the product will respond as follows:

- The product will continue operating (if already in operation).
- Alarm light turns on.
- Alarm signal is output.
- Alarm is displayed.

Option combination (○: Available, ×: Not available, ●: Possible, but specification needs to be modified partially.)

Symbol	5	B	C	E	H	J	K	M	S	T	Y
Options	Temperature stability ±0.5°C	With ground fault circuit interrupter	With communications function (RS-485)	With water leakage sensor	With heater	With automatic water supply function	With external switch inlet	Stainless steel wetted part to circulating fluid	With communications function (RS-232C)	High-lift pump	With DI control kit
Combination possibility with options	○	○	○	○	○	○	○	○	×	○	○

Applicable model	HRGC001- <input type="checkbox"/> - <input type="checkbox"/> - K	HRGC002- <input type="checkbox"/> - <input type="checkbox"/> - K	HRGC005- <input type="checkbox"/> - <input type="checkbox"/> - K
External switch signal input	Contact input or PNP open collector input (voltage at OFF: 24 VDC; current at ON: 35 mA or less)		
External switch power output	Power supply voltage 24 VDC ±10% 5 W to 20 W		

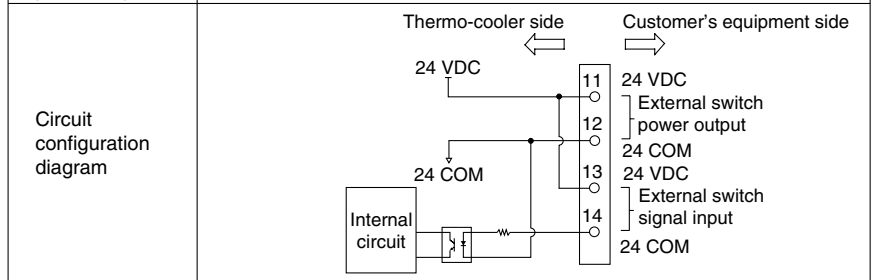

Wiring Connection Location

Remove the front panel, and connect your communication cable to the terminal block mounted inside the electrical component enclosure.

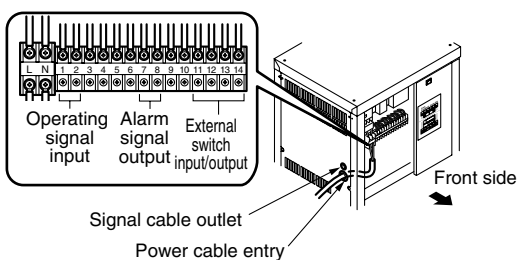

Application examples

When monitoring flow with a flow-rate switch

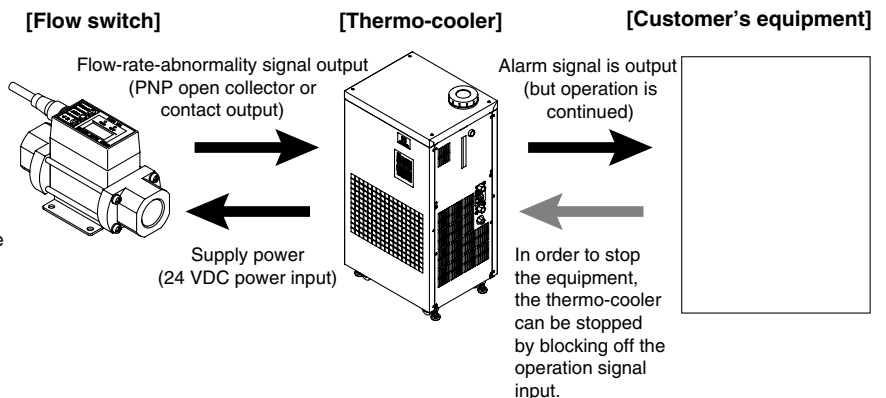

M Option symbol

Stainless Steel Wetted Part for Circulating Fluid

HRGC - - - M

● Stainless steel wetted part for circulating fluid

By changing the material of the wetted part in the circulating-fluid circuit to stainless steel, deionised water with 2 MΩ or less of electrical resistance (0.5 μS/cm or more of electric conductivity) can be used. (However, heat exchanger is made of copper brazing.)

Option combination (○: Available, ×: Not available, ●: Possible, but specification needs to be modified partially.)

Symbol	5	B	C	E	H	J	K	M	S	T	Y
Options	Temperature stability ±0.5°C	With ground fault circuit interrupter	With communications function (RS-485)	With water leakage sensor	With heater	With automatic water supply function	With external switch inlet	Stainless steel wetted part for circulating fluid	With communications function (RS-232C)	High-lift pump	With DI control kit
Combination possibility with options	×	○	○	○	●	○	○	○	○	○	×

Applicable model	HRGC001- <input type="checkbox"/> -M	HRGC002- <input type="checkbox"/> -M	HRGC005- <input type="checkbox"/> -M
Temperature setting range	5 to 35°C Note 1)		
Temperature stability	±1.0°C Note 2)		
Circulating-fluid type	Clear water, Deionised water Note 3), Aqueous solution of 15% ethylene glycol		
Wetted part material for circulating fluid	Stainless steel, Copper brazing (Heat exchanger), PVC		

Note 1) This cannot be used in circulating-fluid temperatures of 35°C or higher, even when option H is selected.

Note 2) Temperature stability ±0.5°C specifications cannot be selected.

Note 3) Use deionised water with electrical resistance 2 MΩ·cm or less (electrical conductivity 0.5μS/cm or more).

S Option symbol

With Communications Function (RS-232C)

HRGC - - - S

● With communications function (RS-232C)

With a host PC programmed in accordance with your manufacturing processor method, the communications function allows you to set (write) or monitor (read) the circulating fluid temperature.

<Writing> Circulating fluid temperature setting (SV)

<Readout> Circulating fluid present temperature (PV)
Circulating fluid temperature setting (SV)

Communication connection location

Remove the front panel, and connect your communication cable to the terminal block mounted inside the electrical component enclosure.

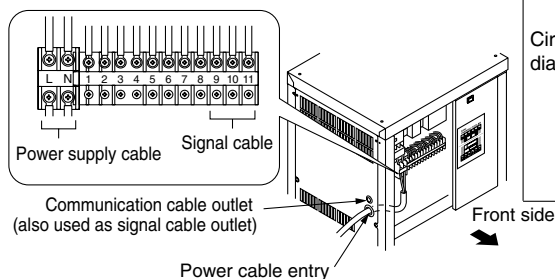

Option combination (○: Available, ×: Not available, ●: Possible, but specification needs to be modified partially.)

Symbol	5	B	C	E	H	J	K	M	S	T	Y
Options	Temperature stability ±0.5°C	With ground fault circuit interrupter	With communications function (RS-485)	With water leakage sensor	With heater	With automatic water supply function	With external switch inlet	Stainless steel wetted part for circulating fluid	With communications function (RS-232C)	High-lift pump	With DI control kit
Combination possibility with options	○	○	×	○	○	○	×	○	○	○	○

Applicable model	HRGC001- <input type="checkbox"/> -S	HRGC002- <input type="checkbox"/> -S	HRGC005- <input type="checkbox"/> -S
Connector no.	9 (RD), 10 (SD), 11 (SG)		
Connector type (on this product side)	M3 terminal block		
Standards	EIA standard RS-232C compliant		
Protocol	Special protocol: For details, refer to the Communications Specifications document.		

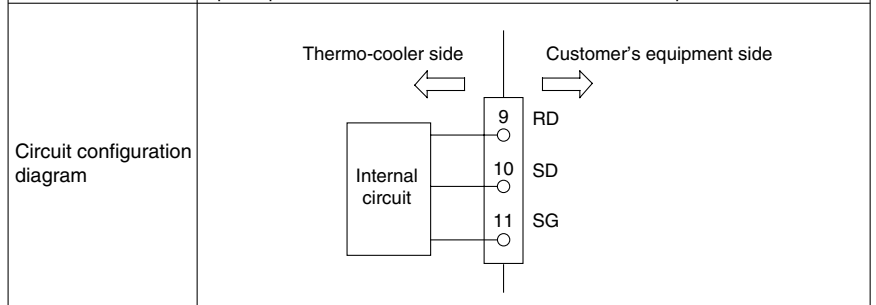

Series HRGC

T Option symbol High-lift Pump

HRGC - - T
 High-lift pump

Possible to choose a high-lift pump in accordance with customer's piping resistance. Cooling capacity may decrease by heat generated in the pump (For HRGC005 as standard).

Option combination (○: Available, ×: Not available, ●: Possible, but specification needs to be modified partially.)

Symbol	5	B	C	E	H	J	K	M	S	T	Y
Options	Temperature stability $\pm 0.5^{\circ}\text{C}$	With ground fault circuit interrupter	With communications function (RS-485)	With water leakage sensor	With heater	With automatic water supply function	With external switch inlet	Stainless steel wetted part to circulating fluid	With communications function (RS-232C)	High-lift pump	With DI control kit
Combination possibility with options	×	●	○	○	○	○	○	○	○	○	○

Applicable model	HRGC001-□-T	HRGC002-□-T	HRGC005-□-T
Cooling capacity (50/60 Hz)	0.6/0.6 kW (Note)		1.6/1.8 kW (Note)
Pump capacity (50/60 Hz)	0.31/0.41 MPa (at 18/22 ℓ/min)		

Note) Cooling capacity may decrease as pump power increases.

Pump Capacity

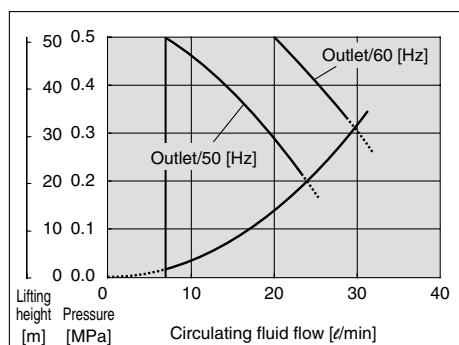

Cooling Capacity

HRGC001-□-T

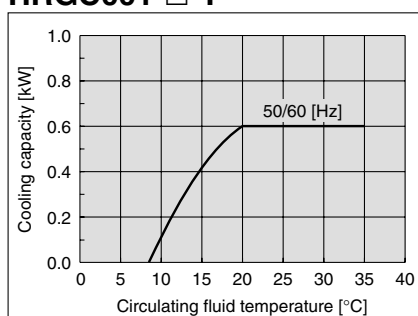

HRGC002-□-T

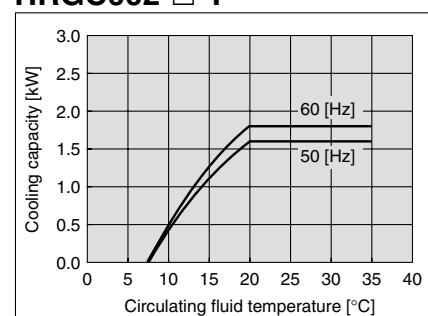

Y Option symbol With DI Control Kit

HRGC - - Y
 With DI control kit

This option adds a function to control the electrical resistance of the circulating fluid to the stainless steel wetted part for the fluid. By using this with a DI (Deionised water) filter (sold separately), the electrical resistance of the circulating fluid can be maintained at a constant level.

Option combination (○: Available, ×: Not available, ●: Possible, but specification needs to be modified partially.)

Symbol	5	B	C	E	H	J	K	M	S	T	Y
Options	Temperature stability $\pm 0.5^{\circ}\text{C}$	With ground fault circuit interrupter	With communications function (RS-485)	With water leakage sensor	With heater	With automatic water supply function	With external switch inlet	Stainless steel wetted part to circulating fluid	With communications function (RS-232C)	High-lift pump	With DI control kit
Combination possibility with options	×	○	○	○	●	○	○	×	○	○	○

Applicable model	HRGC001-□-Y	HRGC002-□-Y	HRGC005-□-Y
Temperature setting range	5 to 35 $^{\circ}\text{C}$ (Note 1)		
Temperature stability	$\pm 1.0^{\circ}\text{C}$ (Note 2)		
Circulating-fluid type	Clear water, Deionised water (Note 3), Aqueous solution of 15% ethylene glycol		
Material of wetted part for circulating fluid	Stainless steel, Copper brazing (heat exchanger), PVC		
DI display range	0 to 20 $\text{M}\Omega\text{-cm}$ (Note 3)		
DI setting range	0.00 to 2.00 $\text{M}\Omega\text{-cm}$ (Note 4)		
DI circuit rated flow	1.5 ℓ/min		
DI alarm	Max. DI level, Min. DI level, Selectable from Max. to Min.		
DI alarm operation	Can choose whether to stop or continue operation when alarm activates		

Note 1) This cannot be used in circulating-fluid temperatures of 35 $^{\circ}\text{C}$ or higher, even when option H is selected.

Note 2) Temperature stability $\pm 0.5^{\circ}\text{C}$ specifications cannot be selected.

Note 3) Use deionized water with 2 $\text{M}\Omega\text{-cm}$ or less of electrical resistance. (electric conductivity: 0.5 μS or more)

Note 4) The DI filter is needed to control the DI level. (SMC Part No.: HRZ-DF001) Please purchase additionally because the DI (Deionized water) filter is not included in this option.

*Install the DI (Deionised water) filter outside the thermo-chiller for piping. Secure the space for installing the DI (Deionised water) filter on the rear side of the Thermo-cooler.
 *It may go outside of the temperature stability range of $\pm 1.0^{\circ}\text{C}$ when this option is used in some operating conditions.

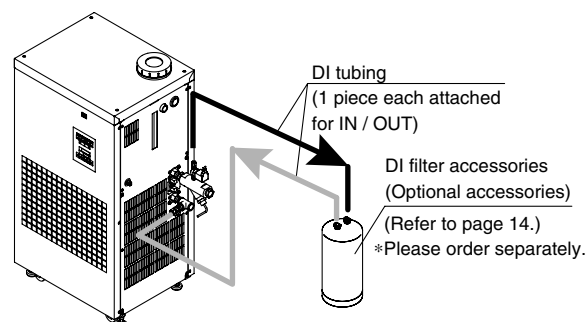

Note) Please order separately.
Necessary to be fitted
by the customer.

Dustproof Filter Set

Prevents performance degradation when using air-cooled refrigeration Thermo-coolers in dusty or contaminated environments.

- Maximum ambient temperature: 40°C

How to Order

HRGC-FL

Applicable Thermo-coolers

Symbol	Applicable Thermo-coolers	Quantity per set
001	HRGC001-A□ HRGC002-A□	1
005	HRGC005-A□	1

Dimensions

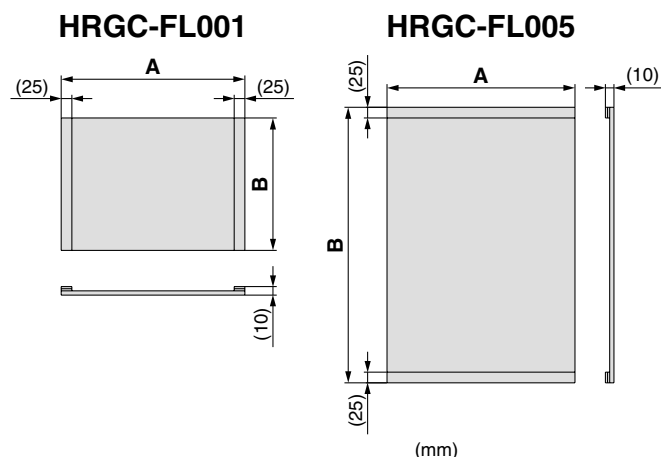

Part no.	A	B	Quantity per set
HRGC-FL001	475	310	1
HRGC-FL005	430	530	1

Mounting Example

- ① This dustproof filter is secured with hook-and-loop tape. This is sewed onto the male side of the surface fastener, and has adhesive tape backing for fixing to the female side.
- ② Remove the paper covering of the adhesive tape and affix the loop tape to the external panel of the ventilation hole on the Thermo-cooler.
- ③ Simply press the hook tape on to the loop tape to mount the dustproof filter.

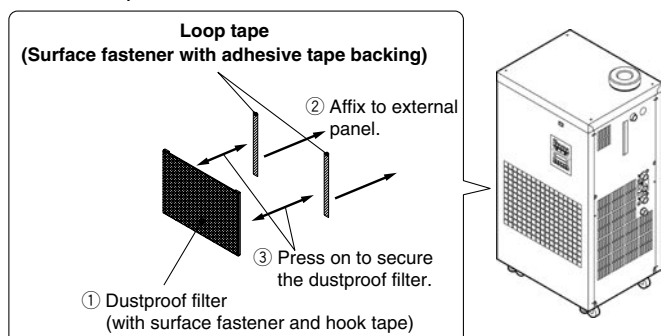

By-pass Piping Set

This prevents the occurrence of pump overload that exceeds the maximum operating pressure of the Thermo-cooler at low flow rate.

- Use circulating fluid in 5 to 60°C temperature range

How to Order

HRGC-BP

Applicable Thermo-coolers

Symbol	Applicable Thermo-coolers	Wetted part material	Pressure setting range (50/60 Hz) ^{Note)}
001	HRGC001-□ HRGC002-□	Bronze, PTFE, Stainless steel	0.12 to 0.13/ 0.16 to 0.18 MPa
001G	HRGC001-□ HRGC002-□	PTFE, Stainless steel	
005	HRGC005-□ HRGC00□-□-T	Bronze, PTFE, Stainless steel	0.22 to 0.48/ 0.29 to 0.48 MPa
005G	HRGC005-□ HRGC00□-□-T	PTFE, Stainless steel	

Note) The pressure of the by-pass piping set can be adjusted by the customer.

Dimensions

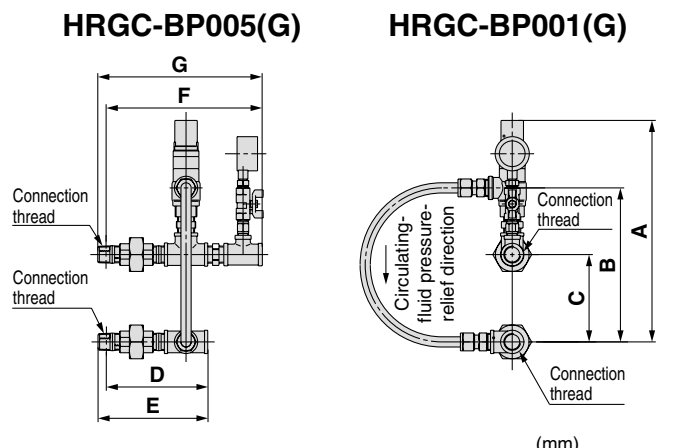

Part no.	A	B	C	D	E	F	G
HRGC-BP001(G)	275	195	110	130	140	200	210
HRGC-BP005(G)	300	210	110	130	140	200	210

Mounting Example

A pressure relief valve and pressure gauge can be mounted on the body with unions and nipples.

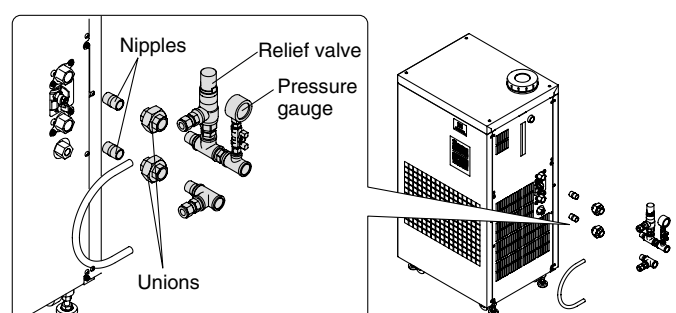

Note) Please order separately.
Necessary to be fitted
by the customer.

DI (Deionised Water) Filter

This is the ion replacement resin to maintain the electrical resistivity of the circulating fluid.

Customers who selected the DI control kit (Option "Y") need to purchase the DI (Deionised water) filter separately.

Part no.	Applicable model
HRZ-DF001	Common for all models which can select the DI control kit. (Option "Y")

Note) The DI (Deionised Water) filters are consumable. Depending on the status (electrical resistivity set value, circulating fluid temperature, piping volume, etc.), product life cycles will vary accordingly.

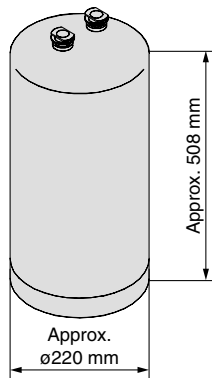

Weight: Approx. 20 kg

Insulating Material for DI (Deionized Water) Filter

When the DI (Deionized Water) filter is used at a high-temperature, we recommend that you use this insulating material to protect the radiated heat from the DI (Deionized Water) filter or possible burns. When the DI filter is used at a low-temperature, we also recommend that you use this to prevent heat absorption from the DI filter and to avoid forming condensation.

Part no.	Applicable model
HRZ-DF002	Common for all models which can select the DI control kit. (Option "Y")

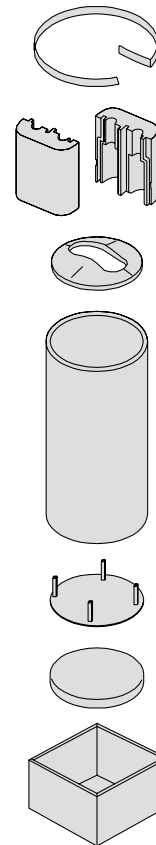



Series HRGC

Specific Product Precautions 1

Be sure to read this before handling. Refer to the back cover for Safety Instructions and "Handling Precautions for SMC Products" (M-E03-3) for Temperature Control Equipment Precautions.

Design

Warning

- This catalogue shows the specification of a single unit.**
 - Confirm the specification of the single unit (contents of this catalogue) and thoroughly consider the adaptability between the customer's system and this unit.
 - Although the protection circuit as a single unit is installed, prepare a drain pan, water leakage sensor, discharge air facility, and emergency stop equipment, depending on the customer's operating condition. Also, the customer is requested to carry out the safety design for the whole system.
- When attempting to cool areas that are open to the atmosphere (tanks, pipes), plan your piping system accordingly.**
When cooling open-air external tanks, arrange the piping so that there are coil pipes for cooling inside the tanks, and to carry back the entire flow volume of circulating fluid that is released.

Selection

Warning

- Model selection**
For selecting a model of Thermo-cooler, it is required to know the heat generation amount of a customer's equipment. Obtain the heat generation amount, referring to the model selection example for the HRGC series before selecting a model.
- Indication of model number**
Select the cooling method and temperature stability depending on the customer's application.

Handling

Warning

- Thoroughly read the operating manual.**
Read the operating manual completely before operation, and keep a copy on-site, for future reference.

Operating Environment / Storage Environment

Warning

- Do not use in the following environments because it will lead to a breakdown.**
 - Environment like described in "Temperature Control Equipment Precautions".
 - Locations where spatter will adhere to when welding.
 - Locations where it is likely that the leakage of flammable gas may occur.
 - Locations having a large quantity of dust.
If it is necessary to use the unit in an environment where there is a risk of the fin portion of the air-condenser becoming clogged, use the dustproof filter set (sold separately).
 - A place in which water freezes. If such an environment is unavoidable, please contact SMC.
- Install in an environment where the unit will not come into direct contact with rain or snow. (HRGC001 to HRGC005)**
These models are for indoor use only. Do not install outdoors where rain or snow may fall on them.
- Conduct ventilation and cooling to discharge heat.**
(Air-cooled refrigeration)
The heat which is cooled down through an air-cooled condenser is discharged.
When using in a room which is shut tightly, the ambient temperature will exceed the specification range stipulated in this catalogue, which will activate the safety detector and stop the operation.
In order to avoid this situation, discharge the heat outside of a room by ventilation or cooling facilities.
- The Thermo-cooler is not designed for a clean room. It generates particles internally.**

Circulating Fluid

Caution

- Avoid oil or other foreign objects entering the circulating fluid.**
- Use an ethylene glycol aqueous solution that does not contain additives (such as preservatives, etc.).**

Circulating Fluid

Caution

- The concentration of ethylene glycol aqueous solution must be 15% or less.**
Overly high concentration aqueous solution will overload to the pump and activates the safety interlock, which may stop the operation. On the other hand, if the concentration is too low, the aqueous solution freezes at low temperature, which may cause malfunction in the product.
- When using clear water as a circulating fluid, use water that conforms to the appropriate water quality standards.**
Use clear water (including diluted ethylene glycol aqueous solution) that satisfies the quality standard shown below.

Clean Water (as Circulating Fluid) Quality Standard

The Japan Refrigeration and Air Conditioning Industry Association
JRA GL-02-1994 "Cooling water system - Circulation type - Make-up water"

	Item	Unit	Standard value
Standard item	pH (at 25°C)	—	6.8 to 8.0
	Electrical conductivity (25°C)	[μS/cm]	100* to 300*
	Chloride ion (Cl ⁻)	[mg/L]	50 or less
	Sulfuric acid ion (SO ₄ ²⁻)	[mg/L]	50 or less
	Acid consumption amount (at pH4.8)	[mg/L]	50 or less
	Total hardness	[mg/L]	70 or less
	Calcium hardness (CaCO ₃)	[mg/L]	50 or less
Reference item	Ionic state silica (SiO ₂)	[mg/L]	30 or less
	Iron (Fe)	[mg/L]	0.3 or less
	Copper (Cu)	[mg/L]	0.1 or less
	Sulfide ion (S ₂ ⁻)	[mg/L]	Should not be detected.
	Ammonium ion (NH ₄ ⁺)	[mg/L]	0.1 or less
	Residual chlorine (Cl)	[mg/L]	0.3 or less
	Free carbon (CO ₂)	[mg/L]	4.0 or less

* In the case of [MΩ·cm], it will be 0.003 to 0.01.

- Deionised water can be used (as supply water), but resistivity cannot be maintained.**
When supplying water, use deionised water with electrical conductivity of 1 μS/cm or more (electrical resistivity: 1 MΩ·cm or less). However, since components of the wetted part will be released in water, electrolyte concentration cannot be maintained.

(HRGC001/002)

- A magnet pump is used as a circulating pump for the circulating liquid.**
It is particularly impossible to use liquid including metallic powder such as iron powder.

Transportation / Transfer / Movement

Warning

- Transportation by forklift (HRGC001 to HRGC005)**
 - A licensed driver should drive the forklift.
 - The proper place to insert the tines of the forklift differs depending on the model of cooler. Check the operating manual to confirm, and be sure to drive the fork in far enough for it to come out the other side.
 - Be careful not to bump the fork to the cover panel or piping ports.
- Hanging transportation (HRGC005)**
 - Crane manipulation and slinging work should be done by an eligible person.
 - Do not grip the piping or the handles of the panel on the right side.
 - When hanging by the eye bolts, be sure to use a 4-point hanging method. For the hanging angle, use caution regarding the position of the centre of gravity and hold it within 60°.

HRGC001, HRGC002

Fork insertion side

HRGC005 Hanging position

Fork insertion side

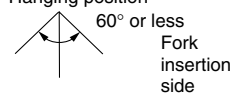

Fork insertion side

Fork insertion side

Fork insertion side

3. Transporting using casters

- This product is heavy and should be moved by at least two people.
- Do not grip the piping port on the right side or the handles of the panel.
- When transporting using a forklift, be sure not to let it hit the casters or adjusters, and drive the fork all the way through until it comes out the other side.



Series HRGC

Specific Product Precautions 2

Be sure to read this before handling. Refer to the back cover for Safety Instructions and "Handling Precautions for SMC Products" (M-E03-3) for Temperature Control Equipment Precautions.

Mounting / Installation

Warning

- Do not place heavy objects on top of this product or step on it.**
The external panel can be deformed and danger can result.
- Do not directly touch the edge of the external panel when removing and installing it.**
It may cause injury. Be sure to wear protective gloves.
- Lower the adjusters and do not move.**
Be sure to lower all four adjusters to the level of the floor.

Caution

- Install on a rigid floor which can withstand this product's weight.**
- Secure with bolts, anchor bolts, etc.**
Fasteners such as bolts or anchor bolts should be tighten with the recommended torque shown below.

Fixing Threads Tightening Torque

Connection thread	Applicable tightening torque N•m	Connection thread	Applicable tightening torque N•m
M3	0.63	M8	12.5
M4	1.5	M10	24.5
M5	3	M12	42
M6	5.2		

(When using optional accessories/dustproof filter set)

- Use the attached surface fastener (with adhesive tape) to affix the dustproof filter to the panel of the Thermo-cooler.**
- Mounting the filter will create a certain amount of resistance to ventilation that will reduce the volume of airflow.**
For this reason, be sure to keep the ambient temperature at 40°C or less.
- Depending on the installation height of the Thermo-cooler and/or the cooled substrates, the circulating fluid may overflow from the tank lid or overflow outlet.**
In particular, avoid overflow from the lid of the built-in tank by installing with a height difference of 10 m or less.
Be sure to pipe the overflow outlet to a wastewater collection pit, etc.

Piping

Caution

- Regarding the circulating fluid pipings, consider carefully the suitability for shutoff pressure, temperature and circulating fluid.**
If the operating performance is not sufficient, the pipings may burst during operation.
- For the circulating fluid pipings, use clean pipings which have no dust, piping debris or other foreign objects inside the pipings, and blow with air prior to undertaking any piping works.**
If piping debris or other foreign objects remain inside the circulating fluid circuit, it can result in blockage, insufficient cooling or damage to the pump impeller.
- Select the piping port size which can exceed the rated flow.**
For the rated flow, refer to the pump capacity table.
- When tightening at the circulating fluid inlets and outlets, tank drain port or overflow outlet of this product, use a pipe wrench to clamp the connection ports.**
- For the circulating fluid piping connection, install a drain pan and wastewater collection pit just in case the circulating fluid leaks.**
- While cleaning the inside of the tank, attach a valve to the tank drain outlet to drain the circulating fluid (clear water).**
- This product series consists of circulating fluid temperature controllers with built-in tanks.**
Do not install equipment on your system side such as pumps that forcibly return the circulating fluid to the unit. Also, if you attach an external tank that is open to the air, it may become impossible to circulate the circulating fluid. Proceed with caution.

Piping

Caution

(Water-cooled refrigeration HRGC□□□-W□)

- When tightening the facility water inlets and outlets of this product, use a pipe wrench to clamp the connection ports.**
- Install by-pass piping.**
This product has a built-in water control valve, so when the refrigeration circuit is stopped, facility water does not flow out in order to save energy. For this reason, by-pass piping is necessary for conducting maintenance of your facility water equipment, so be sure to install it.

Electrical Wiring

Warning

- Never change the set value of the safety instrument.**
If the set value is changed, it will likely cause a breakdown or cause the product to catch on fire.
- Before wiring, be sure to cut the power supply.**
Never perform any job while the product is energised.
- Secure the cable so that its force, etc. is not applied to the terminal connector ports.**
When the connection or attachment is incomplete, it will likely lead to an electrical shock, a fire, etc.
- Grounding should never be connected to a water line, gas line or lightning rod.**
- Multiple wiring is dangerous because it will lead to heat generation or cause a fire.**

Caution

- Power supply, signal cable and connecting terminal should be prepared by the customer.**

(When using the HRGC□□□-□□-C with optional communications function)

- Communication cables and adapters should be prepared by the customer.**
Prepare parts that conform to the connector specifications of your host computer.
- Pay attention to the polarity when connecting communication cables.**

Facility Water Supply

Warning

(Water-cooled refrigeration HRGC□□□-W□)

- Before startup, be sure to open the valve of your facility water equipment.**
Prepare before startup, so that facility water can flow when the fitted water control valve (facility water control valve) opens during operation.
- Supply pressure should be 0.5 MPa or less.**
When the supply pressure is high, it will cause water leakage.
- Be sure to prepare your utilities so that the pressure of the Thermo-cooler facility water outlet is at 0 MPa (atmospheric pressure) or more.**
If the facility water outlet pressure becomes negative, the internal facility water piping may collapse, and proper flow control of facility water will be impossible.

Operation

Warning

- Confirmation before operation**
 - The fluid level of a tank should be within the specified range of "HIGH" and "LOW".
When exceeding the specified level, the circulating fluid will overflow.
 - Remove the air.
Conduct a trial operation, looking at the fluid level.
Since the fluid level will go down when the air is removed from a customer's piping system, supply water once again when the fluid level is reduced. When there is no reduction in the fluid level, the job of removing the air is completed.



Series HRGC

Specific Product Precautions 3

Be sure to read this before handling. Refer to the back cover for Safety Instructions and "Handling Precautions for SMC Products" (M-E03-3) for Temperature Control Equipment Precautions.

Operation

⚠ Warning

3. Handling of by-pass valve
At the time this product is shipped from our factory, the by-pass valve is fully open.
Operation with it fully closed will cause the circulating fluid outlet pressure to increase high and it may safely stop in order to prevent the pump's operation from overloading.
When operating for the first time after installation, be sure to operate it with the by-pass valve fully open.
2. Confirmation during operation
 1. Adjust the by-pass valve.
Monitor the external piping, pressure gauge, or flow meter mounted on the equipment from the customer's side, in order to adjust the open angle of the by-pass valve, so that the required pressure or flow can be obtained.
 2. Confirm the circulating fluid temperature.
The operating temperature range of the circulating fluid is between 5 and 35°C.
When the amount of heat generated from a customer's equipment is greater than the product's capability, the circulating fluid temperature may exceed this range. Use caution regarding this matter.
3. Emergency stop method
 - When an abnormality is confirmed, stop the equipment immediately. After pushing the (OFF) switch, be sure to turn off the power supply breaker.

⚠ Caution

1. The temperature set value can be written to EEPROM, but only up to approximately one million times.
Especially when using communication function, save data with STOR before stoppage, and do not carry out frequent saving (STOR) of temporary setting values.

Operation Restart Time

⚠ Caution

1. Wait five minutes or more before restarting operation after it has been stopped. If the operation is restarted within five minutes, the protection circuit may activate and the operation may not start properly.

Protection Circuit

⚠ Caution

1. If operating in the below conditions, the protection circuit will activate and an operation may not be performed or will stop.
 - Power supply voltage is not within the rated voltage range of $\pm 10\%$.
 - In case the water level inside the tank is reduced abnormally.
 - Facility water is not supplied. (HRGC□□□-W)
 - Transfer pressure of the circulating fluid is too high.
 - Circulating fluid temperature is too high.
 - Compared to the cooling capacity, the heat generation amount of a customer's equipment is too high.
 - Ambient temperature is too high (40°C or higher)
 - Refrigerant pressure is too high.
 - Ventilation hole is clogged with dust or dirt. (Especially HRGC□□□-A)

Maintenance

⚠ Warning

1. Do not operate the switch with wet hands or touch electrical parts. This will lead to an electrical shock.
2. In the event of cleaning, do not splash water directly on this product for cleaning.
This will lead to an electrical shock or a fire.
3. When the panel is removed for the purpose of inspection or cleaning, mount the panel after works are done.
If the panel is still open, or running the equipment with the panel removed, it may cause an injury or electric shocks.
4. In the event of cleaning the air-cooled condenser, do not touch the fin directly.
This may lead to injuries.

Maintenance

⚠ Caution

<Periodical inspection every month>
(Air-cooled refrigeration HRGC□□□-A□)

1. Cleaning the ventilation hole
If the fin portion of the air-condenser becomes clogged with dust or debris, a decline in cooling performance can result.
In order to avoid deforming or damaging the fin, clean it with a long-haired brush or air gun.

(When using optional accessories/dustproof filter set)

1. Clean the dustproof filter.
To prevent dirt or clogging of the dustproof filter from leading to a decline in heat-releasing performance of the air-condenser, clean or wash it regularly.
2. Remove the filter from the Thermo-cooler before cleaning it.
Do not splash water directly on the filter to clean it while it is still attached to the Thermo-cooler.
This can lead to electric shock or fires in the main unit of the thermo-cooler.

<Periodical inspection every three months>

1. Inspect the circulating fluid.
 1. When using clear water
 - Replacement of clear water
Failure to replace the clear water can lead to the development of bacteria or algae. Replace it regularly depending on your usage conditions.
 - Tank cleaning
Consider whether dirt, slime or foreign objects may be present in the circulating fluid inside the tank, and carry out regular cleanings of the tank.
 2. When using ethylene glycol aqueous solution
Use a concentration measurement device to confirm that the concentration does not exceed 15%.
Dilute or add as needed to adjust the concentration.

2. Check the water quality of facility water.
Regarding the water quality standards for facility water, refer to "Temperature Control Equipment Precautions".

<Periodical inspection every six months>
(HRGC005-□□) ^{Note 1)}

1. Inspect the circulating fluid.
 1. Remove the panel and inspect if there is abnormal leakage from the pump's mechanical seal.
 2. Leakage amount of a mechanical seal
Leakage of the mechanical seal cannot be completely avoided due to its construction (rotating machine).
This amount of leakage is stipulated as 3 (cc/h) or less (reference value) according to the JIS standard.
Also, as a guide for periodic replacement, the operation hours is 6000 to 8000 hours. (normally 1 year) ^{Note 2)}

Note 1) In the case of the HRGC001/002, because the pump included in the unit is a magnet pump with no rotating shaft seal, it is not necessary to inspect the mechanical seal (rotating shaft seal).

Note 2) When placing an order of mechanical seal set (service parts), inform us of the complete model number and the production lot number of the product in use.

<Periodical inspection during winter season>

1. Keep the power supply running (POWER light on, RUN light off), and fully open the valves in the circulating fluid piping.
If the circulating fluid temperature falls below 3°C, the pump will start operating automatically. The heat generated by the pump operation will warm up the circulating fluid. When the temperature rises above 5°C, the pump will stop automatically.
As a result, the circulating fluid maintains a temperature of between 3°C and 5°C, preventing freezing.
2. Make water-removal arrangements beforehand.
In extremely cold weather conditions, the heat generated by the pump as described above may not be enough to prevent freezing.
If you expect these kind of conditions, remove the circulating fluid (especially clear water or deionised water) beforehand.
3. Consult a professional.
For additional methods to prevent freezing (such as commercially available tape heaters, etc.), consult a professional for advice.

Safety Instructions

These safety instructions are intended to prevent hazardous situations and/or equipment damage. These instructions indicate the level of potential hazard with the labels of “**Caution**,” “**Warning**” or “**Danger**.” They are all important notes for safety and must be followed in addition to International Standards (ISO/IEC)*1, and other safety regulations.

Caution:

Caution indicates a hazard with a low level of risk which, if not avoided, could result in minor or moderate injury.

Warning:

Warning indicates a hazard with a medium level of risk which, if not avoided, could result in death or serious injury.

Danger :

Danger indicates a hazard with a high level of risk which, if not avoided, will result in death or serious injury.

- *1) ISO 4414: Pneumatic fluid power – General rules relating to systems.
 ISO 4413: Hydraulic fluid power – General rules relating to systems.
 IEC 60204-1: Safety of machinery – Electrical equipment of machines.
 (Part 1: General requirements)
 ISO 10218-1: Manipulating industrial robots - Safety.
 etc.

Warning

1. The compatibility of the product is the responsibility of the person who designs the equipment or decides its specifications.

Since the product specified here is used under various operating conditions, its compatibility with specific equipment must be decided by the person who designs the equipment or decides its specifications based on necessary analysis and test results. The expected performance and safety assurance of the equipment will be the responsibility of the person who has determined its compatibility with the product. This person should also continuously review all specifications of the product referring to its latest catalogue information, with a view to giving due consideration to any possibility of equipment failure when configuring the equipment.

2. Only personnel with appropriate training should operate machinery and equipment.

The product specified here may become unsafe if handled incorrectly. The assembly, operation and maintenance of machines or equipment including our products must be performed by an operator who is appropriately trained and experienced.

3. Do not service or attempt to remove product and machinery/equipment until safety is confirmed.

- The inspection and maintenance of machinery/equipment should only be performed after measures to prevent falling or runaway of the driven objects have been confirmed.
- When the product is to be removed, confirm that the safety measures as mentioned above are implemented and the power from any appropriate source is cut, and read and understand the specific product precautions of all relevant products carefully.
- Before machinery/equipment is restarted, take measures to prevent unexpected operation and malfunction.

4. Contact SMC beforehand and take special consideration of safety measures if the product is to be used in any of the following conditions.

- Conditions and environments outside of the given specifications, or use outdoors or in a place exposed to direct sunlight.
- Installation on equipment in conjunction with atomic energy, railways, air navigation, space, shipping, vehicles, military, medical treatment, combustion and recreation, or equipment in contact with food and beverages, emergency stop circuits, clutch and brake circuits in press applications, safety equipment or other applications unsuitable for the standard specifications described in the product catalogue.
- An application which could have negative effects on people, property, or animals requiring special safety analysis.
- Use in an interlock circuit, which requires the provision of double interlock for possible failure by using a mechanical protective function, and periodical checks to confirm proper operation.

Caution

1. The product is provided for use in manufacturing industries.

The product herein described is basically provided for peaceful use in manufacturing industries.

If considering using the product in other industries, consult SMC beforehand and exchange specifications or a contract if necessary.

If anything is unclear, contact your nearest sales branch.

Limited warranty and Disclaimer/ Compliance Requirements

The product used is subject to the following “Limited warranty and Disclaimer” and “Compliance Requirements”.

Read and accept them before using the product.

Limited warranty and Disclaimer

- The warranty period of the product is 1 year in service or 1.5 years after the product is delivered.*2)
 Also, the product may have specified durability, running distance or replacement parts. Please consult your nearest sales branch.
- For any failure or damage reported within the warranty period which is clearly our responsibility, a replacement product or necessary parts will be provided.
 This limited warranty applies only to our product independently, and not to any other damage incurred due to the failure of the product.
- Prior to using SMC products, please read and understand the warranty terms and disclaimers noted in the specified catalogue for the particular products.

*2) Vacuum pads are excluded from this 1 year warranty.

A vacuum pad is a consumable part, so it is warranted for a year after it is delivered. Also, even within the warranty period, the wear of a product due to the use of the vacuum pad or failure due to the deterioration of rubber material are not covered by the limited warranty.

Compliance Requirements

- The use of SMC products with production equipment for the manufacture of weapons of mass destruction (WMD) or any other weapon is strictly prohibited.
- The exports of SMC products or technology from one country to another are governed by the relevant security laws and regulations of the countries involved in the transaction. Prior to the shipment of a SMC product to another country, assure that all local rules governing that export are known and followed.

Safety Instructions

Be sure to read “Handling Precautions for SMC Products” (M-E03-3) before using.

SMC Corporation (Europe)

Austria	☎ +43 2262622800	www.smc.at	office@smc.at
Belgium	☎ +32 (0)33551464	www.smcpnematics.be	info@smcpnematics.be
Bulgaria	☎ +359 29744492	www.smc.bg	office@smc.bg
Croatia	☎ +385 13776674	www.smc.hr	office@smc.hr
Czech Republic	☎ +420 541424611	www.smc.cz	office@smc.cz
Denmark	☎ +45 70252900	www.smc.dk.com	smc@smcdk.com
Estonia	☎ +372 6510370	www.smcpnematics.ee	smc@smcpnematics.ee
Finland	☎ +358 207513513	www.smc.fi	smc.fi@smc.fi
France	☎ +33 (0)164761000	www.smc-france.fr	contact@smc-france.fr
Germany	☎ +49 (0)61034020	www.smc-pneumatik.de	info@smc-pneumatik.de
Greece	☎ +30 210 2717265	www.smchellas.gr	sales@smchellas.gr
Hungary	☎ +36 23511390	www.smc.hu	office@smc.hu
Ireland	☎ +353 (0)14039000	www.smcpnematics.ie	sales@smcpnematics.ie
Italy	☎ +39 (0)292711	www.smcitalia.it	mailbox@smcitalia.it
Latvia	☎ +371 67817700	www.smc.lv	info@smclv.lv

Lithuania	☎ +370 5 2308118	www.smclt.lt	info@smclt.lt
Netherlands	☎ +31 (0)205318888	www.smcpnematics.nl	info@smcpnematics.nl
Norway	☎ +47 67129020	www.smc-norge.no	post@smc-norge.no
Poland	☎ +48 222119600	www.smc.pl	office@smc.pl
Portugal	☎ +351 226166570	www.smc.eu	postpt@smc.smces.es
Romania	☎ +40 213205111	www.smcromania.ro	smcromania@smcromania.ro
Russia	☎ +7 8127185445	www.smc-pneumatik.ru	info@smc-pneumatik.ru
Slovakia	☎ +421 413213212	www.smc.sk	office@smc.sk
Slovenia	☎ +386 73885412	www.smc.si	office@smc.si
Spain	☎ +34 945184100	www.smc.eu	post@smc.smces.es
Sweden	☎ +46 (0)86031200	www.smc.nu	post@smcpnematics.se
Switzerland	☎ +41 (0)523963131	www.smc.ch	info@smc.ch
Turkey	☎ +90 (0)2124440762	www.entek.com.tr	smc@entek.com.tr
UK	☎ +44 (0)845 121 5122	www.smcpnematics.co.uk	sales@smcpnematics.co.uk