



# Operation Manual

PRODUCT NAME

Digital Flow Switch

MODEL / Series / Product Number

*PF2A7##*

**SMC Corporation**



## Table of Contents

Safety Instructions	2
Model Indication and How to Order	10
Summary of Product parts	12
Definition and terminology	13
Mounting and Installation	15
Installation	15
Piping	16
Wiring	17
Outline of setting	19
List of outputs	20
Initialize mode	21
Setting procedure of initialize mode	22
Function selection mode	25
F_1 Input procedure of the Set value of instantaneous output	26
F_2 Input procedure of the Set value of instantaneous output (Auto-preset)	27
F_3 Input procedure of the Set value of accumulated output	28
Key-lock function	30
Maintenance	31
Troubleshooting	32
Cross-reference for troubleshooting	32
Error indication	34
Specifications	35
Specifications	35
Characteristics data	37
Dimensions	38
Made to Order	40

## Safety Instructions

These safety instructions are intended to prevent hazardous situations and/or equipment damage. These instructions indicate the level of potential hazard with the labels of "Caution", "Warning" or "Danger". They are all important notes for safety and must be followed in addition to International standards (ISO/IEC) \*1) and other safety regulations.

- \*1) ISO 4414: Pneumatic fluid power -- General rules relating to systems
- ISO 4413: Hydraulic fluid power -- General rules relating to systems
- IEC 60204-1: Safety of machinery -- Electrical equipment of machines (Part 1: General requirements)
- ISO 10218-1992: Manipulating industrial robots -Safety.
- etc.

-  **Caution** : CAUTION indicates a hazard with a low level of risk which, if not avoided, could result in minor or moderate injury.
-  **Warning** : WARNING indicates a hazard with a medium level of risk which, if not avoided, could result in death or serious injury.
-  **Danger** : DANGER indicates a hazard with a high level of risk which, if not avoided, will result in death or serious injury.

### Warning

**1. The compatibility of the product is the responsibility of the person who designs the equipment or decides its specifications.**

Since the product specified here is used under various operating conditions, its compatibility with specific equipment must be decided by the person who designs the equipment or decides its specifications based on necessary analysis and test results. The expected performance and safety assurance of the equipment will be the responsibility of the person who has determined its compatibility with the product. This person should also continuously review all specifications of the product referring to its latest catalog information, with a view to giving due consideration to any possibility of equipment failure when configuring the equipment.

**2. Only personnel with appropriate training should operate machinery and equipment.**

The product specified here may become unsafe if handled incorrectly. The assembly, operation and maintenance of machines or equipment including our products must be performed by an operator who is appropriately trained and experienced.

**3. Do not service or attempt to remove product and machinery/equipment until safety is confirmed.**

1. The inspection and maintenance of machinery/equipment should only be performed after measures to prevent falling or runaway of the driven objects have been confirmed.
2. When the product is to be removed, confirm that the safety measures as mentioned above are implemented and the power from any appropriate source is cut, and read and understand the specific product precautions of all relevant products carefully.
3. Before machinery/equipment is restarted, take measures to prevent unexpected operation and malfunction.

**4. Contact SMC beforehand and take special consideration of safety measures if the product is to be used in any of the following conditions.**

1. Conditions and environments outside of the given specifications, or use outdoors or in a place exposed to direct sunlight.
2. Installation on equipment in conjunction with atomic energy, railways, air navigation, space, shipping, vehicles, military, medical treatment, combustion and recreation, or equipment in contact with food and beverages, emergency stop circuits, clutch and brake circuits in press applications, safety equipment or other applications unsuitable for the standard specifications described in the product catalog.
3. An application which could have negative effects on people, property, or animals requiring special safety analysis.
4. Use in an interlock circuit, which requires the provision of double interlock for possible failure by using a mechanical protective function, and periodical checks to confirm proper operation.

## **Caution**

### **The product is provided for use in manufacturing industries.**

The product herein described is basically provided for peaceful use in manufacturing industries. If considering using the product in other industries, consult SMC beforehand and exchange specifications or a contract if necessary.  
If anything is unclear, contact your nearest sales branch.

## **Limited warranty and Disclaimer/Compliance Requirements**

The product used is subject to the following "Limited warranty and Disclaimer" and "Compliance Requirements".

Read and accept them before using the product.

### **Limited warranty and Disclaimer**

1. The warranty period of the product is 1 year in service or 1.5 years after the product is delivered. \*2)  
Also, the product may have specified durability, running distance or replacement parts. Please consult your nearest sales branch.
2. For any failure or damage reported within the warranty period which is clearly our responsibility, a replacement product or necessary parts will be provided.  
This limited warranty applies only to our product independently, and not to any other damage incurred due to the failure of the product.
3. Prior to using SMC products, please read and understand the warranty terms and disclaimers noted in the specified catalog for the particular products.

\*2) Vacuum pads are excluded from this 1 year warranty.

A vacuum pad is a consumable part, so it is warranted for a year after it is delivered.

Also, even within the warranty period, the wear of a product due to the use of the vacuum pad or failure due to the deterioration of rubber material are not covered by the limited warranty.

### **Compliance Requirements**

1. The use of SMC products with production equipment for the manufacture of weapons of mass destruction (WMD) or any other weapon is strictly prohibited.
2. The exports of SMC products or technology from one country to another are governed by the relevant security laws and regulation of the countries involved in the transaction. Prior to the shipment of a SMC product to another country, assure that all local rules governing that export are known and followed.

## Operator

- ◆ This operation manual is intended for those who have knowledge of machinery using pneumatic equipment, and have sufficient knowledge of assembly, operation and maintenance of such equipment. Only those persons are allowed to perform assembly, operation and maintenance.
- ◆ Read and understand this operation manual carefully before assembling, operating or providing maintenance to the product.

### ■ Safety Instructions

#### **Warning**

- Do not disassemble, modify (including changing the printed circuit board) or repair.  
An injury or failure can result.
- Do not operate the product outside of the specifications.  
Do not use for flammable or harmful fluids.  
Fire, malfunction, or damage to the product can result.  
Verify the specifications before use.
- Do not operate in an atmosphere containing flammable, explosive or corrosive gas.  
Fire or an explosion can result.  
This product is not designed to be explosion proof.
- Do not use the product for flammable fluid.  
A fire or explosion can result.
- Do not use the product in a place where static electricity is a problem.  
Otherwise it can cause failure or malfunction of the system.
- If using the product in an interlocking circuit:
  - Provide a double interlocking system, for example a mechanical system
  - Check the product regularly for proper operationOtherwise malfunction can result, causing an accident.
- The following instructions must be followed during maintenance:
  - Turn off the power supply
  - Stop the air supply, exhaust the residual pressure and verify that the air is released before performing maintenance workOtherwise an injury can result.

#### **Caution**

- Do not touch the terminals and connectors while the power is on.  
Otherwise electric shock, malfunction or damage to the product can result.
- After maintenance is complete, perform appropriate functional inspections and leak tests.  
Stop operation if the equipment does not function properly or there is a leakage of fluid.  
When leakage occurs from parts other than the piping, the product might be faulty.  
Disconnect the power supply and stop the fluid supply.  
Do not apply fluid under leaking conditions.  
Safety cannot be assured in the case of unexpected malfunction.

## ■NOTE

- Follow the instructions given below when designing, selecting and handling the product.
- The instructions on design and selection (installation, wiring, environment, adjustment, operation, maintenance, etc.) described below must also be followed.
- \*Product specifications
  - Use the specified voltage.
    - Otherwise failure or malfunction can result.
    - Insufficient supply voltage may not drive a load due to a voltage drop inside the product.
    - Verify the operating voltage of the load before use.
  - Do not exceed the specified maximum allowable load.
    - Otherwise it can cause damage or shorten the lifetime of the product.
  - Data stored by the product is not deleted, even if the power supply is cut off.
    - (writing time: 1000000 cycles.)
  - The applicable fluids are air and Nitrogen.
    - The fluid temperature range is 0 to 50 °C.
  - Before designing piping confirm the pressure loss at the sensor from the pressure loss graph.
    - Confirm pressure loss of the sensor from the characteristics data.
  - Do not use compressed air containing a lot of condensate.
    - Otherwise failure or malfunction can result.
    - If compressed air containing condensate is used, install an air dryer or drain catch before the filter and perform draining regularly.
  - Use the specified measurement flow rate and operating pressure.
    - Otherwise it can cause damage to the product or inability to measure correctly.
  - Reserve a space for maintenance.
    - Allow sufficient space for maintenance when designing the system.

## ●Product handling

### \*Installation

- Tighten to the specified tightening torque.  
If the tightening torque is exceeded the mounting screws and brackets may be damaged.  
If the tightening torque is insufficient, the product may be displaced and the mounting screws may come loose.  
(Refer to page 15 "Mounting and Installation".)
- Ensure that the FG terminal is connected to ground when using a commercially available switch-mode power supply.
- Do not drop, hit or apply excessive shock to the product.  
Otherwise damage to the internal parts can result, causing malfunction.
- Do not pull the lead wire forcefully, or lift the product by the lead wire. (Tensile force 49 N or less)  
Hold the product body when handling, to prevent damage, failure or malfunction.
- For piping of the product, hold the piping with a spanner on the metal part of the product (Piping attachment).  
Holding other parts with a spanner leads to may damage the product.
- Any dust left in the piping should be flushed out by air blow before connecting the piping to the product.  
Otherwise damage or malfunction can result.
- Refer to the flow direction of the fluid indicated on the product label for installation and piping.  
Remaining air can cause inability to measure accurately.
- Do not mount the body with the bottom facing upwards.  
Retention of air can cause inability to measure accurately.
- Avoid piping in which the piping size of the IN side of the product changes suddenly.  
If the piping size is reduced sharply or there is a restrictor such as a valve on the IN side, fluid velocity distribution in the piping will be disturbed, leading to improper measurement.  
Therefore, the above-mentioned piping should be connected on the OUT side.  
If the orifice of the OUT side is fully closed to operate the pump, the switch may malfunction due to the effect of pulsation (pressure fluctuation). Ensure that there is no malfunction before usage.
- Do not insert metal wires or other foreign matter into the piping port.  
This can damage the sensor causing failure or malfunction.
- Never mount a product in a location that will be used as a foothold.  
The product may be damaged if excessive force is applied by stepping or climbing onto it.
- If there is a risk of foreign matter entering the fluid, install and pipe a filter or the mist separator at the inlet to avoid failure and malfunction.  
Otherwise damage or malfunction can result.  
And it can cause inability to measure accurately.
- Do not apply excessive rotational force to the monitor.  
Rotating the monitor with excessive force will damage the end stop.

#### \*Wiring

- Do not pull the lead wires.

In particular, never lift a product equipped with fitting and piping by holding the lead wires.

Otherwise damage to the internal parts can result, causing malfunction or disconnection of the connector.

- Avoid repeatedly bending or stretching the lead wire, or placing heavy loads on it.

Repeated bending stress or tensile stress can cause damage to the sheath, or breakage of the wires.

If the lead wire can move, fix it near the body of the product.

The recommended bend radius of the lead wire is 6 times the outside diameter of the sheath, or 33 times the outside diameter of the wire insulation material, whichever is larger.

Replace any damaged lead wire with a new one.

- Wire correctly.

Incorrect wiring can damage the product.

- Do not perform wiring while the power is on.

Otherwise damage to the internal parts can result, causing malfunction.

- Do not route wires and cables together with power or high voltage cables.

Otherwise the product can malfunction due to interference or noise and surge voltage from power and high voltage cables.

- Confirm proper insulation of wiring.

Poor insulation (interference from another circuit, poor insulation between terminals, etc.) can lead to excess voltage or current being applied to the product, causing damage.

- Keep wiring as short as possible to prevent interference from electromagnetic noise and surge voltage.

Do not use a cable longer than 10 m.

Wire the DC(-) line (blue) as close as possible to the power supply.

- When analogue output is used, install a noise filter (line noise filter, ferrite element, etc.) between the switch-mode power supply and this product.

#### \*Environment

- Do not use the product in an environment that is constantly exposed to the splash of water.  
Otherwise failure or malfunction can result. Take measures such as using a cover.
- Do not use the product in an environment where corrosive gases or fluids could be splashed.  
Otherwise damage to the product and malfunction can result.
- Do not use in a place where the product could be splashed by oil or chemicals.  
If the product is to be used in an environment containing oils or chemicals such as coolant or cleaning solvent, even for a short time, it may be adversely affected (damage, malfunction, or hardening of the lead wires)
- Do not use in an area where electrical surges are generated.  
If there is equipment generates a large electrical surge (solenoid type lifter, high frequency induction furnace, motor, etc.) close to the product, damage or failure of the internal circuit may occur. Take measures against the surge sources, and prevent the wires from coming into close contact.
- Do not use a load which generates surge voltage.  
When a surge-generating load such as a relay or solenoid is driven directly, use a product with a built-in surge absorbing element.
- The product is CE marked, but not immune to lightning strikes. Take measures against lightning strikes in the system.
- Do not use the product in areas that are exposed to vibration or impact.  
Otherwise failure or malfunction can result.
- Do not use the product in the presence of a magnetic field.  
This may lead to the malfunction of the product.
- Prevent foreign matter such as wire debris from entering the product.  
Otherwise failure or malfunction can result.
- Do not use the product in areas subject to large temperature cycle.  
Heating/cooling cycles other than ordinary changes in temperature can adversely affect the internal structure of the product.
- Do not expose the product to direct sunlight.  
If using in a location directly exposed to sunlight, use a suitable protective cover.  
Otherwise failure or malfunction can result.
- Keep within the operating fluid temperature and operation temperatures range.  
The operating fluid temperature and operating temperature range is 0 to 50 °C.  
Operation below the minimum temperature limit may cause damage or operation failure due to frozen moisture in the fluid or air.  
Protection against freezing is necessary.  
An air dryer is recommended for elimination of drainage and water.  
Avoid sudden temperature changes even within the specified temperature range.
- Do not operate close to a heat source, or in a location exposed to radiant heat.  
Otherwise malfunction can result.

#### \*Adjustment and Operation

- Connect load before turning on the power.

Otherwise it can cause excess current causing instantaneous damage to the product.

- Do not short-circuit the load.

Although an error is displayed when the product load is short circuited, excess current may cause damage to the product.

- Do not press the setting buttons with a sharp pointed object.

This may damage the setting buttons.

- Supply the power when there is no flow.

The display and analogue output will drift by approximately 2 to 3%F.S. immediately after the power supply is turned on.

- The output is off for 3 seconds after power is supplied.

- Use settings suitable for the operating conditions.

Incorrect settings can cause operational failure.

(Refer to page 19 "Outline of setting")

- During the initial setting and any subsequent flow rate setting, the product will switch the output according to the existing settings until the changes are complete.

Confirm the output has no adverse effect on machinery and equipment before setting.

Stop the control system before setting if necessary.

#### \*Maintenance

- Perform regular maintenance and inspections.

There is a risk of unexpected malfunction of components due to the malfunction of equipment and machinery.

- Turn off the power supply, stop the supplied air, exhaust the residual pressure and verify the release of air before performing maintenance.

There is a risk of unexpected malfunction.

- Perform drainage regularly.

If condensate enters the outside, it can cause operating failure of pneumatic equipment.

- Do not use solvents such as benzene, thinner etc. to clean the product.

They could damage the surface of the body and erase the markings on the body.

Use a soft cloth to remove stains.

For heavy stains, use a cloth lightly dampened with diluted neutral detergent, then wipe up any residue with a dry cloth.

# Model indication and How to Order

PF2A 7  -   -   -  -

Integrated display type

Rated flow range

Symbol	Content
10	1 to 10 L/min
50	5 to 50 L/min
11	10 to 100 L/min
21	20 to 200 L/min
51	50 to 500 L/min

Thread type

Symbol	Content
Nil	Rc
N	NPT
F	G

Port size

Symbol	Port size	Rated flow range				
		10	50	11	21	51
01	1/8 inch	●	●	-	-	-
02	1/4 inch	●	●	-	-	-
03	3/8 inch	-	-	●	●	-
04	1/2 inch	-	-	-	-	●

Made to order  
(Refer to page 11.)

Unit specification

Symbol	Content
Nil	Unit selection function *1
M	SI unit only *2

\*1: Since the unit for japan is fixed to SI due to new measurement law, this option is for overseas.

\*2: Fixed unit Instantaneous flow: L/min  
Accumulated flow: L

Lead wire  
(Refer to page 11.)

Output specification

Symbol	Content
27	NPN (2 outputs)
67	PNP (2 outputs)

## Lead wire

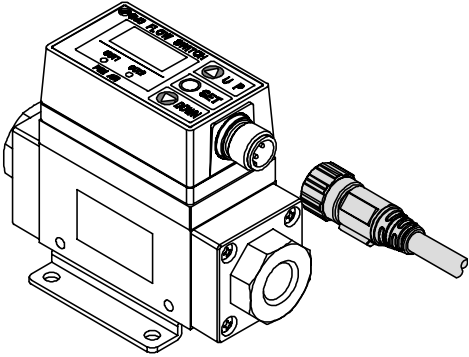
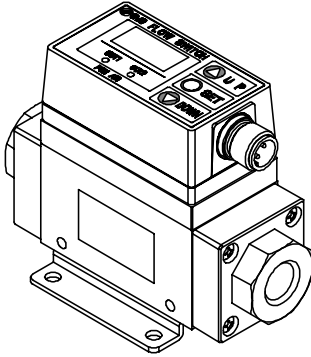
NIL	N
<p data-bbox="264 376 576 439">with lead wire and connector (Straight, 3 m)</p> 	<p data-bbox="858 376 1043 405">without lead wire</p> 

\*: Lead wire is not assembled with the product, but shipped together.

## Made to order

Model indication	Content	Page
PF2A7□□-□□-28□-□-X560	Output specification (1 output): NPN + Analogue (1 to 5 V)	Page 40
PF2A7□□-□□-29□-□-X560	Output specification (1 output): NPN + Analogue (4 to 20 mA)	
PF2A7□□-□□-68□-□-X560	Output specification (1 output): PNP + Analogue (1 to 5 V)	
PF2A7□□-□□-69□-□-X560	Output specification (1 output): PNP + Analogue (4 to 20 mA)	

## Accessories / Part number

If an accessory is required separately, order using the following part numbers.

Part number	Description	Remarks	Weight
ZS-37-A	Lead wire with connector (Straight)	Length: 3 m	100 g
ZS-37-B	Lead wire with connector (Right angle)	Length: 3 m	100 g
ZS-29-T	Bracket	Mounting screw (3 x 12 Self tapping screw) 4 pcs.	40 g

## Summary of Product parts

### Body

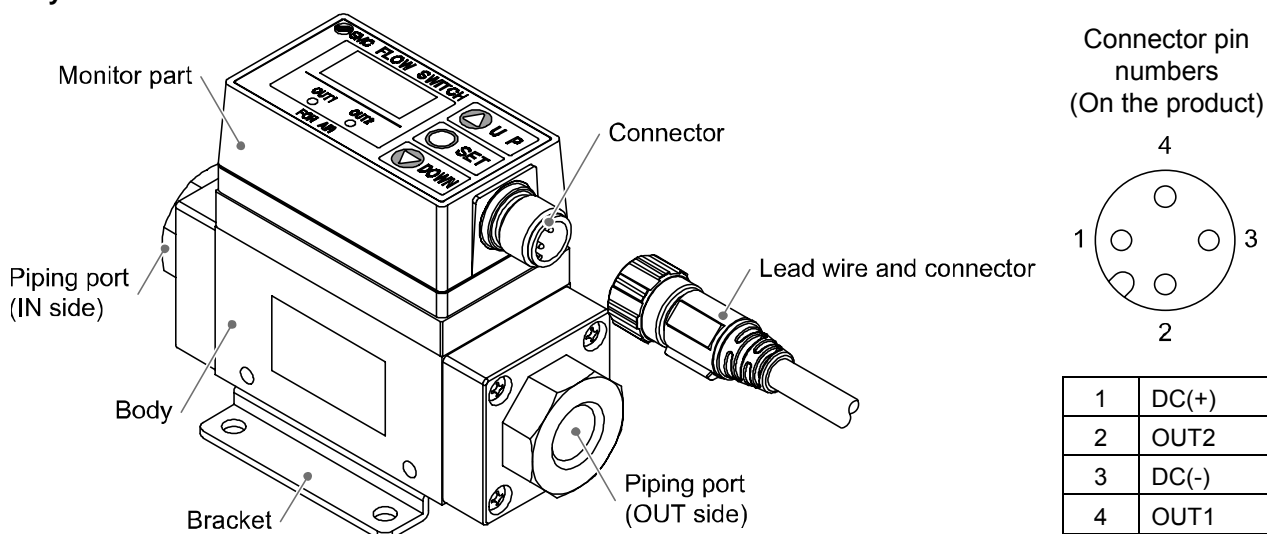

Item	Description
Monitor part	See below.
Piping port	Connected to the fluid inlet at IN side and to the fluid outlet at OUT side.
Body	The body of the product.
Bracket	Bracket for mounting the product.
Connector	Connector for electrical connections.
Lead wire and connector	Lead wire to supply power and transmit output signals.

### Monitor part

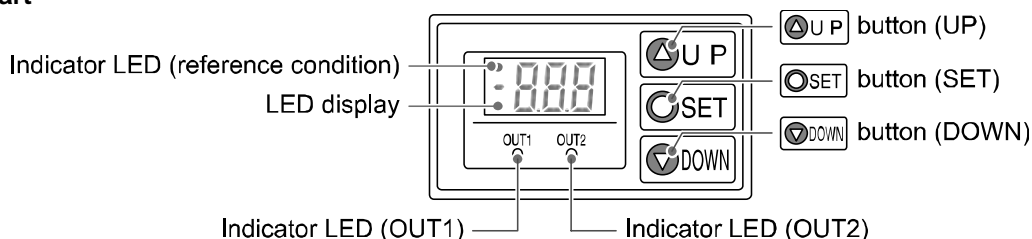

Item	Description
Indicator LED (reference condition)	Indicates the reference condition selected. LED is ON (Red) when normal condition is selected.
LED display	Displays the flow value, setting mode, and error indication.
Indicator LED (OUT1)	Indicates the output status of OUT1. LED is ON (Green) when OUT1 is ON. The LED flashes when an over current error occurs. When the accumulated pulse output mode is selected, the indicator LED will turn OFF.
Indicator LED (OUT2)	Indicates the output status of OUT2. LED is ON (Red) when OUT2 is ON. The LED flashes when an over current error occurs. When the accumulated pulse output mode is selected, the indicator LED will turn OFF.
UP button (UP)	Selects the mode or increases the ON/OFF Set value.
SET button (SET)	Press this button to change to another mode and to set a value.
DOWN button (DOWN)	Selects the mode or decreases the ON/OFF Set value.

## ■ Definition and terminology

	Terms	Meaning
A	Accumulated flow	The total amount of fluid that has passed through the device. If an instantaneous flow of 10 L/min continues for 5 minutes, the accumulated flow will be $10 \times 5 = 50$ L.
	Accumulated pulse output	A type of output where a pulse is generated every time a predefined accumulated flow passes. It is possible to calculate the total accumulated flow by counting the pulses.
	Analogue output	Outputs a value proportional to the flow rate. When the analogue output is in the range 1 to 5 V, it will vary between 1 to 5 V according to the rate of flow. The same for analogue output of 4 to 20 mA.
	Attachment	A metal part at both sides of the product to connect piping.
	Auto-preset	This function calculates and sets the pressure values automatically based on the on-going operation.
C	Chattering	The problem of the switch output turning ON and OFF repeatedly around the Set value at high frequency due to the effect of pulsation.
D	Digit	Minimum unit for setting / display is 1 digit. When the minimum unit for setting / display is 5 L/min, 3 digits will be $3 \times 5 = 15$ L/min
	Display flow range	The range which can be displayed by the product with a digital display.
F	Fluid temperature	Range of fluid temperature that can be measured by the product.
	F.S. (Full span, Full scale)	Stands for "full span" or "full scale", and indicates varied analogue output range at rated value. For example, when analogue output is 1 to 5 V, F.S. = $5[V] - 1[V] = 4[V]$ , (ref. $1\%F.S. = 4[V] \times 1\% = 0.04[V]$ )
H	Hysteresis	The difference between ON and OFF points used to prevent chattering. Hysteresis can be effective in avoiding the effects of pulsation.
	Hysteresis mode	Mode where the switch output will turn ON when the flow is greater than the Set value, and will turn OFF when the flow falls below the Set value by the amount of hysteresis or more.
I	Instantaneous flow	The volume of flow per unit of time. If it is 10 L/min, there is a flow of 10 L passing through the device in 1 minute.
	Internal voltage drop	The voltage drop across the product (and therefore not applied to the load), when the switch output is ON. The voltage drop will vary with load current, and ideally should be 0 V.
M	Minimum setting/display unit	The resolution of set and display values. If the minimum setting unit is 1 L/min, the flow can be displayed in 1 L/min units, i.e. 10, 11, 12.
N	Normal condition	Reference condition for volumetric flow: 101.3 kPa, 0 °C. The flow measurement which is converted at normal atmospheric pressure conditions at 0 °C.
O	Operating humidity range	The ambient humidity range within which the product will meet all published specifications.
	Operating temperature range	The ambient temperature range within which the product will meet all published specifications.
P	Part in contact with fluid	A part that comes into physical contact with the fluid.
	Pressure characteristics	The amount of variation in the analogue output or display value when the supply pressure is changed.
	Proof pressure	The pressure beyond which the flow switch will be damaged.

	Terms	Meaning
R	Rated flow range	The flow range within which the product will meet all published specifications.
	Rated pressure range	The pressure range within which the product will meet all published specifications.
	Repeatability	Reproducibility of the display or analogue output value, when the flow is repeatedly changing.
	Response time	Time from when the target flow is applied until the flow reaches 90% of the Set value.
S	Setting flow range	The range of ON/OFF threshold values that can be set for flow switches products with a switch output.
	Standard condition	Reference condition for volumetric flow: 101.3 kPa, 20 °C, 65%R.H. The flow measurement which is converted at normal atmospheric pressure conditions at 20 °C, 65%R.H.
	Switch output	An output type that has only 2 conditions, ON or OFF. In the ON condition an indicator LED will turn on, and any connected load will be powered. In the OFF condition, there will be no indicator LED and no power is supplied to the load.
T	Temperature characteristics	The amount of variation in the analogue output or display value when the ambient temperature is changed.
U	Unit selection function	Function to change the unit in which the value of flow is displayed. Only a product with this function can change the unit. A product with unit selection function cannot be purchased if it is used within Japan. Flow is indicated only by SI units in Japan.
W	Window comparator mode	An operating mode in which the switch output is turned on or off depending on whether the flow is within the range of 2 Set values.

## Mounting and Installation

### ■ Installation

- Never mount the product in a location that will be used as a foothold.
- The rotation angle of the monitor is  $270^\circ$ , in steps of  $90^\circ$ . Rotating the display part with excessive force will damage the end stop.

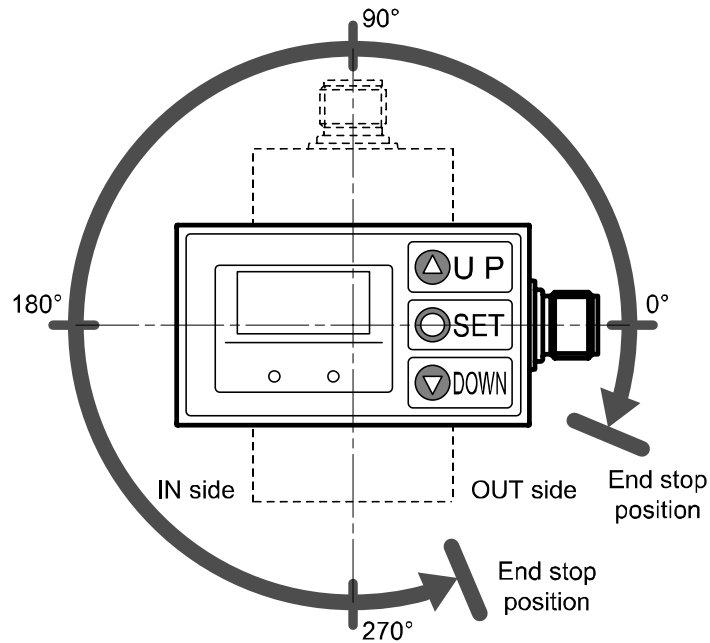

### ● Installing

- Install the product (with bracket) using the M4 screws (4 pcs.) supplied.
- Bracket thickness is approximately 1.6 mm.
- Refer to the dimension drawing of the bracket (page 39) for mounting hole dimensions.

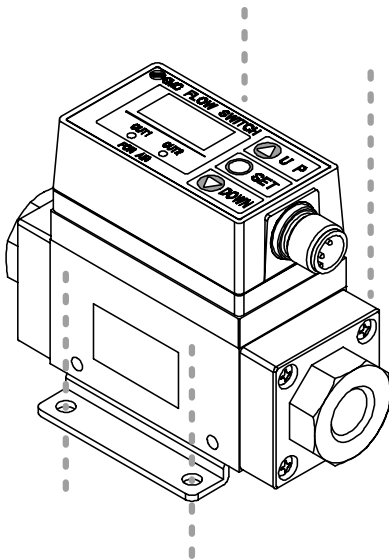

## ■ Piping

- Use the product within the specified operating pressure range and temperature range.
- Proof pressure is 1.0 MPa.
- Connect the piping to the fittings.
- Mount the product so that the fluid direction is the same as the arrow indicated on the product.
- Never mount the product upside down.
- The piping on the IN side must have a straight section of piping whose length is 8 times the piping diameter or more.
- Avoid sudden changes in the piping size on the IN side of the product.

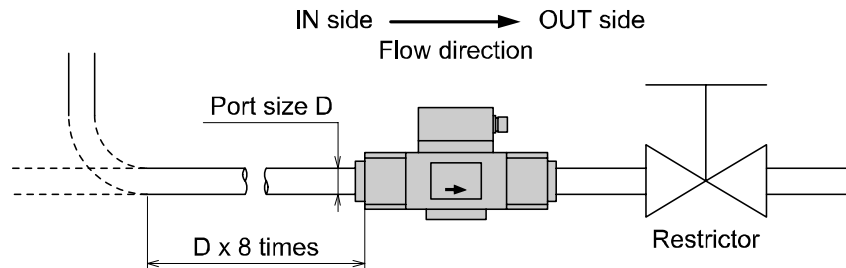

## ● Connecting the piping

- Ensure that the metal piping attachments are tightened to the required torque (refer to the table below).
- If the tightening torque is exceeded, the product can be broken. If the tightening torque is insufficient, the fittings may become loose.
- When connecting piping to the product, a spanner should be used on the metal piping attachment only. Using a spanner on other parts may damage the product.
- Avoid any sealing tape from entering inside the piping.
- Ensure that there is no leakage from loose piping.

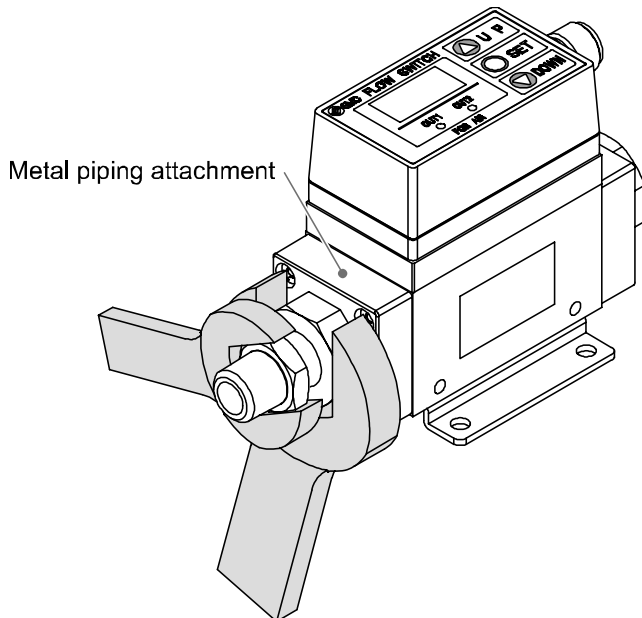

Nominal thread size	Required torque
Rc(NPT)1/8	7 to 9 Nm
Rc(NPT)1/4	12 to 14 Nm
Rc(NPT)3/8	22 to 24 Nm
Rc(NPT)1/2	28 to 30 Nm

Model	Width across flats of attachment
PF2A710	24 mm
PF2A750	
PF2A711	30 mm
PF2A721	
PF2A751	

## ■Wiring

- Connections should only be made with the power supply turned off.
- Use separate routes for the product wiring and any power or high voltage wiring. Otherwise, malfunction may result due to noise.
- Ensure that the FG terminal is connected to ground when using a commercially available switch-mode power supply. When a switch-mode power supply is connected to the product, switching noise will be superimposed and the product specification can no longer be met. This can be prevented by inserting a noise filter, such as a line noise filter and ferrite core, between the switch-mode power supply and the product, or by using a series power supply instead of a switch-mode power supply.

## ●Connecting the wiring

- Align the lead wire connector with the connector key groove, and insert vertically.
- Connection is complete when the knurled part is fully tightened. Check that the connection is not loose.

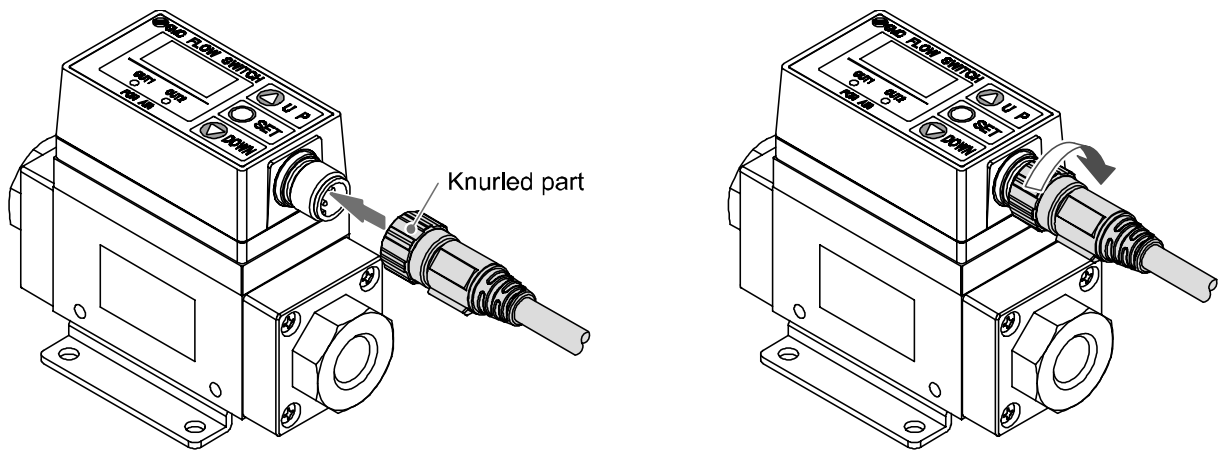

## ●Connector Pin numbers

When the lead wire with connector designated for the PF2A7 is used, the wire colours will apply as shown in the diagram.

### Connector Pin numbers (on the lead wire)

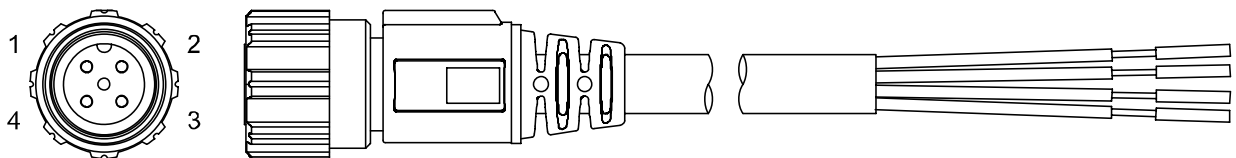

Pin number	Content	Colour
1	DC(+)	Brown
2	OUT2	White
3	DC(-)	Blue
4	OUT1	Black

● **Internal circuit and wiring example**

When the lead wire with connector designated for the PF2A7 is used, the wire colours will apply as shown in the diagram.

**NPN (2 outputs) type**

PF2A7□□-□□-27□-□

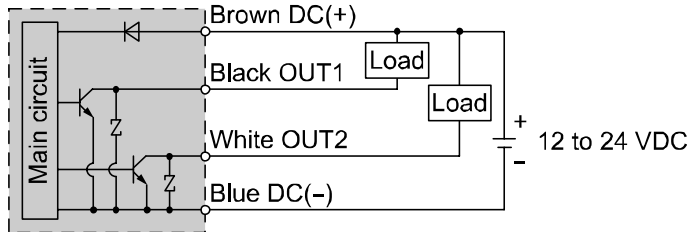

Max. 30 V, 80 mA

Internal voltage drop: 1 V or less

**PNP (2 outputs) type**

PF2A7□□-□□-67□-□

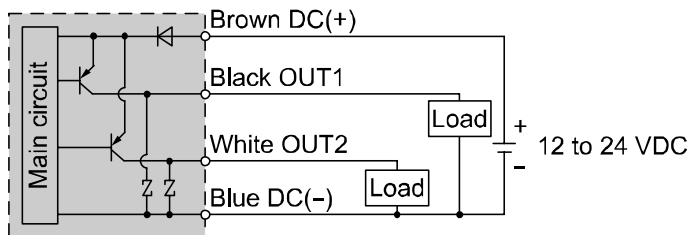

Max. 80 mA

Internal voltage drop: 1.5 V or less

## Outline of setting

### Power is supplied





The output will not operate for 3 seconds after supplying power.  
The identification code of the product is displayed.



### Measurement mode

The mode in which the flow is detected and displayed, and the switch function is operating. This is the basic operating mode; and other modes should be selected for setting changes and other function settings.

The display of instantaneous flow and accumulated flow can be changed while the  button is pressed.

While pressing the  button during the display of accumulated flow, the accumulation can be started / stopped by pressing the  button.

  
↑↓  
button  
press  
for 2 sec.

  
↑↓  
button  
press.

  
↑↓  
button  
press  
for 3 sec.

### Initialize mode

(Refer to page 21)

Items below can be set.

- Display mode
- Unit selection function \*
- Output mode (OUT1)
- Output mode (OUT2)
- Switch operation (OUT1)
- Switch operation (OUT2)
- Reference condition

### Function selection mode

(Refer to page 25)

Items below can be set.

- [F\_1]  
Input the Set value of instantaneous output
- [F\_2]  
Input the Set value of instantaneous output (Auto-preset)
- [F\_3]  
Input the Set value of accumulated output

### Key-lock function

(Refer to page 30)

This function is used to prevent errors occurring due to unintentional changes of the Set values.

\*: Operate only the product with unit selection function.

## ■List of outputs

Find the diagram of the output required in the table below. Perform settings following the Set value column on the right. Characters in ( ) are for OUT2.

	Switch output diagram	Output mode	Switch operation	Set value
Instantaneous flow	<p>Hysteresis ON OFF P_2 P_1 Instantaneous flow (P_4) (P_3)</p>	Instantaneous output mode 	Non-Reverse output 	Set point 2    Set point 1 <sup>*2z</sup>  Hysteresis mode
	<p>Hysteresis *1    Hysteresis *1 ON OFF P_1 P_2 Instantaneous flow (P_3) (P_4)</p>			Set point 1    Set point 2  Window comparator mode
	<p>Hysteresis ON OFF n_2 n_1 Instantaneous flow (n_4) (n_3)</p>		Reverse output 	Set point 2    Set point 1 <sup>*2</sup>  Hysteresis mode
	<p>Hysteresis *1    Hysteresis *1 ON OFF n_1 n_2 Instantaneous flow (n_3) (n_4)</p>			Set point 1    Set point 2  Window comparator mode
Accumulated flow	<p>Accumulated flow 1PH+1PL (2PH+2PL) ON OFF Time</p>	Accumulated output mode 	Non-Reverse output 	Upper 3 digits    Lower 3 digits 
	<p>Accumulated flow 1nH+1nL (2nH+2nL) ON OFF Time</p>		Reverse output 	Upper 3 digits    Lower 3 digits 
Accumulated pulse	<p>ON OFF 50 ms Time</p>	Accumulated pulse output mode 	Non-Reverse output 	No Set value input
	<p>ON OFF 50 ms Time</p>		Reverse output 	No Set value input

\*1: In window comparator mode, the hysteresis is fixed at 3 digits. When setting, allow 7 digits or more between Set point 1 and Set point 2 (Set point 3 and Set point 4).

\*2: When Set point 1 = Set point 2 (Set point 3 = Set point 4), chattering may occur.

## Initialize mode

### ●Default settings

The default settings are as follows.

If this condition is acceptable, then keep these settings.

Refer to the relevant page for changing the settings.

Item	Default settings	Page
Selection of display mode	[d_1] Display instantaneous flow	Page 22
Unit selection function *	[U_1] L/min	
Selection of output mode (OUT1)	[o10] Instantaneous output mode	
Selection of output mode (OUT2)	[o20] Instantaneous output mode	Page 23
Selection of switch operation (OUT1)	[1_n] Reverse output	
Selection of switch operation (OUT2)	[2_n] Reverse output	
Selection of reference condition	[Anr] Standard condition	

\*: Operate only the product with unit selection function.

## ■ Setting procedure of initialize mode

### <Operation>

Press the  button for 2 seconds or longer in measurement mode.

#### Selection of display mode

Select the display of instantaneous flow or accumulated flow.

Press the  button to select.

- [d\_1]: display instantaneous flow
- [d\_2]: display accumulated flow

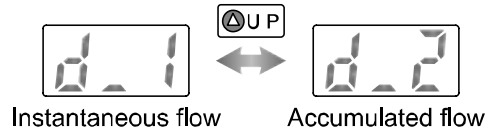

The product with unit selection function

Press the  button.

SI unit only

#### Selection of unit selection function

Display unit can only be selected for products with unit selection function.

Press the  or  button for selection.

Display	Instantaneous flow	Accumulated flow
[U_1]	L/min	L
[U_2] *	CFM x 10 <sup>-2</sup> , CFM x 10 <sup>-1</sup>	ft <sup>3</sup> x 10 <sup>-1</sup>

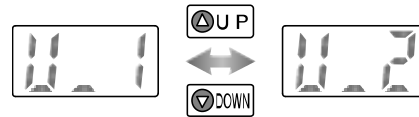

\*: Refer to page 24 for the flow rate when [U\_2] is selected.

Press the  button.

#### Selection of output mode (OUT1)

Select the switch output mode required referring to the list of outputs (page 20).

Press the  button to select.

- [o10]: Instantaneous output mode
- [o11]: Accumulated output mode
- [o12]: Accumulated pulse output mode

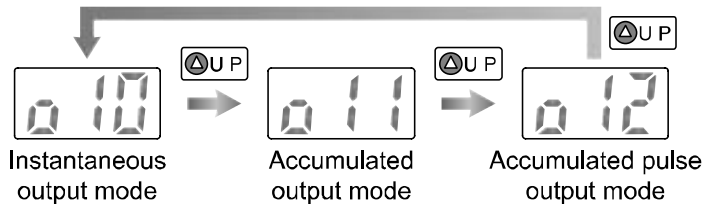

Press the  button.

#### Selection of output mode (OUT2)

Select the switch output mode required referring to the list of outputs (page 20).

Press the  button to select.

- [o20]: Instantaneous output mode
- [o21]: Accumulated output mode
- [o22]: Accumulated pulse output mode

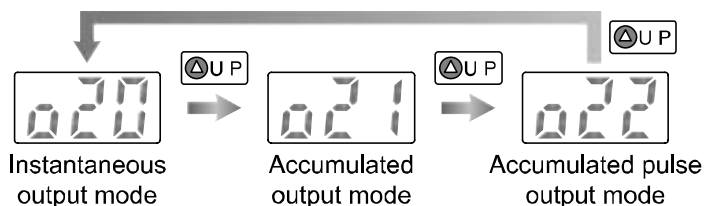

Press the  button. (Continued)



### Selection of switch operation (OUT1)

Select the switch operation required referring to the list of outputs (page 20).

Press the  button to select.

- [1\_n]: Reverse output
- [1\_P]: Non-Reverse output

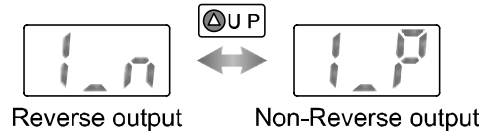

Press the  button.

### Selection of switch operation (OUT2)

Select the switch operation required referring to the list of outputs (page 20).

Press the  button to select.

- [2\_n]: Reverse output
- [2\_P]: Non-Reverse output

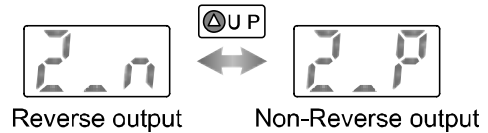

Press the  button.

### Reference condition selection

Select standard condition or normal condition for the display units.

Press the  button to select.

- [ Anr]: Standard condition.  
Flow display which is converted in atmospheric pressure at 20 °C, 65%R.H.
- [ nor]: Normal condition.  
Flow display which is converted in atmospheric pressure at 0 °C.

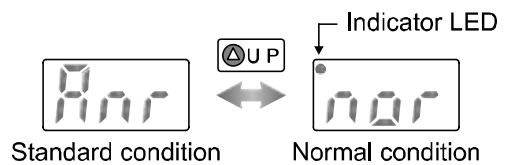

\*: Flow rate in the specification is the value at standard condition.

If the display unit standard is changed from standard to normal, use the conversion formula.

Flow rate at standard condition x 0.927 = Flow rate at normal condition

\*: When [nor] is selected, an Indicator LED (reference condition) [ • ] appears on the upper left of the screen.



Press the  button.

Setting of initialize mode is completed.  
Return to measurement mode.

Flow specification when [U\_2] is selected by the unit selection function

Model		PF2A710	PF2A750	PF2A711	PF2A721	PF2A751	
Flow	Rated flow range		3.5 to 35.5 CFM x 10 <sup>-2</sup>	18 to 176 CFM x 10 <sup>-2</sup>	3.5 to 35.5 CFM x 10 <sup>-1</sup>	7 to 71 CFM x 10 <sup>-1</sup>	18 to 176 CFM x 10 <sup>-1</sup>
	Instantaneous flow	Setting/display flow range *	1.0 to 38.0 CFM x 10 <sup>-2</sup>	8 to 186 CFM x 10 <sup>-2</sup>	1.0 to 38.0 CFM x 10 <sup>-1</sup>	2 to 76 CFM x 10 <sup>-1</sup>	8 to 186 CFM x 10 <sup>-1</sup>
		Min. setting/display unit	0.5 CFM x 10 <sup>-2</sup>	2.0 CFM x 10 <sup>-2</sup>	0.5 CFM x 10 <sup>-1</sup>	1.0 CFM x 10 <sup>-1</sup>	2.0 CFM x 10 <sup>-1</sup>
	Accumulated flow	Setting/display flow range	0 to 999999 ft <sup>3</sup> x 10 <sup>-1</sup>				
		Min. setting/display unit	1 ft <sup>3</sup> x 10 <sup>-1</sup>				
	Conversion of accumulated pulse		0.5 ft <sup>3</sup> x 10 <sup>-2</sup> /pulse	2.0 ft <sup>3</sup> x 10 <sup>-2</sup> /pulse	0.5 ft <sup>3</sup> x 10 <sup>-1</sup> /pulse	1.0 ft <sup>3</sup> x 10 <sup>-1</sup> /pulse	2.0 ft <sup>3</sup> x 10 <sup>-1</sup> /pulse

\*: Flow rate in the specification is the value at standard condition.

If the display unit standard is changed from standard to normal, use the conversion formula.

Flow rate at standard condition x 0.927 = Flow rate at normal condition

## Function selection mode

### Function selection mode

In measurement mode, press the  button, to display [F\_□].  
This [F\_□] indicates the mode for changing each functional setting.

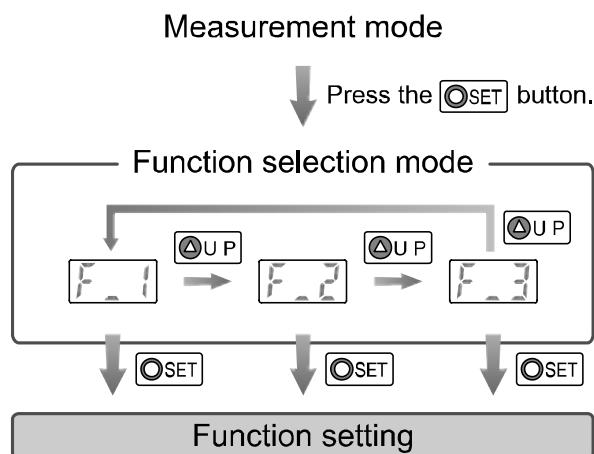

\*: When OUT1 or OUT2 is assigned to be instantaneous output mode during initialize mode, [F\_1] and [F\_2] are displayed.  
When OUT1 or OUT2 is assigned to be accumulated output mode, [F\_3] is displayed.

### •Default settings

The default settings are as follows.

If this condition is acceptable, then keep these settings.

Refer to the relevant page for changing the settings.

Item		Default Setting	Page
[F_1] Input the Set value of instantaneous output	[n_1] * Input of the Set point 1 (OUT1)	50% of max. rated flow	Page 26
	[n_2] * Input of the Set point 2 (OUT1)	50% of max. rated flow	
	[n_3] * Input of the Set point 3 (OUT2)	50% of max. rated flow	
	[n_4] * Input of the Set point 4 (OUT2)	50% of max. rated flow	
[F_2] Input the Set value of instantaneous output (Auto-preset)	—	—	Page 27
[F_3] Input the Set value of accumulated output	[1nL] * Input of the Set value for the lower 3 digits (OUT1)	[ 0]	Page 28
	[1nH] * Input of the Set value for the upper 3 digits (OUT1)	[ 0]	
	[2nL] * Input of the Set value for the lower 3 digits (OUT2)	[ 0]	
	[2nH] * Input of the Set value for the upper 3 digits (OUT2)	[ 0]	

\*: When Non-Reverse output is selected as the switching operation, n becomes P.

## ■ [F\_1] Input procedure of the Set value of instantaneous output

The Set point of the switch output can be set manually.



### <Operation>

Press the  button in function selection mode to display [F\_1]. (When OUT1 or OUT2 is assigned to be accumulated output mode, [F\_1] is displayed.)

↓ Press the  button.

### Input of the Set point 1 (OUT1)

[n\_1] \* and the current Set value are displayed in turn.

Press the  and  button to change the value referring to the list of outputs (page 20).

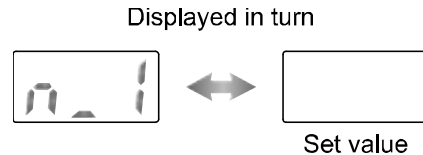



\*: When Non-Reverse output is selected as the switch operation, [P\_1] is displayed.

↓ Press the  button.

### Input of the Set point 2 (OUT1)

[n\_2] \* and the current Set value are displayed in turn.

Press the  and  button to change the value referring to the list of outputs (page 20).

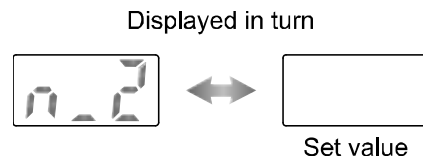



\*: When Non-Reverse output is selected as the switch operation, [P\_2] is displayed.

↓ Press the  button.

### Input of the Set point 3 (OUT2)

[n\_3] \* and the current Set value are displayed in turn.

Press the  and  button to change the value referring to the list of outputs (page 20).

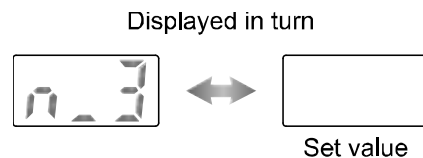



\*: When Non-Reverse output is selected as the switch operation, [P\_3] is displayed.

↓ Press the  button.

### Input of the Set point 4 (OUT2)

[n\_4] \* and the current Set value are displayed in turn.

Press the  and  button to change the value referring to the list of outputs (page 20).

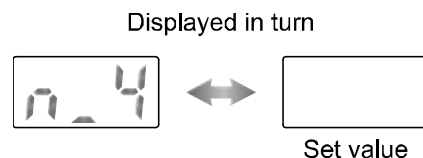

\*: When Non-Reverse output is selected as the switch operation, [P\_4] is displayed.

↓ Press the  button.

[F\_1] Input procedure of the Set value of instantaneous output is completed.  
Return to measurement mode.

## ■ [F\_2] Input procedure of the Set value of instantaneous output (Auto-preset)

The Set point of the switch output can be automatically set referring to actual air flow.

### <Operation>

Press the  button in function selection mode to display [F\_2]. (When OUT1 or OUT2 is assigned to be accumulated output mode, [F\_2] is displayed.)



↓ Press the  button.

### Measurement of the Set value (OUT1)

[AP1] is displayed.

Apply flow rate to set for OUT1.



\*: If setting of OUT1 is not necessary, press the  and  buttons simultaneously.

The display moves on to the measurement of OUT2 Set value.

↓ Press the  button.

[A1L] and the Set value are displayed in turn.

The flow rate is read automatically,  
and the Set value is set.

A value 3 digits below is set as hysteresis.

Displayed in turn



Set value



↓ Press the  button.

### Measurement of the Set value (OUT2)

[AP2] is displayed.

Apply flow rate to set for OUT2.



\*: If setting of OUT1 is not necessary, press the  and  buttons simultaneously.

Return to the measurement mode.

↓ Press the  button.

[A2L] and the Set value are displayed in turn.

The flow rate is read automatically,  
and the Set value is set.

A value 3 digits below is set as hysteresis.

Displayed in turn



Set value

↓ Press the  button.

[F\_2] Input procedure of the Set value of instantaneous output (Auto-preset) is completed.  
Return to measurement mode.

■ [F\_3] Input procedure of the Set value of accumulated output

The Set point of the switch output can be manually set. Accumulated flow rate is displayed by the lower 3 digits and upper 3 digits separately. Setting is performed separately.



**<Operation>**

Press the  button in function selection mode to display [F\_3]. (When both OUT1 and OUT2 are assigned to be instantaneous output mode or accumulated output mode, [F\_3] is not displayed. When OUT1 or OUT2 is assigned to be accumulated output mode, [F\_3] is displayed.)

↓ Press the  button.

**Input of the Set value for the lower 3 digits (OUT1)**

[1nL] \* and the current Set value are displayed in turn.

Press the  and  button to change the value referring the list of outputs (page 20).

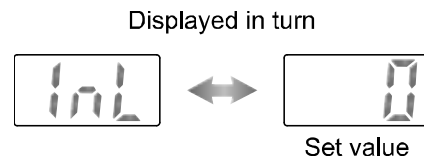

\*: When Non-Reverse output is selected as the switch operation, [1PL] is displayed.



↓ Press the  button.

**Input of the Set value for the upper 3 digits (OUT1)**

[1nH] \* and the current Set value are displayed in turn.

Press the  and  button to change the value referring the list of outputs (page 20).

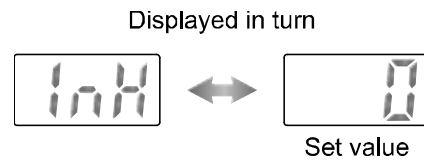

\*: When Non-Reverse output is selected as the switch operation, [1PH] is displayed.



↓ Press the  button.

**Input of the Set value for the lower 3 digits (OUT2)**

[2nL] \* and the current Set value are displayed in turn.

Press the  and  button to change the value referring the list of outputs (page 20).

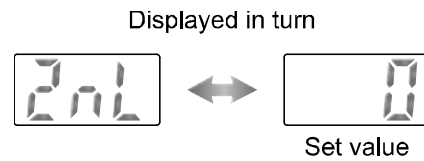

\*: When Non-Reverse output is selected as the switch operation, [2PL] is displayed.



↓ Press the  button.

**Input of the Set value for the upper 3 digits (OUT2)**

[2nH] \* and the current Set value are displayed in turn.

Press the  and  button to change the value referring the list of outputs (page 20).

\*: When Non-Reverse output is selected as the switch operation, [2PH] is displayed.

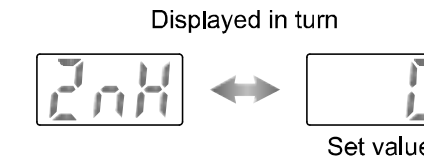



↓ Press the  button. (Continued)

[F\_3] Input procedure of the Set value of accumulated output is completed.  
Return to measurement mode.

### Starting of accumulation

Check that the display of accumulated flow rate is selected as the display mode.

Press the  and  buttons simultaneously in measurement mode.





[-] flashes and accumulation starts.

Stop and restart of accumulation are performed the same way.

Pressing the  button displays the instantaneous flow rate while displaying the accumulated flow.

The accumulated flow rate can be displayed up to 999,999 L, but the display normally shows the lower 3 digits.

Press the  button to display the upper 3 digits.

The display flashes when the value reaches 999,999 L. To reset the accumulated value, press the  and  buttons simultaneously for 2 seconds or longer.





The accumulated value will be reset if the power supply is turned off.

## Key-lock function

This function is used to prevent errors occurring due to unintentional changes of the Set values.

### <How to lock>

1. Press the  button for 3 seconds or longer in measurement mode. The display will change from [F\_□] to [d\_□] to [unL]. When [unL] is displayed, release the  button.

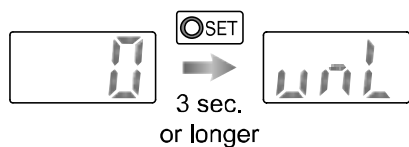

2. Press the  button to select [Loc], to lock the keys.

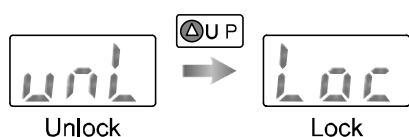

3. Key operation is locked by pressing the  button, and returns to measurement mode.



\*: Even when keys are locked, while the  button is pressed, instantaneous flow and accumulated flow can be displayed in turn.

### < How to unlock >

1. Press the  button for 3 seconds or longer in measurement mode.

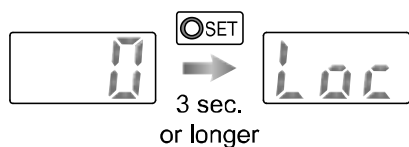

2. Press the  button to select [unL], to unlock the keys.

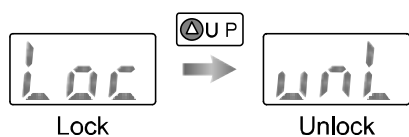

3. Key operation is unlocked by pressing the  button, and returns to measurement mode.



## Maintenance

### **How to reset the product after a power cut or forcible de-energizing**

The setting of the product will be retained as it was before a power cut or de-energizing.

The output condition is also basically recovered to that before a power cut or de-energizing, but may change depending on the operating environment.

Therefore, check the safety of the whole installation before operating the product.

# Troubleshooting

## Troubleshooting

If an operation failure occurs with the product, use the table below to find out the cause of the problem. If none of the countermeasures seem to be applicable, or a replacement product operates normally when installed, the product may be faulty. A product can be damaged by the operating environment (system configuration etc). If the product seems to be faulty, please contact SMC.





### ■ Cross-reference for troubleshooting

Fault		Probable cause	Recommended action
Display	Display is OFF.	Wiring failure.	Correct the wiring.
		Connector loose.	Check the connector.
	The display is unstable.	Foreign matter inside.	Install a filter or mist separator at IN side of product. If there is foreign matter stuck to the mesh, remove it completely, taking care not to damage the product.
		Piping is connected in the wrong direction.	Install with the mounting direction corresponding to the flow direction (arrow indicated on the product).
		Pulsation in the flow.	Change to a pump that has less pulsation. Install a tank to reduce the pressure fluctuation. Change the piping to elastic piping such as rubber tube.
		Air leakage.	Check that seal tape has been applied correctly. Reconnect the pipes with the specified tightening torque.
	The display is not correct.	Foreign matter inside.	Install a filter or mist separator at IN side of product. If there is foreign matter stuck to the mesh, remove it completely, taking care not to damage the product.
		Piping is connected in the wrong direction.	Install with the mounting direction corresponding to the flow direction (arrow indicated on the product).
		An incorrect flow unit was selected. *	Select the appropriate flow unit.
		Air leakage.	Check that seal tape has been applied correctly. Reconnect the pipes with the specified tightening torque.

\*: Operate only the product with unit selection function.

Fault		Probable cause	Recommended action
Output	There is no output.	Wiring failure.	Correct the wiring.
		Connector loose.	Check the connector.
	Output is unstable.	Foreign matter inside.	Install a filter or mist separator at IN side of product. If there is foreign matter stuck to the mesh, remove it completely, taking care not to damage the product.
		Piping is connected in the wrong direction.	Install with the mounting direction corresponding to the flow direction (arrow indicated on the product).
		Pulsation in the flow.	Change to a pump that has less pulsation. Install a tank to reduce the pressure fluctuation. Change the piping to elastic piping such as rubber tube.
		Air leakage.	Check that seal tape has been applied correctly. Reconnect the pipes with the specified tightening torque.
		Hysteresis is too narrow.	Increase the hysteresis.
Button	The buttons cannot be operated.	Key-lock mode is activated.	Cancel the Key-lock function (page 30).

## ■ Error indication

Error Name	Error Display	Error Type	Troubleshooting Method
Excessive instantaneous flow	- - -	Flow has exceeded the upper limit of the display flow range.	Reduce the flow.
OUT1 over current error	Er 1	The switch output load current is more than 80 mA (OUT1).	Turn the power off and remove the cause of the over current. Then turn the power on again.
OUT2 over current error	Er 2	The switch output load current is more than 80 mA (OUT2).	
System error	Er 4	The set data has been changed unexpectedly.	To reset, press  and  buttons simultaneously for 2 seconds or longer. Then set all data again.
Excessive accumulated flow	 Accumulated flow displayed (flashing)	The display flow range of accumulated flow has been exceeded.	To reset the accumulated flow value, press  and  buttons simultaneously for 2 seconds or longer.

\*: If the error cannot be reset after the above measures are taken, then please contact SMC.

# Specifications

## ■ Specifications

Model		PF2A710	PF2A750	PF2A711	PF2A721	PF2A751	
Applicable fluid		Air and N <sub>2</sub>					
Fluid temperature		0 to 50 °C (No freezing or condensation)					
Flow	Rated flow range	1 to 10 L/min	5 to 50 L/min	10 to 100 L/min	20 to 200 L/min	50 to 500 L/min	
	Instantaneous flow	Setting/display flow range *1 *2	0.5 to 10.5 L/min	2.5 to 52.5 L/min	5 to 105 L/min	10 to 210 L/min	25 to 525 L/min
		Min. setting/display unit	0.1 L/min	0.5 L/min	1.0 L/min	2.0 L/min	5.0 L/min
	Accumulated Flow	Setting/display flow range	0 to 999999 L				
		Min. setting/display unit	1 L				
	Reference condition *3		Standard condition, Normal condition *4				
Pressure	Rated pressure range	-50 kPa to 0.5 MPa		-50 kPa to 0.75 MPa			
	Proof pressure	1.0 MPa					
Switch output	NPN open collector output, PNP open collector output						
	Output mode *3	Instantaneous flow output mode (hysteresis mode, window comparator mode) Accumulated flow output mode, Accumulated pulse output mode					
	Switch operation *3	Non-Reversed output, Reversed output					
	Max. load current	80 mA					
	Max. applied voltage	30 VDC (NPN output)					
	Internal voltage drop	NPN output: 1 V or less (at 80 mA) PNP output: 1.5 V or less (at 80 mA)					
	Response time	1 s or less					
	Repeatability	±1%F.S. max.		±2%F.S. max.			
	Accuracy	±5%F.S. max.					
	Hysteresis	Hysteresis mode: Variable *3 Window comparator mode: Fixed (3 digits)					
	Output protection	Short circuit protection					
	Accumulated pulse	Pulse width	50 ms				
Conversion value of accumulated pulse		0.1 L/pulse	0.5 L/pulse	1 L/pulse	2 L/pulse	5 L/pulse	
Display	Display accuracy	±5%F.S. max.					
	Display part	Displayed digit: 3 digits 7 segments, Colour: Red					
	Indicator LED (output)	LED is ON when output is ON OUT1: Green OUT2: Red					
Supply voltage		12 to 24 VDC ±10%					
Power consumption (no load)		150 mA or less		160 mA or less		170 mA or less	

Model		PF2A710	PF2A750	PF2A711	PF2A721	PF2A751
Environment	Enclosure	IP65				
	Operating temperature range	Operation: 0 to 50 °C, Storage: -25 to 85 °C (no condensation or freezing)				
	Operating humidity range	Operation, Storage: 35 to 85%R.H. (no condensation)				
	Temperature characteristics	±3%F.S. max. (15 to 35 °C), ±5%F.S. max. (0 to 50 °C)				
	Withstand voltage	1000 VAC, for 1 minute between the external terminals and case				
	Insulation resistance	50 MΩ or more (at 500 VDC) between external terminals and case				
Standards and regulations		CE, RoHS				
Port size (Rc, NPT, G)		1/8, 1/4		3/8		1/2
Materials of parts in contact with fluid		ADC, NBR, SUS, PBT, Lead glass, Ptlr, FeNi, OFC				
Weight	Product	250 g		290 g		
	Lead wire and connector	100 g				

\*1: Display flow range in the specification is the value at standard condition.

If the display unit standard is changed from standard to normal, use the conversion formula.

Flow rate at standard condition x 0.927 = Flow rate at normal condition

\*2: If the flow rate is smaller than the minimum flow of the display range, "0 L/min" is displayed.

\*3: Selectable by setting.

\*4: Standard condition: Flow display which is converted in atmospheric pressure at 20 °C, 65%R.H.

Normal condition: Flow display which is converted in atmospheric pressure at 0 °C.

### Lead wire Specifications

Sheath	Finished outside diameter	approx. 4 mm
	Material	Oil-resistant PVC
Insulator	Colours	Brown, White, Black, Blue
	Outside diameter	approx. 1.14 mm
Conductor	Nominal cross section area	AWG23
	Outside diameter	approx. 0.72 mm

■ Characteristics data

● Flow characteristics (pressure loss)

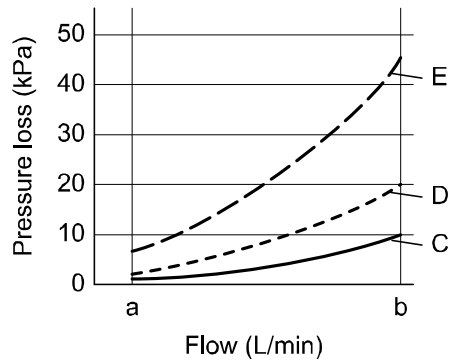
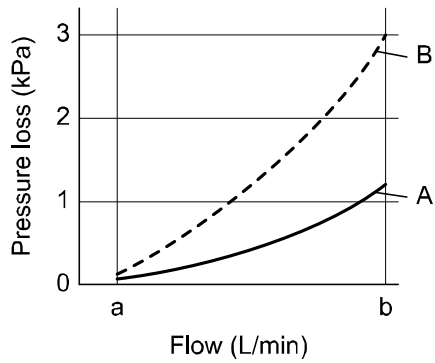

Model	Graph	a (L/min)	b (L/min)
PF2A710	A	1	10
PF2A750	B	5	50
PF2A711	C	10	100
PF2A721	D	20	200
PF2A751	E	50	500

■ Dimensions (in mm)  
PF2A710/750

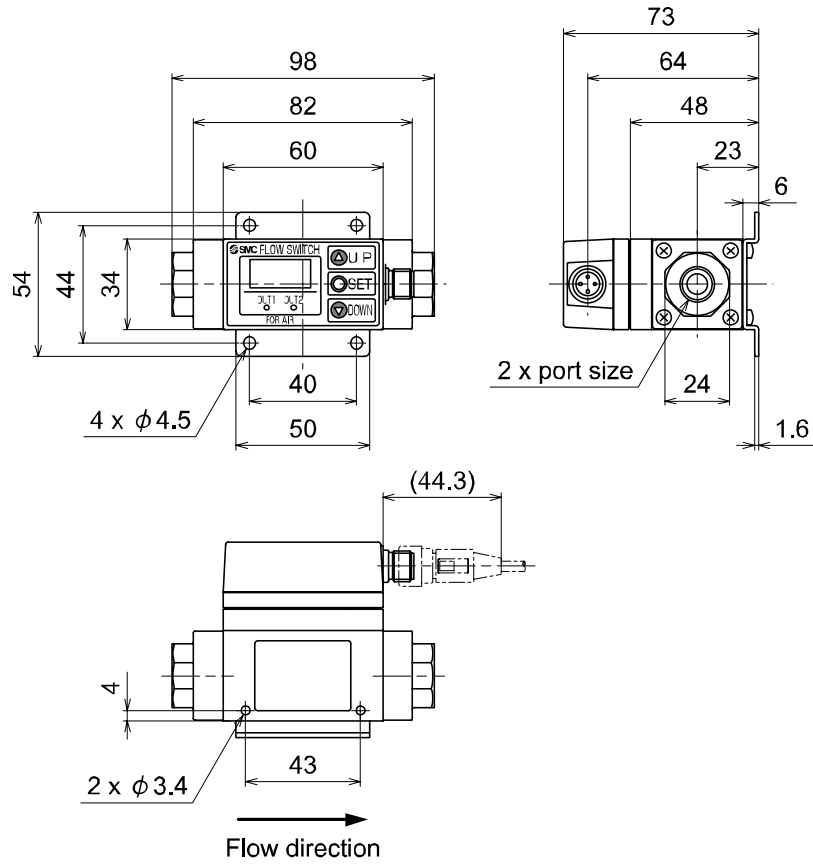

PF2A711/721/751

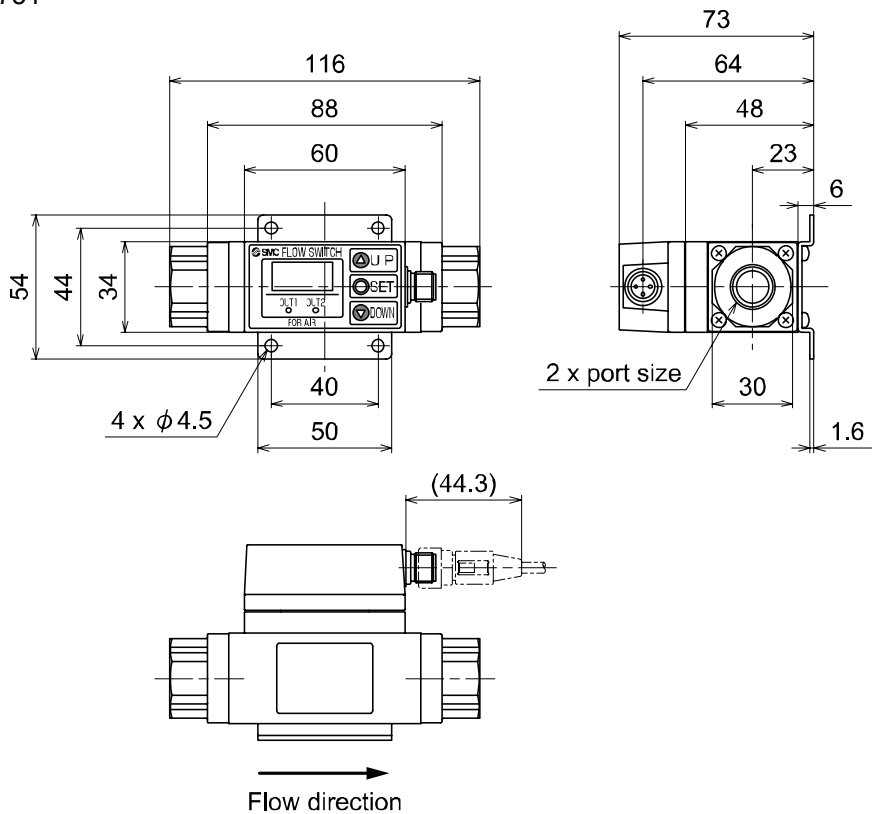

Lead wire and connector (Straight): ZS-37-A

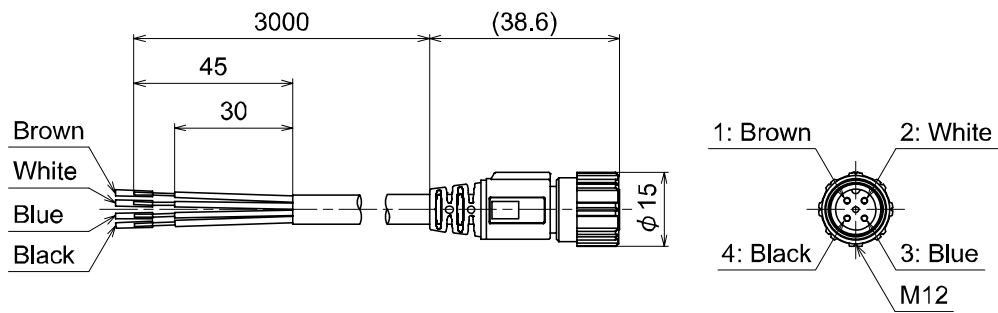

Lead wire and connector (Right angle): ZS-37-B

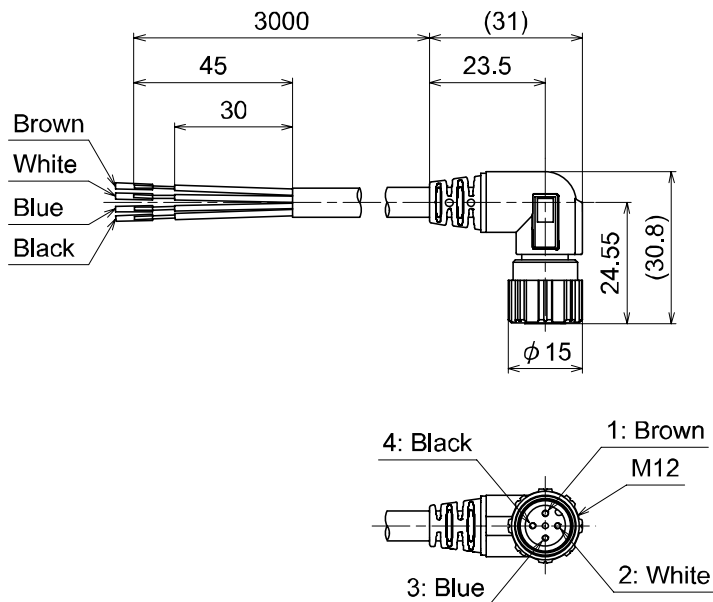

Bracket: ZS-29-T

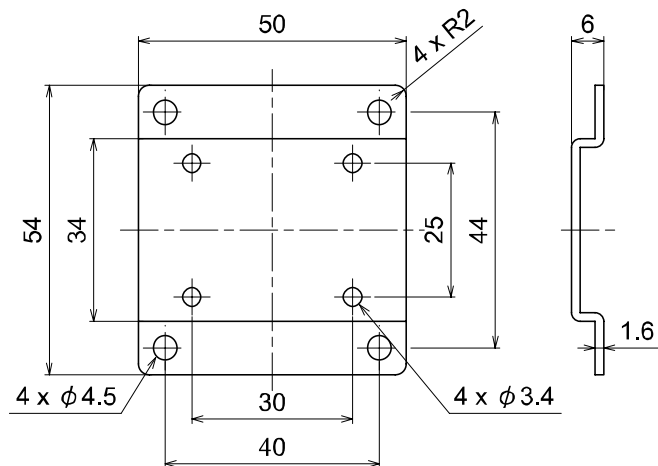

Dimensions of rotating monitor part

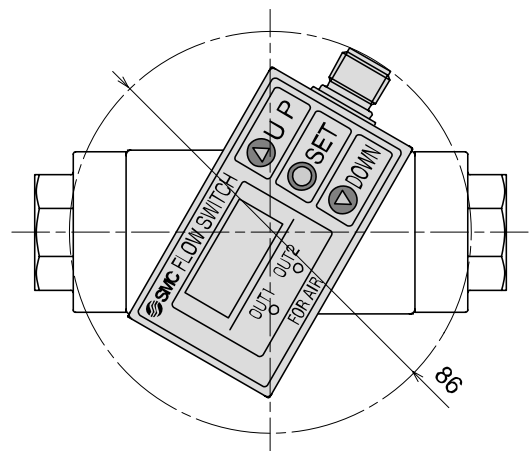

# Made to Order

## ● Model Indication and How to Order

PF2A7  -   -   -  -X560

Integrated display type

Output specification

Symbol	Content
28	NPN (1 output) + Analogue (1 to 5 V)
29	NPN (1 output) + Analogue (4 to 20 mA)
68	PNP (1 output) + Analogue (1 to 5 V)
69	PNP (1 output) + Analogue (4 to 20 mA)

Refer to page 10 for details of model indication and how to order.

## ● Internal circuit and wiring example

When the lead wire with connector designated for PF2A7 is used, the wire colours will apply as shown on the circuit diagram.

### NPN (1 output) + Analogue (1 to 5 V) type

PF2A7--28--X560

### NPN (1 output) + Analogue (4 to 20 mA) type

PF2A7--29--X560

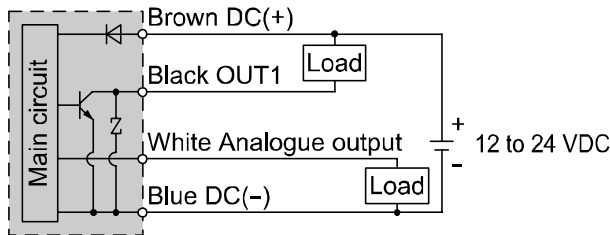

### PNP (1 output) + Analogue (1 to 5 V) type

PF2A7--68--X560

### PNP (1 output) + Analogue (4 to 20 mA) type

PF2A7--69--X560

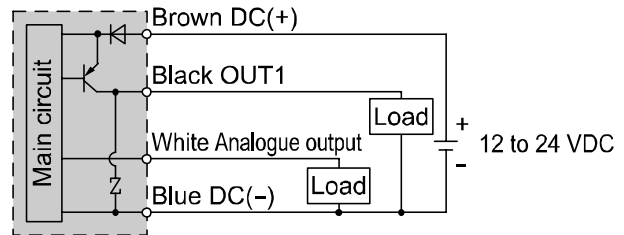

Max. 30 V, 80 mA

Internal voltage drop: 1 V or less

28: Analogue output: 1 to 5 V

Output impedance: 1 kΩ

29: Analogue output: 4 to 20 mA

Load impedance

Power supply voltage 12 V: 300 Ω

Power supply voltage 24 V: 600 Ω

Max. 80 mA

Internal voltage drop: 1.5 V or less

68: Analogue output: 1 to 5 V

Output impedance: 1 kΩ

69: Analogue output: 4 to 20 mA

Load impedance

Power supply voltage 12 V: 300 Ω

Power supply voltage 24 V: 600 Ω

## ● Specifications

Model		PF2A7□□-□□-28□□-X560 PF2A7□□-□□-68□□-X560	PF2A7□□-□□-29□□-X560 PF2A7□□-□□-69□□-X560
Analogue output		Voltage output (1 to 5 V)	Current output (4 to 20 mA)
	Impedance	Output impedance approx. 1 kΩ	Load impedance Power supply voltage 12 V: 300 Ω Power supply voltage 24 V: 600 Ω
	Accuracy	±5%F.S. max.	
	Response time	1 s or less	

\*: Other specifications are equal to standard product.

## ● Analogue output

	A	B
Voltage output	1 V	5 V
Current output	4 mA	20 mA

Model	Rated flow range	
	Min.	Max.
PF2A710	1 NL/min	10 NL/min
	$3.5 \text{ CFM} \times 10^{-2}$	$35.0 \text{ CFM} \times 10^{-2}$
PF2A750	5 NL/min	50 NL/min
	$18 \text{ CFM} \times 10^{-2}$	$176 \text{ CFM} \times 10^{-2}$
PF2A711	10 NL/min	100 NL/min
	$3.5 \text{ CFM} \times 10^{-1}$	$35.5 \text{ CFM} \times 10^{-1}$
PF2A721	20 NL/min	200 NL/min
	$7 \text{ CFM} \times 10^{-1}$	$71 \text{ CFM} \times 10^{-1}$
PF2A751	50 NL/min	500 NL/min
	$18 \text{ CFM} \times 10^{-1}$	$176 \text{ CFM} \times 10^{-1}$

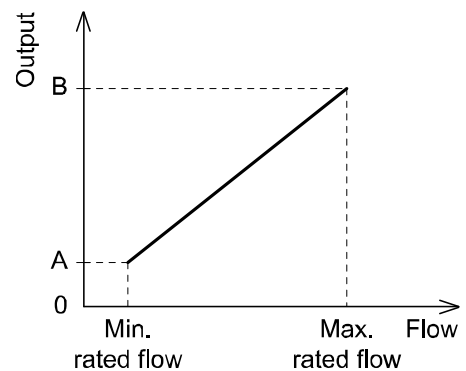

\*: Analogue output is based on the rated flow range at normal condition.

The displayed flow range is based on standard conditions.

Therefore, the range of rated flow and the displayed flow are different.

In analogue output mode, the output value varies depending on the mode (normal condition ↔ standard condition).

Use the formula below when the analogue output is used in standard conditions.

Flow range at normal condition ÷ 0.927 = Flow range at standard condition

Revision history

# SMC Corporation

4-14-1, Sotokanda, Chiyoda-ku, Tokyo 101-0021 JAPAN

Tel: +81 3 5207 8249 Fax: +81 3 5298 5362

URL <http://www.smcworld.com>

---

Note: Specifications are subject to change without prior notice and any obligation on the part of the manufacturer.  
© 2011 SMC Corporation All Rights Reserved

