

Rodless Cylinder for Vacuum

CYV Series

ø15, ø32

Air cylinder for transfer in vacuum environments (1.3×10^{-4} Pa)

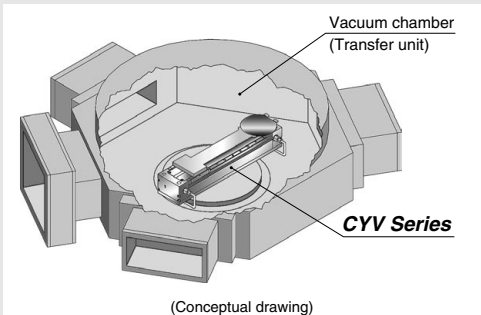

Simplifies and reduces the size of equipment

Since the cylinder can be installed inside a vacuum chamber, it contributes to simplifying and reducing the size of a transfer system.

Note) The illustration above is an example showing how to install the rodless cylinder.
However, it is only an image, and does not satisfy all the required conditions for using a vacuum chamber.

XLA

XL□

XL□Q

XM□

XY□

D-□

XSA

XVD

XGT

CYV

Rodless Cylinder for Vacuum

CYV Series

ø15, ø32

Air cylinder for transfer

Carefully designed for low particulate generation,

Low particulate generation

Average particle generation (particles > 0.1 μ) is 0.1 particles/cycle. (Atmospheric conditions)

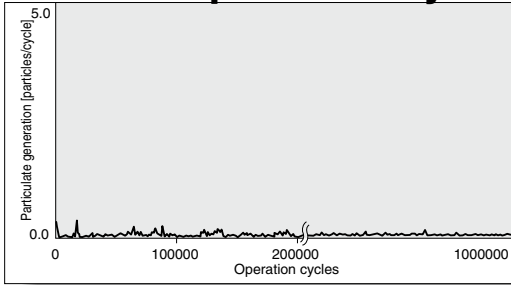

Note 1) This data indicates deterioration with age of the average number of particles per operation under the following test conditions.

<Test conditions>

- Cylinder: CYV32-100
- Workpiece mass: 5 kg
- Average speed: 100 mm/s
- Measurement environment: Operation in the atmosphere after baking at 150°C for 48 hours.

Note 2) This data is considered typical but not guaranteed.

Note 3) A particulate generation test has been conducted in a vacuum environment of 10⁻⁶ Pa.

Low particulate generation

1

Non-contact construction

There is no particulate generation due to friction, since the construction does not allow contact between the cylinder tube's exterior surface and the slide table's internal surface.

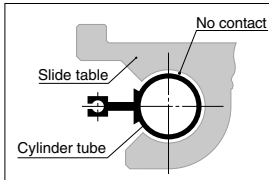

Special cylinder tube Long stroke (Max. 700 mm)

A special cylinder tube using extruded aluminum material is employed. No deflection or contact occurs even for long strokes, since the cylinder is rigidly attached to the base and the slide table is independently supported by a linear guide.

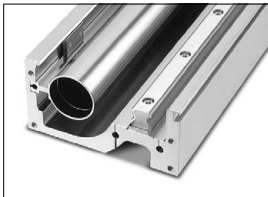

Low particulate generation

2

Stainless steel linear guide &

low particulate generation vacuum grease

Particulate generation from the linear guide unit has been reduced with the use of a stainless steel linear guide and low particulate generating vacuum grease.

Low particulate generation

3

Reduced initial particulate generation

Cleaned, assembled, inspected and first-stage packaged in a clean environment.

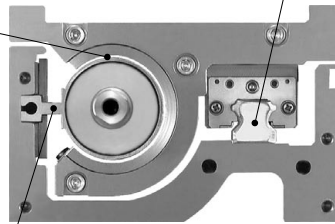

Low particulate generation

4

Low particulate generation at the stroke ends

Particulate generation has been reduced at the stroke ends by reducing impact using a sine cushion and by stopping the stroke using an internal stopper.

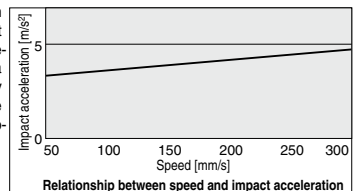

in vacuum environments (1.3×10^{-4} Pa)

low leakage, and low outgassing.

Low leakage

Leakage: 1.3×10^{-7} Pa·m³/sec or less
(at normal temperatures, excluding gas permeation)

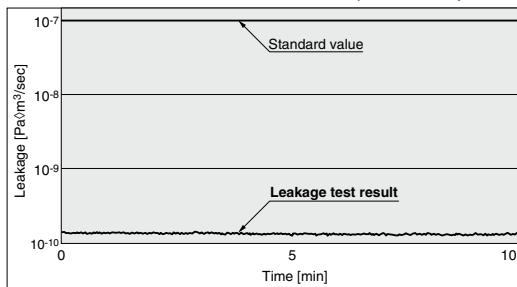

Note 1) The data indicates the leakage measured in a vacuum environment of 10^{-4} Pa.

Note 2) The leakage test result shown is based on a test conducted for 10 minutes after the cylinder was pressurized with helium at 0.1 MPa.

Note 3) This data is considered typical but not guaranteed.

Low leakage
1

Employs a magnetically coupled rodless cylinder with no air leakage from moving parts

Low leakage
2

O-ring seals separate vacuum and atmosphere

Static O-ring seals are used for all the seals between vacuum and atmosphere.

Note 1) The chart above shows the leakage test results based on a test conducted using this cylinder construction.

Note 2) To allow fine stroke adjustments, O-ring seals are installed to separate vacuum and atmosphere. Please consult with SMC if the sealing method needs to be altered.

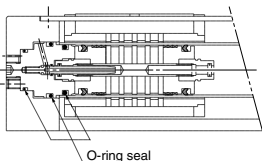

XLA

XL□

XL□Q

XM□

XY□

D-□

XSA

XVD

XGT

CVY

Reduced outgassing

Reduced outgassing
1

Reduction of outgassing due to surface treatment

All the external parts (made of aluminum alloy) such as the body and slide table are electroless nickel plated.

Furthermore, external magnets are coated with titanium nitride.

Note 1) Please consult with SMC if other specifications for surface treatment are required.

Reduced outgassing
2

Resin materials eliminated

Laser marking is employed for the model designation.

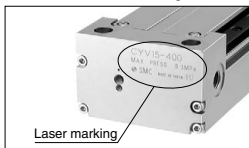

Fine adjustments at the end of the stroke

Fine adjustments between -2 to 0 mm can be made on one side (-4 to 0 mm for both sides).

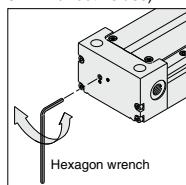

CYV Series Model Selection 1

Caution on Design (1)

The allowable load mass moment differs depending on the workpiece mounting method, cylinder mounting orientation and piston speed. To determine whether or not the cylinder can be operated, do not allow the sum ($\Sigma \alpha_n$) of the load factors (α_n) for each mass and moment to exceed "1".

$$\Sigma \alpha_n = \frac{\text{Load mass (m)}}{\text{Max. load mass (m max)}} + \frac{\text{Static moment (M)}}{\text{Allowable static moment (M max)}} + \frac{\text{Dynamic moment (Me)}}{\text{Allowable dynamic moment (Me max)}} \leq 1$$

Load Mass

Max. load mass (kg)

Model	m max
CYV15	1
CYV32	5

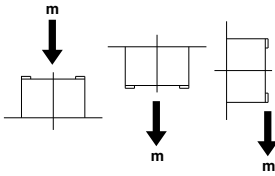

Moment

Allowable moment (Static moment/Dynamic moment)

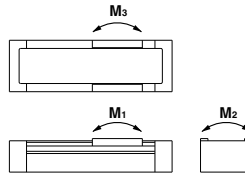

Model	(N·m)		
	M1	M2	M3
CYV15	0.3	0.6	0.3
CYV32	3	4	3

Static Moment

Moment generated by the workpiece weight even when the cylinder is stopped

■ Pitch moment

$$M_1 = m \times g \times (L + B) \times 10^{-3}$$

■ Roll moment

$$M_2 = m \times g \times (L + B) \times 10^{-3}$$

■ Yaw moment

$$M_3 = m \times g \times (L + A) \times 10^{-3}$$

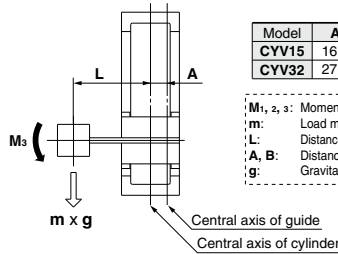
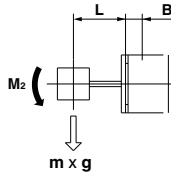
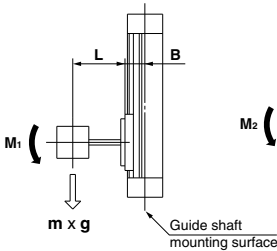

Model	(mm)	
	A	B
CYV15	16.5	25.5
CYV32	27.0	48.0

M_{1, 2, 3}: Moment [N·m]
 m: Load mass [kg]
 L: Distance to load center of gravity [mm]
 A, B: Distance to guide shaft (mm)
 g: Gravitational acceleration [9.8 m/s²]

Dynamic Moment

Moment generated by the load equivalent to impact at the stroke end

$$We = 5 \times 10^{-3} \times m \times g \times U$$

We: Load equivalent to impact [N]
 m: Load mass [kg]

U: Max. speed [mm/s]
 g: Gravitational acceleration [9.8 m/s²]

■ Pitch moment

$$Me_1 = 1/3 \cdot We (L + B) \cdot 10^{-3} *$$

* Average load coefficient

■ Yaw moment

$$Me_3 = 1/3 \cdot We (L + A) \cdot 10^{-3} *$$

* Average load coefficient

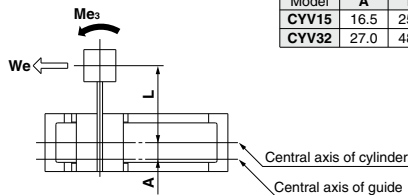
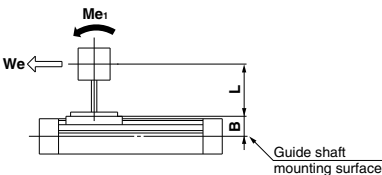

Model	(mm)	
	A	B
CYV15	16.5	25.5
CYV32	27.0	48.0

CYV Series

Model Selection 2

Selection Calculation

The selection calculation finds the load factors (α_n) of the items below, where the total ($\sum \alpha_n$) does not exceed "1".

$$\sum \alpha_n = \alpha_1 + \alpha_2 + \alpha_3 \leq 1$$

Item	Load factor α_n	Note
1 Max. load mass	$\alpha_1 = m/m \text{ max}$	Review m . m max is the maximum load mass.
2 Static moment	$\alpha_2 = M/M \text{ max}$	Review M_1, M_2, M_3 . M max is the allowable moment.
3 Dynamic moment	$\alpha_3 = Me/Me \text{ max}$	Review Me_1, Me_3 . Me max is the allowable moment.

Calculation Example

Operating Conditions

Cylinder: CYV32
 Mounting: Horizontal wall mounting
 Maximum speed: $U = 300$ [mm/s]
 Load mass: $m = 1$ [kg] (excluding mass of the arm section)
 $L_1 = 50$ [mm]
 $L_2 = 50$ [mm]

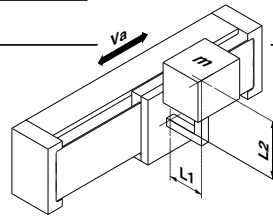

Item	Load factor α_n	Note
1 Maximum load mass 	$\alpha_1 = m/m \text{ max}$ $= 1/5$ $= 0.20$	Review m .
2 Static moment 	$M_2 = m \cdot g \cdot (L_1 + B) \cdot 10^{-3}$ $= 1 \cdot 9.8 \cdot (50 + 48) \cdot 10^{-3}$ $= 0.96$ [N·m] $\alpha_2 = M_2/M_2 \text{ max}$ $= 0.96/4$ $= 0.24$	Review M_2 . Since M_1 and M_3 are not generated, review is unnecessary.
3 Dynamic moment 	$We = 5 \times 10^{-3} \cdot m \cdot g \cdot U$ $= 5 \times 10^{-3} \cdot 1 \cdot 9.8 \cdot 300$ $= 14.7$ [N] $Me_3 = 1/3 \cdot We \cdot (L_2 + A) \cdot 10^{-3}$ $= 1/3 \cdot 14.7 \cdot (50 + 27) \cdot 10^{-3}$ $= 0.38$ [N·m] $\alpha_{3a} = Me_3/Me_3 \text{ max}$ $= 0.38/3$ $= 0.13$ $Me_1 = 1/3 \cdot We \cdot (L_1 + B) \cdot 10^{-3}$ $= 1/3 \cdot 14.7 \cdot (50 + 48) \cdot 10^{-3}$ $= 0.48$ [N·m] $\alpha_{3b} = Me_1/Me_1 \cdot \text{max}$ $= 0.48/3$ $= 0.16$	Review Me_3 . Review Me_1 .

$$\begin{aligned} \sum \alpha_n &= \alpha_1 + \alpha_2 + (\alpha_{3a} + \alpha_{3b}) \\ &= 0.20 + 0.24 + (0.13 + 0.16) \\ &= 0.73 \end{aligned}$$

The result $\sum \alpha_n = 0.73 \leq 1$ allows operation.

XLA

XL

XL Q

XM

XY

D-

XSA

XVD

XGT

CYV

CYV Series Model Selection 3

Caution on Design (2)

Table Deflection Note)

Table deflection due to pitch moment load

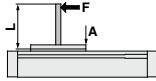

$$M_1 = F \times L$$

Table deflection due to roll moment load

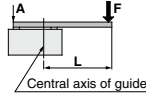

$$M_2 = F \times L$$

Table deflection due to yaw moment load

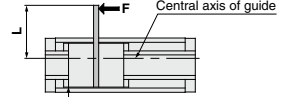

$$M_3 = F \times L$$

Note) Deflection: Displacement of point A when force acts on point F
Point A: Indicates a measurement point

CYV15 (M₁)

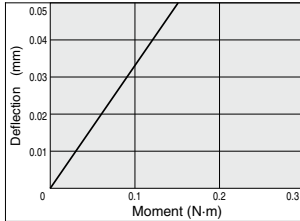

CYV15 (M₂)

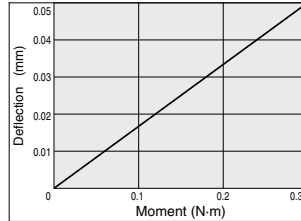

CYV15 (M₃)

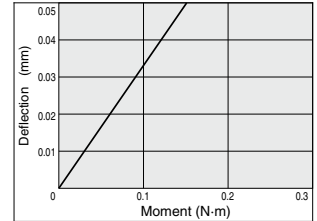

CYV32 (M₁)

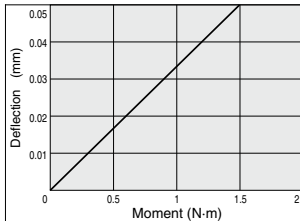

CYV32 (M₂)

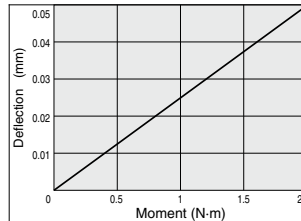

CYV32 (M₃)

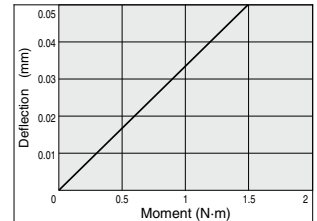

Note) Extend the graph line for the deflection, if a moment other than those given above is applied.

Note) Indicates the displacement (rigidity) on the slide table from the position where the reaction force is generated when the torque is applied to the slide table. (Reference values)
Please contact SMC for the accuracy.

Vertical Operation

When using in vertical operation, prevention of workpiece dropping due to breaking of the magnetic coupling should be considered. The allowable load mass and maximum operating pressure should be as shown in the table below.

Model	Allowable load mass mv (kg)	Maximum operating pressure Pv (MPa)
CYV15	1	0.3
CYV32	5	

Intermediate Stop

The cushion effect (smooth start-up, soft stop) is applied only before the stroke end in the stroke ranges indicated in the table below.

The cushion effect (smooth start-up, soft stop) is not available an intermediate stop or return from an intermediate stop using an external stopper, etc.

When using an intermediate stop with the above information taken into account, implement measures to prevent particulate generation and set the operating pressure to no more than 0.3 MPa.

Cushion Stroke

Model	Stroke (mm)
CYV15	25
CYV32	30

Rodless Cylinder for Vacuum

CYV Series

How to Order



CYV **15** - **200**

Rodless Cylinder for Vacuum

Bore size

15	15 mm
32	32 mm

Standard stroke

Bore size (mm)	Standard stroke (mm)
15, 32	100, 150, 200, 250 300, 350, 400, 450 500, 600, 700

Specifications

Bore size (mm)	15	32
Operating environment pressure	Atmosphere to 1.3×10^{-4} Pa (ABS)	
Operating atmosphere <small>Note 1)</small>	Air/Inert gas	
Fluid <small>Note 1)</small>	Air/Inert gas	
Action	Double acting	
Proof pressure	0.5 MPa	
Operating pressure range	0.05 to 0.3 MPa	
Leakage	1.3×10^{-7} Pa·m ³ /sec or less (at normal temperatures, excluding gas permeation)	
Maximum baking temperature <small>Note 2) Note 3)</small>	100°C	
Ambient and fluid temperature	-10 to 60°C (No freezing)	
Piston speed (MAX.) <small>Note 4)</small>	50 to 300 mm/s	
Stroke adjustment	-2 to 0 mm on each side (-4 to 0 mm total)	
Cushion	Sine cushion (Air cushion)	
Port size	5/16-24 UNF	7/16-20 UNF
Lubrication	Vacuum grease for linear guide unit and inside the cylinder tube	

Note 1) Air is recommended as the operational atmosphere and fluid, but contact SMC if other inert gasses are used, as the product life may change.

Note 2) Baking is limited to baking before cylinder operation. Cylinder operation should be with a temperature range of -10 to 60°C.

Note 3) Contact SMC if the baking temperature will exceed 100°C.

Note 4) The piston speed listed above is the maximum piston speed. When the slide table on the stroke edge starts moving, it will take approximately 0.5 seconds (each end) or 1 second (both ends) to slip out of the cushion stroke.

Weight

Model	Standard stroke (mm)										(kg)	
	100	150	200	250	300	350	400	450	500	600		700
CYV15	1.2	1.4	1.6	1.7	1.9	2.0	2.2	2.4	2.5	2.8	3.2	
CYV32	4.2	4.6	5.0	5.5	5.9	6.3	6.7	7.1	7.5	8.3	9.1	

Magnetic Holding Force

Bore size (mm)	Magnetic holding force (N)
15	59
32	268

Theoretical Output

Bore size (mm)	Piston area (mm ²)	Operating pressure (MPa)		
		0.1	0.2	0.3
15	176	18	35	53
32	804	80	161	241

XLA

XL□

XL□□

XM□

XY□

D-□

XSA

XVD

XGT

CYV

CYV Series

Construction

CYV15

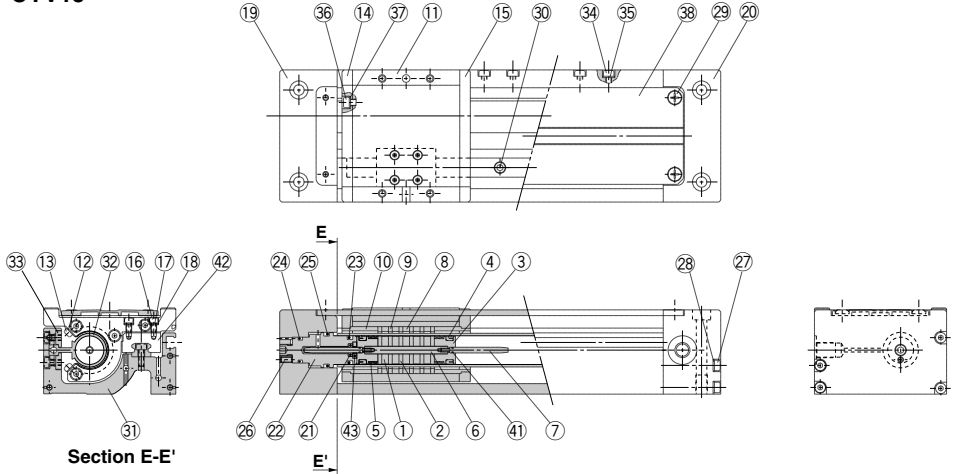

CYV32

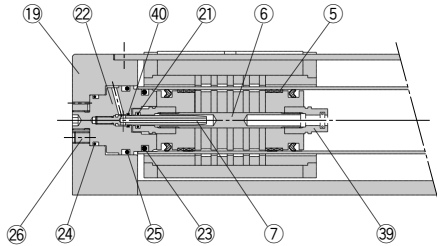

Component Parts

No.	Description	Material	Note
1	Magnet A	—	
2	Piston side yoke	Rolled steel plate	Zinc chromated
3	Piston	Brass/ Aluminum alloy	Electroless nickel plated/Chromated
4	Piston seal	Fluororubber	
5	Wear ring	Special bearing	
6	Shaft	Stainless steel	
7	Cushion ring	Stainless steel/Brass	—/Electroless nickel plated
8	Magnet B	—	Titanium nitride coating
9	External slider side yoke	Rolled steel	Electroless nickel plated
10	Hold spacer	Aluminum alloy	Electroless nickel plated
11	Slide table	Aluminum alloy	Electroless nickel plated
12	Insertion guide plate	Stainless steel	
13	Round head Phillips screw	Stainless steel	
14	Side plate A	Aluminum alloy	Electroless nickel plated
15	Side plate B	Aluminum alloy	Electroless nickel plated
16	Hexagon socket head cap screw	Stainless steel	
17	Spring washer	Stainless steel	
18	Flat washer	Stainless steel	
19	Plate A	Aluminum alloy	Electroless nickel plated
20	Plate B	Aluminum alloy	Electroless nickel plated
21	Cushion seal	Fluororubber	

No.	Description	Material	Note
22	Inner cover	Aluminum alloy	Electroless nickel plated
23	Cylinder tube gasket	Fluororubber	
24	O-ring	Fluororubber	
25	O-ring	Fluororubber	
26	Hexagon socket head set screw	Stainless steel	
27	Hexagon socket head cap screw	Stainless steel	
28	Flat washer	Stainless steel	
29	Round head Phillips screw	Stainless steel	
30	Hexagon socket head cap screw	Stainless steel	
31	Base	Aluminum alloy	Electroless nickel plated
32	Cylinder tube	Aluminum alloy	Electroless nickel plated
33	Tube attaching bracket	Aluminum alloy	Electroless nickel plated
34	Hexagon socket head cap screw	Stainless steel	
35	Flat washer	Stainless steel	
36	Hexagon socket head cap screw	Stainless steel	
37	Flat washer	Stainless steel	
38	Top cover	Aluminum alloy	Electroless nickel plated
39	Cushion seal holder	Aluminum alloy	Chromated
40	O-ring	Fluororubber	
41	O-ring	Fluororubber	
42	Linear guide	Stainless steel	
43	Retaining plate	Aluminum alloy	Hard anodized

Note) In the material and note columns of the Component Parts list above, the first description is for CYV15 and the second description is for CYV32.

Dimensions

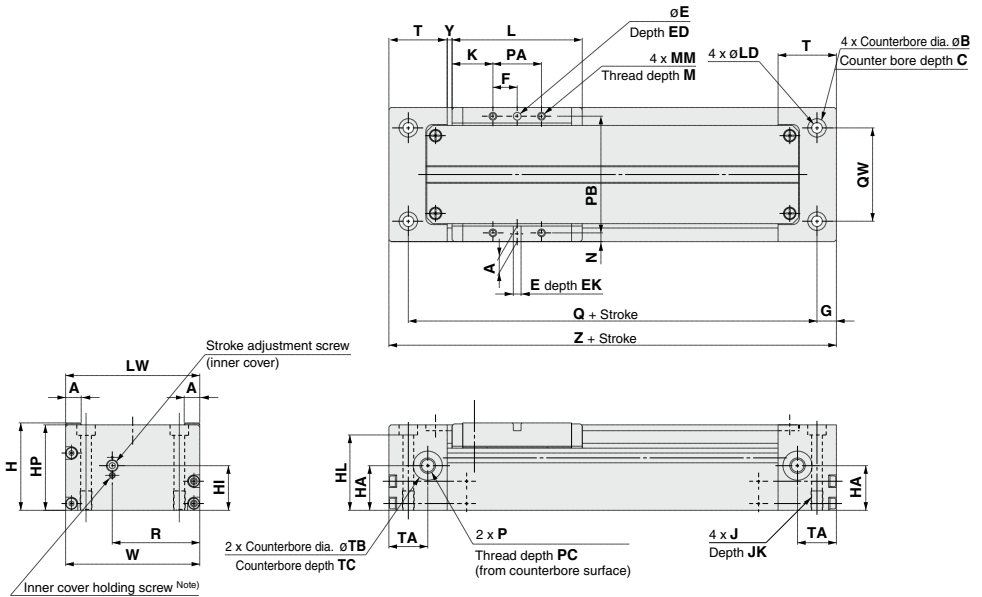

Model	A	B	C	E	ED	EK	F	G	H	HA	HI	HL	HP	J	JK	K	L	LD
CYV15	8	10.5	6.4	$4_{+H9}^{+0.030}$	9.5	4	12.5	10	45	23	23	37.6	44	M6 x 1	10	21	67	5.6
CYV32	12	16	10.2	$6_{+H9}^{+0.030}$	13	6	25	9	75	39	39	63.3	73.5	M10 x 1.5	12	20	90	9.2

Model	LW	MM	M	N	P	PA	PB	PC	Q	QW	R	T	TA	TB	TC	W	Y	Z
CYV15	69	M4 x 0.7	6	4.5	5/16-24 UNF	25	60	10	112	48	45	30	20	15	0.5	69	2.5	132
CYV32	115	M6 x 1	8	7.5	7/16-20 UNF	50	100	12	147	83	79.5	34	22.5	20	0.5	115	3.5	165

Note) Refer to "Cushion Effect (Sine Cushion) and Stroke Adjustment" under Specific Product Precautions on page 545.

XLA

XL□

XL□Q

XM□

XY□

D-□

XSA

XVD

XGT

CYV



CYV Series

Specific Product Precautions 1

Be sure to read this before handling the products.
Refer to back page 50 for Safety Instructions.

Handling

Caution

1. Open the inner package of the double packaged clean series product inside a clean room or other clean environment.
2. Do not install a cylinder with bare hands. Outgassing characteristics can be degraded.
3. Perform parts replacement and disassembly work inside the chamber after exhausting compressed air in the piping to the outside of the clean room.

Mounting

Caution

1. Take care to avoid striking the cylinder tube with other objects or handling it in a way that could cause deformation.

The cylinder tube and slider units have a non-contact construction. For this reason, even a slight deformation or slippage of position can cause malfunction and loss of durability, as well as a danger of degrading particulate generation characteristics.

2. Do not scratch or gouge the linear guide by striking it with other objects.
3. Since the slide table is supported by precision bearings, do not apply strong impacts or excessive moment when mounting workpieces.
The slide table may come into contact with the cylinder tube.
4. The cylinder can be operated by directly applying a load within the allowable range. However, careful alignment is necessary when connecting to a load with an external guide mechanism.

Since displacement of the alignment increases as the stroke becomes longer, consider a connection method that can absorb the displacement and does not cause interference at any point within the stroke. Also, operate with due consideration of measures against particulate generation.

5. Never loosen the bolt holding the linear guide block and slide table.
Otherwise the slide table may come in contact with the cylinder tube.
6. It is recommended that the load center of gravity is set on top of the linear guide.

The linear guide position is offset from the cylinder's central axis, and if the cylinder's central axis becomes the load center of gravity, moment is applied to the cylinder and this will lower the tolerance.

7. Be sure to operate the cylinder with the plates on both sides secured.
Avoid applications in which the slide table or only one plate is secured.
8. Do not use until you verify that the equipment can be operated properly.

After mounting or repair, connect the air supply and electric power, and then confirm proper mounting by performing appropriate function and leakage tests.

Operation

Caution

9. Operation manual

Mount and operate the product after thoroughly reading the manual and understanding its contents. Also, store it where it can be referred at any time.

Operation

Caution

1. The maximum operating pressure for the vacuum rodless cylinder is 0.3 MPa.

If the maximum operating pressure of 0.3 MPa for the vacuum rodless cylinder is exceeded, the magnetic coupling can be broken, causing a danger of malfunction or degradation of particulate generation characteristics, etc.

2. When used for vertical operation, take precautions against possible dropping due to separation of the magnetic coupling.

When used for vertical operation, use caution as there is a possibility of dropping due to separation of the magnetic coupling if a load (pressure) greater than the allowable value is applied.

3. Do not operate with the magnetic coupling out of position.

If the magnetic coupling is out of position, push the external slider (or the piston slider by using air pressure) back to the proper position at the stroke end. (When pushing the external slider, do not push it with bare hands.)

4. Do not apply lubricant, as this is a non-lube product.

The interior of the cylinder is lubricated at the factory, and lubrication with turbine oil, etc., will not satisfy the product's specifications.

5. Contact SMC if greasing the linear guide.

If grease is applied to the linear guide, particle generation will increase temporarily. However, regular greasing is recommended.

6. Use the cylinder in inert gas environments.

Corrosive gases may cause corrosion of a cylinder and loss of durability.

7. Be sure to use the cylinder in pressure environments from atmosphere to 1.3×10^{-4} Pa (ABS).

If used in pressure environments below these conditions, grease applied to the guide unit will evaporate excessively and may cause environmental contamination and loss of durability.

8. Be sure to set the baking temperature (only before the cylinder operates) to 100°C or less.

If a higher temperature is used, the grease will evaporate excessively and may cause environmental contamination and loss of durability.

9. Positioning of a cylinder should be performed using an optical sensor from outside the chamber.

A positioning sensor cannot be mounted on the cylinder.

10. Using extremely dry air as a fluid will affect the reliability (life) of the device, such as deteriorating the lubrication characteristics of the interior, so contact SMC and check.



CYV Series

Specific Product Precautions 2

Be sure to read this before handling the products.
Refer to back page 50 for Safety Instructions.

Fitting

⚠ Caution

1. A fitting with an O-ring is used for a high vacuum rodless cylinder.

Use a fitting that conforms to the dimensions below, and install it so that there is no air leakage.

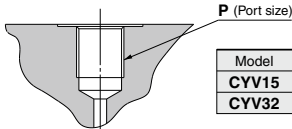

2. Air blow and clean fittings and piping materials completely with clean air to remove oil and impurities, etc., before piping.

Speed Adjustment

⚠ Caution

1. A speed controller for clean room use is recommended for speed adjustment.
2. Install the speed controller outside the chamber.
3. In case of vertical mounting, a system with a regulated supply circuit installed on the down side is recommended. (This is effective against delays at the start of upward movement and for conservation of air.)

Cushion Effect (Sine Cushion) and Stroke Adjustment

⚠ Caution

1. A sine cushion (smooth start-up, soft stop) function is included in the standard specifications.

Due to the nature of a sine cushion, adjustment of the cushion effect is not possible. There is no cushion needle adjustment as in the case of current cushion mechanisms.

2. The stroke adjustment is a mechanism to adapt the slide table's stroke end position to a mechanical stopper on other equipment, etc.

(Adjustment range: Total of both sides -4 to 0 mm)

To ensure safety, perform adjustment after shutting off the drive air, releasing the residual pressure and implementing drop prevention measures, etc.

- 1) Loosen the inner cover holding screw with a hexagon wrench. (When adjusting the stroke, always loosen this holding screw first. If the stroke adjustment screw is turned before the holding screw is loosened, the adjustment screw's hexagonal hole will change shape and stroke adjustment will become impossible)
- 2) By turning the inner cover's stroke adjustment screw with the hexagon wrench, the inner cover is moved back and forth in an axial direction, in order to align it with devices such as mechanical stoppers. (Stroke adjustment screw part's turn direction: left rotation → +stroke/right rotation → -stroke)

Cushion Effect (Sine Cushion) and Stroke Adjustment

⚠ Caution

- 3) The maximum adjustment on one side is -2 to 0 mm. A total adjustment of approximately -4 to 0 mm is possible using both sides.
- 4) After completing the stroke adjustment, tighten the inner cover holding screw with a hexagon wrench, etc.

Inner Cover Holding Screw Tightening Torques [N·m] and Hexagon Wrench

Model	Inner Cover Holding Screw			Stroke adjustment screw	
	Screw size	Tightening torque	Hexagon wrench (nominal)	Hexagon wrench (nominal)	Hexagon wrench (nominal)
CYV15	M3 x 0.5	0.3	1.5	2.5	
CYV32	M6 x 1	2.45	3	4	

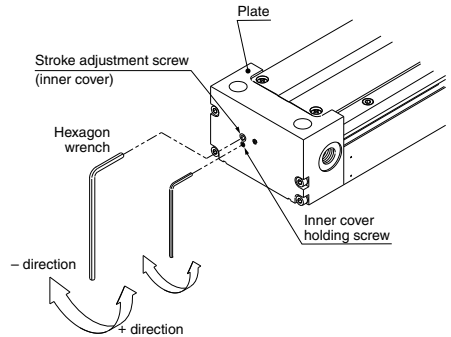

Maintenance

⚠ Caution

1. Never disassemble the cylinder tube or linear guide, etc.

If disassembled, the slide table may touch the outside surface of the cylinder tube resulting in a degradation of particulate generation characteristics.

2. Please consult with SMC when replacing seals and bearings (wear rings).
3. Cylinder maintenance should be performed after an operation of 1 million cycles, or a length of 200 km.

XLA

XL□

XL□Q

XM□

XY□

D-□

XSA

XVD

XGT

CYV



CYV Series

Specific Product Precautions 3

Be sure to read this before handling the products.
Refer to back page 50 for Safety Instructions.

Particulate Generation Characteristics

Caution

1. In order to maintain the particulate generation grade, use operation of 1 million cycles or travel distance of about 200 km as a guide. (Table (1) below)

If operation is continued beyond the recommended values, lubrication failure of the linear guide and a degradation of particulate generation characteristics may occur.

Contact SMC if you intend to perform operation beyond the recommended values.

Table (1)

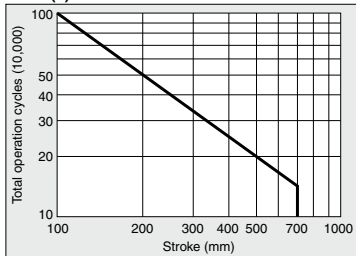

2. Regular greasing is recommended if grease for the linear guide section runs low because of the operating situation.

However, particle generation will increase temporarily in the above case. The increased particle generation will lower gradually if operation continues for a while.