

# Series 10-SQ1000

5 Port Solenoid Valve  
Plug-in Unit



## How to Order Manifold

10-SS5Q13-08 FD2 - D □ - □ - □

• Clean series

• Stations

01	1 station
⋮	⋮
24 <sup>Note 1)</sup>	24 stations

Note 1) The maximum number of stations depends on the type of electrical entries.

• CE-compliant

Nil	—
Q	CE-compliant

• 1(P), 3(R) port size

Nil	1(P), 3(R) port ø8 One-touch fittings
00T	1(P), 3(R) port ø5/16" One-touch fittings

• Option

Nil	None
02 to 24 <sup>Note 1)</sup>	DIN rail length specified
B <sup>Note 2)</sup>	Back pressure check valve
K <sup>Note 3)</sup>	Special wiring specifications (Except double wiring)
N	With name plate (Side ported only)

• Manifold mounting

D	DIN rail mounting
E	Direct mounting

Note 1) Specify DIN rail length with □ at the end. (Enter the number of stations inside □.) The number of stations that may be displayed is longer than the manifold number of stations. Example: -D09

Note 2) When "-B" is selected, a back pressure check valve is included in all stations of the manifold. If the back pressure check valve is used only for the station that need it, then specify the station location in the manifold specification. ("B" is not necessary)

Note 3) Specify "-K" for wiring specification for cases below. (Except L kit)

All single wiring

- Single and double mixed wiring.

- When there are stations which do not require wiring (e.g. individual SUP spacer), specify the wiring specification in the manifold specification so that the number of solenoids is the maximum number of solenoids or less. (Standard wiring specification is double wiring)

Note 4) For specifying two or more options, enter them alphabetically. Example: -BKN

## • Electrical entry

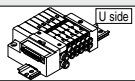
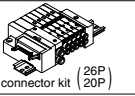
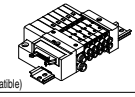
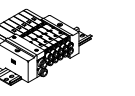
Kit type	Lead wire connector location	Cable/SI unit specifications	Station (Double wiring)	Max. number of solenoids for special wiring specifications <sup>Note 2)</sup>	CE-compliant				
<b>F</b> kit  D-sub connector kit	FD0 FD1 FD2 FD3 D side	D-sub connector (25P) kit, without cable	1 to 12 stations	24	●				
		D-sub connector (25P) kit, with 1.5 m cable							
		D-sub connector (25P) kit, with 3.0 m cable							
		D-sub connector (25P) kit, with 5.0 m cable							
<b>P</b> kit  Flat ribbon cable connector kit (26P 20P)	PD0 PD1 PD2 PD3 PDC D side <sup>Note 1)</sup>	Flat ribbon cable (26P) kit, without cable	1 to 12 stations	24	●				
		Flat ribbon cable (26P) kit, with 1.5 m cable							
		Flat ribbon cable (26P) kit, with 3.0 m cable							
		Flat ribbon cable (26P) kit, with 5.0 m cable							
		Flat ribbon cable (20P) kit, without cable							
<b>J</b> kit  Flat ribbon cable (20P) (PC wiring system compatible)	JD0 D side	Flat ribbon cable (20P) PC wiring system compatible	1 to 8 stations	16	●				
<b>L</b> kit <sup>Note 3)</sup>  Lead wire kit	LD0 (N) D side LU0 (N) U side LD1 (N) D side LU1 (N) U side LD2 (N) D side LU2 (N) U side	Lead wire kit with 0.6 m cable	1 to 12 stations	—	●				
		Lead wire kit with 1.5 m cable							
		Lead wire kit with 3.0 m cable							
	<b>S</b> kit Serial transmission kit EX140 Integrated-type (For Output) Serial Transmission System	SDH SDQ SDR1 SDR2 SDV D side				NKE Corp.: Fieldbus H System DeviceNet™	1 to 8 stations	16	●
						OMRON Corp.: CompoBus/S (16 output points)	1 to 4 stations	8	
						OMRON Corp.: CompoBus/S (8 output points)	1 to 8 stations	16	
CC-Link			1 to 8 stations	16					

Note 1) Separately order the 20P type cable assembly for the P kit.

Note 2) Specify the wiring so that the maximum number of solenoids is not exceeded. (The number of solenoids are counted as: 1 for single solenoids and 2 for type 3P double solenoids.)

Note 3) When specifying the negative common specifications of the L kit, suffix "N" to the kit symbol.

Directional Control Valves

Air Cylinders

Rotary Actuators

Air Grippers

Air Preparation Equipment

Modular F. R.

Pressure Control Equipment

Fittings & Tubing

Flow Control Equipment

Pressure Switches/ Pressure Sensors

**How to Order Valve**



**10-SQ1** **1** **31** **1** **5** **1** **C6** **1** **1** **1**

● Clean series

● CE-compliant

<b>Nil</b>	—
<b>Q</b>	CE-compliant

● Seal

<b>1</b>	Rubber seal
----------	-------------

● Actuation type

<b>1</b>	2 position single (A)4 2(B)  (R1)5 1 3(R2) (P)
<b>2</b>	2 position double (Double solenoid) (Note) (A)4 2(B)  (R1)5 1 3(R2) (P) Rubber seal
<b>3</b>	3 position closed center (A)4 2(B)  (R1)5 1 3(R2) (P)
<b>4</b>	3 position exhaust center (A)4 2(B)  (R1)5 1 3(R2) (P)
<b>5</b>	3 position pressure center (A)4 2(B)  (R1)5 1 3(R2) (P)

Note) For double solenoid specification, the function symbol below is "D".

● Function

Symbol	Specifications
<b>Nil</b>	Standard type (0.4 W)
<b>B</b>	Quick response type (0.95 W)
<b>D</b> (Note 1)	2 position double (Double solenoid specifications)
<b>N</b> (Note 2)	Negative common

Note 1) "D" is specified for 2 position double.

Note 2) For L kit, when the manifold specifies negative common, the valve common should also be negative. The combination of negative common of the valve cannot be specified with S kit (EX140).

Note 3) When two or more symbols are specified, indicate them alphabetically.

● Manifold block

<b>Nil</b>	<b>M</b>	<b>MB</b>
Without manifold block 	With manifold block 	With manifold block, built-in back pressure check valve 
	* Lead wire is not included.	* Lead wire is not included.
<ul style="list-style-type: none"> <li>When ordering with manifolds</li> <li>When only valves are required.</li> </ul>	For adding stations	

● Port plug mounting port

<b>Nil</b>	None
<b>A</b>	Port 4(A)
<b>B</b>	Port 2(B)

● Cylinder port

Symbol	Port size	Port location	
<b>C3</b>	With ø3.2 One-touch fittings	Side ported	
<b>C4</b>	With ø4 One-touch fittings		
<b>C6</b>	With ø6 One-touch fittings		
<b>M5</b>	M5 thread	Top ported (Note)	
<b>L3</b>	With ø3.2 One-touch fittings		
<b>L4</b>	With ø4 One-touch fittings		
<b>L6</b>	With ø6 One-touch fittings		
<b>L5</b>	M5 thread		

Note) Can be changed to side ported configuration.

● Manual override

<b>Nil</b>	<b>B</b>
Non-locking push type (Tool required)	Locking type (Tool required)

● Rated voltage

<b>5</b>	24 VDC
<b>6</b>	12 VDC

Note 1) Light/surge voltage suppressor is built-in.

Note 2) S kit: 24 VDC only

## How to Order Manifold Assembly (Example)

Example) D-sub connector kit, with cable (3 m)

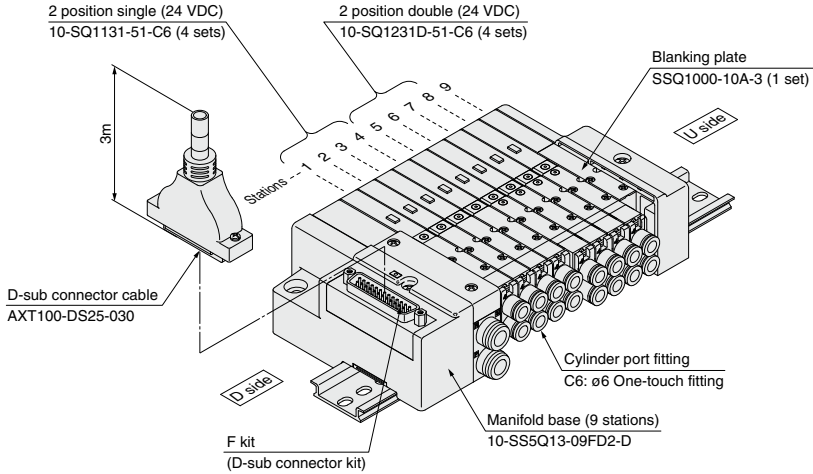

- 10-SS5Q13-09FD2-D ..... 1 set (F kit 9-station manifold base)
- \* 10-SQ1131-51-C6 ..... 4 sets (2 position single)
- \* 10-SQ1231D-51-C6 ..... 4 sets (2 position double)
- \* SSQ1000-10A-3 ..... 1 set (Blanking plate)

→ The asterisk denotes the symbol for assembly. Prefix it to the part no. of the solenoid valve, etc.

Add the valve and option part numbers in order starting from the first station on the D side.  
When entry of part numbers becomes complicated, indicate on the manifold specification sheet.

Directional Control Valves

Air Cylinders

Rotary Actuators

Air Grippers

Air Preparation Equipment

Modular F. R.

Pressure Control Equipment

Fittings & Tubing

Flow Control Equipment

Pressure Switches/ Pressure Sensors

**Model**

Series	Actuation type	Seal	Model	Flow rate characteristics <small>Note 1)</small>						Response time (ms) <small>Note 2)</small>		Weight (g)
				1 → 4/2 (P → A/B)			4 → 5 (A → R1)			Standard (0.4 W)	Quick response (0.95 W)	
				C [dm <sup>3</sup> /(s·bar)]	b	Cv	C [dm <sup>3</sup> /(s·bar)]	b	Cv			
<b>SQ1000</b>	2 position	Single	<b>10-SQ1131</b>	0.79	0.20	0.19	0.80	0.20	0.19	24 or less	15 or less	80
		Double	<b>10-SQ1231D</b>	0.79	0.20	0.19	0.80	0.20	0.19	20 or less	15 or less	95
	3 position	Closed center	<b>10-SQ1331</b>	0.64	0.20	0.15	0.58	0.26	0.16	39 or less	25 or less	100
		Exhaust center	<b>10-SQ1431</b>	0.64	0.20	0.15	0.80	0.20	0.19	39 or less	25 or less	100
		Pressure center	<b>10-SQ1531</b>	0.79	0.21	0.19	0.59	0.20	0.14	39 or less	25 or less	100

Note 1) Values for the cylinder port size of C6, CYL → Values of EXH. Flow rate characteristics of 2 → 3 (B → R2) declines about 30% of 4 → 5 (A → R1).  
 Note 2) Based on JIS B 8375-1981. (Values with a supply pressure of 0.5 MPa and light/surge voltage suppressor. Values fluctuate depending on the pressure and air quality.)

**Specifications**



<b>Valve specifications</b>	<b>Valve construction</b>	Rubber seal		
	<b>Fluid</b>	Air		
	<b>Maximum operating pressure</b>	0.7 MPa		
	<b>Min. operating pressure</b>	<b>Single</b>	0.15 MPa	
		<b>Double (Double solenoid)</b>	0.1 MPa	
		<b>3 position</b>	0.2 MPa	
	<b>Ambient and fluid temp.</b>	-10 to 50°C <small>Note 1)</small>		
	<b>Lubrication</b>	Not required		
	<b>Pilot valve manual override</b>	Push type/Locking type (Tool required)		
	<b>Vibration/Impact resistance</b> <small>Note 2)</small>	30/150 m/s <sup>2</sup>		
<b>Protection structure</b>	Dust tight			
<b>Solenoid specifications</b>	<b>Coil rated voltage</b>	12 VDC, 24 VDC		
	<b>Allowable voltage fluctuation</b>	±10% of rated voltage		
	<b>Coil insulation type</b>	Equivalent to class B		
	<b>Power consumption (Current)</b>	<b>24 VDC</b>	0.4 W DC (17 mA), 0.95 W DC (40 mA) <small>Note 3)</small>	
	<b>12 VDC</b>	0.4 W DC (34 mA), 0.95 W DC (80 mA) <small>Note 3)</small>		

Note 1) Use dry air to prevent condensation when operating at low temperatures.  
 Note 2) Vibration resistance: No malfunction occurred in a one-sweep test between 45 and 2000 Hz. Test was performed in both energized and de-energized states in the axial direction and at right angles to the main valve and armature. (Default settings)  
 Impact resistance: No malfunction occurred when it was tested with a drop tester in the axial direction and at right angles to the main valve and armature in both energized and deenergized states once for each condition.  
 Note 3) Value for quick response type

**Symbol**

2 position single (A)4 2(B)  (R1)5 13(R2) (P)	2 position double (Double solenoid) (A)4 2(B)  (R1)5 13(R2) (P)	3 position closed center (A)4 2(B)  (R1)5 13(R2) (P)	3 position exhaust center (A)4 2(B)  (R1)5 13(R2) (P)	3 position pressure center (A)4 2(B)  (R1)5 13(R2) (P)
---	---	--	---	--

**Manifold Specifications**

Base model	Piping specifications			Applicable solenoid valve	Connection type	Applicable stations <small>Note 3)</small>	5 station weight (g) <small>Note 4)</small>	1 station weight (g) <small>Note 4)</small>		
	Port size <small>Note 1)</small>									
	P, R	A, B								
<b>10-SSQ13-□□□</b>	C8 (For ø8)	Side	C3 (For ø3.2)	<b>10-SQ1□31</b>	F kit: D-sub connector	1 to 12 stations	420	20		
			C4 (For ø4)			C6 (For ø6)	26P	1 to 12 stations	420	20
	Top <small>Note 2)</small>	L3 (For ø3.2)	L4 (For ø4)		L6 (For ø6)	L5 (M5 thread)	J kit: Flat ribbon cable PC wiring system compatible	1 to 9 stations	420	20
								1 to 8 stations	420	20
					L kit: Lead wire	1 to 12 stations	460	35		
					S kit: Serial transmission	1 to 8 stations	475	20		

Note 1) One-touch fittings in inch sizes are also available.  
 Note 2) Can be changed to side ported configuration.  
 Note 3) An optional specification for special wiring is available to increase the maximum number of stations.  
 Note 4) Except valves.

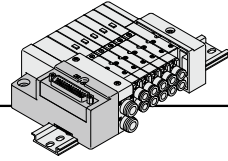

**F** Kit (D-sub connector)

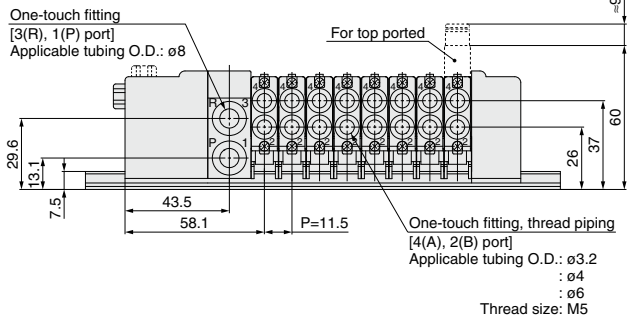
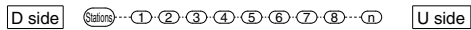
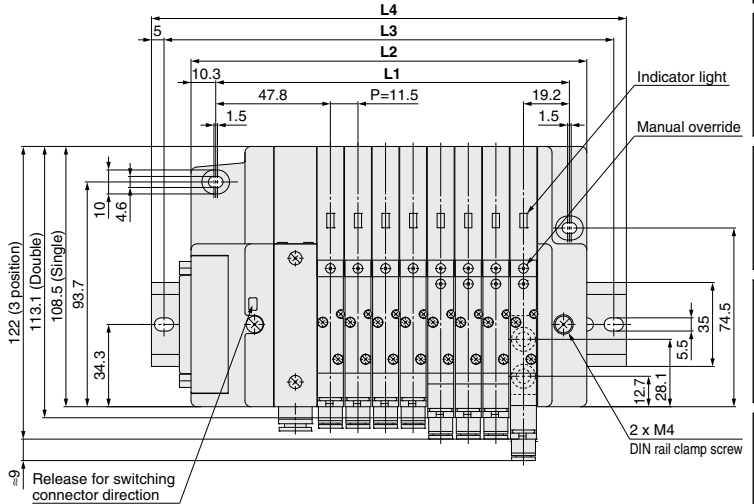
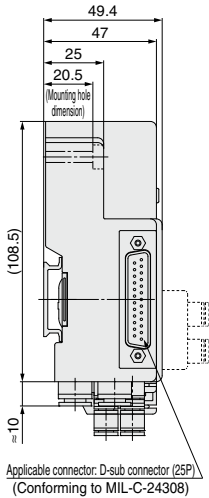

**Dimensions**

Formula L1 = 11.5n + 55.5 L2 = 11.5n + 73 n: Stations (Max. 24 stations)

L	n	1	2	3	4	5	6	7	8	9	10	11	12	13	14	15	16	17	18	19	20	21	22	23	24
L1		67	78.5	90	101.5	113	124.5	136	147.5	159	170.5	182	193.5	205	216.5	228	239.5	251	262.5	274	285.5	297	308.5	320	331.5
L2		84.5	96	107.5	119	130.5	142	153.5	165	176.5	188	199.5	211	222.5	234	245.5	257	268.5	280	291.5	303	314.5	326	337.5	349
L3		112.5	125	137.5	150	162.5	175	187.5	200	212.5	225	237.5	250	262.5	275	287.5	300	300	312.5	325	337.5	350	362.5	375	
L4		123	135.5	148	160.5	173	185.5	198	210.5	223	235.5	248	260.5	273	285.5	298	310.5	310.5	323	335.5	348	360.5	373	385.5	

Directional Control Valves

Air Cylinders

Rotary Actuators

Air Grippers

Air Preparation Equipment

Modular F. R.

Pressure Control Equipment

Fittings & Tubing

Flow Control Equipment

Pressure Switches/Pressure Sensors

**P** Kit (Flat ribbon cable connector)

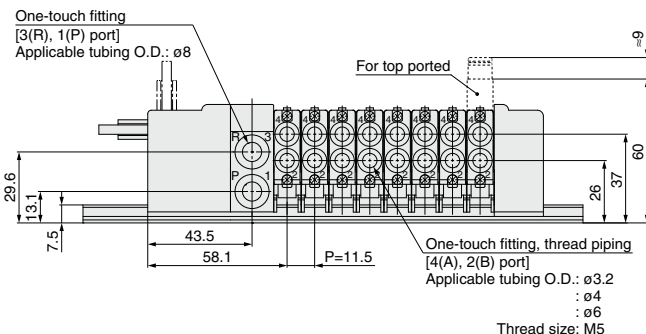
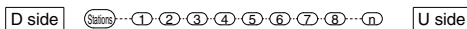
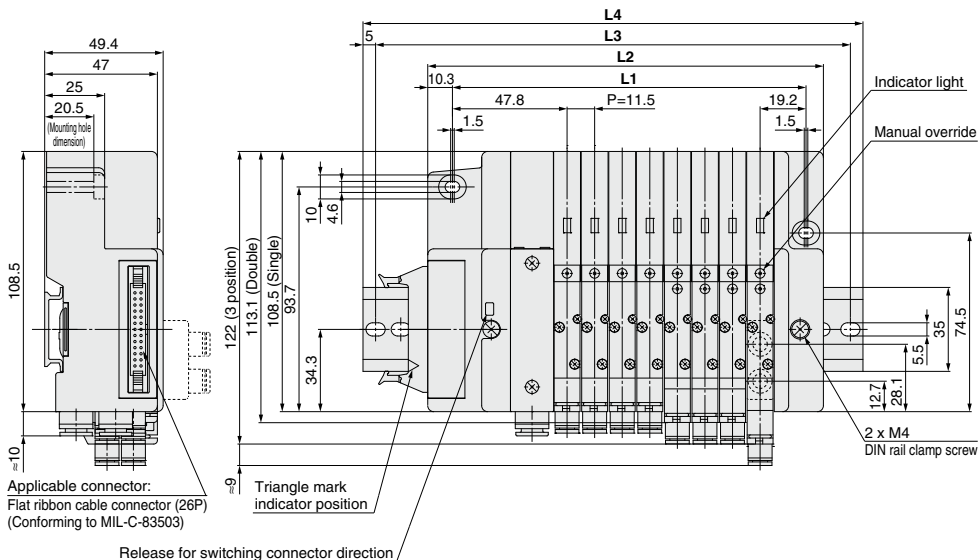
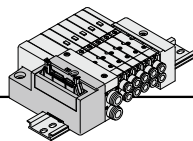

**Dimensions**

Formula  $L1 = 11.5n + 55.5$   $L2 = 11.5n + 73$   $n$ : Stations (Max. 24 stations)

L	n	1	2	3	4	5	6	7	8	9	10	11	12	13	14	15	16	17	18	19	20	21	22	23	24
<b>L1</b>		67	78.5	90	101.5	113	124.5	136	147.5	159	170.5	182	193.5	205	216.5	228	239.5	251	262.5	274	285.5	297	308.5	320	331.5
<b>L2</b>		84.5	96	107.5	119	130.5	142	153.5	165	176.5	188	199.5	211	222.5	234	245.5	257	268.5	280	291.5	303	314.5	326	337.5	349
<b>L3</b>		112.5	125	137.5	150	162.5	175	187.5	200	212.5	225	237.5	250	262.5	275	287.5	300	300	312.5	325	337.5	350	362.5	375	
<b>L4</b>		123	135.5	148	160.5	173	185.5	198	210.5	223	235.5	248	260.5	273	285.5	298	310.5	310.5	323	335.5	348	360.5	373	385.5	

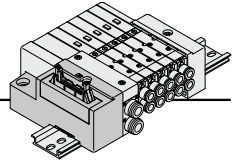

**J**

**Kit (PC wiring system compatible flat ribbon cable)**

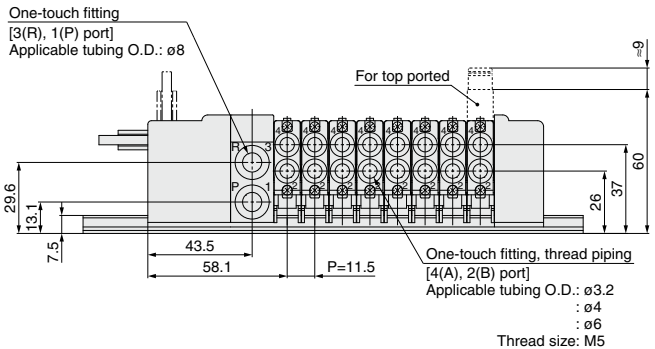
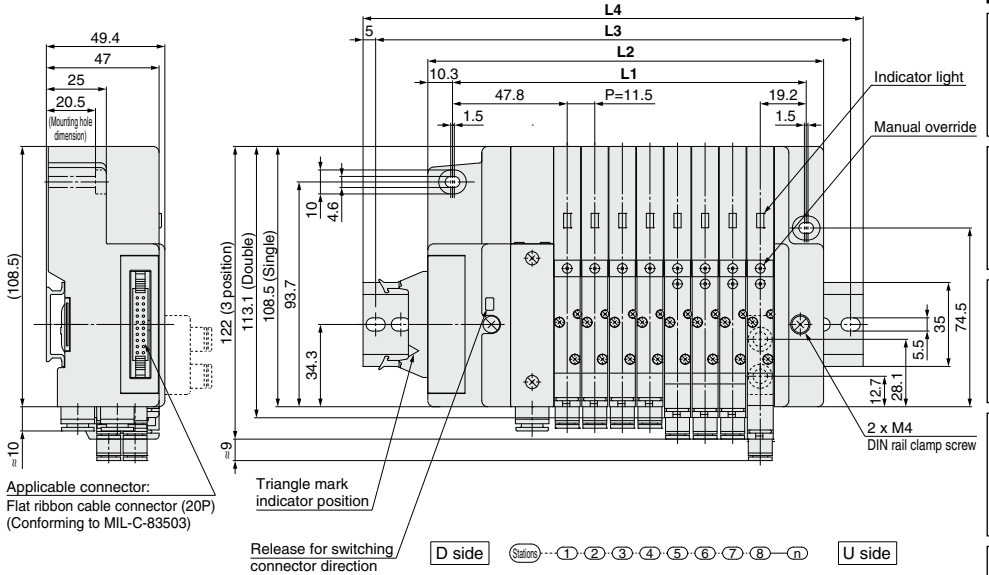

**Dimensions**

Formula L1 = 11.5n + 55.5 L2 = 11.5n + 73 n: Stations (Max. 16 stations)

L	n	1	2	3	4	5	6	7	8	9	10	11	12	13	14	15	16
L1	67	78.5	90	101.5	113	124.5	136	147.5	159	170.5	182	193.5	205	216.5	228	239.5	
L2	84.5	96	107.5	119	130.5	142	153.5	165	176.5	188	199.5	211	222.5	234	245.5	257	
L3	112.5	125	137.5	150	162.5	175	187.5	200	212.5	225	237.5	250	262.5	275	287.5		
L4	123	135.5	148	160.5	173	185.5	198	210.5	223	235.5	248	260.5	273	285.5	298		

Directional Control Valves  
Air Cylinders  
Rotary Actuators  
Air Grippers  
Air Preparation Equipment  
Modular F. R.  
Pressure Control Equipment  
Fittings & Tubing  
Flow Control Equipment  
Pressure Switches/ Pressure Sensors

**L** Kit (Lead wire cable)

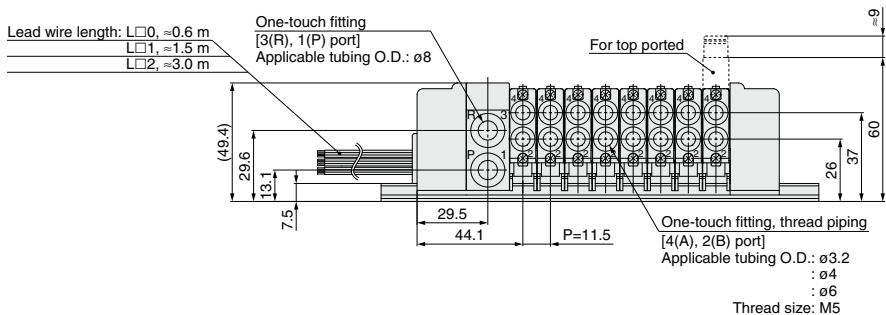
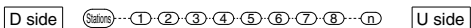
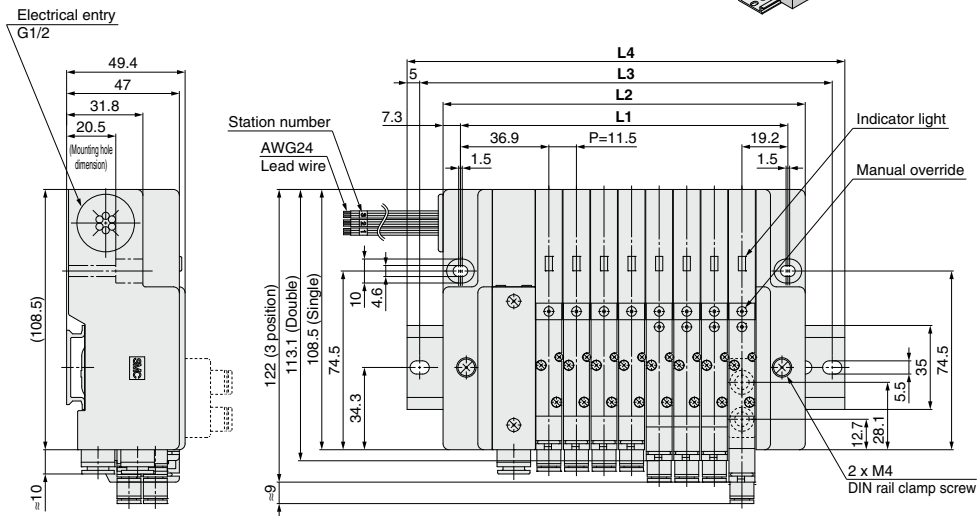
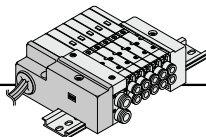

**Dimensions** Formula L1 = 11.5n + 44.5 L2 = 11.5n + 59 n: Stations (Max. 12 stations)

L	n	1	2	3	4	5	6	7	8	9	10	11	12
L1	n	56	67.5	79	90.5	102	113.5	125	136.5	148	159.5	171	182.5
L2	n	70.5	82	93.5	105	116.5	128	139.5	151	162.5	174	185.5	197
L3	n	100	112.5	125	125	137.5	150	162.5	175	187.5	200	212.5	225
L4	n	110.5	123	135.5	135.5	148	160.5	173	185.5	198	210.5	223	235.5



**S** Kit (Serial transmission unit)

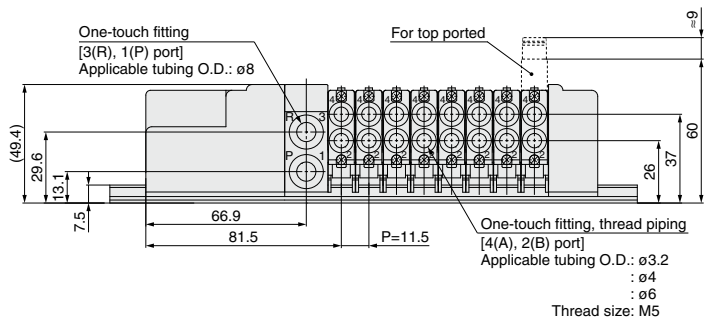
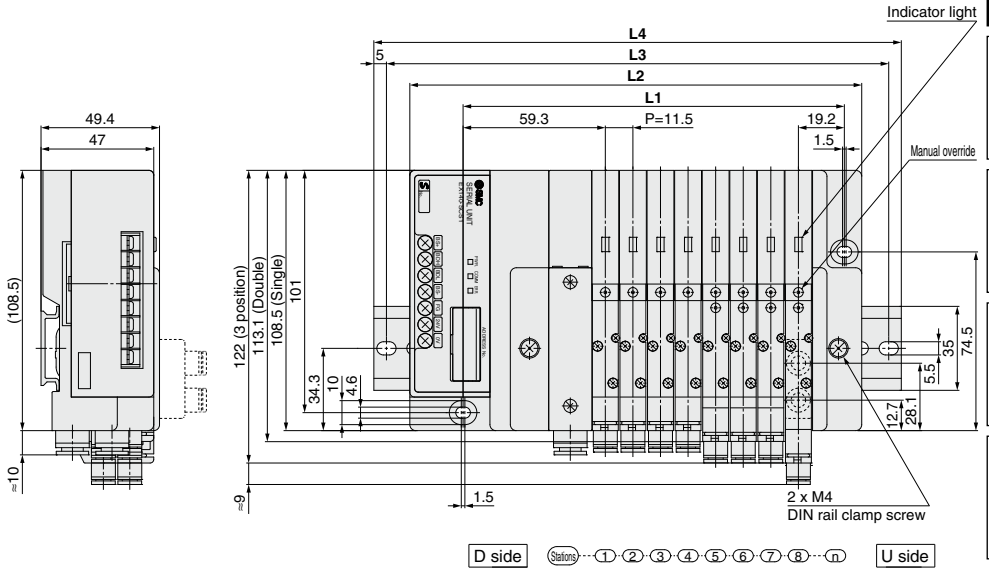
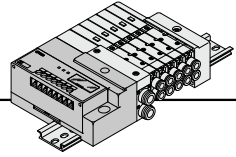

**Dimensions**

Formula L1 = 11.5n + 67    L2 = 11.5n + 96.5    n: Stations (Max. 16 stations)

L \ n	1	2	3	4	5	6	7	8	9	10	11	12	13	14	15	16
<b>L1</b>	78.5	90	101.5	113	124.5	136	147.5	159	170.5	182	193.5	205	216.5	228	239.5	251
<b>L2</b>	108	119.5	131	142.5	154	165.5	177	188.5	200	211.5	223	234.5	246	257.5	269	280.5
<b>L3</b>	137.5	150	162.5	175	187.5	200	212.5	225	237.5	250	262.5	275	287.5	300	300	
<b>L4</b>	148	160.5	173	185.5	198	210.5	223	235.5	248	260.5	273	285.5	298	310.5	310.5	

- Directional Control Valves
- Air Cylinders
- Rotary Actuators
- Air Grippers
- Air Preparation Equipment
- Modular F. R.
- Pressure Control Equipment
- Fittings & Tubing
- Flow Control Equipment
- Pressure Switches/ Pressure Sensors

# Series 10-SQ2000

5 Port Solenoid Valve  
Plug-in Unit



## How to Order Manifold

10-SS5Q23-08 FD2-D □ - □ - □

• Clean series

• Stations •

01	1 station
⋮	⋮
16 (Note)	16 stations

(Note) The maximum number of stations depends on the type of electrical entries.

• Manifold mounting •

D	DIN rail mounting
E	Direct mounting

• CE-compliant

Nil	—
Q	CE-compliant

• 1(P), 3(R) port size

Nil	1(P), 3(R) port ø10 One-touch fittings
00T	1(P), 3(R) port ø3/8" One-touch fittings

• Option

Nil	None
02 to 16 (Note 1)	DIN rail length specified
B (Note 2)	Back pressure check valve
K (Note 3)	Special wiring specifications (Except double wiring)
N	With name plate (Side ported only)

Note 1) Specify DIN rail length with □ at the end. (Enter the number of stations inside □.)  
The number of stations that may be displayed is longer than the manifold number of stations.  
Example: -D09

Note 2) When "B" is selected, a back pressure check valve is included in all stations of the manifold.  
If the back pressure check valve is used only for the station that need it, then specify the station location in the manifold specification. ("B" is not necessary)

Note 3) Specify "K" for wiring specification for cases below. (Except L kit)

- All single wiring

- Single and double mixed wiring.

- When there are stations which do not require wiring (e.g. individual SUP spacer),

specify the wiring specification in the manifold specification so that the number of solenoids is the maximum number of solenoids or less. (Standard wiring specification is double wiring)

Note 4) For specifying two or more options, enter them alphabetically. Example: -BKN

• Electrical entry

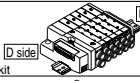
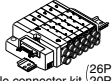
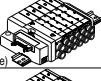
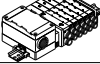
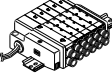
Kit type	Lead wire connector location	Cable/SI unit specifications	Station (Double wiring)	Max. number of stations for special wiring specifications	Max. number of solenoids for special wiring specifications (Note 2)	CE-compliant			
<b>F</b> kit  D-sub connector kit	FD0 FD1 FD2 FD3	D side	D-sub connector (25P) kit, without cable	1 to 12 stations	16 stations	●			
		D side	D-sub connector (25P) kit, with 1.5 m cable						
		D side	D-sub connector (25P) kit, with 3.0 m cable						
		D side	D-sub connector (25P) kit, with 5.0 m cable						
<b>P</b> kit  Flat ribbon cable connector kit (26P)	PD0 PD1 PD2 PD3 PDC	D side	Flat ribbon cable (26P) kit, without cable	1 to 12 stations	16 stations	●			
		D side (Note 1)	Flat ribbon cable (26P) kit, with 1.5 m cable						
		D side	Flat ribbon cable (26P) kit, with 3.0 m cable						
		D side	Flat ribbon cable (26P) kit, with 5.0 m cable						
		D side	Flat ribbon cable (20P) kit, without cable				1 to 9 stations	18	
<b>J</b> kit  Flat ribbon cable (20P) (PC Wiring System compatible)	JD0	D side	Flat ribbon cable (20P) PC wiring system compatible	1 to 8 stations	16 stations	16	●		
<b>T</b> kit  Terminal block box kit	TD0	D side	Terminal block box kit	1 to 10 stations	16 stations	20	●		
<b>L</b> kit Note 3)  Lead wire kit	LD0 (N)	D side	Lead wire kit with 0.6 m cable	1 to 12 stations	—	●			
	LU0 (N)	U side							
	LD1 (N)	D side							
	LU1 (N)	U side							
	LD2 (N)	D side							
	LU2 (N)	U side							
<b>S</b> kit Serial transmission kit EX140 Integrated-type (For Output) Serial Transmission System	SDH	D side	NKE Corp.: Fieldbus H System	1 to 8 stations	16 stations	—			
	SDQ	D side	DeviceNet™						
	SDR1	D side	OMRON Corp.: CompoBus/S (16 outputs)						
	SDR2	D side	OMRON Corp.: CompoBus/S (8 outputs)				1 to 4 stations	8 stations	8
	SDV	D side	CC-Link				1 to 8 stations	16 stations	16

Note 1) Separately order the 20P type cable assembly for the P kit.

Note 2) Specify the number of the solenoid so that the maximum station number is not exceeded. (The number of solenoids are counted as: 1 for single solenoids and 2 for type 3P double solenoids.)

Note 3) When specifying the negative common specifications of the L kit, suffix "N" to the kit symbol. For details, refer to the **WEB catalog**.

**How to Order Valve**



**10-SQ2** **1** **3** **1** **-** **5** **-** **1** **-** **C6** **-** **-** **-** **-**

• Clean series

• Seal

1	Rubber seal
---	-------------

• CE-compliant

Nil	—
Q	CE-compliant

• Actuation type

1	2 position single (A)4 2(B)  (R)1 5 1 3 (R)2 (P)
2	2 position double (Double solenoid) Note (A)4 2(B)  (R)1 5 1 3 (R)2 (P) Rubber seal
3	3 position closed center (A)4 2(B)  (R)1 5 1 3 (R)2 (P)
4	3 position exhaust center (A)4 2(B)  (R)1 5 1 3 (R)2 (P)
5	3 position pressure center (A)4 2(B)  (R)1 5 1 3 (R)2 (P)

Note) For double solenoid specification, the function symbol below is "D".

• Function

Symbol	Specifications
Nil	Standard type (0.4 W)
B	Quick response type (0.95 W)
D Note 1)	2 position double (Double solenoid specifications)
N Note 2)	Negative common

Note 1) "D" is specified for 2 position double.  
 Note 2) For L kit, when the manifold specifies negative common, the valve common should also be negative.  
 The combination of negative common of the valve cannot be specified with S kit (EX140).  
 Note 3) When two or more symbols are specified, indicate them alphabetically.

• Manifold block

Nil	M	MB
Without manifold block	With manifold block	With manifold block, built-in back pressure check valve
	* Lead wire is not included.	* Lead wire is not included.
• When ordering with manifolds • When only valves are required.	For adding stations	

• Port plug mounting port

Nil	None
A	Port 4(A)
B	Port 2(B)

• Cylinder port

Symbol	Port size	Port location	
C4	With ø4 One-touch fittings	Side ported	
C6	With ø6 One-touch fittings		
C8	With ø8 One-touch fittings	Top ported	
L4	With ø4 One-touch fittings		
L6	With ø6 One-touch fittings		
L8	With ø8 One-touch fittings		

Note) Can be changed to side ported configuration.

• Manual override

Nil	B	D
Non-locking push type (Tool required)	Locking type (Tool required)	Slide locking type (Manual type) * Only side ported applicable

• Rated voltage

5	24 VDC
6	12 VDC

Note 1) Light/surge voltage suppressor is built-in.  
 Note 2) S kit: 24 VDC only

Directional Control Valves

Air Cylinders

Rotary Actuators

Air Grippers

Air Preparation Equipment

Modular F. R.

Pressure Control Equipment

Fittings & Tubing

Flow Control Equipment

Pressure Switches/ Pressure Sensors

## How to Order Manifold Assembly (Example)

Example) D-sub connector kit, with cable (3 m)

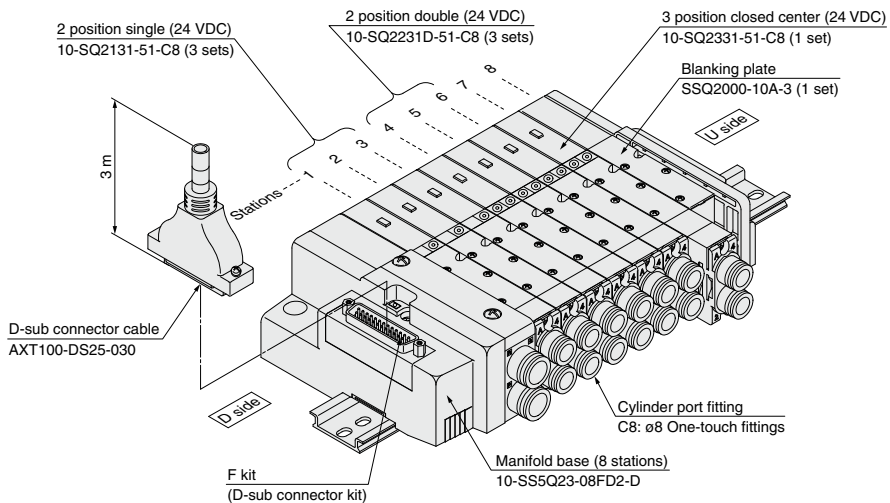

**10-SS5Q23-08FD2-D ... 1 set (F kit 8-station manifold base)**

**\* 10-SQ2131-51-C8 ..... 3 sets (2 position single)**

**\* 10-SQ2231D-51-C8 ... 3 sets (2 position double)**

**\* 10-SQ2331-51-C8 ..... 1 set (3 position closed center)**

**\* SSQ2000-10A-3 ..... 1 set (Blanking plate)**

↳ The asterisk denotes the symbol for assembly. Prefix it to the part no. of the solenoid valve, etc.

Add the valve and option part numbers in order starting from the first station on the D side.  
When entry of part numbers becomes complicated, indicate on the manifold specification sheet.

**Model**

Series	Actuation type	Seal	Model	Flow rate characteristics Note 1)						Response time (ms) Note 2)		Weight (g)	
				1→4/2 (P→A/B)			4/2→5/3 (A/B→R1/R2)			Standard (0.4 W)	Quick response (0.95 W)		
				C [dm³/(s·bar)]	b	Cv	C [dm³/(s·bar)]	b	Cv				
<b>SQ2000</b>	3 position 2 position	Single	Rubber seal	<b>10-SQ2131</b>	2.3	0.17	0.51	3.1	0.18	0.71	31 or less	24 or less	140
		Double	Rubber seal	<b>10-SQ2231D</b>	2.3	0.17	0.51	3.1	0.18	0.71	26 or less	20 or less	155
	3 position	Closed center	Rubber seal	<b>10-SQ2331</b>	1.9	0.17	0.46	1.8	0.29	0.47	44 or less	34 or less	175
		Exhaust center	Rubber seal	<b>10-SQ2431</b>	1.9	0.17	0.46	3.1	0.14	0.65	44 or less	34 or less	175
		Pressure center	Rubber seal	<b>10-SQ2531</b>	2.5	0.17	0.56	1.8	0.30	0.47	44 or less	34 or less	175

Note 1) Values for the top ported cylinder port size of C8. CYL → Values of EXH. The side ported type will be about 10% less.  
 Note 2) Based on JIS B 8375-1981. (Values with a supply pressure of 0.5 MPa and light/surge voltage suppressor. Values fluctuate depending on the pressure and air quality.)

**Specifications**



<b>Valve specifications</b>	<b>Valve construction</b>	Rubber seal	
	<b>Fluid</b>	Air	
	<b>Maximum operating pressure</b>	0.7 MPa	
	<b>Min. operating pressure</b>	Single	0.15 MPa
		Double (Double solenoid)	0.1 MPa
		3 position	0.2 MPa
	<b>Ambient fluid temperature</b>	-10 to 50°C Note 1)	
	<b>Lubrication</b>	Not required	
	<b>Pilot valve manual override</b>	Push type (Tool required)/Locking type (Tool required)/Slide locking type (Manual)	
	<b>Vibration/Impact resistance</b> Note 2)	30/150 m/s²	
<b>Protection structure</b>	Dust tight		
<b>Solenoid specifications</b>	<b>Coil rated voltage</b>	12 VDC, 24 VDC	
	<b>Allowable voltage fluctuation</b>	±10% of rated voltage	
	<b>Coil insulation type</b>	Equivalent to class B	
	<b>Power consumption (Current)</b>	24 VDC	0.4 W DC (17 mA), 0.95 W DC (40 mA) Note 3)
		12 VDC	0.4 W DC (34 mA), 0.95 W DC (80 mA) Note 3)

Note 1) Use dry air to prevent condensation when operating at low temperatures.  
 Note 2) Vibration resistance: No malfunction occurred in a one-sweep test between 45 and 2000 Hz. Test was performed in both energized and de-energized states in the axial direction and at right angles to the main valve and armature. (Default settings)  
 Impact resistance: No malfunction occurred when it was tested with a drop tester in the axial direction and at right angles to the main valve and armature in both energized and de-energized states once for each condition.  
 Note 3) Value for quick response type.

**Symbol**

2 position single (A)4 2(B)  (R1)5 1 3(R2) (P)	2 position double (Double solenoid) (A)4 2(B)  (R1)5 1 3(R2) (P)	3 position closed center (A)4 2(B)  (R1)5 1 3(R2) (P)	3 position exhaust center (A)4 2(B)  (R1)5 1 3(R2) (P)	3 position pressure center (A)4 2(B)  (R1)5 1 3(R2) (P)
--	--	---	--	---

**Manifold Specifications**

Base model	Piping specifications		Applicable solenoid valve	Connection type	Applicable stations Note 3)	5 stations weight (g) Note 4)	1 station weight (g) Note 4)
	Port size Note 1)						
	P, R	A, B					
<b>Series 10-SQ2000</b>	Side	C4 (For ø4) C6 (For ø6) C8 (For ø8)	10-SQ2□31	F kit: D-sub connector	1 to 12 stations	580	35
		C10 (For ø10)		Note 2) Top	P kit: Flat ribbon cable	26P	1 to 12 stations
20P	1 to 9 stations						
J kit: Flat ribbon cable PC wiring system compatible	1 to 8 stations				580	35	
<b>10-SS5Q23-□□□</b>	Side	C4 (For ø4) C6 (For ø6) C8 (For ø8)	10-SQ2□31	L Kit: Lead wire	1 to 12 stations	620	50
				S Kit: Serial transmission	1 to 8 stations	650	35

Note 1) One-touch fittings in inch sizes are also available.  
 Note 2) Can be changed to side ported configuration.  
 Note 3) An optional configuration for special wiring is available to increase the maximum number of stations.  
 Note 4) Except valves.

Directional Control Valves

Air Cylinders

Rotary Actuators

Air Grippers

Air Preparation Equipment

Modular F. R.

Pressure Control Equipment

Fittings & Tubing

Flow Control Equipment

Pressure Switches/Pressure Sensors

**F** Kit (D-sub connector)

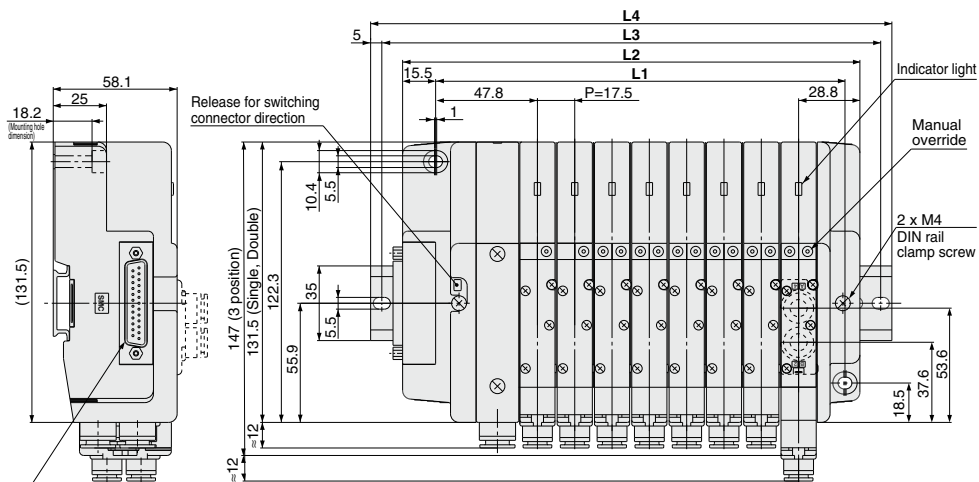
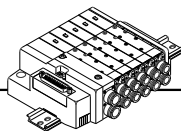

Applicable connector: D-sub connector (25P)  
(Conforming to MIL-C-24308)

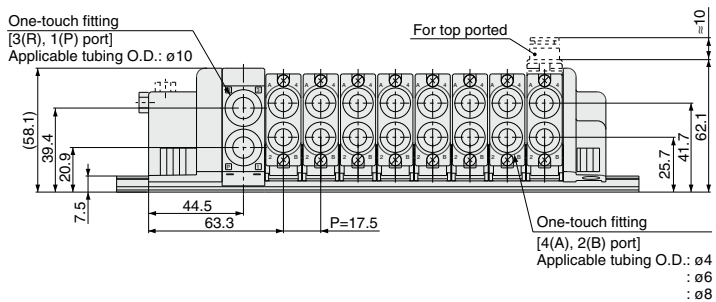
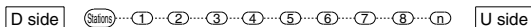

**Dimensions**

Formula: L1 = 17.5n + 52, L2 = 17.5n + 74.5 n: Stations (Max. 16 stations)

L	n	1	2	3	4	5	6	7	8	9	10	11	12	13	14	15	16
L1		69.5	87	104.5	122	139.5	157	174.5	192	209.5	227	244.5	262	279.5	297	314.5	332
L2		92	109.5	127	144.5	162	179.5	197	214.5	232	249.5	267	284.5	302	319.5	337	354.5
L3		112.5	137.5	150	175	187.5	200	225	237.5	262.5	275	287.5	312.5	325	350	362.5	375
L4		123	148	160.5	185.5	198	210.5	235.5	248	273	285.5	298	323	335.5	360.5	373	385.5

**P** Kit (Flat ribbon cable)

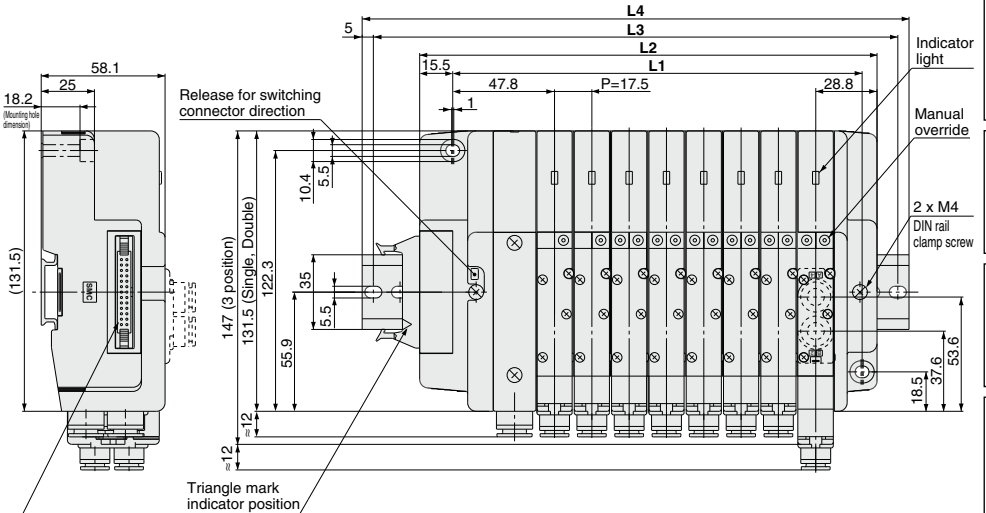
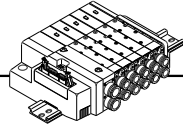

Applicable connector:  
Flat ribbon cable connector (26P)  
(Conforming to MIL-C-83503)

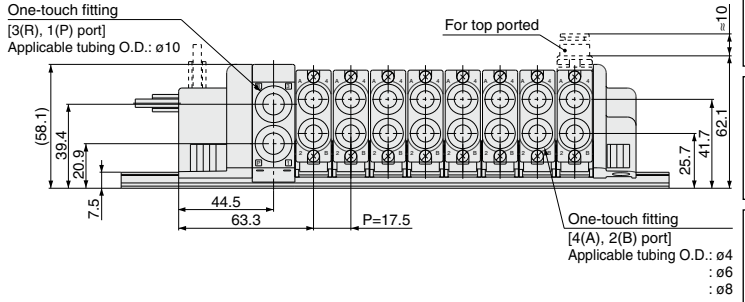
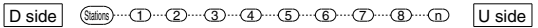

**Dimensions**

Formula:  $L1 = 17.5n + 52$ ,  $L2 = 17.5n + 74.5$ ; Stations (Max. 16 stations)

L \ n	1	2	3	4	5	6	7	8	9	10	11	12	13	14	15	16
<b>L1</b>	69.5	87	104.5	122	139.5	157	174.5	192	209.5	227	244.5	262	279.5	297	314.5	332
<b>L2</b>	92	109.5	127	144.5	162	179.5	197	214.5	232	249.5	267	284.5	302	319.5	337	354.5
<b>L3</b>	112.5	137.5	150	175	187.5	200	225	237.5	262.5	275	287.5	312.5	325	350	362.5	375
<b>L4</b>	123	148	160.5	185.5	198	210.5	235.5	248	273	285.5	298	323	335.5	360.5	373	385.5

- Directional Control Valves
- Air Cylinders
- Rotary Actuators
- Air Grippers
- Air Preparation Equipment
- Modular F. R.
- Pressure Control Equipment
- Fittings & Tubing
- Flow Control Equipment
- Pressure Switches/Pressure Sensors

**J** Kit (PC wiring system compatible flat ribbon cable)

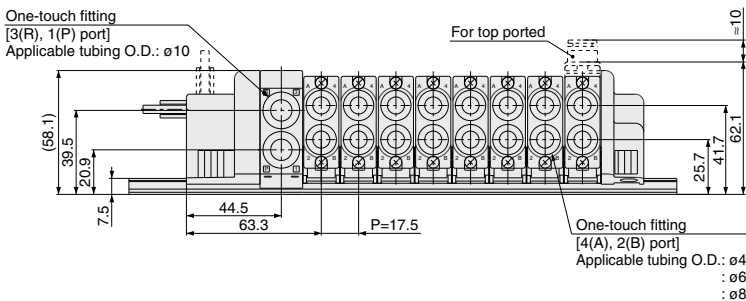
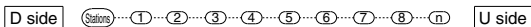
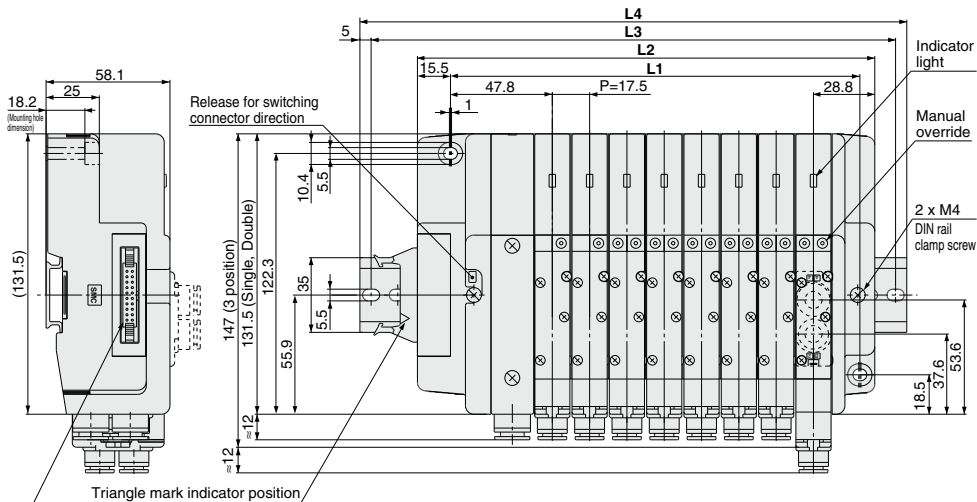
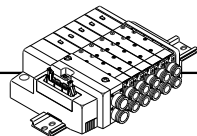

**Dimensions**

Formula:  $L1 = 17.5n + 52$ ,  $L2 = 17.5n + 74.5$  n: Stations (Max. 16 stations)

L	n	1	2	3	4	5	6	7	8	9	10	11	12	13	14	15	16
L1		69.5	87	104.5	122	139.5	157	174.5	192	209.5	227	244.5	262	279.5	297	314.5	332
L2		92	109.5	127	144.5	162	179.5	197	214.5	232	249.5	267	284.5	302	319.5	337	354.5
L3		112.5	137.5	150	175	187.5	200	225	237.5	262.5	275	287.5	312.5	325	350	362.5	375
L4		123	148	160.5	185.5	198	210.5	235.5	248	273	285.5	298	323	335.5	360.5	373	385.5



**T** Kit (Terminal block box)

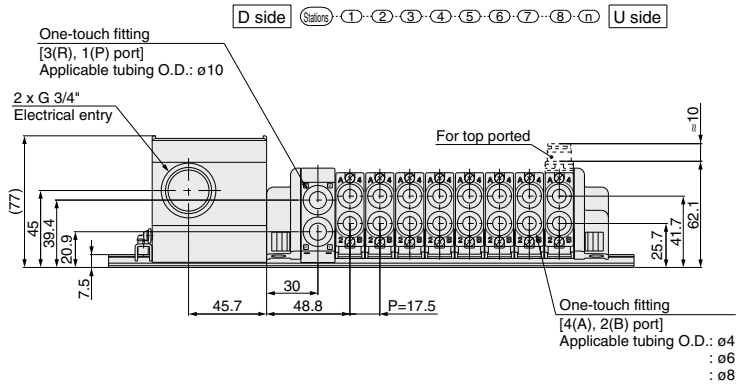
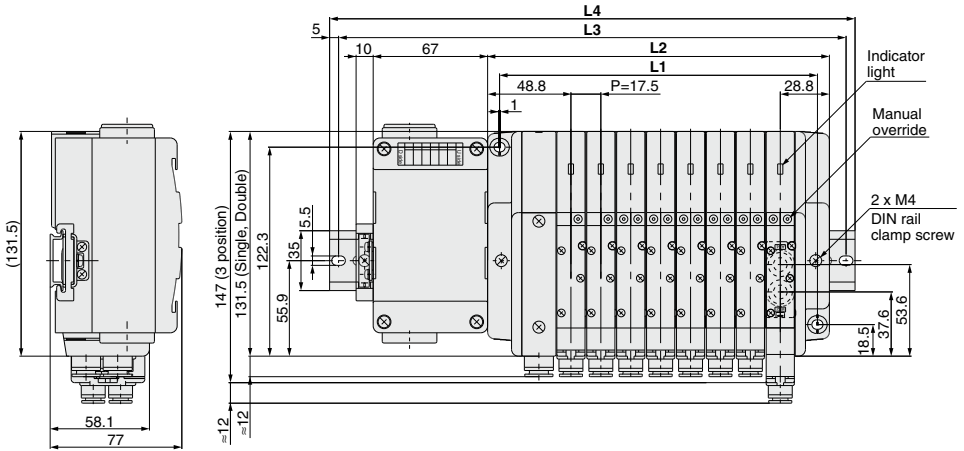
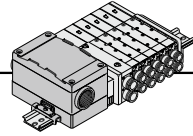

**Dimensions**

Formula:  $L1 = 17.5n + 46$ ,  $L2 = 17.5n + 60$  n: Stations (Maximum 16 stations)

L	n	1	2	3	4	5	6	7	8	9	10	11	12	13	14	15	16
L1		63.5	81	98.5	116	133.5	151	168.5	186	203.5	221	238.5	256	273.5	291	308.5	326
L2		77.5	95	112.5	130	147.5	165	182.5	200	217.5	235	252.5	270	287.5	305	322.5	340
L3		175	200	212.5	237.5	250	262.5	287.5	300	325	337.5	350	375	387.5	412.5	425	437.5
L4	DIN rail mounting	185.5	210.5	223	248	260.5	273	298	310.5	335.5	348	360.5	385.5	398	423	435.5	448
	Direct mounting	160.5	173.0	198.0	210.5	235.5	248.0	260.5	285.5	298.0	323.0	335.5	348.0	373.0	385.5	410.5	423.0

Directional Control Valves

Air Cylinders

Rotary Actuators

Air Grippers

Air Preparation Equipment

Modular F. R.

Pressure Control Equipment

Fittings & Tubing

Flow Control Equipment

Pressure Switches/Pressure Sensors

**L** Kit (Lead wire)

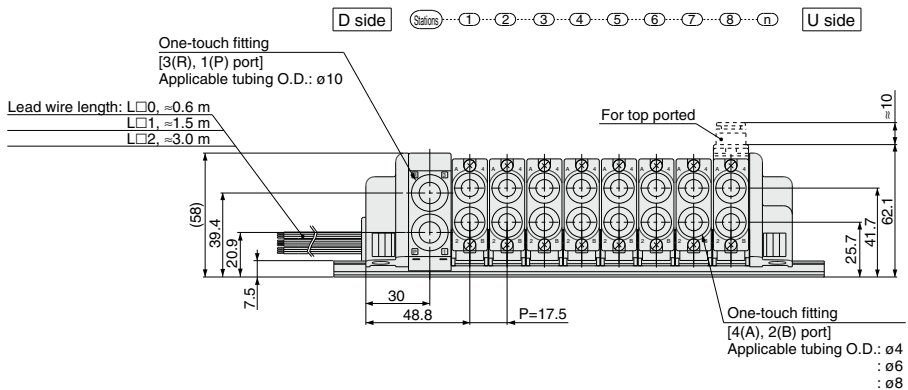
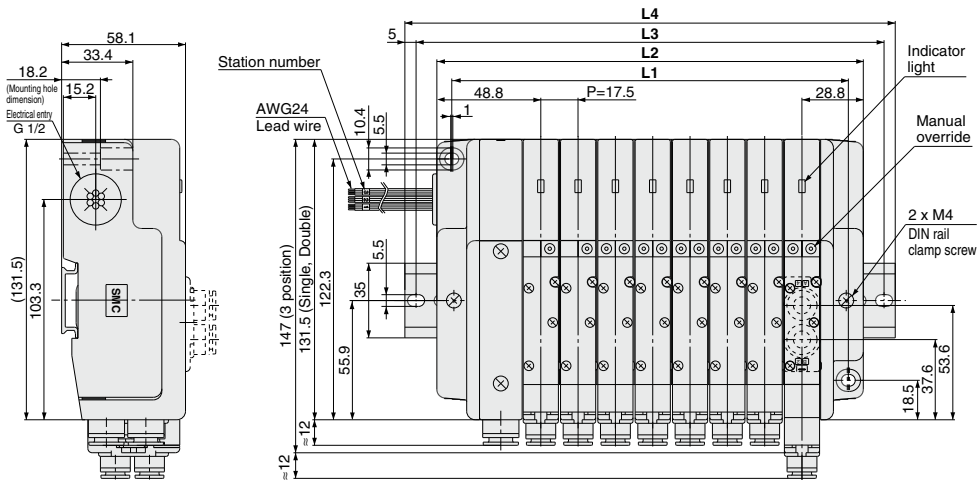
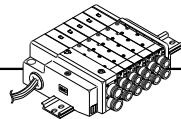

**Dimensions** Formula: L1 = 17.5n + 46, L2 = 17.5n + 60 n: Stations (Max. 12 stations)

L \ n	1	2	3	4	5	6	7	8	9	10	11	12
L1	63.5	81	98.5	116	133.5	151	168.5	186	203.5	221	238.5	256
L2	77.5	95	112.5	130	147.5	165	182.5	200	217.5	235	252.5	270
L3	100	125	137.5	150	175	187.5	212.5	225	237.5	262.5	275	300
L4	110.5	135.5	148	160.5	185.5	198	223	235.5	248	273	285.5	310.5

**S** Kit (Serial transmission)

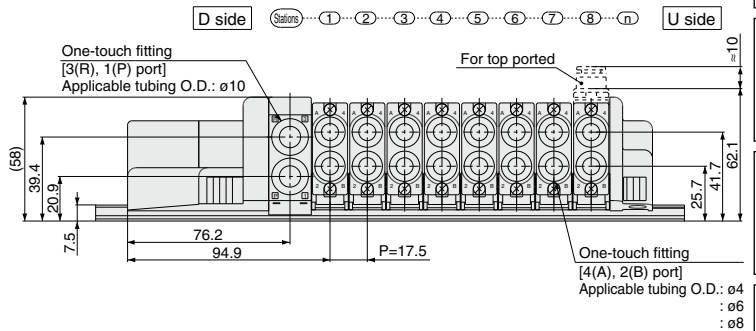
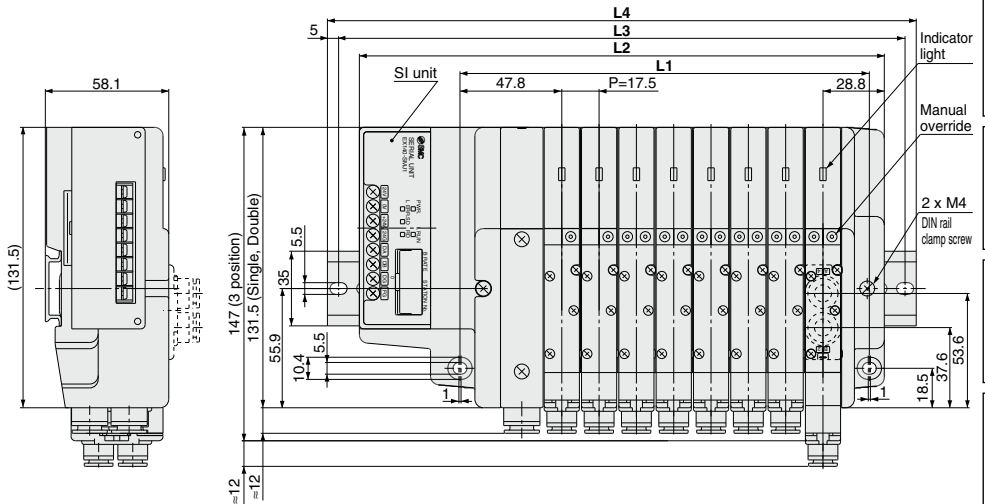
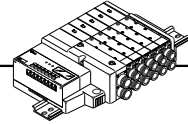

**Dimensions**

Formula:  $L1 = 17.5n + 52$ ,  $L2 = 17.5n + 106$  n: Stations (Max. 16 stations)

n	1	2	3	4	5	6	7	8	9	10	11	12	13	14	15	16
<b>L1</b>	69.5	87	104.5	122	139.5	157	174.5	192	209.5	227	244.5	262	279.5	297	314.5	332
<b>L2</b>	123.5	141	158.5	176	193.5	211	228.5	246	263.5	281	298.5	316	333.5	351	368.5	386
<b>L3</b>	150	162.5	187.5	200	225	237.5	250	275	287.5	312.5	325	337.5	362.5	375	400	412.5
<b>L4</b>	160.5	173	198	210.5	235.5	248	260.5	285.5	298	323	335.5	348	373	385.5	410.5	423

- Directional Control Valves
- Air Cylinders
- Rotary Actuators
- Air Grippers
- Air Preparation Equipment
- Modular F. R.
- Pressure Control Equipment
- Fittings & Tubing
- Flow Control Equipment
- Pressure Switches/ Pressure Sensors