

Plug-in Connector Connecting Base

D-sub Connector

Type 10
Side Ported

25A-JSY1000/3000 Series



Internal Pilot

How to Order Manifolds

25A-JJ5SY **3** - **10** **F** **1** - **05** **D** **□** - **C6** **□**

①
②
③
④
⑤
⑥
⑦
⑧
⑨

Series compatible with secondary batteries

1 Series

1	JSY1000
3	JSY3000

2 Type

10	Side ported
----	-------------

3 Connector type

F: D-sub connector
Connector entry direction adjustable

<IP40>
(25 pins)

4 Connector entry direction

1: Upward	2: Lateral
-----------	------------

5 Valve stations

F: D-sub connector (25 pins)

Symbol	Stations	Note
02	2 stations	Double wiring*1
⋮	⋮	
12	12 stations	
02	2 stations	Specified layout*2 (Up to 16 solenoids available)
⋮	⋮	
16	16 stations	

*1 Double wiring: 2-position single, 2-position double, 3-position, and 4-position valves can be used on all manifold stations. The use of a 2-position single solenoid will result in an unused control signal. If this is not desired, order with a specified layout.

*2 Specified layout: Indicate the wiring specifications on the manifold specification sheet. (Note that 2-position double, 3-position, and 4-position valves cannot be used where single wiring has been specified.)

* This also includes the number of blanking plates.

6 P, E port entry

U	U side (2 to 10 stations)
D	D side (2 to 10 stations)
B	Both sides (2 to 16 stations)

7 SUP/EXH block assembly

Nil	Internal pilot
S	Internal pilot, Built-in silencer

* The 3/5(E) port is plugged for the built-in silencer type.

8 A, B port size (Metric/One-touch fitting)

Symbol	A, B port	JSY1000	JSY3000
C4	Straight	ø4	●
		ø6	●
		ø8	—
		CM*1	●
CM*1	Straight port, mixed sizes	●	●
		—	—
P, E port size (One-touch fittings)		ø8	ø10

*1 Indicate the sizes on the manifold specification sheet for "CM."

* The JSY1000 manifold pitch for C4 is 6.5 mm, and 9 mm for C6. When CM is selected, the manifold pitch is different depending on the selected fitting.

9 Mounting and Option

Symbol	Mounting
Nil	Direct mounting
D□	DIN rail mounting

DIN Rail Option

Symbol	Mounting
Nil	DIN rail mounting (With DIN rail)
0	DIN rail mounting (Without DIN rail)
3	For 3 stations
⋮	⋮
16	For 16 stations

* Enter the number of stations inside □ when it is larger than the number of valve stations. (Refer to "DIN Rail Option" shown above.)

* Refer to the **Web Catalog** for details on securing the DIN rail mounting type manifold.

* The 25A-series specifications and dimensions are the same as those of the standard model.

For details, refer to the **Web Catalog**.

How to Order Manifold Assembly

Example (25A-JJ5SY3-10F1-□)

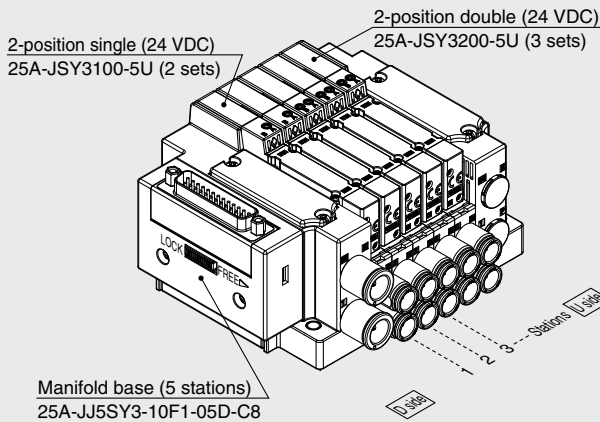

25A-JJ5SY3-10F1-05D-C8 ...1 set (Type 10 5-station manifold base part no.)
 * 25A-JSY3100-5U2 sets (2-position single part no.)
 * 25A-JSY3200-5U3 sets (2-position double part no.)

→ The asterisk denotes the symbol for the assembly.
 Prefix it to the part numbers of the valve, etc.

- For the valve arrangement, the valve closest to the D side is considered the 1st station.
- Under the manifold part number, state the valves to be mounted in order starting with the 1st station as shown in the figure. If the arrangement becomes too complicated, specify the details on a manifold specification sheet.

Internal Pilot

How to Order Valves (With mounting screw)

Refer to the **Web Catalog** for valve specifications.

25A-JSY1000 Series

25A-JSY 1 1 0 0 T-5 Z □

25A-JSY3000 Series

25A-JSY 3 1 0 0 -5 Z □

Series compatible with secondary batteries

With power-saving circuit



Made to Order

Specification

With power-saving circuit (Continuous duty type):
 0.1 W (JSY3000)

Base mounted

1 Series

1	JSY1000
3	JSY3000

3 Pilot valve exhaust method

0	Pilot valve individual exhaust
---	--------------------------------

4 Rated voltage

5	24 VDC
---	--------

2 Type of actuation

1	2-position	Single
2		Double
3	3-position	Closed center
4		Exhaust center
5		Pressure center
A	4-position dual 3-port	N.C./N.C.
B		N.O./N.O.
C		N.C./N.O.

5 Light/surge voltage suppressor and common specification

Symbol	With light	Surge voltage suppressor	Common specification
U	●	●	Non-polar
Z			Positive common
NZ			Negative common

- * Only "Z" and "NZ" types are available for the JSY1000 series.
- * When the non-polar common specification type is selected, take measures to prevent surge voltage. For details, refer to the **Web Catalog**.

6 Manual override

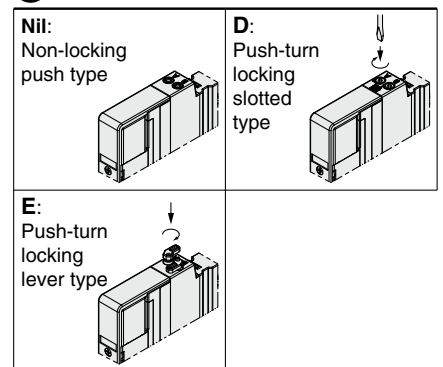

* Push-turn locking lever type "E" is not available for the JSY1000.

- * **When ordering a valve individually, the base gasket is not included.** Since the base gasket is attached to the manifold, please order the base gasket separately if it is needed for maintenance. Refer to the **Web Catalog** for base gasket part numbers. Refer to page 24 for mounting screw part numbers.

* The 25A- series specifications and dimensions are the same as those of the standard model.

For details, refer to the **Web Catalog**.

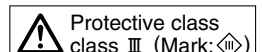

⚠ Caution

If the JSY3000 series is to be continuously energized, please be sure to select the power-saving circuit (continuous duty type) specification. Refer to "Made to Order."

For the JSY1000 series, only the power-saving circuit specification is available.

Plug-in Connector Connecting Base

Terminal Block Box

Type 10
Side Ported

25A-JSY1000/3000 Series



Internal Pilot

How to Order Manifolds

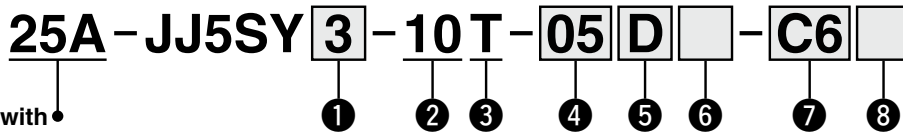

Series compatible with secondary batteries

1 Series

1	JSY1000
3	JSY3000

2 Type

10	Side ported
----	-------------

3 Wiring

T	Terminal block box
---	--------------------

4 Valve stations

T: Terminal block box

Symbol	Stations	Note
02	2 stations	Double wiring*1
⋮	⋮	
10	10 stations	
02	2 stations	Specified layout*2 (Up to 16 solenoids available)
⋮	⋮	
16	16 stations	

*1 Double wiring: 2-position single, 2-position double, 3-position, and 4-position valves can be used on all manifold stations. The use of a 2-position single solenoid will result in an unused control signal. If this is not desired, order with a specified layout.

*2 Specified layout: Indicate the wiring specifications on the manifold specification sheet. (Note that 2-position double, 3-position, and 4-position valves cannot be used where single wiring has been specified.)

*3 This also includes the number of blanking plates.

5 P, E port entry

U	U side (2 to 10 stations)
D	D side (2 to 10 stations)
B	Both sides (2 to 16 stations)

6 SUP/EXH block assembly

Nil	Internal pilot
S	Internal pilot, Built-in silencer

* The 3/5(E) port is plugged for the built-in silencer type.

* When the built-in silencer type is used, keep the exhaust port from coming into direct contact with water or other liquids.

7 A, B port size (Metric/One-touch fitting)

Symbol	A, B port	JSY1000	JSY3000
C4	Straight	●	—
C6		●	●
C8		—	●
CM*1		●	●
P, E port size (One-touch fittings)		●	●
		ø8	ø10

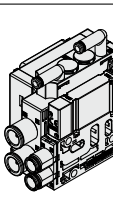

*1 Indicate the sizes on the manifold specification sheet for "CM."

* The JSY1000 manifold pitch for C4 is 6.5 mm, and 9 mm for C6. When CM is selected, the manifold pitch is different depending on the selected fitting.

8 Mounting and Option

Symbol	Mounting
Nil	Direct mounting
D□	DIN rail mounting

* Enter the number of stations inside □ when it is larger than the number of valve stations. (Refer to "DIN Rail Option" shown below.)

* Refer to the **Web Catalog** for details on securing the DIN rail mounting type manifold.

DIN Rail Option

Nil	DIN rail mounting (With DIN rail)	
0	DIN rail mounting (Without DIN rail)	
3	For 3 stations	Specify a length longer than that of the standard rail.
⋮	⋮	
16	For 16 stations	

* The 25A- series specifications and dimensions are the same as those of the standard model.

For details, refer to the **Web Catalog**.

How to Order Manifold Assembly

Example (25A-JJ5SY3-10T-□)

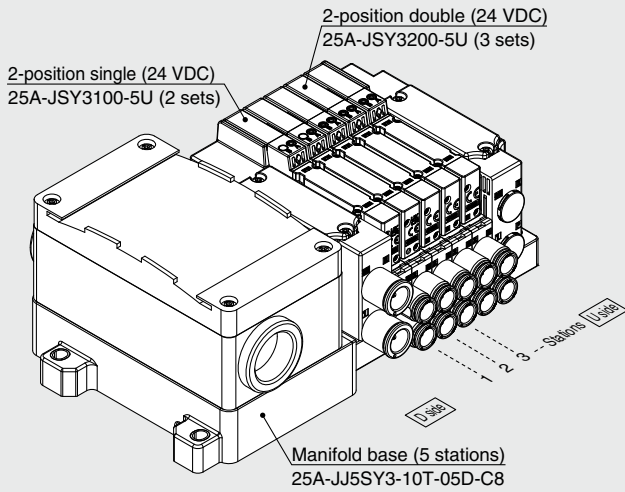

25A-JJ5SY3-10T-05D-C8 1 set (Type 10 5-station manifold base part no.)
 * 25A-JSY3100-5U 2 sets (2-position single part no.)
 * 25A-JSY3200-5U 3 sets (2-position double part no.)

→ The asterisk denotes the symbol for the assembly. Prefix it to the part numbers of the valve, etc.

- For the valve arrangement, the valve closest to the D side is considered the 1st station.
- Under the manifold part number, state the valves to be mounted in order starting with the 1st station as shown in the figure. If the arrangement becomes too complicated, specify the details on a manifold specification sheet.

Internal Pilot

How to Order Valves (With mounting screw)

Refer to the **Web Catalog** for valve specifications.

25A-JSY1000 Series

25A - JSY 1 1 0 0 T - 5 Z □

25A-JSY3000 Series

25A - JSY 3 1 0 0 - 5 Z □

Series compatible with secondary batteries

Base mounted

With power-saving circuit



Made to Order

Specification

With power-saving circuit (Continuous duty type): 0.1 W (JSY3000)

1 Series

1	JSY1000
3	JSY3000

3 Pilot valve exhaust method

0	Pilot valve individual exhaust
---	--------------------------------

4 Rated voltage

5	24 VDC
---	--------

2 Type of actuation

1	Single
2	2-position Double
3	Closed center
4	3-position Exhaust center
5	Pressure center
A	4-position N.C./N.C.
B	dual 3-port N.O./N.O.
C	N.C./N.O.

5 Light/surge voltage suppressor and common specification

Symbol	With light	Surge voltage suppressor	Common specification
U			Non-polar
Z	●	●	Positive common
NZ			Negative common

* Only "Z" and "NZ" types are available for the JSY1000 series.

* When the non-polar common specification type is selected, take measures to prevent surge voltage. For details, refer to the **Web Catalog**.

6 Manual override

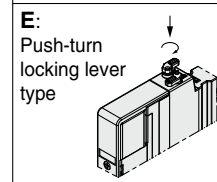
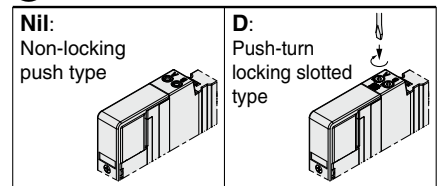

* Push-turn locking lever type "E" is not available for the JSY1000.

* **When ordering a valve individually, the base gasket is not included.** Since the base gasket is attached to the manifold, please order the base gasket separately if it is needed for maintenance.

Refer to the **Web Catalog** for base gasket part numbers. Refer to page 24 for mounting screw part numbers.

* The 25A- series specifications and dimensions are the same as those of the standard model.

For details, refer to the **Web Catalog**.

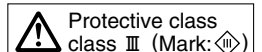

⚠ Caution

If the JSY3000 series is to be continuously energized, please be sure to select the power-saving circuit (continuous duty type) specification. Refer to "Made to Order."

For the JSY1000 series, only the power-saving circuit specification is available.

Directional Control Valves
Air Cylinders
Related Products
Rotary Actuators
Air Grippers
Vacuum Equipment
Air Preparation Equipment
Clean Air Filters
Modular F.R.L./Pressure Control Equipment
Flow Control Equipment/Fittings
Detection Switches
Fluid Control Equipment
Process Gas Equipment
Electric Actuators
Auto Switches

Plug-in Connector Connecting Base

EX260

Type 10
Side Ported

25A-JSY1000/3000 Series



Internal Pilot

How to Order Manifolds

25A-JJ5SY 3-10S QA-05D □ -C6 □

Series compatible with secondary batteries

1 Series

1	JSY1000
3	JSY3000

3 SI unit (Output polarity, Protocol, Number of outputs, Communication connector)

Symbol (Output polarity)		Protocol	Number of outputs	Communication connector
Positive common (NPN)	Negative common (PNP)			
0*1 Without SI unit				
QA	QAN	DeviceNet™	32	M12
QB	QBN		16	
NA	NAN	PROFIBUS DP	32	M12
NB	NBN		16	
VA	VAN	CC-Link	32	M12
VB	VBN		16	
DA	DAN	EtherCAT	32	M12
DB	DBN		16	
FA	FAN	PROFINET	32	M12
FB	FBN		16	
EA	EAN	EtherNet/IP™	32	M12
EB	EBN		16	

- *1 Without SI unit, the output polarity is decided by the SI unit used. Ensure a match with the common specification of the valves to be used.
- * DIN rail cannot be mounted without SI unit.

7 A, B port size (Metric/One-touch fitting)

Symbol	A, B port	JSY1000	JSY3000
C4	Straight	●	—
C6		●	●
C8		—	●
CM*1		●	●
P, E port size (One-touch fittings)		●	●

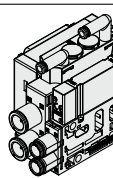

- *1 Indicate the sizes on the manifold specification sheet for "CM."
- * The JSY1000 manifold pitch for C4 is 6.5 mm, and 9 mm for C6. When CM is selected, the manifold pitch is different depending on the selected fitting.

2 Type

10	Side ported
----	-------------

5 P, E port entry

U	U side (2 to 10 stations)
D	D side (2 to 10 stations)
B	Both sides (2 to 16 stations)

6 SUP/EXH block assembly

Nil	Internal pilot
S	Internal pilot, Built-in silencer

- * The 3/5(E) port is plugged for the built-in silencer type.
- * When the built-in silencer type is used, keep the exhaust port from coming into direct contact with water or other liquids.

4 Valve stations

In the case of the 32-output SI unit

Symbol	Stations	Note
02	2 stations	Double wiring*1
⋮	⋮	
16	16 stations	

In the case of the 16-output SI unit

Symbol	Stations	Note
02	2 stations	Double wiring*1
⋮	⋮	
08	8 stations	
02	2 stations	Specified layout*2 (Up to 16 solenoids available)
⋮	⋮	
16	16 stations	

- *1 Double wiring: 2-position single, 2-position double, 3-position, and 4-position valves can be used on all manifold stations. The use of a 2-position single solenoid will result in an unused control signal. If this is not desired, order with a specified layout.
- *2 Specified layout: Indicate the wiring specifications on the manifold specification sheet. (Note that 2-position double, 3-position, and 4-position valves cannot be used where single wiring has been specified.)
- * This also includes the number of blanking plates.
- * For the product without the SI unit (S0), note the maximum number of solenoids of the SI unit that will be mounted. If the layout is specified, indicate it on the manifold specification sheet.

8 Mounting and Option

Symbol	Mounting
Nil	Direct mounting
D□	DIN rail mounting

- * Enter the number of stations inside □ when it is larger than the number of valve stations. (Refer to "DIN Rail Option" shown below.)
- * Refer to the **Web Catalog** for details on securing the DIN rail mounting type manifold.
- * DIN rail mounting (D□) is not available for the product without the SI unit (S0).

DIN Rail Option

Nil	DIN rail mounting (With DIN rail)	
0	DIN rail mounting (Without DIN rail)	
3	For 3 stations	Specify a length longer than that of the standard rail.
⋮	⋮	
16	For 16 stations	

- * Refer to L3 of the dimensions for the DIN rail length and order separately. (Refer to the **Web Catalog** for the DIN rail part number.)

- * The 25A-series specifications and dimensions are the same as those of the standard model.

For details, refer to the **Web Catalog**.

For details on the EX260 Integrated Type (For Output) Serial Transmission System, refer to the **Web Catalog** and the Operation Manual. For the part numbers of the SI units to be mounted, refer to the **Web Catalog**. Please download the Operation Manual via the SMC website: <https://www.smcworld.com>

How to Order Manifold Assembly

Example (25A-JJ5SY3-10SNAN-□)

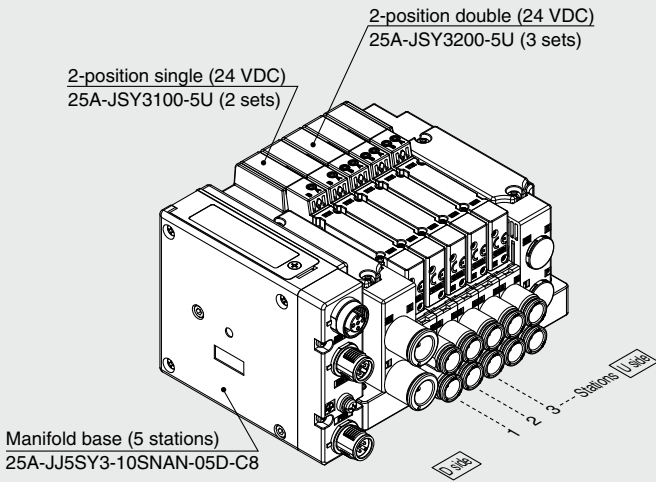

25A-JJ5SY3-10SNAN-05D-C8...1 set (Type 10 5-station manifold base part no.)
 * 25A-JSY3100-5U2 sets (2-position single part no.)
 * 25A-JSY3200-5U3 sets (2-position double part no.)
 ↳ The asterisk denotes the symbol for the assembly. Prefix it to the part numbers of the valve, etc.

- For the valve arrangement, the valve closest to the D side is considered the 1st station.
- Under the manifold part number, state the valves to be mounted in order starting with the 1st station as shown in the figure. If the arrangement becomes too complicated, specify the details on a manifold specification sheet.

Internal Pilot How to Order Valves (With mounting screw) Refer to the Web Catalog for valve specifications.

25A-JSY1000 Series **25A-JSY1100T-5Z** Made to Order

25A-JSY3000 Series **25A-JSY3100-5Z** Made to Order

Series compatible with secondary batteries

With power-saving circuit

Base mounted

Specification

With power-saving circuit (Continuous duty type): 0.1 W (JSY3000)

1 Series

1	JSY1000
3	JSY3000

3 Pilot valve exhaust method

0	Pilot valve individual exhaust
---	--------------------------------

4 Rated voltage

5	24 VDC
---	--------

⚠ Caution
 If the JSY3000 series is to be continuously energized, please be sure to select the power-saving circuit (continuous duty type) specification. Refer to "Made to Order."
 For the JSY1000 series, only the power-saving circuit specification is available.

2 Type of actuation

1	2-position	Single
2		Double
3	3-position	Closed center
4		Exhaust center
5		Pressure center
A	4-position dual 3-port	N.C./N.C.
B		N.O./N.O.
C		N.C./N.O.

5 Light/surge voltage suppressor and common specification

Symbol	With light	Surge voltage suppressor	Common specification
U	●	●	Non-polar
Z	●	●	Positive common
NZ	●	●	Negative common

- * Select "U" or "Z" for the valve when the SI unit output polarity is Nil (positive common). Select "U" or "NZ" for the valve when the SI unit output polarity is N (negative common).
- * Only "Z" and "NZ" types are available for the JSY1000 series.
- * When the non-polar common specification type is selected, take measures to prevent surge voltage. For details, refer to the Web Catalog.

6 Manual override

<p>Nil: Non-locking push type</p>	<p>D: Push-turn locking slotted type</p>
<p>E: Push-turn locking lever type</p>	

* Push-turn locking lever type "E" is not available for the JSY1000.

* **When ordering a valve individually, the base gasket is not included.** Since the base gasket is attached to the manifold, please order the base gasket separately if it is needed for maintenance. Refer to the Web Catalog for base gasket part numbers. Refer to page 24 for mounting screw part numbers.

* The 25A- series specifications and dimensions are the same as those of the standard model.

For details, refer to the Web Catalog.

⚠ Protective class class III (Mark: ⚡)

Directional Control Valves
Air Cylinders
Related Products
Rotary Actuators
Air Grippers
Vacuum Equipment
Air Preparation Equipment
Clean Air Filters
Modular F.R.L./Pressure Control Equipment
Flow Control Equipment/Fittings
Detection Switches
Fluid Control Equipment
Process Gas Equipment
Electric Actuators
Auto Switches

Plug-in Connector Connecting Base

EX120

Type 10
Side Ported

25A-JSY1000/3000 Series



Internal Pilot

How to Order Manifolds

25A-JJ5SY 3 - 10 S3 Q - 05 D -

1
 2
 3
 4
 5
 6
 7
 8

Series compatible with secondary batteries

1 Series

1	JSY1000
3	JSY3000

2 Type

10	Side ported
-----------	-------------

3 SI unit

0	Without SI unit
Q	DeviceNet™ (Positive common NPN)
V	CC-Link (Positive common NPN)

* Ensure a match with the common specification of the valve to be used.

4 Valve stations

Symbol	Stations	Note
02	2 stations	Double wiring*1
⋮	⋮	
08	8 stations	Specified layout*2 (Up to 16 solenoids available)
02	2 stations	
⋮	⋮	
16	16 stations	

*1 Double wiring: 2-position single, 2-position double, 3-position, and 4-position valves can be used on all manifold stations. The use of a 2-position single solenoid will result in an unused control signal. If this is not desired, order with a specified layout.

*2 Specified layout: Indicate the wiring specifications on the manifold specification sheet. (Note that 2-position double, 3-position, and 4-position valves cannot be used where single wiring has been specified.)

* This also includes the number of blanking plates.

5 P, E port entry

U	U side (2 to 10 stations)
D	D side (2 to 10 stations)
B	Both sides (2 to 16 stations)

6 SUP/EXH block

Nil	Internal pilot
S	Internal pilot, Built-in silencer

* The 3/5(E) port is plugged for the built-in silencer type.

7 A, B port size (Metric/One-touch fitting)

Symbol	A, B port	JSY1000	JSY3000
C4	Straight	●	—
C6		●	●
C8		—	●
CM *1		●	●
P, E port size (One-touch fittings)		ø8	ø10

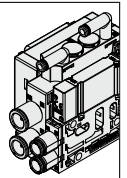

*1 Indicate the sizes on the manifold specification sheet for "CM."

* The JSY1000 manifold pitch for C4 is 6.5 mm, and 9 mm for C6. When CM is selected, the manifold pitch is different depending on the selected fitting.

8 Mounting and Option

Symbol	Mounting
Nil	Direct mounting
D <input type="checkbox"/>	DIN rail mounting

* Enter the number of stations inside when it is larger than the number of valve stations. (Refer to "DIN Rail Option" shown below.)

* Refer to the **Web Catalog** for details on securing the DIN rail mounting type manifold.

DIN Rail Option

Nil	DIN rail mounting (With DIN rail)	
0	DIN rail mounting (Without DIN rail)	
3	For 3 stations	Specify a length longer than that of the standard rail.
⋮	⋮	
16	For 16 stations	

* If the DIN rail must be mounted without an SI unit, select D0. Refer to L3 of the dimensions for the DIN rail length and order separately. (Refer to the **Web Catalog** for the DIN rail part number.)

* The 25A-series specifications and dimensions are the same as those of the standard model.

For details, refer to the Web Catalog.

For details on the EX120 Integrated Type (For Output) Serial Transmission System, refer to the **Web Catalog** and the Operation Manual. For the part numbers of the SI units to be mounted, refer to the **Web Catalog**. Please download the Operation Manual via the SMC website: <https://www.smcworld.com>

How to Order Manifold Assembly

Example (25A-JJ5SY3-10S3Q-□)

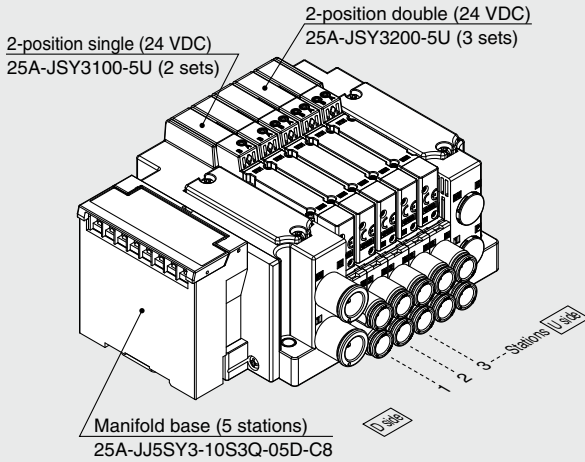

25A-JJ5SY3-10S3Q-05D-C8 ..1 set (Type 10 5-station manifold base part no.)
 * 25A-JSY3100-5U2 sets (2-position single part no.)
 * 25A-JSY3200-5U3 sets (2-position double part no.)
 ↳ The asterisk denotes the symbol for the assembly.
 Prefix it to the part numbers of the valve, etc.

- For the valve arrangement, the valve closest to the D side is considered the 1st station.
- Under the manifold part number, state the valves to be mounted in order starting with the 1st station as shown in the figure. If the arrangement becomes too complicated, specify the details on a manifold specification sheet.

Internal Pilot How to Order Valves (With mounting screw) Refer to the Web Catalog for valve specifications.

25A-JSY1000 Series

25A-JSY3000 Series

25A - JSY 1 1 0 0 T - 5 Z □

25A - JSY 3 1 0 0 - 5 Z □

Series compatible with secondary batteries

1 2 3 4 5 6

Base mounted

With power-saving circuit

Made to Order

Specification

With power-saving circuit (Continuous duty type): 0.1 W (JSY3000)

1 Series

1	JSY1000
3	JSY3000

2 Type of actuation

1	Single
2	2-position Double
3	Closed center
4	3-position Exhaust center
5	Pressure center
A	4-position N.C./N.C.
B	dual 3-port N.O./N.O.
C	N.C./N.O.

6 Manual override

Nil: Non-locking push type

D: Push-turn locking slotted type

3 Pilot valve exhaust method

0	Pilot valve individual exhaust
---	--------------------------------

4 Rated voltage

5	24 VDC
---	--------

5 Light/surge voltage suppressor and common specification

Symbol	With light	Surge voltage suppressor	Common specification
U	●	●	Non-polar
Z	●	●	Positive common

Caution
 If the JSY3000 series is to be continuously energized, please be sure to select the power-saving circuit (continuous duty type) specification.
 For the JSY1000 series, only the power-saving circuit specification is available.

- * Only "Z" and "NZ" types are available for the JSY1000 series.
- * When the non-polar common specification type is selected, take measures to prevent surge voltage. For details, refer to the Web Catalog.

E: Push-turn locking lever type

* Push-turn locking lever type "E" is not available for the JSY1000.

* **When ordering a valve individually, the base gasket is not included.**
 Since the base gasket is attached to the manifold, please order the base gasket separately if it is needed for maintenance.
 Refer to the Web Catalog for base gasket part numbers.
 Refer to page 24 for mounting screw part numbers.

* The 25A- series specifications and dimensions are the same as those of the standard model.

For details, refer to the Web Catalog.

Protective class class III (Mark: ⚡)

Directional Control Valves
 Air Cylinders
 Related Products
 Rotary Actuators
 Air Grippers
 Vacuum Equipment
 Air Preparation Equipment
 Clean Air Filters
 Modular F.R.L./Pressure Control Equipment
 Flow Control Equipment/Fittings
 Detection Switches
 Fluid Control Equipment
 Process Gas Equipment
 Electric Actuators
 Auto Switches

25A-JSY1000/3000 Series Manifold Options

Blanking plate assembly

(With two mounting screws)

Used when valve additions are expected or for maintenance. A structure is in place on the blanking plate to prevent the mounting screws from sliding.

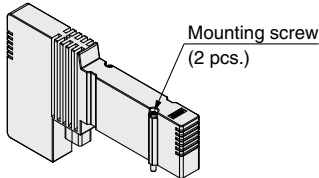

How to Order Blanking Plate Assembly

25A - JSY **3** 1M - 26P - 1A

Series

1	JSY1000
3	JSY3000

SI Unit Part Nos.

Description	SI unit part no.	Note
EX260 SI unit	EX260-SPR1-X117	PROFIBUS DP M12 connector, 32 outputs, Negative common (PNP)
	EX260-SPR2-X117	PROFIBUS DP M12 connector, 32 outputs, Positive common (NPN)
	EX260-SPR3-X117	PROFIBUS DP M12 connector, 16 outputs, Negative common (PNP)
	EX260-SPR4-X117	PROFIBUS DP M12 connector, 16 outputs, Positive common (NPN)
	EX260-SDN1-X117	DeviceNet® M12 connector, 32 outputs, Negative common (PNP)
	EX260-SDN2-X117	DeviceNet® M12 connector, 32 outputs, Positive common (NPN)
	EX260-SDN3-X117	DeviceNet® M12 connector, 16 outputs, Negative common (PNP)
	EX260-SDN4-X117	DeviceNet® M12 connector, 16 outputs, Positive common (NPN)
	EX260-SEC1-X117	EtherCAT M12 connector, 32 outputs, Negative common (PNP)
	EX260-SEC2-X117	EtherCAT M12 connector, 32 outputs, Positive common (NPN)
	EX260-SEC3-X117	EtherCAT M12 connector, 16 outputs, Negative common (PNP)
	EX260-SEC4-X117	EtherCAT M12 connector, 16 outputs, Positive common (NPN)
	EX260-SMJ1-X117	CC-Link M12 connector, 32 outputs, Negative common (PNP)
	EX260-SMJ2-X117	CC-Link M12 connector, 32 outputs, Positive common (NPN)
	EX260-SMJ3-X117	CC-Link M12 connector, 16 outputs, Negative common (PNP)
	EX260-SMJ4-X117	CC-Link M12 connector, 16 outputs, Positive common (NPN)
	EX260-SPN1-X117	PROFINET M12 connector, 32 outputs, Negative common (PNP)
	EX260-SPN2-X117	PROFINET M12 connector, 32 outputs, Positive common (NPN)
	EX260-SPN3-X117	PROFINET M12 connector, 16 outputs, Negative common (PNP)
	EX260-SPN4-X117	PROFINET M12 connector, 16 outputs, Positive common (NPN)
EX120 SI unit	EX120-SEN1-X117	EtherNet/IP™ M12 connector, 32 outputs, Negative common (PNP)
	EX120-SEN2-X117	EtherNet/IP™ M12 connector, 32 outputs, Positive common (NPN)
	EX120-SEN3-X117	EtherNet/IP™ M12 connector, 16 outputs, Negative common (PNP)
	EX120-SEN4-X117	EtherNet/IP™ M12 connector, 16 outputs, Positive common (NPN)
	EX120-SMJ1-X220	CC-Link (Terminal block, 16 outputs, Positive common (NPN))
	EX120-SDN1-X220	DeviceNet® (Terminal block, 16 outputs, Positive common (NPN))

One-touch Fittings Part Nos.

Port size	Series	25A-JSY1000		25A-JSY3000	Note
		6.5 mm pitch	9 mm pitch		
A, B port	ø4	25A-KQSY10-C4-X1336	—	—	The part number is for 1 piece. (Sales unit: 10 pcs.)
	ø6	—	25A-KQSY11-C6-X1336	25A-KQSY30-C6	
	ø8	—	—	25A-KQSY30-C8-X1336	
P, E port	ø8	25A-KQSY30-C8-X1336		—	
	ø10	—	—	25A-KQSY31-C10-X1336	

How to Order Individual SUP/EXH Spacer Assembly

One-touch fitting Straight type **25A - JSY 3 1M - 38 P - 1A - C6**

Series

1	JSY1000
3	JSY3000

Spacer type

38	Individual SUP spacer
39	Individual EXH spacer

Port size (Metric)

Symbol	P, E port	JSY1000	JSY3000
C4	ø4 One-touch fitting	●	—
C6	ø6 One-touch fitting	—	●

Part numbers of mounting screw
(2 pcs. of each)

JSY1000: 25A-JSY11V-23-5A
JSY3000: 25A-JSY31V-23-2A

Manifold Parts Nos./For the 25A-JJ5SY1-10, 25A-JJ5SY3-10

Description	25A-JSY1000		25A-JSY3000
	6.5 mm pitch	9 mm pitch	
Tie-rod for additional stations	JSY11M-49P-4-1-A (6.5 mm pitch)	JSY11M-49P-3-1-A (9 mm pitch)	JSY31M-49P-2-1-A (11.5 mm pitch)
Tie-rod	JSY11M-49P-4-□-A (6.5 mm pitch)	JSY11M-49P-3-□-A (9 mm pitch)	JSY31M-49P-2-□-A (11.5 mm pitch)
Valve mounting screw	25A-JSY11V-23-4A (M1.4 x 21.5)		25A-JSY31V-23-1A (M2 x 25)
Clamp bracket (for connector connecting base)	25A-JSY11M-15P-1A (Refer to the table below.) 25A-JSY11M-15P-2A (Refer to the table below.)		25A-SY30M-15-1A

Table. 25A-JSY1000 series clamp bracket

Wiring (JSY1000 series)		25A-JSY11M-15P-1A	25A-JSY11M-15P-2A
F	D-sub connector	●	—
T	Terminal block box	—	●
S□□	EX260	●	—
S3	EX120	●	—

Manifold Parts Nos.

Ⓐ Manifold block assembly

25A – JSY 3 1M – 2P – 1 D A – C8

● **Series**

1	JSY1000
3	JSY3000

● **Manifold pitch**

1	JSY1000 (6.5 mm pitch) JSY3000 (11.5 mm pitch)
2	JSY1000 (9 mm pitch)

● **A, B port size (One-touch fittings)**

Symbol	A, B port	JSY1000		JSY3000
		6.5 mm pitch	9 mm pitch	
C4	ø4 One-touch fitting	●	—	—
C6	ø6 One-touch fitting	—	●	●
C8	ø8 One-touch fitting	—	—	●

● **Wiring type**

S	Single wiring
D	Double wiring

Directional Control Valves
 Air Cylinders
 Related Products
 Rotary Actuators
 Air Grippers
 Vacuum Equipment
 Air Preparation Equipment
 Clean Air Filters
 Modular F.R.L./Pressure Control Equipment
 Flow Control Equipment/Fittings
 Detection Switches
 Fluid Control Equipment
 Process Gas Equipment
 Electric Actuators
 Auto Switches

25A-JSY1000/3000 Series

Manifold Parts Nos.

② SUP/EXH end block assembly

25A – JSY **3** 1M – 3P – 1A – C10

● **Series**

1	JSY1000
3	JSY3000

● **Pilot, Silencer type**

Symbol	Pilot type	
	Internal	Built-in silencer
Nil	●	—
S	●	●

● **P, E port size (One-touch fittings)**

Symbol	P, E port	JSY1000	JSY3000
C8	ø8 One-touch fitting	●	—
C10	ø10 One-touch fitting	—	●
00	Plug	●	●

● **Mounting**

Nil	Direct mounting
D0	DIN rail mounting (Without DIN rail)
D00*1	DIN rail mounting (Without DIN rail)

*1 Part number only for the 25A-JSY1000
Part number is different depending on the wiring.
Refer to Table 1.

Table 1. JSY1000 series DIN rail mounting

Symbol	Wiring
D0	D-sub connector (F type) EX260 (S□□ type) EX120 (S3 type)
D00	Terminal block box (T type)

Clamp bracket

Series		Part no.
25A-JSY1000	For D0	25A-JSY11M-15P-1A
	For D00	25A-JSY11M-15P-2A
25A-JSY3000		25A-SY30M-15-1A

■ Cover, Silencer cover for SUP/EXH (end) block assembly

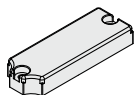

Cover
(Internal pilot)

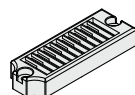

Silencer cover
(Internal pilot, Built-in silencer)

25A – JSY **3** 1M – 4P – 1A

25A – JSY **3** 1M – 5P – 1A

● **Series**

1	JSY1000
3	JSY3000

Manifold Parts Nos.

© SUP/EXH block assembly

For D-sub connector

25A-JSY 3 **1M-1P-3A** **1** - **C10**

Series

1	JSY1000
3	JSY3000

Pilot, Silencer type

Symbol	Pilot type	
	Internal	Built-in silencer
Nil	●	—
S	●	●

Mounting

Nil	Direct mounting
D0	DIN rail mounting (Without DIN rail)

P, E port size (One-touch fittings)

Symbol	P, E port	JSY1000	JSY3000
C8	ø8 One-touch fitting	●	—
C10	ø10 One-touch fitting	—	●
00	Plug	●	●

Connector entry direction

1	Upward
2	Lateral

For the terminal block box or EX260

25A-JSY 3 **1M-1P-1A** - **C10**

Series

1	JSY1000
3	JSY3000

Pilot, Silencer type

Symbol	Pilot type	
	Internal	Built-in silencer
Nil	●	—
S	●	●

Mounting

Symbol	Mounting	JSY1000			JSY3000
		Terminal block	EX260		
Nil	Mounting	●	●	●	
D00	Direct mounting	●	—	—	
D0	DIN rail mounting (Without DIN rail)	—	●	●	

P, E port size (One-touch fittings)

Symbol	P, E port	JSY1000	JSY3000
C8	ø8 One-touch fitting	●	—
C10	ø10 One-touch fitting	—	●
00	Plug	●	●

For EX120

25A-JSY 3 **1M-1P-14A** - **C10**

Series

1	JSY1000
3	JSY3000

Pilot, Silencer type

Symbol	Pilot type	
	Internal	Built-in silencer
Nil	●	—
S	●	●

Mounting

Nil	Direct mounting
D0	DIN rail mounting (Without DIN rail)

P, E port size (One-touch fittings)

Symbol	P, E port	JSY1000	JSY3000
C8	ø8 One-touch fitting	●	—
C10	ø10 One-touch fitting	—	●
00	Plug	●	●

* Refer to page 25 for clamp bracket part numbers.

Directional Control Valves
 Air Cylinders
 Related Products
 Rotary Actuators
 Air Grippers
 Vacuum Equipment
 Air Preparation Equipment
 Clean Air Filters
 Modular F.R.L./Pressure Control Equipment
 Flow Control Equipment/Fittings
 Detection Switches
 Fluid Control Equipment
 Process Gas Equipment
 Electric Actuators
 Auto Switches

25A-JSY1000/3000 Series

How to Order Pilot Valves

25A - V112 - 5 A

• Rated voltage

5	24 VDC
---	--------

• Coil type

Nil	Standard
T	With power-saving circuit (Made to Order)

Pilot cover

25A - SY30V - 25AS (For 25A-JSY3000)

* The pilot valve of the 25A-JSY1000 series cannot be replaced.

Auto Switches	Electric Actuators	Process Gas Equipment	Fluid Control Equipment	Detection Switches	Flow Control Equipment/Fittings	Modular F.R.L./Pressure Control Equipment	Clean Air Filters	Air Preparation Equipment	Vacuum Equipment	Air Grippers	Rotary Actuators	Related Products	Air Cylinders	Directional Control Valves
---------------	--------------------	-----------------------	-------------------------	--------------------	---------------------------------	---	-------------------	---------------------------	------------------	--------------	------------------	------------------	---------------	----------------------------

Type 40
Side Ported

Non Plug-in Metal Base

25A-JSY1000/3000 Series



Internal Pilot

How to Order Manifolds

25A - JJ5SY **3** - 40 - 05 **D** - C6

1
2
3
4
5
6

Series compatible with secondary batteries

1 Series

1	JSY1000
3	JSY3000

2 Type

40	Side ported
----	-------------

3 Valve stations

Symbol	Stations
02	2 stations
⋮	⋮
20	20 stations

4 P, E port entry

U	U side*1
D	D side*1
B	Both sides

*1 Plugs are mounted on the opposite side of the selected ports.

5 A, B port size

Thread piping

Symbol	A, B port	JSY1000	JSY3000
M3	M3 x 0.5	●	—
M5	M5 x 0.8	●	●
01	1/8	—	●

6 Thread type

Nil	Rc
-----	----

One-touch fitting (Metric)

Symbol	A, B port	JSY1000	JSY3000
Fixed	C4	●	—
	C6	—	●
Replaceable	KC4	●	—
	KC6	●	●
	KC8	—	●
	M*1	A, B ports mixed	—
P, E port size (Thread piping)		1/8	1/4

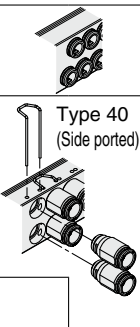

*1 When ports are mixed sizes, indicate the piping specifications on the manifold specification sheet.

* The 25A-series specifications and dimensions are the same as those of the standard model.

For details, refer to the **Web Catalog**.

How to Order Manifold Assembly

Example (25A-JJ5SY3-40-□)

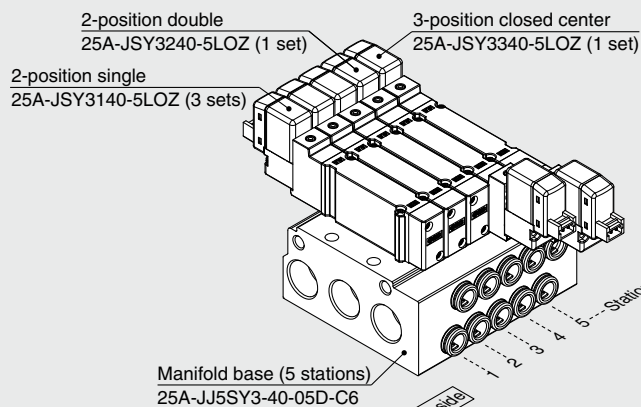

25A-JJ5SY3-40-05D-C6 .. 1 set (Type 40 5-station manifold base part no.)
 * 25A-JSY3140-5LOZ 3 sets (2-position single part no.)
 * 25A-JSY3240-5LOZ 1 set (2-position double part no.)
 * 25A-JSY3340-5LOZ 1 set (3-position closed center part no.)

→ The asterisk denotes the symbol for the assembly.
Prefix it to the part numbers of the valve, etc.

· For the valve arrangement, the valve closest to the D side is considered the 1st station.

· Under the manifold part number, state the valves to be mounted in order starting with the 1st station as shown in the figure. If the arrangement becomes too complicated, specify the details on a manifold specification sheet.

Internal Pilot

How to Order Valves (With two mounting screws)

25A-JSY1000 Series

25A-JSY 1 1 4 0 T-5 L Z

25A-JSY3000 Series

25A-JSY 3 1 4 0 -5 L Z

① ② ③ ④ ⑤ ⑥ ⑦



Made to Order

Specification
With power-saving circuit (Continuous duty type): 0.1 W (JSY3000)

• Series compatible with secondary batteries

• With power-saving circuit

① Series

1	JSY1000
3	JSY3000

② Type of actuation

1	2-position single
2	2-position double
3	3-position closed center
4	3-position exhaust center
5	3-position pressure center
A	Dual 3-port (N.C./N.C.)
B	Dual 3-port (N.O./N.O.)
C	Dual 3-port (N.C./N.O.)

③ Pilot valve exhaust method

0	Pilot valve individual exhaust
---	--------------------------------

④ Rated voltage

5	24 VDC
---	--------

⑥ Light/surge voltage suppressor

Z	With light/surge voltage suppressor
---	-------------------------------------

⑤ Electrical entry

	L plug connector		M plug connector	
	L	LO	M	MO
JSY1000	L: With lead wire (300 mm) 	LO: Without connector 	M: With lead wire (300 mm) 	MO: Without connector
JSY3000	L: With lead wire (300 mm) 	LO: Without connector 	M: With lead wire (300 mm) 	MO: Without connector

* Refer to the Web Catalog for the lead wire length of L and M plug connectors.

⑦ Manual override

JSY1000	Nil: Non-locking push type 	D: Push-turn locking slotted type 	E: Push-turn locking lever type
JSY3000	Nil: Non-locking push type 	D: Push-turn locking slotted type 	E: Push-turn locking lever type

* The 25A-series specifications and dimensions are the same as those of the standard model.

For details, refer to the Web Catalog.

⚠ Caution

If the JSY3000 series is to be continuously energized, please be sure to select the power-saving circuit (continuous duty type) specification. Refer to "Made to Order."

For the JSY1000 series, only the power-saving circuit specification is available.

25A-JSY1000/3000 Series Manifold Options

Blanking plate assembly

(With two mounting screws)

Used when valve additions are expected or for maintenance. A structure is in place on the blanking plate to prevent the mounting screws from sliding.

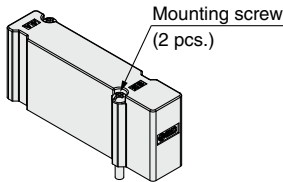

How to Order Blanking Plate Assembly

25A-JSY **3** 1M-26-1A

Series

1	JSY1000
3	JSY3000

Valve Mounting Screw Part No.

Description	Part no.		Note
	25A-JJ5SY1	25A-JJ5SY3	
Round head combination screw	25A-JSY11V-23-4A	25A-JSY31V-23-4A	Part numbers shown on the left are for 10 valves. (20 pcs.)

One-touch Fittings Part Nos.

		Port size	25A-JSY1000	25A-JSY3000
A, B port	Metric size	ø4 One-touch fitting (Straight type)	25A-KQSY10-C4-X1336	—
		ø6 One-touch fitting (Straight type)	25A-KQSY11-C6-X1336	25A-KQSY30-C6
		ø8 One-touch fitting (Straight type)	—	25A-KQSY30-C8-X1336

How to Order Individual SUP/EXH Spacer Assembly

One-touch fitting Straight type 25A-JSY **3** 1M-**38**-1A-**C6**

Series

1	JSY1000
3	JSY3000

Spacer type

38	Individual SUP spacer
39	Individual EXH spacer

Port size (Metric)

Symbol	P, E port	JSY1000	JSY3000
C4	ø4 One-touch fitting	●	—
C6	ø6 One-touch fitting	—	●

Part numbers of mounting screw
(2 pcs. of each)

JSY1000: 25A-JSY11V-23-5A
JSY3000: 25A-JSY31V-23-5A

How to Order Pilot Valves

For 25A-JSY3000

25A-V111 **5** **L** **Z**

Coil type

Nil	Standard
T	With power-saving circuit (Made to Order)

Light/surge voltage suppressor

Z	With light/surge voltage suppressor
---	-------------------------------------

Electrical entry

Symbol	Electrical entry	With lead wire
L	L plug connector	With lead wire
LO		Without connector
M	M plug connector	With lead wire
MO		Without connector

Rated voltage	Rated voltage
5	24 VDC

* For the 25A-JSY1000, the pilot valve is the same as that of the standard model.

Auto Switches	Electric Actuators	Process Gas Equipment	Fluid Control Equipment	Detection Switches	Flow Control Equipment/Fittings	Modular F.R.L./Pressure Control Equipment	Clean Air Filters	Air Preparation Equipment	Vacuum Equipment	Air Grippers	Rotary Actuators	Related Products	Air Cylinders	Directional Control Valves
---------------	--------------------	-----------------------	-------------------------	--------------------	---------------------------------	---	-------------------	---------------------------	------------------	--------------	------------------	------------------	---------------	----------------------------

Type 10
Side Ported

Type 11
Bottom Ported

Plug-in Connector Connecting Base

D-sub Connector

25A-SY5000/7000 Series



How to Order Manifolds

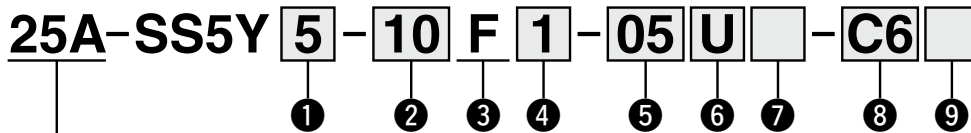

Series compatible with secondary batteries

1 Series

5	SY5000
7	SY7000

2 Type

10	Side ported
11	Bottom ported

3 Connector type

F: D-sub connector (25 pins)

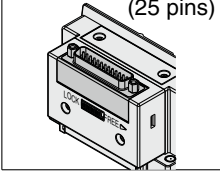

4 Connector entry direction

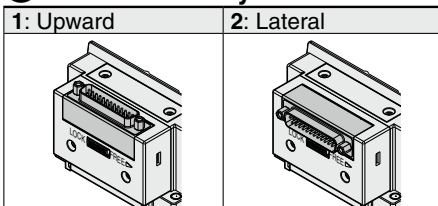

5 Valve stations

F: D-sub connector (25 pins)

Symbol	Stations	Note
02	2 stations	Double wiring*1
⋮	⋮	
12	12 stations	
02	2 stations	Specified layout*2 (Up to 24 solenoids available)
⋮	⋮	
24	24 stations	

*1 Double wiring: 2-position single, 2-position double, 3-position, and 4-position valves can be used on all manifold stations.

The use of a 2-position single solenoid will result in an unused control signal. If this is not desired, order with a specified layout.

*2 Specified layout: Indicate the wiring specifications on the manifold specification sheet. (Note that 2-position double, 3-position, and 4-position valves cannot be used where single wiring has been specified.)

* The blanking plate assembly is included in this number.

6 P, E port entry

U	U side (2 to 10 stations)
D	D side (2 to 10 stations)
B	Both sides (2 to 24 stations)

7 SUP/EXH block assembly

Nil	Internal pilot
S	Internal pilot, Built-in silencer
R	External pilot

* The 3/5(E) port is plugged for the built-in silencer type.

8 A, B port size (Metric)

Symbol	A, B port	Type 10/ Side ported		Type 11/ Bottom ported	
		SY5000	SY7000	SY5000	SY7000
C4	Straight	●	—	●	—
C6		●	●	●	●
C8		●	●	●	●
C10		—	●	—	●
C12		—	●	—	●
CM*1	Straight port, mixed sizes	●	●	●	●
P, E port size (One-touch fittings)		ø10	ø12	ø10	ø12

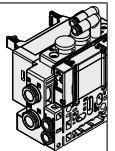

*1 Indicate the sizes on the manifold specification sheet for "CM."

* The direction of P, E port fittings is the same as for the A, B port.

9 Mounting

Symbol	Mounting	Option	
		Name plate	Station number
Nil	Direct mounting	—	—
AA		●	●
BA		●	—
D□	DIN rail mounting	—	—
A□		●	●
B□		●	—

DIN Rail Option

Nil	Direct mounting
0	Without DIN rail (with bracket)
3	For 3 stations
⋮	⋮
24	For 24 stations

* Enter the number of stations inside □ when it is larger than the number of valve stations. (Refer to "DIN Rail Option" above.)

* Only direct mounting is available for the type 11 bottom-ported type.

* The 25A- series specifications and dimensions are the same as those of the standard model.

For details, refer to the Web Catalog.

How to Order Valves (With mounting screw)

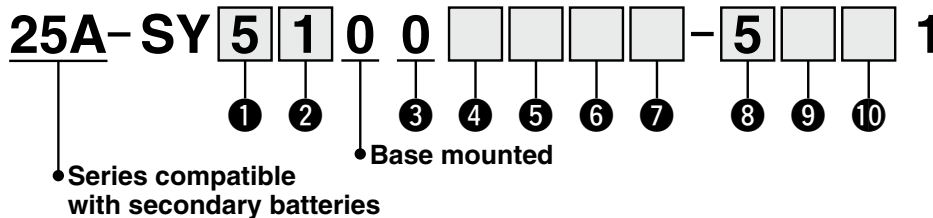

1 Series

5	SY5000
7	SY7000

2 Type of actuation

1	2-position single
2	2-position double
3	3-position closed center
4	3-position exhaust center
5	3-position pressure center
A	4-position dual 3-port valve (N.C./N.C.)
B	4-position dual 3-port valve (N.O./N.O.)
C	4-position dual 3-port valve (N.C./N.O.)

3 Seal type

0	Rubber seal
---	-------------

4 Pilot type

Nil	Internal pilot
R	External pilot

* When selecting the external pilot specification for the 4-position dual 3-port valve, pay attention to the pilot pressure. For details, refer to the valve specifications of the standard SY series product in the **Web Catalog**.

5 Back pressure check valve (Built-in valve type)

Nil	None
H	Built-in

* The built-in valve type back pressure check valve is not available for the 3-position type or the SY7000.

6 Pilot valve option

Nil	Standard (0.7 MPa)
B	Quick response type (0.7 MPa)

7 Coil type

Nil	Standard
T	With power-saving circuit (Continuous duty type)

* Be sure to select the power-saving circuit type if the valve is to be continuously energized for long periods of time.
* Be careful of the energizing time when the power-saving circuit is selected. For details, refer to the standard product catalog.

8 Rated voltage

5	24 VDC
6	12 VDC

9 Light/surge voltage suppressor and common specification

Nil	Without light/surge voltage suppressor (Non-polar)
R	With surge voltage suppressor (Non-polar)
U	With light/surge voltage suppressor (Non-polar)
S	With surge voltage suppressor (Positive common)
Z	With light/surge voltage suppressor (Positive common)
NS	With surge voltage suppressor (Negative common)
NZ	With light/surge voltage suppressor (Negative common)

* Only "Z" and "NZ" types are available with a power-saving circuit.

10 Manual override

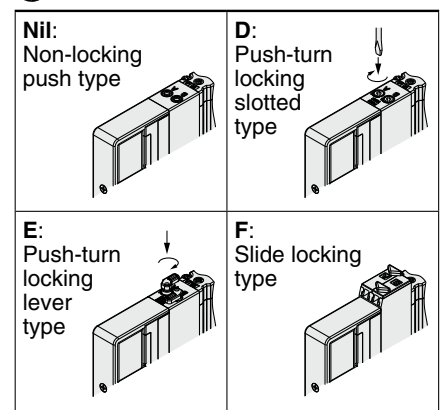

* The 25A- series specifications and dimensions are the same as those of the standard model.

For details, refer to the **Web Catalog**.

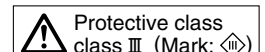

Plug-in Connector Connecting Base

D-sub Connector



Type 12
Top Ported

25A-SY5000/7000 Series

How to Order Manifolds

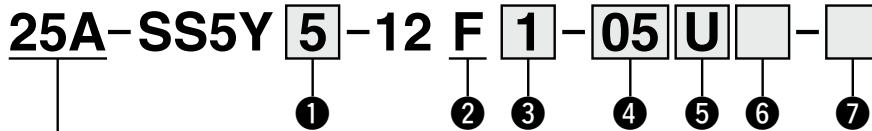

• Series compatible with secondary batteries

① Series

5	SY5000
7	SY7000

② Connector type

F: D-sub connector (25 pins)

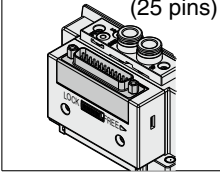

③ Connector entry direction

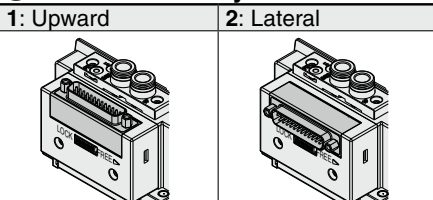

④ Valve stations

F: D-sub connector (25 pins)

Symbol	Stations	Note
02	2 stations	Double wiring*1
⋮	⋮	
12	12 stations	Specified layout*2 (Up to 24 solenoids available)
02	2 stations	
⋮	⋮	
24	24 stations	

*1 Double wiring: 2-position single, 2-position double, 3-position, and 4-position valves can be used on all manifold stations. The use of a 2-position single solenoid will result in an unused control signal. If this is not

desired, order with a specified layout.

*2 Specified layout: Indicate the wiring specifications on the manifold specification sheet. (Note that 2-position double, 3-position, and 4-position valves cannot be used where single wiring has been specified.)

* The blanking plate assembly is included in this number.

⑤ P, E port entry

U*1	U side (2 to 10 stations)
D*1	D side (2 to 10 stations)
B	Both sides (2 to 24 stations)

*1 For type "S," SUP/EXH block assembly with a built-in silencer, choose "U" or "D" for P port entry.

⑥ SUP/EXH block assembly

Nil	Internal pilot
S	Internal pilot, Built-in silencer

* The P and E ports are only available on the U and D sides for the built-in silencer type. The 3/5(E) port is plugged. The silencer exhaust port is located on the opposite side of the P and E port entry. (Example: When the P and E port entry is on the D side, the silencer exhaust port is on the U side.)

⑦ Mounting

Nil	Direct mounting	
D	DIN rail mounting (With DIN rail)	
D0	DIN rail mounting (Without DIN rail)	
D3	For 3 stations	Specify a length longer than that of the standard rail.
⋮	⋮	
D24	For 24 stations	

* The 25A- series specifications and dimensions are the same as those of the standard model.

For details, refer to the **Web Catalog**.

How to Order Valves (With mounting screw)

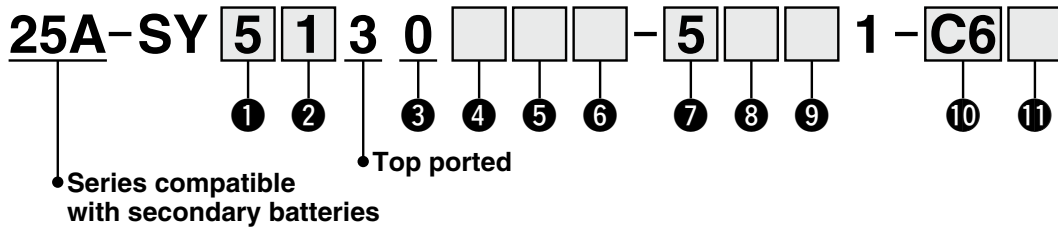

1 Series

5	SY5000
7	SY7000

2 Type of actuation

1	2-position single
2	2-position double
3	3-position closed center
4	3-position exhaust center
5	3-position pressure center
A	4-position dual 3-port valve (N.C./N.C.)
B	4-position dual 3-port valve (N.O./N.O.)
C	4-position dual 3-port valve (N.C./N.O.)

3 Seal type

0	Rubber seal
---	-------------

4 Back pressure check valve (Built-in valve type)

Nil	None
H	Built-in

* The built-in valve type back pressure check valve is not available for the 3-position type or the SY7000.

5 Pilot valve option

Nil	Standard (0.7 MPa)
B	Quick response type (0.7 MPa)

6 Coil type

Nil	Standard
T	With power-saving circuit (Continuous duty type)

* Be sure to select the power-saving circuit type if the valve is to be continuously energized for long periods of time.
* Be careful of the energizing time when the power-saving circuit is selected. For details, refer to the standard product catalog.

7 Rated voltage

5	24 VDC
6	12 VDC

8 Light/surge voltage suppressor and common specification

Nil	Without light/surge voltage suppressor (Non-polar)
R	With surge voltage suppressor (Non-polar)
U	With light/surge voltage suppressor (Non-polar)
S	With surge voltage suppressor (Positive common)
Z	With light/surge voltage suppressor (Positive common)
NS	With surge voltage suppressor (Negative common)
NZ	With light/surge voltage suppressor (Negative common)

* Only "Z" and "NZ" types are available with a power-saving circuit.

9 Manual override

<p>Nil: Non-locking push type</p>	<p>D: Push-turn locking slotted type</p>
<p>E: Push-turn locking lever type</p>	<p>F: Slide locking type</p>

10 A, B port size

Symbol	Port size	Applicable series
02	1/4	SY7000

One-touch fitting (Metric)

Symbol	A, B port	SY5000	SY7000
C4	ø4	●	—
C6	ø6	●	●
C8	ø8	●	●
C10	ø10	—	●
C12	ø12	—	●

11 Thread type

Nil	Rc
F	G
N	NPT
T	NPTF

* The 25A- series specifications and dimensions are the same as those of the standard model.

For details, refer to the Web Catalog.

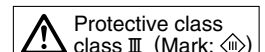

Type 10
Side Ported

Type 11
Bottom Ported

Plug-in Connector Connecting Base

Terminal Block Box

25A-SY5000/7000 Series



How to Order Manifolds

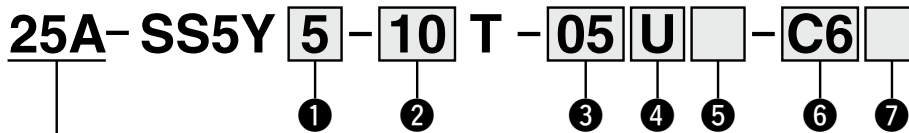

• Series compatible with secondary batteries

① Series

5	SY5000
7	SY7000

② Type

10	Side ported
11	Bottom ported

③ Valve stations

Symbol	Stations	Note
02	2 stations	Double wiring*1
⋮	⋮	
10	10 stations	
02	2 stations	Specified layout*2 (Up to 20 solenoids available)
⋮	⋮	
20	20 stations	

*1 Double wiring: 2-position single, 2-position double, 3-position, and 4-position valves can be used on all manifold stations. The use of a 2-position single solenoid will result in an unused control signal. If this is not desired, order with a specified layout.

*2 Specified layout: Indicate the wiring specifications on the manifold specification sheet. (Note that 2-position double, 3-position, and 4-position valves cannot be used where single wiring has been specified.)

* The blanking plate assembly is included in this number.

④ P, E port entry

U	U side (2 to 10 stations)
D	D side (2 to 10 stations)
B	Both sides (2 to 20 stations)

⑤ SUP/EXH block assembly

Nil	Internal pilot
S	Internal pilot, Built-in silencer
R	External pilot

* The 3/5(E) port is plugged for the built-in silencer type.

* When the built-in silencer type is used, keep the exhaust port from coming into direct contact with water or other liquids.

⑦ Mounting

Symbol	Mounting	Option	
		Name plate	Station number
Nil	Direct mounting	—	—
AA		●	●
BA		●	—
D	DIN rail mounting	—	—
A		●	●
B		●	—

* Enter the number of stations inside when it is larger than the number of valve stations. (Refer to "DIN Rail Option" below.)

* Only direct mounting is available for the type 11 bottom-porting type.

DIN Rail Option

Nil	Direct mounting	
0	Without DIN rail (with bracket)	
3	For 3 stations	Specify a longer rail than the total length of specified stations.
⋮	⋮	
20	For 20 stations	

⑥ A, B port size (Metric)

Symbol	A, B port	Type 10/ Side ported		Type 11/ Bottom ported	
		SY5000	SY7000	SY5000	SY7000
C4	Straight	●	—	●	—
C6		●	●	●	●
C8		●	●	●	●
C10		—	●	—	●
C12		—	●	—	●
CM*1	Straight port, mixed sizes	●	●	●	●
P, E port size (One-touch fittings)		ø10	ø12	ø10	ø12

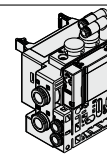

*1 Indicate the sizes on the manifold specification sheet for "CM."

* The direction of P, E port fittings is the same as for the A, B port.

* The 25A- series specifications and dimensions are the same as those of the standard model.

For details, refer to the **Web Catalog**.

How to Order Valves (With mounting screw)

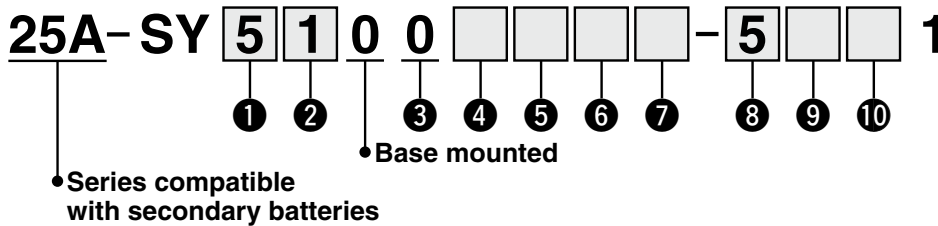

1 Series

5	SY5000
7	SY7000

2 Type of actuation

1	2-position single
2	2-position double
3	3-position closed center
4	3-position exhaust center
5	3-position pressure center
A	4-position dual 3-port valve (N.C./N.C.)
B	4-position dual 3-port valve (N.O./N.O.)
C	4-position dual 3-port valve (N.C./N.O.)

3 Seal type

0	Rubber seal
---	-------------

4 Pilot type

Nil	Internal pilot
R	External pilot

* When selecting the external pilot specification for the 4-position dual 3-port valve, pay attention to the pilot pressure. For details, refer to the valve specifications of the standard SY series product in the **Web Catalog**.

5 Back pressure check valve (Built-in valve type)

Nil	None
H	Built-in

* The built-in valve type back pressure check valve is not available for the 3-position type or the SY7000.

6 Pilot valve option

Nil	Standard (0.7 MPa)
B	Quick response type (0.7 MPa)

7 Coil type

Nil	Standard
T	With power-saving circuit (Continuous duty type)

* Be sure to select the power-saving circuit type if the valve is to be continuously energized for long periods of time.
* Be careful of the energizing time when the power-saving circuit is selected. For details, refer to the standard product catalog.

8 Rated voltage

5	24 VDC
6	12 VDC

9 Light/surge voltage suppressor and common specification

Nil	Without light/surge voltage suppressor (Non-polar)
R	With surge voltage suppressor (Non-polar)
U	With light/surge voltage suppressor (Non-polar)
S	With surge voltage suppressor (Positive common)
Z	With light/surge voltage suppressor (Positive common)
NS	With surge voltage suppressor (Negative common)
NZ	With light/surge voltage suppressor (Negative common)

* Only "Z" and "NZ" types are available with a power-saving circuit.

10 Manual override

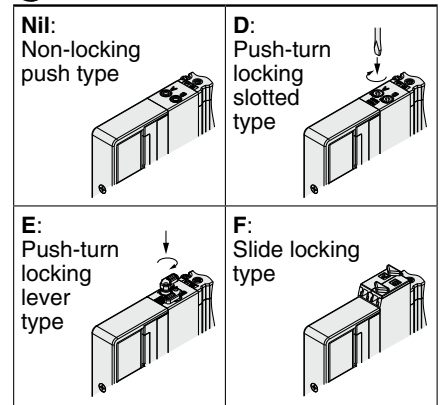

* The 25A- series specifications and dimensions are the same as those of the standard model.

For details, refer to the **Web Catalog**.

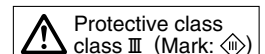

How to Order Valves (With mounting screw)

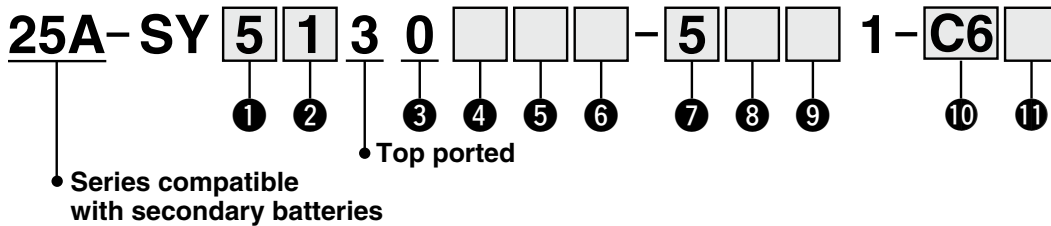

1 Series

5	SY5000
7	SY7000

2 Type of actuation

1	2-position single
2	2-position double
3	3-position closed center
4	3-position exhaust center
5	3-position pressure center
A	4-position dual 3-port valve (N.C./N.C.)
B	4-position dual 3-port valve (N.O./N.O.)
C	4-position dual 3-port valve (N.C./N.O.)

3 Seal type

0	Rubber seal
---	-------------

4 Back pressure check valve (Built-in valve type)

Nil	None
H	Built-in

* The built-in valve type back pressure check valve is not available for the 3-position type or the SY7000.

5 Pilot valve option

Nil	Standard (0.7 MPa)
B	Quick response type (0.7 MPa)

6 Coil type

Nil	Standard
T	With power-saving circuit (Continuous duty type)

* Be sure to select the power-saving circuit type if the valve is to be continuously energized for long periods of time.
* Be careful of the energizing time when the power-saving circuit is selected. For details, refer to the standard product catalog.

7 Rated voltage

5	24 VDC
6	12 VDC

8 Light/surge voltage suppressor and common specification

Nil	Without light/surge voltage suppressor (Non-polar)
R	With surge voltage suppressor (Non-polar)
U	With light/surge voltage suppressor (Non-polar)
S	With surge voltage suppressor (Positive common)
Z	With light/surge voltage suppressor (Positive common)
NS	With surge voltage suppressor (Negative common)
NZ	With light/surge voltage suppressor (Negative common)

* Only "Z" and "NZ" types are available with a power-saving circuit.

9 Manual override

<p>Nil: Non-locking push type</p>	<p>D: Push-turn locking slotted type</p>
<p>E: Push-turn locking lever type</p>	<p>F: Slide locking type</p>

10 A, B port size Thread piping

Symbol	Port size	Applicable series
02	1/4	SY7000

One-touch fitting (Metric)

Symbol	A, B port	SY5000	SY7000
C4	ø4	●	—
C6	ø6	●	●
C8	ø8	●	●
C10	ø10	—	●
C12	ø12	—	●

11 Thread type

Nil	Rc
F	G
N	NPT
T	NPTF

* The 25A- series specifications and dimensions are the same as those of the standard model.

For details, refer to the Web Catalog.

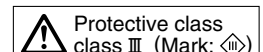

Directional Control Valves
Air Cylinders
Related Products
Rotary Actuators
Air Grippers
Vacuum Equipment
Air Preparation Equipment
Clean Air Filters
Modular F.R.L./Pressure Control Equipment
Flow Control Equipment/Fittings
Detection Switches
Fluid Control Equipment
Process Gas Equipment
Electric Actuators
Auto Switches

Type 10
Side Ported

Type 11
Bottom Ported

Plug-in Connector Connecting Base

Lead Wire

25A-SY5000/7000 Series



How to Order Manifolds

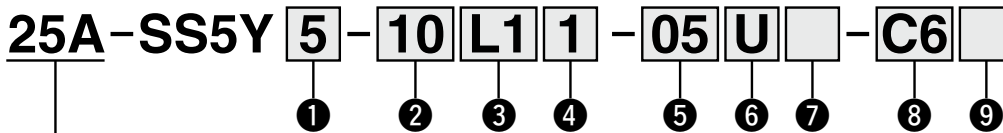

Series compatible with secondary batteries

① Series

5	SY5000
7	SY7000

② Type

10	Side ported
11	Bottom ported

③ Number of cores (Lead wire)

L1	34 cores
L2	17 cores
L3	9 cores

④ Lead wire length

1	0.6 m
2	1.5 m
3	3 m

⑥ P, E port entry

U	U side (2 to 10 stations)
D	D side (2 to 10 stations)
B	Both sides (2 to 24 stations)

⑦ SUP/EXH block assembly

Nil	Internal pilot
S	Internal pilot, Built-in silencer
R	External pilot

* The 3/5(E) port is plugged for the built-in silencer type.
* When the built-in silencer type is used, keep the exhaust port from coming into direct contact with water or other liquids.

⑤ Valve stations

(L1□)

Symbol	Stations	Note
02	2 stations	Double wiring*1
⋮	⋮	
16	16 stations	Specified layout*2 (Up to 32 solenoids available)
02	2 stations	
⋮	⋮	
24	24 stations	

(L3□)

Symbol	Stations	Note
02	2 stations	Double wiring*1
⋮	⋮	
04	4 stations	Specified layout*2 (Up to 8 solenoids available)
02	2 stations	
⋮	⋮	
08	8 stations	

(L2□)

Symbol	Stations	Note
02	2 stations	Double wiring*1
⋮	⋮	
08	8 stations	Specified layout*2 (Up to 16 solenoids available)
02	2 stations	
⋮	⋮	
16	16 stations	

*1 Double wiring: 2-position single, 2-position double, 3-position, and 4-position valves can be used on all manifold stations. The use of a 2-position single solenoid will result in an unused control signal. If this is not desired, order with a specified layout.

*2 Specified layout: Indicate the wiring specifications on the manifold specification sheet. (Note that 2-position double, 3-position, and 4-position valves cannot be used where single wiring has been specified.)

* The blanking plate assembly is included in this number.

⑧ A, B port size (Metric)

Symbol	A, B port	Type 10/Side ported		Type 11/Bottom ported		
		SY5000	SY7000	SY5000	SY7000	
C4 C6 C8 C10 C12	Straight	ø4	●	—	●	
		ø6	●	●	●	
		ø8	●	●	●	
		ø10	—	●	—	●
		ø12	—	●	—	●
CM*1	Straight port, mixed sizes	●	●	●	●	
P, E port size (One-touch fittings)		ø10	ø12	ø10	ø12	

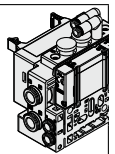

*1 Indicate the sizes on the manifold specification sheet for "CM."
* The direction of P, E port fittings is the same as for the A, B port.

⑨ Mounting

Symbol	Mounting	Option	
		Name plate	Station number
Nil	Direct mounting	—	—
AA		●	●
BA		●	—
D□	DIN rail mounting	—	—
A□		●	●
B□		●	—

* Enter the number of stations inside □ when it is larger than the number of valve stations. (Refer to "DIN Rail Option" below.)
* Only direct mounting is available for the type 11 bottom ported type.

DIN Rail Option

Symbol	Mounting	Option
Nil	Direct mounting	
0	Without DIN rail (with bracket)	
3	For 3 stations	Specify a longer rail than the total length of specified stations.
⋮	⋮	
24	For 24 stations	

* The 25A- series specifications and dimensions are the same as those of the standard model.

For details, refer to the Web Catalog.

How to Order Valves (With mounting screw)

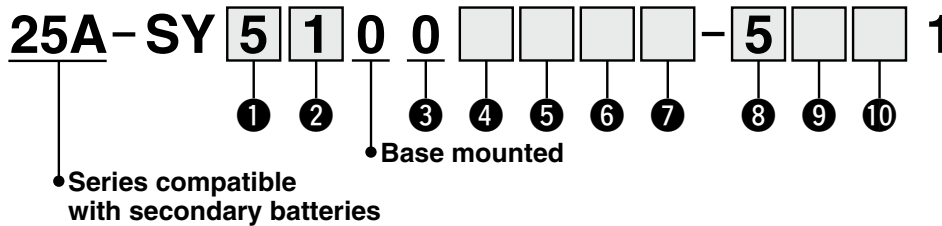

① Series

5	SY5000
7	SY7000

② Type of actuation

1	2-position single
2	2-position double
3	3-position closed center
4	3-position exhaust center
5	3-position pressure center
A	4-position dual 3-port valve (N.C./N.C.)
B	4-position dual 3-port valve (N.O./N.O.)
C	4-position dual 3-port valve (N.C./N.O.)

③ Seal type

0	Rubber seal
---	-------------

④ Pilot type

Nil	Internal pilot
R	External pilot

* When selecting the external pilot specification for the 4-position dual 3-port valve, pay attention to the pilot pressure. For details, refer to the valve specifications of the standard SY series product in the **Web Catalog**.

⑤ Back pressure check valve (Built-in valve type)

Nil	None
H	Built-in

* The built-in valve type back pressure check valve is not available for the 3-position type or the SY7000.

⑥ Pilot valve option

Nil	Standard (0.7 MPa)
B	Quick response type (0.7 MPa)

⑦ Coil type

Nil	Standard
T	With power-saving circuit (Continuous duty type)

* Be sure to select the power-saving circuit type if the valve is to be continuously energized for long periods of time.
* Be careful of the energizing time when the power-saving circuit is selected. For details, refer to the standard product catalog.

⑧ Rated voltage

5	24 VDC
6	12 VDC

⑨ Light/surge voltage suppressor and common specification

Nil	Without light/surge voltage suppressor (Non-polar)
R	With surge voltage suppressor (Non-polar)
U	With light/surge voltage suppressor (Non-polar)
S	With surge voltage suppressor (Positive common)
Z	With light/surge voltage suppressor (Positive common)
NS	With surge voltage suppressor (Negative common)
NZ	With light/surge voltage suppressor (Negative common)

* Only "Z" and "NZ" types are available with a power-saving circuit.

⑩ Manual override

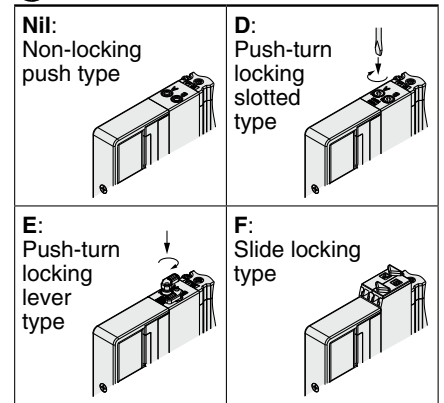

* The 25A- series specifications and dimensions are the same as those of the standard model.

For details, refer to the **Web Catalog**.

Plug-in Connector Connecting Base

Lead Wire



Type 12
Top Ported

25A-SY5000/7000 Series

How to Order Manifolds

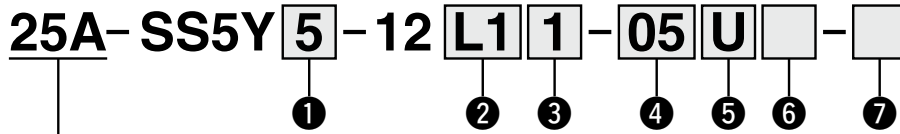

• Series compatible with secondary batteries

1 Series

5	SY5000
7	SY7000

2 Number of cores (Lead wire)

L1	34 cores
L2	17 cores
L3	9 cores

3 Lead wire length

1	0.6 m
2	1.5 m
3	3 m

4 Valve stations

(L1□)

Symbol	Stations	Note
02	2 stations	Double wiring*1
⋮	⋮	
16	16 stations	Specified layout*2 (Up to 32 solenoids available)
02	2 stations	
⋮	⋮	
24	24 stations	

(L3□)

Symbol	Stations	Note
02	2 stations	Double wiring*1
⋮	⋮	
04	4 stations	Specified layout*2 (Up to 8 solenoids available)
02	2 stations	
⋮	⋮	
08	8 stations	

(L2□)

Symbol	Stations	Note
02	2 stations	Double wiring*1
⋮	⋮	
08	8 stations	Specified layout*2 (Up to 16 solenoids available)
02	2 stations	
⋮	⋮	
16	16 stations	

*1 Double wiring: 2-position single, 2-position double, 3-position, and 4-position valves can be used on all manifold stations. The use of a 2-position single solenoid will result in an unused control signal. If this is not desired, order with a specified layout.

*2 Specified layout: Indicate the wiring specifications on the manifold specification sheet. (Note that 2-position double, 3-position, and 4-position valves cannot be used where single wiring has been specified.)

* The blanking plate assembly is included in this number.

5 P, E port entry

U*1	U side (2 to 10 stations)
D*1	D side (2 to 10 stations)
B	Both sides (2 to 24 stations)

*1 6 For type "S," SUP/EXH block assembly with a built-in silencer, choose "U" or "D" for P port entry.

6 SUP/EXH block assembly

Nil	Internal pilot
S	Internal pilot, Built-in silencer

* The P and E ports are only available on the U and D sides for the built-in silencer type. The 3/5(E) port is plugged. The silencer exhaust port is located on the opposite side of the P and E port entry. (Example: When the P and E port entry is on the D side, the silencer exhaust port is on the U side.)

* When the built-in silencer type is used, keep the exhaust port from coming into direct contact with water or other liquids.

7 Mounting

Nil	Direct mounting	
D	DIN rail mounting (With DIN rail)	
D0	DIN rail mounting (Without DIN rail)	
D3	For 3 stations	Specify a length longer than that of the standard rail.
⋮	⋮	
D24	For 24 stations	

* The 25A- series specifications and dimensions are the same as those of the standard model.

For details, refer to the **Web Catalog**.

How to Order Valves (With mounting screw)

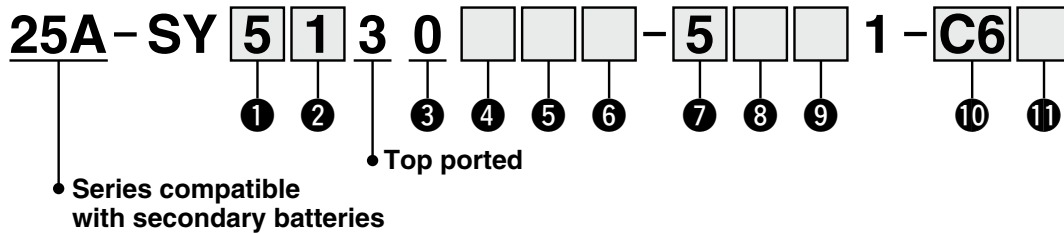

1 Series

5	SY5000
7	SY7000

2 Type of actuation

1	2-position single
2	2-position double
3	3-position closed center
4	3-position exhaust center
5	3-position pressure center
A	4-position dual 3-port valve (N.C./N.C.)
B	4-position dual 3-port valve (N.O./N.O.)
C	4-position dual 3-port valve (N.C./N.O.)

3 Seal type

0	Rubber seal
---	-------------

4 Back pressure check valve (Built-in valve type)

Nil	None
H	Built-in

* The built-in valve type back pressure check valve is not available for the 3-position type or the SY7000.

5 Pilot valve option

Nil	Standard (0.7 MPa)
B	Quick response type (0.7 MPa)

6 Coil type

Nil	Standard
T	With power-saving circuit (Continuous duty type)

* Be sure to select the power-saving circuit type if the valve is to be continuously energized for long periods of time.
* Be careful of the energizing time when the power-saving circuit is selected. For details, refer to the standard product catalog.

7 Rated voltage

5	24 VDC
6	12 VDC

8 Light/surge voltage suppressor and common specification

Nil	Without light/surge voltage suppressor (Non-polar)
R	With surge voltage suppressor (Non-polar)
U	With light/surge voltage suppressor (Non-polar)
S	With surge voltage suppressor (Positive common)
Z	With light/surge voltage suppressor (Positive common)
NS	With surge voltage suppressor (Negative common)
NZ	With light/surge voltage suppressor (Negative common)

* Only "Z" and "NZ" types are available with a power-saving circuit.

9 Manual override

<p>Nil: Non-locking push type</p>	<p>D: Push-turn locking slotted type</p>
<p>E: Push-turn locking lever type</p>	<p>F: Slide locking type</p>

10 A, B port size Thread piping

Symbol	Port size	Applicable series
02	1/4	SY7000

One-touch fitting (Metric)

Symbol	A, B port	SY5000	SY7000
C4	ø4	●	—
C6	ø6	●	●
C8	ø8	●	●
C10	ø10	—	●
C12	ø12	—	●

11 Thread type

Nil	Rc
F	G
N	NPT
T	NPTF

* The 25A- series specifications and dimensions are the same as those of the standard model.

For details, refer to the Web Catalog.

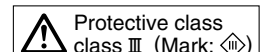

Directional Control Valves
Air Cylinders
Related Products
Rotary Actuators
Air Grippers
Vacuum Equipment
Air Preparation Equipment
Clean Air Filters
Modular F.R.L./Pressure Control Equipment
Flow Control Equipment/Fittings
Detection Switches
Fluid Control Equipment
Process Gas Equipment
Electric Actuators
Auto Switches

Type 10
Side Ported

Type 11
Bottom Ported

Plug-in Connector Connecting Base

EX260

25A-SY5000/7000 Series



How to Order Manifolds

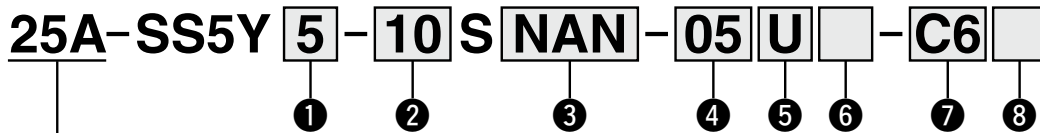

• Series compatible with secondary batteries

① Series

5	SY5000
7	SY7000

② Type

10	Side ported
11	Bottom ported

③ SI unit specifications

(Output polarity, Protocol, Number of outputs, Communication connector)

Symbol (Output polarity)		Protocol	Number of outputs	Communication connector
Positive common (NPN)	Negative common (PNP)			
0 Without SI unit				
QA	QAN	DeviceNet®	32	M12
QB	QBN		16	
NA	NAN	PROFIBUS DP	32	M12
NB	NBN		16	
VA	VAN	CC-Link	32	M12
VB	VBN		16	
DA	DAN	EtherCAT	32	M12
DB	DBN		16	
FA	FAN	PROFINET	32	M12
FB	FBN		16	
EA	EAN	EtherNet/IP™	32	M12
EB	EBN		16	
—	KAN	IO-Link	32	M12

- * Without SI unit, the output polarity is decided by the SI unit used. Ensure a match with the common specification of the valves to be used.
- * DIN rail cannot be mounted without SI unit.
- * For IO-Link, only the negative common (PNP) type and the 32 outputs type are available.

⑦ A, B port size (Metric)

Symbol	A, B port	Type 10/Side ported		Type 11/Bottom ported	
		SY5000	SY7000	SY5000	SY7000
C4	∅4	●	—	●	—
C6	∅6	●	●	●	●
C8	∅8	●	●	●	●
C10	∅10	—	●	—	●
C12	∅12	—	●	—	●
CM ¹	Straight port, mixed sizes	●	●	●	●
P, E port size (One-touch fittings)		∅10	∅12	∅10	∅12

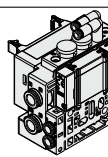

*1 Indicate the sizes on the manifold specification sheet for "CM."

④ Valve stations

In the case of the 32-output SI unit

Symbol	Stations	Note
02	2 stations	Double wiring*1
⋮	⋮	
16	16 stations	Specified layout*2 (Up to 32 solenoids available)
02	2 stations	
⋮	⋮	
24	24 stations	

In the case of the 16-output SI unit

Symbol	Stations	Note
02	2 stations	Double wiring*1
⋮	⋮	
08	8 stations	Specified layout*2 (Up to 16 solenoids available)
02	2 stations	
⋮	⋮	
16	16 stations	

- *1 Double wiring: 2-position single, 2-position double, 3-position, and 4-position valves can be used on all manifold stations. The use of a 2-position single solenoid will result in an unused control signal. If this is not desired, order with a specified layout.
- *2 Specified layout: Indicate the wiring specifications on the manifold specification sheet. (Note that 2-position double, 3-position, and 4-position valves cannot be used where single wiring has been specified.)
- * The blanking plate assembly is included in this number.
- * For the model without the SI unit (S0), note the maximum number of solenoids of the SI unit that will be mounted. If the layout is specified, indicate it on the manifold specification sheet.

⑤ P, E port entry

U	U side (2 to 10 stations)
D	D side (2 to 10 stations)
B	Both sides (2 to 24 stations)

⑥ SUP/EXH block assembly

Nil	Internal pilot
S	Internal pilot, Built-in silencer
R	External pilot

- * The 3/5(E) port is plugged for the built-in silencer type.
- * When the built-in silencer type is used, keep the exhaust port from coming into direct contact with water or other liquids.

⑧ Mounting

Symbol	Mounting	Option	
		Name plate	Station number
Nil	Direct mounting	—	—
AA		●	●
BA		●	—
D□	DIN rail mounting	—	—
A□		●	●
B□		●	—

- * Enter the number of stations inside □ when it is larger than the number of valve stations. (Refer to "DIN Rail Option" below.)
- * Only direct mounting is available for the type 11 bottom ported type.

DIN Rail Option

Nil	Direct mounting
0	Without DIN rail (with bracket)
3	For 3 stations
⋮	⋮
24	For 24 stations

- * The 25A-series specifications and dimensions are the same as those of the standard model.

For details, refer to the **Web Catalog**.

For details on the EX260 Integrated Type (For Output) Serial Transmission System, refer to the **Web Catalog** and the **Operation Manual**. For the part numbers of the SI units to be mounted, refer to page 53 in this catalog. Please download the **Operation Manual** via the SMC website: <https://www.smcworld.com>

How to Order Valves (With mounting screw)

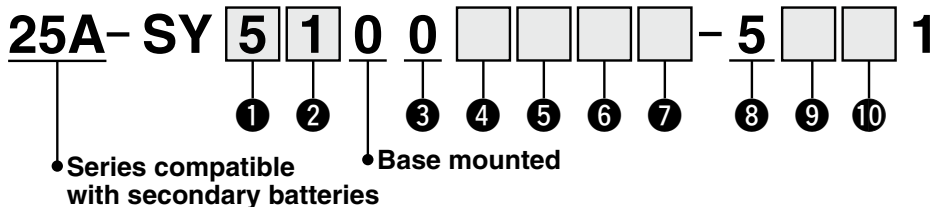

1 Series

5	SY5000
7	SY7000

2 Type of actuation

1	2-position single
2	2-position double
3	3-position closed center
4	3-position exhaust center
5	3-position pressure center
A	4-position dual 3-port valve (N.C./N.C.)
B	4-position dual 3-port valve (N.O./N.O.)
C	4-position dual 3-port valve (N.C./N.O.)

3 Seal type

0	Rubber seal
---	-------------

4 Pilot type

Nil	Internal pilot
R	External pilot

* When selecting the external pilot specification for the 4-position dual 3-port valve, pay attention to the pilot pressure. For details, refer to the valve specifications of the standard SY series product in the **Web Catalog**.

5 Back pressure check valve (Built-in valve type)

Nil	None
H	Built-in

* The built-in valve type back pressure check valve is not available for the 3-position type or the SY7000.

6 Pilot valve option

Nil	Standard (0.7 MPa)
B	Quick response type (0.7 MPa)

7 Coil type

Nil	Standard
T	With power-saving circuit (Continuous duty type)

* Be sure to select the power-saving circuit type if the valve is to be continuously energized for long periods of time.
* Be careful of the energizing time when the power-saving circuit is selected. For details, refer to the standard product catalog.

8 Rated voltage

5	24 VDC
---	--------

9 Light/surge voltage suppressor and common specification

R	With surge voltage suppressor (Non-polar)
U	With light/surge voltage suppressor (Non-polar)
S	With surge voltage suppressor (Positive common)
Z	With light/surge voltage suppressor (Positive common)
NS	With surge voltage suppressor (Negative common)
NZ	With light/surge voltage suppressor (Negative common)

* Select "R," "U," "S," or "Z" for the valve when the SI unit output polarity is Nil (positive common). Select "R," "U," "NS," or "NZ" for the valve when the SI unit output polarity is N (negative common).
* Only "Z" and "NZ" types are available with a power-saving circuit.

10 Manual override

<p>Nil: Non-locking push type</p>	<p>D: Push-turn locking slotted type</p>
<p>E: Push-turn locking lever type</p>	<p>F: Slide locking type</p>

* The 25A- series specifications and dimensions are the same as those of the standard model.

For details, refer to the **Web Catalog**.

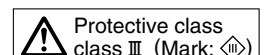

Directional Control Valves
Air Cylinders
Related Products
Rotary Actuators
Air Grippers
Vacuum Equipment
Air Preparation Equipment
Clean Air Filters
Modular F.R.L./Pressure Control Equipment
Flow Control Equipment/Fittings
Detection Switches
Fluid Control Equipment
Process Gas Equipment
Electric Actuators
Auto Switches

Plug-in Connector Connecting Base

EX260



Type 12
Top Ported

25A-SY5000/7000 Series

How to Order Manifolds



• Series compatible with secondary batteries

① Series

5	SY5000
7	SY7000

② SI unit specifications

(Output polarity, Protocol, Number of outputs, Communication connector)

Symbol (Output polarity)		Protocol	Number of outputs	Communication connector
Positive common (NPN)	Negative common (PNP)			
0		Without SI unit		
QA	QAN	DeviceNet®	32	M12
QB	QBN		16	
NA	NAN	PROFIBUS DP	32	M12
NB	NBN		16	
VA	VAN	CC-Link	32	M12
VB	VBN		16	
DA	DAN	EtherCAT	32	M12
DB	DBN		16	
FA	FAN	PROFINET	32	M12
FB	FBN		16	
EA	EAN	EtherNet/IP™	32	M12
EB	EBN		16	
—	KAN	IO-Link	32	M12

- * Without SI unit, the output polarity is decided by the SI unit used. Ensure a match with the common specification of the valves to be used.
- * DIN rail cannot be mounted without SI unit.
- * For IO-Link, only the negative common (PNP) type and the 32 outputs type are available.

③ Valve stations

In the case of the 32-output SI unit

Symbol	Stations	Note
02	2 stations	Double wiring*1
⋮	⋮	
16	16 stations	Specified layout*2 (Up to 32 solenoids available)
02	2 stations	
⋮	⋮	
24	24 stations	

In the case of the 16-output SI unit

Symbol	Stations	Note
02	2 stations	Double wiring*1
⋮	⋮	
08	8 stations	Specified layout*2 (Up to 16 solenoids available)
02	2 stations	
⋮	⋮	
16	16 stations	

- *1 Double wiring: 2-position single, 2-position double, 3-position, and 4-position valves can be used on all manifold stations. The use of a 2-position single solenoid will result in an unused control signal. If this is not desired, order with a specified layout.
- *2 Specified layout: Indicate the wiring specifications on the manifold specification sheet. (Note that 2-position double, 3-position, and 4-position valves cannot be used where single wiring has been specified.)
- * The blanking plate assembly is included in this number.
- * For the model without the SI unit (S0), note the maximum number of solenoids of the SI unit that will be mounted. If the layout is specified, indicate it on the manifold specification sheet.

④ P, E port entry

U*1	U side (2 to 10 stations)
D*1	D side (2 to 10 stations)
B	Both sides (2 to 24 stations)

*1 ⑤ For type “S,” SUP/EXH block assembly with a built-in silencer, choose “U” or “D” for P port entry.

⑤ SUP/EXH block assembly

Nil	Internal pilot
S	Internal pilot, Built-in silencer

- * The P and E ports are only available on the U and D sides for the built-in silencer type. The 3/5(E) port is plugged. The silencer exhaust port is located on the opposite side of the P and E port entry. (Example: When the P and E port entry is on the D side, the silencer exhaust port is on the U side.)
- * When the built-in silencer type is used, keep the exhaust port from coming into direct contact with water or other liquids.

⑥ Mounting

Nil	Direct mounting	
D	DIN rail mounting (With DIN rail)	
D0	DIN rail mounting (Without DIN rail)	
D3	For 3 stations	Specify a length longer than that of the standard rail.
⋮	⋮	
D24	For 24 stations	

* If the DIN rail must be mounted without an SI unit, select D0. Then, refer to L3 of the dimensions for the DIN rail length and order separately.

* The 25A- series specifications and dimensions are the same as those of the standard model.

For details, refer to the **Web Catalog**.

For details on the EX260 Integrated Type (For Output) Serial Transmission System, refer to the **Web Catalog** and the **Operation Manual**. For the part numbers of the SI units to be mounted, refer to page 53 in this catalog. Please download the Operation Manual via the SMC website: <https://www.smcworld.com>

How to Order Valves (With mounting screw)

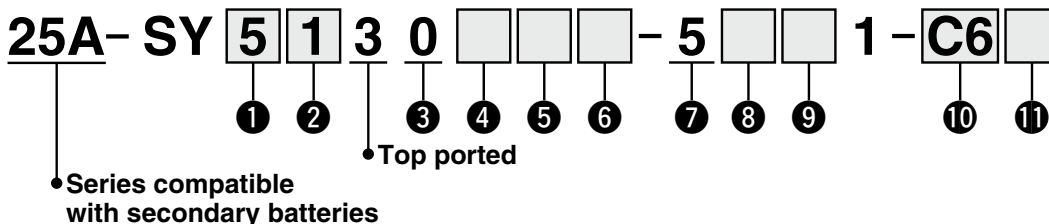

1 Series

5	SY5000
7	SY7000

2 Type of actuation

1	2-position single
2	2-position double
3	3-position closed center
4	3-position exhaust center
5	3-position pressure center
A	4-position dual 3-port valve (N.C./N.C.)
B	4-position dual 3-port valve (N.O./N.O.)
C	4-position dual 3-port valve (N.C./N.O.)

3 Seal type

0	Rubber seal
---	-------------

4 Back pressure check valve (Built-in valve type)

Nil	None
H	Built-in

* The built-in valve type back pressure check valve is not available for the 3-position type or the SY7000.

5 Pilot valve option

Nil	Standard (0.7 MPa)
B	Quick response type (0.7 MPa)

6 Coil type

Nil	Standard
T	With power-saving circuit (Continuous duty type)

* Be sure to select the power-saving circuit type if the valve is to be continuously energized for long periods of time.
* Be careful of the energizing time when the power-saving circuit is selected. For details, refer to the standard product catalog.

7 Rated voltage

5	24 VDC
---	--------

8 Light/surge voltage suppressor and common specification

R	With surge voltage suppressor (Non-polar)
U	With light/surge voltage suppressor (Non-polar)
S	With surge voltage suppressor (Positive common)
Z	With light/surge voltage suppressor (Positive common)
NS	With surge voltage suppressor (Negative common)
NZ	With light/surge voltage suppressor (Negative common)

* Select "R," "U," "S," or "Z" for the valve when the SI unit output polarity is Nil (positive common). Select "R," "U," "NS," or "NZ" for the valve when the SI unit output polarity is N (negative common).
* Only "Z" and "NZ" types are available with a power-saving circuit.

9 Manual override

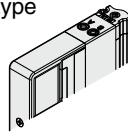
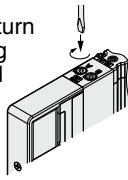
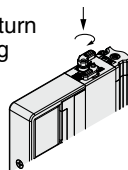
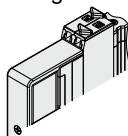
<p>Nil: Non-locking push type</p> 	<p>D: Push-turn locking slotted type</p> 
<p>E: Push-turn locking lever type</p> 	<p>F: Slide locking type</p> 

10 A, B port size

Symbol	Port size	Applicable series
02	1/4	SY7000

One-touch fitting (Metric)

Symbol	A, B port	SY5000	SY7000
C4	ø4	●	—
C6	ø6	●	●
C8	ø8	●	●
C10	ø10	—	●
C12	ø12	—	●

11 Thread type

Nil	Rc
F	G
N	NPT
T	NPTF

* The 25A- series specifications and dimensions are the same as those of the standard model.

For details, refer to the **Web Catalog**.

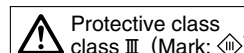

Directional Control Valves
 Air Cylinders
 Related Products
 Rotary Actuators
 Air Grippers
 Vacuum Equipment
 Air Preparation Equipment
 Clean Air Filters
 Modular F.R.L./Pressure Control Equipment
 Flow Control Equipment/Fittings
 Detection Switches
 Fluid Control Equipment
 Process Gas Equipment
 Electric Actuators
 Auto Switches

Type 10
Side Ported

Type 11
Bottom Ported

Plug-in Connector Connecting Base

EX126

25A-SY5000/7000 Series



How to Order Manifolds

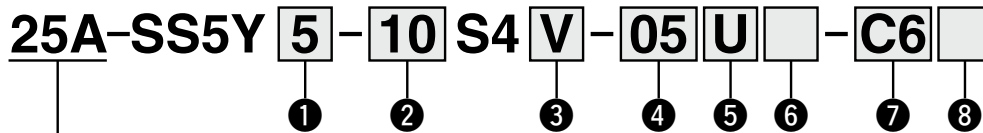

• Series compatible with secondary batteries

① Series

5	SY5000
7	SY7000

② Type

10	Side ported
11	Bottom ported

③ SI unit

0	Without SI unit
V	CC-Link (Positive common NPN)

* Only a terminal block plate is mounted for the valve without SI unit.
For SI unit part numbers, refer to page 53.

④ Valve stations

Symbol	Stations	Note
02	2 stations	Double wiring*1
⋮	⋮	
08	8 stations	
02	2 stations	Specified layout*2 (Up to 16 solenoids available)
⋮	⋮	
16	16 stations	

*1 Double wiring: 2-position single, 2-position double, 3-position, and 4-position valves can be used on all manifold stations.
The use of a 2-position single solenoid will result in an unused control signal. If this is not desired, order with a specified layout.

*2 Specified layout: Indicate the wiring specifications on the manifold specification sheet. (Note that 2-position double, 3-position, and 4-position valves cannot be used where single wiring has been specified.)

* The blanking plate assembly is included in this number.

⑤ P, E port entry

U	U side (2 to 10 stations)
D	D side (2 to 10 stations)
B	Both sides (2 to 16 stations)

⑥ SUP/EXH block assembly

Nil	Internal pilot
S	Internal pilot, Built-in silencer
R	External pilot

* The 3/5(E) port is plugged for the built-in silencer type.

* When the built-in silencer type is used, keep the exhaust port from coming into direct contact with water or other liquids.

⑧ Mounting

Symbol	Mounting	Option	
		Name plate	Station number
Nil	Direct mounting	—	—
AA		●	●
BA		●	—
D	DIN rail mounting	—	—
A		●	●
B		●	—

* Enter the number of stations inside when it is larger than the number of valve stations. (Refer to "DIN Rail Option" below.)
* Only direct mounting is available for the type 11 bottom-porting type.

DIN Rail Option

Nil	Direct mounting
0	Without DIN rail (with bracket)
3	For 3 stations
⋮	⋮
16	For 16 stations

Specify a longer rail than the total length of specified stations.

⑦ A, B port (Metric)

Symbol	A, B port	Type 10/ Side ported		Type 11/ Bottom ported	
		SY5000	SY7000	SY5000	SY7000
C4	Straight	●	—	●	—
C6		●	●	●	●
C8		●	●	●	●
C10		—	●	—	●
C12		—	●	—	●
CM*1	Straight port, mixed sizes	●	●	●	●
P, E port size (One-touch fittings)		ø10	ø12	ø10	ø12

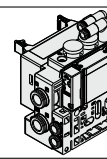

*1 Indicate the sizes on the manifold specification sheet for "CM."

* The direction of P, E port fittings is the same as for the A, B port.

* The 25A-series specifications and dimensions are the same as those of the standard model.

For details, refer to the **Web Catalog**.

For details on the EX126 Integrated Type (For Output) Serial Transmission System, refer to the **Web Catalog** and the **Operation Manual**. For the part numbers of the SI units to be mounted, refer to page 53 in this catalog. Please download the Operation Manual via the SMC website: <https://www.smcworld.com>

How to Order Valves (With mounting screw)

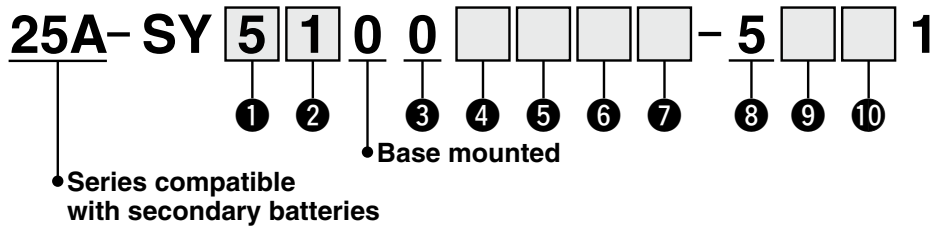

1 Series

5	SY5000
7	SY7000

2 Type of actuation

1	2-position single
2	2-position double
3	3-position closed center
4	3-position exhaust center
5	3-position pressure center
A	4-position dual 3-port valve (N.C./N.C.)
B	4-position dual 3-port valve (N.O./N.O.)
C	4-position dual 3-port valve (N.C./N.O.)

3 Seal type

0	Rubber seal
---	-------------

4 Pilot type

Nil	Internal pilot
R	External pilot

* When selecting the external pilot specification for the 4-position dual 3-port valve, pay attention to the pilot pressure. For details, refer to the valve specifications of the standard SY series product in the **Web Catalog**.

5 Back pressure check valve (Built-in valve type)

Nil	None
H	Built-in

* The built-in valve type back pressure check valve is not available for the 3-position type or the SY7000.

6 Pilot valve option

Nil	Standard (0.7 MPa)
B	Quick response type (0.7 MPa)

7 Coil type

Nil	Standard
T	With power-saving circuit (Continuous duty type)

* Be sure to select the power-saving circuit type if the valve is to be continuously energized for long periods of time.
 * Be careful of the energizing time when the power-saving circuit is selected. For details, refer to the standard product catalog.

8 Rated voltage

5	24 VDC
---	--------

9 Light/surge voltage suppressor and common specification

R	With surge voltage suppressor (Non-polar)
U	With light/surge voltage suppressor (Non-polar)
S	With surge voltage suppressor (Positive common)
Z	With light/surge voltage suppressor (Positive common)

* Only "Z" type is available with a power-saving circuit.

10 Manual override

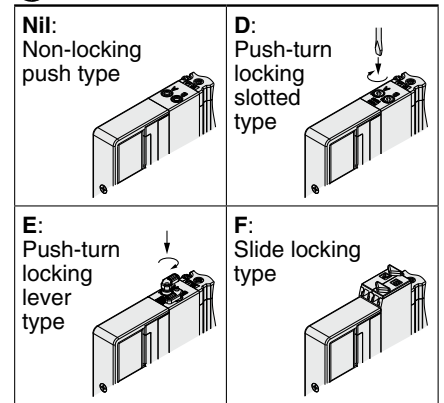

* The 25A- series specifications and dimensions are the same as those of the standard model.

For details, refer to the **Web Catalog**.

Plug-in Connector Connecting Base

EX126



Type 12
Top Ported

25A-SY5000/7000 Series



How to Order Manifolds

25A - SS5Y

5

 - 12S4

V

 -

05

U

--

 -

--

① ② ③ ④ ⑤ ⑥

Series compatible with secondary batteries

① Series

5	SY5000
7	SY7000

② SI unit

0	Without SI unit
V	CC-Link (Positive common NPN)

* Only a terminal block plate is mounted for the valve without SI unit. For SI unit part numbers, refer to page 53.

③ Valve stations

Symbol	Stations	Note
02	2 stations	Double wiring*1
:	:	
:	:	
08	8 stations	Specified layout*2 (Up to 16 solenoids available)
02	2 stations	
:	:	
:	:	
16	16 stations	

- *1 Double wiring: 2-position single, 2-position double, 3-position, and 4-position valves can be used on all manifold stations. The use of a 2-position single solenoid will result in an unused control signal. If this is not desired, order with a specified layout.
- *2 Specified layout: Indicate the wiring specifications on the manifold specification sheet. (Note that 2-position double, 3-position, and 4-position valves cannot be used where single wiring has been specified.)
- * The blanking plate assembly is included in this number.

④ P, E port entry

U*1	U side (2 to 10 stations)
D*1	D side (2 to 10 stations)
B	Both sides (2 to 16 stations)

*1 For type "S," SUP/EXH block assembly with a built-in silencer, choose "U" or "D" for P port entry.

⑤ SUP/EXH block assembly

Nil	Internal pilot
S	Internal pilot, Built-in silencer

- * The P and E ports are only available on the U and D sides for the built-in silencer type. The 3/5(E) port is plugged. The silencer exhaust port is located on the opposite side of the P and E port entry. (Example: When the P and E port entry is on the D side, the silencer exhaust port is on the U side.)
- * When the built-in silencer type is used, keep the exhaust port from coming into direct contact with water or other liquids.

⑥ Mounting

Nil	Direct mounting	
D	DIN rail mounting (With DIN rail)	
D0	DIN rail mounting (Without DIN rail)	
D3	For 3 stations	Specify a length longer than that of the standard rail.
:	:	
D16	For 16 stations	

* The 25A-series specifications and dimensions are the same as those of the standard model.

For details, refer to the **Web Catalog**.

For details on the EX126 Integrated Type (For Output) Serial Transmission System, refer to the **Web Catalog** and the **Operation Manual**. For the part numbers of the SI units to be mounted, refer to page 53 in this catalog. Please download the **Operation Manual** via the SMC website: <https://www.smcworld.com>

How to Order Valves (With mounting screw)

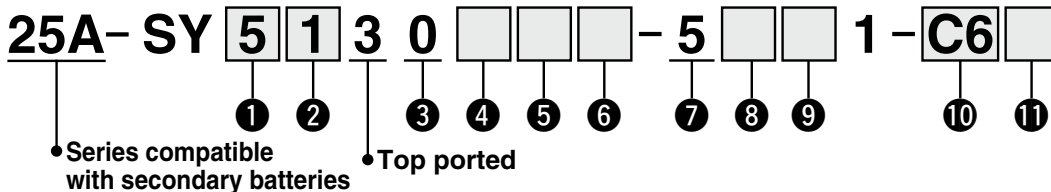

① Series

5	SY5000
7	SY7000

② Type of actuation

1	2-position single
2	2-position double
3	3-position closed center
4	3-position exhaust center
5	3-position pressure center
A	4-position dual 3-port valve (N.C./N.C.)
B	4-position dual 3-port valve (N.O./N.O.)
C	4-position dual 3-port valve (N.C./N.O.)

③ Seal type

0	Rubber seal
---	-------------

④ Back pressure check valve (Built-in valve type)

Nil	None
H	Built-in

* The built-in valve type back pressure check valve is not available for the 3-position type or the SY7000.

⑤ Pilot valve option

Nil	Standard (0.7 MPa)
B	Quick response type (0.7 MPa)

⑥ Coil type

Nil	Standard
T	With power-saving circuit (Continuous duty type)

* Be sure to select the power-saving circuit type if the valve is to be continuously energized for long periods of time.
* Be careful of the energizing time when the power-saving circuit is selected. For details, refer to the standard product catalog.

⑦ Rated voltage

5	24 VDC
---	--------

⑧ Light/surge voltage suppressor and common specification

R	With surge voltage suppressor (Non-polar)
U	With light/surge voltage suppressor (Non-polar)
S	With surge voltage suppressor (Positive common)
Z	With light/surge voltage suppressor (Positive common)

* Only "Z" type is available with a power-saving circuit.

⑨ Manual override

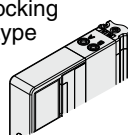
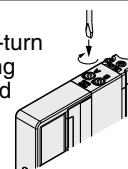
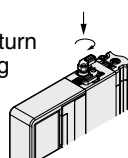
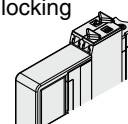
<p>Nil: Non-locking push type</p> 	<p>D: Push-turn locking slotted type</p> 
<p>E: Push-turn locking lever type</p> 	<p>F: Slide locking type</p> 

⑩ A, B port size

Thread piping

Symbol	Port size	Applicable series
02	1/4	SY7000

One-touch fitting (Metric)

Symbol	A, B port	SY5000	SY7000
C4	ø4	●	—
C6	ø6	●	●
C8	ø8	●	●
C10	ø10	—	●
C12	ø12	—	●

⑪ Thread type

Nil	Rc
F	G
N	NPT
T	NPTF

* The 25A- series specifications and dimensions are the same as those of the standard model.
For details, refer to the **Web Catalog**.

⚠ Caution

Tightening torque for mounting screw
M3: 0.8 N·m

Manifold Options

■ Blanking plate assembly

(With mounting screw)

Used when valve additions are expected or for maintenance. A structure is in place on the blanking plate to prevent the mounting screws from sliding.

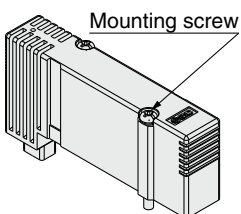

25A-SY50M-26-1A

How to Order Blanking Plate Assembly

25A-SY 5 0M-26- 1 A

Series	
5	SY5000
7	SY7000

• Base type

1	For plug-in connector connecting base
---	---------------------------------------

* The 25A- series specifications and dimensions are the same as those of the standard model.

For details, refer to the **Web Catalog**.

Directional Control Valves
 Air Cylinders
 Related Products
 Rotary Actuators
 Air Grippers
 Vacuum Equipment
 Air Preparation Equipment
 Clean Air Filters
 Modular F.R.L./Pressure Control Equipment
 Flow Control Equipment/Fittings
 Detection Switches
 Fluid Control Equipment
 Process Gas Equipment
 Electric Actuators
 Auto Switches

25A-SY5000/7000 Series

SI Unit Part Nos.

Description	SI unit part no.	Note
EX260 SI unit	EX260-SPR1-X117	PROFIBUS DP M12 connector, 32 outputs, Negative common (PNP)
	EX260-SPR2-X117	PROFIBUS DP M12 connector, 32 outputs, Positive common (NPN)
	EX260-SPR3-X117	PROFIBUS DP M12 connector, 16 outputs, Negative common (PNP)
	EX260-SPR4-X117	PROFIBUS DP M12 connector, 16 outputs, Positive common (NPN)
	EX260-SDN1-X117	DeviceNet® M12 connector, 32 outputs, Negative common (PNP)
	EX260-SDN2-X117	DeviceNet® M12 connector, 32 outputs, Positive common (NPN)
	EX260-SDN3-X117	DeviceNet® M12 connector, 16 outputs, Negative common (PNP)
	EX260-SDN4-X117	DeviceNet® M12 connector, 16 outputs, Positive common (NPN)
	EX260-SEC1-X117	EtherCAT M12 connector, 32 outputs, Negative common (PNP)
	EX260-SEC2-X117	EtherCAT M12 connector, 32 outputs, Positive common (NPN)
	EX260-SEC3-X117	EtherCAT M12 connector, 16 outputs, Negative common (PNP)
	EX260-SEC4-X117	EtherCAT M12 connector, 16 outputs, Positive common (NPN)
	EX260-SMJ1-X117	CC-Link M12 connector, 32 outputs, Negative common (PNP)
	EX260-SMJ2-X117	CC-Link M12 connector, 32 outputs, Positive common (NPN)
	EX260-SMJ3-X117	CC-Link M12 connector, 16 outputs, Negative common (PNP)
	EX260-SMJ4-X117	CC-Link M12 connector, 16 outputs, Positive common (NPN)
	EX260-SPN1-X117	PROFINET M12 connector, 32 outputs, Negative common (PNP)
	EX260-SPN2-X117	PROFINET M12 connector, 32 outputs, Positive common (NPN)
	EX260-SPN3-X117	PROFINET M12 connector, 16 outputs, Negative common (PNP)
	EX260-SPN4-X117	PROFINET M12 connector, 16 outputs, Positive common (NPN)
EX126 SI unit	EX260-SEN1-X117	EtherNet/IP™ M12 connector, 32 outputs, Negative common (PNP)
	EX260-SEN2-X117	EtherNet/IP™ M12 connector, 32 outputs, Positive common (NPN)
	EX260-SEN3-X117	EtherNet/IP™ M12 connector, 16 outputs, Negative common (PNP)
	EX260-SEN4-X117	EtherNet/IP™ M12 connector, 16 outputs, Positive common (NPN)
	EX260-SIL1-X117	IO-Link M12 connector, 32 outputs, Negative common (PNP)
	EX126D-SMJ1-X220	CC-Link (Terminal block, 16 outputs, Positive common (NPN))

Valve Mounting Screw Part No.

Description	Part no.		Note
	SY5000	SY7000	
Round head combination screw	SY5000-223-1A	SY7000-224-1A	Part numbers shown on the left are for 10 valves. (SY5000: 20 pcs./SY7000: 30 pcs.)

One-touch Fittings Part Nos.

Port size		25A-SY5000	25A-SY7000
A, B port	Metric size		
	ø4 One-touch fitting (Straight type)	90-VVQ1000-51A-C4	—
	ø6 One-touch fitting (Straight type)	90-VVQ1000-51A-C6	25A-KJH06-17-X1607
	ø8 One-touch fitting (Straight type)	90-VVQ1000-51A-C8	90-VVQ2000-51A-C8
	ø10 One-touch fitting (Straight type)	—	90-VVQ2000-51A-C10
P, E port	Metric size		
	ø10 One-touch fitting (Straight type)	90-VVQ2000-51A-C10	—
	ø12 One-touch fitting (Straight type)	—	90-VVQ4000-50B-C12

Manifold Options

How to Order Individual SUP/EXH Spacer Assembly

One-touch fitting
Straight type

25A-SY 5 0M-38-1 A-C6

Series

5	SY5000
7	SY7000

Spacer type

38	Individual SUP spacer
39	Individual EXH spacer

Port size (Metric)

Symbol	P, E port	SY5000	SY7000
C4	ø4	●	—
C6	ø6	●	●
C8	ø8	●	●
C10	ø10	—	●
C12	ø12	—	●

Part numbers of mounting screw

SY5000: SY5000-223-2A (2 pcs. of each)

SY7000: SV1000-136-12A (3 pcs. of each)

How to Order Individual SUP/EXH Block Assembly

One-touch fitting
Straight type

25A-SY 5 0M-78-1 A-C6

Series

5	SY5000
7	SY7000

Block type

78	Individual SUP block
79	Individual EXH block

Port size (Metric)

Symbol	P, E port	SY5000	SY7000
C4	ø4	●	—
C6	ø6	●	●
C8	ø8	●	●
C10	ø10	—	●
C12	ø12	—	●

Manifold Parts Nos.

Ⓐ Manifold block assembly

25A – SY 5 0M – 2 – 1 D A – C6

Series

5	SY5000
7	SY7000

Piping direction

1	Side/Top ported
2	Bottom ported

Wiring type

S	Single wiring
D	Double wiring

A, B port size (One-touch fittings)

Symbol	A, B port	SY5000	SY7000	Note
C4	ø4	●	—	Side/Bottom ported Metric size
C6	ø6	●	●	
C8	ø8	●	●	
C10	ø10	—	●	
C12	ø12	—	●	Top ported
00	Plug	●	●	

Ⓑ SUP/EXH block assembly

① D-sub connector <IP40>

25A – SY 5 0M – 1 – 11 A [] 1 – C10 – []

Series

5	SY5000
7	SY7000

SUP/EXH block assembly

11	D-sub connector <IP40>
----	------------------------

Pilot, Silencer/Piping type

Symbol	Pilot type		Built-in silencer	Piping direction
	Internal	External		
Nil	●	—	—	Side
S	●	—	●	
R	—	●	—	
V	●	—	—	Top
VP	●	—	●*1	
B	●	—	—	Bottom
BS	●	—	●	
BR	—	●	—	

*1 For silencer (supply side)
E port is plugged.

Mounting

Nil	Direct mounting
D0	DIN rail mounting (Without DIN rail)

* For the bottom-porting type, the symbol is nil.

P, E port size (One-touch fittings)

Symbol	P, E port	SY5000	SY7000	Note
C10	ø10	●	—	Side/Bottom/Top ported Metric size
C12	ø12	—	●	
00*2	Plug	●	●	P/E port entry on one side or Top ported

*2 It can be selected only if no symbol or "S" or "V" or "B" is selected
for the pilot and the piping.

Connector entry direction

1	Upward
2	Lateral

Clamp bracket assembly

Series	Part no.
25A-SY5000/7000	25A-SY50M-15-3A

* Part number is for one assembly.

② Terminal block box

25A – SY 5 0M – 1 – 1A [] – C10 – []

Series

5	SY5000
7	SY7000

Pilot, Silencer/Piping type

Symbol	Pilot type		Built-in silencer	Piping direction
	Internal	External		
Nil	●	—	—	Side
S	●	—	●	
R	—	●	—	
V	●	—	—	Top
VP	●	—	●*3	
B	●	—	—	Bottom
BS	●	—	●	
BR	—	●	—	

*3 For silencer (supply side)
E port is plugged.

Mounting

Nil	Direct mounting
D0	DIN rail mounting (Without DIN rail)

* For the bottom-porting type, the symbol is nil.

P, E port size (One-touch fittings)

Symbol	P, E port	SY5000	SY7000	Note
C10	ø10	●	—	Side/Bottom/Top ported Metric size
C12	ø12	—	●	
00*4	Plug	●	●	P/E port entry on one side or Top ported

*4 It can be selected only if no symbol or "S" or "V" or "B" is selected
for the pilot and the piping.

Terminal block box housing assembly

25A – VVQC1000 – T0 – 1

Clamp bracket assembly for terminal block box

25A – SY30M – 15 – 6A

* Part number is for one assembly.

Clamp bracket assembly

Series	Part no.
25A-SY5000/7000	25A-SY50M-15-3A

* Part number is for one assembly.

Directional Control Valves
 Air Cylinders
 Related Products
 Rotary Actuators
 Air Grippers
 Vacuum Equipment
 Air Preparation Equipment
 Clean Air Filters
 Modular F.R.L./Pressure Control Equipment
 Flow Control Equipment/Fittings
 Detection Switches
 Fluid Control Equipment
 Process Gas Equipment
 Electric Actuators
 Auto Switches

25A-SY5000/7000 Series

Manifold Parts Nos.

③ Lead wire

25A - SY **5** 0M - 1 - 1A - **C10** -

Series

5	SY5000
7	SY7000

Mounting

Nil	Direct mounting
D0	DIN rail mounting (Without DIN rail)

* For the bottom-ported type, the symbol is nil.

Pilot, Silencer/Piping type

Symbol	Pilot type		Built-in silencer	Piping direction
	Internal	External		
Nil	●	—	—	Side
S	●	—	●	
R	—	●	—	
V	●	—	—	Top
VP	●	—	●*1	
B	●	—	—	Bottom
BS	●	—	●	
BR	—	●	—	

*1 For silencer (supply side) E port is plugged.

P, E port size (One-touch fittings)

Symbol	P, E port	SY5000	SY7000	Note
C10	ø10	●	—	Side/Bottom/Top ported Metric size
C12	ø12	—	●	
00*2	Plug	●	●	P/E port entry on one side or Top ported

*2 It can be selected only if no symbol or "S" or "V" or "B" is selected for the pilot and the piping.

Lead wire connector block assembly

25A - SY30M - 14 - 4A - -

Number of cores

1	34
2	17
3	9

Lead wire length [m]

1	0.6
2	1.5
3	3

Clamp bracket assembly

Series	Part no.
25A-SY5000/7000	25A-SY50M-15-3A

* Part number is for one assembly.

④ EX126

25A - SY **5** 0M - 1 - 1A - **C10** -

Series

5	SY5000
7	SY7000

Mounting

Nil	Direct mounting
D0	DIN rail mounting (Without DIN rail)

* For the bottom-ported type, the symbol is nil.

Pilot, Silencer/Piping type

Symbol	Pilot type		Built-in silencer	Piping direction
	Internal	External		
Nil	●	—	—	Side
S	●	—	●	
R	—	●	—	
V	●	—	—	Top
VP	●	—	●*3	
B	●	—	—	Bottom
BS	●	—	●	
BR	—	●	—	

*3 For silencer (supply side) E port is plugged.

P, E port size (One-touch fittings)

Symbol	P, E port	SY5000	SY7000	Note
C10	ø10	●	—	Side/Bottom/Top ported Metric size
C12	ø12	—	●	
00*4	Plug	●	●	P/E port entry on one side or Top ported

*4 It can be selected only if no symbol or "S" or "V" or "B" is selected for the pilot and the piping.

Terminal block plate assembly

25A - VVQC1000 - 74A - 2

Clamp bracket assembly for EX126 SI unit

25A - SY30M - 15 - 6A

* Part number is for one assembly.

Clamp bracket assembly

Series	Part no.
25A-SY5000/7000	25A-SY50M-15-3A

* Part number is for one assembly.

Manifold Parts Nos.

⑤ EX260

25A-SY 5 0M-1-1A - **C10** -

Series ●

5	SY5000
7	SY7000

Pilot, Silencer/Piping type ●

Symbol	Pilot type		Built-in silencer	Piping direction
	Internal	External		
Nil	●	—	—	Side
S	●	—	●	
R	—	●	—	
V	●	—	—	Top
VP	●	—	●*5	
B	●	—	—	Bottom
BS	●	—	●	
BR	—	●	—	

*5 For silencer (supply side) E port is plugged.

Mounting ●

Nil	Direct mounting
D0	DIN rail mounting (Without DIN rail)

* For the bottom-ported type, the symbol is nil.

● P, E port size (One-touch fittings)

Symbol	P, E port	SY5000	SY7000	Note
C10	ø10	●	—	Side/Bottom/Top ported Metric size
C12	ø12	—	●	
00*6	Plug	●	●	P/E port entry on one side or Top ported

*6 It can be selected only if no symbol or "S" or "V" or "B" is selected for the pilot and the piping.

Clamp bracket assembly

Series	Part no.
25A-SY5000/7000	25A-SY50M-15-3A

* Part number is for one assembly.

Directional
Control Valves

Air Cylinders

Related
Products

Rotary
Actuators

Air Grippers

Vacuum
Equipment

Air Preparation
Equipment

Clean
Air Filters

Modular F.R.L./
Pressure Control
Equipment

Flow Control
Equipment/
Fittings

Detection
Switches

Fluid Control
Equipment

Process Gas
Equipment

Electric
Actuators

Auto
Switches

Manifold Parts Nos.

◎ SUP/EXH block assembly

25A - SY **5** 0M - 3 - 1A - **C10** -

Series ●

5	SY5000
7	SY7000

Pilot, Silencer/Piping type ●

Symbol	Pilot type		Built-in silencer	Piping direction
	Internal	External		
Nil	●	—	—	Side
S	●	—	●	
R	—	●	—	
V	●	—	—	Top
VP	●	—	●*1	
B	●	—	—	Bottom
BS	●	—	●	
BR	—	●	—	

*1 For silencer (supply side) E port is plugged.

* "B" for the bottom-ported type can be selected for the SY5000/7000 series.

● Mounting

Nil	Direct mounting
D0	DIN rail mounting (Without DIN rail)

* For the bottom-ported type, the symbol is nil.

● P, E port size (One-touch fittings)

Symbol	P, E port	SY5000	SY7000	Note
C10	ø10	●	—	Side/Bottom/Top ported Metric size
C12	ø12	—	●	
00*2	Plug	●	●	P/E port entry on one side or Top ported

*2 It can be selected only if no symbol or "S" or "V" or "B" is selected for the pilot and the piping.

■ Cover assembly/Silencer cover assembly/Port block assembly for SUP/EXH (end) block assembly

Cover assembly
(Internal pilot)

25A - SY **5** 0M - 4 - 1 A

Silencer cover assembly
(Internal pilot, Built-in silencer)

25A - SY **5** 0M - 5 - 1 A

Port block assembly
(Side ported, External pilot)

25A - SY **5** 0M - 6 - 1 AR - 00

A, B port
One-touch fittings piping direction ●

Nil	Straight (Side ported)
-----	------------------------

X, PE port One-touch fitting type ●

Symbol	X, PE port	SY5000	SY7000
		Nil	Metric size
	ø6		—
		ø6	●

Port block assembly
(Top ported, Internal pilot, for silencer (supply side))

25A - SY **5** 0M - 6 - 3 AV - **C10**

Port block assembly
(Top ported, Internal pilot)

25A - SY **5** 0M - 6 - 1 A V - **C10**

Series ●

5	SY5000
7	SY7000

Pilot type ●

Nil	Internal pilot
-----	----------------

P, E port size (One-touch fittings) ●

Symbol	P, E port	SY5000	SY7000
C10	ø10	●	—
C12	ø12	—	●

■ Name plate bracket assembly (For SY5000 only)

25A - SY50M - 85 - 1A

Directional Control Valves

Air Cylinders

Related Products

Rotary Actuators

Air Grippers

Vacuum Equipment

Air Preparation Equipment

Clean Air Filters

Modular F.R.L./Pressure Control Equipment

Flow Control Equipment/Fittings

Detection Switches

Fluid Control Equipment

Process Gas Equipment

Electric Actuators

Auto Switches

25A-SY5000/7000 Series Valve Replacement Parts

How to Order Pilot Valves

Pilot cover
25A-SY50V-25A

25A-V112 - **5** **A**

Pilot valve option

Nil	Standard (0.7 MPa)
B	Quick response type (0.7 MPa)

Rated voltage

5	24 VDC
6	12 VDC

Coil type

Nil	Standard
T	With power-saving circuit (Made to Order)

How to Order Port Block Assembly

25A-SY **0V-6A** - -

Series

5	5000
7	7000

Thread type

Nil	Rc
F	G
N	NPT
T	NPTF

Pilot type

Nil	Internal pilot
------------	----------------

Option for mounting

Nil	Standard (Valve mounting screw without drop prevention)
1	Drop prevention type valve mounting screw

A, B port size

Thread piping

Symbol	Port size	Applicable series
02	1/4	SY7000

Metric size (One-touch fitting)

Symbol	Port size	Applicable series	
		SY5000	SY7000
C4	ø4	●	—
C6	ø6	●	●
C8	ø8	●	●
C10	ø10	—	●
C12	ø12	—	●

Body Cover Assembly

* Used when the top-ported type is changed to the side or bottom-ported type

Series		Part no.	
		Standard (Valve mounting screw without drop prevention)	Drop prevention type valve mounting screw
SY5000	Internal pilot	25A-SY50V-16A	25A-SY50V-16A-1
	External pilot	25A-SY50V-16AR	25A-SY50V-16AR-1
SY7000	Internal pilot	25A-SY70V-16A	25A-SY70V-16A-1
	External pilot	25A-SY70V-16AR	25A-SY70V-16AR-1

* The part number is not indicated on the product.

25A-SY5000/7000 Series

With Residual Pressure Release Valve

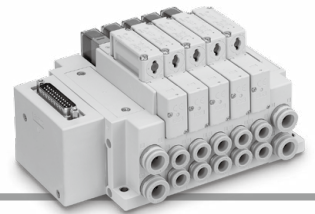

How to Order (With mounting screw)

25A-SY **5** **3** **0** **0** - **5** **1** - **E**

5	SY5000
7	SY7000

3	3-position closed center*1
----------	----------------------------

*1 Only the closed center type is available.

● **Base mounted**
(The top-ported type is not available.)

● **With residual pressure release valve**

E	With residual pressure release valve*2
----------	--

*2 Mounting screw types, hexagon socket head cap screw B and drop prevention type K, H are not available.

Protective class class III (Mark:)

1 Seal type

0	Rubber seal
----------	-------------

2 Pilot valve option

Nil	Standard (0.7 MPa)
B	Quick response type (0.7 MPa)

3 Coil type

Nil	Standard
T	With power saving circuit (Continuous duty type)

* Be sure to select the power saving circuit type if the valve is to be continuously energized for long periods of time.

* Be careful of the energizing time when the power saving circuit is selected. Refer to the **Web Catalog** for details.

4 Rated voltage

5	24 VDC
6	12 VDC

* The applicable rated voltage varies depending on the manifold wiring type. Refer to the "How to Order Manifolds" pages.

5 Light/surge voltage suppressor and common specification

Symbol	With light	Surge voltage suppressor	Common specification
Nil	—	—	Non-polar
R	—	—	
U	●	●	Positive common
S	—		
Z	●		
NS	—	●	Negative common
NZ	●		

* Only "Z" and "NZ" types are available with a power saving circuit.

6 Manual override

<p>Nil: Non-locking push type</p>	<p>D: Push-turn locking slotted type</p>
<p>E: Push-turn locking lever type</p>	<p>F: Slide locking type</p>

Table 1. Valve mounting screw

SY5000	SY7000
SY5000-221-9A (2 pcs.)	SY7000-221-14A (3 pcs.)

Directional Control Valves

Air Cylinders

Related Products

Rotary Actuators

Air Grippers

Vacuum Equipment

Air Preparation Equipment

Clean Air Filters

Modular F.R.L./Pressure Control Equipment

Flow Control Equipment/Fittings

Detection Switches

Fluid Control Equipment

Process Gas Equipment

Electric Actuators

Auto Switches

25A-SY5000/7000 Series

Made to Order

Please contact SMC for detailed dimensions, specifications, and lead times.



1 With Safety Slide Locking Manual Override

Symbol
-X13

A safety lock is added to the slide locking manual override.

25A-SY $\frac{5}{7}$ 00 - G1-X13

- Entry is the same as 25A-standard products. Specifications and performance are the same as standard products.

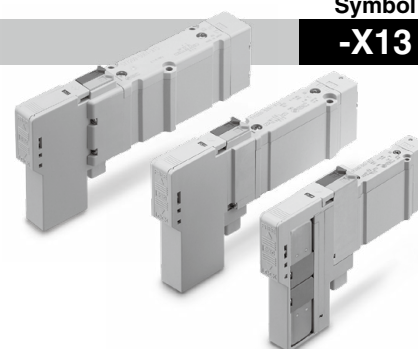

2 2-Position Single Solenoid Valve with Built-in Return Spring

Symbol
-X350

A 2-position single solenoid valve with a spring built into the main valve
The main valve returns to origin (the OFF position) via the spring when it is not pressurized.

25A-SY $\frac{5}{7}$ 1 $\frac{0}{3}$ 0 - 1-X350

- Entry is the same as 25A-standard products. Specifications and performance are the same as standard products.

* For the external pilot type, exhaust the external pilot (X) port and the main pressure simultaneously.
If the main pressure cannot be exhausted due to the system specifications, please contact SMC separately.

* The manual option is only applicable to the non-locking push type.

Internal pilot type

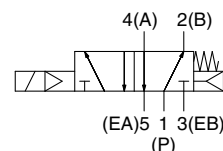

External pilot type

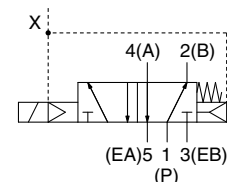

25A-SY5000/7000 Series

Plug-in Single Unit/Sub-plate Type [IP67 Compliant]

(Side ported, Bottom ported, Top ported)

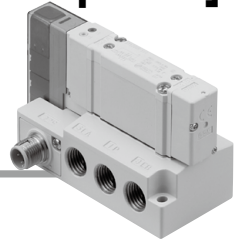

How to Order

In the case of (Valve) + (Sub-plate) (Built-in valve type part no.)

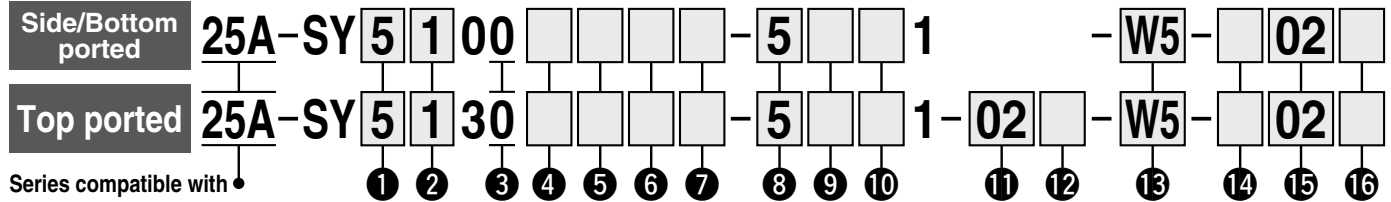

1 Series

5	SY5000
7	SY7000

2 Type of actuation

1	2-position	Single
2		Double
3	3-position	Closed center
4		Exhaust center
5		Pressure center
A	4-position dual 3-port	N.C./N.C.
B		N.O./N.O.
C		N.C./N.O.

3 Seal type

0	Rubber seal
---	-------------

4 Pilot type

Nil	Internal pilot
R	External pilot

5 Back pressure check valve (Built-in valve type)

Nil	None
H	Built-in

* The built-in valve type back pressure check valve is not available for the 3-position type or the SY7000.

6 Pilot valve option

Nil	Standard (0.7 MPa)
B	Quick response type (0.7 MPa)

7 Coil type

Nil	Standard
T	With power saving circuit (Continuous duty type)

* Be sure to select the power saving circuit type if the valve is to be continuously energized for long periods of time.

* Be careful of the energizing time when the power saving circuit is selected. For details, refer to the standard product catalog.

8 Rated voltage

5	24 VDC
6	12 VDC

9 Light/surge voltage suppressor and common specification

Symbol	With light	Surge voltage suppressor	Common specification
Nil	—	—	Non-polar
R	—	●	
U	●		
S	—		Positive common
Z	●		
NS	—	Negative common	
NZ	●		

* Only "Z" and "NZ" types are available with a power saving circuit.

10 Manual override

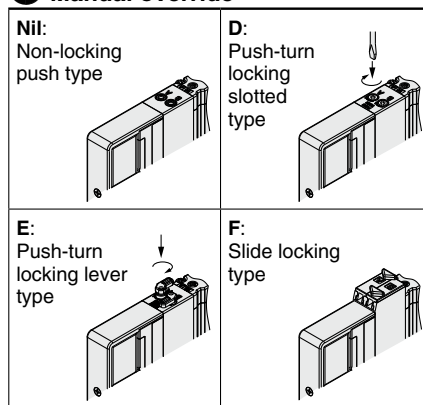

11 A, B port size (* Top-ported valve only)

Symbol	Port size	Applicable series
02	1/4	SY7000

Metric size (One-touch fitting)

Symbol	A, B port	SY5000	SY7000
C4	ø4	●	—
C6	ø6	●	●
C8	ø8	●	●
C10	ø10	—	●
C12	ø12	—	●

12 A, B port thread type (Thread piping)

Nil	Rc
F	G

13 Wiring specifications (Sub-plate)

WO	Without M12 connector cable
W5	With M12 connector cable (3000 mm)

* When ordering a product with M12 connector cable, the connector cable is included.

14 Port location (Sub-plate)

Nil	Side ported
B	Bottom ported
V*1	Top ported (1P, 5EA, 3EB port: Side ported)

*1 Only available for the valve piping type "3" top ported

15 Port size (Sub-plate)

Symbol	Port size	Applicable series
02	1/4	SY5000
03	3/8	SY7000

16 Thread type (Sub-plate)

Nil	Rc
F	G

* The 25A- series specifications and dimensions are the same as those of the standard model.

* When mounting a special order (including Made-to-Order specification) valve or manifold option (spacer, etc.) on the sub-plate, add the valve part number or spacer part number under the sub-plate part number to place an order. For details, refer to the ordering example on page 57-4.

25A-SY5000/7000 Series

How to Order

In the case of **Sub-plate** (Sub-plate single unit part no.)

* Without valve

25A-SY **5** **0M-27-1-** **W5** - **02**

Series compatible with secondary batteries

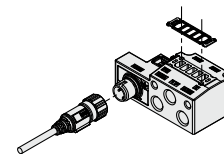

* Base gasket is included.
* Valve mounting screws are not included.

1 Series

5	SY5000
7	SY7000

3 Port location (Sub-plate)

Nil	Side ported
B	Bottom ported
V	Top ported [1(P), 5(EA), 3(EB) port: Side ported]

5 Sub-plate thread type

Nil	Rc
F	G

2 Wiring specifications

WO	Without M12 connector cable
W5	With M12 connector cable (3000 mm)

* Refer to the table below for connector cable part numbers.
* When ordering a product with M12 connector cable, the connector cable is included.

4 Port size (Sub-plate)

Symbol	Port size	Applicable series
02	1/4	SY5000
03	3/8	SY7000

How to Order when mounting a special order (including Made-to-Order specification) valve on the sub-plate (Ordering example: X350)

25A-SY50M-27-1-W5-02 1 set (Sub-plate single unit part no.)
***25A-SY5100-5U1-X350** 1 set (Built-in return spring specification)

Ordering example when mounting a manifold option (spacer, etc.)

25A-SY50M-27-1-W5-02 1 set (Sub-plate single unit part no.)
***25A-SY5400-5U1** 1 set (3-position exhaust center part no.)
***25A-SY50M-39-1A-C6** 1 set (Individual EXH spacer part no.)

Sub-plate Parts Nos.

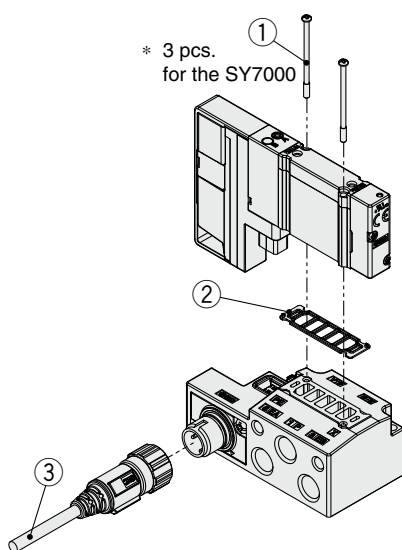

* 3 pcs. for the SY7000

No.	Description	Part no.		Note
		SY5000	SY7000	
①	Round head combination screw	SY5000-223-1A (M3 x 32.5)	SY7000-224-1A (M3 x 36.5)	Part numbers shown on the left are for 10 valves (20 pcs.). (30 pcs. for the SY7000)
②	Base gasket (for sub-plate)	SY50M-11-1A	SY70M-11-1A	Part numbers shown on the left are for 10 valves (10 pcs.).
③	M12 waterproof connector cable	90-ZS-37-A-X258		Cable length: 3000 mm

Auto Switches	Electric Actuators	Process Gas Equipment	Fluid Control Equipment	Detection Switches	Flow Control Equipment/Fittings	Modular F.R.L./Pressure Control Equipment	Clean Air Filters	Air Preparation Equipment	Vacuum Equipment	Air Grippers	Rotary Actuators	Related Products	Air Cylinders	Directional Control Valves
---------------	--------------------	-----------------------	-------------------------	--------------------	---------------------------------	---	-------------------	---------------------------	------------------	--------------	------------------	------------------	---------------	----------------------------

5-Port Solenoid Valve Body Ported/Single Unit



25A-SY5000/7000 Series

How to Order



25A - SY 5 1 20 [] - 5 L [] [] - 01 [] - [] - []

Series compatible with secondary batteries

Series

5	SY5000
7	SY7000

Type of actuation

1	2-position single
2	2-position double
3	3-position closed center
4	3-position exhaust center
5	3-position pressure center

Coil specifications

Nil	Standard
T	With power-saving circuit (24, 12 VDC only)

* Power-saving circuit is not available in the case of "D" or "Y" type.

For DC

5	24 VDC
6	12 VDC
V	6 VDC
S	5 VDC
R	3 VDC

Rated voltage

For AC (50/60Hz)

1	100 VAC
2	200 VAC
3	110 VAC [115 VAC]
4	220 VAC [230 VAC]

* DC specifications of type "D" and "Y" are only available with 12 and 24 VDC.

* AC-type models that are CE/UKCA-compliant have DIN terminals only.

Electrical entry

24, 12, 6, 5, 3 VDC/100, 110, 200, 220 VAC				24, 12 VDC/100, 110, 200, 220 VAC
Grommet	L plug connector	M plug connector	MN: Without lead wire	D, Y: With connector
G: With lead wire (Length 300 mm)	L: With lead wire (Length 300 mm)	M: With lead wire (Length 300 mm)	MN: Without lead wire	D, Y: With connector
H: With lead wire (Length 600 mm)	LN: Without lead wire	LO: Without connector	MO: Without connector	

- * "LN," "MN" type: with 2 sockets.
- * "Y" type is a DIN terminal conforming to EN-175301-803C (former DIN43650C).
- * Refer to the standard products for the lead wire length of L and M plug connectors and the connector assembly with cover for L and M plug connector.

CE/UKCA-compliant

Nil	—
Q	CE/UKCA-compliant

* AC-type models that are CE/UKCA-compliant have DIN terminals only.

Bracket

Nil	Without bracket
F1	With foot bracket (2-position single only)
F2	With side bracket

Thread type

Nil	Rc
F	G

A, B port size Thread piping

Symbol	Port size	Applicable series
01	1/8	SY5000
02	1/4	SY7000

One-touch fitting (Metric size)

Symbol	Port size	Applicable series
C4	One-touch fitting for $\phi 4$	SY5000
C6	One-touch fitting for $\phi 6$	
C8	One-touch fitting for $\phi 8$	
C8	One-touch fitting for $\phi 8$	SY7000
C10	One-touch fitting for $\phi 10$	

Manual override

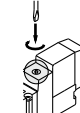
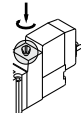
<p>Nil: Non-locking push type</p> 	<p>D: Push-turn locking slotted type</p> 	<p>E: Push-turn locking lever type</p> 
--	--	--

Light/surge voltage suppressor

Electrical entry for G, H, L, M		Electrical entry for D, Y	
Nil	Without light/surge voltage suppressor	Nil	Without light/surge voltage suppressor
S	With surge voltage suppressor	S	With surge voltage suppressor
Z	With light/surge voltage suppressor	Z	With light/surge voltage suppressor
R	With surge voltage suppressor (Non-polar type)	* There is no "S" type for AC mode, since a rectifier prevents surge voltage generation.	
U	With light/surge voltage suppressor (Non-polar type)		

* There is no "S" type for AC mode, since a rectifier prevents surge voltage generation.
 * For "R" and "U," DC voltage is only available.
 * Power-saving circuit is only available in the "Z" type.

* When placing an order for body ported solenoid valve as a single unit, mounting screw for manifold and gasket are not attached. Order them separately, if necessary.

* The 25A- series specifications and dimensions are the same as those of the standard model.

For details, refer to the Web Catalog.

5-Port Solenoid Valve Base Mounted/Single Unit



25A-SY5000/7000 Series

How to Order

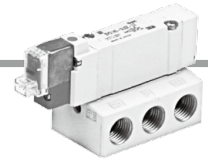

25A - SY 5 2 40 [] [] - 5 L [] [] - [] [] - []

Series compatible with secondary batteries

Series

5	SY5000
7	SY7000

Type of actuation

1	2-position single
2	2-position double
3	3-position closed center
4	3-position exhaust center
5	3-position pressure center

Pilot type

Nil	Internal pilot
R	External pilot

Coil specifications

Nil	Standard
T	With power-saving circuit (24, 12 VDC only)

* Power-saving circuit is not available in the case of "D" or "Y" type.

Rated voltage

For DC

5	24 VDC
6	12 VDC
V	6 VDC
S	5 VDC
R	3 VDC

For AC (50/60Hz)

1	100 VAC
2	200 VAC
3	110 VAC [115 VAC]
4	220 VAC [230 VAC]

* DC specifications of type "D" and "Y" are only available with 12 and 24 VDC.

* AC-type models that are CE/UKCA-compliant have DIN terminals only.

CE/UKCA-compliant

Nil	—
Q	CE/UKCA-compliant

* AC-type models that are CE/UKCA-compliant have DIN terminals only.

Thread type

Nil	Rc
F	G

Port size

Symbol	Port size	Applicable series
Nil	Without sub-plate	
02	1/4 With sub-plate	SY5000 SY7000
03	3/8 With sub-plate	SY7000

Manual override

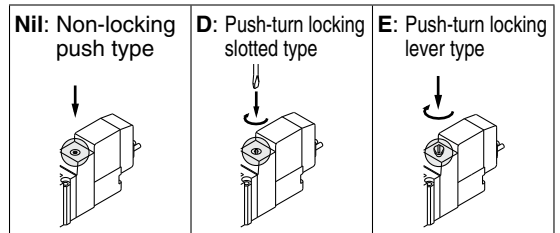

Light/surge voltage suppressor

Electrical entry for G, H, L, M

Nil	Without light/surge voltage suppressor
S	With surge voltage suppressor
Z	With light/surge voltage suppressor
R	With surge voltage suppressor (Non-polar type)
U	With light/surge voltage suppressor (Non-polar type)

* There is no "S" type for AC mode, since a rectifier prevents surge voltage generation.
* For "R" and "U," DC voltage is only available.
* Power-saving circuit is only available in the "Z" type.

Electrical entry for D, Y

Nil	Without light/surge voltage suppressor
S	With surge voltage suppressor (Non-polar type)
Z	With light/surge voltage suppressor (Non-polar type)

* There is no "S" type for AC mode, since a rectifier prevents surge voltage generation.

Electrical entry

24, 12, 6, 5, 3 VDC / 100, 110, 200, 220 VAC				24, 12 VDC / 100, 110, 200, 220 VAC
Grommet	L plug connector	M plug connector	MN: Without lead wire	D, Y: With connector
G: With lead wire (Length 300 mm)	L: With lead wire (Length 300 mm)	M: With lead wire (Length 300 mm)	MN: Without lead wire	D, Y: With connector
H: With lead wire (Length 600 mm)	LN: Without lead wire	LO: Without connector	MO: Without connector	

* "LN," "MN" type: with 2 sockets.

* "Y" type is a DIN terminal conforming to EN-175301-803C (former DIN43650C).

* Refer to the standard products for the lead wire length of L and M plug connectors and the connector assembly with cover for L and M plug connector.

* The 25A- series specifications and dimensions are the same as those of the standard model.

For details, refer to the Web Catalog.

Directional Control Valves
Air Cylinders
Related Products
Rotary Actuators
Air Grippers
Vacuum Equipment
Air Preparation Equipment
Clean Air Filters
Modular F.R.L./Pressure Control Equipment
Flow Control Equipment/Fittings
Detection Switches
Fluid Control Equipment
Process Gas Equipment
Electric Actuators
Auto Switches

5-Port Solenoid Valve Body Ported Manifold



Bar Stock Type/Individual Wiring

Type **20**

25A-SY5000/7000 Series

How to Order Manifolds

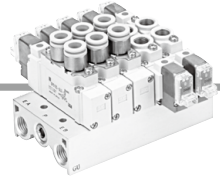

25A – SS5Y **5** – 20 – **05** – [] – []

• Series compatible with secondary batteries

Manifold series

5	SY5000
7	SY7000

• CE/UKCA-compliant

Nil	—
Q	CE/UKCA-compliant

* AC-type models that are CE/UKCA-compliant have DIN terminals only.

• Thread type

Nil	Rc
00F	G

• Stations

02	2 stations
⋮	⋮
20	20 stations

* The blanking plate assembly is included in this number.

* The 25A- series specifications and dimensions are the same as those of the standard model. However, the blanking plate assembly has different dimensions. Refer to page 67.

For details, refer to the **Web Catalog**.



How to Order Valves

25A – SY 5 1 20 [] – 5 L [] [] – 01 [] – []

• Series compatible with secondary batteries

Series

5	SY5000
7	SY7000

• Type of actuation

1	2-position single
2	2-position double
3	3-position closed center
4	3-position exhaust center
5	3-position pressure center

• Coil specifications

Nil	Standard
T	With power-saving circuit (24 VDC, 12 VDC only)

* Power-saving circuit is not available in the case of "D" or "Y" type.

• Rated voltage

For DC		For AC (50/60Hz)	
5	24 VDC	1	100 VAC
6	12 VDC	2	200 VAC
V	6 VDC	3	110 VAC [115 VAC]
S	5 VDC	4	220 VAC [230 VAC]
R	3 VDC		

* DC specifications of type "D" and "Y" are only available with 12 and 24 VDC.
* AC-type models that are CE/UKCA-compliant have DIN terminals only.

• CE/UKCA-compliant

Nil	—
Q	CE/UKCA-compliant

* AC-type models that are CE/UKCA-compliant have DIN terminals only.

• Thread type

Nil	Rc
F	G

• A, B port size Thread piping

Symbol	Port size	Applicable series
01	1/8	SY5000
02	1/4	SY7000

• One-touch fitting (Metric size)

Symbol	Port size	Applicable series
C4	One-touch fitting for ø4	SY5000
C6	One-touch fitting for ø6	
C8	One-touch fitting for ø8	
C8	One-touch fitting for ø8	SY7000
C10	One-touch fitting for ø10	

• Manual override

Nil	Non-locking push type
D	Push-turn locking slotted type
E	Push-turn locking lever type

• Light/surge voltage suppressor

Electrical entry for G, H, L, M

Nil	Without light/surge voltage suppressor
S	With surge voltage suppressor
Z	With light/surge voltage suppressor
R	With surge voltage suppressor (Non-polar type)
U	With light/surge voltage suppressor (Non-polar type)

* There is no "S" type for AC mode, since a rectifier prevents surge voltage generation.
* For "R" and "U," DC voltage is only available.
* Power-saving circuit is only available in the "Z" type.

Electrical entry for D, Y

Nil	Without light/surge voltage suppressor
S	With surge voltage suppressor (Non-polar type)
Z	With light/surge voltage suppressor (Non-polar type)

* There is no "S" type for AC mode, since a rectifier prevents surge voltage generation.

• Electrical entry

24, 12, 6, 5, 3 VDC/100, 110, 200, 220 VAC			24, 12 VDC/ 100, 110, 200, 220 VAC
Grommet	L plug connector	M plug connector	DIN terminal
G: With lead wire (Length 300 mm) H: With lead wire (Length 600 mm)	L: With lead wire (Length 300 mm) LN: Without lead wire LO: Without connector	M: With lead wire (Length 300 mm) MN: Without lead wire MO: Without connector	D: With connector Y: With connector

* "LN," "MN" type: with 2 sockets.
* "Y" type is a DIN terminal conforming to EN-175301-803C (former DIN43650C).
* Refer to the standard products for the lead wire length of L and M plug connectors and the connector assembly with cover for L and M plug connector.

* The 25A- series specifications and dimensions are the same as those of the standard model.

For details, refer to the Web Catalog.

Directional Control Valves
Air Cylinders
Related Products
Rotary Actuators
Air Grippers
Vacuum Equipment
Air Preparation Equipment
Clean Air Filters
Modular F.R.L./Pressure Control Equipment
Flow Control Equipment/Fittings
Detection Switches
Fluid Control Equipment
Process Gas Equipment
Electric Actuators
Auto Switches

Type **41**
Type **42**

5-Port Solenoid Valve Base Mounted Manifold Bar Stock Type/Individual Wiring

25A-SY5000/7000 Series



How to Order Manifolds

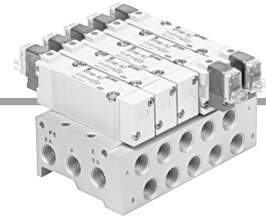

Type 41/Compact type

25A – SS5Y 5 – 41 – 05 – C8 [] – []

• Series compatible with secondary batteries

Manifold series

5	SY5000
---	--------

Stations

02	2 stations
⋮	⋮
20	20 stations

* The blanking plate assembly is included in this number.

• Thread type

Nil	Rc
F	G

• A, B port size
Thread piping

Symbol	Port size	Applicable series
01	1/8	SY5000

One-touch fitting (Metric size)

Symbol	Port size	Applicable series
C6	One-touch fitting for $\phi 6$	SY5000
C8	One-touch fitting for $\phi 8$	SY5000

One-touch fitting (Inch size)

Symbol	Port size	Applicable series
N7	One-touch fitting for $\phi 1/4"$	SY5000
N9	One-touch fitting for $\phi 5/16"$	SY5000

• CE/UKCA-compliant

Nil	—
Q	CE/UKCA-compliant

* AC-type models that are CE/UKCA-compliant have DIN terminals only.

Type 42/External pilot capable

25A – SS5Y 5 – 42 – 05 – C8 [] – []

• Series compatible with secondary batteries

Manifold series

5	SY5000
7	SY7000

Stations

02	2 stations
⋮	⋮
20	20 stations

* The blanking plate assembly is included in this number.

• Thread type

Nil	Rc
F	G

• A, B port size
Thread piping

Symbol	Port size	Applicable series
02	1/4	SY5000
02	1/4	SY7000

One-touch fitting (Metric size)

Symbol	Port size	Applicable series
C6	One-touch fitting for $\phi 6$	SY5000
C8	One-touch fitting for $\phi 8$	SY5000
C10	One-touch fitting for $\phi 10$	SY7000

One-touch fitting (Inch size)

Symbol	Port size	Applicable series
N7	One-touch fitting for $\phi 1/4"$	SY5000
N9	One-touch fitting for $\phi 5/16"$	SY5000
N11	One-touch fitting for $\phi 3/8"$	SY7000

• CE/UKCA-compliant

Nil	—
Q	CE/UKCA-compliant

* AC-type models that are CE/UKCA-compliant have DIN terminals only.

* The 25A- series specifications and dimensions are the same as those of the standard model. However, the blanking plate assembly has different dimensions. Refer to page 67.

For details, refer to the **Web Catalog**.

How to Order Valves

25A – SY 5 2 40 [] [] – **5 L** [] [] – []

• **Series compatible with secondary batteries**

Series

5	SY5000
7	SY7000

Type of actuation

1	2-position single
2	2-position double
3	3-position closed center
4	3-position exhaust center
5	3-position pressure center

Pilot type

Nil	Internal pilot
R	External pilot

Coil specifications

Nil	Standard
T	With power-saving circuit (24 VDC, 12 VDC only)

* Power-saving circuit is not available in the case of "D" or "Y" type.

Rated voltage

For DC

5	24 VDC
6	12 VDC
V	6 VDC
S	5 VDC
R	3 VDC

For AC (50/60Hz)

1	100 VAC
2	200 VAC
3	110 VAC [115 VAC]
4	220 VAC [230 VAC]

* DC specifications of type "D" and "Y" are only available with 12 and 24 VDC.

* AC-type models that are CE/UKCA-compliant have DIN terminals only.

• **CE/UKCA-compliant**

Nil	—
Q	CE/UKCA-compliant

* AC-type models that are CE/UKCA-compliant have DIN terminals only.

• **Manual override**

Nil	Non-locking push type
D	Push-turn locking slotted type
E	Push-turn locking lever type

• **Light/surge voltage suppressor**

Electrical entry for G, H, L, M

Nil	Without light/surge voltage suppressor
S	With surge voltage suppressor
Z	With light/surge voltage suppressor
R	With surge voltage suppressor (Non-polar type)
U	With light/surge voltage suppressor (Non-polar type)

* There is no "S" type for AC mode, since a rectifier prevents surge voltage generation.

* For "R" and "U," DC voltage is only available.

* Power-saving circuit is only available in the "Z" type.

Electrical entry for D, Y

Nil	Without light/surge voltage suppressor
S	With surge voltage suppressor (Non-polar type)
Z	With light/surge voltage suppressor (Non-polar type)

* There is no "S" type for AC mode, since a rectifier prevents surge voltage generation.

• **Electrical entry**

24, 12, 6, 5, 3 VDC/100, 110, 200, 220 VAC			24, 12 VDC/ 100, 110, 200, 220 VAC
Grommet	L plug connector	M plug connector	DIN terminal
G: With lead wire (Length 300 mm) H: With lead wire (Length 600 mm)	L: With lead wire (Length 300 mm) LN: Without lead wire LO: Without connector	M: With lead wire (Length 300 mm) MN: Without lead wire MO: Without connector	D: With connector Y: With connector

* "LN," "MN" type: with 2 sockets.

* "Y" type is a DIN terminal conforming to EN-175301-803C (former DIN43650C).

* Refer to the standard products for the lead wire length of L and M plug connectors and the connector assembly with cover for L and M plug connector.

* The 25A- series specifications and dimensions are the same as those of the standard model.

For details, refer to the Web Catalog.

Directional Control Valves
Air Cylinders
Related Products
Rotary Actuators
Air Grippers
Vacuum Equipment
Air Preparation Equipment
Clean Air Filters
Modular F.R.L./Pressure Control Equipment
Flow Control Equipment/Fittings
Detection Switches
Fluid Control Equipment
Process Gas Equipment
Electric Actuators
Auto Switches

25A-SY5000/7000 Series

How to Order Pilot Valve Assembly (With two mounting screws)

25A - V111 - 5 G

Coil specifications

Nil	Standard
T	With power-saving circuit (24 VDC, 12 VDC only)

* Power-saving circuit is not available in the case of D or Y type.

Rated voltage

5	24 VDC
6	12 VDC
V	6 VDC
S	5 VDC
R	3 VDC
1	100 VAC ^{50/60} Hz
2	200 VAC ^{50/60} Hz
3	110 VAC ^{50/60} Hz [115 VAC ^{50/60} Hz]
4	220 VAC ^{50/60} Hz [230 VAC ^{50/60} Hz]

* CE/UKCA-compliant:
For DC only.

Light/Surge voltage suppressor

Nil	Without light/surge voltage suppressor
S	With surge voltage suppressor
Z	With light/surge voltage suppressor
R	With surge voltage suppressor (Non-polar type)
U	With light/surge voltage suppressor (Non-polar type)

* For AC voltage valves there is no "S" option. It is already built-in to the rectifier circuit.
* For "R" and "U", DC voltage is only available.
* Power-saving circuit is only available in the "Z" type.

Electrical entry

G	Grommet, 300 mm lead wire
H	Grommet, 600 mm lead wire
L	L plug connector
LN	With lead wire
LO	Without lead wire
M	M plug connector
MN	With lead wire
MO	Without lead wire

DIN terminal type

25A - V115 - 5 D

Rated voltage

5	24 VDC
6	12 VDC
1	100 VAC ^{50/60} Hz
2	200 VAC ^{50/60} Hz
3	110 VAC ^{50/60} Hz [115 VAC ^{50/60} Hz]
4	220 VAC ^{50/60} Hz [230 VAC ^{50/60} Hz]

* DC specifications of type D and Y is only available with 12 and 24 VDC.

Light/Surge voltage suppressor

Nil	Without light/surge voltage suppressor
S	With surge voltage suppressor (Non-polar type)
Z	With light/surge voltage suppressor (Non-polar type)

* DOZ and YOZ are not available.
* For AC voltage valves there is no "S" option. It is already built-in to the rectifier circuit.

Electrical entry

D	DIN terminal (Type D)	With connector
DO	Without connector	
Y	DIN terminal (Type Y)	With connector
YO	Without connector	

* Do not replace V111 (G, H, L, M) to V115 (DIN terminal) and vice versa when replacing pilot valve assembly only.

* Since V111 and V115 are CE/UKCA-compliant as standard, the suffix "-Q" is not necessary.

Bar Stock Type/Individual Wiring **25A-SY5000/7000 Series**

One-touch Fittings Part Nos. for Body Ported

		Port size	25A-SY5000	25A-SY7000
Cylinder port	Metric size	ø4 One-touch fitting (Straight type)	90-VVQ1000-51A-C4	
		ø6 One-touch fitting (Straight type)	90-VVQ1000-51A-C6	
		ø8 One-touch fitting (Straight type)	90-VVQ1000-51A-C8	90-VVQ2000-51A-C8
		ø10 One-touch fitting (Straight type)		90-VVQ2000-51A-C10

Gasket Assembly Part Nos.

Valve model	Manifold type	25A-SY5000	25A-SY7000
Body ported	Type 20	SY5000-GS-3	SY7000-GS-3
Base mounted	Type 41/42	SY5000-GS-4 (-Q)	SY7000-GS-4 (-Q)

* The gasket assembly includes 10 sets of a gasket and mounting screws.

Bracket Assembly Part Nos.

Description	Part no.
Bracket (For F1)	25A-SX ⁵ 000-16-2A (With mounting screw)
Bracket (For F2)	25A-SX ⁵ 000-16-1A (With mounting screw)

Port Block Assembly Part Nos.

25A-SY **5** 000-6A-**01**

Series

5	SY5000
7	SY7000

Thread type

Nil	Rc
F	G

A, B port size

Thread piping

Symbol	Port size	Applicable series
01	1/8	25A-SY5000
02	1/4	25A-SY7000

One-touch fitting (Metric size)

Symbol	Port size	Applicable series
C4	One-touch fitting for ø4	25A-SY5000
C6	One-touch fitting for ø6	
C8	One-touch fitting for ø8	
C8	One-touch fitting for ø8	25A-SY7000
C10	One-touch fitting for ø10	

Directional Control Valves

Air Cylinders

Related Products

Rotary Actuators

Air Grippers

Vacuum Equipment

Air Preparation Equipment

Clean Air Filters

Modular F.R.L./Pressure Control Equipment

Flow Control Equipment/Fittings

Detection Switches

Fluid Control Equipment

Process Gas Equipment

Electric Actuators

Auto Switches

25A-SY5000/7000 Series

Manifold Options

Blanking plate assembly

(Mounting screw: 2 pcs., with gasket)

It is used by attaching on the manifold block for being prepared for removing a valve for maintenance reasons or planning to mount a spare valve, etc.

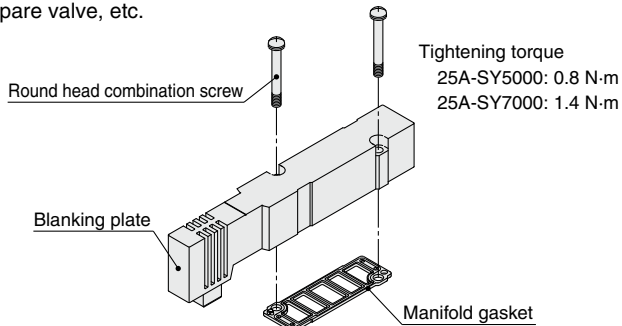

How to Order

25A-SY **5** 000-26-1A

Series

5	SY5000
7	SY7000

Caution

When mounted on a type 20 manifold, only the P port is plugged. In addition, it cannot be used for the type 20 CE/UKCA-compliant manifold.

Dimensions

Manifold type/For type 20

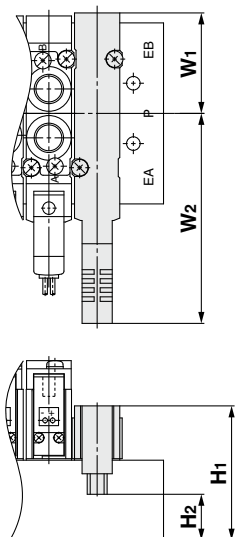

Dimensions

[mm]

Series	Manifold type	W1	W2	H1	H2
25A-SY5000	Type 20	33.3	69.6	44.5	15.2
25A-SY7000	Type 20	39.4	76.4	41.1	18.3

Manifold type/For type 41/42

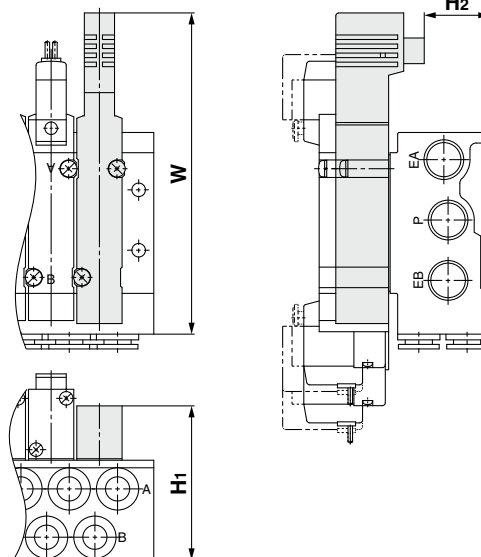

Dimensions

[mm]

Series	Manifold type	W	H1	H2
25A-SY5000	Type 41	106.4	51	21.7
	Type 42	107.6	56	26.7
25A-SY7000	Type 42	118.1	55.6	32.8

Auto Switches	Electric Actuators	Process Gas Equipment	Fluid Control Equipment	Detection Switches	Flow Control Equipment/Fittings	Modular F.R.L./Pressure Control Equipment	Clean Air Filters	Air Preparation Equipment	Vacuum Equipment	Air Grippers	Rotary Actuators	Related Products	Air Cylinders	Directional Control Valves
---------------	--------------------	-----------------------	-------------------------	--------------------	---------------------------------	---	-------------------	---------------------------	------------------	--------------	------------------	------------------	---------------	----------------------------

Plug-in Unit/Base Mounted F Kit (D-sub connector kit) 25A-VQ2000 Series



How to Order Manifolds

* For CE/UKCA-compliant models, DC-type only.

25A-VV5Q 2 1-08 C6 F U 1

• Series compatible with secondary batteries

• Series: 2 VQ2000

• Manifold: 1 Plug-in unit

• Stations: 02 2 stations, 24 24 stations

• Cylinder port

Symbol	Port size
C4	With ø4 One-touch fitting
C6	With ø6 One-touch fitting
C8	With ø8 One-touch fitting
L4	Top ported elbow with ø4 One-touch fitting
L6	Top ported elbow with ø6 One-touch fitting
L8	Top ported elbow with ø8 One-touch fitting

• Connector entry direction

U	Top entry
S	Side entry

• Cable (Length)

0	Without cable
1	With cable (1.5 m)
2	With cable (3 m)
3	With cable (5 m)

• CE/UKCA-compliant

Nil	—
Q	CE/UKCA-compliant

* For CE/UKCA-compliant models, DC-type only.

• Option

Symbol	Option
Nil	None
2	200/220 VAC models
B*1	With back pressure check valve
D	DIN rail mounting
D0	With DIN rail bracket (Without DIN rail)
D□*2	DIN rail length specified (□: Stations 02 to 24)
K*3	Special wiring specifications (Except double wiring)
N	With name plate
R*4	External pilot
S	Direct EXH outlet with built-in silencer

*1 Models with a suffix "-B" have check valves for prevention of back pressure at all manifold stations. When a back pressure check valve is desired, and is to be installed only in certain manifold stations, specify the mounting position by means of the manifold specification sheet.

*2 The number of stations that may be displayed is longer than the manifold number of stations.

*3 Specify the wiring specifications by means of the manifold specification sheet.

*4 Indicate "R" for the valve with external pilot.

* When two or more symbols are specified, indicate them alphabetically. Example) -BRS

How to Order Valves

* For CE/UKCA-compliant models, DC-type only.



25A-VQ 2 1 0 1

• Series compatible with secondary batteries

• Series: 2 VQ2000

• Seal type: 1 Rubber seal

• Function

Symbol	Specifications	DC	AC
Nil	Standard	(0.4 W) ○	○
B	High speed response type	(0.95 W) ○	—
N	Negative common	○	—
R	External pilot	○	○

* When two or more symbols are specified, indicate them alphabetically.

• CE/UKCA-compliant

Nil	—
Q	CE/UKCA-compliant

* For CE/UKCA-compliant models, DC-type only.

• Manual override

Nil	Non-locking push type (Tool required)
B	Locking type (Tool required)
C	Locking type (Manual)
D	Slide locking type (Manual)

• Light/surge voltage suppressor

Nil	Yes
E	None

• Coil voltage

	CE/UKCA-compliant
1	100 VAC (50/60 Hz)
2	200 VAC (50/60 Hz)
3	110 VAC (50/60 Hz)
4	220 VAC (50/60 Hz)
5	24 VDC
6	12 VDC

⚠ Caution

Use the standard (DC) specification when continuously energizing for long periods of time.

* The 25A- series specifications and dimensions are the same as those of the standard model.

For details, refer to the Web Catalog.

Plug-in Unit/Base Mounted T Kit (Terminal block box kit) 25A-VQ2000 Series



How to Order Manifolds

* For CE/UKCA-compliant models, DC-type only.

25A-VV5Q 2 1-08 C6 T 0- -

- Series compatible with secondary batteries**
- Series**
2 VQ2000
- Manifold**
1 Plug-in unit
- Stations**
02 2 stations
: :
20 20 stations
- Cylinder port**

Symbol	Port size
C4	With ø4 One-touch fitting
C6	With ø6 One-touch fitting
C8	With ø8 One-touch fitting
L4	Top ported elbow with ø4 One-touch fitting
L6	Top ported elbow with ø6 One-touch fitting
L8	Top ported elbow with ø8 One-touch fitting

Symbol	Option
Nil	None
B*1	With back pressure check valve
D	DIN rail mounting
D0	With DIN rail bracket (Without DIN rail)
D□*2	DIN rail length specified (□: Stations 02 to 20)
K*3	Special wiring spec. (Except double wiring)
N	With name plate
R*4	External pilot
S	Direct EXH outlet with built-in silencer
W	Enclosure: Dust-tight, Water-jet-proof (IP65)

CE/UKCA-compliant

Nil	—
Q	CE/UKCA-compliant

* For CE/UKCA-compliant models, DC-type only.

Option

- *1 Models with a suffix "B" have check valves for prevention of back pressure at all manifold stations. When a back pressure check valve is desired, and is to be installed only in certain manifold stations, specify the mounting position by means of the manifold specification sheet.
- *2 The number of stations that may be displayed is longer than the manifold number of stations.
- *3 Specify the wiring specifications by means of the manifold specification sheet.
- *4 Indicate "R" for the valve with external pilot.
- * When two or more symbols are specified, indicate them alphabetically. Example) -BRS
- * Specify the mounting position by means of the manifold specification sheet.

How to Order Valves

* For CE/UKCA-compliant models, DC-type only.



25A-VQ 2 1 0 1 - 5 - - - 1 -

- Series compatible with secondary batteries**
- Series**
2 VQ2000
- Type of actuation**
- Seal type**
1 Rubber seal
- Function**
- CE/UKCA-compliant**
- Enclosure**
- Manual override**
- Light/surge voltage suppressor**
- Coil voltage**

Symbol	Specifications	DC	AC
Nil	Standard	(0.4 W) ○	○
B	High speed response type	(0.95 W) ○	—
N	Negative common	○	—
R	External pilot	○	○

Nil	—
Q	CE/UKCA-compliant

* For CE/UKCA-compliant models, DC-type only.

Symbol	Option
Nil	Dustproof
W	Dust-tight/Water-jet-proof type (IP65)

Symbol	Option
Nil	Non-locking push type (Tool required)
B	Locking type (Tool required)
C	Locking type (Manual)
D	Slide locking type (Manual)

Symbol	Option
Nil	Yes
E	None

Symbol	Option
1	100 VAC (50/60 Hz)
3	110 VAC (50/60 Hz)
5	24 VDC
6	12 VDC

CE/UKCA-compliant

Caution
Use the standard (DC) specification when continuously energizing for long periods of time.

* When two or more symbols are specified, indicate them alphabetically. Combination of "B" and "K" is not possible.

* The 25A- series specifications and dimensions are the same as those of the standard model.

For details, refer to the **Web Catalog**.

Directional Control Valves
Air Cylinders
Related Products
Rotary Actuators
Air Grippers
Vacuum Equipment
Air Preparation Equipment
Clean Air Filters
Modular F.R.L./Pressure Control Equipment
Flow Control Equipment/Fittings
Detection Switches
Fluid Control Equipment
Process Gas Equipment
Electric Actuators
Auto Switches

Plug-in Unit/Base Mounted L Kit (Lead wire) 25A-VQ2000 Series



How to Order Manifolds

* For CE/UKCA-compliant models, DC-type only.

25A-VV5Q 2 1-06 C6 L 1 - -

• **Series compatible with secondary batteries**

Series

2	VQ2000
---	--------

• **Manifold**

1	Plug-in unit
---	--------------

• **Stations**

01	1 station
:	:
08	8 stations

• **Cylinder port**

Symbol	Port size
C4	With ø4 One-touch fitting
C6	With ø6 One-touch fitting
C8	With ø8 One-touch fitting
L4	Top ported elbow with ø4 One-touch fitting
L6	Top ported elbow with ø6 One-touch fitting
L8	Top ported elbow with ø8 One-touch fitting

• **Cable (Length)**

0	Cable length 0.6 m
1	Cable length 1.5 m
2	Cable length 3 m

• **CE/UKCA-compliant**

Nil	—
Q	CE/UKCA-compliant

* For CE/UKCA-compliant models, DC-type only.

• **Option**

Symbol	Option
Nil	None
2	200/220 VAC models
B*1	With back pressure check valve
D	DIN rail mounting
D0	With DIN rail bracket (Without DIN rail)
D□*2	DIN rail length specified (□: Stations 02 to 08)
N	With name plate
R*3	External pilot
S	Direct EXH outlet with built-in silencer
W	Enclosure: Dust-tight, Water-jet-proof (IP65)

*1 Models with a suffix "B" have check valves for prevention of back pressure at all manifold stations. When a back pressure check valve is desired, and is to be installed only in certain manifold stations, specify the mounting position by means of the manifold specification sheet.
*2 The number of stations that may be displayed is longer than the manifold a number of stations.
*3 Indicate "R" for the valve with external pilot.
* When two or more symbols are specified, indicate them alphabetically.
Example) -BRS

How to Order Valves

* For CE/UKCA-compliant models, DC-type only.



25A-VQ 2 1 0 1 - 5 - - - 1 -

• **Series compatible with secondary batteries**

Series

2	VQ2000
---	--------

• **Type of actuation**

1	2-position single
2	2-position double
3	3-position closed center
4	3-position exhaust center
5	3-position pressure center
A	4-position dual port (N.C./N.C.)
B	4-position dual port (N.O./N.O.)
C	4-position dual port (N.C./N.O.)

• **Seal type**

1	Rubber seal
---	-------------

• **Function**

Symbol	Specifications	DC (0.4 W)	AC
Nil	Standard	○	○
B	High speed response type	○	—
N	Negative common	○	—
R	External pilot	○	○

* When two or more symbols are specified, indicate them alphabetically.

• **CE/UKCA-compliant**

Nil	—
Q	CE/UKCA-compliant

* For CE/UKCA-compliant models, DC-type only.

• **Enclosure**

Nil	Dustproof
W	Dust-tight/Water-jet-proof type (IP65)

• **Manual override**

Nil	Non-locking push type (Tool required)
B	Locking type (Tool required)
C	Locking type (Manual)
D	Slide locking type (Manual)

• **Light/surge voltage suppressor**

Nil	Yes
E	None

• **Coil voltage**

	CE/UKCA-compliant
1	100 VAC (50/60 Hz) —
2	200 VAC (50/60 Hz) —
3	110 VAC (50/60 Hz) —
4	220 VAC (50/60 Hz) —
5	24 VDC ●
6	12 VDC ●

* The 25A- series specifications and dimensions are the same as those of the standard model. For details, refer to the Web Catalog.

Plug-in Unit/Base Mounted S Kit (Serial transmission) 25A-VQ2000 Series

* Refer to "SI Unit Part Nos." when ordering the CE/UKCA-compliant SI unit.



How to Order Manifolds

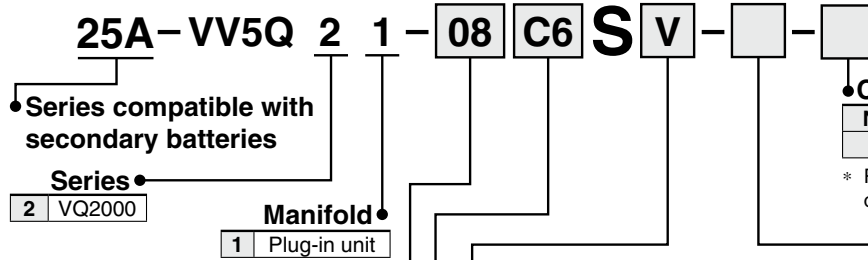

Nil	—
Q	CE/UKCA-compliant

* Refer to "SI Unit Part Nos." when ordering the CE/UKCA-compliant SI unit.

Symbol	Option
Nil	None
B*1	With back pressure check valve
D	DIN rail mounting
D□*2	DIN rail length specified (□: Stations 02 to 16)
K*3	Special wiring specifications (Except double wiring)
N	With name plate
R*4	With external pilot
S	Direct EXH outlet with built-in silencer
W*5	Enclosure: Dust-tight, Water-jet-proof (IP65)

Symbol	Port size
C4	With ø4 One-touch fitting
C6	With ø6 One-touch fitting
C8	With ø8 One-touch fitting
L4	Top ported elbow with ø4 One-touch fitting
L6	Top ported elbow with ø6 One-touch fitting
L8	Top ported elbow with ø8 One-touch fitting

Symbol	Protocol	Stations
0	Without SI unit	—
Q	DeviceNet®	Max.16 stations
V	CC-Link	Max.16 stations

- *1 Models with a suffix "-B" have check valves for prevention of back pressure at all manifold stations. When a back pressure check valve is desired, and is to be installed only in certain manifold stations, specify the mounting position by means of the manifold specification sheet.
 - *2 The number of stations that may be displayed is longer than the manifold number of stations.
 - *3 Specify the wiring specifications by means of the manifold specification sheet.
 - *4 Indicate "R" for the valve with external pilot.
 - *5 Refer to "Dimensions" of the standard products for SI unit and valve, in case of "W" (Dust-tight, Water-jet-proof).
- * When two or more symbols are specified, indicate them alphabetically.
Example) -BRS.

SI Unit Part Nos.

Symbol	Protocol	SI unit part no.
Q	DeviceNet®	EX120-SDN1-X220
V	CC-Link	EX120-SMJ1-X220

SI Unit Part Nos. (With option W)

Symbol	Protocol	SI unit part no.
Q	DeviceNet®	EX124D-SDN1-X220
V	CC-Link	EX124D-SMJ1-X220

How to Order Valves

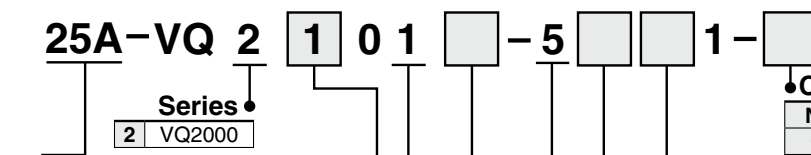

Nil	—
Q	CE/UKCA-compliant

Nil	Non-locking push type (Tool required)
B	Locking type (Tool required)
C	Locking type (Manual)
D	Slide locking type (Manual)

Nil	Dustproof
W	Dust-tight/Water-jet-proof type (IP65)

Symbol	Specifications	DC
1	2-position single	(0.4 W)
2	2-position double	(0.95 W)
3	3-position closed center	○
4	3-position exhaust center	○
5	3-position pressure center	○
A	4-position dual port (N.C./N.C.)	○
B	4-position dual port (N.O./N.O.)	○
C	4-position dual port (N.C./N.O.)	○

Symbol	Specifications	DC
Nil	Standard	(0.4 W)
B	High speed response type	(0.95 W)
N*1	Negative common	○
R*1	External pilot	○

- *1 External pilot and negative common specifications are the same as standard products.
- * When two or more symbols are specified, indicate them alphabetically.

* The 25A- series specifications and dimensions are the same as those of the standard model. For details, refer to the Web Catalog.

Sub-plate Single Unit 25A-VQ2000 Series

How to Order

* For CE/UKCA-compliant models, DC-type only.



In the case of **Valve** + **Sub-plate**

25A-VQ2 1 0 1-5 W 1-02 -

Series compatible with secondary batteries

The entry is the same as that of the standard model.

Enclosure

Nil	Dustproof
W*1	Dust-tight/Water-jet-proof type (IP65)

*1 Valves are IP65 specifications.

* When the valve is a standard (dust-protected) specification, it is not compatible with 200 or 220 VAC.

CE/UKCA-compliant

Nil	—
Q	CE/UKCA-compliant

* For CE/UKCA-compliant models, DC-type only.

Thread type

Nil	Rc
N	NPT
T	NPTF
F	G

Port size

02	1/4
----	-----

In the case of **Sub-plate** alone

25A-VQ2000-PW-02

* The 25A- series specifications and dimensions are the same as those of the standard model.

For details, refer to the **Web Catalog**.

Manifold Options

Blanking plate assembly

25A-VVQ2000V-10A-1

It is used by attaching on the manifold block for being prepared for removing a valve for maintenance reasons or planning to mount a spare valve, etc.

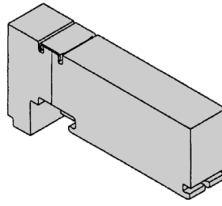

* The 25A- series specifications and dimensions are the same as those of the standard model.

For details, refer to the **Web Catalog**.

SI Unit Part Nos.

Description	SI unit part no.	Note
EX124 SI unit	EX124D-SMJ1-X220	CC-Link
	EX124D-SDN1-X220	DeviceNet®
EX120 SI unit	EX120-SMJ1-X220	CC-Link (VQ2000/Without option "W")
	EX120-SDN1-X220	DeviceNet® (VQ2000/Without option "W")

One-touch Fittings Part Nos.

Port size		One-touch fitting part no.	
Cylinder port	Metric size	ø4 One-touch fitting (Straight type)	90-VVQ1000-51A-C4
		ø6 One-touch fitting (Straight type)	90-VVQ1000-51A-C6
		ø8 One-touch fitting (Straight type)	90-VVQ1000-51A-C8
1 (P), 3 (R) port	Metric size	ø10 One-touch fitting (Straight type)	90-VVQ2000-51A-C10

Directional
Control Valves

Air Cylinders

Related
Products

Rotary
Actuators

Air Grippers

Vacuum
Equipment

Air Preparation
Equipment

Clean
Air Filters

Modular F.R.L./
Pressure Control
Equipment

Flow Control
Equipment/
Fittings

Detection
Switches

Fluid Control
Equipment

Process Gas
Equipment

Electric
Actuators

Auto
Switches

Plug-in/Plug Lead: Single Unit Base Mounted 25A-VQ4000 Series



How to Order Valves

0: Plug-in sub-plate

Body

Porting specifications

Nil	Side ported
B	Bottom ported

Port size

Nil	Without sub-plate (For manifold)
02	Rc 1/4
03	Rc 3/8

* Thread standard is the same as standard products.

Plug-in 25A-VQ4 1 0 1

Plug lead 25A-VQ4 2 5 1

Series compatible with secondary batteries

Type of actuation

1	2-position single
2	Rubber/2-position double
3	3-position closed center
4	3-position exhaust center
5	3-position pressure center
6*1	3-position double check

*1 For double check type, refer to the **Web Catalog**.

5: Plug lead sub-plate

Body

Seal type

1	Rubber seal
---	-------------

Function

Nil*1	Standard type (0.95 W)
Y*2	Low wattage type (0.4 W)
R*3	External pilot

*1 When the unit is energized continuously, refer to "Specific Product Precautions 1" in the **Web Catalog** (VQ4000 series).
*2 Only DC is available with Y.
*3 External pilot specifications are the same as standard products. Combination of external pilot and perfect interface is not possible.
* When two or more symbols are specified, indicate them alphabetically.

Enclosure

Nil	Dustproof
W	Dust-tight/Water-jet-proof type (IP65)

CE/UKCA-compliant

Nil	—
Q	CE/UKCA-compliant

* CE/UKCA-compliant: For DC only.

Manual override

Nil: Non-locking push type (Tool required)

B: Slotted locking type (Tool required)

C: Locking type (Manual)

Light/Surge voltage suppressor

Nil	Yes
E	Without light, with surge voltage suppressor

Electrical entry

Grommet	G	Lead wire length 0.6 m
	H	Lead wire length 1.5 m

Coil voltage

1	100 VAC (50/60 Hz)
2	200 VAC (50/60 Hz)
3	110 VAC (50/60 Hz)
4	220 VAC (50/60 Hz)
5	24 VDC
6	12 VDC

How to Order Sub-plates



25A-VQ4000 - [] - [] - [] - []

Series compatible with secondary batteries

Electrical entry

P	Plug-in conduit terminal
S	Plug lead

Enclosure

Nil	Dustproof
W*1	Dust-tight/Water-jet-proof type

*1 It is not necessary for plug lead type.

CE/UKCA-compliant

Nil	—
Q	CE/UKCA-compliant

Porting specifications

Nil	Side ported
B	Bottom ported*1

*1 For bottom ported port size is Rc 1/4 only.
* Thread standard is the same as standard products.

Port size

02	Rc1/4
03	Rc3/8

* The 25A- series specifications and dimensions are the same as those of the standard model. **For details, refer to the Web Catalog.**

Plug-in Unit/Base Mounted F Kit (D-sub connector kit) 25A-VQ4000 Series



How to Order Manifolds

25A – VV5Q 4 1 – 08 C8 F U 1 –

- Series compatible with secondary batteries**
- Series**

4	VQ4000
---	--------
- Manifold**

1	Plug-in unit
---	--------------
- Stations**

01	1 station
⋮	⋮
18	18 stations
- Cylinder port**

C6	With One-touch fitting for ø6
C8	With One-touch fitting for ø8
C10	With One-touch fitting for ø10
C12	With One-touch fitting for ø12
02	Rc 1/4
03	Rc 3/8
B	Bottom ported Rc 1/4
CM	Mixed

* As a semi-standard specification, the maximum number of stations can be increased by special wiring specifications.
- CE/UKCA-compliant**

Nil	—
Q	CE/UKCA-compliant
- Option**

Symbol	Option
Nil	None
K*1	Special wiring specifications (Except double wiring)

*1 Specify the wiring specifications on the manifold specification sheet.
- Cable (Length)**

0	Without cable
1	Cable length 1.5 m
2	Cable length 3 m
3	Cable length 5 m
- Connector entry direction**

D	D side entry
U	U side entry

How to Order Valves

25A – VQ 4 1 0 1 – 5 – 1 –

- Series compatible with secondary batteries**
- Series**

4	VQ4000
---	--------
- Type of actuation**

1	2-position single
2	2-position double
3	3-position closed center
4	3-position exhaust center
5	3-position pressure center
6	3-position double check
- Seal type**

1	Rubber seal
---	-------------
- Function**

Nil*1	Standard (0.95 W)
Y*2	Low wattage type (0.4 W)
R*3	External pilot

*1 When the unit is energized continuously, refer to "Specific Product Precautions 1" in the **Web Catalog** (VQ4000 series).
*2 Only DC is available with Y.
*3 External pilot specifications are the same as standard products. Combination of external pilot and perfect interface is not possible.
* When two or more symbols are specified, indicate them alphabetically.
- CE/UKCA-compliant**

Nil	—
Q	CE/UKCA-compliant

* CE/UKCA-compliant: For DC only.
- Manual override**

Nil	Non-locking push type (Tool required)
B	Locking type (Tool required)
C	Locking type (Manual)
- Light/Surge voltage suppressor**

Nil	Yes
E	Without light, with surge voltage suppressor
- Coil voltage**

1	100 VAC (50/60 Hz)
2	200 VAC (50/60 Hz)
3	110 VAC (50/60 Hz)
4	220 VAC (50/60 Hz)
5	24 VDC
6	12 VDC
- The 25A- series specifications and dimensions are the same as those of the standard model.**

For details, refer to the **Web Catalog**.

Plug-in Unit/Base Mounted T Kit (Terminal block box kit) 25A-VQ4000 Series



How to Order Manifolds

25A – VV5Q 4 1 – 08 C8 T O – [] – []

• Series compatible with secondary batteries

• Series

4	VQ4000
---	--------

• Manifold

1	Plug-in unit
---	--------------

• Stations

03	3 stations
:	:
18	18 stations

* 2 stations are used for mounting the terminal block box. The number of stations is the number of manifold valves plus 2 stations for the terminal block box. For 13 stations or more, specify the wiring specifications by means of the manifold specification sheet.

• CE/UKCA-compliant

Nil	—
Q	CE/UKCA-compliant

• Option

Symbol	Option
Nil	None
K*1	Special wiring specifications (Except double wiring, for 13 stations or more)
N*2	Name plate
W	IP65 enclosure

*1 Specify the wiring specifications on the manifold specification sheet.
*2 Name plate is inlaid in the terminal block cover.
* When two or more symbols are specified, indicate them alphabetically. Example) -KM

• Box mounting position

O	U side mounting
D	D side mounting

• Cylinder port

C6	With One-touch fitting for ø6
C8	With One-touch fitting for ø8
C10	With One-touch fitting for ø10
C12	With One-touch fitting for ø12
02	Rc 1/4
03	Rc 3/8
B	Bottom ported Rc 1/4
CM	Mixed

* As a semi-standard specification, the maximum number of stations can be increased by special wiring specifications.



How to Order Valves

25A – VQ 4 1 0 1 [] – 5 [] [] [] 1 – []

Series compatible with secondary batteries

• Series

4	VQ4000
---	--------

• Type of actuation

1	2-position single
2	2-position double
3	3-position closed center
4	3-position exhaust center
5	3-position pressure center
6	3-position double check

• Seal type

1	Rubber seal
---	-------------

• Function

Nil*1	Standard (0.95 W)
Y*2	Low wattage type (0.4 W)
R*3	External pilot

*1 When the unit is energized continuously, refer to "Specific Product Precautions 1" in the **Web Catalog** (VQ4000 series).
*2 Only DC is available with Y.
*3 External pilot specifications are the same as standard products. Combination of external pilot and perfect interface is not possible.
* When two or more symbols are specified, indicate them alphabetically.

• CE/UKCA-compliant

Nil	—
Q	CE/UKCA-compliant

* CE/UKCA-compliant: For DC only.

• Enclosure

Nil	Dustproof
W	Dust-tight/Water-jet-proof type (IP65)

• Manual override

Nil	Non-locking push type (Tool required)
B	Locking type (Tool required)
C	Locking type (Manual)

• Light/Surge voltage suppressor

Nil	Yes
E	Without light, with surge voltage suppressor

• Coil voltage

1	100 VAC (50/60 Hz)
2	200 VAC (50/60 Hz)
3	110 VAC (50/60 Hz)
4	220 VAC (50/60 Hz)
5	24 VDC
6	12 VDC

* The 25A- series specifications and dimensions are the same as those of the standard model.

For details, refer to the **Web Catalog**.

Plug-in Unit/Base Mounted L Kit (Lead wire cable) 25A-VQ4000 Series



How to Order Manifolds

25A – VV5Q 4 1 – 08 C8 L D – –

- Series compatible with secondary batteries**
- Series**

4	VQ4000
---	--------
- Manifold**

1	Plug-in unit
---	--------------
- Stations**

01	1 station
⋮	⋮
16	16 stations
- Cylinder port**

C6	With One-touch fitting for ø6
C8	With One-touch fitting for ø8
C10	With One-touch fitting for ø10
C12	With One-touch fitting for ø12
02	Rc 1/4
03	Rc 3/8
B	Bottom ported Rc 1/4
CM	Mixed
- CE/UKCA-compliant**

Nil	—
Q	CE/UKCA-compliant
- Option**

Symbol	Option
Nil	None
W	IP65 enclosure
- Cable (Length)**

0	Cable length 0.6 m
1	Cable length 1.5 m
2	Cable length 3 m
- Connector locations**

D	D side entry
U	U side entry



How to Order Valves

25A – VQ 4 1 0 1 – 5 – – – 1 –

- Series compatible with secondary batteries**
- Series**

4	VQ4000
---	--------
- Type of actuation**

1	2-position single
2	2-position double
3	3-position closed center
4	3-position exhaust center
5	3-position pressure center
6	3-position double check
- Seal type**

1	Rubber seal
---	-------------
- Function**

Nil*1	Standard (0.95 W)
Y*2	Low wattage type (0.4 W)
R*3	External pilot
- CE/UKCA-compliant**

Nil	—
Q	CE/UKCA-compliant

* CE/UKCA-compliant: For DC only.
- Enclosure**

Nil	Dustproof
W	Dust-tight/Water-jet-proof type (IP65)
- Manual override**

Nil	Non-locking push type (Tool required)
B	Locking type (Tool required)
C	Locking type (Manual)
- Light /Surge voltage suppressor**

Nil	Yes
E	Without light, with surge voltage suppressor
- Coil voltage**

1	100 VAC (50/60 Hz)
2	200 VAC (50/60 Hz)
3	110 VAC (50/60 Hz)
4	220 VAC (50/60 Hz)
5	24 VDC
6	12 VDC

*1 When the unit is energized continuously, refer to "Specific Product Precautions 1" in the **Web Catalog** (VQ4000 series).
 *2 Only DC is available with Y.
 *3 External pilot specifications are the same as standard products. Combination of external pilot and perfect interface is not possible.
 * When two or more symbols are specified, indicate them alphabetically.

* The 25A- series specifications and dimensions are the same as those of the standard model. **For details, refer to the Web Catalog.**

Directional Control Valves
Air Cylinders
Related Products
Rotary Actuators
Air Grippers
Vacuum Equipment
Air Preparation Equipment
Clean Air Filters
Modular F.R.L./Pressure Control Equipment
Flow Control Equipment/Fittings
Detection Switches
Fluid Control Equipment
Process Gas Equipment
Electric Actuators
Auto Switches

Plug-in Unit/Base Mounted S Kit (Serial transmission unit) 25A-VQ4000 Series

* Refer to "SI Unit Part Nos." when ordering the CE/UKCA-compliant SI unit.



How to Order Manifolds

25A - VV5Q 4 1 - 08 C8 S D V - [] - []

• **Series compatible with secondary batteries**

• **Series**

4	VQ4000
---	--------

• **Manifold**

1	Plug-in unit
---	--------------

• **Stations**

03	3 stations
:	:
18	18 stations

* 2 stations are used for mounting SI unit. The number of stations is the number of manifold valves plus 2 stations for SI unit. For 11 stations or more, specify the wiring specifications by means of the manifold specification sheet.

• **Cylinder ports**

C6	With One-touch fitting for ø6
C8	With One-touch fitting for ø8
C10	With One-touch fitting for ø10
C12	With One-touch fitting for ø12
02	Rc 1/4
03	Rc 3/8
B	Bottom ported Rc 1/4
CM	Mixed

• **SI unit**

0	Without SI unit
Q	DeviceNet®
V	CC-Link

• **SI unit mounting position**

Nil	U side mounting
D	D side mounting

• **CE/UKCA-compliant**

Nil	—
Q	CE/UKCA-compliant

• **Option**

Symbol	Option
Nil	None
K*1	Special wiring specifications (Except double wiring, for 11 stations or more)
W	IP65 enclosure

*1 Specify the wiring specifications on the manifold specification sheet.
* When two or more symbols are specified, indicate them alphabetically. Example) -KW

How to Order Valves

25A - VQ 4 1 0 1 [] - 5 [] [] [] 1 - []

• **Series compatible with secondary batteries**

• **Series**

4	VQ4000
---	--------

• **Type of actuation**

1	2-position single
2	2-position double
3	3-position closed center
4	3-position exhaust center
5	3-position pressure center
6	3-position double check

• **Seal type**

1	Rubber seal
---	-------------

• **Function**

Nil*1	Standard (0.95 W)
Y*2	Low wattage type (0.4 W)
R*3	External pilot

*1 When the unit is energized continuously, refer to "Specific Product Precautions 1" in the **Web Catalog** (VQ4000 series).
*2 Only DC is available with Y.
*3 External pilot specifications are the same as standard products. Combination of external pilot and perfect interface is not possible.
* When two or more symbols are specified, indicate them alphabetically.

• **CE/UKCA-compliant**

Nil	—
Q	CE/UKCA-compliant

* CE/UKCA-compliant: For DC only.

• **Enclosure**

Nil	Dustproof
W	Dust-tight/Water-jet-proof type (IP65)

• **Manual override**

Nil	Non-locking push type (Tool required)
B	Locking type (Tool required)
C	Locking type (Manual)

• **Light /Surge voltage suppressor**

Nil	Yes
E	Without light, with surge voltage suppressor

• **Coil voltage**

5	24 VDC
---	--------

* The 25A- series specifications and dimensions are the same as those of the standard model.

For details, refer to the **Web Catalog**.

Plug Lead Unit/Base Mounted C Kit (Connector kit)



25A-VQ4000 Series

How to Order Manifolds

25A - VV5Q 4 5 - 08 C8 C - W -

- Series compatible with secondary batteries**
- Series**

4	VQ4000
---	--------
- Manifold**

5	Plug lead unit
---	----------------
- Stations**

01	1 station
⋮	⋮
16	16 stations
- Cylinder port**

C6	With One-touch fitting for $\phi 6$
C8	With One-touch fitting for $\phi 8$
C10	With One-touch fitting for $\phi 10$
C12	With One-touch fitting for $\phi 12$
02	Rc 1/4
03	Rc 3/8
B	Bottom ported Rc 1/4
CM	Mixed
- Kit type**

C	kit (Connector)
---	-----------------
- CE/UKCA-compliant**

Nil	—
Q	CE/UKCA-compliant
- Option**

Symbol	Option
Nil	None
W	IP65 enclosure

Refer to the **Web Catalog** for wiring specifications.

How to Order Valves

25A - VQ 4 1 5 1 - 5 G -

- Series compatible with secondary batteries**
- Series**

4	VQ4000
---	--------
- Type of actuation**

1	2-position single
2	2-position double
3	3-position closed center
4	3-position exhaust center
5	3-position pressure center
6	3-position double check
- Seal type**

1	Rubber seal
---	-------------
- Function**

Nil*1	Standard (0.95 W)
Y*2	Low wattage type (0.4 W)
R*3	External pilot
- Enclosure**

Nil	Dustproof
W	Dust-tight/Water-jet-proof type (IP65)
- Manual override**

Nil:	Non-locking push type (Tool required)
B:	Locking type (Tool required)
C:	Locking type (Manual)
- Light/Surge voltage suppressor**

Nil	Yes
E	Without light, with surge voltage suppressor
- Electrical entry**

G	Lead wire length 0.6 m
H	Lead wire length 1.5 m
- Coil voltage**

1	100 VAC (50/60 Hz)	4	220 VAC (50/60 Hz)
2	200 VAC (50/60 Hz)	5	24 VDC
3	110 VAC (50/60 Hz)	6	12 VDC
- CE/UKCA-compliant**

Nil	—
Q	CE/UKCA-compliant

* CE/UKCA-compliant: For DC only.

*1 When the unit is energized continuously, refer to "Specific Product Precautions 1" in the **Web Catalog** (VQ4000 series).
 *2 Only DC is available with Y.
 *3 External pilot specifications are the same as standard products. Combination of external pilot and perfect interface is not possible.
 * When two or more symbols are specified, indicate them alphabetically.

* The 25A- series specifications and dimensions are the same as those of the standard model. **For details, refer to the Web Catalog.**

Directional Control Valves
Air Cylinders
Related Products
Rotary Actuators
Air Grippers
Vacuum Equipment
Air Preparation Equipment
Clean Air Filters
Modular F.R.L./Pressure Control Equipment
Flow Control Equipment/Fittings
Detection Switches
Fluid Control Equipment
Process Gas Equipment
Electric Actuators
Auto Switches

25A-VQ4000 Series

Manifold Options

Blanking plate assembly

25A-VVQ4000-10A-1 (Plug-in type)

25A-VVQ4000-10A-5 (Plug lead type)

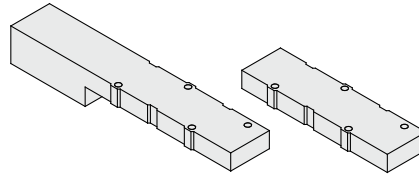

It is used by attaching on the manifold block for being prepared for removing a valve for maintenance reasons or planning to mount a spare valve, etc.

* The 25A- series specifications and dimensions are the same as those of the standard model.

For details, refer to the **Web Catalog**.

SI Unit Part Nos.

Description	SI unit part no.	Note
EX124 SI unit	EX124D-SMJ1-X220	CC-Link/D side mounting
	EX124D-SDN1-X220	DeviceNet®/D side mounting
	EX124U-SMJ1-X220	CC-Link/U side mounting
	EX124U-SDN1-X220	DeviceNet®/U side mounting

One-touch Fittings Part Nos.

		Port size	One-touch fittings part no.
Cylinder port	Metric size	ø6 One-touch fitting (Straight type)	90-VVQ4000-50B-C6
		ø8 One-touch fitting (Straight type)	90-VVQ4000-50B-C8
		ø10 One-touch fitting (Straight type)	90-VVQ4000-50B-C10
		ø12 One-touch fitting (Straight type)	90-VVQ4000-50B-C12

Auto Switches	Electric Actuators	Process Gas Equipment	Fluid Control Equipment	Detection Switches	Flow Control Equipment/Fittings	Modular F.R.L./Pressure Control Equipment	Clean Air Filters	Air Preparation Equipment	Vacuum Equipment	Air Grippers	Rotary Actuators	Related Products	Air Cylinders	Directional Control Valves
---------------	--------------------	-----------------------	-------------------------	--------------------	---------------------------------	---	-------------------	---------------------------	------------------	--------------	------------------	------------------	---------------	----------------------------

Plug-in Unit

25A-SQ2000 Series

How to Order Manifolds

25A – SS5Q23 – 08 FD2 – D – – –

Series compatible with secondary batteries

Stations

01	1 station
⋮	⋮
16*1	16 stations

*1 The maximum number of stations depends on the type of electrical entries.

Manifold mounting

D	DIN rail mounting
E	Direct mounting

Option

Nil	None
02 to 16*1	DIN rail length specified
B*2	Back pressure check valve
K*3	Special wiring specifications (Except double wiring)
N	With name plate (Side ported only)
R	External pilot specifications
S	Built-in silencer, direct exhaust

*1 Specify DIN rail length with "D□" at the end. (Enter the number of stations inside □.)
The number of stations that may be displayed is longer than the manifold number of stations. Example: -D09

*2 When "B" is selected, a back pressure check valve is included in all stations of the manifold. If the back pressure check valve is used only for the station that need it, then specify the station location in the manifold specification. ("B" is not necessary)

*3 Specify "K" for wiring specification for cases below. (Except L kit)

- All single wiring - Single and double mixed wiring
- When there are stations which do not require wiring (e.g. single SUP spacer)

Specify the wiring specification in the manifold specification so that the number of solenoids is the maximum number of solenoids or less. (Standard wiring specification is double wiring)

* For specifying two or more options, enter them alphabetically. Example: -BKN

Nil	—
Q	CE/UKCA-compliant

1(P), 3(R) port size

Nil	1(P), 3(R) port One-touch fittings for ø10
00T	1(P), 3(R) port One-touch fittings for ø3/8"

Electrical entry

Kit type	Lead wire connector location	Cable specifications	Station	Max. number of stations for special wiring specifications	*1 Max. number of solenoids
F kit The electric parts are made of copper. Mounting screw: Stainless steel U side D-sub connector kit	D side	FD0	D-sub connector (25P) kit, without cable	1 to 12 stations	16 stations
		FD1	D-sub connector (25P) kit, with 1.5 m cable		
		FD2	D-sub connector (25P) kit, with 3.0 m cable		
		FD3	D-sub connector (25P) kit, with 5.0 m cable		
T kit Terminal block box kit 	TD0	D side	Terminal block box kit	1 to 10 stations	16 stations
L kit Mounting screw: Stainless steel One-touch fitting Body: Stainless steel Lead wire kit	LD0	D side	Lead wire kit with 0.6 m cable	1 to 12 stations	—
	LU0	U side			
	LD1	D side	Lead wire kit with 1.5 m cable		
	LU1	U side			
	LD2	D side	Lead wire kit with 3.0 m cable		
	LU2	U side			
S kit The electric parts are made of copper. Mounting screw: Stainless steel One-touch fitting Body: Stainless steel Serial transmission kit EX140 integrated-type (for output) serial transmission system*2	SDQ	D side	DeviceNet®	1 to 8 stations	16 stations
	SDV	D side	CC-Link	1 to 8 stations	16 stations

*1 The maximum number of stations should not be more than the maximum number of solenoids. (The number of solenoids are counted as: 1 for single solenoids and 2 for type 3P and 4P double solenoids.)

*2 Refer to the **Web Catalog** for the details of EX140 integrated-type (for output) serial transmission system. Refer to "SI unit part nos." below when ordering the CE/UKCA-compliant SI unit.

SI unit part nos.

Symbol	Protocol type	SI unit part no.	Page
SDQ	DeviceNet®	EX140-SDN1-X220	84
SDV	CC-Link	EX140-SMJ1-X220	

Blanking plate assembly

25A-SSQ2000-10A-3

* The 25A- series specifications and dimensions are the same as those of the standard model.

For details, refer to the **Web Catalog**.



How to Order Valves

25A-SQ2 1 3 1 5 1 C6

• **Series compatible with secondary batteries**

Type of actuation

1	2-position single
2	2-position double (Double solenoid)*1
3	3-position closed center
4	3-position exhaust center
5	3-position pressure center
A	4-position dual 3-port valve (N.C./N.C.)
B	4-position dual 3-port valve (N.O./N.O.)
C	4-position dual 3-port valve (N.C./N.O.)

*1 For double solenoid specification, the function symbol below is "D."

Seal type

1	Rubber seal
---	-------------

Function

Nil	Standard (0.4 W DC)
B	Quick response type (0.95 W)
D*1	2-position double (Double solenoid specifications)
N*2	Negative common
R*3	External pilot specifications

*1 "D" is specified for 2-position double.
 *2 For L kit, when the manifold specifies negative common, the valve common should also be negative.
 *3 Except dual 3-port valves.
 * When two or more symbols are specified, indicate them alphabetically.

Coil voltage

5	24 VDC
6	12 VDC

* Light/Surge voltage suppressor is built-in.
 * S kit: 24 VDC only

• **CE/UKCA-compliant**

Nil	—
Q	CE/UKCA-compliant

With/Without manifold block

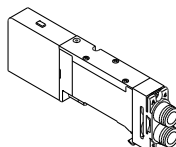
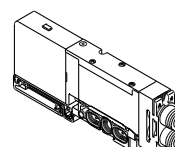
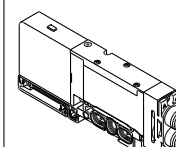
Nil	M	MB
Without manifold block 	With manifold block 	With manifold block, built-in back pressure check valve 
• When ordering with manifolds • When only valves are required.		For adding stations

* Lead wire is not included. * Lead wire is not included.

Port plug mounting port

Nil	None
A	Port 4(A)
B	Port 2(B)

Cylinder port

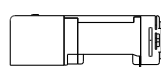
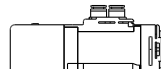
C4	One-touch fittings for ø4	Side ported 
C6	One-touch fittings for ø6	
C8	One-touch fittings for ø8	
L4	One-touch fittings for ø4	Top ported *1 
L6	One-touch fittings for ø6	
L8	One-touch fittings for ø8	

*1 Can be changed to side ported configuration.

Manual override

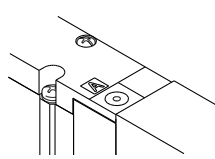
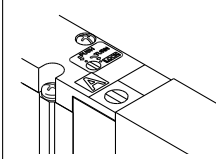
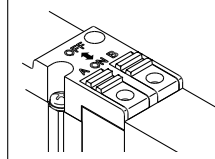
Nil	B	D
Non-locking push type (Tool required) 	Locking type (Tool required) 	Slide locking type (Manual type) * Only side ported type applicable 

SI Unit Part Nos.

Description	SI unit part no.	Note
EX140 SI unit	EX140-SMJ1-X220	CC-Link
	EX140-SDN1-X220	DeviceNet®

One-touch Fittings Part Nos.

Port size		One-touch fittings part no.	
Cylinder port	Metric size	ø4 One-touch fitting (Straight type)	90-VVQ1000-51A-C4
		ø6 One-touch fitting (Straight type)	90-VVQ1000-51A-C6
		ø8 One-touch fitting (Straight type)	90-VVQ1000-51A-C8
1 (P), 3 (R) port	Metric size	ø10 One-touch fitting (Straight type)	90-VVQ2000-51A-C10

* The 25A- series specifications and dimensions are the same as those of the standard model.

For details, refer to the **Web Catalog**.

Directional Control Valves
 Air Cylinders
 Related Products
 Rotary Actuators
 Air Grippers
 Vacuum Equipment
 Air Preparation Equipment
 Clean Air Filters
 Modular F.R.L./Pressure Control Equipment
 Flow Control Equipment/Fittings
 Detection Switches
 Fluid Control Equipment
 Process Gas Equipment
 Electric Actuators
 Auto Switches

Plug Lead Unit

25A-SQ2000 Series

How to Order Manifolds

25A – SS5Q24 – 08 FD2 – D □ – □ – □

Series compatible with secondary batteries

CE/UKCA-compliant

Nil	—
Q	CE/UKCA-compliant

Stations

01	1 station
⋮	⋮
16*1	16 stations

*1 The maximum number of stations depends on the type of electrical entries.

1(P), 3(R) port size

Nil	1(P), 3(R) port, One-touch fittings for ø10
00T	1(P), 3(R) port, One-touch fittings for ø3/8"

Option

Nil	None
02 to 16*1	DIN rail length specified
B*2	Back pressure check valve
K*3	Special wiring specifications (Except double wiring)
N	With name plate (Side ported only)
R	External pilot specifications
S	Built-in silencer, direct exhaust

Manifold mounting

D	DIN rail mounting
E*1	Direct mounting

*1 Type "E" is only available with a C kit.

- *1 Specify DIN rail length with "D□" at the end. (Enter the number of stations inside □.)
The number of stations that may be displayed is longer than the manifold number of stations. Example: -D09
- *2 When "-B" is selected, a back pressure check valve is included in all stations of the manifold. If the back pressure check valve is used only for the station that need it, then specify the station location in the manifold specification. ("-B" is not necessary)
- *3 Specify "-K" for wiring specification for cases below. (Except C kit)
 - All single wiring
 - Single and double mixed wiring
 Specify the wiring specification in the manifold specification so that the number of solenoids is the maximum number of solenoids or less. (Standard wiring specification is double wiring)
- * For specifying two or more options, enter them alphabetically. Example: -BKN

Electrical entry

Kit type	Lead wire connector location	Cable specifications	Stations	Max. number of stations for special wiring specifications	Max. number of solenoids
F kit The electric parts are made of copper. D-sub connector kit 	D side	FD0	1 to 12 stations	16 stations	24
		FD1			
		FD2			
		FD3			
C kit Connector kit 	C	Connector kit	1 to 16 stations	—	—

*1 The maximum number of stations should not be more than the maximum number of solenoids. (The number of solenoids are counted as: 1 for single solenoids and 2 for type 3P and 4P double solenoids.)

* Refer to the **Web Catalog** for manifold spare parts.

Blanking plate assembly

25A-SSQ2000-10A-4

* The 25A- series specifications and dimensions are the same as those of the standard model.

For details, refer to the **Web Catalog**.



How to Order Valves

25A-SQ2 1 4 1 5 L 1 C6

• **Series compatible with secondary batteries**

Type of actuation

1	2-position single
2	2-position double (Double solenoid)*1
3	3-position closed center
4	3-position exhaust center
5	3-position pressure center
A	4-position dual 3-port valve (N.C./N.C.)
B	4-position dual 3-port valve (N.O./N.O.)
C	4-position dual 3-port valve (N.C./N.O.)

*1 For double solenoid specification, the function symbol below is "D."

Seal type

1	Rubber seal
---	-------------

Function

Nil	Standard (0.4 W DC)
B	Quick response type (0.95 W)
D*1	2-position double (Double solenoid specifications)
N	Negative COM
R*2	External pilot specifications

*1 "D" is specified for 2-position double.

*2 Except dual 3-port valves.

* When two or more symbols are specified, indicate them alphabetically.

Coil voltage

5	24 VDC
6	12 VDC

* Light/Surge voltage suppressor is built-in.

Electrical entry

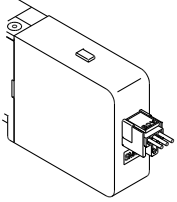
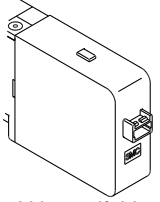
L	LO
Plug connector type with 300 mm lead wire 	Plug connector type without connector  For F, P, J kit manifolds*1

*1 Indicate "LO" when ordering centralized wiring type manifolds, F, P, and J kits, since the lead wire will be attached to the manifold side.

One-touch Fittings Part Nos.

Port size		One-touch fittings part no.
Cylinder port	Metric size	ø4 One-touch fitting (Straight type) 90-VVQ1000-51A-C4
		ø6 One-touch fitting (Straight type) 90-VVQ1000-51A-C6
		ø8 One-touch fitting (Straight type) 90-VVQ1000-51A-C8
1 (P), 3 (R) port	Metric size	ø10 One-touch fitting (Straight type) 90-VVQ2000-51A-C10

* The 25A-series specifications and dimensions are the same as those of the standard model.

For details, refer to the **Web Catalog**.

• **CE/UKCA-compliant**

Nil	—
Q	CE/UKCA-compliant

With/Without manifold block

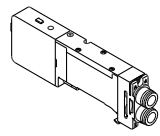
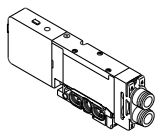
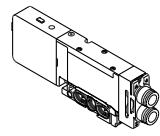
Nil	M	MB
Without manifold block	With manifold block	With manifold block, built-in back pressure check valve
		
	* Lead wire is not included.	* Lead wire is not included.
• When ordering with manifolds • When only valves are required.		
For adding stations		

Port plug mounting port

Nil	None
A	Port 4(A)
B	Port 2(B)

Cylinder port

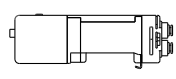
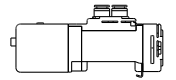
C4	One-touch fitting for ø4	Side ported	
C6	One-touch fitting for ø6		
C8	One-touch fitting for ø8		
L4	One-touch fitting for ø4	Top ported *1	
L6	One-touch fitting for ø6		
L8	One-touch fitting for ø8		

*1 Can be changed to side ported configuration.

Manual override

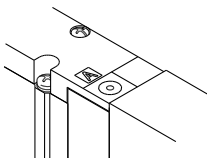
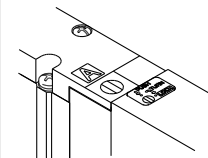
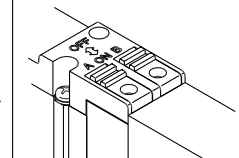
Nil	B	D
Non-locking push type (Tool required)	Locking type (Tool required)	Slide locking type (Manual type) * Only side ported type applicable
		

Directional Control Valves

Air Cylinders

Related Products

Rotary Actuators

Air Grippers

Vacuum Equipment

Air Preparation Equipment

Clean Air Filters

Modular F.R.L./Pressure Control Equipment

Flow Control Equipment/Fittings

Detection Switches

Fluid Control Equipment

Process Gas Equipment

Electric Actuators

Auto Switches

Base Mounted
Plug Lead Unit

5-Port Solenoid Valve

25A-VQZ1000 Series

Single Unit



How to Order Valves

25A-VQZ 1 1 5 1 - **5 M** 1 - **01** -

• Series compatible with secondary batteries

Series

1 VQZ1000 body width 10 mm

Type of actuation

1	2-position single
2	2-position double
3	3-position closed center
4	3-position exhaust center
5	3-position pressure center
8	3-port for mixture mounting N.C.
9	3-port for mixture mounting N.O.

Body type

5 Base mounted

Seal type

1 Rubber seal

Function

Symbol	Specifications	DC	AC
Nil	Standard	(0.35 W) ○	○
B	High speed response type	(0.9 W) ○	—
R	External pilot type	○	○
BR	High speed response/External pilot type	(0.9 W) ○	—

• CE/UKCA-compliant

Nil	—
Q	CE/UKCA-compliant

* CE/UKCA-compliant: For DC only.

• Port size

Symbol	Port size
Nil	Without sub-plate
01	Rc1/8

• Manual override

<p>Nil: Non-locking push type (Tool required)</p>	<p>B: Locking type (Tool required)</p>
--	---

• Electrical entry

G: Grommet (DC specification)	L: L-type plug connector with lead wire	LO: L-type plug connector without connector	M: M-type plug connector with lead wire	MO: M-type plug connector without connector
	With light/surge voltage suppressor	With light/surge voltage suppressor	With light/surge voltage suppressor	With light/surge voltage suppressor

• Coil voltage

1	100 VAC (50/60 Hz)
2	200 VAC (50/60 Hz)
3	110 VAC [115 VAC] (50/60 Hz)
4	220 VAC [230 VAC] (50/60 Hz)
5	24 VDC
6	12 VDC

⚠ Caution

Use standard (DC) specification for continuous duty.

* The 25A- series specifications and dimensions are the same as those of the standard model.

For details, refer to the **Web Catalog**.

Base Mounted
Plug Lead Unit

5-Port Solenoid Valve

25A-VQZ1000 Series

Manifold Connector Kit



How to Order Manifolds

25A-VV5QZ 1 5-08 C6 C-R-

Series compatible with secondary batteries

Series
1 VQZ1000

Manifold type
5 Base mounted

Stations
02 2 stations
: :
20 20 stations

Port size [4(A), 2(B) port]

Symbol	Port size
C4	ø4 One-touch fitting
C6	ø6 One-touch fitting
M5	M5 thread
CM*1	Mixture of port sizes

*1 Specify port mixture/with port plug by the manifold specification sheet. Port mixture and port plug are available only for One-touch fitting type.

CE/UKCA-compliant

Nil	—
Q	CE/UKCA-compliant

Option

Nil	None
R	External pilot type

Kit type
C Connector

How to Order Valves

25A-VQZ 1 1 5 1 - 5 M 1 -

Series compatible with secondary batteries

Series
1 VQZ1000 body width 10 mm

Type of actuation

1	2-position single
2	2-position double
3	3-position closed center
4	3-position exhaust center
5	3-position pressure center
8	3-port for mixture mounting N.C.
9	3-port for mixture mounting N.O.

Body type
5 Base mounted

Seal type
1 Rubber seal

Function

Symbol	Specifications	DC	AC
Nil	Standard	(0.35 W) ○	○
B	High speed response type	(0.9 W) ○	—
R	External pilot type	○	○
BR	High speed response/ External pilot type	(0.9 W) ○	—

CE/UKCA-compliant

Nil	—
Q	CE/UKCA-compliant

* CE/UKCA-compliant: For DC only.

Manual override

Nil	Non-locking push type (Tool required)
B	Locking type (Tool required)

Electrical entry

Symbol	Electrical entry	Light/surge voltage suppressor
G	Grommet (DC specification)	None
L	L-type plug connector with lead wire	Yes
LO	L-type plug connector without connector	
M	M-type plug connector with lead wire	
MO	M-type plug connector without connector	

Coil voltage

1	100 VAC (50/60 Hz)
2	200 VAC (50/60 Hz)
3	110 VAC [115 VAC] (50/60 Hz)
4	220 VAC [230 VAC] (50/60 Hz)
5	24 VDC
6	12 VDC

Caution
Use standard (DC) specification for continuous duty.

* The 25A-series specifications and dimensions are the same as those of the standard model.

For details, refer to the **Web Catalog**.

Directional Control Valves
Air Cylinders
Related Products
Rotary Actuators
Air Grippers
Vacuum Equipment
Air Preparation Equipment
Clean Air Filters
Modular F.R.L./Pressure Control Equipment
Flow Control Equipment/Fittings
Detection Switches
Fluid Control Equipment
Process Gas Equipment
Electric Actuators
Auto Switches

Body Ported
Plug Lead Unit

5-Port Solenoid Valve

25A-VQZ1000 Series

Single Unit



How to Order Valves

25A-VQZ 1 1 2 1 [] - **5 M** [] **1-C6** - [] - []

• **Series compatible with secondary batteries**

• **Series**

1 VQZ1000 body width 10 mm

• **Type of actuation**

1	2-position single
2	2-position double
3	3-position closed center
4	3-position exhaust center
5	3-position pressure center
8	3-port for mixture mounting N.C.
9	3-port for mixture mounting N.O.

* 3-port for mixture mounting is only available for port size C4 or C6.

• **Body type**

2 Body ported

• **Seal type**

1 Rubber seal

• **Function**

Symbol	Specifications	DC	AC
Nil	Standard	(0.35 W) ○	○
B	High speed response type	(0.9 W) ○	—

• **Coil voltage**

1	100 VAC (50/60 Hz)
2	200 VAC (50/60 Hz)
3	110 VAC [115 VAC] (50/60 Hz)
4	220 VAC [230 VAC] (50/60 Hz)
5	24 VDC
6	12 VDC

• **CE/UKCA-compliant**

Nil	—
Q	CE/UKCA-compliant

* CE/UKCA-compliant: For DC only.

• **Option**

Nil: None
F: With bracket (2-position single type only)

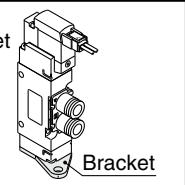

• **Port size [4(A), 2(B) port]**

Symbol	Port size
C4	ø4 One-touch fitting
C6	ø6 One-touch fitting
M5	M5 thread

• **Manual override**

<p>Nil: Non-locking push type (Tool required)</p>	<p>B: Locking type (Tool required)</p>
---	--

• **Electrical entry**

G: Grommet (DC specification)	L: L-type plug connector with lead wire	LO: L-type plug connector without connector	M: M-type plug connector with lead wire	MO: M-type plug connector without connector
	With light/surge voltage suppressor	With light/surge voltage suppressor	With light/surge voltage suppressor	With light/surge voltage suppressor

⚠ Caution

Use standard (DC) specification for continuous duty.

* The 25A-series specifications and dimensions are the same as those of the standard model.

For details, refer to the **Web Catalog**.

Body Ported
Plug Lead Unit

5-Port Solenoid Valve

25A-VQZ1000 Series

Manifold Connector Kit



How to Order Manifolds

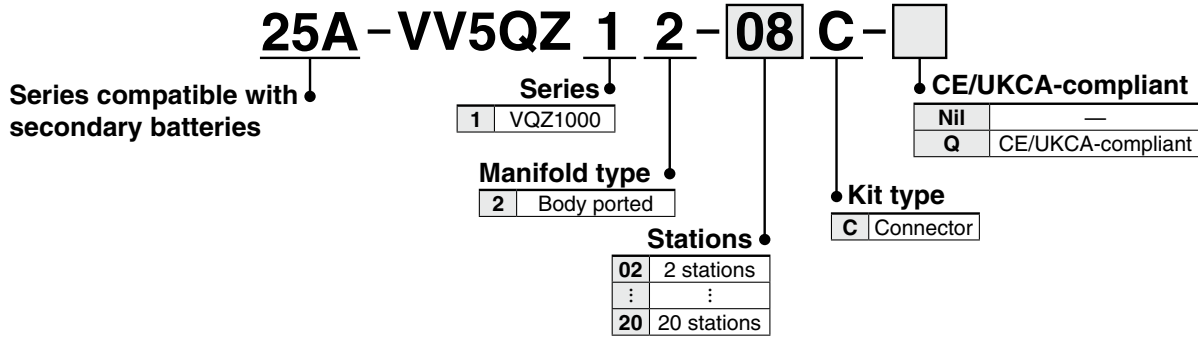

How to Order Valves

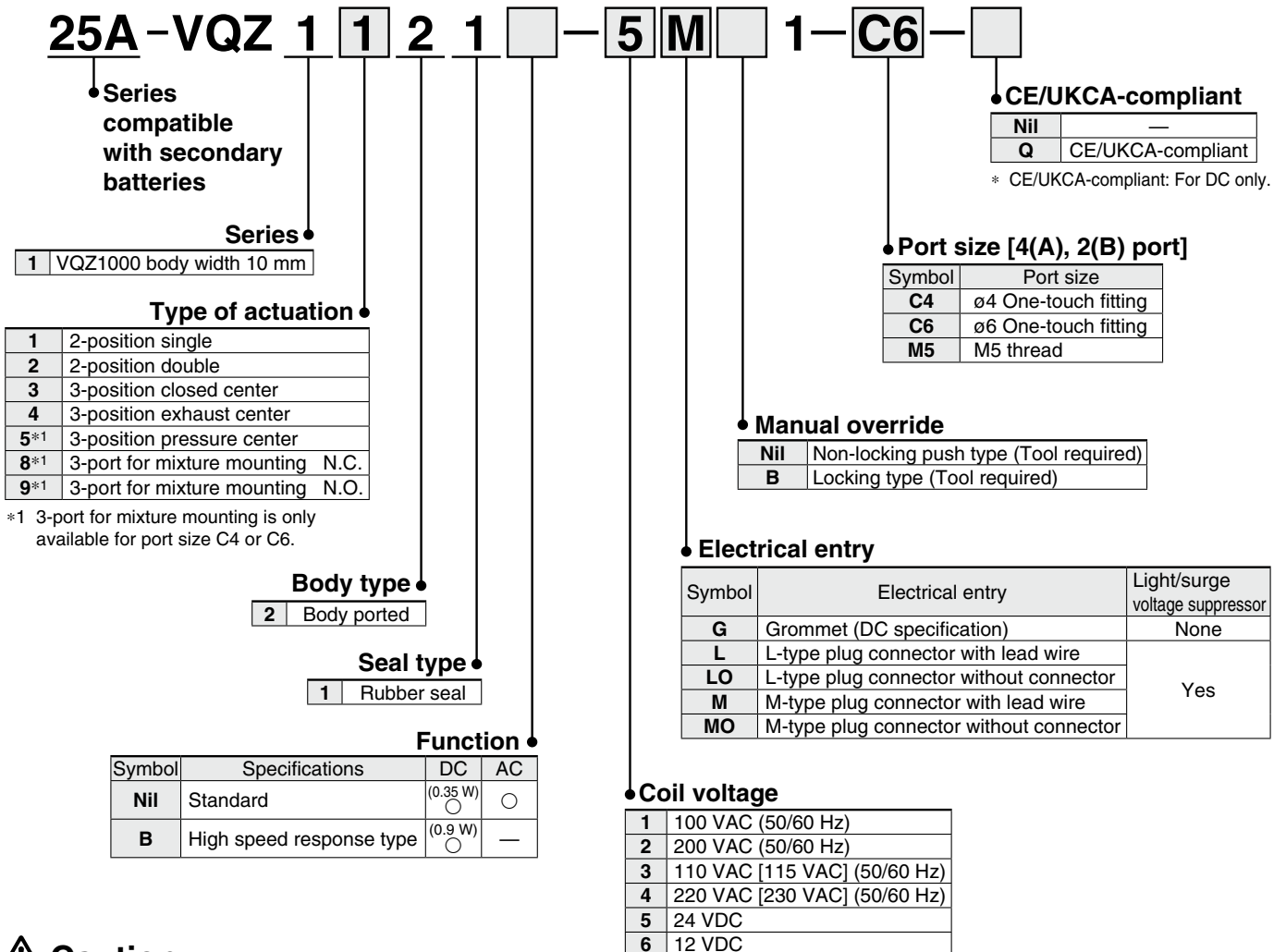

Caution
Use standard (DC) specification for continuous duty.

* The 25A- series specifications and dimensions are the same as those of the standard model.

For details, refer to the **Web Catalog**.

Directional Control Valves
Air Cylinders
Related Products
Rotary Actuators
Air Grippers
Vacuum Equipment
Air Preparation Equipment
Clean Air Filters
Modular F.R.L./Pressure Control Equipment
Flow Control Equipment/Fittings
Detection Switches
Fluid Control Equipment
Process Gas Equipment
Electric Actuators
Auto Switches

Plug-in Unit Base Mounted

25A-VQ1000/2000 Series

Double check block (Separated)

How to Order

Double check block

25A-VQ1000-FPG-C4M5-F

• Series compatible with secondary batteries

• IN side port size

M5	M5 thread
C3	ø3.2 One-touch fitting
C4	ø4 One-touch fitting
C6	ø6 One-touch fitting

• OUT side port size

M5	M5 thread
C3	ø3.2 One-touch fitting
C4	ø4 One-touch fitting
C6	ø6 One-touch fitting

• Option

Nil	None
F	With bracket
D	DIN rail mounting (For manifold)
N	Name plate

* When two or more symbols are specified, indicate them alphabetically.
Example) -DN

Manifold (DIN rail mounting)

25A-VVQ1000-FPG-06

• Series compatible with secondary batteries

When ordering a double check block, order the DIN rail mounting [-D].

<Ordering example>

25A-VVQ1000-FPG-06...6-station manifold

* 25A-VQ1000-FPG-C4M5-D; } Double check block
3 sets
* 25A-VQ1000-FPG-C6M5-D; }
3 sets

• Stations

01	1 station
⋮	⋮
16	16 stations

Bracket Assembly

Part no.	Tightening torque
25A-VQ1000-FPG-FB	0.22 to 0.25 N·m

Double check block

25A-VQ2000-FPG-0101-F

• Series compatible with secondary batteries

• IN side port size

01	Rc 1/8
02	Rc 1/4
C6	ø6 One-touch fitting
C8	ø8 One-touch fitting

• OUT side port size

01	Rc 1/8
02	Rc 1/4
C6	ø6 One-touch fitting
C8	ø8 One-touch fitting

• Option

Nil	None
D	DIN rail mounting (For manifold)
F	With bracket
N	Name plate

* When two or more symbols are specified, indicate them alphabetically.
Example) -DN

Manifold (DIN rail mounting)

25A-VVQ2000-FPG-06

• Series compatible with secondary batteries

When ordering a double check block, order the DIN rail mounting [-D].

<Ordering Example>

25A-VVQ2000-FPG-06...6-station manifold

* 25A-VQ2000-FPG-C6C6-D; } Double check block
3 sets
* 25A-VQ2000-FPG-C8C8-D; }
3 sets

• Stations

01	1 station
⋮	⋮
16	16 stations

Bracket Assembly

Part no.	Tightening torque
25A-VQ2000-FPG-FB	0.8 to 1.0 N·m

* The 25A- series specifications and dimensions are the same as those of the standard model.

For details, refer to the **Web Catalog**.

Rubber Seal 3-Port/Pilot Poppet Type 25A-VP342/542/742 Series

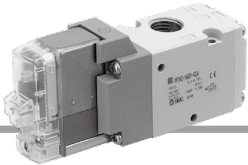

* Only DIN and conduit terminal types are available for AC mode. Refer to the electrical entry for details.

How to Order

Body ported **25A-VP 3 4 2** **5 D** **1-01** **A**

Series compatible with secondary batteries

Series

3	VP300
5	VP500
7	VP700

Pilot type

Nil	Internal pilot
R	External pilot

Pressure specification

Nil	Standard (0.7 MPa)
K	High pressure type (1.0 MPa)

Coil specification

Nil	Standard
T	With power-saving circuit (DC only)

- * Be sure to select the power-saving circuit type if it is to be continuously energized for long periods of time.
- * "T" type is only available for DC mode. When "T" is selected, only "Z" type of light/surge voltage suppressor is available.

Rated voltage

DC	AC (50/60 Hz)
5 24 VDC	1 100 VAC
6 12 VDC	2 200 VAC
	3 110 VAC [115 VAC]
	4 220 VAC [230 VAC]
	7 240 VAC
	B 24 VAC

Electrical entry

	DIN terminal [IP65 compatible]	DIN (EN175301-803) terminal [IP65 compatible]	Conduit terminal [IP65 compatible]
	D: With connector	Y: With connector	T: Conduit terminal
CE/UKCA-compliant	DC	DC	DC
	AC	AC	AC

Thread type

Nil	Rc
F	G
N	NPT
T	NPTF

Type of actuation

A	N.C. (Normally closed)
B	N.O. (Normally open)

Bracket

Nil	Without bracket
F	With bracket

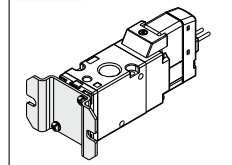

Port size

Symbol	Port size	VP300	VP500	VP700
01	1/8	○	—	—
02	1/4	○	○	—
03	3/8	—	○	○
04	1/2	—	—	○

Manual override

Nil: Non-locking push type	D: Push-turn locking slotted type	E: Push-turn locking lever type

Light/surge voltage suppressor

		DC	AC
Nil	Without light/surge voltage suppressor	○	○
S	With surge voltage suppressor	○	—*1
Z	With light/surge voltage suppressor	○	○
R	With surge voltage suppressor (Non-polar)	○	—
U	With light/surge voltage suppressor (Non-polar)	○	—

*1 There is no "S" type for AC mode, since a rectifier prevents surge voltage generation.

* The 25A- series specifications and dimensions are the same as those of the standard model.

For details, refer to the Web Catalog.

Rubber Seal

3-Port/Pilot Poppet Type

25A-VP344/544/744 Series



* Only DIN and conduit terminal types are available for AC mode. Refer to the electrical entry for details.

How to Order

Base mounted **25A-VP 3 4 4** - **5 D** **1-01** **A**

Series compatible with secondary batteries

Series

3	VP300
5	VP500
7	VP700

Pilot type

Nil	Internal pilot
R	External pilot

Pressure specifications

Nil	Standard (0.7 MPa)
K	High pressure type (1.0 MPa)

Coil specifications

Nil	Standard
T	With power-saving circuit (DC only)

* Be sure to select the power-saving circuit type if it is to be continuously energized for long periods of time.
* "T" type is only available for DC mode. When "T" is selected, only "Z" type of light/surge voltage suppressor is available.

Rated voltage

DC	AC (50/60 Hz)		
5	1	24 VDC	100 VAC
6	2	12 VDC	200 VAC
	3		110 VAC [115 VAC]
	4		220 VAC [230 VAC]
	7		240 VAC
	B		24 VAC

Thread type

Nil	Rc
F	G
N	NPT
T	NPTF

Type of actuation

A	N.C. (Normally closed)
B	N.O. (Normally open)

Port size (Sub-plate)

Symbol	Port size	VP300	VP500	VP700
Nil	Without sub-plate*1			
01	1/8	○	—	—
02	1/4	○	○	—
03	3/8	—	○	○
04	1/2	—	—	○

*1 With a gasket and two mounting bolts.

Electrical entry

	DIN terminal	DIN (EN175301-803) terminal	Conduit terminal
	[IP65 compatible]	[IP65 compatible]	[IP65 compatible]
	D: With connector	Y: With connector	T: Conduit terminal
CE/UKCA-compliant	DC	DC	DC
	AC	AC	AC

Manual override

Nil: Non-locking push type	D: Push-turn locking slotted type	E: Push-turn locking lever type

Light/surge voltage suppressor

		DC	AC
Nil	Without light/surge voltage suppressor	○	○
S	With surge voltage suppressor	○	—*1
Z	With light/surge voltage suppressor	○	○
R	With surge voltage suppressor (Non-polar)	○	—
U	With light/surge voltage suppressor (Non-polar)	○	—

*1 There is no "S" type for AC mode, since a rectifier prevents surge voltage generation.

* The 25A-series specifications and dimensions are the same as those of the standard model.

For details, refer to the **Web Catalog**.

3-Port Solenoid Valve/Residual Pressure Release Valve with Detection of Main Valve Position

25A-VP500/700-X536, X538, X555



How to Order

Residual pressure release valve 25A-VP 5 4 2 R - 5 D Z 1 - 03 [] - M [] - X536

Dual residual pressure release valve 25A-VP 5 4 4 R - 5 D Z 1 - 03 [] - M A - X538

Dual residual pressure release valve with soft start-up function 25A-VP 5 4 4 [] - 5 D Z 1 - 03 [] - M [] [] - X555

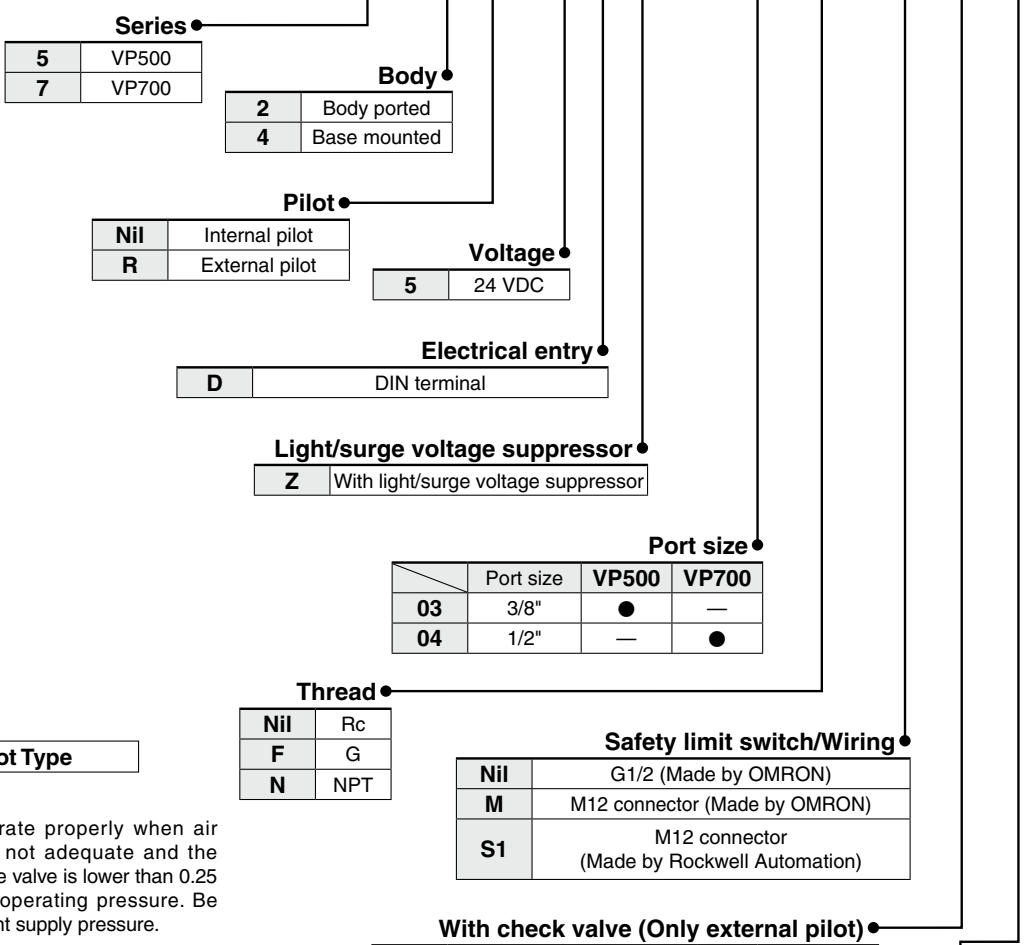

Internal Pilot Type

Caution
Valve may not operate properly when air supply to P port is not adequate and the supply pressure to the valve is lower than 0.25 MPa, the minimum operating pressure. Be careful with insufficient supply pressure.

Piping for External Pilot Type

Caution
The product may not operate when the external pilot pressure is insufficient due to simultaneous operation or restricted air piping. In this case, use the check valve (AKH series) with the external pilot port, change the piping size or adjust the set pressure to provide a constant pressure of 0.25 MPa or more.

Throttle

Nil	Variable throttle
10	ø1 fixed orifice
15	ø1.5 fixed orifice
20*	ø2 fixed orifice

* For the internal pilot, the symbol is nil.
* The 25A- series specifications and dimensions are the same as those of the standard model.
*1 VP700 only

For details, refer to the Web Catalog.

Directional Control Valves

Air Cylinders

Related Products

Rotary Actuators

Air Grippers

Vacuum Equipment

Air Preparation Equipment

Clean Air Filters

Modular F.R.L./Pressure Control Equipment

Flow Control Equipment/Fittings

Detection Switches

Fluid Control Equipment

Process Gas Equipment

Electric Actuators

Auto Switches

3-Port Solenoid Valve Direct Operated Poppet Type 25A-VT317 Series Rubber Seal



[Option]

* CE/UKCA-compliant:
For DIN terminal type.

How to Order

25A-V T 317 - 1 G - 02

Body type

T	Body ported
O	Manifold

Series compatible with secondary batteries

Valve option

Nil	Standard
E*1	Continuous duty type
V*1	For vacuum

*1 Semi-standard

Rated voltage

1	100 VAC (50/60 Hz)
2	200 VAC (50/60 Hz)
3*1	110 VAC (50/60 Hz)
4*1	220 VAC (50/60 Hz)
5	24 VDC
6*1	12 VDC
7*1	240 VAC (50/60 Hz)

*1 Semi-standard

* Applicable only for DIN terminal type.

Thread type

Nil	Rc
F	G
N	NPT
T	NPTF

CE/UKCA-compliant

Nil	—
Q	CE/UKCA-compliant*1

*1 Applicable only for DIN terminal type.

Port size

Nil	Without port (For manifold)
02	1/4 (8A)

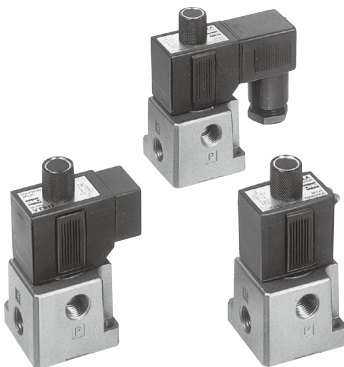

Electrical entry

		CE/UKCA-compliant
G	Grommet, 300 mm lead wire	—
H	Grommet, 600 mm lead wire	—
C	Conduit	—
D	DIN terminal	●

Light/Surge voltage suppressor

Electrical entry Symbol	CE/UKCA-compliant				
	G	H	C	D	D Only
Nil	●	●	●	●	●
S	●*1	●*1	●*1	●	●
Z	—	—	—	●	●

S: With surge voltage suppressor

*1 Refer to the figure below.

Z: With light/surge voltage suppressor

Surge voltage suppressor mounting part (For "G")

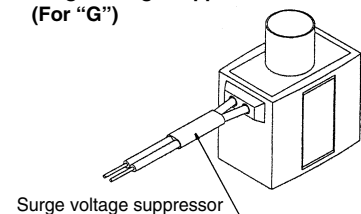

Manifold

Model	Applicable manifold type	Accessory
VO317(-Q)	Common or individual exhaust	O-ring (KA00066, 4 pcs.)*1 Bolts (XT012-25C#1, 2 pcs.)

*1 It is not applied to "Continuous duty type." Refer to the accessories in the **Web Catalog**.

* The 25A- series specifications and dimensions are the same as those of the standard model.

For details, refer to the **Web Catalog**.

3-Port Solenoid Valve Direct Operated Poppet Type **25A-VG342 Series** Rubber Seal

Low power consumption

4.8 W DC (Standard type)
2 W DC (Energy-saving type)

No lubrication required

Possible to use in vacuum or under low pressures

External pilot
Vacuum: Up to -101.2 kPa
Low pressure: 0 to 0.2 MPa

Changeable actuation:

N.C., N.O., or external pilot

Can be used as a selector or divider valve (External pilot)



How to Order

25A-VG342 [] - **5** **D** [] - **04** [] **A** - []

Series compatible with secondary batteries

Valve option

Nil	Internal pilot
R	External pilot

Rated voltage

5	24 VDC
6*1	12 VDC

*1 Semi-standard

Electrical entry

D	DIN terminal
---	--------------

Light/Surge voltage suppressor

Nil	None
z	With light/surge voltage suppressor (Except grommet type)

Pilot valve option

Nil	Standard type
Y*1	Energy-saving type (DC only)
E*1	Continuous duty type

*1 Semi-standard

Passage symbol

Nil	External pilot
A	N.C. (Normally closed)
B	N.O. (Normally open)

Thread type

Nil	Rc
-----	----

Port size

04	1/2
06	3/4
10	1

* The 25A- series specifications and dimensions are the same as those of the standard model.

For details, refer to the **Web Catalog**.

5-Port Air Operated Valve

25A-SYA5000/7000 Series

How to Order

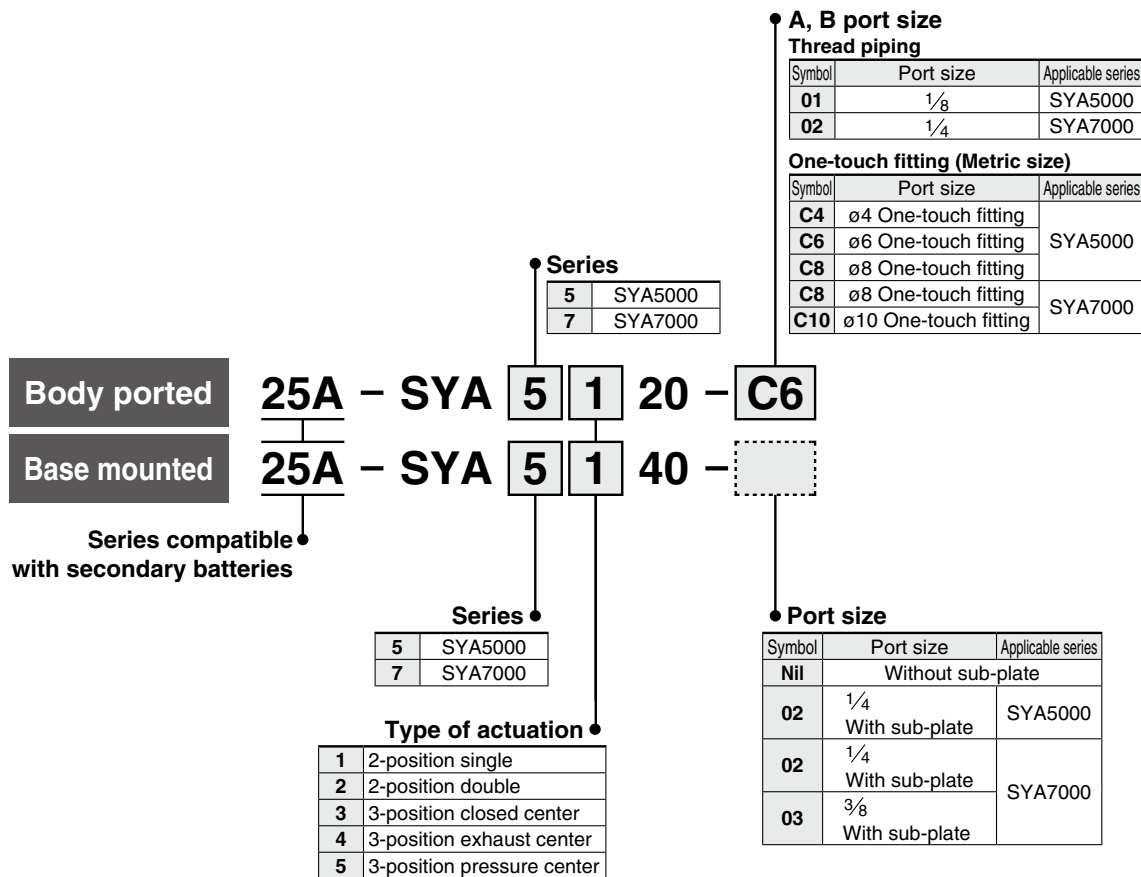

How to Order Manifold Base

Same manifolds as the SY series (Non plug-in type) are prepared.
(For 20, 41 and 42 Types)

25A-SS5YA⁵₇- [] Fill the same as 25A-SS5Y⁵₇.

(Refer to pages 61 and 63.)

* Specify the part numbers for valves and options together beneath the manifold base part number.

<Example>

25A-SS5YA5-42-03-02....1 set (Type 42, 3-station manifold base part no.)

* 25A-SYA5140 1 set (Single air operated valve part no.)

* 25A-SYA5240 1 set (Double air operated valve part no.)

* 25A-SY5000-26-1A 1 set (Blanking plate the assembly part no.)

↳The asterisk denotes the symbol for the assembly.

Prefix it to the part nos. of the solenoid valve, etc.

* When single body ported air operated valves are ordered, manifold mounting screws and gaskets are not included. Order them separately if necessary.

(For details, refer to page 66.)

* The 25A- series specifications and dimensions are the same as those of the standard model.

For details, refer to the **Web Catalog**.

3-Port Air Operated Valve

25A-SYJA500/700 Series

How to Order

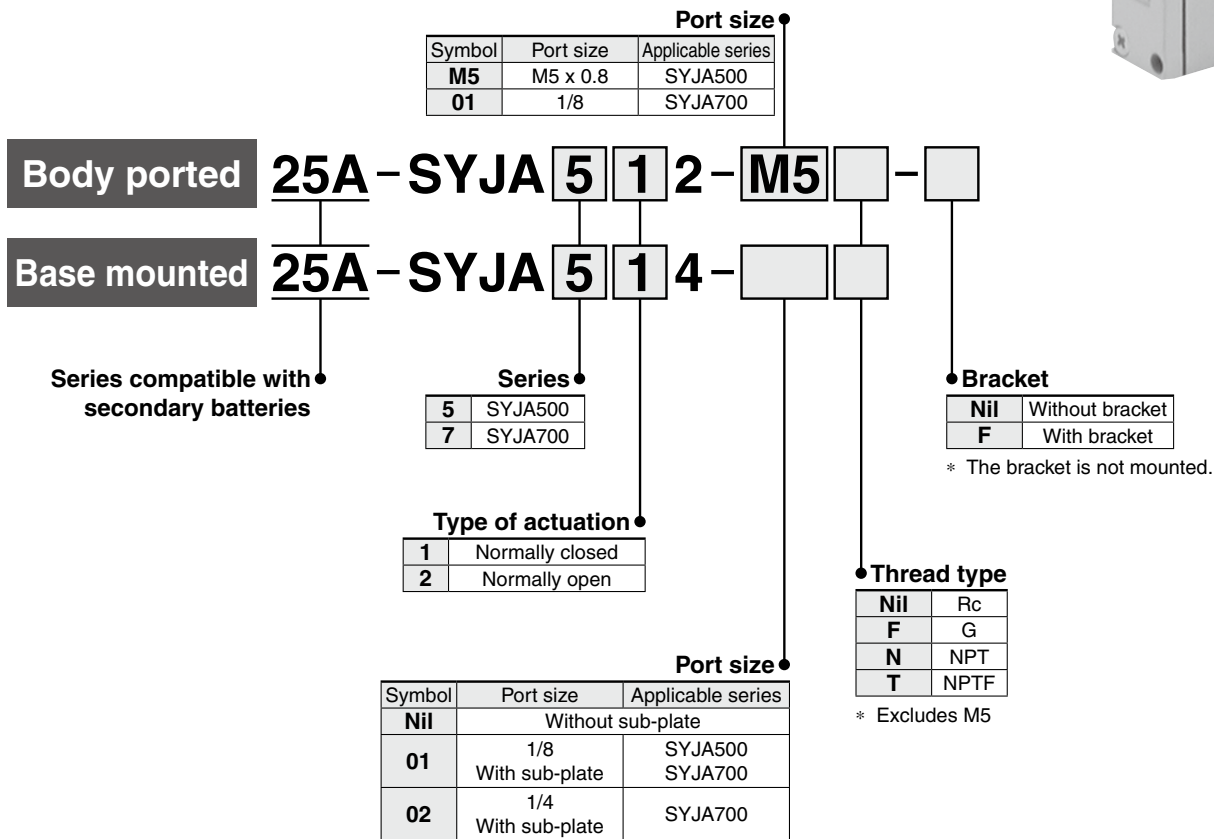

* The 25A- series specifications and dimensions are the same as those of the standard model.

For details, refer to the **Web Catalog**.

Directional Control Valves

Air Cylinders

Related Products

Rotary Actuators

Air Grippers

Vacuum Equipment

Air Preparation Equipment

Clean Air Filters

Modular F.R.L./Pressure Control Equipment

Flow Control Equipment/Fittings

Detection Switches

Fluid Control Equipment

Process Gas Equipment

Electric Actuators

Auto Switches

25A-SYJA500/700 Series

Manifold Type for the SYJA500

Type 20

How to Order

25A - SS3YJA5 - 20 - 05

Stations

02	2 stations
:	:
20	20 stations

Applicable valve
25A-SYJA5□2

Applicable blanking
plate assembly
25A-SYJ500-10-1A

* For more than 6 stations, supply air to both sides of P port and exhaust air from both sides of R port.

Type 40

How to Order

25A - SS3YJA5 - 40 - 05 M5

Stations

02	2 stations
:	:
20	20 stations

A port size

M5	M5 x 0.8
01	1/8

Applicable valve
25A-SYJA5□4

Applicable blanking
plate assembly
25A-SYJ500-10-3A

* For more than 9 stations, supply air to both sides of P port and exhaust air from both sides of R port.

Type 41

How to Order

25A - SS3YJA5 - 41 - 05 - C6

Stations

02	2 stations
:	:
20	20 stations

A port size

M5	M5 x 0.8
01	1/8
C4	ø4 One-touch fitting
C6	ø6 One-touch fitting

Applicable valve
25A-SYJA5□4

Applicable blanking
plate assembly
25A-SYJ500-10-3A

* For more than 9 stations, supply air to both sides of P port and exhaust air from both sides of R port.

Manifold Type for the SYJA700

Type 20/21

How to Order

25A - SS3YJA7 - 20 - 05

Manifold type

20	Type 20
21	Type 21

Stations

02	2 stations
:	:
20	20 stations

Applicable valve
25A-SYJA7□2

Applicable blanking
plate assembly
25A-SYJ700-10-1A

* If there are more than 6 stations for type 20, or more than 9 stations for type 21, supply air to both sides of P port and exhaust air from both sides of R port.

Type 40/41

How to Order

25A - SS3YJA7 - 40 - 05 - 01

Manifold type

40	Type 40
41	Type 41

A port size

01	1/8
----	-----

Stations

02	2 stations
:	:
20	20 stations

Applicable valve
25A-SYJA7□4

Applicable blanking
plate assembly
25A-SYJ700-10-2A

* If there are more than 6 stations for type 40, or more than 9 stations for type 41, supply air to both sides of P port and exhaust air from both sides of R port.

Type 42

How to Order

25A - SS3YJA7 - 42 - 05 - C6

Stations

02	2 stations
:	:
20	20 stations

A port size

01	1/8
C6	ø6 One-touch fitting
C8	ø8 One-touch fitting

Applicable valve
25A-SYJA7□4

Applicable blanking
plate assembly
25A-SYJ700-10-2A

* For more than 9 stations, supply air to both sides of P port and exhaust air from both sides of R port.

Finger Valve

RoHS

25A-VHK□A Series

How to Order

Series compatible with secondary batteries

25A-VHK **2** A - **04F** - **04F** □ □

Valve model

2	2-port valve
3	3-port valve

1(P) port size

04F	ø4
06F	ø6
08F	ø8
01S	R 1/8
02S	R 1/4
03S	R 3/8

Bracket

Nil	None
L	With L-bracket

* Bracket and screws are attached.

Knob color

Nil (Standard)	2-port valve	Gray
	3-port valve	Blue
R (Option)	2-port valve	Red
	3-port valve	

2(A) port size

04F	ø4
06F	ø6
08F	ø8
01S	R 1/8
02S	R 1/4
03S	R 3/8

Standard Type

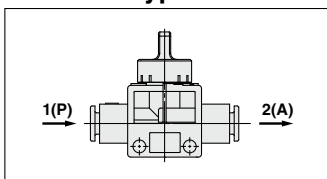

1(P): One-touch fitting
2(A): One-touch fitting

		2(A) Applicable tubing O.D. [mm]		
		ø4	ø6	ø8
Applicable tubing O.D. [mm]	ø4	●		
	ø6	●	●	
	ø8		●	●

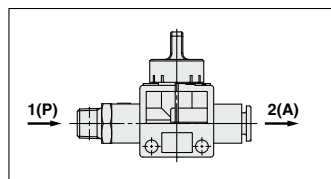

1(P): Male thread
2(A): One-touch fitting

		2(A) Applicable tubing O.D. [mm]		
		ø4	ø6	ø8
Port size R	1/8	●	●	●
	1/4		●	●
	3/8		●	●

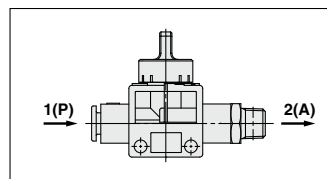

1(P): One-touch fitting
2(A): Male thread

		2(A) Port size R		
		1/8	1/4	3/8
Applicable tubing O.D. [mm]	ø4	●		
	ø6	●	●	●
	ø8	●	●	●

* The 25A- series specifications and dimensions are the same as those of the standard model.

For details, refer to the **Web Catalog**.

OSHA Standard Compliant Pressure Relief 3-Port Valve with Locking Holes

Single Action

25A-VHS20/30/40/50-D Series

RoHS

Double Action

25A-VHS20W/30W/40W/50W-D Series

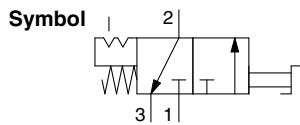

How to Order

25A-VHS 30 - 03 - - - **D**

1
 2
 3
 4
 5
 6

• Series compatible with secondary batteries

· Option/Semi-standard: Select one each for a to f.
 · Option/Semi-standard symbol:
 When more than one specification is required, indicate in alphanumeric order.
 Example) 25A-VHS30-N03-BS-RZ-D

	Symbol	Description	①					
			Body size					
			20	30	40	50		
②	Handle operation	Nil	Single action					
		W	Double action					
+								
③	Pipe thread type	Nil	Rc*1					
		N	NPT					
		F	G					
+								
④	Port size	01	1/8					
		02	1/4					
		03	3/8					
		04	1/2					
		06	3/4					
+								
⑤	Option	a	Mounting	Nil	Without mounting option			
				B	With bracket			
+								
b	Silencer	Nil	Without silencer					
		S	With built-in silencer (for EXH port)					
+								
⑥	Semi-standard	c	Handle color	Nil	Red			
				K	Black			
		+						
		d	Handle material	Nil	Resin			
				M	Metal			
+								
e	Flow direction	Nil	Flow direction: Left to right					
		R	Flow direction: Right to left					
+								
f	Pressure unit	Nil	Product label in SI units: MPa					
		Z*2	Product label in imperial units: psi					

*1 The pipe thread type for the EXH port is G.

*2 For the pipe thread type: NPT only. This product is for overseas use only according to the New Measurement Act. (The SI unit type is provided for use in Japan.)

*3 ○: For the pipe thread type: NPT only

Option/Part Nos.

Optional specifications	Model				
	25A-VHS20-D	25A-VHS30-D	25A-VHS40-D	25A-VHS40-06-D	25A-VHS50-D
Bracket assembly*1	25A-VHS24P-180AS	25A-VHS34P-180AS	25A-VHS44P-180AS	25A-VHS44P-180AS	25A-VHS54P-180AS
Silencer assembly*2	VHS24P-190AS	VHS34P-190AS	VHS44P-190AS	VHS54P-190AS	VHS54P-190AS

*1 The assembly consists of a bracket A/B and 2 mounting screws.

*2 The assembly consists of the element assembly and an O-ring.

* The 25A- series specifications and dimensions are the same as those of the standard model.

For details, refer to the Web Catalog.

Conforming to OSHA Standard

Pressure Relief 3-Port Valve with Locking Holes (Single Action)

25A-VHS20/30/40/50 Series

RoHS

How to Order

Single action **25A - VHS 40 - [] 04 A - B - [] - []**

Series compatible with secondary batteries
 Pressure relief 3-port valve

Body size

Symbol	Body size
20	20
30	30
40	40
50	50

Thread type

Symbol	Thread type
Nil	Rc
N	NPT
F	G

Port size

Symbol	Port size	Body size			
		20	30	40	50
01	1/8	●	—	—	—
02	1/4	●	●	●	—
03	3/8	—	●	●	—
04	1/2	—	—	●	—
06	3/4	—	—	●	●
10	1	—	—	—	●

Handle/Bonnet material

Symbol	Material
A	Flame-resistant PBT
B	Aluminum

Made to order

Symbol	Description
X1	Body: Red

Semi-standard specifications

Symbol	Description
Nil	—
K	Handle color: Black
R	Flow direction: Right → Left
Z*1	psi as unit displayed on label

*1 Only for the NPT thread
 This product is for overseas use only according to the New Measurement Act. (The SI unit type is provided for use in Japan.)

Options

Symbol	Description
Nil	—
B	With bracket

Option Part Nos.

Model	Bracket assembly part no.*1
25A-VHS20	VHS20PW-180AS-6
25A-VHS30	VHS30PW-180AS-6
25A-VHS40	VHS40PW-180AS-6
25A-VHS40-06	VHS40PW-180-06AS-6
25A-VHS50	VHS50PW-180AS-6

*1 Bracket/1 pc., Mounting screw/2 pcs.

OSHA standard (Occupational Safety and Health Administration Department of Labor)

For safety control, OSHA rule requires energy sources for certain equipment be turned off or disconnected and that the device either be locked or labelled with a warning tag.

* The 25A- series specifications and dimensions are the same as those of the standard model.

For details, refer to the **Web Catalog**.

Directional Control Valves

Air Cylinders

Related Products

Rotary Actuators

Air Grippers

Vacuum Equipment

Air Preparation Equipment

Clean Air Filters

Modular F.R.L./Pressure Control Equipment

Flow Control Equipment/Fittings

Detection Switches

Fluid Control Equipment

Process Gas Equipment

Electric Actuators

Auto Switches

Conforming to OSHA Standard

Pressure Relief 3-Port Valve with Locking Holes (Double Action)

25A-VHS2510/3510/4510/5510 Series

RoHS

How to Order

Double action 25A - VHS 4 510 - [] 04 A - B - [] - []

Series compatible with secondary batteries
Pressure relief 3-port valve

Body size

Symbol
2
3
4
5

Double action

Thread type

Nil	Rc
N	NPT
F	G

Port size

Symbol	Port size	Body size			
		2	3	4	5
01	1/8	●	—	—	—
02	1/4	●	●	●	—
03	3/8	—	●	●	—
04	1/2	—	—	●	—
06	3/4	—	—	●	●
10	1	—	—	—	●

Handle/Bonnet material

Symbol	Material
A	Flame-resistant PBT
B	Aluminum

Made to order

Symbol	Description
X1	Body: Red

Semi-standard specifications

Symbol	Description
Nil	—
K	Handle color: Black
R	Flow direction: Right → Left
Z*1	psi as unit displayed on label

*1 Only for the NPT thread
This product is for overseas use only according to the New Measurement Act. (The SI unit type is provided for use in Japan.)

Options

Symbol	Description
Nil	—
B	With bracket

Option Part Nos.

Model	Bracket assembly part no.*1
25A-VHS2510	VHS20PW-180AS-6
25A-VHS3510	VHS30PW-180AS-6
25A-VHS4510	VHS40PW-180AS-6
25A-VHS4510-06	VHS40PW-180-06AS-6
25A-VHS5510	VHS50PW-180AS-6

*1 Bracket/1 pc., Mounting screw/2 pcs.

OSHA standard (Occupational Safety and Health Administration Department of Labor)

For safety control, OSHA rule requires energy sources for certain equipment be turned off or disconnected and that the device either be locked or labelled with a warning tag.

* The 25A- series specifications and dimensions are the same as those of the standard model.

For details, refer to the Web Catalog.