

Mist Separator

AFM20 to AFM40

Micro Mist Separator

AFD20 to AFD40

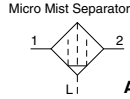
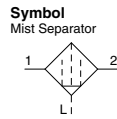

AFM20, AFD20 AFM40, AFD40

- Series AFM Nominal filtration rating: 0.3 μ m
- Series AFD Nominal filtration rating: 0.01 μ m

How to Order

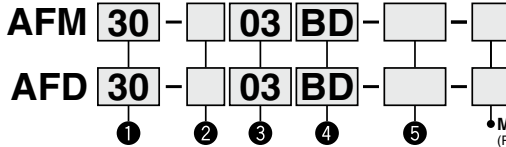

- Option/Semi-standard: Select one each for a to f.
- Option/Semi-standard symbol: When more than one specification is required, indicate in alphanumeric order.
Example) AFM30-03BD-2R

• Made to Order
(Refer to pages 493 and 494 for details.)

		Symbol	Description	①			
				Body size			
				20	30	40	
②	Thread type	Nil	Rc	●	●	●	
		N ^{Note 1)}	NPT	●	●	●	
		F ^{Note 2)}	G	●	●	●	
		+					
③	Port size	01	1/8	●	—	—	
		02	1/4	●	●	●	
		03	3/8	—	●	●	
		04	1/2	—	—	●	
		06	3/4	—	—	●	
		+					
④	a	Mounting	Nil	Without mounting option	●	●	●
			B ^{Note 3)}	With bracket	●	●	●
		+					
④	b	Float type auto drain ^{Note 4)}	Nil	Without auto drain	●	●	●
			C	Float type auto drain (N.C.)	●	●	●
			D	Float type auto drain (N.O.)	—	●	●
		+					
⑤	c	Bowl ^{Note 5)}	Nil	Polycarbonate bowl	●	●	●
			2	Metal bowl	●	●	●
			6	Nylon bowl	●	●	●
			8	Metal bowl with level gauge	—	●	●
			C	With bowl guard	●	—	—
			6C	Nylon bowl with bowl guard	●	—	—
		+					
⑤	d	Drain port	Nil	With drain cock	●	●	●
			J ^{Note 6)}	Drain guide 1/8	●	—	—
			W ^{Note 7)}	Drain cock with barb fitting: For $\phi 6 \times \phi 4$ nylon tube	—	●	●
		+					
⑤	e	Flow direction	Nil	Flow direction: Left to right	●	●	●
			R	Flow direction: Right to left	●	●	●
		+					
⑤	f	Pressure unit	Nil	Name plate and caution plate for bowl in imperial units: MPa	●	●	●
			Z ^{Note 8)}	Name plate and caution plate for bowl in imperial units: psi, °F	○ ^{Note 9)}	○ ^{Note 9)}	○ ^{Note 9)}

Note 1) Drain guide is NPT1/8 (applicable to the AFM20, AFD20) and NPT1/4 (applicable to the AFM30/40, AFD30/40).

The auto drain port comes with $\phi 3/8"$ one-touch fitting (applicable to the AFM30/40, AFD30/40).

Note 2) Drain guide is G1/8 (applicable to the AFM20, AFD20) and G1/4 (applicable to the AFM30/40, AFD30/40).

Note 3) A bracket is not assembled and supplied loose at the time of shipment. Including 2 mounting screws

Note 4) Float type auto drain: The combination of C and D is not possible.

Note 5) Refer to Chemical Data on page 365 when selecting a case material.

Note 6) Without a valve function

Note 7) Metal bowl: The combination of 2 and 8 is not possible.

Note 8) For thread type: NPT. This product is for overseas use only according to the new Measurement Law. (The SI unit type is provided for use in Japan.)

Note 9) ○: For thread type: NPT only

Mist Separator *Series AFM20 to AFM40* Micro Mist Separator *Series AFD20 to AFD40*

Standard Specifications

Model		AFM20 AFD20	AFM30 AFD30	AFM40 AFD40	AFM40-06 AFD40-06
Port size		1/8, 1/4	1/4, 3/8	1/4, 3/8, 1/2	3/4
Fluid		Air			
Ambient and fluid temperature		-5 to 60°C (with no freezing)			
Proof pressure		1.5 MPa			
Maximum operating pressure		1.0 MPa			
Minimum operating pressure		0.05 MPa			
Nominal filtration rating	AFM20 to AFM40-06	0.3 μm (99.9% filtered particle size)			
	AFD20 to AFD40-06	0.01 μm (99.9% filtered particle size)			
Outlet side oil mist concentration	AFM20 to AFM40-06	Max. 1.0 mg/m ³ (ANR) (= 0.8 ppm) ^{Note 2) Note 3)}			
	AFD20 to AFD40-06	Max. 0.1 mg/m ³ (ANR) (Before saturated with oil 0.01 mg/m ³ (ANR) or less = 0.008 ppm) ^{Note 2) Note 3)}			
Rated flow (L/min (ANR)) ^{Note 1)}	AFM20 to AFM40-06	200	450	1100	
	AFD20 to AFD40-06	120	240	600	
Drain capacity (cm ³)		8	25	45	
Bowl material		Polycarbonate			
Bowl guard		Semi-standard	Standard		
Weight (kg)		0.10	0.22	0.44	0.49

Note 1) Conditions: Inlet pressure: 0.7 MPa; The rated flow varies depending on the inlet pressure. Keep the air flow within the rated flow to prevent an outflow of lubricant to the outlet side.

Note 2) When the compressor oil mist discharge concentration is 30 mg/m³ (ANR).

Note 3) Bowl O-ring and other O-rings are slightly lubricated.

Options/Part No.

Optional specifications		Model			
		AFM20 AFD20	AFM30 AFD30	AFM40 AFD40	AFM40-06 AFD40-06
Bracket assembly ^{Note 1)}		AF20P-050AS	AF30P-050AS	AF40P-050AS	AF40P-070AS
Float type auto drain ^{Note 2) Note 3)}	N.C.	AD27	AD37	AD47	
	N.O.	—	AD38	AD48	

Semi-standard/Bowl Assembly Part No.

Semi-standard specifications						Model			
Bowl material	Note 2) Note 3) Float type auto drain		Note 3) With drain guide	With barb fitting	With bowl guard	AFM20 AFD20	AFM30 AFD30	AFM40 AFD40	AFM40-06 AFD40-06
	N.C.	N.O.							
Polycarbonate	—	—	—	—	●	C2SF-C	—	—	—
	●	—	—	—	●	AD27-C	—	—	—
	—	—	●	—	—	C2SF-J	C3SF-J	—	C4SF-J
	—	—	—	●	—	—	C3SF-W	—	C4SF-W
	—	—	●	—	●	C2SF-CJ	—	—	—
Nylon	—	—	—	—	—	C2SF-6	C3SF-6	—	C4SF-6
	—	—	—	—	●	C2SF-6C	—	—	—
	●	—	—	—	—	AD27-6	AD37-6	—	AD47-6
	—	●	—	—	—	—	AD38-6	—	AD48-6
	●	—	—	—	●	AD27-6C	—	—	—
	—	—	●	—	—	C2SF-6J	C3SF-6J	—	C4SF-6J
	—	—	—	●	—	—	C3SF-6W	—	C4SF-6W
Metal	—	—	—	—	●	C2SF-6CJ	—	—	—
	—	—	—	—	—	C2SF-2	C3SF-2	—	C4SF-2
	●	—	—	—	—	AD27-2	AD37-2	—	AD47-2
	—	●	—	—	—	—	AD38-2	—	AD48-2
Metal bowl with level gauge	—	—	●	—	—	C2SF-2J	C3SF-2J	—	C4SF-2J
	—	—	—	—	—	—	C3LF-8	—	C4LF-8
	●	—	—	—	—	—	AD37-8	—	AD47-8
	—	●	—	—	—	—	AD38-8	—	AD48-8
	—	—	●	—	—	—	C3LF-8J	—	C4LF-8J

Note 1) Assembly of a bracket and 2 mounting screws

Note 2) Minimum operating pressure: N.O. type-0.1 MPa; N.C. type-0.1 MPa (AD27) and 0.15 MPa (AD37/47).

Please consult with SMC separately for psi and "F" unit display specifications.

Note 3) Please consult with SMC for details on drain piping to fit NPT or G port sizes.

Note) • Bowl O-ring is included.

• Bowl assembly for the AFM30 to AFM40-06 models and AFD30 to AFD40-06 models comes with a bowl guard (steel band material). (except when the bowl material is metal)

Series AFM20 to AFM40

Series AFD20 to AFD40

Flow Characteristics (Representative values)

— : When saturated with oil
 - - - : Initial state

AFM20

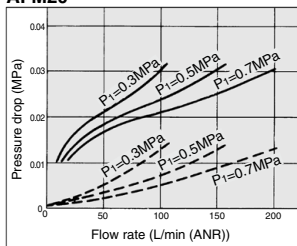

AFM30

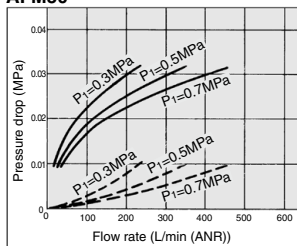

AFM40

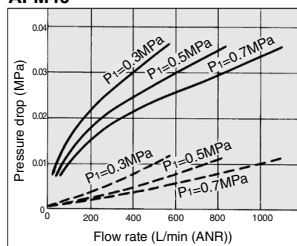

AFD20

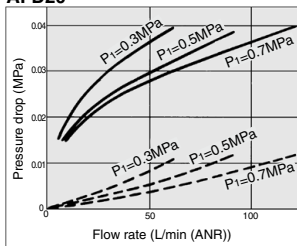

AFD30

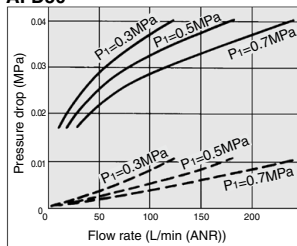

AFD40

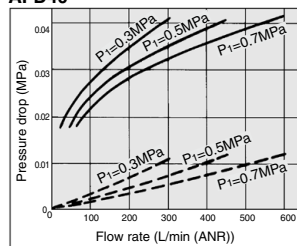

⚠ Specific Product Precautions

Be sure to read before handling.

Refer to front matter 43 for Safety Instructions and pages 365 to 369 for F.R.L. Precautions.

Air Supply

⚠ Caution

1. Install an air filter (AF series) as a pre-filter on the inlet side of the mist separator to prevent premature clogging.
2. Install a mist separator (AFM series) as a pre-filter on the inlet side of the micro mist separator to prevent premature clogging.
3. Do not install on the inlet side of the dryer as this can cause premature clogging of the element.

Maintenance

⚠ Warning

1. Replace the element every 2 years or when the pressure drop becomes 0.1 MPa, whichever comes first, to prevent damage to the element.

Design

⚠ Caution

1. Design the system so that the mist separator is installed in a pulsation-free location. The difference between internal and external pressure inside the element should be kept within 0.1 MPa, as exceeding this value could cause damage.

Selection

⚠ Caution

1. Do not allow air flow that exceeds the rated flow. If the air flow is allowed outside the range of the rated flow even momentarily, drainage and lubricant may splash at the outlet side or cause damage to the component.
2. Do not use in a low pressure application (such as a blower). F.R.L. unit has its own minimum operating pressure depending on the equipment and is designed specifically to function with compressed air. If used below the minimum operating pressure, a loss of performance and malfunction can occur. Please contact SMC if an application under such conditions cannot be avoided.

Mist Separator *Series AFM20 to AFM40* Micro Mist Separator *Series AFD20 to AFD40*

Construction

**AFM20
AFD20**

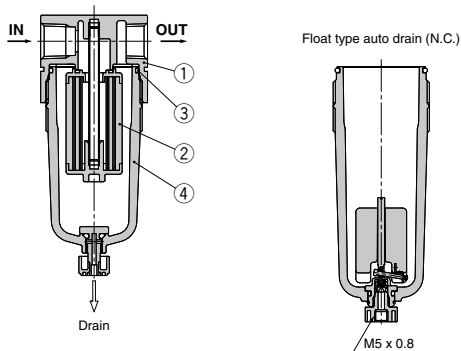

**AFM30 to AFM40-06
AFD30 to AFD40-06**

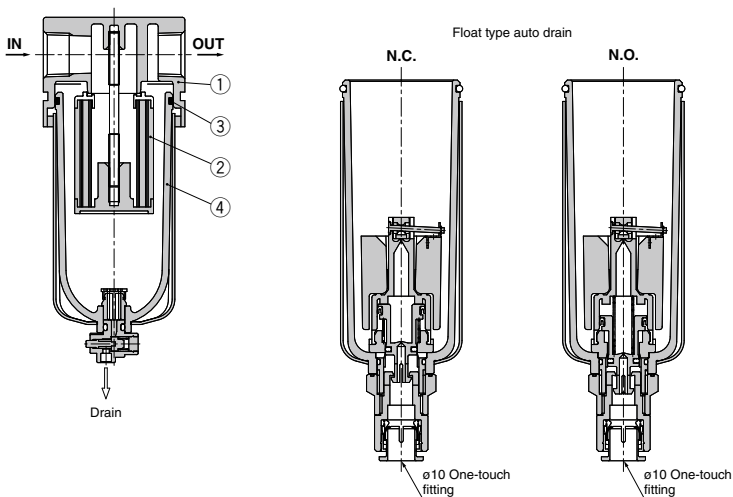

- AC-A
- AF-A
- AF□-A
- AR-A
- AL-A
- AW-A
- AC
- AF
- AF□**
- AR
- AL
- AW□
- A□G
- E□
- AV
- AF

Component Parts

No.	Description	Material	Model	Color
1	Body	Aluminum die-cast	AFM20 to AFM40-06 AFD20 to AFD40-06	Platinum silver

Replacement Parts

No.	Description	Material	Part no.			
			AFM20 AFD20	AFM30 AFD30	AFM40 AFD40	AFM40-06 AFD40-06
2	Element assembly	AFM20 to 40	AFM20P-060AS	AFM30P-060AS	AFM40P-060AS	
		AFD20 to 40	AFD20P-060AS	AFD30P-060AS	AFD40P-060AS	
3	Bowl O-ring	NBR	C2SFP-260S	C3SFP-260S	C4SFP-260S	
4	Bowl assembly <small>Note 1)</small>	Polycarbonate	C2SF	C3SF <small>Note 2)</small>	C4SF <small>Note 2)</small>	

Note 1) Bowl O-ring is included. Please contact SMC regarding the bowl assembly supply for psi and "F unit specifications.

Note 2) Bowl assembly for the AFM30 to AFM40-06 models and the AFD30 to AFD40-06 models comes with a bowl guard (steel band material).

Series AFM20 to AFM40

Series AFD20 to AFD40

Dimensions

AFM20
AFD20

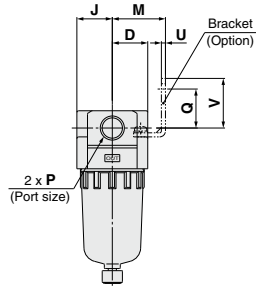
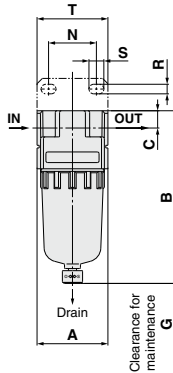

AFM30 to AFM40-06
AFD30 to AFD40-06

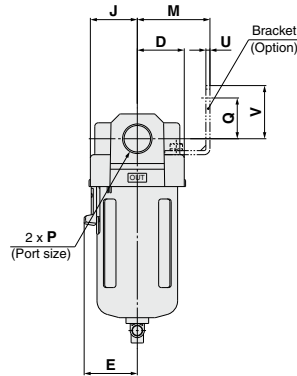
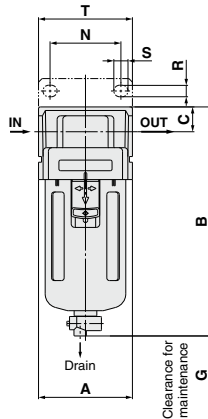

Applicable model Optional/Semi-standard specifications	AFM20, AFD20				AFM30 to AFM40-06, AFD30 to AFD40-06							
	With auto drain (N.C.)	Metal bowl	With drain guide	With auto drain (N.O./N.C.)	Metal bowl	Metal bowl with level gauge	With drain guide	With drain guide	Drain cock with barb fitting			
Dimensions												

Model	Standard specifications										Optional specifications							
											Bracket mount							With auto drain
	P	A	B	C	D	E	G	J	M	N	Q	R	S	T	U	V	B	
AFM20/AFD20	1/8, 1/4	40	97	10	20	—	40	20	30	27	22	5.4	8.4	40	2.3	28	115	
AFM30/AFD30	1/4, 3/8	53	129	14	26.5	30	50	26.5	41	40	23	6.5	8	53	2.3	30	170	
AFM40/AFD40	1/4, 3/8, 1/2	70	165	18	35	38	75	35	50	54	26	8.5	10.5	70	2.3	35	204	
AFM40-06/AFD40-06	3/4	75	169	20	35	38	75	35	50	54	25	8.5	10.5	70	2.3	34	208	

Model	Semi-standard specifications			
	With barb fitting	With drain guide	Metal bowl	Metal bowl with level gauge
	B	B	B	B
AFM20/AFD20	—	101	97	—
AFM30/AFD30	137	136	142	162
AFM40/AFD40	173	172	178	198
AFM40-06/AFD40-06	177	176	182	202

Mist Separator *AFM20 to AFM40* Micro Mist Separator *AFD20 to AFD40* Made to Order Specifications:

Please contact SMC for detailed dimensions, specifications, and lead times.



① Long Bowl

Drain capacity is greater than that of standard models.

Applicable Model/Drain Capacity

Model	AFM20, AFD20	AFM30, AFD30	AFM40, AFD40	AFM40-06, AFD40-06
Port size	1/8, 1/4	1/4, 3/8	1/4, 3/8, 1/2	3/4
Drain capacity (cm ³)	19	43		88

Note) Please consult with SMC for dimensions.

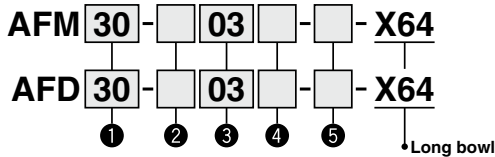

- Semi-standard: Select one each for a to d.
- Option/Semi-standard symbol: When more than one specification is required, indicate in alphanumeric order.
Example) AFM30-03B-2R-X64

	Symbol	Description	①				
			Body size				
			20	30	40		
②	Thread type	Nil	Rc	●	●	●	
		N <small>Note 1)</small>	NPT	●	●	●	
		F <small>Note 2)</small>	G	●	●	●	
+							
③	Port size	01	1/8	●	—	—	
		02	1/4	●	●	●	
		03	3/8	—	●	●	
		04	1/2	—	—	●	
		06	3/4	—	—	●	
+							
④	Option (Mounting)	Nil	Without mounting option	●	●	●	
		B <small>Note 3)</small>	With bracket	●	●	●	
+							
⑤ Semi-standard	a	Bowl <small>Note 4)</small>	Nil	Polycarbonate bowl	●	●	●
			2	Metal bowl	●	●	●
			6	Nylon bowl	●	●	●
			C	With bowl guard	●	—	—
			6C	Nylon bowl with bowl guard	●	—	—
	+						
	b	Drain port	Nil	With drain cock	●	—	●
			J <small>Note 5)</small>	Drain guide 1/8	●	—	—
				Drain guide 1/4	—	●	●
			W <small>Note 6)</small>	Drain cock with barb fitting: For ø6 x ø4 nylon tube	—	●	●
+							
c	Flow direction	Nil	Flow direction: Left to right	●	●	●	
		R	Flow direction: Right to left	●	●	●	
+							
d	Pressure unit	Nil	Name plate and caution plate for bowl in imperial units: MPa	●	●	●	
		Z <small>Note 7)</small>	Name plate and caution plate for bowl in imperial units: psi, °F	○ <small>Note 8)</small>	○ <small>Note 8)</small>	○ <small>Note 8)</small>	

Note 1) Drain guide is NPT1/8 (applicable to the AFM20, AFD20) and NPT1/4 (applicable to the AFM30/40, AFD30/40).

Note 2) Drain guide is G1/8 (applicable to the AFM20, AFD20) and G1/4 (applicable to the AFM30/40, AFD30/40).

Note 3) A bracket is not assembled and supplied loose at the time of shipment. Including 2 mounting screws

Note 4) Refer to Chemical Data on page 365 when selecting a case material.

Note 5) Without a valve function

Note 6) Metal bowl: The combination with 2 is not possible.

Note 7) For thread type: NPT. This product is for overseas use only according to the new Measurement Law. (The SI unit type is provided for use in Japan.)

Note 8) ○: For thread type: NPT only

Mist Separator *AFM30 to AFM40* Micro Mist Separator *AFD30 to AFD40* Made to Order Specifications:



Please contact SMC for detailed dimensions, specifications, and lead times.

② With Element Service Indicator

Clogging status of elements can be checked visually.

Applicable Model

Model	AFM30, AFD30	AFM40, AFD40	AFM40-06, AFD40-06
Port size	1/4, 3/8	1/4, 3/8, 1/2	3/4

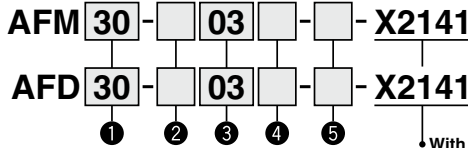

A special body type is required to mount the clogging checker. It cannot be mounted on a standard body.

- Option/Semi-standard: Select one each for a to f.
- Option/Semi-standard symbol: When more than one specification is required, indicate in alphanumeric order. Example) AF30-03BD-2R-X2141

		Symbol	Description	①			
				Body size			
				30	40		
②	Thread type	Nil	Rc	●	●		
		N ^{Note 1)}	NPT	●	●		
		F ^{Note 2)}	G	●	●		
		+					
③	Port size	02	1/4	●	●		
		03	3/8	●	●		
		04	1/2	—	●		
		06	3/4	—	●		
		+					
④	Option	a	Mounting	Nil	Without mounting option	●	●
				B ^{Note 3)}	With bracket	●	●
		+					
④	Option	b	Float type auto drain	Nil	Without auto drain	●	●
				C	Float type auto drain (N.C.)	●	●
				D	Float type auto drain (N.O.)	●	●
		+					
⑤	Semi-standard	c	Bowl ^{Note 4)}	Nil	Polycarbonate bowl	●	●
				2	Metal bowl	●	●
				6	Nylon bowl	●	●
				8	Metal bowl with level gauge	●	●
				+			
⑤	Semi-standard	d	Drain port ^{Note 5)}	Nil	With drain cock	●	●
				J ^{Note 6)}	Drain guide 1/4	●	●
				W ^{Note 7)}	Drain cock with barb fitting: For ø6 x ø4 nylon tube	●	●
		+					
⑤	Semi-standard	e	Flow direction	Nil	Flow direction: Left to right	●	●
				R	Flow direction: Right to left	●	●
		+					
⑤	Semi-standard	f	Pressure unit	Nil	Name plate and caution plate for bowl in imperial units: MPa	●	●
				Z ^{Note 8)}	Name plate and caution plate for bowl in imperial units: psi, °F	○ ^{Note 9)}	○ ^{Note 9)}

Note 1) Drain guide is NPT1/4.

The auto drain port comes with ø3/8" one-touch fitting.

Note 2) Drain guide is G1/4.

Note 3) Option B is not assembled and supplied loose at the time of shipment.

Including 2 mounting screws

Note 4) Refer to Chemical Data on page 365 when selecting a case material.

Note 5) Float type auto drain: The combination of C and D is not possible.

Note 6) Without a valve function

Note 7) Metal bowl: The combination between 2 and 8 is not possible.

Note 8) For thread type: NPT. This product is for overseas use only according to the new Measurement Law. (The SI unit type is provided for use in Japan.)

Note 9) ○: For thread type: NPT only