







Air Cylinder

Series CG1

ø20, ø25, ø32, ø40, ø50, ø63, ø80, ø100

Series Variations

Series	Action	Rod	Cushion	Basic	Standard variations				Bore size (mm)	Page
					Built-in One-touch fittings	With rod boot	Air-hydro type	Clean series		
Standard Series CG1  Substantially shorter length: ø20 to ø40... -15 to -30 mm (in comparison with Series CM2) ø40 to ø63... -17 to -28 mm (in comparison with Series CA2) ø80, ø100... -9 to -33 mm (in comparison with Series CA2)	Double acting	Single rod Double rod	Rubber	●	●	●	●	20 to 100	306	
			Air	●	●	●	●		322	
	Single acting	Single rod (Spring return/Spring extend)	Rubber	●					20 to 40	329
Non-rotating Rod Series CG1K 	Double acting	Single rod Double rod	Rubber	●				20 to 63	334	
			Air	●				40 to 63		
	Double rod	Rubber	●					20 to 63	339	
Direct Mount Series CG1R 	Double acting	Single rod	Rubber	●			●	20 to 63	343	
			Air	●						
Direct Mount, Non-rotating Rod Series CG1KR 	Double acting	Single rod	Rubber	●				20 to 63	348	
Low Friction Series CG1□Q 	Use the new series "Smooth Cylinder Series CG1Y" to realize both-direction low friction and low-speed operation. (Refer to Best Pneumatics No. 3.)								351	
With End Lock Series CBG1 	Double acting	Single rod	Rubber	●			●	20 to 100	352	
			Air	●			●			

CJ1

CJP

CJ2
-Z

CJ2

CM2
-Z

CM2

CM3

CG1
-Z

CG1

CG3

MB
-Z

MB

MB1

CA2
-Z

CA2

CS1

CS2

D-□

-X□

Technical data

Combinations of Standard Products and Made

Series CG1

● :Standard
⊙ :Made to Order specifications
○ :Special product (Contact SMC for details.)
— :Not available

Symbol	Specification Applicable	Bore size	CG1 (Standard)				
			Double acting				Single acting
			Single rod		Double rod		Single rod
			Rubber	Air	Rubber	Air	Rubber
			ø20 to ø100				ø20 to ø40
Standard	Standard	ø20 to ø100	●	●	●	●	●
Long st	Long stroke		●	●	●	●	○
D	Built-in magnet	ø20 to ø63	●	●	●	●	●
CG1□F	One-touch fittings		●	○	○	○	○
CG1□-□^J_K	With rod boot	ø20 to ø100	●	●	●	●	○
CG1□H	Air-hydro type	ø20 to ø63	●	—	●	—	—
10-, 11-	Clean series	ø20 to ø100	●	● ^{Note 1)}	●	● ^{Note 1)}	○
25- ^{Note 12)}	Copper (Cu)-free	ø10, ø16	●	●	○	○	○
25A- ^{Note 12)}	Copper (Cu) and zinc (Zn)-free		●	●	○	○	○
20- ^{Note 12)}	Copper ^{Note 11)} and Fluorine-free	ø20 to ø100	●	●	○	●	○
CG1□^F	Water resistant	ø32 to ø100	●	●	●	●	○
XB6	Heat-resistant cylinder (-10 to 150°C) ^{Note 7)}	ø20 to ø100	⊙ ^{Note 2)}	⊙	⊙ ^{Note 2)}	⊙	○
XB7	Cold-resistant cylinder ^{Note 7)}		⊙ ^{Note 2)}	○	⊙ ^{Note 2)} ⊙ ^{Note 5)}	○	○
XB9	Low-speed cylinder (5 to 50 mm/s)		⊙	○	○	○	—
XB13	Low-speed cylinder (5 to 50 mm/s)		⊙	○	○	○	—
XC4	With heavy duty scraper	ø32 to ø63	⊙	⊙	○	○	○
XC6	Stainless steel rod and rod end nut	ø20 to ø100	⊙	⊙	⊙	⊙	⊙
XC8	Adjustable stroke cylinder/Adjustable extension type	ø20 to ø63	⊙	⊙	—	—	○
XC9	Adjustable stroke cylinder/Adjustable retraction type		⊙	⊙	—	—	○
XC10	Dual stroke cylinder/Double rod type		⊙	⊙	—	—	○
XC11	Dual stroke cylinder/Single rod type		⊙	⊙	—	—	○
XC12	Tandem type cylinder	ø20 to ø100	⊙	○	○	○	○
XC13	Auto switch rail mounting		⊙	⊙	⊙ ^{Note 5)}	⊙ ^{Note 5)}	○
XC20	Head cover axial port	ø20 to ø63	⊙	○	—	—	⊙
XC22	Fluororubber seal	ø20 to ø100	⊙	⊙	⊙	⊙	○
XC27	Stainless steel double clevis pin/double knuckle pin		⊙	⊙	○	○	○
XC29	Double knuckle joint with spring pin		⊙	⊙	○	○	○
XC35	With coil scraper	ø20 to ø63	⊙	⊙	○	○	○
XC37	Larger throttle diameter of connecting port		⊙	⊙	⊙	⊙	⊙
XC42	Built-in rear shock absorber		⊙	⊙	—	—	○
XC70	End lock cylinder for MGG ^{Note 8)}	ø20 to ø100	—	—	—	—	—
XC85	Grease for food processing equipment		⊙	⊙	⊙	⊙	○

Note 1) ø40 to ø63 only.

Note 2) Without bumper

Note 3) ø32 to ø100 only.

Note 4) SV type only. (Heat-resistant grease is used.)

Note 5) ø20 to ø63 only.

Note 6) Single acting/spring return type (S) only

Note 7) The products with an auto switch are not compatible.

Note 8) Since this is used for a guide, a cover port and an end lock will be on the same side.

Note 9) Available only for locking at head end.

Note 10) Available only for locking on rod side.

Note 11) Copper-free for the externally exposed part

Note 12) For details, refer to the SMC website.

to Order Specifications

Series CG1

Use the new series "Smooth Cylinder Series CG1Y" to realize both-direction low friction and low-speed operation. (Refer to Best Pneumatics No. 3.)

	CG1K (Non-rotating rod)				CG1R (Direct mount)		CG1KR (Non-rotating rod, direct mount)	CG1□Q (Low friction)	CBG1 (End lock)	
	Double acting		Double rod	Single acting	Double acting		Double acting	Double acting	Double acting	
	Single rod			Single rod	Single rod		Single rod	Single rod	Single rod	
	Rubber	Air	Rubber	Rubber	Rubber	Air	Rubber	—	Rubber	Air
	ø20 to ø63	ø40 to ø63	ø20 to ø63	ø20 to ø40	ø20 to ø63		ø20 to ø63	ø20 to ø100		
	●	●	●	●	●	●	●	●	●	●
	●	●	●	○	○	○	○	●	●	●
	●	●	●	●	●	●	●	●	●	●
	○	○	○	○	○	○	○	○	○	○
	○	○	○	○	○	○	○	○	●	●
	—	—	—	—	○	—	—	—	—	—
	○	○	○	○	●	○	○	—	○	○
	○	○	○	○	○	○	○	○	○	○
	○	○	○	○	○	○	○	○	○	○
	○	○	○	○	○	○	○	○	○	○
	●	○	●	○	●	●	●	—	○	○
	—	—	—	—	○	○	—	—	○	○
	○	○	○	○	◎ (Note 2)	◎	○	—	○	○
	○	○	○	○	◎ (Note 2)	○	○	—	—	—
	—	—	—	—	◎	○	—	—	○	○
	—	—	—	—	◎	○	—	—	○	○
	—	—	—	—	◎	◎	—	◎	○	○
	◎	○	—	○	◎	○	◎	○	○ (Note 9)	○ (Note 9)
	◎	○	—	○	◎	○	◎	○	○ (Note 10)	○ (Note 10)
	◎	○	—	○	○	○	○	○	○	○
	◎	○	—	○	○	○	○	○	○	○
	◎	○	○	○	◎	○	○	○	○	○
	◎	○	○	○	◎	○	◎	○	○	○
	◎	○	—	○	◎	○	◎	○	○	○
	○	○	○	○	◎	◎	○	—	○	○
	○	○	○	○	○	○	○	○	○	○
	○	○	○	○	○	○	○	○	○	○
	—	—	—	—	○	○	—	—	○	○
	○	○	○	○	○	○	○	○	○	○
	◎	○	—	○	○	○	○	—	○	○
	—	—	—	—	—	—	—	—	◎	○
	○	○	○	○	◎	◎	○	—	○	○

CG1

CGP

CG2-Z

CG2

CM2-Z

CM2

CM3

CG1-Z

CG1

CG3

MB-Z

MB

MB1

CA2-Z

CA2

CS1

CS2

D-□

-X□

Technical data

Air Cylinder: Standard Type Double Acting, Single Rod Series CG1

ø20, ø25, ø32, ø40, ø50, ø63, ø80, ø100

Series CG1 standard type: double acting, single rod has been remodeled. For details, refer to page 283.

How to Order

CG1 L N 25 [] - 100 [] - []

With auto switch CDG1 L N 25 [] - 100 [] - M9BW [] - C - []

With auto switch (Built-in magnet)

Mounting style

B	Basic style
L	Axial foot style
F	Rod side flange style
G	Head side flange style
U ^a	Rod side trunnion style
T ^a	Head side trunnion style
D	Clevis style

Type

N	Rubber bumper
A	Air cushion

Port thread type

Nil	Rc	ø20 to ø100
TN	NPT	ø20 to ø100
TF	M5 x 0.8	ø20, ø25
	G	ø32 to ø100

Auto switch mounting bracket (Note)
Note) This symbol is indicated when the D-A9□ or M9□ type auto switch is specified. This mounting bracket does not apply to other auto switches (D-C7□ and H7□, etc.) (Nil)

Auto switch

Nil	Without auto switch	Nil	2 pcs.
S	For the applicable auto switch model, refer to the table below.	S	1 pc.
n		n	"n" pcs.

Number of auto switches

Suffix for cylinder (Rod boot (at one end))

Nil	Without rod boot
J	Nylon tarpaulin
K	Heat resistant tarpaulin

Bore size

20	20 mm	50	50 mm
25	25 mm	63	63 mm
32	32 mm	80	80 mm
40	40 mm	100	100 mm

Port thread type

Nil	M5 x 0.8	ø20, ø25
Rc		ø32 to ø100
TN	NPT	ø32 to ø100
TF	M5 x 0.8	ø20, ø25
	G	ø32 to ø100

Air Cushion

Cylinder stroke (mm)
Refer to "Standard Stroke" on page 307.

Made to Order
Refer to page 307 for details.

* Not available for ø80 or ø100.
Note) Mounting brackets are shipped together, (but not assembled).

Built-in Magnet Cylinder Model

If a built-in magnet cylinder without an auto switch is required, there is no need to enter the symbol for the auto switch. (Example) CDG1F32-100

Applicable Auto Switches

Type	Special function	Electrical entry	Indicator/light	Wiring (Output)	Load voltage		Auto switch model				Lead wire length (m)				Pre-wired connector	Applicable load				
					DC	AC	Applicable bore size		0.5 (Nil)	1 (M)	3 (L)	5 (Z)	None (N)							
							ø20 to ø63	ø80, ø100												
Solid state auto switch	Grommet	Connector	Yes	3-wire (NPN)	5 V, 12 V	—	ø20 to ø63	ø80, ø100	M9NV	M9N	●	●	●	○	—	IC circuit				
				3-wire (PNP)					M9PV	M9P	●	●	●	○	—					
				2-wire					M9BV	M9B	●	●	●	○	—					
				—					—	—	K59	●	—	○	—		—			
	Diagnostic indication (2-color indication)	Grommet	Connector	Yes	3-wire (NPN)	24 V	5 V, 12 V	—	ø20 to ø63	ø80, ø100	—	H7C	●	●	●	○	IC circuit			
					3-wire (PNP)						M9NWV	M9NW	●	●	●	○		—		
					2-wire						—	—	—	—	—	—		—	—	
					3-wire (NPN)						M9PWV	M9PW	●	●	●	○		—		
					3-wire (PNP)						—	—	—	G59W	●	●		●	○	—
					2-wire						—	—	—	—	—	—		—	—	
Water resistant (2-color indication)	Grommet	Connector	Yes	3-wire (NPN)	5 V, 12 V	—	ø20 to ø63	ø80, ø100	M9NAV**	M9NA**	—	○	○	○	IC circuit					
				3-wire (PNP)					M9PAV**	M9PA**	—	○	○	○		—				
Reed auto switch	Grommet	Connector	Yes	2-wire	24 V	12 V	—	ø20 to ø63	ø80, ø100	M9B**	M9B	●	●	●	○	IC circuit				
				4-wire (NPN)						—	—	—	—	—	—		—			
				3-wire (Equip. to NPN)						—	—	—	H7NF	—	—		—	—		
				—						—	—	—	A96V	A96	●		●	●	○	IC circuit
				—						—	—	—	A93V	A93	●		●	●	○	
				—						—	—	—	A90V	A90	●		●	●	○	IC circuit
—	—	—	—	—	—	—	—	—	—											
Diagnostic output (2-color indication)	Grommet	Connector	Yes	2-wire	24 V	12 V	—	ø20 to ø63	ø80, ø100	—	B54	●	●	●	○	Relay, PLC				
				—						—	—	B64	●	●	●		○			
				—						—	—	—	C73C	—	—		—	—		
				—						—	—	—	C80C	—	—		—	—		
Diagnostic indication (2-color indication)	Grommet	Connector	Yes	2-wire	24 V	12 V	—	ø20 to ø63	ø80, ø100	—	B59W	●	●	●	○	IC circuit				
				—						—	—	—	—	—	—		—	—		

** Water resistant type auto switches can be mounted on the above models, but in such case SMC cannot guarantee water resistance.
* A water-resistant type cylinder is recommended for use in an environment which requires water resistance. However, please contact SMC for water-resistant products of ø20 and ø25.

* Lead wire length symbols: 0.5 m Nil (Example) M9NW
1 m M (Example) M9NWM
3 m L (Example) M9NWL
5 m Z (Example) M9NWZ
None N (Example) H7CN

* Solid state auto switches marked with "C" are produced upon receipt of order.

* Since there are other applicable auto switches than listed, refer to page 368 for details.
* For details about auto switches with pre-wired connector, refer to pages 1626 and 1627.
* D-A9□/M9□□ auto switches are shipped together (not assembled). (Only auto switch mounting brackets are assembled before shipped).

Air Cylinder: Standard Type Double Acting, Single Rod *Series CG1*



Substantially shorter length:

- ø20 to ø40... -15 to -30 mm
(in comparison with Series CM2)
- ø40 to ø63... -17 to -28 mm
(in comparison with Series CA2)
- ø80, ø100... -9 to -33 mm
(in comparison with Series CA2)

Symbol

Double acting, Rubber bumper

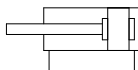

Made to Order

(Refer to pages 1675 to 1818 for details.)

Symbol	Specifications
-XA□	Change of rod end shape
-XB6	Heat resistant cylinder (150°C)*1
-XB7	Cold resistant cylinder
-XB9	Low speed cylinder (10 to 50 mm/s)*3
-XB13	Low speed cylinder (5 to 50 mm/s)*3
-XC4	With heavy duty scraper
-XC6	Piston rod and rod end nut made of stainless steel
-XC8	Adjustable stroke cylinder/Adjustable extension type
-XC9	Adjustable stroke cylinder/Adjustable retraction type
-XC10	Dual stroke cylinder/Double rod type
-XC11	Dual stroke cylinder/Single rod type
-XC12	Tandem type cylinder*3
-XC13	Auto switch rail mounting style
-XC20	Head cover axial port*3
-XC22	Fluororubber seals
-XC27	Stainless steel double clevis pin
-XC29	Double knuckle joint with spring pin
-XC35	With coil scraper
-XC37	Larger throttle diameter of connecting port
-XC42	Built-in rear shock absorber
-XC85	Grease for food processing equipment

- * 1 Cylinders with rubber bumper have no bumper.
- * 2 Compatible with cylinders with rubber bumper, but has no bumper.
- * 3 Compatible with cylinders with rubber bumper only.

Refer to pages 363 to 368 for cylinders with auto switches.
<ul style="list-style-type: none"> • Minimum auto switch mounting stroke • Proper auto switch mounting position (detection at stroke end) and mounting height • Operating range • Switch mounting bracket: Part no.

Specifications

Bore size (mm)	20	25	32	40	50	63	80	100
Action	Double acting, Single rod							
Lubricant	Not required (Non-lube)							
Fluid	Air							
Proof pressure	1.5 MPa							
Maximum operating pressure	1.0 MPa							
Minimum operating pressure	0.05 MPa							
Ambient and fluid temperature	Without auto switch: -10 to 70°C (No freezing) With auto switch: -10 to 60°C (No freezing)							
Piston speed	50 to 1000 mm/s						50 to 700 mm/s	
Stroke length tolerance	Up to 1000 ^{+1.4} ₀ mm, Up to 1200 ^{+1.8} ₀ mm						Up to 1000 ^{+1.4} ₀ mm Up to 1500 ^{+1.8} ₀ mm	
Cushion	Rubber bumper, Air cushion							
Mounting *	Basic style, Axial foot style, Rod side flange style, Head side flange style, Rod side trunnion style, Head side trunnion style, Clevis style (Used for changing the port location by 90°.)							

Rod/Head side trunnion styles are not available for bore sizes ø80 and ø100.

Accessory

Mounting		Basic style	Axial foot style	Rod side flange style	Head side flange style	Rod side trunnion style	Head side trunnion style	Clevis style
Standard equipment	Rod end nut	●	●	●	●	●	●	●
	Clevis pin	—	—	—	—	—	—	●
Option	Single knuckle joint	●	●	●	●	●	●	●
	Double knuckle joint (With pin)	●	●	●	●	●	●	●
	Pivot bracket	—	—	—	—	●*	●*	●
	Rod boot	●	●	●	●	●	●	●

* Trunnion bracket is not available for ø80 and ø100.

** Pin and retaining ring are shipped together with double knuckle joint.

Standard Stroke

Bore size (mm)	Standard stroke ⁽¹⁾ (mm)	Long stroke ⁽²⁾ (mm)	Maximum manufacturable stroke (mm)
20	25, 50, 75, 100, 125, 150, 200	201 to 350	1500
25		301 to 400	
32		301 to 450	
40		301 to 800	
50, 63		301 to 1200	
80		301 to 1400	
100		301 to 1500	

Note 1) Manufacture of intermediate strokes at 1 mm intervals is possible. (Spacers are not used.)

Note 2) Long stroke is compatible with the axial foot and rod side flange types. When other mounting brackets are used or the long stroke exceeds the limit, the allowable maximum stroke length is determined using the stroke selection table (front matter 34)

Rod Boot Material

Symbol	Rod boot material	Maximum operating temperature
J	Nylon tarpaulin	70°C
K	Heat resistant tarpaulin	110°C*

* Maximum ambient temperature for the rod boot itself.

CG1

CGP

CG2

CG2-Z

CG2

CG2-Z

CG2

CG2-Z

CG3

CG3

CG1-Z

CG1

CG1

CG3

MB

MB-Z

MB

MB1

CA2

CA2-Z

CA2

CA2

CS1

CS1

CS2

CS2

CS2

CS2

CS2

CS2

CS2

CS2

CS2

CS2

CS2

CS2

CS2

CS2

CS2

CS2

Series CG1

Mounting Bracket Part No.

Mounting bracket	Min. order	Bore size (mm)								Description
		20	25	32	40	50	63	80	100	
Foot	Note 2	CG-L020	CG-L025	CG-L032	CG-L040	CG-L050	CG-L063	CG-L080	CG-L100	Foot x 2, Mounting bolt x 8
Flange	1	CG-F020	CG-F025	CG-F032	CG-F040	CG-F050	CG-F063	CG-F080	CG-F100	Flange x 1, Mounting bolt x 4
Trunnion pin	1	CG-T020	CG-T025	CG-T032	CG-T040	CG-T050	CG-T063	-	-	Trunnion pin x 2, Trunnion bolt x 2, Flat washer x 2
Clevis	1	CG-D020	CG-D025	CG-D032	CG-D040	CG-D050	CG-D063	CG-D080	CG-D100	Clevis x 1, Mounting bolt x 4, Clevis pin x 1, Retaining ring x 2
Pivot bracket	1	CG-020-24A	CG-025-24A	CG-032-24A	CG-040-24A	CG-050-24A	CG-063-24A	CG-080-24A	CG-100-24A	Pivot bracket x 1

Note) Order two foot brackets per cylinder.

Weight

(kg)

Bore size (mm)		20	25	32	40	50	63	80	100
Basic weight	Basic style	0.10	0.17	0.26	0.41	0.77	1.07	2.04	3.17
	Axial foot style	0.21	0.30	0.42	0.63	1.25	1.79	3.00	4.92
	Flange style	0.18	0.27	0.40	0.61	1.11	1.57	2.75	4.52
	Trunnion style	0.11	0.19	0.29	0.46	0.91	1.21	-	-
	Clevis style	0.15	0.25	0.41	0.64	1.17	1.75	2.75	4.45
Pivot bracket		0.08	0.09	0.17	0.25	0.44	0.80	0.98	1.75
Single knuckle joint		0.05	0.09	0.09	0.10	0.22	0.22	0.39	0.57
Double knuckle joint (With pin)		0.05	0.09	0.09	0.13	0.26	0.26	0.64	1.31
Additional weight per each 50 mm of stroke		0.05	0.07	0.09	0.15	0.22	0.26	0.35	0.49
Additional weight with air cushion		0.01	0.01	0.02	0.02	0.03	0.03	0.03	0.03
Additional weight for long stroke		0.01	0.01	0.02	0.03	0.06	0.10	0.19	0.26

Calculation: (Example) **CG1LA20-100** (Foot style, ø20, 100 st)

- Basic weight:..... 0.21 kg (Foot, ø20)
- Cylinder stroke.....100 stroke
- Additional weight:..... 0.05 kg/50 stroke
- Additional weight by air cushion.....0.01 kg

$$0.21 + 0.05 \times 100/50 + 0.01 = 0.32 \text{ kg}$$

Mounting Procedure

Mounting procedure for trunnion

Follow the procedures below when mounting a pivot bracket on the trunnion.

ø20 to ø63

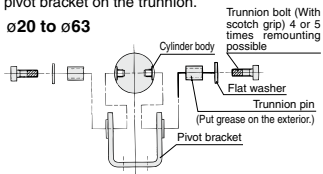

Mounting procedure for clevis

Follow the procedures below when mounting a pivot bracket on the clevis style.

ø20 to ø63

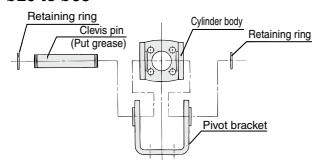

ø80, ø100

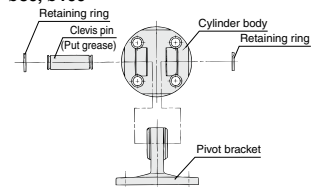

Air Cylinder: Standard Type Double Acting, Single Rod *Series CG1*

Built-in One-touch Fittings

CG1 **Mounting style** N **Bore size** F — **Stroke**
 ↓ Built-in One-touch fittings

This type has the One-touch fittings integrated in a cylinder, which enables to reduce the piping labor and installing space dramatically.

Specifications

Bore size (mm)	20, 25, 32, 40, 50, 63
Action	Double acting
Fluid	Air
Maximum operating pressure	1.0 MPa
Minimum operating pressure	0.05 MPa
Piston speed	50 to 750 mm/s
Cushion	Rubber bumper
Mounting	Basic style, Axial foot style, Rod side flange style Head side flange style, Rod side trunnion style Head side trunnion style, Clevis style (Used for changing the port location by 90°.)

* Auto switch can be mounted.

Applicable Tubing O.D./I.D.

Bore size (mm)	20	25	32	40	50	63
Applicable tubing O.D. (mm)	6/4	6/4	6/4	8/6	10/7.5	10/7.5
Applicable tubing material	Can be used for either nylon, soft nylon or polyurethane tubing.					

* For other specifications, refer to page 307.

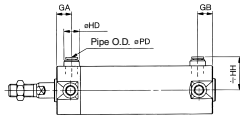

* Other dimensions are the same as the double acting single rod standard type.

Bore size (mm)	GA	GB	HD	HH	PD
20	12	12	13	24.2	6
25	12	10(12)	13	26.7	6
32	12	10(12)	13	30.2	6
40	12	10(12)	16	34.6	8
50	13	13	20	40.6	10
63	13	13	20	47.1	10

Note) () : Long stroke

Air-hydro

CG1 **Mounting style** H **Bore size** — **Stroke**
 ↓ Air-hydro

Low pressure hydraulic cylinder of 1.0 MPa or less
 When used together with a Series CC air-hydro unit, constant and low speed actuation and intermediate stopping similar to hydraulic units are possible with the use of valves and other pneumatic equipment.

Specifications

Type	Air-hydro
Bore size (mm)	20, 25, 32, 40, 50, 63
Action	Double acting
Fluid	Turbine oil
Proof pressure	1.5 MPa
Maximum operating pressure	1.0 MPa
Minimum operating pressure	0.18 MPa
Piston speed	15 to 300 mm/s
Cushion	None
Ambient and fluid temperature	5 to 60°C
Mounting	Basic style, Axial foot style, Rod side flange style Head side flange style, Rod side trunnion style Head side trunnion style, Clevis style (Used for changing the port location by 90°.)

* Auto switch can be mounted.

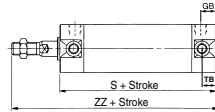

* Other dimensions are the same as the double acting single rod standard type.

Bore size (mm)	GB	TB	S	ZZ
20	12	11	77	114
25	12	11	77	119
32	12	11	79	121
40	13	12	87	139
50	14	13	102	162
63	14	13	102	162

Clean Series

10-CG1 **Mounting style** N **Bore size** — **Stroke**

↓ Clean series (With relief port)

The type which is applicable for using inside the clean room graded Class 100 by making an actuator's rod section a double seal construction and discharging by relief port directly to the outside of clean room.

Specifications

Bore size (mm)	20, 25, 32, 40, 50, 63, 80, 100
Action	Double acting
Fluid	Air
Maximum operating pressure	1.0 MPa
Minimum operating pressure	0.05 MPa
Cushion	Rubber bumper
Piston speed	30 to 400 mm/s
Relief port size	M5 x 0.8
Mounting	Basic style, Axial foot style, Rod side flange style Head side flange style

* Auto switch can be mounted.

For details, refer to the separate catalog, "Pneumatic Clean Series".

CJ1

CJP

CJ2
-Z

CJ2

CM2
-Z

CM2

CM3

CG1
-Z

CG1

CG3

MB
-Z

MB

MB1

CA2
-Z

CA2

CS1

CS2

D-□

-X□

Technical data

Series CG1

Water Resistant

CDG1 Mounting style Style Bore size Port thread type **R** Stroke H7BAL -XC6

With auto switch
(Built-in magnet)

Water resistant cylinder

R	NBR seals (Nitrile rubber)
V	FKM seals (Fluororubber)

Water resistant 2-color
indication, solid state auto switch

H7BAL	ø32 to ø63
G5BAL	ø80, ø100

Caution

Since the scraper is press-fit into the rod cover, it cannot be replaced.

Made to Order

Applicable for use in an environment with water splashing such as food processing and car wash equipment, etc.

Specifications

Bore size (mm)	32, 40, 50, 63, 80, 100
Action	Double acting, Single rod
Cushion	Rubber bumper/Air cushion
Auto switch mounting	Band mounting style
Made to order	Piston Rod/Rod end nut material: Stainless steel (-XC6)

* Specifications other than above are the same as standard, basic style.

Dimensions

With rubber bumper

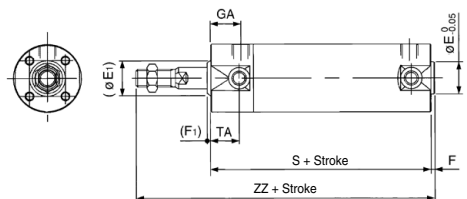

With air cushion

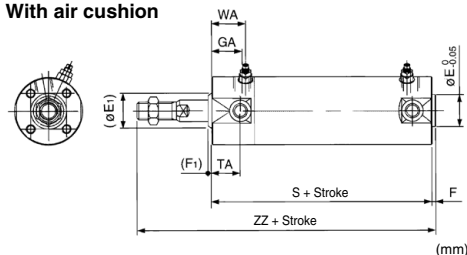

Bore size (mm)	(E1)	E*	(F1)	F*	GA	S	TA	WA	ZZ
32	17	18	2	2	18	77 (85)	17	22	119 (127)
40	21	25	2	2	19	84 (93)	18	22	136 (145)
50	26	30	2	2	21	97 (109)	20	25	157 (169)
63	26	32	2	2	21	97 (109)	20	25	157 (169)
80	32	40	3	3	28	116 (130)	-	30	190 (204)
100	37	50	3	3	29	117 (131)	-	31	191 (205)

* Other dimensions are the same as the double acting single rod standard type.

(): Denotes the dimensions for long stroke.

Refer to page 1117 for details.

Precautions

Be sure to read before handling.
Refer to front matter 57 for Safety Instructions and pages 3 to 12 for Actuator and Auto Switch Precautions.

Operating Precautions

Warning

- Do not operate the cushion valve in the fully closed or fully opened state.**
Using it in the fully closed state will cause the cushion seal to be damaged. Using it in the fully opened state will cause the piston rod assembly or the cover to be damaged.
- Operate within the specified cylinder speed.**
Otherwise, cylinder and seal damage may occur.
- Use caution regarding the cushion performance in the low-speed range.**
There may be individual performance and effect variances when used near 50 mm/s. Please consult with SMC about usage.
- When the cylinder is used as mounted with a single side fixed or free (basic type, flange type), a bending moment will be applied to the cylinder due to the vibration generated at the stroke end, and the cylinder may be damaged.** In such a case, mount a bracket to reduce the vibration of the cylinder or use the cylinder at a piston speed low enough to prevent the cylinder from vibrating at the stroke end.
Also, please use a support bracket to reduce vibrations when the cylinder body moves or when the cylinder is fixed horizontally on one side and moved at a high speed and frequency.
- Use without applying excess lateral load to the piston rod.**
Simplified confirmation method
Minimum operating pressure after equipment is mounted (MPa) = Minimum cylinder operating pressure (MPa) + [Load weight (kg) x Coefficient of guide friction/Effective cylinder area (mm²)]
If smooth operation is confirmed with within the above value, the load on the cylinder is the resistance of the thrust only and it can be judged as having no lateral load.

Caution

- Do not use the air cylinder as an air-hydro cylinder.**
This will cause an oil leak.
- Install a rod boot without twisting.**
If the cylinder is installed with its bellows twisted, it could damage the bellows.
- Tighten clevis bracket mounting bolts with the following proper tightening torque.**
ø20: 1.5N·m, ø25 to 32: 2.9N·m, ø40: 4.9N·m, ø50: 11.8N·m, ø63 to 80: 24.5N·m, ø100: 42.2N·m

Disassembly/Replacement

Caution

- Do not replace the bushings.**
The bushings are press-fit. To replace them, they must be replaced together with the cover assembly.
- To replace a seal, apply grease to the new seal before installing it.**
If the cylinder is put into operation without applying grease to the seal, it could cause the seal to wear significantly, leading to premature air leakage.
- Do not replace One-touch fittings.**
Because pipe fittings are press-fit, they must be replaced together with the cover assembly.
- Those with a bore of ø50 or more cannot be disassembled.**
When disassembling cylinders with bore sizes of ø20 through ø40, grip the double flat part of either the head cover or the rod cover with a vise and loosen the other side with a wrench or a monkey wrench, etc., and then remove the cover. When re-tightening, tighten approximately 2 degrees more than the original position. (Cylinders with ø50 or larger bore sizes are tightened with a large tightening torque and cannot be disassembled. Please contact SMC when disassembly is required.)

Construction

With rubber bumper

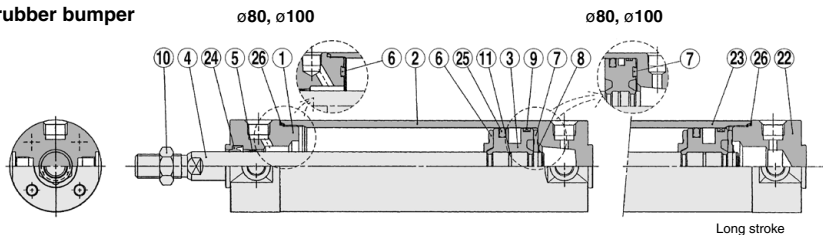

With air cushion

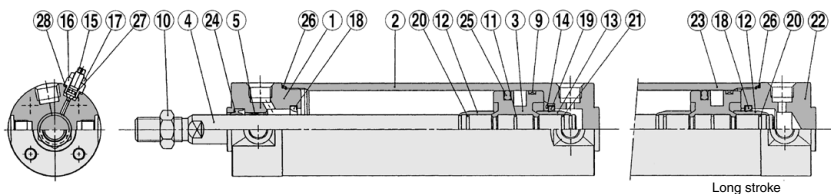

Component Parts

No.	Description	Material	Note
1	Rod cover	Aluminum alloy	Clear hard anodized
2	Tube cover	Aluminum alloy	Clear hard anodized
3	Piston	Aluminum alloy	Chromated
4	Piston rod	Carbon steel*	Hard chrome plated*
5	Bushing	Bearing alloy	
6	Bumper A	Urethane	
7	Bumper B	Urethane	ø40 or larger: The same as bumper A
8	Retaining ring	Stainless steel	Except ø80 and ø100
9	Wear ring	Resin	
10	Rod end nut	Rolled steel	Zinc chromated
11	Piston gasket	NBR	
12	Cushion ring A	Aluminum alloy	Anodized
13	Cushion ring B	Aluminum alloy	ø32 or larger: The same as A, Anodized
14	Seal retainer	Rolled steel	Nickel plated/Except long stroke
15	Cushion valve	Rolled steel	Electroless nickel plated
16	Valve retainer	Rolled steel	Electroless nickel plated
17	Lock nut	Rolled steel	Nickel plated
18	Cushion seal A	Urethane	
19	Cushion seal B	Urethane	ø32 or larger: The same as A
20	Cushion ring gasket A	NBR	
21	Cushion ring gasket B	NBR	ø32 or larger: The same as A
22	Head cover	Aluminum alloy	Clear hard anodized
23	Cylinder tube	Aluminum alloy	Hard anodized
24	Rod seal	NBR	
25	Piston seal	NBR	
26	Tube gasket	NBR	
27	Valve seal	NBR	
28	Valve retaining gasket	NBR	

Note) In the case of cylinders with auto switches, magnets are installed in the piston.

* The material is stainless steel on auto switch equipped styles ø20 and ø25.

Replacement Parts/Seal Kit

• For rubber bumper		
Bore size (mm)	Kit no.	Contents
20	CG1N20-PS	Set of the nos. 24, 25, 26
25	CG1N25-PS	
32	CG1N32-PS	
40	CG1N40-PS	

• For air cushion		
Bore size (mm)	Kit no.	Contents
20	CG1A20-PS	Set of the nos. 24, 25, 26, 27, 28
25	CG1A25-PS	
32	CG1A32-PS	
40	CG1A40-PS	

Note) Refer to the Specific Product Precautions on page 310 for Disassembly/Replacement.
Order with a part number for each type and bore size.

* The seal kit includes a grease pack (10 g). Order with the following part number when only the grease pack is needed.

Grease pack part no.: GR-S-010 (10 g)

CJ1

CJP

CJ2
-Z

CJ2

CM2
-Z

CM2

CM3

CG1
-Z

CG1

CG3

MB
-Z

MB

MB1

CA2
-Z

CA2

CS1

CS2

D-□

-X□

Technical
data

Series CG1

Basic Style: CG1B□

With rubber bumper

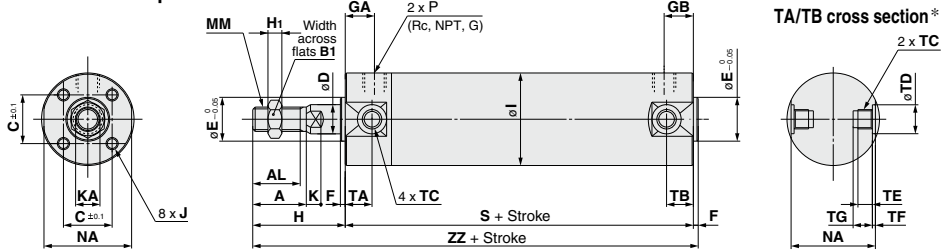

With rod boot

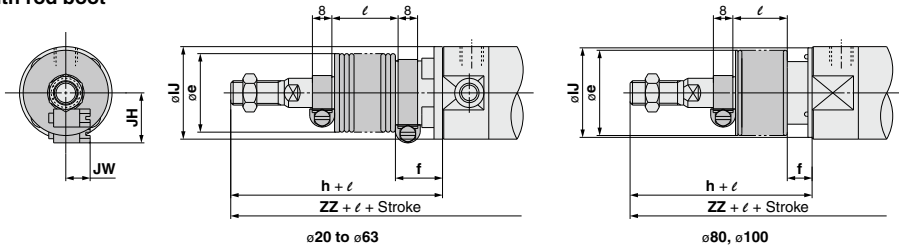

With air cushion

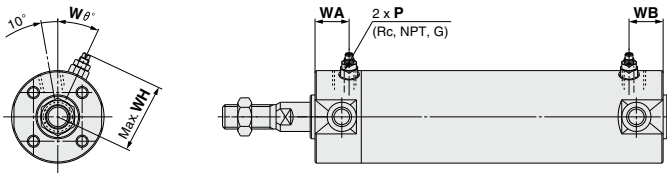

Bore size (mm)	Stroke range (mm)		Rc, NPT port			G port																					
	Standard	Long stroke	GA	GB	P	GA	GB	P	A	AL	B ₁	C	D	E	F	H	H ₁	I	J	K	KA	MM	NA	S	TA	TB	ZZ
20	Up to 200	201 to 350	12	10 (12)	1/8	12	10 (12)	M5 x 0.8	18	15.5	13	14	8	12	2	35	5	26	M4 x 0.7 depth 7	5	6	M8 x 1.25	24	69 (77)	11	11	106 (114)
25	Up to 300	301 to 400	12	10 (12)	1/8	12	10 (12)	M5 x 0.8	22	19.5	17	16.5	10	14	2	40	6	31	M5 x 0.8 depth 7.5	5.5	8	M10 x 1.25	29	69 (77)	11	11	111 (119)
32	Up to 300	301 to 450	12	10 (12)	1/8	10	9 (10)	1/8	22	19.5	17	20	12	18	2	40	6	38	M5 x 0.8 depth 8	5.5	10	M10 x 1.25	35.5	71 (79)	11	10 (11)	113 (121)
40	Up to 300	301 to 800	13	10 (13)	1/8	10	9 (10)	1/8	30	27	19	26	16	25	2	50	8	47	M6 x 1 depth 12	6	14	M14 x 1.5	44	78 (87)	12	10 (12)	130 (139)
50	Up to 300	301 to 1200	14	12 (14)	1/4	12	11 (12)	1/4	35	32	27	32	20	30	2	58	11	58	M8 x 1.25 depth 16	7	18	M18 x 1.5	55	90 (102)	13	12 (13)	150 (162)
63	Up to 300	301 to 1200	14	12 (14)	1/4	12	11 (12)	1/4	35	32	27	38	20	32	2	58	11	72	M10 x 1.5 depth 16	7	18	M18 x 1.5	69	90 (102)	13	12 (13)	150 (162)
80	Up to 300	301 to 1400	20	16 (20)	3/8	17	16 (17)	3/8	40	37	32	50	25	40	3	71	13	89	M10 x 1.5 depth 22	10	22	M22 x 1.5	80	108 (122)	—	—	182 (196)
100	Up to 300	301 to 1500	20	16 (20)	1/2	17	16 (17)	1/2	40	37	41	60	30	50	3	71	16	110	M12 x 1.75 depth 22	10	26	M26 x 1.5	100	108 (122)	—	—	182 (196)

Note () : Denotes the dimensions for long stroke.

TA/TB Sectional View (mm)

Bore size (mm)	TC*	TD	TE	TF	TG
20	M5 x 0.8	8 ^{+0.08}	4	0.5	5.5
25	M6 x 0.75	10 ^{+0.08}	5	1	6.5
32	M8 x 1.0	12 ^{+0.08}	5.5	1	7.5
40	M10 x 1.25	14 ^{+0.08}	6	1.25	8.5
50	M12 x 1.25	16 ^{+0.08}	7.5	2	10
63	M14 x 1.5	18 ^{+0.08}	11.5	3	14.5
80	—	—	—	—	—
100	—	—	—	—	—

* Trunnion mounting screw with width across flats NA are not attached for bore size ø80 and ø100.

With Rod Boot (mm)

Bore size (mm)	e	f	h	J	JH (Reference)	JW (Reference)	ZZ
20	30	18	55	27	15.5	10.5	126 (134)
25	30	19	62	32	16.5	10.5	133 (141)
32	35	19	62	38	18.5	10.5	135 (143)
40	35	19	70	48	21.5	10.5	150 (159)
50	40	19	78	59	24	10.5	170 (182)
63	40	20	78	72	24	10.5	170 (182)
80	52	10	80	59	—	—	191 (205)
100	62	7	80	71	—	—	191 (205)

* The minimum stroke with rod boot is 20 mm.

With Air Cushion (mm)

Bore size (mm)	Rc, NPT, G	P	WA	WB	WH	Wθ
20	M5 x 0.8	16	15 (16)	23	30°	30°
25	M5 x 0.8	16	15 (16)	25	30°	30°
32	1/8	16	15 (16)	28.5	25°	25°
40	1/8	16	15 (16)	33	20°	20°
50	1/4	18	17 (18)	40.5	20°	20°
63	1/4	18	17 (18)	47.5	20°	20°
80	3/8	22	22	60.5	20°	20°
100	1/2	22	22	71	20°	20°

Axial Foot Style: CG1L□

With rubber bumper

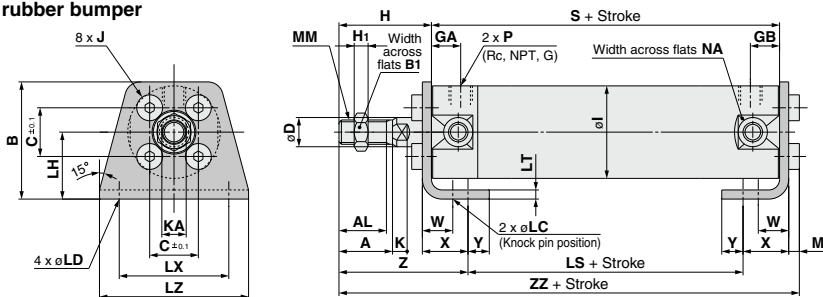

With rod boot

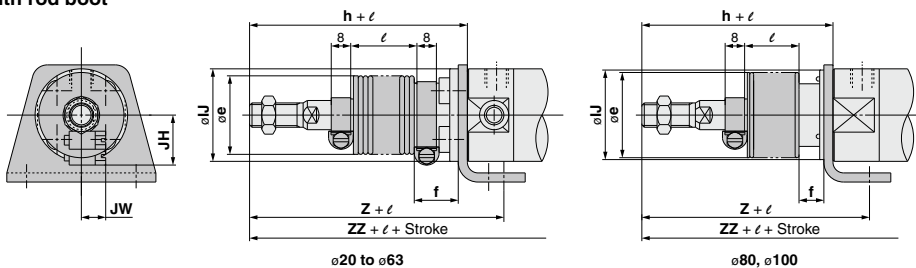

With air cushion

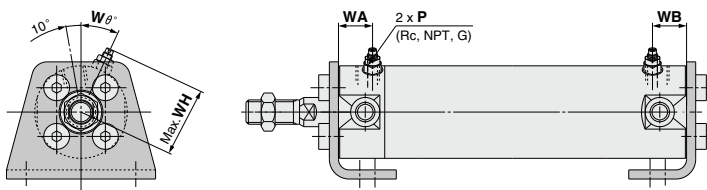

Bore size (mm)	Stroke range (mm)		Rc, NPT port			G port			A																			
	Standard	Long stroke	GA	GB	P	GA	GB	P	A	AL	B1	B	C	D	H	H1	I	J	K	KA	LC	LD	LH	LS	LT	LX	LZ	M
20	Up to 200	201 to 350	12	10 (12)	1/8	12	10 (12)	M5 x 0.8	18	15.5	13	34	14	8	35	5	26	M4 x 0.7	5	6	4	6	20	45 (53)	3	32	44	3
25	Up to 300	301 to 400	12	10 (12)	1/8	12	10 (12)	M5 x 0.8	22	19.5	17	38.5	16.5	10	40	6	31	M5 x 0.8	5.5	8	4	6	22	45 (53)	3	36	49	3.5
32	Up to 300	301 to 450	12	10 (12)	1/8	10	9 (10)	1/8	22	19.5	17	45	20	12	40	6	38	M5 x 0.8	5.5	10	4	7	25	45 (53)	3	44	58	3.5
40	Up to 300	301 to 800	13	10 (13)	1/8	10	9 (10)	1/8	30	27	19	54.5	26	16	50	8	47	M6 x 1	6	14	4	7	30	51 (60)	3	54	71	4
50	Up to 300	301 to 1200	14	12 (14)	1/4	12	11 (12)	1/4	35	32	27	70.5	32	20	58	11	58	M8 x 1.25	7	18	5	10	40	55 (67)	4.5	66	86	5
63	Up to 300	301 to 1200	14	12 (14)	1/4	12	11 (12)	1/4	35	32	27	82.5	38	20	58	11	72	M10 x 1.5	7	18	5	12	45	55 (67)	4.5	82	106	5
80	Up to 300	301 to 1400	20	16 (20)	3/8	17	16 (17)	3/8	40	37	32	101	50	25	71	13	89	M10 x 1.5	10	22	6	11	55	60 (74)	4.5	100	125	5
100	Up to 300	301 to 1500	20	16 (20)	1/2	17	16 (17)	1/2	40	37	41	121	60	30	71	16	110	M12 x 1.75	10	26	6	14	65	60 (74)	6	120	150	7

Bore size (mm)	(mm)							
	MM	NA	S	W	X	Y	Z	ZZ
20	M8 x 1.25	24	69 (77)	10	15	7	47	110 (118)
25	M10 x 1.25	29	69 (77)	10	15	7	52	115.5 (123.5)
32	M10 x 1.25	35.5	71 (79)	10	16	8	53	117.5 (125.5)
40	M14 x 1.5	44	78 (87)	10	16.5	8.5	63.5	135 (144)
50	M18 x 1.5	55	90 (102)	17.5	22	11	75.5	157.5 (169.5)
63	M18 x 1.5	69	90 (102)	17.5	22	13	75.5	157.5 (169.5)
80	M22 x 1.5	80	108 (122)	20	28.5	14	95	188.5 (202.5)
100	M26 x 1.5	100	108 (122)	20	30	16	95	192 (206)

With Rod Boot

Bore size (mm)	(mm)									
	e	f	h	IJ	JH (Reference)	JW (Reference)	l	Z	ZZ	1/4 stroke
20	30	18	55	27	15.5	10.5	67	130 (138)		
25	30	19	62	32	16.5	10.5	74	137.5 (145.5)		
32	35	19	62	38	18.5	10.5	75	139.5 (147.5)		
40	35	19	70	48	21.5	10.5	83.5	155 (164)		
50	40	19	78	59	24	10.5	95.5	177.5 (189.5)		
63	40	20	78	72	24	10.5	95.5	177.5 (189.5)		
80	52	10	80	59	—	—	104	197.5 (211.5)		
100	62	7	80	71	—	—	104	201 (215)		

With Air Cushion

Bore size (mm)	(mm)					
	Rc, NPT, G	P	WA	WB	WH	Wθ
20	M5 x 0.8	16	15 (16)	23	30°	
25	M5 x 0.8	16	15 (16)	25	30°	
32	1/8	16	15 (16)	28.5	25°	
40	1/8	16	15 (16)	33	20°	
50	1/4	18	17 (18)	40.5	20°	
63	1/4	18	17 (18)	47.5	20°	
80	3/8	22	22	60.5	20°	
100	1/2	22	22	71	20°	

Note () : Denotes the dimensions for long stroke.

* The minimum stroke with rod boot is 20 mm.

- CG1
- CGP
- CGJ2-Z
- CGJ2
- CM2-Z
- CM2
- CM3
- CG1-Z
- CG1
- CG3
- MB-Z
- MB
- MB1
- CA2-Z
- CA2
- CS1
- CS2

- D-□
- X□

Technical data

Series CG1

Rod Side Flange Style: CG1F□

With rubber bumper

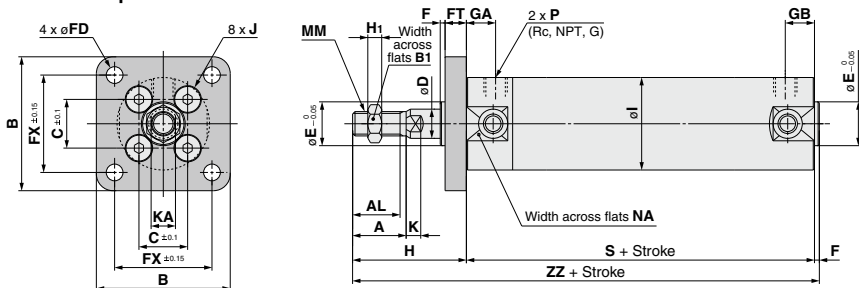

With rod boot

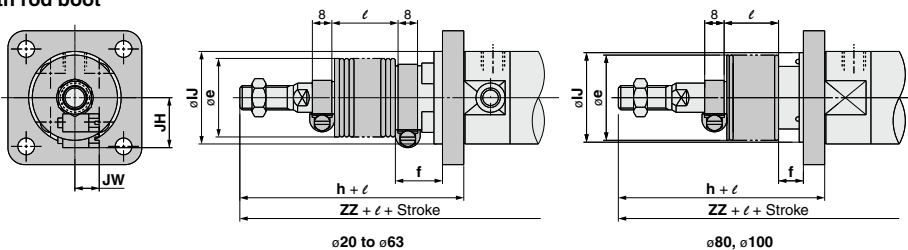

With air cushion

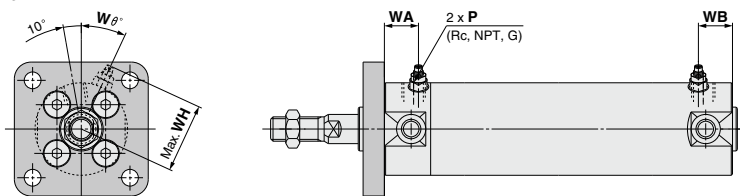

Bore size (mm)	Stroke range (mm)	Rc, NPT port			G port																					
		GA	GB	P	GA	GB	P	A	AL	B1	C	D	E	F	FX	FD	FT	H	H1	I	J	K	KA	MM		
20	Up to 200	201 to 350	12	10 (12)	1/8	12	10 (12)	M5 x 0.8	18	15.5	13	40	14	8	12	2	28	5.5	6	35	5	26	M4 x 0.7	5	6	M8 x 1.25
25	Up to 300	301 to 400	12	10 (12)	1/8	12	10 (12)	M5 x 0.8	22	19.5	17	44	16.5	10	14	2	32	5.5	7	40	6	31	M5 x 0.8	5.5	8	M10 x 1.25
32	Up to 300	301 to 450	12	10 (12)	1/8	10	9 (10)	1/8	22	19.5	17	53	20	12	18	2	38	6.6	7	40	6	38	M5 x 0.8	5.5	10	M10 x 1.25
40	Up to 300	301 to 800	13	10 (13)	1/8	10	9 (10)	1/8	30	27	19	61	26	16	25	2	46	6.6	8	50	8	47	M6 x 1	6	14	M14 x 1.5
50	Up to 300	301 to 1200	14	12 (14)	1/4	12	11 (12)	1/4	35	32	27	76	32	20	30	2	58	9	9	58	11	58	M8 x 1.25	7	18	M18 x 1.5
63	Up to 300	301 to 1200	14	12 (14)	1/4	12	11 (12)	1/4	35	32	27	92	38	20	32	2	70	11	9	58	11	72	M10 x 1.5	7	18	M18 x 1.5
80	Up to 300	301 to 1400	20	16 (20)	3/8	17	16 (17)	3/8	40	37	32	104	50	25	40	3	82	11	11	71	13	89	M10 x 1.5	10	22	M22 x 1.5
100	Up to 300	301 to 1500	20	16 (20)	1/2	17	16 (17)	1/2	40	37	41	128	60	30	50	3	100	14	14	71	16	110	M12 x 1.75	10	26	M26 x 1.5

(mm)			
Bore size (mm)	NA	S	ZZ
20	24	69 (77)	106 (114)
25	29	69 (77)	111 (119)
32	35.5	71 (79)	113 (121)
40	44	78 (87)	130 (139)
50	55	90 (102)	150 (162)
63	69	90 (102)	150 (162)
80	80	108 (122)	182 (196)
100	100	108 (122)	182 (196)

With Rod Boot (mm)								
Bore size (mm)	e	f	h	IJ	JH (Reference)	JW (Reference)	ℓ	ZZ
20	30	18	55	27	15.5	10.5	1/4 stroke	126 (134)
25	30	19	62	32	16.5	10.5		133 (141)
32	35	19	62	38	18.5	10.5		135 (143)
40	35	19	70	48	21.5	10.5		150 (159)
50	40	19	78	59	24	10.5		170 (182)
63	40	20	78	72	24	10.5		170 (182)
80	52	10	80	59	—	—		191 (205)
100	62	7	80	71	—	—		191 (205)

With Air Cushion (mm)						
Bore size (mm)	Rc, NPT, G P	WA	WB	WH	Wθ	
20	M5 x 0.8	16	15 (16)	23	30°	
25	M5 x 0.8	16	15 (16)	25	30°	
32	1/8	16	15 (16)	28.5	25°	
40	1/8	16	15 (16)	33	20°	
50	1/4	18	17 (18)	40.5	20°	
63	1/4	18	17 (18)	47.5	20°	
80	3/8	22	22	60.5	20°	
100	1/2	22	22	71	20°	

Note () : Denotes the dimensions for long stroke.

* The minimum stroke with rod boot is 20 mm.

Head Side Flange Style: CG1G□

With rubber bumper

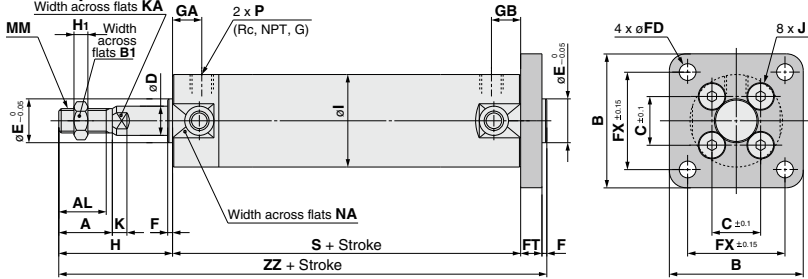

With rod boot

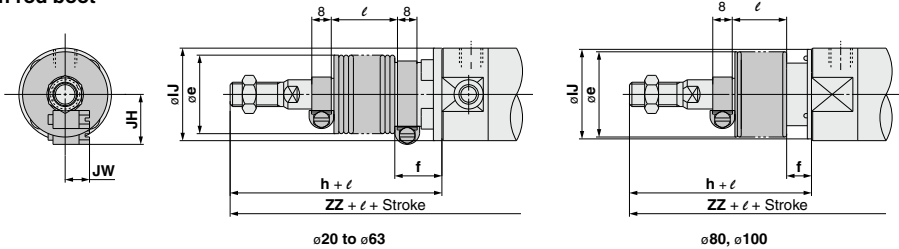

With air cushion

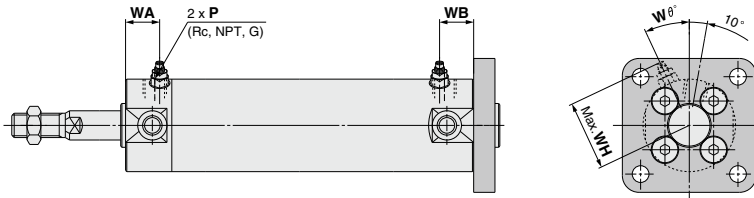

Bore size (mm)	Stroke range (mm)		Rc, NPT port		G port				A	AL	B1	B	C	D	E	F	FX	FD	FT	H	H1	I	J	K	KA	MM
	Standard	Long stroke	GA	GB	P	GA	GB	P																		
20	Up to 200	—	12	10	1/8	12	10	M5 x 0.8	18	15.5	13	40	14	8	12	2	28	5.5	6	35	5	26	M4 x 0.7	5	6	M8 x 1.25
25	Up to 300	—	12	10	1/8	12	10	M5 x 0.8	22	19.5	17	44	16.5	10	14	2	32	5.5	7	40	6	31	M5 x 0.8	5.5	8	M10 x 1.25
32	Up to 300	—	12	10	1/8	10	9	1/8	22	19.5	17	53	20	12	18	2	38	6.6	7	40	6	38	M5 x 0.8	5.5	10	M10 x 1.25
40	Up to 300	301 to 500	13	10 (13)	1/8	10	9 (10)	1/8	30	27	19	61	26	16	25	2	46	6.6	8	50	8	47	M6 x 1	6	14	M14 x 1.5
50	Up to 300	301 to 600	14	12 (14)	1/4	12	11 (12)	1/4	35	32	27	76	32	20	30	2	58	9	9	58	11	58	M8 x 1.25	7	18	M18 x 1.5
63	Up to 300	301 to 600	14	12 (14)	1/4	12	11 (12)	1/4	35	32	27	92	38	20	32	2	70	11	9	58	11	72	M10 x 1.5	7	18	M18 x 1.5
80	Up to 300	301 to 750	20	16 (20)	3/8	17	16 (17)	3/8	40	37	32	104	50	25	40	3	82	11	11	71	13	89	M10 x 1.5	10	22	M22 x 1.5
100	Up to 300	301 to 750	20	16 (20)	1/2	17	16 (17)	1/2	40	37	41	128	60	30	50	3	100	14	14	71	16	110	M12 x 1.75	10	26	M26 x 1.5

Bore size (mm)	(mm)		
	NA	S	ZZ
20	24	69	112
25	29	69	118
32	35.5	71	120
40	44	78 (87)	138 (147)
50	55	90 (102)	159 (171)
63	69	90 (102)	159 (171)
80	80	108 (122)	193 (207)
100	100	108 (122)	196 (210)

With Rod Boot

Bore size (mm)	(mm)							
	e	f	h	IJ	JH (Reference)	JW (Reference)	l	ZZ
20	30	18	55	27	15.5	10.5	1/4 stroke	132
25	30	19	62	32	16.5	10.5		140
32	35	19	62	38	18.5	10.5		142
40	35	19	70	48	21.5	10.5		158 (167)
50	40	19	78	59	24	10.5		179 (191)
63	40	20	78	72	24	10.5		179 (191)
80	52	10	80	59	—	—		202 (216)
100	62	7	80	71	—	—		205 (219)

With Air Cushion

Bore size (mm)	(mm)						
	Rc, NPT, G port	WA	WB	WH	Wθ		
20	M5 x 0.8	16	15	23	30°		
25	M5 x 0.8	16	15	25	30°		
32	1/8	16	15	28.5	25°		
40	1/8	16	15 (16)	33	20°		
50	1/4	18	17 (18)	40.5	20°		
63	1/4	18	17 (18)	47.5	20°		
80	3/8	22	22	60.5	20°		
100	1/2	22	22	71	20°		

Note (): Denotes the dimensions for long stroke.

* The minimum stroke with rod boot is 20 mm.

- CG1
- CGP
- CG2-Z
- CG2
- CM2-Z
- CM2
- CM3
- CG1-Z
- CG1
- CG3
- MB-Z
- MB
- MB1
- CA2-Z
- CA2
- CS1
- CS2

- D-□
- X□

Technical data

Series CG1

Rod Side Trunnion Style: CG1U□

With rubber bumper

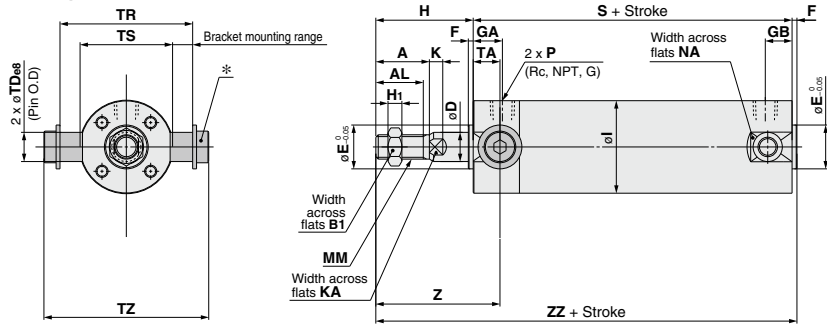

* Consists of trunnion pins, flat washers and hexagon socket head cap bolts.

With rod boot

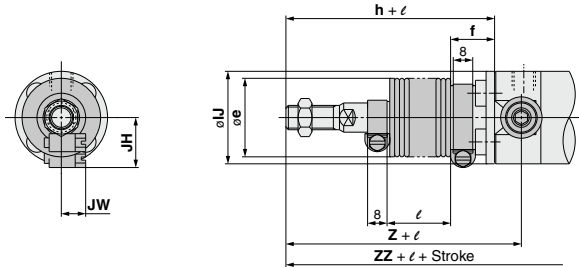

With air cushion

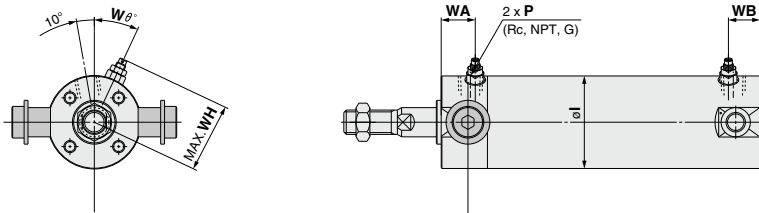

Bore size (mm)	Stroke range (mm)		Rc, NPT port			G port			A	AL	BL	D	E	F	H	H ₁	I	K	KA	MM	NA	S	TA	TD _{es}		
	Standard	Long stroke	GA	GB	P	GA	GB	P																		
20	Up to 200	-	12	10	1/8	12	10	1/8	10	M5 x 0.8	18	15.5	13	8	12	2	35	5	26	5	6	M8 x 1.25	24	69	11	8 _{3.025} 23.947
25	Up to 300	-	12	10	1/8	12	10	1/8	12	M5 x 0.8	22	19.5	17	10	14	2	40	6	31	5.5	8	M10 x 1.25	29	69	11	10 _{3.025} 30.047
32	Up to 300	-	12	10	1/8	10	9	1/8	9	1/8	22	19.5	17	12	18	2	40	6	38	5.5	10	M10 x 1.25	35.5	71	11	12 _{3.025} 32.059
40	Up to 300	301 to 500	13	10 (13)	1/8	10	9 (10)	1/8	30	27	19	16	25	2	50	8	47	6	14	M14 x 1.5	44	78 (87)	12	14 _{3.025} 43.969		
50	Up to 300	301 to 600	14	12 (14)	1/4	12	11 (12)	1/4	35	32	27	20	30	2	58	11	58	7	18	M18 x 1.5	55	90 (102)	13	16 _{3.025} 45.959		
63	Up to 300	301 to 600	14	12 (14)	1/4	12	11 (12)	1/4	40	35	32	27	20	32	2	58	11	72	7	18	M18 x 1.5	69	90 (102)	13	18 _{3.025} 47.959	

Bore size (mm)	(mm)					
	TR	TS	TZ	Z	ZZ	
20	39	28	47.6	46	106	
25	43	33	53	51	111	
32	54.5	40	67.7	51	113	
40	65.5	49	78.7	62	130 (139)	
50	80	60	98.6	71	150 (162)	
63	98	74	119.2	71	150 (162)	

Note () : Denotes the dimensions for long stroke.
Refer to page 321 for pivot bracket.

With Rod Boot

Bore size (mm)	(mm)										
	e	f	h	IJ	JH (Reference)	JW (Reference)	l	Z	ZZ		
20	30	18	55	27	15.5	10.5		66	126		
25	30	19	62	32	16.5	10.5		73	133		
32	35	19	62	38	18.5	10.5		73	135		
40	35	19	70	48	21.5	10.5	1/4 stroke	82	150 (159)		
50	40	19	78	59	24	10.5		91	170 (182)		
63	40	20	78	72	24	10.5		91	170 (182)		

* The minimum stroke with rod boot is 20 mm.

With Air Cushion

Bore size (mm)	(mm)					
	Rc, NPT, G P	WA	WB	WH	Wθ	
20	M5 x 0.8	16	15	23	30°	
25	M5 x 0.8	16	15	25	30°	
32	1/8	16	15	28.5	25°	
40	1/8	16	15 (16)	33	20°	
50	1/4	18	17 (18)	40.5	20°	
63	1/4	18	17 (18)	47.5	20°	

Head Side Trunnion Style: CG1T□

With rubber bumper

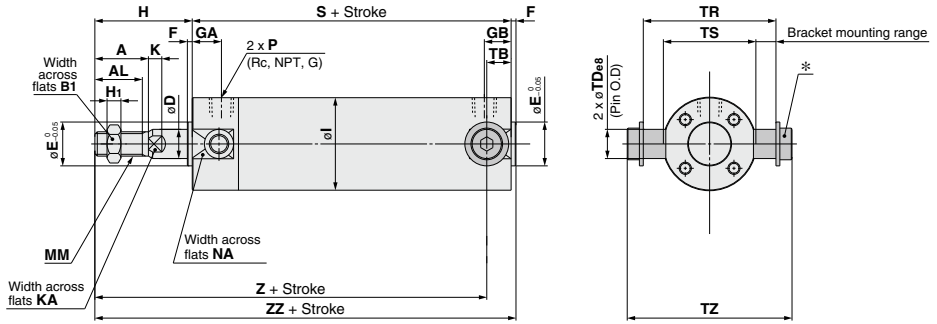

With rod boot

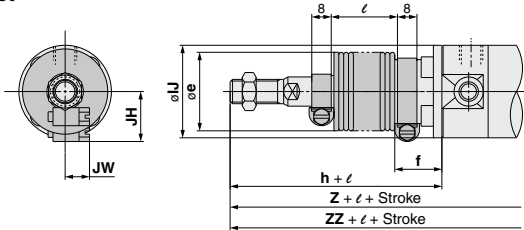

* Consists of trunnion pins, flat washers and hexagon socket head cap bolts.

With air cushion

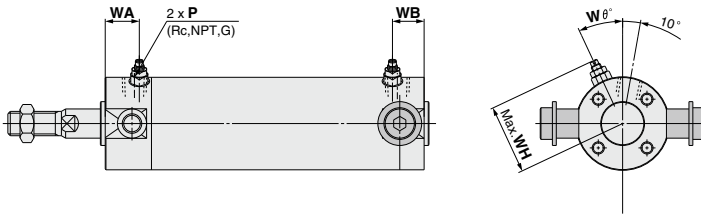

Bore size (mm)	Stroke range (mm)		Rc, NPT port			G port													TDø8	TR						
	Standard	Long stroke	GA	GB	P	GA	GB	P	A	AL	B1	D	E	F	H	H1	I	K			KA	MM	NA	S	TB	
20	Up to 200	-	12	10 (12)	1/8	12	10 (12)	M5 x 0.8	18	15.5	13	8	12	2	35	5	26	5	6	M8 x 1.25	24	69	11	8	^{-0.025} _{-0.047}	39
25	Up to 300	-	12	10 (12)	1/8	12	10 (12)	M5 x 0.8	22	19.5	17	10	14	2	40	6	31	5.5	8	M10 x 1.25	29	69	11	10	^{-0.025} _{-0.047}	43
32	Up to 300	-	12	10 (12)	1/8	10	9 (10)	1/8	22	19.5	17	12	18	2	40	6	38	5.5	10	M10 x 1.25	35.5	71	10	12	^{-0.025} _{-0.047}	54.5
40	Up to 300	301 to 500	13	10 (13)	1/8	10	9 (10)	1/8	30	27	19	16	25	2	50	8	47	6	14	M14 x 1.5	44	78 (87)	10 (12)	14	^{-0.025} _{-0.047}	65.5
50	Up to 300	301 to 600	14	12 (14)	1/4	12	11 (12)	1/4	35	32	27	20	30	2	58	11	58	7	18	M18 x 1.5	55	90 (102)	12 (13)	16	^{-0.025} _{-0.047}	80
63	Up to 300	301 to 600	14	12 (14)	1/4	12	11 (12)	1/4	35	32	27	20	32	2	58	11	72	7	18	M18 x 1.5	69	90 (102)	12 (13)	18	^{-0.025} _{-0.047}	98

Bore size (mm)	(mm)			
	TS	TZ	Z	ZZ
20	28	47.6	93	106
25	33	53	98	111
32	40	67.7	101	113
40	49	78.7	118 (125)	130 (139)
50	60	98.6	136 (147)	150 (162)
63	74	119.2	136 (147)	150 (162)

Bore size (mm)	With Rod Boot										(mm)	
	e	f	h	IJ	JH (Reference)	JW (Reference)	l	Z	ZZ	1/4 stroke		
20	30	18	55	27	15.5	10.5	113	126				
25	30	19	62	32	16.5	10.5	120	133				
32	35	19	62	38	18.5	10.5	123	135				
40	35	19	70	48	21.5	10.5	138 (145)	150 (159)				
50	40	19	78	59	24	10.5	156 (167)	170 (182)				
63	40	20	78	72	24	10.5	156 (167)	170 (182)				

Bore size (mm)	With Air Cushion					(mm)	
	Rc, NPT, G P	WA	WB	WH	Wθ		
20	M5 x 0.8	16	15	23	30°		
25	M5 x 0.8	16	15	25	30°		
32	1/8	16	15	28.5	25°		
40	1/8	16	15 (16)	33	20°		
50	1/4	18	17 (18)	40.5	20°		
63	1/4	18	17 (18)	47.5	20°		

Note () : Denotes the dimensions for long stroke. Refer to page 321 for pivot bracket.

* The minimum stroke with rod boot is 20 mm.

- CG1
- CGP
- CG2 -Z
- CG2
- CM2 -Z
- CM2
- CM3
- CG1 -Z
- CG1
- CG3
- MB -Z
- MB
- MB1
- CA2 -Z
- CA2
- CS1
- CS2

- D-□
- X□

Technical data

Series CG1

Clevis Style: CG1D□ (ø20 to ø63)

With rubber bumper

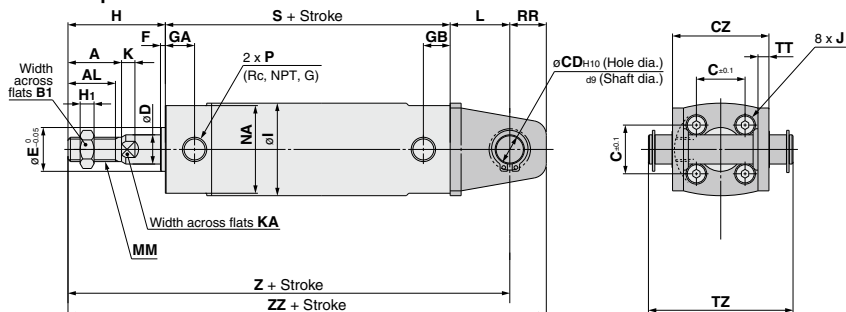

* The above shows the case port location is changed by 90°

With rod boot

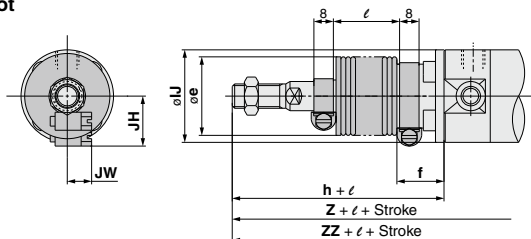

With air cushion

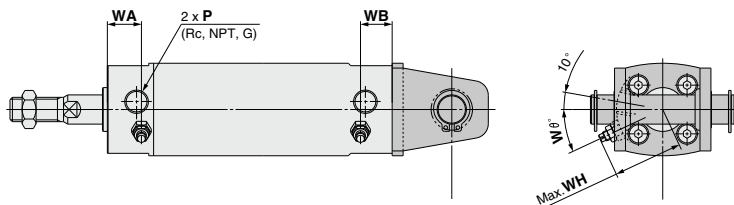

Bore size (mm)	Stroke range (mm)		Rc, NPT port		G port																								
	Standard	Long stroke	GA	GB	P	GA	GB	P	A	AL	B1	C	CD	CZ	D	E	F	H	Hi	I	J	K	KA	MM	NA	RR	S	L	
20	Up to 200	—	12	10	1/8	12	10	10	M5 x 0.8	22	19.5	17	16.5	10	33	10	14	2	40	6	31	M5 x 0.8	5.5	8	M10 x 1.25	29	13	69	16
32	Up to 300	—	12	10	1/8	10	9	1/8	22	19.5	17	20	12	40	12	18	2	40	6	38	M5 x 0.8	5.5	10	M10 x 1.25	35.5	15	71	20	
40	Up to 300	301 to 500	13	10 (13)	1/8	10	9 (10)	1/8	30	27	19	26	14	49	16	25	2	50	8	47	M6 x 1	6	14	M14 x 1.5	44	18	78 (87)	22	
50	Up to 300	301 to 600	14	12 (14)	1/4	12	11 (12)	1/4	35	32	27	32	16	60	20	30	2	58	11	58	M8 x 1.25	7	18	M18 x 1.5	55	20	90 (102)	25	
63	Up to 300	301 to 600	14	12 (14)	1/4	12	11 (12)	1/4	35	32	27	38	18	74	20	32	2	58	11	72	M10 x 1.5	7	18	M18 x 1.5	69	22	90 (102)	30	

Bore size (mm)	(mm)				Applicable pin part no.	
	TH	TT	TZ	Z		
20	25	3.2	43.4	118	129	CD-G02
25	30	3.2	48	125	138	CD-G25
32	35	4.5	59.4	131	146	CD-G03
40	40	4.5	71.4	150 (159)	168 (177)	CD-G04
50	50	6	86	173 (185)	193 (205)	CD-G05
63	60	8	105.4	178 (190)	200 (212)	CD-G06

Note () : Denotes the dimensions for long stroke. Refer to page 321 for pivot bracket.

With Rod Boot

Bore size (mm)	(mm)										Z	ZZ
	e	f	h	IJ	JH	JW	l	Z	ZZ			
20	30	18	55	27	15.5	10.5	138	149				
25	30	19	62	32	16.5	10.5	147	160				
32	35	19	62	38	18.5	10.5	153	168				
40	35	19	70	48	21.5	10.5	170 (179)	188 (197)				
50	40	19	78	59	24	10.5	193 (205)	213 (225)				
63	40	20	78	72	24	10.5	198 (210)	220 (232)				

* The minimum stroke with rod boot is 20 mm.

With Air Cushion

Bore size (mm)	(mm)			
	Rc, NPT, G	WA	WB	WH
20	M5 x 0.8	16	15	23
25	M5 x 0.8	16	15	25
32	1/8	16	15	28.5
40	1/8	16	15 (16)	33
50	1/4	18	17 (18)	40.5
63	1/4	18	17 (18)	47.5

Clevis Style: CG1D□ (ø80, ø100)

With rubber bumper

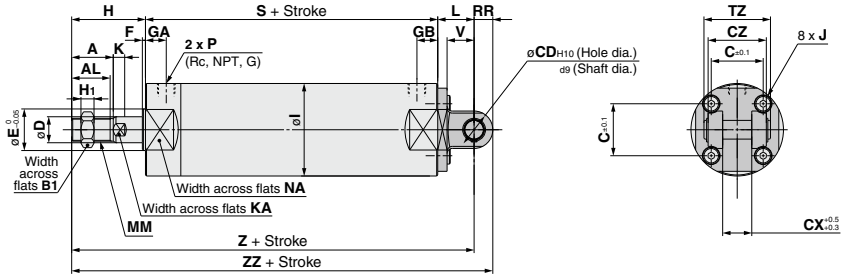

With rod boot

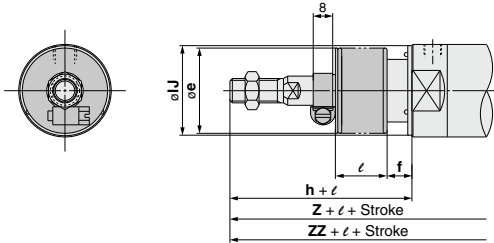

With air cushion

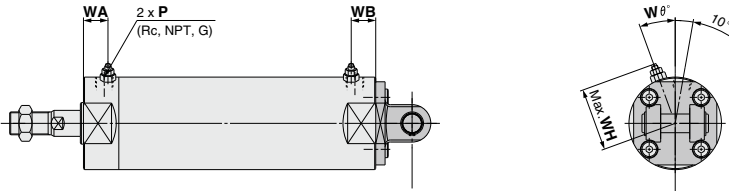

Bore size (mm)	Stroke range (mm)		Rc, NPT port			G port			A	AL	BL	C	CD	CX	CZ	D	E	F	H	H ₁	I	J	K	KA	L
	Standard	Long stroke	GA	GB	P	GA	GB	P																	
80	Up to 300	301 to 750	20	16 (20)	3/8	17	16 (17)	3/8	40	37	32	50	18	28	56	25	40	3	71	13	89	M10 x 1.5	10	22	35
100	Up to 300	301 to 750	20	16 (20)	1/2	17	16 (17)	1/2	40	37	41	60	22	32	64	30	50	3	71	16	110	M12 x 1.75	10	26	43

Bore size (mm)	(mm)								Applicable pin part no.
	MM	NA	RR	S	TZ	V	Z	ZZ	
80	M22 x 1.5	80	18	108 (122)	64	26	214 (228)	232 (246)	IY-G08
100	M26 x 1.5	100	22	108 (122)	72	32	222 (236)	244 (258)	IY-G10

Note (): Denotes the dimensions for long stroke. Refer to page 321 for pivot bracket.

With Rod Boot

Bore size (mm)	(mm)						
	e	f	h	IJ	l	Z	ZZ
80	52	10	80	59	1/4	223 (237)	241 (255)
100	62	7	80	71	stroke	231 (245)	253 (267)

* The minimum stroke with rod boot is 20 mm.

With Air Cushion

Bore size (mm)	(mm)					
	Rc, NPT, G	WA	WB	WH	Wθ	
80	3/8	22	22	60.5	20°	
100	1/2	22	22	71	20°	

CG1

CJP

CJ2-Z

CJ2

CM2-Z

CM2

CM3

CG1-Z

CG1

CG3

MB-Z

MB

MB1

CA2-Z

CA2

CS1

CS2

D-□

-X□

Technical data

Accessory Bracket Dimensions

Single Knuckle Joint

I-G02, G03

Material: Rolled steel

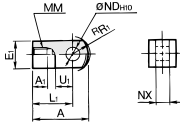

I-G04, G05, G08, G10

Material: Cast iron

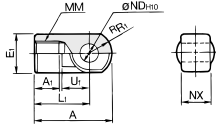

Part no.	Applicable bore (mm)	A	A ₁	E ₁	L ₁	MM	R ₁	U ₁	ND _{H10}	NX
I-G02	20	34	8.5	□16	25	M8 x 1.25	10.3	11.5	8 ^{+0.058} ₋₀	8 ^{-0.2} _{-0.4}
I-G03	25,32	41	10.5	□20	30	M10 x 1.25	12.8	14	10 ^{+0.058} ₋₀	10 ^{-0.4} _{-0.4}
I-G04	40	42	14	□22	30	M14 x 1.5	12	14	10 ^{+0.058} ₋₀	18 ^{-0.5} _{-0.5}
I-G05	50,63	56	18	□28	40	M18 x 1.5	16	20	14 ^{+0.070} ₋₀	22 ^{-0.3} _{-0.2}
I-G08	80	71	21	□38	50	M22 x 1.5	21	27	18 ^{+0.070} ₋₀	28 ^{-0.3} _{-0.2}
I-G10	100	79	21	□44	55	M26 x 1.5	24	31	22 ^{+0.084} ₋₀	32 ^{-0.3} _{-0.5}

Knuckle Pin

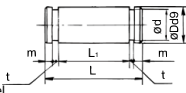

Material: Carbon steel

Part no.	Applicable bore (mm)	Dd9	L	d	L ₁	m	t	Applicable snap ring
IY-G02	20	8 ^{+0.040} _{-0.076}	21	7.6	16.2	1.5	0.9	Type C 8 for axis
IY-G03	25,32	10 ^{+0.040} _{-0.076}	25.6	9.6	20.2	1.55	1.15	Type C 10 for axis
IY-G04	40	10 ^{+0.040} _{-0.093}	41.6	9.6	36.2	1.55	1.15	Type C 10 for axis
IY-G05	50,63	14 ^{+0.050} _{-0.093}	50.6	13.4	44.2	2.05	1.15	Type C 14 for axis
IY-G08	80	18 ^{+0.050} _{-0.093}	64	17	56.2	2.55	1.35	Type C 18 for axis
IY-G10	100	22 ^{+0.065} _{-0.117}	72	21	64.2	2.55	1.35	Type C 22 for axis

* Retaining rings are shipped together.

Clevis Pin

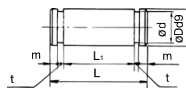

Material: Carbon steel

Part no.	Applicable bore (mm)	Dd9	L	d	L ₁	m	t	Applicable snap ring
CD-G02	20	8 ^{+0.040} _{-0.076}	43.4	7.6	38.6	1.5	0.9	Type C 8 for axis
CD-G25	25	10 ^{+0.040} _{-0.076}	48	9.6	42.6	1.55	1.15	Type C 10 for axis
CD-G03	32	12 ^{+0.050} _{-0.093}	59.4	11.5	54	1.55	1.15	Type C 12 for axis
CD-G04	40	14 ^{+0.050} _{-0.093}	71.4	13.4	65	2.05	1.15	Type C 14 for axis
CD-G05	50	16 ^{+0.050} _{-0.093}	86	15.2	79.6	2.05	1.15	Type C 16 for axis
CD-G06	63	18 ^{+0.050} _{-0.093}	105.4	17	97.8	2.45	1.35	Type C 18 for axis

* Retaining rings are shipped together.

* Clevis pin and knuckle pin are common for bore size ø80 and ø100.

Double Knuckle Joint

Y-G02, G03

Material: Rolled steel

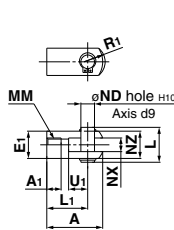

Y-G04, G05, G08, G10

Material: Cast iron

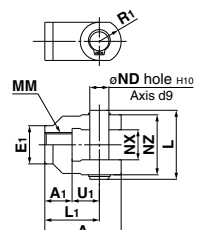

Part no.	Applicable bore (mm)	A	A ₁	E ₁	L ₁	MM	R ₁	U ₁	ND	NX	NZ	L	Applicable pin part no.
Y-G02	20	34	8.5	□16	25	M8 x 1.25	10.3	11.5	8	8 ^{+0.058} ₋₀	16	21	IY-G02
Y-G03	25,32	41	10.5	□20	30	M10 x 1.25	12.8	14	10	10 ^{+0.058} ₋₀	20	25.6	IY-G03
Y-G04	40	42	14	□22	30	M14 x 1.5	12	14	10	10 ^{+0.058} ₋₀	36	41.6	IY-G04
Y-G05	50,63	56	18	□28	40	M18 x 1.5	16	20	14	14 ^{+0.070} ₋₀	44	50.6	IY-G05
Y-G08	80	71	21	□38	50	M22 x 1.5	21	27	18	18 ^{+0.070} ₋₀	56	64	IY-G08
Y-G10	100	79	24	□44	55	M26 x 1.5	24	31	22	22 ^{+0.084} ₋₀	64	72	IY-G10

* Knuckle pin and retaining ring are shipped together.

Rod End Nut

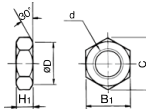

Material: Rolled steel

Part no.	Applicable bore (mm)	d	H ₁	B ₁	C	D
NT-02	20	M8 x 1.25	5	13	(15)	12.5
NT-03	25,32	M10 x 1.25	6	17	(19.6)	16.5
NT-G04	40	M14 x 1.5	8	19	(21.9)	18
NT-05	50,63	M18 x 1.5	11	27	(31.2)	26
NT-08	80	M22 x 1.5	13	32	(37.0)	31
NT-10	100	M26 x 1.5	16	41	(47.3)	39

Pivot Bracket

ø20 to ø63

Material: Rolled steel

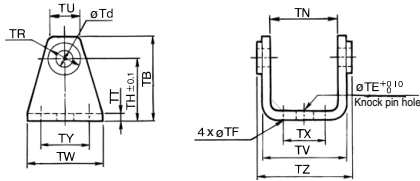

ø80, ø100

Material: Cast iron

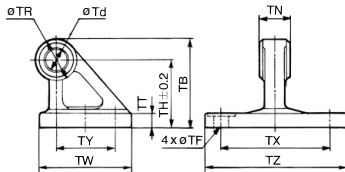

(mm)

Part no.	Applicable bore (mm)	TB	Td	TE	TF	TH	TN	TR	TT
CG-020-24A	20	36	8	10	5.5	25	(29.3)	13	3.2
CG-025-24A	25	43	10	10	5.5	30	(33.1)	15	3.2
CG-032-24A	32	50	12	10	6.6	35	(40.4)	17	4.5
CG-040-24A	40	58	14	10	6.6	40	(49.2)	21	4.5
CG-050-24A	50	70	16	20	9	50	(60.4)	24	6
CG-063-24A	63	82	18	20	11	60	(74.6)	26	8
CG-080-24A	80	73	18	-	11	55	28 ^{+0.05} _{-0.03}	36	11
CG-100-24A	100	90	22	-	13.5	65	32 ^{+0.05} _{-0.03}	50	12

Part no.	Applicable bore (mm)	TU	TV	TW	TX	TY	TZ	Applicable pin O.D
CG-020-24A	20	(18.1)	(35.8)	42	16	28	38.3	8d ₉ ^{+0.040} _{-0.076}
CG-025-24A	25	(20.7)	(39.8)	42	20	28	42.1	10d ₉ ^{+0.040} _{-0.076}
CG-032-24A	32	(23.6)	(49.4)	48	22	28	53.8	12d ₉ ^{+0.050} _{-0.093}
CG-040-24A	40	(27.3)	(58.4)	56	30	30	64.6	14d ₉ ^{+0.050} _{-0.093}
CG-050-24A	50	(29.7)	(72.4)	64	36	36	79.2	16d ₉ ^{+0.050} _{-0.093}
CG-063-24A	63	(34.3)	(90.4)	74	46	46	97.2	18d ₉ ^{+0.050} _{-0.093}
CG-080-24A	80	-	-	72	85	45	110	18d ₉ ^{+0.050} _{-0.093}
CG-100-24A	100	-	-	93	100	60	130	22d ₉ ^{+0.065} _{-0.117}

CG1

CGP

CGJ2
-Z

CGJ2

CM2
-Z

CM2

CM3

CG1
-Z

CG1

CG3

MB
-Z

MB

MB1

CA2
-Z

CA2

CS1

CS2

D-□

-X□

Technical data

Air Cylinder: Standard Type Double Acting, Double Rod Series **CG1W** ø20, ø25, ø32, ø40, ø50, ø63, ø80, ø100

How to Order

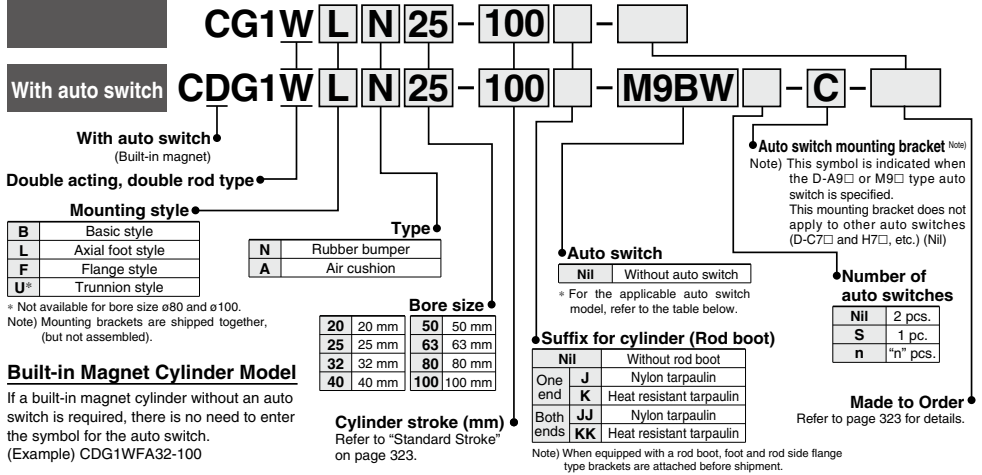

Built-in Magnet Cylinder Model

If a built-in magnet cylinder without an auto switch is required, there is no need to enter the symbol for the auto switch.
(Example) CDG1WFA32-100

Applicable Auto Switches

Refer to pages 1559 to 1673 for further information on auto switches.

Type	Special function	Electrical entry	Indicator light	Wiring (Output)	Load voltage		Auto switch model		Lead wire length (m)					Pre-wired connector	Applicable load	
					DC	AC	Applicable bore size		0.5 (Nil)	1 (M)	3 (L)	5 (Z)	None (N)			
							ø20 to ø63	ø80, ø100								
Solid state auto switch	Diagnostic indication (2-color indication)	Grommet	Yes	3-wire (NPN) 3-wire (PNP)	5 V, 12 V	—	Perpendicular	M9NV	M9N	●	●	●	○	—	○	IC circuit
								—	—	●	●	●	○	—	○	
								M9PV	M9P	●	●	●	○	—	○	
								—	—	●	●	●	○	—	○	
								—	—	●	●	●	○	—	○	
	Water resistant (2-color indication)	Connector	Yes	2-wire	12 V	—	In-line	—	K59	●	●	●	○	—	○	—
								—	—	●	●	●	○	—	○	
								—	H7C	●	●	●	○	—	○	
								M9NWV	M9NW	●	●	●	○	—	○	
								—	—	●	●	●	○	—	○	
Diagnostic output (2-color indication)	Grommet	Yes	3-wire (NPN) 3-wire (PNP) 2-wire	5 V, 12 V	—	Perpendicular	—	G59W	●	●	●	○	—	○	IC circuit	
							—	—	●	●	●	○	—	○		
							—	—	●	●	●	○	—	○		
							M9BWV	M9BW	●	●	●	○	—	○		
							—	—	●	●	●	○	—	○		
Reed auto switch	Diagnostic indication (2-color indication)	Grommet	Yes	4-wire (NPN) 3-wire (Equip. to NPN)	5 V	—	Perpendicular	A96V	A96	●	●	●	○	—	○	IC circuit
								—	—	●	●	●	○	—	○	
								—	—	●	●	●	○	—	○	
								—	—	●	●	●	○	—	○	
								—	—	●	●	●	○	—	○	
	Diagnostic indication (2-color indication)	Connector	Yes	2-wire	24 V	—	In-line	—	A93V	A93	●	●	●	○	—	IC circuit
								—	A90V	A90	●	●	●	○	—	
								—	—	●	●	●	○	—	○	
								—	—	●	●	●	○	—	○	
								—	—	●	●	●	○	—	○	
Diagnostic indication (2-color indication)	Grommet	Yes	2-wire	24 V	—	Perpendicular	—	B54	●	●	●	○	—	—		
							—	B64	●	●	●	○	—		○	
							—	—	●	●	●	○	—		○	
							—	C73C	●	●	●	○	—		○	
							—	C80C	●	●	●	○	—		○	
Diagnostic indication (2-color indication)	Grommet	Yes	2-wire	24 V	—	Perpendicular	—	B59W	●	●	●	○	—	IC circuit		
							—	—	●	●	●	○	—		○	

** Water resistant type auto switches can be mounted on the above models, but in such case SMC cannot guarantee water resistance. Consult with SMC regarding water resistant types with the above model numbers.

* Lead wire length symbols: 0.5 m Nil (Example) M9NV
1 m M (Example) M9NW
3 m L (Example) M9NL
5 m Z (Example) M9NZ
None N (Example) H7CN

* Solid state auto switches marked with "○" are produced upon receipt of order.

* Since there are other applicable auto switches than listed, refer to page 368 for details.

* For details about auto switches with pre-wired connector, refer to pages 1626 and 1627.

* D-A9□□/M9□□□ auto switches are shipped together (not assembled). (Only auto switch mounting brackets are assembled before shipped.)

Air Cylinder: Standard Type Double Acting, Double Rod *Series CG1W*



Specifications

Bore size (mm)	20	25	32	40	50	63	80	100
Action	Double acting, Double rod							
Lubricant	Not required (Non-lube)							
Fluid	Air							
Proof pressure	1.5 MPa							
Maximum operating pressure	1.0 MPa							
Minimum operating pressure	0.08 MPa							
Ambient and fluid temperature	Without auto switch: -10 to 70°C (No freezing)							
	With auto switch: -10 to 60°C (No freezing)							
Piston speed	50 to 1000 mm/s						50 to 700 mm/s	
Stroke length tolerance	up to 1000 ^{+1.4} ₀ mm,						up to 1000 ^{+1.4} ₀ mm,	
	up to 1200 ^{+1.8} ₀ mm						up to 1500 ^{+1.8} ₀ mm	
Cushion	Rubber bumper, Air cushion							
Mounting *	Basic style, Axial foot style, Rod side flange style, Rod side trunnion style							

* Rod side trunnion style is not available for bore sizes ø80 and ø100.

Symbol

Rubber bumper

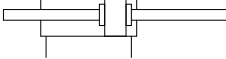

Air cushion

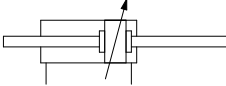

Made to Order Specifications
(For details, refer to pages 1675 to 1818.)

Symbol	Specifications
-XA□	Change of rod end shape
-XB6	Heat resistant cylinder (150°C) *1
-XB7	Cold resistant cylinder *2
-XC6	Piston rod and rod end nut made of stainless steel
-XC13	Auto switch rail mounting style
-XC22	Fluororubber seats
-XC37	Large throttle diameter of connecting port
-XC85	Grease for food processing equipment

* 1 Cylinders with rubber bumper have no bumper.

* 2 Compatible with cylinders with rubber bumper, but has no bumper.

Refer to pages 363 to 368 for cylinders with auto switches.

- Minimum auto switch mounting stroke
- Proper auto switch mounting position (detection at stroke end) and mounting height
- Operating range
- Switch mounting bracket: Part no.

Accessory

Mounting		Basic style	Axial foot style	Rod side flange style	Rod side trunnion style
Standard equipment	Rod end nut	●	●	●	●
	Single knuckle joint	●	●	●	●
Option	Double knuckle joint (With pin) **	●	●	●	●
	Pivot bracket *	—	—	—	●*
	Rod boot	●	●	●	●

* Not available for bore size ø80 and ø100.

** Pin and retaining ring are shipped together with double knuckle joint.

Standard Stroke

Bore size (mm)	Standard stroke (mm) (1)	Long stroke (mm)	Maximum manufacturable stroke
20	25, 50, 75, 100, 125, 150, 200	201 to 350	1500
25	25, 50, 75, 100, 125, 150, 200, 250, 300	301 to 400	
32		301 to 450	
40		301 to 800	
50, 63		301 to 1200	
80		301 to 1400	
100		301 to 1500	

Note 1) Manufacture of intermediate strokes at 1 mm intervals is possible. (Spacers are not used.)

Note 2) Long stroke is compatible with the axial foot and rod side flange types. When other mounting brackets are used or the long stroke exceeds the limit, the allowable maximum stroke length is determined using the stroke selection table (front matter 28)

Rod Boot Material

Symbol	Rod boot material	Maximum ambient temperature
J	Nylon tarpaulin	70°C
K	Heat resistant tarpaulin	110°C *

* Maximum ambient temperature for the rod boot itself.

CJ1

CJP

CJ2
-Z

CJ2

CM2
-Z

CM2

CM3

CG1
-Z

CG1

CG3

MB
-Z

MB

MB1

CA2
-Z

CA2

CS1

CS2

D-□

-X□

Technical data

Series CG1W

Weight

(kg)

Bore size (mm)		20	25	32	40	50	63	80	100
Basic weight	Basic style	0.13	0.22	0.33	0.55	1.02	1.37	2.64	4.09
	Axial foot style	0.24	0.35	0.49	0.77	1.50	2.09	3.60	5.84
	Flange style	0.21	0.32	0.47	0.75	1.36	1.87	3.35	5.44
	Trunnion style	0.14	0.24	0.36	0.60	1.16	1.51	—	—
Pivot bracket		0.08	0.09	0.17	0.25	0.44	0.80	—	—
Single knuckle joint		0.05	0.09	0.09	0.10	0.22	0.22	0.39	0.57
Double knuckle joint (With pin)		0.05	0.09	0.09	0.13	0.26	0.26	0.64	1.31
Additional weight per each 50 mm of stroke		0.07	0.10	0.13	0.23	0.34	0.38	0.54	0.77
Additional weight with air cushion		0.01	0.01	0.02	0.02	0.03	0.03	0.09	0.10

Calculation: (Example) **CG1WLN32-100** (Foot style, ø32, 100 st)

- Basic weight:.....0.49 (Foot, ø32) • Cylinder stroke:.....100 st
- Additional weight:.....0.13/50 st 0.49 + 0.13 × 100/50 = 0.75 kg

⚠ Precautions

Be sure to read before handling.
Refer to front matter 57 for Safety Instructions and pages 3 to 12 for Actuator and Auto Switch Precautions.

Mounting Bracket Part No.

Mounting bracket	Min. order	Bore size(mm)								Description
		20	25	32	40	50	63	80	100	
Axial foot	Note) 2	CG-L020	CG-L025	CG-L032	CG-L040	CG-L050	CG-L063	CG-L080	CG-L100	Foot x 2, Mounting bolt x 8
Flange	1	CG-F020	CG-F025	CG-F032	CG-F040	CG-F050	CG-F063	CG-F080	CG-F100	Flange x 1, Mounting bolt x 4
Trunnion pin	1	CG-T020	CG-T025	CG-T032	CG-T040	CG-T050	CG-T063	—	—	Trunnion pin x 2, Trunnion bolt x 2, Flat washer x 2
Pivot bracket	1	CG-020-24A	CG-025-24A	CG-032-24A	CG-040-24A	CG-050-24A	CG-063-24A	—	—	Pivot bracket x 1

Note) Order two foot brackets per cylinder.

Air-hydro

CG1 **Mounting style** H **Bore size** — **Stroke**

↓ Air-hydro

Low pressure hydraulic cylinder of 1.0 MPa or less

When used together with a Series CC air-hydro unit, constant and low speed actuation and intermediate stopping similar to hydraulic units are possible with the use of valves and other pneumatic equipment.

Specifications

Type	Air-hydro
Bore size (mm)	20, 25, 32, 40, 50, 63
Action	Double acting
Fluid	Turbine oil
Proof pressure	1.5 MPa
Maximum operating pressure	1.0 MPa
Minimum operating pressure	0.18 MPa
Piston speed	15 to 300 mm/s
Cushion	None
Ambient and fluid temperature	+5 to 60°C
Mounting	Basic style, Axial foot style, Flange style, Trunnion style

* Auto switch can be mounted.

* Dimensions are the same as the double rod standard type on page 326.

Construction

With rubber bumper

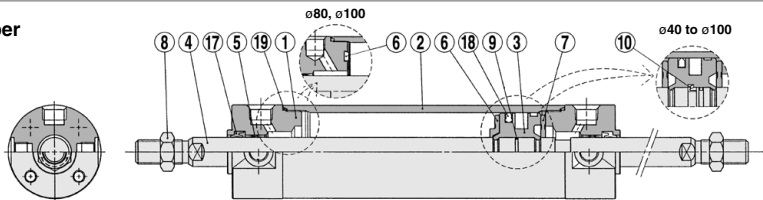

With air cushion

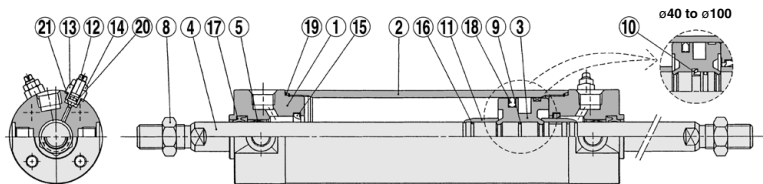

Component Parts

No.	Description	Material	Note
1	Rod cover	Aluminum alloy	Clear hard anodized
2	Cylinder tube	Aluminum alloy	Hard anodized
3	Piston	Aluminum alloy	Chromated *
4	Piston rod	Carbon steel *	Hard chrome plated
5	Bushing	Bearing alloy	
6	Bumper A	Urethane	
7	Bumper B	Urethane	$\phi 40$ or larger: The same as bumper A
8	Rod end nut	Rolled steel	Zinc chromated
9	Piston gasket	NBR	
10	Piston holder	Urethane	$\phi 40$ or more *
11	Cushion ring	Aluminum alloy	Anodized
12	Cushion valve	Rolled steel	Electroless nickel plated
13	Valve retainer	Rolled steel	Nickel plated
14	Lock nut	Carbon steel	
15	Cushion seal	Urethane	
16	Cushion ring gasket	NBR	
17	Rod seal	NBR	
18	Piston seal	NBR	
19	Tube gasket	NBR	
20	Valve seal	NBR	
21	Valve retaining gasket	NBR	

Note) In the case of cylinders with auto switches, magnets are installed in the piston.
* The material is stainless steel on auto switch equipped styles $\phi 20$ and $\phi 25$.

Replacement Parts/Seal Kit

• For rubber bumper

Bore size (mm)	Kit no.	Contents
20	CG1WN20-PS	Set of the nos. ①, ③, ⑯
25	CG1WN25-PS	
32	CG1WN32-PS	
40	CG1WN40-PS	

• For air cushion

Bore size (mm)	Kit no.	Contents
20	CG1WA20-PS	Set of the nos. ①, ③, ⑱, ⑳, ㉑
25	CG1WA25-PS	
32	CG1WA32-PS	
40	CG1WA40-PS	

Note) Refer to the Specific Product Precautions on page 310 for Disassembly/Replacement.
Order with a part number for each type and bore size.

* The seal kit includes a grease pack (10 g). Order with the following part number when only the grease pack is needed.
Grease pack part no.: GR-S-010 (10 g)

CG1

CGP

CG2
-Z

CG2

CM2
-Z

CM2

CM3

CG1
-Z

CG1

CG3

MB
-Z

MB

MB1

CA2
-Z

CA2

CS1

CS2

D-□

-X□

Technical
data

Series CG1W

Basic Style with Rubber Bumper: CG1WBN

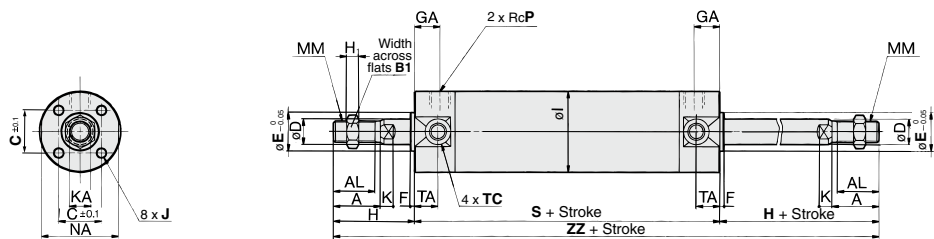

<With rod boot at one end>

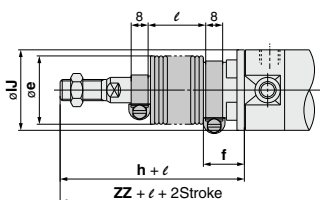

<With rod boot at both ends>

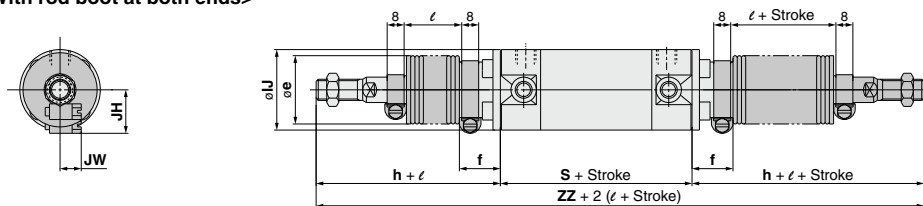

																				(mm)	
Bore size (mm)	Stroke range (mm)	A	AL	B ₁	C	D	E	F	GA	H ₁	I	J	K	KA	MM	NA	P	S			
20	Up to 350	18	15.5	13	14	8	12	2	12	5	26	M4 x 0.7 depth 7	5	6	M8 x 1.25	24	1/8	77			
25	Up to 400	22	19.5	17	16.5	10	14	2	12	6	31	M5 x 0.8 depth 7.5	5.5	8	M10 x 1.25	29	1/8	77			
32	Up to 450	22	19.5	17	20	12	18	2	12	6	38	M5 x 0.8 depth 8	5.5	10	M10 x 1.25	35.5	1/8	79			
40	Up to 800	30	27	19	26	16	25	2	13	8	47	M6 x 1 depth 12	6	14	M14 x 1.5	44	1/8	87			
50	Up to 1200	35	32	27	32	20	30	2	14	11	58	M8 x 1.25 depth 16	7	18	M18 x 1.5	55	1/4	102			
63	Up to 1200	35	32	27	38	20	32	2	14	11	72	M10 x 1.5 depth 16	7	18	M18 x 1.5	69	1/4	102			
80	Up to 1400	40	37	32	50	25	40	3	20	13	89	M10 x 1.5 depth 22	10	22	M22 x 1.5	80	3/8	122			
100	Up to 1500	40	37	41	60	30	50	3	20	16	110	M12 x 1.75 depth 22	10	26	M26 x 1.5	100	1/2	122			

Bore size (mm)	TA	TC **	Without rod boot			With rod boot on one side *						With rod boot on both sides *	
			H	ZZ	e	f	h	IJ	JH (Reference)	JW (Reference)	ℓ	ZZ	ZZ
20	11	M5 x 0.8	35	147	30	18	55	27	15.5	10.5	1/4 stroke	167	187
25	11	M6 x 0.75	40	157	30	19	62	32	16.5	10.5		179	201
32	11	M8 x 1.0	40	159	35	19	62	38	18.5	10.5		181	203
40	12	M10 x 1.25	50	187	35	19	70	48	21.5	10.5		207	227
50	13	M12 x 1.25	58	218	40	19	78	59	24	10.5		238	258
63	13	M14 x 1.5	58	218	40	20	78	72	24	10.5		238	258
80	—	—	71	264	52	10	80	59	—	—		273	282
100	—	—	71	264	62	7	80	71	—	—	273	282	

Air-hydro

Bore size (mm)	S	ZZ
20	77	147
25	77	157
32	79	159
40	87	187
50	102	218
63	102	218

* The minimum stroke with rod boot is 20 mm.

** Tunnion mounting screw with width across flats NA are not attached for bore sizes $\phi 80$ and $\phi 100$.

Basic Style with Air Cushion: CG1WBA

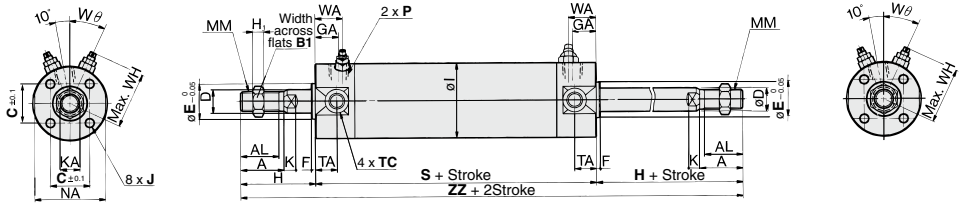

* For the one with rod boot, refer to w/ rubber bumper. (mm)

Bore size (mm)	Standard stroke range (mm)	Long stroke range (mm)	A	AL	B ₁	C	D	E	F	GA	H	H ₁	I	J	K	KA
20	Up to 200	201 to 350	18	15.5	13	14	8	12	2	12	35	5	26	M4 x 0.7 depth 7	5	6
25	Up to 300	301 to 400	22	19.5	17	16.5	10	14	2	12	40	6	31	M5 x 0.8 depth 7.5	5.5	8
32	Up to 300	301 to 450	22	19.5	17	20	12	18	2	12	40	6	38	M5 x 0.8 depth 8	5.5	10
40	Up to 300	301 to 800	30	27	19	26	16	25	2	13	50	8	47	M6 x 1 depth 12	6	14
50	Up to 300	301 to 1200	35	32	27	32	20	30	2	14	58	11	58	M8 x 1.25 depth 16	7	18
63	Up to 300	301 to 1200	35	32	27	38	20	32	2	14	58	11	72	M10 x 1.5 depth 16	7	18
80	Up to 300	301 to 1400	40	37	32	50	25	40	3	20	71	13	89	M10 x 1.5 depth 22	10	22
100	Up to 300	301 to 1500	40	37	41	60	30	50	3	20	71	16	110	M12 x 1.75 depth 22	10	26

Bore size (mm)	MM	NA	P	S	TA	TC**	ZZ	WA	WH	Wθ
20	M8 x 1.25	24	M5 x 0.8	77	11	M5 x 0.8	147	16	23	30°
25	M10 x 1.25	29	M5 x 0.8	77	11	M6 x 0.75	157	16	25	30°
32	M10 x 1.25	35.5	Rc 1/8	79	11	M8 x 1.0	159	16	28.5	25°
40	M14 x 1.5	44	Rc 1/8	87	12	M10 x 1.25	187	16	33	20°
50	M18 x 1.5	55	Rc 1/4	102	13	M12 x 1.25	218	18	40.5	20°
63	M18 x 1.5	69	Rc 1/4	102	13	M14 x 1.5	218	18	47.5	20°
80	M22 x 1.5	80	Rc 3/8	122	—	—	264	22	60.5	20°
100	M26 x 1.5	100	Rc 1/2	122	—	—	264	22	71	20°

* For mounting brackets, refer to page 328.
** Trunnion mounting taps with width across flats NA are not attached for bore sizes ø80 and ø100.

- CJ1**
- CJP**
- CJ2**
-Z
- CJ2**
- CM2**
-Z
- CM2**
- CM3**
- CG1**
-Z
- CG1**
- CG3**
- MB**
-Z
- MB**
- MB1**
- CA2**
-Z
- CA2**
- CS1**
- CS2**

- D-□**
- X□**
- Technical data

Series CG1W

With Mounting Bracket

Axial foot style: CG1WL□

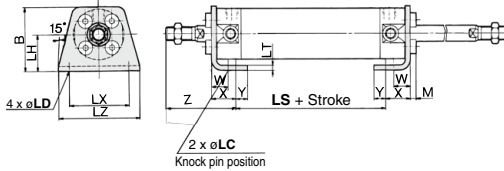

Foot Style

(mm)

Bore size (mm)	Stroke range (mm)	B	LC	LD	LH	LS	LT	LX	LZ	M	W	X	Y	Z
20	Up to 350	34	4	6	20	53	3	32	44	3	10	15	7	47
25	Up to 400	38.5	4	6	22	53	3	36	49	3.5	10	15	7	52
32	Up to 450	45	4	7	25	53	3	44	58	3.5	10	16	8	53
40	Up to 800	54.5	4	7	30	60	3	54	71	4	10	16.5	8.5	63.5
50	Up to 1200	70.5	5	10	40	67	4.5	66	86	5	17.5	22	11	75.5
63	Up to 1200	82.5	5	12	45	67	4.5	82	106	5	17.5	22	13	75.5
80	Up to 1400	101	6	11	55	74	4.5	100	125	5	20	28.5	14	95
100	Up to 1500	121	6	14	65	74	6	120	150	7	20	30	16	95

* Other dimensions are the same as basic style.

Flange style: CG1WF□

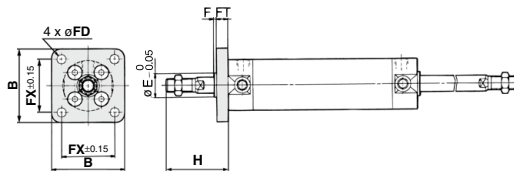

Flange Style

(mm)

Bore size (mm)	Stroke range (mm)	B	E	F	FX	FD	FT	H
20	Up to 350	40	12	2	28	5.5	6	35
25	Up to 400	44	14	2	32	5.5	7	40
32	Up to 450	53	18	2	38	6.6	7	40
40	Up to 800	61	25	2	46	6.6	8	50
50	Up to 1200	76	30	2	58	9	9	58
63	Up to 1200	92	32	2	70	11	9	58
80	Up to 1400	104	40	3	82	11	11	71
100	Up to 1500	128	50	3	100	14	14	71

* End boss is machined on the flange for øE.

* Other dimensions are the same as basic style.

Trunnion style: CG1WU□

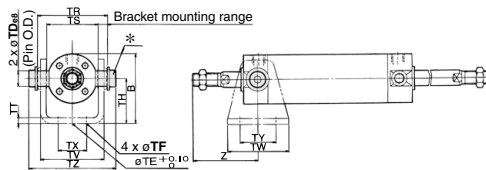

Trunnion Style

(mm)

Bore size (mm)	Stroke range (mm)	B	TDe8	TE	TF	TH	TR	TS
20	Up to 200	38	8 ^{+0.025} _{-0.047}	10	5.5	25	39	28
25	Up to 300	45.5	10 ^{+0.025} _{-0.047}	10	5.5	30	43	33
32	Up to 300	54	12 ^{+0.032} _{-0.059}	10	6.6	35	54.5	40
40	Up to 500	63.5	14 ^{+0.032} _{-0.059}	10	6.6	40	65.5	49
50	Up to 600	79	16 ^{+0.032} _{-0.059}	20	9	50	80	60
63	Up to 600	96	18 ^{+0.032} _{-0.059}	20	11	60	98	74

(mm)

Bore size (mm)	Z						
	TT	TV	TW	TX	TY	TZ	Without rod boot
20	3.2	(35.8)	42	16	28	47.6	46
25	3.2	(39.8)	42	20	28	53	51
32	4.5	(49.4)	48	22	28	67.7	51
40	4.5	(58.4)	56	30	30	78.7	62
50	6	(72.4)	64	36	36	98.6	71
63	8	(90.4)	74	46	46	119.2	71

* Consists of pin, flat washer and hexagon socket head cap bolt.

* Other dimensions are the same as basic style.

Air Cylinder: Standard Type Single Acting, Spring Return/Extend

Series CG1

ø20, ø25, ø32, ø40

How to Order

CG1 L N 25 - 100 S - []

With auto switch **CDG1 L N 25 - 100 S - M9BW [] - C - []**

Mounting style

B	Basic style	U	Rod side trunnion style
L	Axial foot style	T	Head side trunnion style
F	Rod side flange style	D	Clevis style
G	Head side flange style		

Note) Mounting brackets are shipped together, (but not assembled).

Type

N	Rubber bumper
----------	---------------

Number of auto switches

Nil	2 pcs.
S	1 pc.
n	"n" pcs.

Auto switch

Nil	Without auto switch
------------	---------------------

* For the applicable auto switch model, refer to the table below.

Action

S	Single acting, Spring return
T	Single acting, Spring extend

Auto switch mounting bracket ^{Note)}

Note) This symbol is indicated when the D-A9□ or M9□ type auto switch is specified. This mounting bracket does not apply to other auto switches (D-C7□ and H7□, etc.) (Nil)

Cylinder stroke (mm)
Refer to "Standard Stroke" on page 330.

Bore size

20	20 mm
25	25 mm
32	32 mm
40	40 mm

Built-in Magnet Cylinder Model

If a built-in magnet cylinder without an auto switch is required, there is no need to enter the symbol for the auto switch.
(Example) CDG1FN32-100T

Made to Order
Refer to page 330 for details.

Applicable Auto Switches

Refer to pages 1559 to 1673 for further information on auto switches.

Type	Special function	Electrical entry	Indicator light	Wiring (Output)	Load voltage		Auto switch model		Lead wire length (m)					Pre-wired connector	Applicable load				
					DC	AC	Applicable bore size		0.5 (Nil)	1 (M)	3 (L)	5 (Z)	None (N)						
							Perpendicular	In-line											
Solid state auto switch	—	Grommet	Yes	3-wire (NPN)	5 V, 12 V	—	M9NV	M9N	●	●	○	—	—	—	IC circuit				
				3-wire (PNP)			M9PV	M9P	●	●	○	—	—						
	Diagnostic indication (2-color indication)	Connector	Yes	2-wire	12 V	—	M9BV	M9B	●	●	○	—	—	—	—				
				—	—	H7C	●	●	○	●	●	—							
	Water resistant (2-color indication)	Grommet	Yes	3-wire (NPN)	5 V, 12 V	—	M9N WV	M9N W	●	●	○	—	—	—	IC circuit				
				3-wire (PNP)			M9P WV	M9P W	●	●	○	—	—						
	Diagnostic output (2-color indication)	Connector	Yes	2-wire	12 V	—	M9B WV	M9B W	●	●	○	—	—	—	—				
				3-wire (NPN)	5 V, 12 V	M9NA V**	M9NA**	○	○	○	—	—	—	IC circuit					
	—	Grommet	None	2-wire	5 V, 12 V	—	M9PA V**	M9PA**	○	○	○	○	—		—	IC circuit			
							2-wire	12 V	M9BA V**	M9BA**	○	○	○	—	—				
Reed auto switch	—	Grommet	Yes	3-wire (Equiv. to NPN)	5 V	—	A96V	A96	●	●	—	—	—	—	IC circuit				
				None			24 V	12 V	100 V	A93V	A93	●	—	●		●	—	—	—
									100 V or less	A90V	A90	●	—	●		●	—	—	
				Yes			None	2-wire	100 V, 200 V	—	B54	●	—	●		●	—	—	—
									200 V or less	—	B64	●	—	●		●	—	—	
				None			Connector	Yes	—	—	—	C73C	●	—		●	●	—	—
24 V or less	—	C80C	●		—	●			●	—	—	IC circuit							
Diagnostic indication (2-color indication)	Grommet	Yes	—	—	—	B59W	●	—	●	—	—		—	—					
			—	—	—	—	—	—	—	—	—	—	—						

** Water resistant type auto switches can be mounted on the above models, but in such case SMC cannot guarantee water resistance. Consult with SMC regarding water resistant types with the above model numbers.

* Lead wire length symbols: 0.5 m Nil (Example) M9NW * Solid state auto switches marked with "○" are produced upon receipt of order.

1 m M (Example) M9NW
3 m L (Example) M9NW
5 m Z (Example) M9NW
None N (Example) H7CN

* Since there are other applicable auto switches than listed, refer to page 368 for details.

* For details about auto switches with pre-wired connector, refer to pages 1626 and 1627.

* D-A9□/M9□□□ auto switches are shipped together (not assembled). (Only auto switch mounting brackets are assembled before shipped.)

CG1

CG2

CG2-Z

CG2

CG2-Z

CG2

CG3

CG1-Z

CG1

CG3

MB-Z

MB

MB1

CA2-Z

CA2

CA2

CS1

CS2

Relay, PLC

Relay, PLC

Relay, PLC

IC circuit

IC circuit

IC circuit

IC circuit

IC circuit

IC circuit

D-□

-X□

Technical data

Series CG1



Spring return



Spring extend

Symbol

Spring return rubber bumper

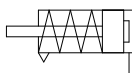

Spring extend rubber bumper

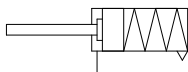

Made to Order Specifications
(For details, refer to pages 1699 to 1818.)

Symbol	Specifications
-XC6	Piston rod and rod end nut made of stainless steel
-XC20	Head cover axial port

Refer to pages 363 to 368 for cylinders with auto switches.

- Minimum auto switch mounting stroke
- Proper auto switch mounting position (detection at stroke end) and mounting height
- Operating range
- Switch mounting bracket: Part no.

⚠ Precautions

Be sure to read before handling.
Refer to front matter 57 for Safety Instructions and pages 3 to 12 for Actuator and Auto Switch Precautions.

Specifications

Bore size (mm)	20	25	32	40	20	25	32	40
Action	Single acting, Spring return				Single acting, Spring extend			
Lubricant	Not required (Non-lube)							
Fluid	Air							
Proof pressure	1.5 MPa							
Maximum operating pressure	1.0 MPa							
Minimum operating pressure	0.18 MPa				0.23 MPa			
Ambient and fluid temperature	Without auto switch: -10 to 70°C (No freezing)							
	With auto switch: -10 to 60°C (No freezing)							
Piston speed	50 to 1000 mm/s							
Stroke length tolerance	Up to 200 ^{±0.14} mm							
Cushion	Rubber bumper							
Mounting	Basic style, Axial foot style, Rod side flange style, Head side flange style, Rod side trunnion style, Head side trunnion style, Clevis style (Used for changing the port location by 90°.)							

Accessory

Mounting		Basic style	Axial foot style	Rod side flange style	Head side flange style	Rod side trunnion style	Head side trunnion style	Clevis style
Standard equipment	Rod end nut	●	●	●	●	●	●	●
	Clevis pin	—	—	—	—	—	—	●
Option	Single knuckle joint	●	●	●	●	●	●	●
	Double knuckle joint* (With pin)	●	●	●	●	●	●	●
	Pivot bracket	—	—	—	—	●	●	●

* Pin and retaining ring are shipped together with double knuckle joint.

Standard Stroke

Bore size (mm)	Standard stroke (mm) ⁽¹⁾
20	25,50,75,100,125
25, 32, 40	25,50,75,100,125,150,200

Note 1) Manufacture of intermediate strokes at 1 mm intervals is possible. (Spacers are not used.)

Theoretical Output

Refer to page 1826 (Theoretical Output Table 2).

Spring Reaction Force

Refer to page 1822 (Table (3) Spring Reaction Force).

Mounting Bracket Part No.

Mounting bracket	Min. order	Bore size (mm)				Description
		20	25	32	40	
Axial foot	^{Note) 2}	CG-L020	CG-L025	CG-L032	CG-L040	Foot x 2, Mounting bolt x 8
Flange	1	CG-F020	CG-F025	CG-F032	CG-F040	Flange x 1, Mounting bolt x 4
Trunnion pin	1	CG-T020	CG-T025	CG-T032	CG-T040	Trunnion pin x 2, Trunnion bolt x 2, Flat washer x 2
Clevis	1	CG-D020	CG-D025	CG-D032	CG-D040	Clevis x 1, Mounting bolt x 4, Clevis pin x 1, Retaining ring x 2
Pivot bracket	1	CG-020-24A	CG-025-24A	CG-032-24A	CG-040-24A	Pivot bracket x 1

Note) Order two foot brackets per cylinder.

Air Cylinder: Standard Type Single Acting, Spring Return/Extend **Series CG1**

Weight

Spring return					
Bore size (mm)		20	25	32	40
Basic weight	25 stroke	0.17	0.27	0.40	0.63
	50 stroke	0.19	0.30	0.45	0.71
	75 stroke	0.26	0.40	0.58	0.91
	100 stroke	0.28	0.43	0.62	0.99
	125 stroke	0.35	0.53	0.76	1.20
	150 stroke	—	0.56	0.81	1.28
Mounting bracket weight	200 stroke	—	0.69	0.98	1.56
	Axial foot style	0.11	0.13	0.16	0.22
	Flange style	0.08	0.10	0.14	0.20
	Trunnion style	0.01	0.02	0.03	0.05
Accessory bracket	Clevis style	0.05	0.08	0.15	0.23
	Pivot bracket	0.08	0.09	0.17	0.25
	Single knuckle joint	0.05	0.09	0.09	0.10
	Double knuckle (With pin)	0.05	0.09	0.09	0.13

Calculation: (Example) **CG1LN20-100S** (Foot style, ø20, 100 st)
 • Basic weight:~0.28 kg (ø20) • Mounting bracket weight:~0.11 kg (Foot)
 0.28 + 0.11 = 0.39 kg

Spring extend					
Bore size (mm)		20	25	32	40
Basic weight	25 stroke	0.16	0.25	0.38	0.59
	50 stroke	0.18	0.28	0.43	0.67
	75 stroke	0.24	0.37	0.54	0.83
	100 stroke	0.26	0.40	0.58	0.91
	125 stroke	0.32	0.48	0.69	1.08
	150 stroke	—	0.50	0.72	1.12
Mounting bracket weight	200 stroke	—	0.63	0.89	1.40
	Axial foot style	0.11	0.13	0.16	0.22
	Flange style	0.08	0.10	0.14	0.20
	Trunnion style	0.01	0.02	0.03	0.05
Accessory bracket	Clevis style	0.05	0.08	0.15	0.23
	Pivot bracket	0.08	0.09	0.17	0.25
	Single knuckle joint	0.05	0.09	0.09	0.10
	Double knuckle (With pin)	0.05	0.09	0.09	0.13

Calculation: (Example) **CG1LN20-100T** (Foot style, ø20, 100 st)
 • Basic weight:~0.26 kg (ø20) • Mounting bracket weight:~0.11 kg (Foot)
 0.26 + 0.11 = 0.37 kg

Construction

Single acting, Spring return

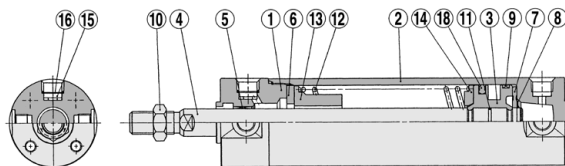

Single acting, Spring extend

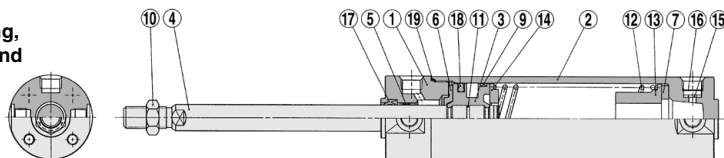

Component Parts

No.	Description	Material	Note
1	Rod cover	Aluminum alloy	Clear hard anodized
2	Tube cover	Aluminum alloy	Clear hard anodized
3	Piston	Aluminum alloy	Chromated
4	Piston rod	Carbon steel [*]	Hard chrome plated [*]
5	Bushing	Bearing alloy	
6	Bumper A	Urethane	
7	Bumper B	Urethane	
8	Retaining ring	Stainless steel	
9	Wear ring	Resin	Zinc chromated
10	Rod end nut	Rolled steel	
11	Piston gasket	NBR	Zinc chromated
12	Return spring	Steel wire	Chromated
13	Spring guide	Aluminum alloy	Chromated
14	Spring seat	Aluminum alloy	
15	Element	Oil-impregnated sintered alloy	
16	Retaining ring	Copper wire	
17	Rod seal	NBR	
18	Piston seal	NBR	
19	Tube gasket	NBR	

Note) In the case of cylinders with auto switches, rubber magnets are installed in the piston.

* The material is stainless steel on auto switch equipped styles ø20 and ø25.

Replacement Parts/Seal

• For single acting, spring return

No.	Description	Material	Part no.			
			20	25	32	40
18	Piston seal	NBR	KB01599	KB01601	KB01602	KB01603

* Since the seal kit does not include a grease pack, order it separately.
Grease pack part no.: GR-S-010 (10 g)

• For single acting, spring extend

Replacement parts/Seal kits are the same as standard type, double acting, single rod (with rubber bumper). Refer to page 311.

Note) Refer to the Specific Product Precautions on page 310 for Disassembly/Replacement.

CG1

CJP

CJ2-Z

CJ2

CM2-Z

CM2

CM3

CG1-Z

CG1

CG3

MB-Z

MB

MB1

CA2-Z

CA2

CA2

CS1

CS2

CS2

CS2

CS2

CS2

CS2

CS2

CS2

CS2

CS2

CS2

CS2

CS2

CS2

CS2

CS2

CS2

Series CG1

Basic Style

Spring return: CG1BN

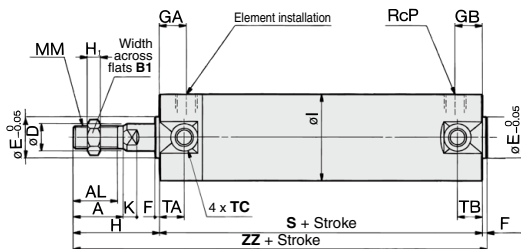
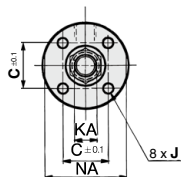

Spring extend: CG1BN

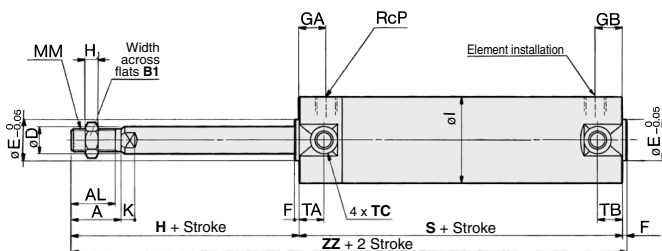
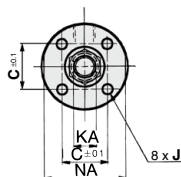

(mm)

Bore size (mm)	Stroke range (mm)	A	AL	B ₁	C	D	E	F	GA	GB	H	H ₁	I	J	K	KA	MM	NA	P
20	Up to 125	18	15.5	13	14	8	12	2	12	10	35	5	26	M4 x 0.7 depth 7	5	6	M8 x 1.25	24	1/8
25	Up to 200	22	19.5	17	16.5	10	14	2	12	10	40	6	31	M5 x 0.8 depth 7.5	5.5	8	M10 x 1.25	29	1/8
32	Up to 200	22	19.5	17	20	12	18	2	12	10	40	6	38	M5 x 0.8 depth 8	5.5	10	M10 x 1.25	35.5	1/8
40	Up to 200	30	27	19	26	16	25	2	13	10	50	8	47	M6 x 1 depth 12	6	14	M14 x 1.5	44	1/8

Bore size (mm)	TA	TB	TC	1 to 50st		51 to 100st		101 to 125st		126 to 200st	
				S	ZZ	S	ZZ	S	ZZ	S	ZZ
20	11	11	M5 x 0.8	94	131	119	156	144	181	—	—
25	11	11	M6 x 0.75	94	136	119	161	144	186	169	211
32	11	10	M8 x 1.0	96	138	121	163	146	188	171	213
40	12	10	M10 x 1.25	103	155	128	180	153	205	178	230

With Mounting Bracket (Note) The drawing below shows the single acting/spring return style. The rod is in retracted state for spring extend type.)

Axial foot style: CG1LN

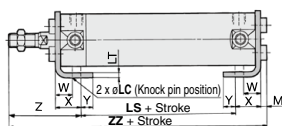
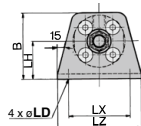

Axial Foot Style

(mm)

Bore size (mm)	Stroke range (mm)	B	M	LC	LD	LH	LT	LX	LZ	W	X	Y	Z
20	Up to 125	34	3	4	6	20	3	32	44	10	15	7	47
25	Up to 200	38.5	3.5	4	6	22	3	36	49	10	15	7	52
32	Up to 200	45	3.5	4	7	25	3	44	58	10	16	8	53
40	Up to 200	54.5	4	4	7	30	3	54	71	10	16.5	8.5	63.5

Bore size (mm)	1 to 50st	51 to 100st	101 to 125st	126 to 200st	ZZ	
					LS	ZZ
20	70	135	95	160	120	185
25	70	140.5	95	165.5	120	190.5
32	70	142.5	95	167.5	120	192.5
40	76	160	101	185	126	210

* Other dimensions are the same as basic style.

Air Cylinder: Standard Type Single Acting, Spring Return/Extend **Series CG1**

With Mounting Bracket

Rod side flange style: CG1FN

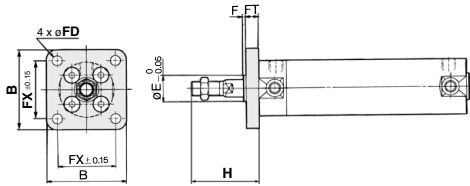

Head side flange style: CG1GN

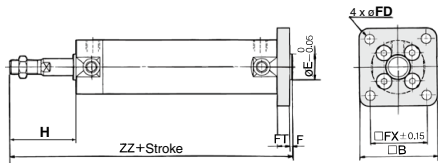

Rod side trunnion style: CG1UN

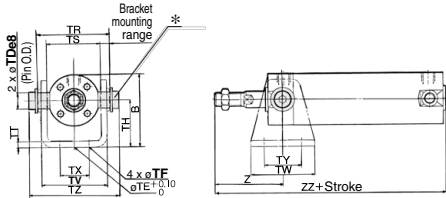

Head side trunnion style: CG1TN

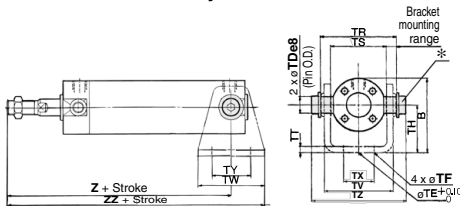

Clevis style: CG1DN

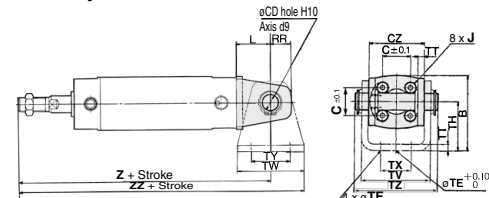

(The above shows the case port location is changed by 90°.)

Bore size (mm)	Stroke range (mm)	B	E	F	FX	FD	FT	H
20	Up to 125	40	12	2	28	5.5	6	35
25	Up to 200	44	14	2	32	5.5	7	40
32	Up to 200	53	18	2	38	6.6	7	40
40	Up to 200	61	25	2	46	6.6	8	50

* End boss is machined on the flange for ϕE .
* Other dimensions are the same as basic style.

Rod Side Flange Style (mm)

Bore size (mm)	ZZ			
	1 to 50st	51 to 100st	101 to 125st	126 to 200st
20	131	156	181	—
25	136	161	186	211
32	138	163	188	213
40	155	180	205	230

Head Side Flange Style (mm)

Bore size (mm)	ZZ			
	1 to 50st	51 to 100st	101 to 125st	126 to 200st
20	137	162	187	—
25	143	168	193	218
32	145	170	195	220
40	163	188	213	238

Bore size (mm)	Stroke range (mm)	B	TD $\phi 8$	TE	TF	TH	TR	TS	TT	TW	TX	TY	TZ
25	Up to 200	45.5	10	5.5	30	43	33	3.2	(39.8)	42	20	28	53
32	Up to 200	54	12	6.6	35	54.5	40	4.5	(49.4)	48	22	28	67.7
40	Up to 200	63.5	14	6.6	40	65.5	49	4.5	(58.4)	56	30	30	78.7

Rod Side Trunnion Style (mm)

Bore size (mm)	Z	ZZ			
		1 to 50st	51 to 100st	101 to 125st	126 to 200st
20	46	131	156	181	—
25	51	136	161	186	211
32	51	138	163	188	213
40	62	155	180	205	230

* Consists of pin, flat washer and hexagon socket head cap bolt.
* Other dimensions are the same as basic style.

Head Side Trunnion Style (mm)

Bore size (mm)	Z				ZZ			
	1 to 50st	51 to 100st	101 to 125st	126 to 200st	Z	ZZ	Z	ZZ
20	118	139	143	164	168	189	—	—
25	123	144	148	169	173	194	198	219
32	126	150	151	175	176	200	201	225
40	143	171	168	196	193	221	218	246

* Consists of pin, flat washer and hexagon socket head cap bolt.
* Other dimensions are the same as basic style.

Clevis Style (mm)

Bore size (mm)	Stroke range (mm)	B	CD	CZ	L	RR	TE	TF	TH	TT	TV
25	Up to 200	45.5	10	33	16	13	10	5.5	30	3.2	(39.8)
32	Up to 200	54	12	40	20	15	10	6.6	35	4.5	(49.4)
40	Up to 200	63.5	14	49	22	18	10	6.6	40	4.5	(58.4)

Bore size (mm)	TW	TX	TY	TZ	1 to 50st		51 to 100st		101 to 125st		126 to 200st	
					Z	ZZ	Z	ZZ	Z	ZZ	Z	ZZ
20	42	16	28	43.4	143	164	168	189	193	214	—	—
25	42	20	28	48	150	171	175	196	200	221	225	246
32	48	22	28	59.4	156	180	181	205	206	230	231	255
40	56	30	30	71.4	175	200	200	228	225	253	250	278

* For dimensions of pivot bracket, refer to page 321.
* Other dimensions are the same as basic style.

CG1

CGP

CG2-Z

CG2

CM2-Z

CM2

CM3

CG1-Z

CG1

CG3

MB-Z

MB

MB1

CA2-Z

CA2

CS1

CS2

D-□

-X□

Technical data

Air Cylinder: Non-rotating Rod Type Double Acting

Series CG1K

ø20, ø25, ø32, ø40, ø50, ø63

How to Order

CG1K L N 25 - 100 -

With auto switch **CDG1K L N 25 - 100 - M9BW - C -**

With auto switch
(Built-in magnet)

Double acting: non-rotating rod type

Mounting style

B	Basic style
L	Axial foot style
F	Rod side flange style
G	Head side flange style
U	Rod side trunnion style
T	Head side trunnion style
D	Clevis style

Type

N	Rubber bumper
A	Air cushion (ø40 to ø63 only)

Bore size

20	20 mm
25	25 mm
32	32 mm
40	40 mm
50	50 mm
63	63 mm

Number of auto switches

Nil	2 pcs.
S	1 pc.
n	"n" pcs.

Auto switch

Nil	Without auto switch
-----	---------------------

* For the applicable auto switch model, refer to the table below.

Auto switch mounting bracket ^(Note)

(Note) This symbol is indicated when the D-A9□ or M9□ type auto switch is specified. This mounting bracket does not apply to other auto switches (D-C7□ and H7□, etc.) (Nil)

Made to Order

Refer to page 335 for details.

Cylinder stroke (mm)
Refer to "Standard Stroke" on page 335.

(Note) Mounting brackets are shipped together, (but not assembled).

Built-in Magnet Cylinder Model

If a built-in magnet cylinder without an auto switch is required, there is no need to enter the symbol for the auto switch.
(Example) CDG1KFA32-100

Applicable Auto Switches

Refer to pages 1559 to 1673 for further information on auto switches.

Type	Special function	Electrical entry	Indicator light	Wiring (Output)	Load voltage		Auto switch model		Lead wire length (m)					Pre-wired connector	Applicable load					
					DC	AC	Applicable bore size		0.5 (Nil)	1 (M)	3 (L)	5 (Z)	None (N)		IC circuit	Relay, PLC				
							ø20 to ø63	Perpendicular									In-line			
Solid state auto switch	—	Grommet	Yes	3-wire (NPN)	5 V, 12 V	—	M9NV	M9N	●	●	○	—	—	—	—	IC circuit				
				3-wire (PNP)			M9PV	M9P	●	●	○	—	—	—						
	Diagnostic indication (2-color indication)	Connector	Yes	2-wire	12 V	—	M9BV	M9B	●	●	○	—	—	—	—	—				
				—			H7C	●	—	●	—	—	—							
	Water resistant (2-color indication)	Grommet	Yes	3-wire (NPN)	5 V, 12 V	—	M9NVW	M9NW	●	●	○	—	—	—	—	IC circuit				
				3-wire (PNP)			M9PVW	M9PW	●	●	○	—	—	—						
	Diagnostic output (2-color indication)	Grommet	Yes	2-wire	12 V	—	M9BWW	M9BW	●	●	○	—	—	—	—	—				
				3-wire (NPN)			M9NAV**	M9NA**	○	○	○	—	—	—						
	—	Grommet	Yes	3-wire (PNP)	5 V, 12 V	—	M9PAV**	M9PA**	○	○	○	—	—	—	—	IC circuit				
				2-wire			M9BAV**	M9BA**	○	○	○	—	—	—						
Reed auto switch	—	Grommet	Yes	4-wire (NPN)	5 V, 12 V	—	H7FN	—	●	—	○	—	—	—	—	IC circuit				
				3-wire (Equiv. to NPN)			A96V	A96	●	—	●	—	—	—						
				None			Yes	24 V	12 V	100 V	A93V	A93	●	—	●		—	—	—	—
										100 V or less	A90V	A90	●	—	●		—	—	—	
				None			Yes	24 V	12 V	100 V, 200 V	—	B54	●	—	●		—	—	—	—
										200 V or less	—	B64	●	—	●		—	—	—	
				None			Yes	24 V	12 V	—	—	C73C	●	—	●		—	—	—	—
24 V or less	—	C80C	●		—	●				—	—	—								
Diagnostic indication (2-color indicator)	Grommet	Yes	—	—	—	B59W	●	—	●	—	—	—	—							

** Water resistant type auto switches can be mounted on the above models, but in such case SMC cannot guarantee water resistance. Consult with SMC regarding water resistant types with the above model numbers.

* Lead wire length symbols: 0.5 m Nil (Example) M9NW
1 m M (Example) M9MWW
3 m L (Example) M9NWL
5 m Z (Example) M9NWX
None N (Example) H7CN

* Solid state auto switches marked with "○" are produced upon receipt of order.

* Since there are other applicable auto switches than listed, refer to page 368 for details.

* For details about auto switches with pre-wired connector, refer to pages 1626 and 1627.

* D-A9□/M9□□ auto switches are shipped together (not assembled). (Only auto switch mounting brackets are assembled before shipped.)

Air Cylinder: Non-rotating Rod Type Double Acting *Series CG1K*



Symbol

Rubber bumper

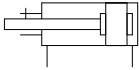

Air cushion

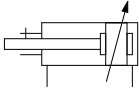

Made to Order Specifications
(For details, refer to pages 1675 to 1818.)

Symbol	Specifications
-XA□	Change of rod end shape
-XC8	Adjustable stroke cylinder/Adjustable extension type*1
-XC9	Adjustable stroke cylinder/Adjustable retraction type*1
-XC10	Dual stroke cylinder/Double rod type*1
-XC11	Dual stroke cylinder/Single rod type*1
-XC12	Tandem type cylinder*1
-XC13	Auto switch rail mounting style*1
-XC20	Head cover axial port*1

*1 Compatible with cylinders with a rubber bumper only.

Refer to pages 363 to 368 for cylinders with auto switches.

- Minimum auto switch mounting stroke
- Proper auto switch mounting position (detection at stroke end) and mounting height
- Operating range
- Switch mounting bracket: Part no.

Specifications

Bore size (mm)	20	25	32	40	50	63
Action	Double acting, Single rod					
Lubricaut	Not required (Non-lube)					
Fluid	Air					
Proof pressure	1.5 MPa					
Maximum operating pressure	1.0 MPa					
Minimum operating pressure	0.05 MPa					
Ambient and fluid temperature	Without auto switch: -10 to 70°C (No freezing)					
	With auto switch: -10 to 60°C (No freezing)					
Piston speed	50 to 500 mm/s					
Stroke length tolerance	Up to 600 ^{±0.1, 0.4} mm					
Cushion	Rubber bumper, Air cushion (ø40 to ø63 only)					
Rod non-rotating accuracy	±1°		±0.8°		±0.5°	
Mounting	Basic style, Axial foot style, Rod side flange style, Head side flange style, Rod side trunnion style, Head side trunnion style, Clevis style (Used for changing the port location by 90°.)					

Accessory

Mounting		Basic style	Axial foot style	Rod side flange style	Head side flange style	Rod side trunnion style	Head side trunnion style	Clevis style
Standard equipment	Rod end nut	●	●	●	●	●	●	●
	Clevis pin	—	—	—	—	—	—	●
Option	Single knuckle joint	●	●	●	●	●	●	●
	Double knuckle joint * (With pin)	●	●	●	●	●	●	●
	Pivot bracket	—	—	—	—	●	●	●

* Pin and retaining ring are shipped together with double knuckle joint.

Standard Stroke

Bore size (mm)	Standard stroke (mm) ⁽¹⁾	Long stroke (mm)
20	25, 50, 75, 100, 125, 150, 200	—
25	25, 50, 75, 100, 125, 150, 200, 250, 300	—
32		—
40		301 to 500
50, 63		301 to 600

Note 1) Manufacture of intermediate strokes at 1 mm intervals is possible. (Spacers are not used.)

Note 2) The maximum limit is 1500 stroke, but the products that exceed the standard or the long stroke limit are not guaranteed.

CG1

CGP

CJ2
-Z

CG2

CM2
-Z

CM2

CM3

CG1
-Z

CG1

CG3

MB
-Z

MB

MB1

CA2
-Z

CA2

CS1

CS2

D-□

-X□

Technical data

Series CG1K

Weight

(kg)

Bore size (mm)		20	25	32	40	50	63
Basic weight	Basic style	0.10	0.17	0.26	0.41	0.77	1.07
	Axial foot style	0.21	0.30	0.42	0.63	1.25	1.79
	Flange style	0.18	0.27	0.40	0.61	1.11	1.57
	Trunnion style	0.11	0.19	0.29	0.46	0.91	1.21
	Clevis style	0.15	0.25	0.41	0.64	1.17	1.75
Pivot bracket		0.08	0.09	0.17	0.25	0.44	0.80
Single knuckle joint		0.05	0.09	0.09	0.10	0.22	0.22
Double knuckle joint (With pin)		0.05	0.09	0.09	0.13	0.26	0.26
Additional weight per each 50 mm of stroke		0.05	0.07	0.09	0.15	0.22	0.26
Additional weight with air cushion		—	—	—	0.02	0.03	0.03
Additional weight for long stroke		—	—	—	0.03	0.06	0.10

Calculation: (Example) **CG1KLN20-100** • Basic weight.....0.21 (Foot, ø20)

(Foot style, ø20, 100 st) • Additional weight.....0.05/50 st

• Cylinder stroke.....100 st

0.21 + 0.05 x 100/50 = 0.31 kg

Mounting Bracket Part No.

Mounting bracket	Min. order	Bore size (mm)						Description
		20	25	32	40	50	63	
Axial foot	Note) 2	CG-L020	CG-L025	CG-L032	CG-L040	CG-L050	CG-L063	Foot x 2, Mounting bolt x 8
Flange	1	CG-F020	CG-F025	CG-F032	CG-F040	CG-F050	CG-F063	Flange x 1, Mounting bolt x 4
Trunnion pin	1	CG-T020	CG-T025	CG-T032	CG-T040	CG-T050	CG-T063	Trunnion pin x 2, Trunnion bolt x 2, Flat washer x 2
Clevis	1	CG-D020	CG-D025	CG-D032	CG-D040	CG-D050	CG-D063	Clevis x 1, Mounting bolt x 4, Clevis pin x 1, Retaining ring x 2
Pivot bracket	1	CG-020-24A	CG-025-24A	CG-032-24A	CG-040-24A	CG-050-24A	CG-063-24A	Pivot bracket x 1

Note) Order two foot brackets per cylinder.

Construction

With rubber bumper

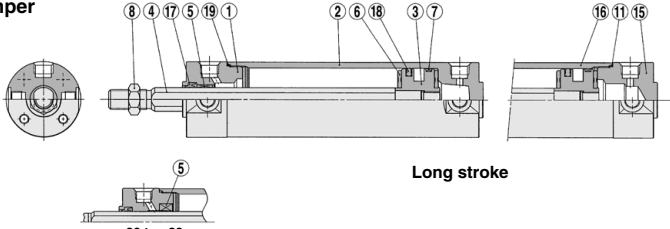

With air cushion

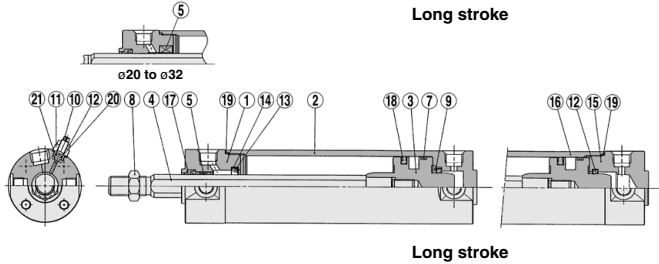

Component Parts

No.	Description	Material	Note
1	Rod cover	Aluminum alloy	Clear hard anodized
2	Tube cover	Aluminum alloy	Clear hard anodized
3	Piston	Aluminum alloy	Chromated, Hard anodized (In case of air cushion)
4	Piston rod	Carbon steel *	Hard chrome plated *
5	Non-rotating guide	Bearing alloy	
6	Bumper	Urethane	
7	Wear ring	Resin	
8	Rod end nut	Rolled steel	Zinc chromated
9	Seal retainer	Rolled steel	Nickel plated (Except long stroke)
10	Cushion valve	Rolled steel	Electroless nickel plated
11	Valve retainer	Rolled steel	Electroless nickel plated
12	Lock nut	Carbon steel	Nickel plated
13	Cushion seal	NBR	
14	Cushion seal holder	Aluminum alloy	
15	Head cover	Aluminum alloy	Clear hard anodized
16	Cylinder tube	Aluminum alloy	Hard anodized
17	Rod seal	NBR	
18	Piston seal	NBR	
19	Tube gasket	NBR	
20	Valve seal	NBR	
21	Valve retaining gasket	NBR	

Note) In the case of cylinders with auto switches, rubber magnets are installed in the piston.
* The material is stainless steel for $\phi 20$ to $\phi 32$.

Replacement Parts/Seal Kit

• For rubber bumper

Bore size (mm)	Kit no.	Contents
20	CG1N20-PS	Set of the nos. ①, ③, ⑨, ⑲
25	CG1N25-PS	
32	CG1N32-PS	
40	CG1N40-PS	

• For air cushion

Bore size (mm)	Kit no.	Contents
40	CG1KA40-PS	Set of the nos. ①, ③, ⑨, ⑲, ⑳, ㉑

Note) Refer to the Specific Product Precautions on page 310 for Disassembly/Replacement.
Order with a part number for each type and bore size.

* The seal kit includes a grease pack (10 g). Order with the following part number when only the grease pack is needed.

Grease pack part no.: GR-S-010 (10 g)

CJ1

CJP

CJ2
-Z

CJ2

CM2
-Z

CM2

CM3

CG1
-Z

CG1

CG3

MB
-Z

MB

MB1

CA2
-Z

CA2

CS1

CS2

D-□

-X□

Technical data

Series CG1K

Basic Style

With rubber bumper: CG1KBN

ø20 to ø63

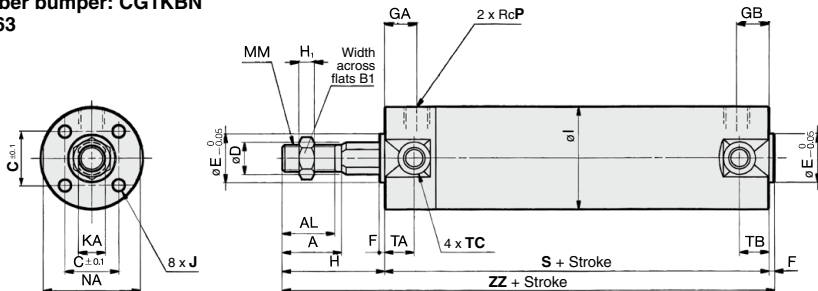

With air cushion: CG1KBA

ø40 to ø63

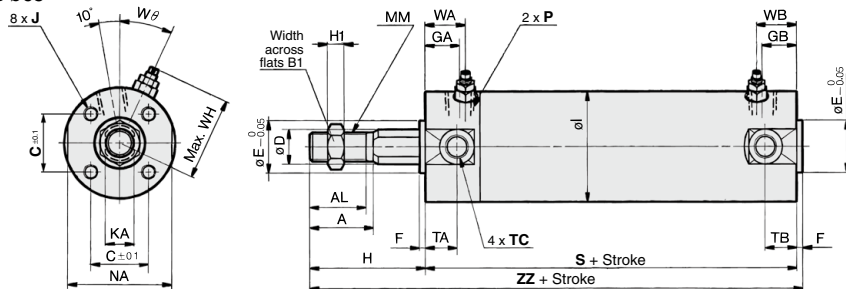

Bore size (mm)	Stroke range (mm)	A	AL	B1	C	D	E	F	GA	GB	H	H1	I	J	KA	MM	NA	P	S	TA	TB	TC	ZZ
20	Up to 200	18	15	13	14	9.2	12	2	12	10	35	5	26	M4 x 0.7 depth 7	8	M8 x 1.25	24	1/8	69	11	11	M5 x 0.8	106
25	Up to 300	22	19.5	17	16.5	11	14	2	12	10	40	6	31	M5 x 0.8 depth 7.5	10	M10 x 1.25	29	1/8	69	11	11	M6 x 0.75	111
32	Up to 300	22	19.5	17	20	12	18	2	12	10	40	6	38	M5 x 0.8 depth 8	10	M10 x 1.25	35.5	1/8	71	11	10	M8 x 1.0	113
40	Up to 300 (500)	30	27	19	26	16	25	2	13	10 (13)	50	8	47	M6 x 1 depth 12	14	M14 x 1.5	44	1/8	78 (87)	12	10 (12)	M10 x 1.25	130 (139)
50	Up to 300 (600)	35	32	27	32	20	30	2	14	12 (14)	58	11	58	M8 x 1.25 depth 16	18	M18 x 1.5	55	1/4	90 (102)	13	12 (13)	M12 x 1.25	150 (162)
63	Up to 300 (600)	35	32	27	38	20	32	2	14	12 (14)	58	11	72	M10 x 1.5 depth 16	18	M18 x 1.5	69	1/4	90 (102)	13	12 (13)	M14 x 1.5	150 (162)

Note 1) Dimensions for each mounting bracket are the same as those for CG1 standard or long stroke model. Refer to pages 313 to 318.

Note 2) () : Denotes the dimensions for long stroke.

With Air Cushion

Bore size (mm)	P	WA	WB	WH	Wθ
40	Rc 1/8	16	15 (16)	33	20°
50	Rc 1/4	18	17 (18)	40.5	20°
63	Rc 1/4	18	17 (18)	47.5	20°

Note) () : Denotes the dimensions for long stroke.

⚠ Precautions

Be sure to read before handling.

Refer to front matter 57 for Safety Instructions and pages 3 to 12 for Actuator and Auto Switch Precautions.

Caution on Handling/Disassembly

⚠ Caution

1. Avoid using the air cylinder in such a way that rotational torque would be applied to the piston rod.

- If rotational torque is applied, the non-rotating guide will become deformed, thus affecting the non-rotating accuracy. Refer to the table below for the approximate values of the allowable range of rotational torque.

Allowable rotational torque (N·m or less)	ø20	ø25, ø32	ø40, ø50, ø63
	0.2	0.25	0.44

- To screw a bracket or a nut onto the piston rod, make sure to retract the piston rod entirely, and place a wrench over the flat portion of the rod that protrudes.

Tighten it by giving consideration to prevent the tightening torque from being applied to the non-rotating guide.

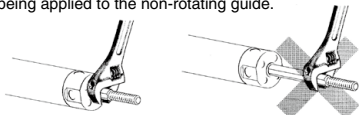

2. When replacing rod seals, please contact SMC.

Air leakage may be happened, depending on the position in which a rod seal is fitted. Thus, please contact SMC when replacing them.

Air Cylinder: Non-rotating Rod Type Double Acting, Double Rod

Series CG1KW

ø20, ø25, ø32, ø40, ø50, ø63

How to Order

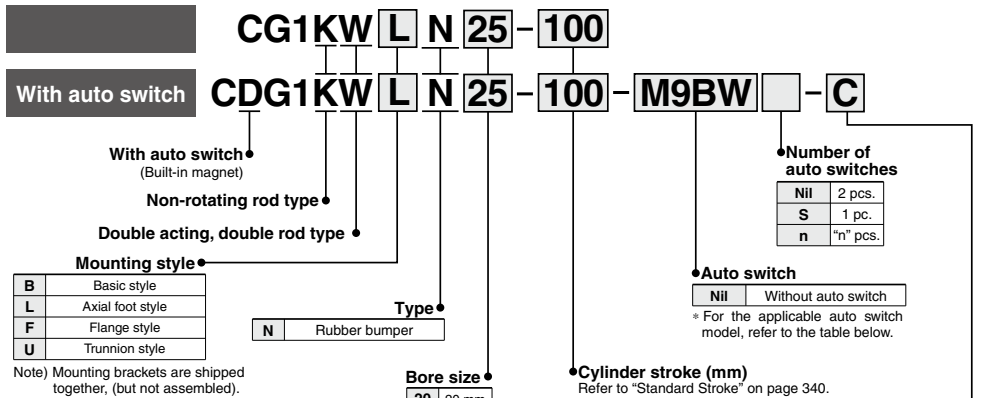

Built-in Magnet Cylinder Model

If a built-in magnet cylinder without an auto switch is required, there is no need to enter the symbol for the auto switch.
(Example) CDG1KWFN32-100

Auto switch mounting bracket ^{Note)}

Note) This symbol is indicated when the D-A9□ or M9□ type auto switch is specified. This mounting bracket does not apply to other auto switches (D-C7□ and H7□, etc.) (Nil)

Applicable Auto Switches/Refer to page 1559 to 1673 for further information on auto switches.

Type	Special function	Electrical entry	Indicator light	Wiring (Output)	Load voltage		Auto switch model		Lead wire length (m)					Pre-wired connector	Applicable load		
					DC	AC	Applicable bore size ø20 to ø63		0.5 (Nil)	1 (M)	3 (L)	5 (Z)	None (N)				
							Perpendicular	In-line									
Solid state auto switch	Diagnostic indication (2-color indication)	Grommet	Yes	3-wire (NPN)	5 V, 12 V	—	M9NV	M9N	●	●	●	○	○	IC circuit	Relay, PLC		
				3-wire (PNP)			M9PV	M9P	●	●	●	○	○				
		Connector		2-wire	M9BV	M9B	●	●	●	○	○	○	—				
				—	H7C	●	●	●	●	—	—	—					
		Water resistant (2-color indication)		Grommet	3-wire (NPN)	5 V, 12 V	M9NVW	M9NW	●	●	●	○	○	○		IC circuit	
					3-wire (PNP)		M9PVW	M9PW	●	●	●	○	○	○		—	
	2-wire		M9BWW		M9BW	●	●	●	○	○	○	—					
	3-wire (NPN)		M9NAV**		M9NA**	○	○	○	○	○	○	IC circuit					
	Diagnostic output (2-color indication)	Grommet	3-wire (PNP)	5 V, 12 V	M9PAV**	M9PA**	○	○	○	○	○	○	IC circuit				
			2-wire		M9BAV**	M9BA**	○	○	○	○	○	○	—				
Reed auto switch	Diagnostic indication (2-color indication)	Grommet	Yes	3-wire (Equiv. to NPN)	—	5 V	A96V	A96	●	—	●	—	—	—	IC circuit	Relay, PLC	
				—			A93V	A93	●	—	●	—	—	—			
		Connector		2-wire	24 V	12 V	100 V or less	A90V	A90	●	—	●	—	—	—		IC circuit
							100 V, 200 V	—	B54	●	—	●	—	—	—		
		Grommet		2-wire	24 V	12 V	200 V or less	—	B64	●	—	●	—	—	—		—
							—	—	C73C	●	—	●	—	—	—		
		Connector		2-wire	24 V	12 V	24 V or less	—	C80C	●	—	●	—	—	—		IC circuit
							—	—	B59W	●	—	●	—	—	—		

** Water resistant type auto switches can be mounted on the above models, but in such case SMC cannot guarantee water resistance.

Consult with SMC regarding water resistant types with the above model numbers.

* Lead wire length symbols: 0.5 m Nil (Example) M9NW
1 m M (Example) M9NWM
3 m L (Example) M9NWL
5 m Z (Example) M9NWZ
None N (Example) H7CN

* Solid state auto switches marked with "○" are produced upon receipt of order.

* Since there are other applicable auto switches than listed, refer to page 368 for details.

* For details about auto switches with pre-wired connector, refer to pages 1626 and 1627.

* D-A9□□/M9□□□ auto switches are shipped together (not assembled). (Only auto switch mounting brackets are assembled before shipped.)

CG1

CGP

CG2-Z

CG2

CM2-Z

CM2

CM3

CG1-Z

CG1

CG3

MB-Z

MB

MB1

CA2-Z

CA2

CS1

CS2

D-□

-X□

Technical data

Series CG1KW



Symbol

Rubber bumper

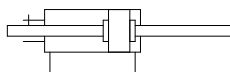

Refer to pages 363 to 368 for cylinders with auto switches.

- Minimum auto switch mounting stroke
- Proper auto switch mounting position (detection at stroke end) and mounting height
- Operating range
- Switch mounting bracket: Part no.

Specifications

Bore size (mm)	20	25	32	40	50	63
Action	Double acting, Double rod					
Lubricant	Not required (Non-lube)					
Fluid	Air					
Proof pressure	1.5 MPa					
Maximum operating pressure	1.0 MPa					
Minimum operating pressure	0.08 MPa					
Ambient and fluid temperature	Without auto switch: -10 to 70°C (No freezing) With auto switch: -10 to 60°C (No freezing)					
Piston speed	50 to 500 mm/s					
Stroke length tolerance	Up to 600 ^{+0.14} mm					
Cushion	Rubber bumper					
Rod non-rotating accuracy	±1°	±0.8°				±0.5°
Mounting	Basic style, Axial foot style, Flange style, Trunnion style					

Accessory

Mounting		Basic style	Axial foot style	Flange style	Trunnion style
Standard equipment	Rod end nut	●	●	●	●
Option	Single knuckle joint	●	●	●	●
	Double knuckle joint (With pin) *	●	●	●	●
	Pivot bracket	—	—	—	●

* Pin and retaining ring are shipped together with double knuckle joint.

Standard Stroke

Bore size (mm)	Standard stroke (mm) ⁽¹⁾	Long stroke (mm)
20	25, 50, 75, 100, 125, 150, 200	—
25	25, 50, 75, 100, 125, 150, 200, 250, 300	—
32		—
40		301 to 500
50, 63		301 to 600

Note 1) Manufacture of intermediate strokes at 1 mm intervals is possible. (Spacers are not used.)

Note 2) The maximum limit is 1500 stroke, but the products that exceed the standard or the long stroke limit are not guaranteed.

Air Cylinder: Non-rotating Rod Type Double Acting, Double Rod *Series CG1KW*

Weight

(kg)

Basic weight	Bore size (mm)	20	25	32	40	50	63
	Basic style		0.13	0.22	0.33	0.55	1.02
	Axial foot style	0.24	0.35	0.49	0.77	1.50	2.09
	Flange style	0.21	0.32	0.47	0.75	1.36	1.87
	Trunnion style	0.14	0.24	0.36	0.60	1.16	1.51
Pivot bracket		0.08	0.09	0.17	0.25	0.44	0.80
Single knuckle joint		0.05	0.09	0.09	0.10	0.22	0.22
Double knuckle joint (With pin)		0.05	0.09	0.09	0.13	0.26	0.26
Additional weight per each 50 mm of stroke		0.07	0.10	0.13	0.23	0.34	0.38

Calculation: (Example) **CG1KWLN32-100** (Foot style, ø32, 100st)

- Basic weight.....0.49 (Foot, ø32) • Cylinder stroke.....100st
- Additional weight.....0.13/50 st • 0.49 + 0.13 x 100/50 = 0.75 kg

Mounting Bracket Part No.

Mounting bracket	Min. order	Bore size (mm)						Description
		20	25	32	40	50	63	
Axial foot	2 <small>Note)</small>	CG-L020	CG-L025	CG-L032	CG-L040	CG-L050	CG-L063	Foot x 2, Mounting bolt x 8
Flange	1	CG-F020	CG-F025	CG-F032	CG-F040	CG-F050	CG-F063	Flange x 1, Mounting bolt x 4
Trunnion pin	1	CG-T020	CG-T025	CG-T032	CG-T040	CG-T050	CG-T063	Trunnion pin x 2, Trunnion bolt x 2, Flat washer x 2
Pivot bracket	1	CG-020-24A	CG-025-24A	CG-032-24A	CG-040-24A	CG-050-24A	CG-063-24A	Pivot bracket x 1

Note) Order two foot brackets per a cylinder.

Construction

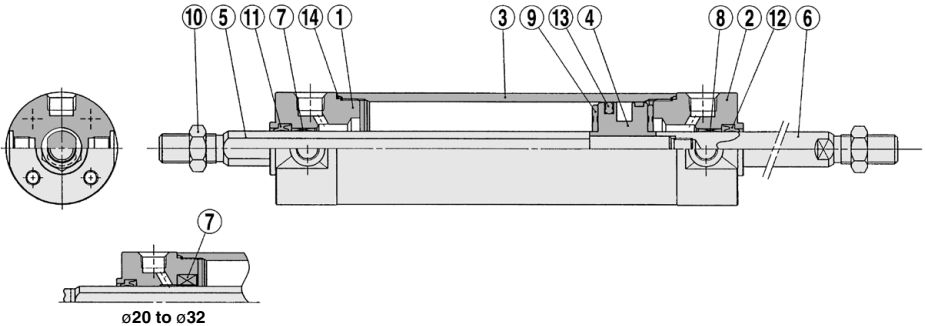

Component Parts

No.	Description	Material	Note
1	Rod cover A	Aluminum alloy	Clear hard anodized
2	Rod cover B	Aluminum alloy	Clear hard anodized
3	Cylinder tube	Aluminum alloy	Hard anodized
4	Piston	Aluminum alloy	Chromated
5	Piston rod A	Carbon steel *	Hard chrome plated *
6	Piston rod B	Carbon steel **	Hard chrome plated **
7	Non-rotating guide	Copper oil-impregnated sintered alloy	
8	Bushing	Copper oil-impregnated sintered alloy	ø40 or more: Copper alloy
9	Bumper	Urethane	
10	Rod end nut	Rolled steel	
11	Rod seal A	NBR	
12	Rod seal B	NBR	
13	Piston seal	NBR	
14	Tube gasket	NBR	

* The material is stainless steel for ø20 to ø32.

** The material is stainless steel on auto switch equipped style ø20 and ø25.

*** A magnet is equipped on the piston of the cylinder with auto switch.

Replacement Parts: Seal Kit

Bore size (mm)	Kit no.	Contents
20	CG1KWN20-PS	Set of the nos. ①, ②, ③, ④
25	CG1KWN25-PS	
32	CG1KWN32-PS	
40	CG1KWN40-PS	

Note) Refer to the Specific Product Precautions on page 310 for Disassembly/Replacement. Order with a part number for each type and bore size.

* The seal kit includes a grease pack (10 g). Order with the following part number when only the grease pack is needed.

Grease pack part no. : GR-S-010 (10 g)

CG1

CGP

CGJ

-Z

CG2

CM2

-Z

CM2

CM3

CG1

-Z

CG1

CG3

MB

-Z

MB

MB1

CA2

-Z

CA2

CS1

CS2

D-□

-X□

Technical data

Series CG1KW

Basic Style with Rubber Bumper: CG1KWBN

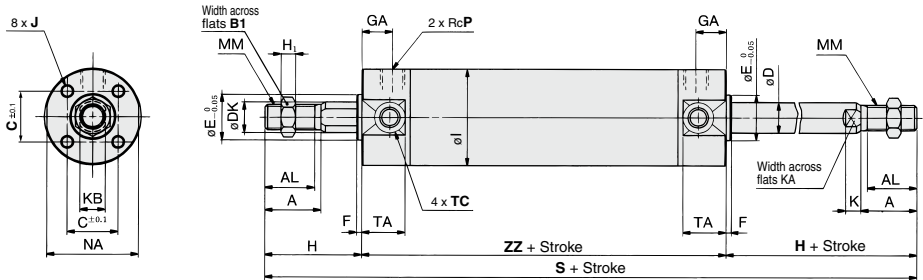

Bore size (mm)	Stroke range (mm)	A	AL	B1	C	D	DK	E	F	GA	H1	I	J	K	KA	KB	MM	NA	P	S
20	Up to 200	18	15.5	13	14	8	9.2	12	2	12	5	26	M4 x 0.7 depth 7	5	6	8	M8 x 1.25	24	1/8	77
25	Up to 300	22	19.5	17	16.5	10	11	14	2	12	6	31	M5 x 0.8 depth 7.5	5.5	8	10	M10 x 1.25	29	1/8	77
32	Up to 300	22	19.5	17	20	12	12	18	2	12	6	38	M5 x 0.8 depth 8	5.5	10	10	M10 x 1.25	35.5	1/8	79
40	Up to 500	30	27	19	26	16	16	25	2	13	8	47	M6 x 1 depth 12	6	14	14	M14 x 1.5	44	1/8	87
50	Up to 600	35	32	27	32	20	20	30	2	14	11	58	M8 x 1.25 depth 16	7	18	18	M18 x 1.5	55	1/4	102
63	Up to 600	35	32	27	38	20	20	32	2	14	11	72	M10 x 1.5 depth 16	7	18	18	M18 x 1.5	69	1/4	102

Bore size (mm)	TA	TC	H	ZZ
20	11	M5 x 0.8	35	147
25	11	M6 x 0.75	40	157
32	11	M8 x 1.0	40	159
40	12	M10 x 1.25	50	187
50	13	M12 x 1.25	58	218
63	13	M14 x 1.5	58	218

Note) Dimensions are the same as CG1W standard type.
Refer to page 328.
• Old number is CG1□□□□-XC21 as made-to-order.

⚠ Precautions

Be sure to read before handling.
Refer to front matter 57 for Safety Instructions and pages 3 to 12 for Actuator and Auto Switch Precautions.

Caution on Handling/Disassembly

⚠ Caution

- Avoid using the air cylinder in such a way that rotational torque would be applied to the piston rod.
 - If rotational torque is applied, the non-rotating guide will become deformed, thus affecting the non-rotating accuracy. Refer to the table below for the approximate values of the allowable range of rotational torque.

Allowable rotational torque (N·m or less)	ø20	ø25, ø32	ø40, ø50, ø63
	0.2	0.25	0.44

- To screw a bracket or a nut onto the piston rod, make sure to retract the piston rod entirely, and place a wrench over the flat portion of the rod that protrudes.

Tighten it by giving consideration to prevent the tightening torque from being applied to the non-rotating guide.

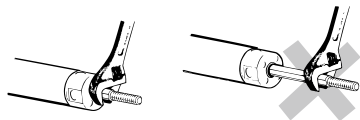

2. When replacing rod seals, please contact SMC.

Air leakage may be happened, depending on the position in which a rod seal is fitted. Thus, please contact SMC when replacing them.

Air Cylinder: Direct Mount Type Double Acting

Series CG1R

ø20, ø25, ø32, ø40, ø50, ø63

How to Order

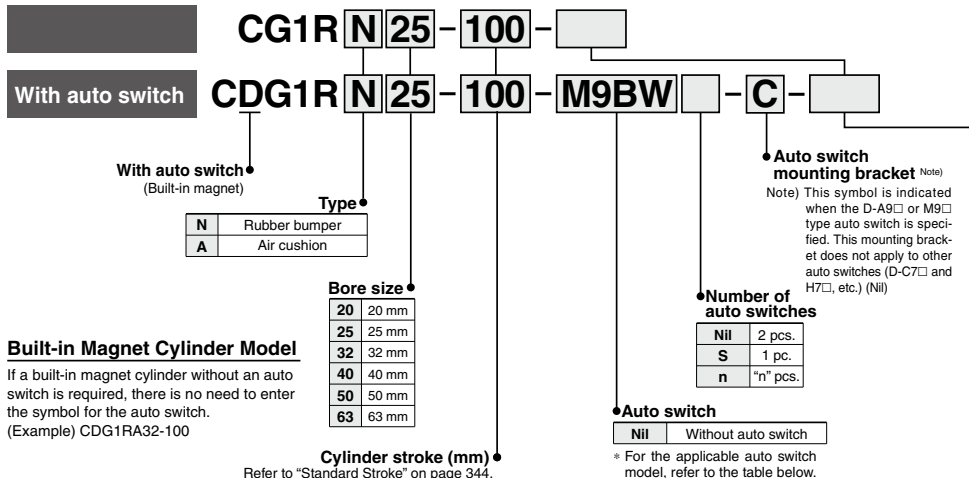

Made to Order

Refer to page 344 for details.

Applicable Auto Switches

Refer to pages 1559 to 1673 for further information on auto switches.

Type	Special function	Electrical entry	Indicator light	Wiring (Output)	Load voltage		Auto switch model		Lead wire length (m)					Pre-wired connector	Applicable load	
					DC	AC	Applicable bore size		0.5 (Nil)	1 (M)	3 (L)	5 (Z)	None (N)			
							ø20 to ø32	ø40 to ø63								
Solid state auto switch		Grommet	Yes	3-wire (NPN)	24 V	5 V, 12 V	—	M9NV	M9N	●	●	●	○	—	○	Relay, PLC
				3-wire (PNP)				M9PV	M9P	●	●	●	○	—	○	
		2-wire		M9BV				M9B	●	●	●	○	—	○		
		—		H7C				●	—	●	●	—	—	—		
	Diagnostic indication (2-color indication)	Grommet	Yes	3-wire (NPN)	24 V	5 V, 12 V	—	M9NVV	M9NV	●	●	●	○	—	○	Relay, PLC
				3-wire (PNP)				M9PVV	M9PV	●	●	●	○	—	○	
	2-wire	M9BVV		M9BV				●	●	●	○	—	○			
	—	H7C		●				—	●	●	—	—	—			
	Water resistant (2-color indication)	Grommet	Yes	3-wire (NPN)	24 V	5 V, 12 V	—	M9NAV**	M9NA**	○	○	●	○	—	○	Relay, PLC
				3-wire (PNP)				M9PAV**	M9PA**	○	○	●	○	—	○	
2-wire	M9BAV**	M9BA**		○				○	●	○	—	○				
—	H7NF	●		—				●	○	—	—	—				
Reed auto switch		Grommet	Yes	3-wire (Equiv. to NPN)	24 V	12 V	—	A96V	A96	●	—	●	—	—	—	Relay, PLC
				100 V				A93V	A93	●	—	●	—	—	—	
				100 V or less				A90V	A90	●	—	●	—	—	—	
		100 V, 200 V		—				B54	●	—	●	—	—	—	—	
		200 V or less		—				B64	●	—	●	—	—	—	—	
		—		—				C73C	●	—	●	—	—	—	—	
Connector	Yes	Yes	2-wire	24 V	12 V	—	—	C80C	●	—	●	—	—	—	Relay, PLC	
							—	B59W	●	—	●	—	—	—		IC circuit
							—	—	—	—	—	—	—	—		—
Grommet	None	Yes	2-wire	24 V	12 V	—	—	—	●	—	●	—	—	—	Relay, PLC	
							—	—	●	—	●	—	—	—		—
							—	—	●	—	●	—	—	—		—

** Water resistant type auto switches can be mounted on the above models, but in such case SMC cannot guarantee water resistance. Consult with SMC regarding water resistant types with the above model numbers.

* Lead wire length symbols: 0.5 m Nil (Example) M9NV
1 m M (Example) M9NVW
3 m L (Example) M9NWL
5 m Z (Example) M9NZZ
None N (Example) H7CN

* Solid state auto switches marked with "○" are produced upon receipt of order.

* Since there are other applicable auto switches than listed, refer to page 368 for details.

* For details about auto switches with pre-wired connector, refer to pages 1626 and 1627.

* D-A9□/M9□□ auto switches are shipped together (not assembled). (Only auto switch mounting brackets are assembled before shipped.)

CG1

CGP

CGJ2-Z

CGJ2

CM2-Z

CM2

CM3

CG1-Z

CG1

CG3

MB-Z

MB

MB1

CA2-Z

CA2

CS1

CS2

D-□

-X□

Technical data

Series CG1R

Series CG1R direct mount cylinder can be installed directly through the use of a square rod cover.

Space-saving has been realized.
Because it is a directly mounted style without using brackets, its overall length is shorter, and its installation pitch can be made smaller. Thus, the space that is required for installation has been dramatically reduced.



Symbol

Rubber bumper

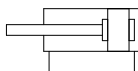

Air cushion

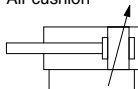

Made to Order Specifications
(For details, refer to pages 1675 to 1818.)

Symbol	Specifications
-XA□	Change of rod end shape
-XB6	Heat resistant cylinder (150°C) *1
-XB7	Cold resistant cylinder *2
-XB9	Low speed cylinder (10 to 50 mm/s) *3
-XB13	Low speed cylinder (5 to 50 mm/s) *3
-XC6	Piston rod and rod end nut made of stainless steel
-XC8	Adjustable stroke cylinder/Adjustable extension type*3
-XC9	Adjustable stroke cylinder/Adjustable retraction type*3
-XC13	Auto switch rail mounting*3
-XC20	Head cover axial port*3
-XC22	Fluororubber seals
-XC85	Grease for food processing equipment

- * 1 Cylinders with rubber bumper have no bumper.
- * 2 Compatible with cylinders with rubber bumper, but has no bumper.
- * 3 Compatible with cylinders with rubber bumper only.

Refer to pages 363 to 368 for cylinders with auto switches.

- Minimum auto switch mounting stroke
- Proper auto switch mounting position (detection at stroke end) and mounting height
- Operating range
- Switch mounting bracket: Part no.

Specifications

Bore size (mm)	20	25	32	40	50	63
Action	Double acting, Single rod					
Lubricant	Not required (Non-lube)					
Fluid	Air					
Proof pressure	1.5 MPa					
Maximum operating pressure	1.0 MPa					
Minimum operating pressure	0.05 MPa					
Ambient and fluid temperature	Without auto switch: -10 to 70°C (No freezing)					
	With auto switch: -10 to 60°C (No freezing)					
Piston speed	50 to 1000 mm/s					
Stroke length tolerance	Up to 300 ^{±0.14} mm					
Cushion	Rubber bumper, Air cushion					

Weight

Bore size (mm)	20	25	32	40	50	63
Basic weight	0.14	0.23	0.35	0.57	1.04	1.49
Single knuckle joint	0.05	0.09	0.09	0.10	0.22	0.22
Double knuckle joint (With pin)	0.05	0.09	0.09	0.13	0.26	0.26
Additional weight per each 50 mm of stroke	0.05	0.07	0.09	0.15	0.22	0.26
Additional weight with air cushion	0.01	0.01	0.02	0.02	0.03	0.03

Calculation: (Example) **CG1RN32-100** (ø32, 100 st)
 • Basic weight..... 0.35
 • Additional weight..... 0.09/50 st
 • Cylinder stroke..... 100 st
 0.35 + 0.09 x 100/50 = 0.53 kg

Accessory

Standard equipment	Mounting	Basic style
	Rod end nut	●
Option	Single knuckle joint	●
	Double knuckle joint * (With pin)	●

* Pin and retaining ring are shipped together with double knuckle joint.

Standard Stroke

Bore size (mm)	Standard stroke * (mm)
20	25, 50, 75, 100, 125, 150
25, 32	25, 50, 75, 100, 125, 150, 200
40, 50, 63	25, 50, 75, 100, 125, 150, 200, 250, 300

* Manufacture of intermediate strokes at 1 mm intervals is possible. (Spacers are not used.)
 * Long strokes are not available.

Clean Series

10-CG1RN

Clean Series (With relief port)

The rod portion of the actuator has a double seal construction, and a relief port is provided to discharge the exhaust air directly outside of the clean room.

Thus, it can be used in a Class 100 clean room.

Specifications

Bore size (mm)	ø20, ø25, ø32, ø40, ø50, ø63
Action	Double acting
Fluid	Air
Maximum operating pressure	1.0 MPa
Minimum operating pressure	0.05 MPa
Cushion	Rubber bumper
Piston speed	50 to 400 mm/s
Relief port size	M5 x 0.8

* Auto switch can be mounted.

For details, refer to the separate catalog, "Pneumatic Clean Series".

Precautions

Be sure to read before handling.
Refer to front matter 57 for Safety Instructions and pages 3 to 12 for Actuator and Auto Switch Precautions.

When the cylinder is used as mounted with a single side fixed or free, a bending moment will be applied to the cylinder due to the vibration generated at the stroke end, and the cylinder may be damaged. In such a case, mount a bracket to reduce the vibration of the cylinder or use the cylinder at a piston speed low enough to prevent the cylinder from vibrating at the stroke end.

Also, please use a support bracket when the cylinder body moves or when the long stroke cylinder is fixed horizontally on one side.

CG1

CGP

CG2
-Z

CG2

CM2
-Z

CM2

CM3

CG1
-Z

CG1

CG3

MB
-Z

MB

MB1

CA2
-Z

CA2

CS1

CS2

D-

-X

Technical
data

Series CG1R

Construction

Basic style: Bottom mounting style/with rubber bumper

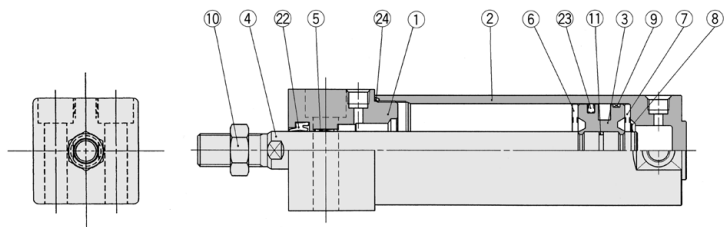

With air cushion

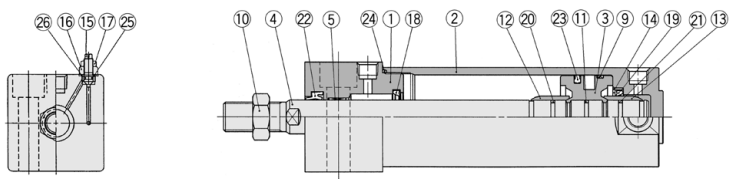

Component Parts

No.	Description	Material	Note
1	Rod cover	Aluminum alloy	Clear hard anodized
2	Tube cover	Aluminum alloy	Clear hard anodized
3	Piston	Aluminum alloy	Chromated
4	Piston rod	Carbon steel *	Hard chrome plated *
5	Bushing	Bearing alloy	
6	Bumper A	Urethane	
7	Bumper B	Urethane	ø40 or larger: The same as bumper A
8	Retaining ring	Stainless steel	
9	Wear ring	Resin	
10	Rod end nut	Rolled steel	Zinc chromated
11	Piston gasket	NBR	
12	Cushion ring A	Aluminum alloy	Anodized
13	Cushion ring B	Aluminum alloy	ø32 or larger: The same as A, Anodized

No.	Description	Material	Note
14	Seal retainer	Rolled steel	
15	Cushion valve	Rolled steel	Electroless nickel plated
16	Valve retainer	Rolled steel	Electroless nickel plated
17	Lock nut	Carbon steel	Nickel plated
18	Cushion seal A	Urethane	
19	Cushion seal B	Urethane	
20	Cushion ring gasket A	NBR	
21	Cushion ring gasket B	NBR	ø32 or larger: The same as A
22	Rod seal	NBR	
23	Piston seal	NBR	
24	Tube gasket	NBR	
25	Valve seal	NBR	
26	Valve retaining gasket	NBR	

Note) In the case of cylinders with auto switches, rubber magnets are installed in the piston.

* The material is stainless steel on auto switch equipped styles ø20 and ø25.

Replacement parts/Seal kit are the same as standard type, double acting, single rod. Refer to page 311.

Note) Refer to the Specific Product Precautions on page 310 for Disassembly/Replacement.

Basic Style with Bottom Mounting

With rubber bumper: CG1RN

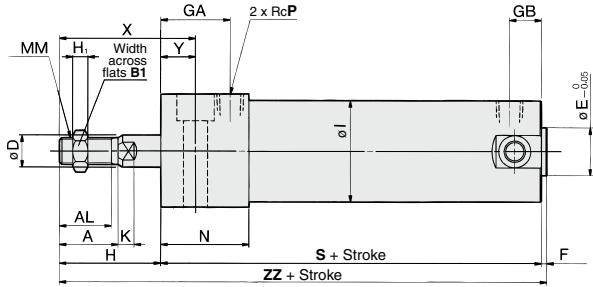
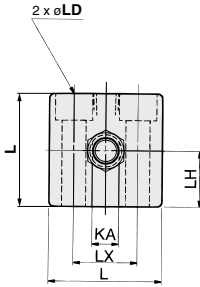

With air cushion CG1RA

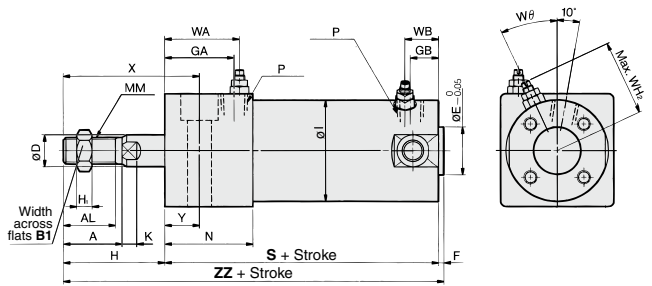
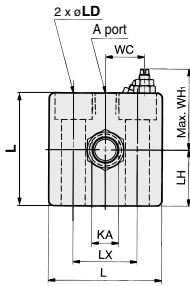
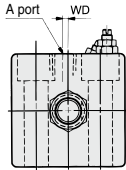

Bore size (mm)	Stroke range (mm)	A	AL	B ₁	D	E	F	GA	GB	H	H ₁	I	K	KA	L	LD	LH	LX	MM	N	P	S	X	Y	ZZ
20	Up to 150	18	15.5	13	8	12	2	20	10	27	5	26	5	6	30.4	ø6.5, ø9.5 counterbore depth 6	15	18	M8 x 1.25	27	1/8	75	38	11	104
25	Up to 200	22	19.5	17	10	14	2	22	10	32	6	31	5.5	8	36.4	ø6.6, ø11 counterbore depth 7	18	22	M10 x 1.25	29	1/8	77	44	12	111
32	Up to 200	22	19.5	17	12	18	2	26	10	32	6	38	5.5	10	42.4	ø9, ø14 counterbore depth 9	21	24	M10 x 1.25	33	1/8	83	45	13	117
40	Up to 300	30	27	19	16	25	2	30	10	39	8	47	6	14	52.4	ø11, ø17.5 counterbore depth 12	26	32	M14 x 1.5	37	1/8	94	55	16	136
50	Up to 300	35	32	27	20	30	2	33	12	45	11	58	7	18	64.5	ø14, ø20 counterbore depth 14	32	41	M18 x 1.5	44	1/4	108	62	17	155
63	Up to 300	35	32	27	20	32	2	39	12	45	11	72	7	18	76.6	ø18, ø28 counterbore depth 18	38	46	M18 x 1.5	50	1/4	114	64	19	161

With air cushion

Bore size (mm)	Stroke range (mm)	P	WA	WB	WC	WD	WH	WH ₂	Wθ
20	Up to 150	M5 x 0.8	22	15	8.5	2	25	23	30°
25	Up to 200	M5 x 0.8	24	15	11	2	27.5	25	30°
32	Up to 200	Rc 1/8	28	15	14.5	—	30.5	28.5	25°
40	Up to 300	Rc 1/8	32	15	18.5	—	35.5	33	20°
50	Up to 300	Rc 1/4	36	17	22	—	43.5	40.5	20°
63	Up to 300	Rc 1/4	42	17	29	—	49.5	47.5	20°

- CG1
- CGP
- CG2-Z
- CG2
- CM2-Z
- CM2
- CM3
- CG1-Z
- CG1**
- CG3
- MB-Z
- MB
- MB1
- CA2-Z
- CA2
- CS1
- CS2

- D-□
- X□
- Technical data

Air Cylinder: Direct Mount, Non-rotating Rod Type

Series CG1KR

ø20, ø25, ø32, ø40, ø50, ø63

How to Order

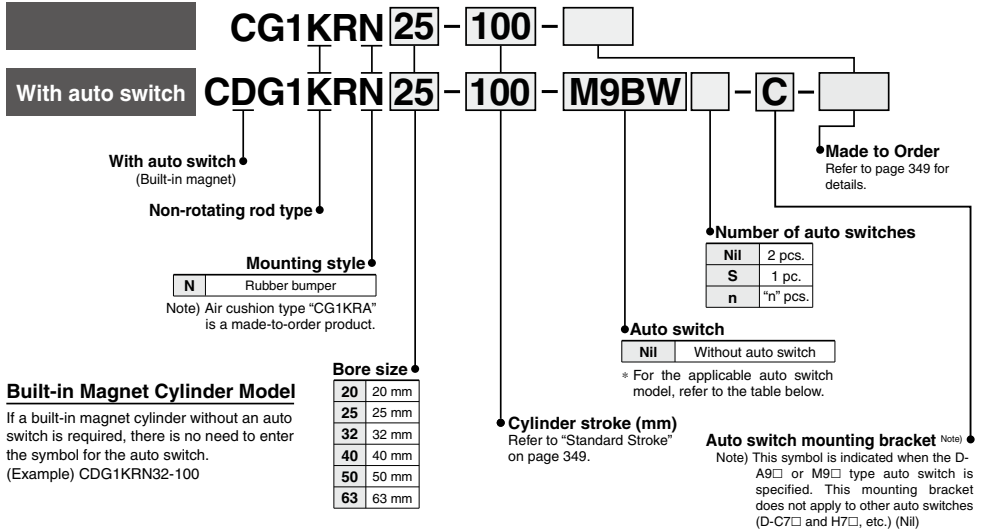

Built-in Magnet Cylinder Model

If a built-in magnet cylinder without an auto switch is required, there is no need to enter the symbol for the auto switch.
(Example) CDG1KR N32-100

Applicable Auto Switches

Refer to pages 1559 to 1673 for further information on auto switches.

Type	Special function	Electrical entry	Indicator/light	Wiring (Output)	Load voltage		Auto switch model		Lead wire length (m)					Pre-wired connector	Applicable load						
					DC	AC	Applicable bore size		0.5 (Nil)	1 (M)	3 (L)	5 (Z)	None (N)		IC circuit	Relay, PLC					
							ø20 to ø63	Perpendicular									In-line				
Solid state auto switch	—	Grommet	Yes	3-wire (NPN)	5 V, 12 V	—	M9NV	M9N	●	●	○	—	—	—	—	IC circuit	Relay, PLC				
				3-wire (PNP)			M9PV	M9P	●	●	○	—	—	—							
	Connector	Yes	2-wire	12 V	—	M9BV	M9B	●	●	○	—	—	—	—	—						
			—	—	H7C	●	—	●	●	—	—	—									
	Diagnostic indication (2-color indication)	Grommet	Yes	3-wire (NPN)	5 V, 12 V	24 V	—	M9NVV	M9NW	●	●	○	—	—	—	—		IC circuit			
				3-wire (PNP)				M9PVV	M9PW	●	●	○	—	—	—	—		—			
	Water resistant (2-color indication)	Grommet	Yes	2-wire	12 V	—	—	M9BWW	M9BW	●	●	○	—	—	—	—		—			
				3-wire (NPN)	5 V, 12 V	—	M9NAV**	M9NA**	○	○	●	○	—	—	—	—		—	IC circuit		
Diagnostic output (2-color indication)	Grommet	Yes	3-wire (PNP)	5 V, 12 V	24 V	—	—	—	○	○	○	○	—	—	—	—					
			2-wire				12 V	—	M9PAV**	M9PA**	○	○	○	○	—	—	—	—			
Reed auto switch	—	Grommet	Yes	3-wire (Equiv. to NPN)	—	5 V	—	A96V	A96	●	—	●	—	—	—	—	IC circuit				
								None	24 V	12 V	100 V	A93V	A93	●	—	●	—	—	—	—	—
											100 V or less	A90V	A90	●	—	●	—	—	—	—	—
								Yes	24 V	12 V	100 V, 200 V	—	B54	●	—	●	—	—	—	—	—
		200 V or less	—	B64	●	—	●				—	—	—	—	—	—					
		None	24 V	12 V	—	—	C73C	●	—	●	●	—	—	—	—	—	—				
					24 V or less	—	C80C	●	—	●	●	—	—	—	—	—	IC circuit				
		Connector	Yes	24 V	12 V	—	—	—	—	—	●	—	●	—	—	—	—	—			
—	—								B59W	●	—	●	—	—	—	—	—	—			

** Water resistant type auto switches can be mounted on the above models, but in such case SMC cannot guarantee water resistance. Consult with SMC regarding water resistant types with the above model numbers.

* Lead wire length symbols: 0.5 m Nil (Example) M9NW
1 m M (Example) M9NWW
3 m L (Example) M9NWL
5 m Z (Example) M9NWZ
None N (Example) H7CN

* Solid state auto switches marked with "○" are produced upon receipt of order.

* Since there are other applicable auto switches than listed, refer to page 368 for details.

* For details about auto switches with pre-wired connector, refer to pages 1626 and 1627.

* D-A9□/M9□□ auto switches are shipped together (not assembled). (Only auto switch mounting brackets are assembled before shipped).

Series CG1KR direct mount, non-rotating rod type cylinder can be installed directly through the use of a square rod cover.

Space-saving has been realized. Because it is a directly mounted style without using brackets, its overall length is shorter, and its installation pitch can be made smaller. Thus, the space that is required for installation has been dramatically reduced.



Symbol Rubber bumper

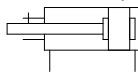

Made to Order Specifications
(For details, refer to pages 1699 to 1818.)

Symbol	Specifications
-XC8	Adjustable stroke cylinder/Adjustable extension type*1
-XC9	Adjustable stroke cylinder/Adjustable retraction type*1
-XC20	Head cover axial port*1

*1 Compatible with cylinders with rubber bumper only.

Refer to pages 363 to 368 for cylinders with auto switches.
<ul style="list-style-type: none"> • Minimum auto switch mounting stroke • Proper auto switch mounting position (detection at stroke end) and mounting height • Operating range • Switch mounting bracket: Part no.

Specifications

Bore size (mm)	20	25	32	40	50	63
Action	Double acting, Single rod					
Lubricant	Not required (Non-lube)					
Fluid	Air					
Proof pressure	1.5 MPa					
Maximum operating pressure	1.0 MPa					
Minimum operating pressure	0.05 MPa					
Ambient and fluid temperature	Without auto switch: -10 to 70°C (No freezing)					
	With auto switch: -10 to 60°C (No freezing)					
Piston speed	50 to 500 mm/s					
Stroke length tolerance	Up to 300 ^{+1.4} mm					
Cushion	Rubber bumper					
Rod non-rotating accuracy	±1°		±0.8°			±0.5°

Weight

Bore size (mm)	20	25	32	40	50	63
Basic weight	0.14	0.24	0.35	0.56	1.04	1.48
Single knuckle joint	0.05	0.09	0.09	0.10	0.22	0.22
Double knuckle (With pin)	0.05	0.09	0.09	0.13	0.26	0.26
Additional weight per each 50 mm of stroke	0.05	0.07	0.09	0.15	0.22	0.26

Calculation: (Example) **CG1KRN32-100** (ø32, 100 st)
 • Basic weight:.....0.35
 • Additional weight:.....0.09/50 st
 • Cylinder stroke:.....100 st
 0.35 + 0.09 x 100/50 = 0.53 kg

Standard Stroke

Bore size (mm)	Standard stroke (mm) *
20	25, 50, 75, 100, 125, 150
25-32	25, 50, 75, 100, 125, 150, 200
40-50-63	25, 50, 75, 100, 125, 150, 200, 250, 300

* Manufacture of intermediate strokes at 1 mm intervals is possible. (Spacers are not used.)
 * Long strokes are not available.

Accessory

Mounting		Basic style
Standard equipment	Rod end nut	●
Option	Single knuckle joint	●
	Double knuckle joint * (With pin)	●

* Pin and retaining ring are shipped together with double knuckle joint.

⚠ Precautions

- Be sure to read before handling.**
Refer to front matter 57 for Safety Instructions and pages 3 to 12 for Actuator and Auto Switch Precautions.

Caution on Handling/Disassembly

⚠ Caution

When the cylinder is used as mounted with a single side fixed or free (basic type, flange type), a bending moment will be applied to the cylinder due to the vibration generated at the stroke end, and the cylinder may be damaged. In such a case, mount a bracket to reduce the vibration of the cylinder or use the cylinder at a piston speed low enough to prevent the cylinder from vibrating at the stroke end. Also, please use a support bracket when the cylinder body moves or when the long stroke cylinder is fixed horizontally on one side.

1. Avoid using the air cylinder in such a way that rotational torque would be applied to the piston rod.

- If rotational torque is applied, the non-rotating guide will become deformed, thus affecting the non-rotating accuracy. Refer to the table below for the allowable range of the allowable range of rotational torque.

Allowable rotational torque (N·m or less)	ø20	ø25, ø32	ø40, ø50, ø63
	0.2	0.25	0.44

- To screw a bracket or a nut onto the piston rod, make sure to retract the piston rod entirely, and place a wrench over the flat portion of the rod that protrudes. Tighten it by giving consideration to prevent the tightening torque from being applied to the non-rotating guide.

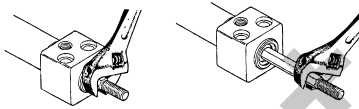

2. When replacing rod seals, please contact SMC.

Air leakage may be happened, depending on the position in which a rod seal is fitted. Thus, please contact SMC when replacing them.

CG1

CGP

CG2

CG2

CG2

CG2

CG2

CG3

CG1

CG1

CG3

MB

MB

MB1

CA2

CA2

CA2

CA2

CS1

CS2

CS2

CS2

CS2

CS2

CS2

CS2

CS2

CS2

CS2

CS2

CS2

CS2

CS2

CS2

CS2

CS2

Series CG1KR

Construction

Non-rotating rod type/ Bottom mounting style

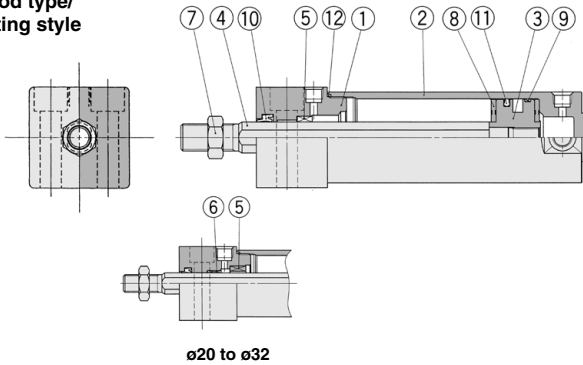

Component Parts

No.	Description	Material	Note
1	Rod cover	Aluminum alloy	Clear hard anodized
2	Tube cover	Aluminum alloy	Clear hard anodized
3	Piston	Aluminum alloy	Chromated
4	Piston rod	Carbon steel *	Hard chrome plated*
5	Non-rotating guide	Bearing alloy	
6	Bushing	Bearing alloy	ø20 to ø32 only
7	Rod end nut	Rolled steel	Zinc chromated
8	Bumper	Urethane	
9	Wear ring	Resin	
10	Rod seal	NBR	
11	Piston seal	NBR	
12	Tube gasket	NBR	

* The material is stainless steel for ø20, ø25 and ø32.

Replacement parts/Seal kits are the same as double acting, non-rotating rod type. Refer to page 337.

Note) Refer to the Specific Product Precautions on page 310 for Disassembly/Replacement.

Basic Style with Bottom Mounting: CG1KRN

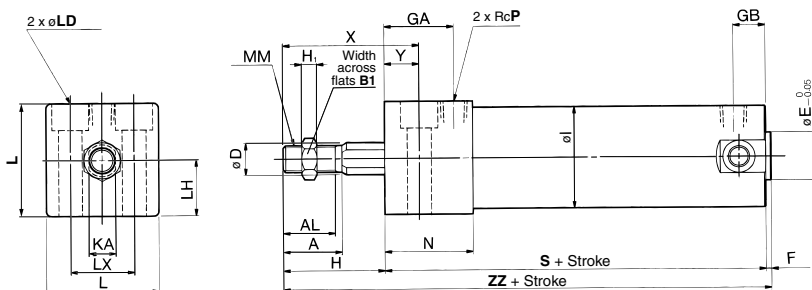

Bore size (mm)	Stroke range (mm)	A	AL	B ₁	D	E	GA	GB	H	H ₁	I	KA	L	LD	LH	LX	MM	N	P	S	X	Y	ZZ
20	Up to 150	18	15.5	13	9.2	12	20	10	27	5	26	8	30.4	ø5.5, ø9.5 counterbore depth 6	15	18	M8 x 1.25	27	1/8	75	38	11	104
25	Up to 200	22	19.5	17	11	14	22	10	32	6	31	10	36.4	ø6.6, ø11 counterbore depth 7	18	22	M10 x 1.25	29	1/8	77	44	12	111
32	Up to 200	22	19.5	17	12	18	26	10	32	6	38	10	42.4	ø9, ø14 counterbore depth 9	21	24	M10 x 1.25	33	1/8	83	45	13	117
40	Up to 300	30	27	19	16	25	30	10	39	8	47	14	52.4	ø11, ø17.5 counterbore depth 12	26	32	M14 x 1.5	37	1/8	94	55	16	135
50	Up to 300	35	32	27	20	30	33	12	45	11	58	18	64.5	ø14, ø20 counterbore depth 14	32	41	M18 x 1.5	44	1/4	108	62	17	155
63	Up to 300	35	32	27	20	32	39	12	45	11	72	18	76.6	ø18, ø26 counterbore depth 18	38	46	M18 x 1.5	50	1/4	114	64	19	161

Auto switch mounting position is the same as that on page 365.

Air Cylinder: Low Friction Type Double Acting, Single Rod

Series **CG1** □ **Q**

ø20, ø25, ø32, ø40, ø50, ø63, ø80, ø100

Use the new series
"Smooth Cylinder Series CG1Y"
to realize both-direction low friction and low-speed operation.
(Refer to **Best Pneumatics No. 3.**)

How to Order

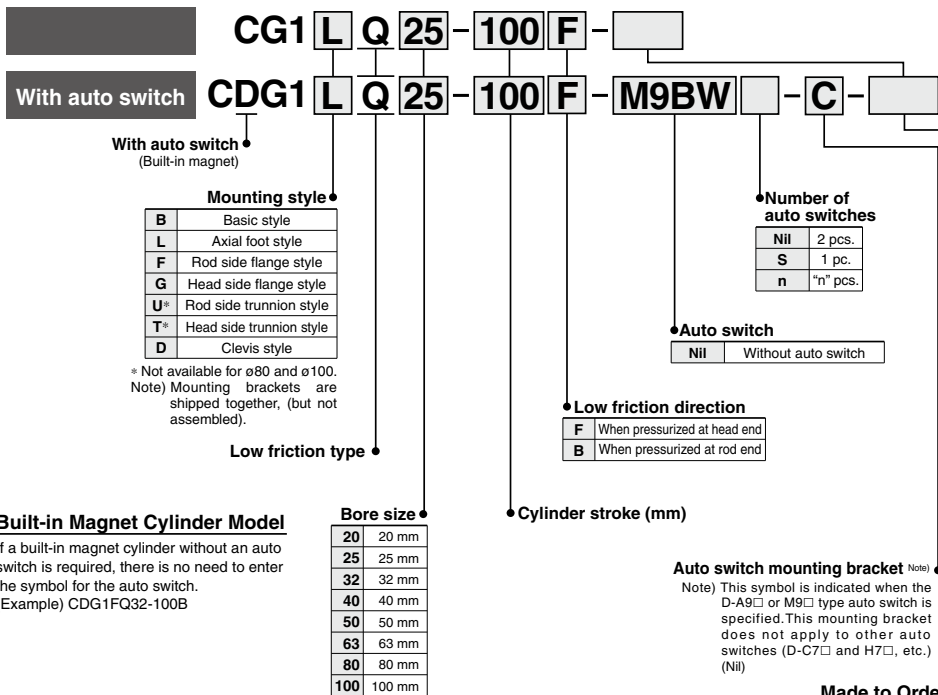

Built-in Magnet Cylinder Model

If a built-in magnet cylinder without an auto switch is required, there is no need to enter the symbol for the auto switch.
(Example) CDG1FQ32-100B

CJ1

CJP

CJ2
-Z

CJ2

CM2
-Z

CM2

CM3

CG1
-Z

CG1

CG3

MB
-Z

MB

MB1

CA2
-Z

CA2

CS1

CS2

D-□

-X□

Technical
data

End Lock Cylinder

Series CBG1

ø20, ø25, ø32, ø40, ø50, ø63, ø80, ø100

How to Order

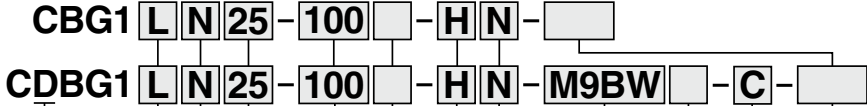

With auto switch
(Built-in magnet)

Mounting style

B	Basic style
L	Axial foot style
F	Rod side flange style
G	Head side flange style
U*	Rod side trunnion style
T*	Head side trunnion style
D	Clevis style

Type

N	Rubber bumper
A	Air cushion

Bore size

20	20 mm	50	50 mm
25	25 mm	63	63 mm
32	32 mm	80	80 mm
40	40 mm	100	100 mm

* Not available for bore size ø80 and ø100. Besides, trunnion cannot be attached in the side to which an end lock is attached. Note) Mounting brackets are shipped together, (but not assembled).

Cylinder stroke (mm)
Refer to "Standard Stroke" on page 353.

Built-in Magnet Cylinder Model

If a built-in magnet cylinder without an auto switch is required, there is no need to enter the symbol for the auto switch. (Example) CDBG1FA32-100-RL

Manual release type

N	Non-lock type
L	Lock type

Lock position

H	Head end lock
R	Rod end lock
W	Double end lock

Number of auto switches

Nil	2 pcs.
S	1 pc.
n	"n" pcs.

Auto switch

Nil	Without auto switch
-----	---------------------

* For the applicable auto switch Model, refer to the table below.

With rod boot

Nil	Without rod boot
J	Nylon tarpaulin
K	Heat resistant tarpaulin

* In the case of w/ rod boot, and a foot bracket or rod side flange as a bracket, those parts are to be assembled at the time of shipment.

Auto switch mounting bracket Note)

Note) This symbol is indicated when the D-A9□ or M9□ type auto switch is specified. This mounting bracket does not apply to other auto switches (D-C7□ and H7□, etc.) (Nil)

Made to Order

Refer to page 353 for details.

Applicable Auto Switches/Refer to pages 1559 to 1673 for further information on auto switches.

Type	Special function	Electrical entry	Indicator light	Wiring (Output)	Load voltage		Auto switch model			Lead wire length (m)					Pre-wired connector	Applicable load			
					DC	AC	Applicable bore size			0.5 (Nil)	1 (M)	3 (L)	5 (Z)	None (N)					
							ø20 to ø63	ø80, ø100	In-line										
Solid state auto switch		Grommet	Yes	3-wire (NPN)	5 V, 12 V		M9NV	M9N	●	●	●	○	—	○	IC circuit	Relay, PLC			
				3-wire (PNP)			—	—	G59	—	—	—	—	—			—		
		Connector		2-wire	12 V	—	—	G5P	—	—	—	—	—	—			—	—	
				—		—	H7C	—	—	—	—	—	—	—			—		
	Diagnostic indication (2-color indication)	Grommet	Yes	3-wire (NPN)	24 V	5 V, 12 V	—	—	—	—	—	—	—	—	—		IC circuit		
				3-wire (PNP)			—	—	G59W	—	—	—	—	—	—				
		Water resistant (2-color indication)		Grommet	2-wire	12 V	—	—	—	—	—	—	—	—	—		—	—	
					—		—	—	K59W	—	—	—	—	—	—				
				Diagnostic output (2-color indication)	Grommet	3-wire (NPN)	5 V, 12 V	M9NAV**	M9NA**	—	○	○	○	—	—		—	—	IC circuit
						3-wire (PNP)		M9PAV**	M9PA**	—	○	○	○	—	—		—	—	
Reed auto switch		Grommet	Yes	2-wire	24 V	12 V	—	—	—	—	—	—	—	—	IC circuit				
							—	—	—	B54	—	—	—	—		—	—		
		Connector		Yes	—	24 V or less	—	—	—	—	—	—	—	—	—	—	—		
					—		—	—	C73C	—	—	—	—	—	—	—			
		Grommet		Yes	—	24 V or less	—	—	—	—	—	—	—	—	—	—	IC circuit		
					—		—	—	C80C	—	—	—	—	—	—	—			
—	—	—	—	—	—	—	—	—	—	—	—	—	—	—					

** Water resistant type auto switches can be mounted on the above models, but in such case SMC cannot guarantee water resistance. Consult with SMC regarding water resistant types with the above model numbers.

* Lead wire length symbols: 0.5 m Nil (Example) M9NW
1 m M (Example) M9NWM
3 m L (Example) M9NWL
5 m Z (Example) M9NWX
None N (Example) H7CN

* Solid state auto switches marked with "○" are produced upon receipt of order.

* Since there are other applicable auto switches than listed, refer to page 368 for details.

* For details about auto switches with pre-wired connector, refer to pages 1626 and 1627.

* D-A9□□/M9□□□ auto switches are shipped together (not assembled). (Only auto switch mounting brackets are assembled before shipped).



Symbol

Rubber bumper

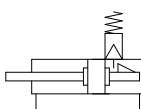

Air cushion

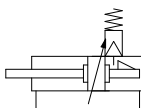

Made to Order Specifications
(For details, refer to pages 1675 to 1818.)

Symbol	Specifications
-XA□	Change of rod end shape
-XC13	Auto switch rail mounting

Refer to pages 363 to 368 for cylinders with auto switches.

- Minimum auto switch mounting stroke
- Proper auto switch mounting position (detection at stroke end) and mounting height
- Operating range
- Switch mounting bracket: Part no.

Specifications

Bore size (mm)	20	25	32	40	50	63	80	100
Action	Double acting, Single rod							
Lubricant	Not required (Non-Lube)							
Fluid	Air							
Proof pressure	1.5 MPa							
Maximum operating pressure	1.0 MPa							
Minimum operating pressure	0.15 MPa *							
Ambient and fluid temperature	Without auto switch: -10 to 70°C (No freezing) With auto switch: -10 to 60°C (No freezing)							
Piston speed	50 to 1000 mm/s						50 to 700 mm/s	
Stroke length tolerance	Up to 1000 ^{+0.1} ₀ mm, to 1200 ^{+0.15} ₀ mm						Up to 1000 ^{+0.14} ₀ mm Up to 1500 ^{+0.18} ₀ mm	
Cushion	Rubber bumper, Air cushion							
Mounting**	Basic style, Axial foot style, Rod side flange style Head side flange style, Rod side trunnion style Head side trunnion style, Clevis style (Used for changing the port location by 90°.)							

* 0.05 MPa except locking parts.

** Rod/Head side trunnion styles are not available for bore sizes ø80 and ø100.
Trunnion is not attached for a cover on which lock mechanism is equipped.

Lock Specifications

Lock position	Head end, Rod end, Double end							
Holding force (Max.) (N)	ø20	ø25	ø32	ø40	ø50	ø63	ø80	ø100
Backlash	215	330	550	860	1340	2140	3450	5390
Manual release	2 mm or less							
	Non-lock type, Lock type							

Adjust the switch position so that it operates upon movement to both the stroke end and backlash (2 mm) positions.

Standard Stroke

Bore size (mm)	Standard stroke (mm) ⁽¹⁾	Long stroke (mm)	Maximum manufacturable stroke (mm)
20	25, 50, 75, 100, 125, 150, 200	201 to 350	1500
25	25, 50, 75, 100, 125, 150, 200, 250, 300	301 to 400	
32		301 to 450	
40		301 to 800	
50, 63		301 to 1200	
80		301 to 1400	
100		301 to 1500	

Note 1) Manufacture of intermediate strokes at 1 mm intervals is possible. (Spacers are not used.)

Note 2) Long stroke applies to the axial foot style and the rod side flange style.

If other mounting brackets are used, or the length exceeds the long stroke limit, the stroke should be determined based on the stroke selection table in the technical data. (Refer to front matter 34.)

Rod Boot Material

Symbol	Rod boot material	Maximum operating temperature
J	Nylon tarpaulin	70°C
K	Heat resistant tarpaulin	110°C *

* Maximum ambient temperature for the rod boot itself.

CJ1

CJP

CJ2
-Z

CJ2

CM2
-Z

CM2

CM3

CG1
-Z

CG1

CG3

MB
-Z

MB

MB1

CA2
-Z

CA2

CA2

CS1

CS2

D-□

-X□

Technical data

Series CBG1

Construction: With Rubber Bumper

Head end lock

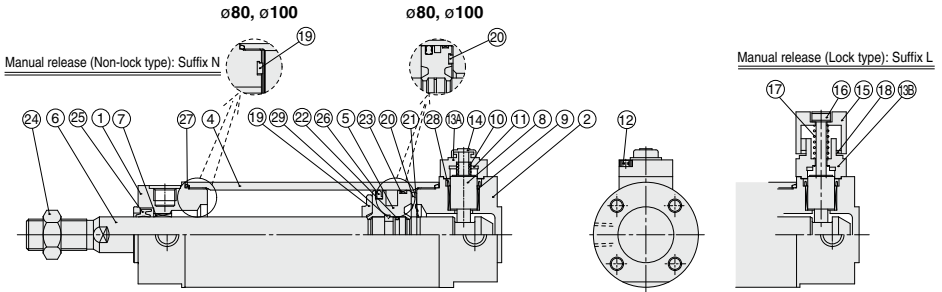

Rod end lock

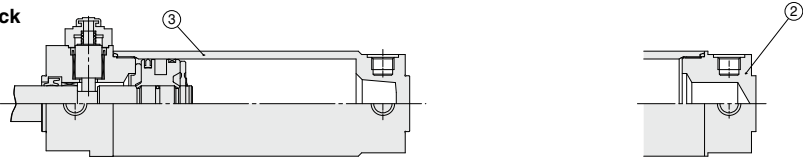

Long stroke

Component Parts

No.	Description	Material	Note
1	Rod cover	Aluminum alloy	Clear hard anodized
2	Head cover	Aluminum alloy	Clear hard anodized
3	Tube cover	Aluminum alloy	Clear hard anodized
4	Cylinder tube	Aluminum alloy	Hard anodized
5	Piston	Aluminum alloy	Chromated
6	Piston rod	Carbon steel	Hard chrome plated
7	Bushing	Bearing alloy	
8	Lock piston	Carbon steel	Hard chrome plated, Heat treated
9	Lock bushing	Copper alloy	
10	Lock spring	Stainless steel	
11	Bumper	Urethane	
12	Hexagon socket head cap screw	Alloy steel	Black zinc chromated
13A	Cap A	Aluminum die-casted	Black painted
13B	Cap B	Carbon steel	Oxide film treated
14	Rubber cap	Synthetic rubber	
15	M/O knob	Zinc die-casted	Black painted
16	M/O bolt	Alloy steel	Black zinc chromated, Red painted
17	M/O spring	Steel wire	Zinc chromated
18	Stopper ring	Carbon steel	Zinc chromated
19	Bumper A	Urethane	
20	Bumper B	Urethane	ø40 or larger: the same as bumper A

Note) In the case of cylinders with auto switches, magnets are installed in the piston.

* The material is stainless steel on auto switch equipped styles ø20 and ø25.

Replacement Parts/Seal Kit (With lock at single end)

Series	Bore size (mm)	Kit no.	Contents
CBG1□N	20	CBG1N20-PS	Set of nos. above and grease pack
Rubber bumper type	25	CBG1N25-PS	
	32	CBG1N32-PS	
	40	CBG1N40-PS	

Order seal kit in accordance with the bore size.

* The seal kit includes a grease pack (10 g). Order with the following part number when only the grease pack is needed.

Grease pack part no.: GR-S-010 (10 g)

⚠ Caution

When disassembling cylinders with bore sizes of ø20 through ø40, grip the double flat part of either the head cover or the rod cover with a vise and loosen the other side with a wrench or an adjustable angle wrench, etc., and then remove the cover.

When re-tightening, tighten approximately 2 degrees more than the original position. (Cylinders with ø50 or larger bore sizes are tightened with a large tightening torque and cannot be disassembled. Please contact SMC when disassembly is required.)

No.	Description	Material	Note
21	Retaining ring	Stainless steel	None for ø80, ø100
22	Piston gasket	NBR	
23	Wear ring	Resin	
24	Rod end nut	Rolled steel	Zinc chromated
25	Rod seal	NBR	
26	Piston seal	NBR	
27	Cylinder tube gasket	NBR	1 pc. when using tube cover
28	Lock piston seal	NBR	2 pcs. for with locks in both sides
29	Piston holder	Urethane	ø40 to ø100, head end lock only

Replacement Parts/Seal Kit (With lock at double end)

Series	Bore size (mm)	Kit no.	Contents
CBG1□N	20	CBG1N20-PS-W	Set of nos. above and grease pack
Rubber bumper type	25	CBG1N25-PS-W	
	32	CBG1N32-PS-W	
	40	CBG1N40-PS-W	

Order seal kit in accordance with the bore size.

* The seal kit includes a grease pack (10 g). Order with the following part number when only the grease pack is needed.

Grease pack part no.: GR-S-010 (10 g)

Construction: With Air Cushion

With air cushion Head end lock

Manual release (Non-lock type): Suffix N

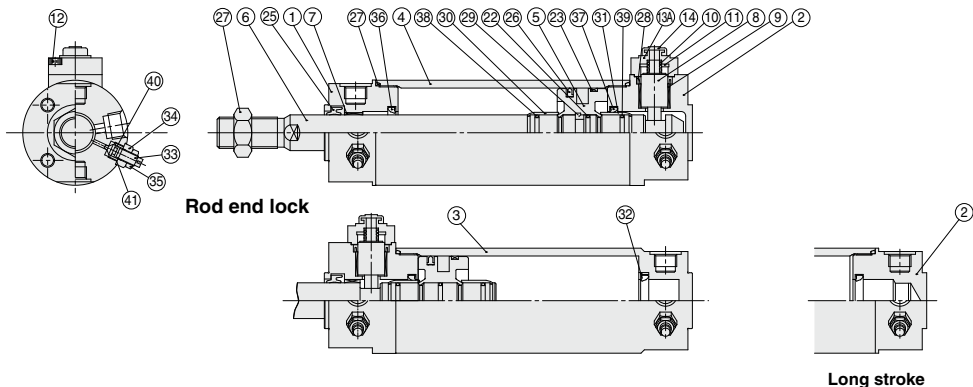

Component Parts

No.	Description	Material	Note
1	Rod cover	Aluminum alloy	Clear hard anodized
2	Head cover	Aluminum alloy	Clear hard anodized
3	Tube cover	Aluminum alloy	Clear hard anodized
4	Cylinder tube	Aluminum alloy	Hard anodized
5	Piston	Aluminum alloy	Chromated
6	Piston rod	Carbon steel	Hard chrome plated *
7	Bushing	Bearing alloy	
8	Lock piston	Carbon steel	Hard chrome plated, Heat treated
9	Lock bushing	Copper alloy	
10	Lock spring	Stainless steel	
11	Bumper	Urethane	
12	Hexagon socket head cap screw	Alloy steel	Black zinc chromated
13A	Cap A	Aluminum die-casted	Black painted
13B	Cap B	Carbon steel	Oxide film treated
14	Rubber cap	Synthetic rubber	
15	M/O knob	Zinc die-casted	Black painted
16	M/O bolt	Alloy steel	Black zinc chromated, Red painted
17	M/O spring	Steel wire	Zinc chromated
40	Stopper ring	Carbon steel	Zinc chromated

Note) In the case of cylinders with auto switches, magnets are installed in the piston.

* The material is stainless steel on auto switch equipped styles ø20 and ø25.

No.	Description	Material	Note
22	Piston gasket	NBR	
23	Wear ring	Resin	
24	Rod end nut	Rolled steel	Zinc chromated
25	Rod seal	NBR	
26	Piston seal	NBR	
27	Cylinder tube gasket	NBR	1 pc. when using tube cover.
28	Lock piston seal	NBR	2 pcs. for with locks in both sides
29	Piston holder	Urethane	ø40 to ø100 only
30	Cushion ring A	Aluminum alloy	Anodized
31	Cushion ring B	Aluminum alloy	Anodized
32	Seal retainer	Rolled steel	Only when using nickel plated, tube cover
33	Cushion valve	Rolled steel	Electroless nickel plated
34	Valve retainer	Rolled steel	Electroless nickel plated
35	Lock nut	Rolled steel	Nickel plated
36	Cushion seal A	Urethane	
37	Cushion seal B	Urethane	ø32 or larger: The same as A
38	Cushion ring gasket A	NBR	
39	Cushion ring gasket B	NBR	ø32 or larger: The same as A
40	Valve seal	NBR	
41	Valve retaining gasket	NBR	

Replacement Parts/Seal Kit (With lock at single end)

Series	Bore size (mm)	Kit no.	Contents
CBG1□A	20	CBG1A20-PS	Set of nos. above
Air cushion type	25	CBG1A25-PS-W	25, 26, 27, 29
	32	CBG1A32-PS	40, 41
	40	CBG1A40-PS	and grease pack

Order seal kit in accordance with the bore size.

* The seal kit includes a grease pack (10 g). Order with the following part number when only the grease pack is needed.

Grease pack part no.: GR-S-010 (10 g)

Replacement Parts/Seal Kit (With lock at double end)

Series	Bore size (mm)	Kit no.	Contents
CBG1□A	20	CBG1A20-PS-W	Set of nos. above
Air cushion type	25	CBG1A25-PS-W	25, 26, 27, 29
	32	CBG1A32-PS-W	40, 41
	40	CBG1A40-PS-W	and grease pack

Order seal kit in accordance with the bore size.

* The seal kit includes a grease pack (10 g). Order with the following part number when only the grease pack is needed.

Grease pack part no.: GR-S-010 (10 g)

⚠ Caution

When disassembling cylinders with bore sizes of ø20 through ø40, grip the double flat part of either the head cover or the rod cover with a vise and loosen the other side with a wrench or an adjustable angle wrench, etc., and then remove the cover.

When re-tightening, tighten approximately 2 degrees more than the original position. (Cylinders with ø50 or larger bore sizes are tightened with a large tightening torque and cannot be disassembled. Please contact SMC when disassembly is required.)

CG1
CJP
CG2-Z
CG2
CM2-Z
CM2
CM3
CG1-Z
CG1
CG3
MB-Z
MB
MB1
CA2-Z
CA2
CS1
CS2

D-□
-X□
Technical data

Series CBG1

Rubber Bumper Type: CBG1BN

Head end lock: CBG1BN

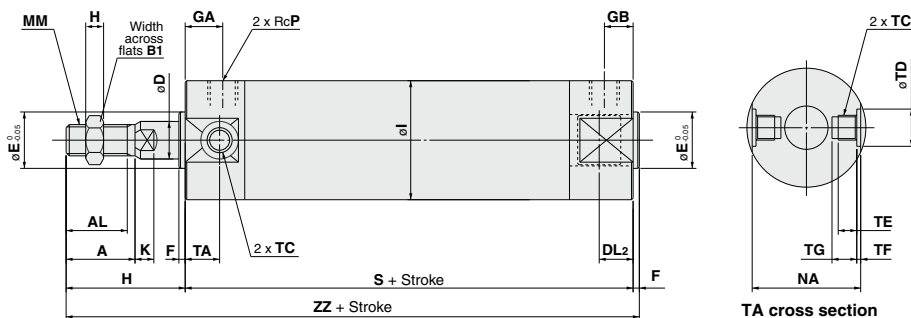

Manual release (Non-lock type): Suffix N

Manual release (Lock type): Suffix L

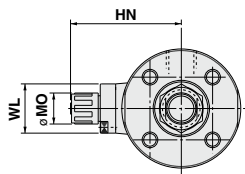
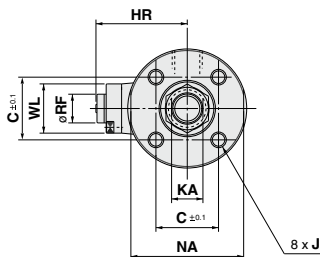

(mm)

Bore size (mm)	Stroke range	A	AL	B ₁	C	D	DL ₂	E	F	GA	GB	H	H ₁	HR	HN (Max.)	I	J
20	Up to 350	18	15.5	13	14	8	12.5	12	2	12	12	35	5	25.3	37	26	M4 x 0.7 depth 7
25	Up to 400	22	19.5	17	16.5	10	12.5	14	2	12	12	40	6	28.3	40	31	M5 x 0.8 depth 7.5
32	Up to 450	22	19.5	17	20	12	12	18	2	12	12	40	6	31.3	43	38	M5 x 0.8 depth 8
40	Up to 800	30	27	19	26	16	15	25	2	13	13	50	8	38.3	52.5	47	M6 x 1 depth 12
50	Up to 1200	35	32	27	32	20	16.5	30	2	14	14	58	11	44.5	58.5	58	M8 x 1.25 depth 16
63	Up to 1200	35	32	27	38	20	16.5	32	2	14	14	58	11	45	59	72	M10 x 1.5 depth 16
80	Up to 1400	40	37	32	50	25	19	40	3	20	20	71	13	53.5	68	89	M10 x 1.5 depth 22
100	Up to 1500	40	37	41	60	30	20	50	3	20	20	71	16	64.5	79	110	M12 x 1.75 depth 22

Bore size (mm)	K	KA	MM	MO	NA	P	RF	S	TA	TC	TD	TE	TF	TG	WL	ZZ
20	5	6	M8 x 1.25	15	24	1/8	11	81	11	M5 x 0.8	$8^{+0.08}_0$	4	0.5	5.5	15	118
25	5.5	8	M10 x 1.25	15	29	1/8	11	81	11	M6 x 0.75	$10^{+0.08}_0$	5	1	6.5	15	123
32	5.5	10	M10 x 1.25	15	35.5	1/8	11	81	11	M8 x 1.0	$12^{+0.08}_0$	5.5	1	7.5	24	123
40	6	14	M14 x 1.5	19	44	1/8	11	92	12	M10 x 1.25	$14^{+0.08}_0$	6	1.25	8.5	24	144
50	7	18	M18 x 1.5	19	55	1/4	11	107	13	M12 x 1.25	$16^{+0.08}_0$	7.5	2	10	24	167
63	7	18	M18 x 1.5	19	69	1/4	11	107	13	M14 x 1.5	$18^{+0.08}_0$	11.5	3	14.5	24	167
80	10	22	M22 x 1.5	23	80	3/8	21	130	—	—	—	—	—	—	40	204
100	10	26	M26 x 1.5	23	100	1/2	21	130	—	—	—	—	—	—	40	204

Rubber Bumper Type: CBG1BN

Rod end lock: CBG1BN - - R

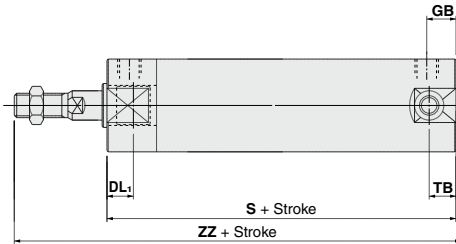

Bore size (mm)	DL1	GB	S	TB	ZZ
20	19.5	10 (12)	80 (88)	11	117 (125)
25	19.5	10 (12)	80 (88)	11	122 (130)
32	20	10 (12)	81 (89)	10 (11)	123 (131)
40	19	10 (13)	87 (96)	10 (12)	139 (148)
50	23.5	12 (14)	102 (114)	12 (13)	162 (174)
63	23.5	12 (14)	102 (114)	12 (13)	162 (174)
80	27	16 (20)	124 (138)	—	198 (212)
100	30	16 (20)	124 (138)	—	198 (212)

* (): Denotes the dimensions for long stroke.

Double end lock: CBG1BN - - W

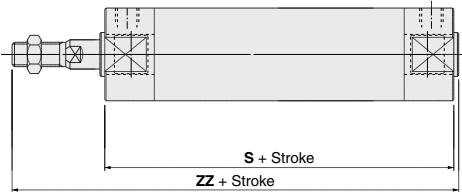

Bore size (mm)	S	ZZ
20	92	129
25	92	134
32	91	133
40	101	153
50	119	179
63	119	179
80	146	220
100	146	220

With rod boot

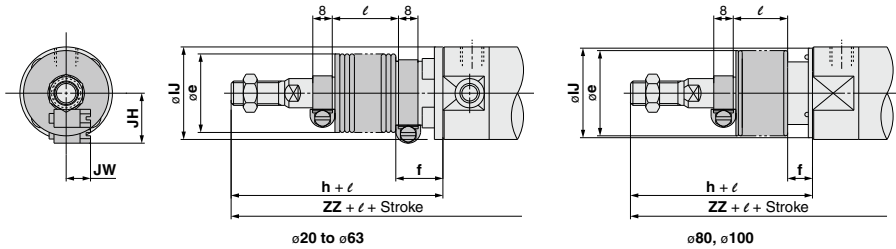

ø20 to ø63

ø80, ø100

Bore size (mm)	e	f	h	IJ	JH (Reference)	JW (Reference)	ℓ	(mm)		
								Head end lock (-HC)	Rod end lock (-RC)	Double end lock (-WC)
							ZZ	ZZ	ZZ	
20	30	18	55	27	15.5	10.5	1/4 stroke	138	137 (145)	149
25	30	19	62	32	16.5	10.5		145	144 (152)	156
32	35	19	62	38	18.5	10.5		145	145 (153)	155
40	35	19	70	48	21.5	10.5		164	159 (168)	173
50	40	19	78	59	24	10.5		187	182 (194)	199
63	40	20	78	72	24	10.5		187	182 (194)	199
80	52	10	80	59	—	—		213	207 (221)	229
100	62	7	80	71	—	—		213	207 (221)	229

* (): Denotes the dimensions for long strokes.

** The minimum stroke with rod boot is 20 mm.

CJ1

CJP

CJ2

-Z

CJ2

CM2

-Z

CM2

CM3

CG1

-Z

CG1

CG3

MB

-Z

MB

MB1

CA2

-Z

CA2

CS1

CS2

CS2

D-

-X

Technical data

Series CBG1

Air Cushion Type: CBG1BA

Head end lock: CBG1BA Bore size Stroke -H

Rod end lock: CBG1BA Bore size Stroke -R

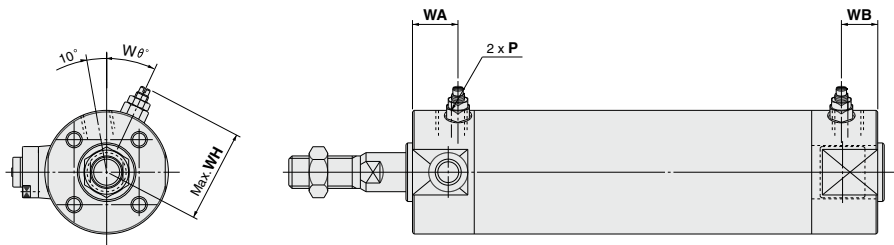

Head End Lock: -H

(mm)

Bore size (mm)	P	WA	WB	WH	Wθ
20	M5 x 0.8	16	16	23	30°
25	M5 x 0.8	16	16	25	30°
32	Rc 1/8	16	16	28.5	25°
40	Rc 1/8	16	16	33	20°
50	Rc 1/4	18	18	40.5	20°
63	Rc 1/4	18	18	47.5	20°
80	Rc 3/8	22	22	60.5	20°
100	Rc 1/2	22	22	71	20°

* For dimensions other than listed above, refer to the dimensions with rubber bumper.

Rod End Lock: -R

(mm)

Bore size (mm)	P	WA	WB	WH	Wθ
20	M5 x 0.8	16	15 (16)	23	30°
25	M5 x 0.8	16	15 (16)	25	30°
32	Rc 1/8	16	15 (16)	28.5	25°
40	Rc 1/8	16	15 (16)	33	20°
50	Rc 1/4	18	17 (18)	40.5	20°
63	Rc 1/4	18	17 (18)	47.5	20°
80	Rc 3/8	22	22	60.5	20°
100	Rc 1/2	22	22	71	20°

* (): Denotes the dimensions for long strokes.

** For dimensions other than the listed above, refer to the dimensions with rubber bumper.

With Mounting Bracket

(For dimensions other than listed below, refer to pages 356 to 358, 313 to 317.)

Axial foot style: CBG1L□

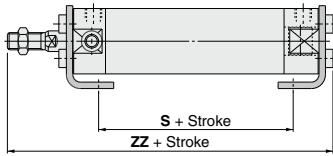

Rod side flange style: CBG1F□

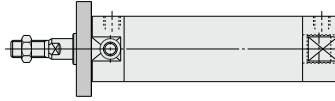

Head side flange style: CBG1G□

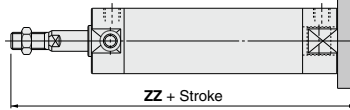

Foot Style

Bore size (mm)	Head end lock: -H□			Rod end lock: -R□			Double end lock: -W□		
	LS	ZZ		LS	ZZ		LS	ZZ	
	—	Without rod boot	With rod boot	—	Without rod boot	With rod boot	—	Without rod boot	With rod boot
20	57	122	142 + ℓ	56 (64)	121 (129)	141 (149) + ℓ	68	133	153 + ℓ
25	57	127.5	149.5 + ℓ	56 (64)	126.5 (134.5)	148.5 (156.5) + ℓ	68	138.5	160.5 + ℓ
32	55	127.5	149.5 + ℓ	55 (63)	127.5 (135.5)	149.5 (157.5) + ℓ	65	137.5	159.5 + ℓ
40	65	149	169 + ℓ	60 (69)	144 (153)	164 (173) + ℓ	74	158	178 + ℓ
50	72	174.5	194.5 + ℓ	67 (79)	169.5 (181.5)	189.5 (201.5) + ℓ	84	186.5	206.5 + ℓ
63	72	174.5	194.5 + ℓ	67 (79)	169.5 (181.5)	189.5 (201.5) + ℓ	84	186.5	206.5 + ℓ
80	82	210.5	219.5 + ℓ	76 (90)	204.5 (218.5)	213.5 (227.5) + ℓ	98	226.5	235.5 + ℓ
100	82	214	223 + ℓ	76 (90)	208 (222)	217 (231) + ℓ	98	230	239 + ℓ

* (): Denotes the dimensions for long stroke.

Rod Side Flange Style ... Overall length is the same as basic style.

Head Side Flange Style

Bore size (mm)	Head end lock: -H□		Rod end lock: -R□		Double end lock: -W□	
	ZZ (Head side flange)					
	Without rod boot	With rod boot	Without rod boot	With rod boot	Without rod boot	With rod boot
20	124	144 + ℓ	123	143 + ℓ	135	155 + ℓ
25	130	152 + ℓ	129	151 + ℓ	141	163 + ℓ
32	130	152 + ℓ	130	152 + ℓ	140	162 + ℓ
40	152	172 + ℓ	147 (156)	167 (176) + ℓ	161	181 + ℓ
50	176	196 + ℓ	171 (183)	191 (203) + ℓ	188	208 + ℓ
63	176	196 + ℓ	171 (183)	191 (203) + ℓ	188	208 + ℓ
80	215	224 + ℓ	209 (223)	218 (232) + ℓ	231	240 + ℓ
100	218	227 + ℓ	212 (226)	221 (235) + ℓ	234	243 + ℓ

* (): Denotes the dimensions for long stroke.

Rod side trunnion style: CBG1U□ (Rod end lock-H□ only)

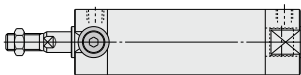

Head side trunnion style: CBG1T□ (Rod end lock -R□ only)

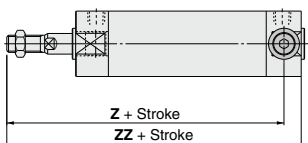

Rod Side Trunnion Style ... Overall length is the same as basic style.

Head Side Trunnion Style

Bore size (mm)	Rod end lock: -R□			
	Z (Head side trunnion)		ZZ (Head side trunnion)	
	Without rod boot	With rod boot	Without rod boot	With rod boot
20	104	124 + ℓ	117	137 + ℓ
25	109	131 + ℓ	122	144 + ℓ
32	111	133 + ℓ	123	145 + ℓ
40	127 (134)	147 (154) + ℓ	139 (148)	159 (168) + ℓ
50	148 (159)	168 (179) + ℓ	162 (174)	182 (194) + ℓ
63	148 (159)	168 (179) + ℓ	162 (174)	182 (194) + ℓ

* (): Denotes the dimensions for long stroke.

CG1

CGP

CG2
-Z

CG2

CM2
-Z

CM2

CM3

CG1
-Z

CG1

CG3

MB
-Z

MB

MB1

CA2
-Z

CA2

CS1

CS2

D-□

-X□

Technical data

Series CBG1

With Mounting Bracket

Clevis style: CBG1D□
 ø20 to ø63

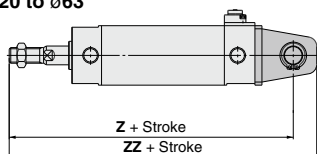

Clevis style: CBG1D□
 ø80 to ø100

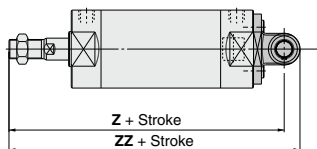

Clevis Style

(mm)

Bore size (mm)	Head end lock: -H□				Rod end lock: -R□			
	Z		ZZ		Z		ZZ	
	Without rod boot	With rod boot	Without rod boot	With rod boot	Without rod boot	With rod boot	Without rod boot	With rod boot
20	130	150 + ℓ	141	161 + ℓ	129	149 + ℓ	140	160 + ℓ
25	137	159 + ℓ	150	172 + ℓ	136	158 + ℓ	149	171 + ℓ
32	141	163 + ℓ	156	178 + ℓ	141	163 + ℓ	156	178 + ℓ
40	164	184 + ℓ	182	202 + ℓ	159 (168)	179 (188) + ℓ	177 (186)	197 (206) + ℓ
50	190	210 + ℓ	210	230 + ℓ	185 (197)	205 (217) + ℓ	205 (217)	225 (237) + ℓ
63	195	215 + ℓ	217	237 + ℓ	190 (202)	210 (222) + ℓ	212 (224)	232 (244) + ℓ
80	236	245 + ℓ	254	263 + ℓ	230 (244)	239 (253) + ℓ	248 (262)	257 (277) + ℓ
100	244	253 + ℓ	266	275 + ℓ	238 (252)	247 (261) + ℓ	260 (274)	269 (283) + ℓ

Bore size (mm)	Double end lock: -W□			
	Z		ZZ	
	Without rod boot	With rod boot	Without rod boot	With rod boot
20	141	161 + ℓ	152	172 + ℓ
25	148	170 + ℓ	161	183 + ℓ
32	151	173 + ℓ	166	188 + ℓ
40	173	193 + ℓ	191	211 + ℓ
50	202	222 + ℓ	222	242 + ℓ
63	207	227 + ℓ	229	249 + ℓ
80	252	261 + ℓ	270	279 + ℓ
100	260	269 + ℓ	282	291 + ℓ

* () : Denotes the dimensions for long stroke.



Series CBG1 Specific Product Precautions 1

Be sure to read before handling.

Refer to front matter 57 for Safety Instructions and pages 3 to 12 for Actuator and Auto Switch Precautions.

Use the Recommended Pneumatic Circuit

⚠ Caution

- This is necessary for proper operation and release of the lock.

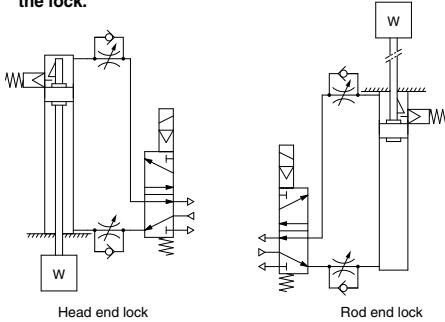

Operating Precautions

⚠ Caution

- Do not use 3 position solenoid valves.**
Avoid use in combination with 3 position solenoid valves (especially closed center metal seal types). If pressure is trapped in the port on the lock mechanism side, the cylinder cannot be locked. Furthermore, even after being locked, the lock may be released after some time, due to air leaking from the solenoid valve and entering the cylinder.
- Back pressure is required when releasing the lock.**
Be sure air is supplied to side of cylinder without the locking mechanism, as above, prior to supplying air pressure to the side with end lock or lock may not be released. (→ Refer to "Releasing the Lock".)
- Release the lock when mounting or adjusting the cylinder.**
If mounting or other work is performed when the cylinder is locked, the lock unit may be damaged.
- Operate with a load ratio of 50% or less.**
If the load ratio exceeds 50%, this may cause problems such as failure of the lock to release, or damage to the lock unit.
- Do not operate multiple cylinders in synchronization.**
Avoid applications in which two or more end lock cylinders are synchronized to move one workpiece, as one of the cylinder locks may not be able to release when required.
- Use a speed controller with meter-out control.**
Lock cannot be released occasionally by meter-in control.
- Be sure to operate completely to the cylinder stroke end on the side with the lock.**
If the cylinder piston does not reach the end of the stroke, locking and unlocking may not be possible.
- Do not use an air cylinder as an air-hydro cylinder.**
This could result in leakage of oil.
- Install a rod boot without twisting.**
If the cylinder is installed with its bellows twisted, it could damage the bellows.
- Adjust an auto switch position so that it operates for movement to both the stroke end and backlash (2 mm) positions.**
When a 2-color indication switch is adjusted for green indication at the stroke end, it may change to red for the backlash return, but this is not abnormal.

Operating Precautions

⚠ Warning

- Do not operate the cushion valve in the fully closed or fully opened state.**
Using it in the fully closed state will cause the cushion seal to be damaged. Using it in the fully opened state will cause the piston rod assembly or the cover to be damaged.
- Operate within the specified cylinder speed.**
Otherwise, cylinder and seal damage may occur.

Operating Pressure

⚠ Caution

- Use pressures over 0.15 MPa at port with locking mechanism. This is required to release the lock.

Exhaust Speed

⚠ Caution

- Locking will occur automatically if the pressure applied to the port on the lock mechanism side falls to 0.05 MPa or less. In cases where the piping on the lock mechanism side is long and thin, or the speed controller is separated at some distance from the cylinder port, the exhaust speed will be reduced. Take note that some time may be required for the lock to engage. In addition, clogging of a silencer mounted on the solenoid valve exhaust port can produce the same effect.

Relation to Cushion

⚠ Caution

- When cushion valve at side with locking mechanism is fully opened or closed, piston rod may reached at stroke end. Thus lock is not established. And when locking is done at cushion valve fully closed, adjust cushion valve since lock may not be released.

Releasing the Lock

⚠ Warning

- Before releasing the lock, be sure to supply air to the side without the lock mechanism, so that there is no load applied to the lock mechanism when it is released. (Refer to the recommended pneumatic circuits.) If the lock is released when the port on the other side is in an exhaust state, and with a load applied to the lock unit, the lock unit may be subjected to an excessive force and be damaged. Furthermore, sudden movement of the piston rod is very dangerous.

Disassembly/Replacement

⚠ Caution

- Do not replace the bushings or the cushion seals.**
The bushings are press-fit. To replace them, they must be replaced together with the cover assembly.
- To replace a seal, apply grease to the new seal before installing it.**
If the cylinder is put into operation without applying grease to the seal, it could cause the seal to wear significantly, leading to premature air leakage.
- Those with a bore of $\phi 50$ or more cannot be disassembled.**
When disassembling cylinders with bore sizes of $\phi 20$ through $\phi 40$, grip the double flat part of either the head cover or the rod cover with a vise and loosen the other side with a wrench or an adjustable angle wrench, etc., and then remove the cover.
When re-tightening, tighten approximately 2 degrees more than the original position. (Cylinders with $\phi 50$ or larger bore sizes are tightened with a large tightening torque and cannot be disassembled. Please contact SMC when disassembly is required.)

CJ1

CJP

CJ2
-Z

CJ2

CM2
-Z

CM2

CM3

CG1
-Z

CG1

CG3

MB
-Z

MB

MB1

CA2
-Z

CA2

CS1

CS2

D-□

-X□

Technical
data



Series CBG1 Specific Product Precautions 2

Be sure to read before handling.

Refer to front matter 57 for Safety Instructions and pages 3 to 12 for Actuator and Auto Switch Precautions.

Manual Release

⚠ Caution

1. Manual release non-lock type

Insert the accessory bolt from the top of the rubber cap (it is not necessary to remove the rubber cap), and after screwing it into the lock piston, pull it to release the lock. If you stop pulling the bolt, the lock will return to an operational state.

Thread sizes, pulling forces and strokes are as shown below.

Bore size (mm)	Thread size	Pulling force	Stroke (mm)
20, 25, 32	M2.5 x 0.45 x 25L or more	4.9N	2
40, 50, 63	M3 x 0.5 x 30L or more	10N	3
80, 100	M5 x 0.8 x 40L or more	24.5N	3

Remove the bolt for normal operation.

It can cause lock malfunction or faulty release.

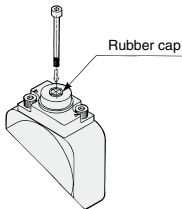

2. Manual release lock type

While pushing the M/O knob, turn it 90° counterclockwise. The lock is released (and remains in a released state) by aligning the ▲ mark on the cap with the ▼OFF mark on the M/O knob.

When locking is desired, turn the M/O knob 90° clockwise while pushing completely down, and align the ▲ mark on the cap with the ▼ ON mark on the M/O knob. The correct position is confirmed by a clicking sound.

Failure to click it into place properly can cause the lock to disengage.

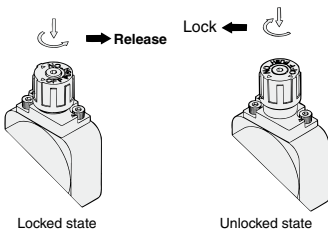

Working Principle

* The figures below are the same as those for Series CBA2.

● Head end lock (Rod end lock is the same.)

1. When the piston rod is getting closer to the stroke end, the taper part (*) of the piston rod edge will push the lock piston up.

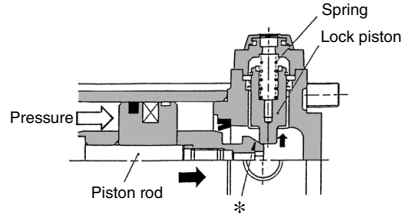

2. The lock piston is pushed up further.

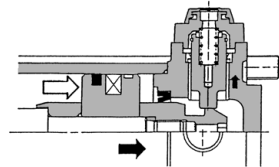

3. The lock piston is pushed up into the groove of the piston rod to lock it. (The lock piston is pushed up by spring force.) At this time, it is exhausted from the port on the head side and introduced into the atmosphere.

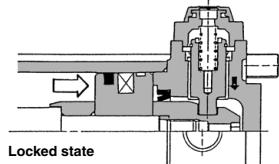

4. When pressure is supplied in the head side, lock piston will be pushed up to release the lock.

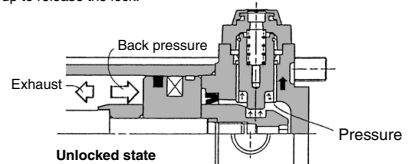

5. When the lock is released, the cylinder will move forward.

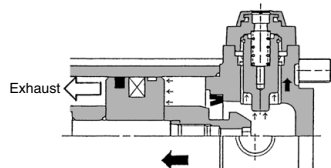

Auto Switch Mounting 1

Auto Switch Mounting Position (Detection at stroke end) and Its Mounting Height

Reed auto switch

D-A9□

ø20 to ø63

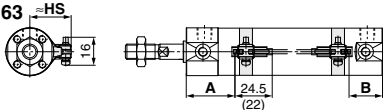

(): Dimension of the D-A96. A and B are the dimensions from the end of the head cover/rod cover to the end of the auto switch.

D-A9□V

ø20 to ø63

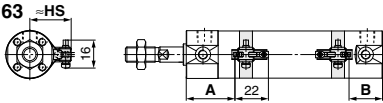

A and B are the dimensions from the end of the head cover/rod cover to the end of the auto switch.

D-C7, C8

ø20 to ø63

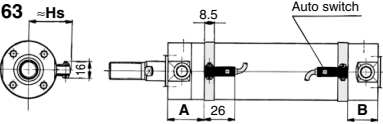

D-C73C, C80C

ø20 to ø63

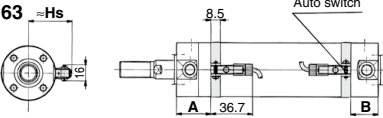

D-B5, B6, B59W

ø20 to ø100

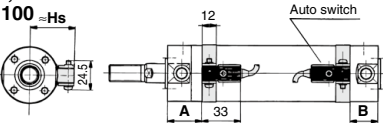

Solid state auto switch

D-M9□/D-M9□W/D-M9□A

ø20 to ø63

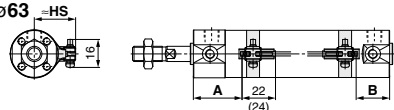

(): Dimension of the D-M9□A. A and B are the dimensions from the end of the head cover/rod cover to the end of the auto switch.

D-M9□V, M9□WV/D-M9□AV

ø20 to ø63

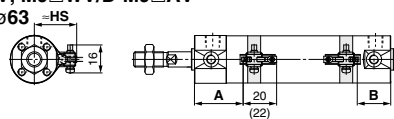

(): Dimension of the D-M9□AV. A and B are the dimensions from the end of the head cover/rod cover to the end of the auto switch.

D-G5, K5, G5□W, G5BA/D-K59W, D-G59F, D-G5NT

ø20 to ø100

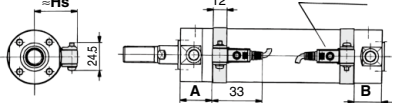

D-H7□, H7□W/D-H7NF, H7BA

ø20 to ø63

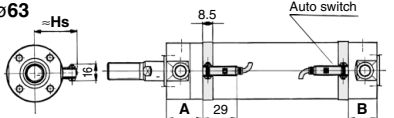

D-H7C

ø20 to ø63

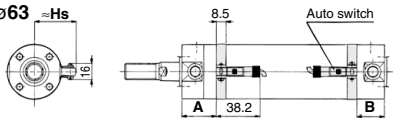

Auto Switch Mounting Position /

Except Single Acting/Direct Mount Type (CG1R, CG1KR), End Lock Cylinder (CBG1) (mm)

Auto switch model	D-M9□		D-M9□V		D-C7/C8		D-B5		D-B59W		D-H7□		D-H7□W		D-H7C	
	D-A9□	D-A9□V	D-M9□	D-M9□A	D-C73C	D-C80C	D-B6		A	B	A	B	A	B	A	B
20	29	20 (28)	33	24 (32)	29.5	20.5 (28.5)	23.5	14.5 (22.5)	26.5	17.5 (25.5)	28.5	19.5 (27.5)	25	16 (24)		
25	29	20 (28)	33	24 (32)	29.5	20.5 (28.5)	23.5	14.5 (22.5)	26.5	17.5 (25.5)	28.5	19.5 (27.5)	25	16 (24)		
32	30	21 (29)	34	25 (33)	30.5	21.5 (29.5)	24.5	15.5 (23.5)	27.5	18.5 (26.5)	29.5	20.5 (28.5)	26	17 (25)		
40	35	23 (32)	39	27 (36)	35.5	23.5 (32.5)	29.5	17.5 (26.5)	32	20.5 (29.5)	34.5	22.5 (31.5)	31	19 (28)		
50	42	28 (40)	46	32 (44)	42.5	28.5 (40.5)	36.5	22.5 (34.5)	39.5	25.5 (37.5)	41.5	27.5 (39.5)	38	24 (36)		
63	42	28 (40)	46	32 (44)	42.5	28.5 (40.5)	36.5	22.5 (34.5)	39.5	25.5 (37.5)	41.5	27.5 (39.5)	38	24 (36)		
80	—	—	—	—	—	—	46.5	30.5 (44.5)	49.5	33.5 (47.5)	—	—	48	32 (46)		
100	—	—	—	—	—	—	46.5	30.5 (44.5)	49.5	33.5 (47.5)	—	—	48	32 (46)		

Operating Range

Auto switch model	D-C7/C8		D-G5□W		D-B5/B6		D-G5NT	
	D-H7□W	D-H7NF	D-H7BA	D-A9□V	D-M9□W	D-M9□A	D-C73C	D-C80C
20	Hs	Hs	Hs	Hs	Hs	Hs	Hs	Hs
20	25.5	24.5	27	27.5	27.5	27.5	27.5	27.5
25	28	27	29.5	30	30	30	30	30
32	31.5	30.5	33	33.5	33.5	33.5	33.5	33.5
40	36	35	37.5	38	38	38	38	38
50	41.5	40.5	43	43.5	43.5	43.5	43.5	43.5
63	48.5	47.5	50	50.5	50.5	50.5	50.5	50.5
80	—	—	—	—	—	—	—	—
100	—	—	—	—	—	—	—	—

Note 1) Figures in parentheses are for the long stroke, double rod type.

Note 2) In the actual setting, adjust them after confirming the auto switch operating condition.

CG1

CGP

CG2
-Z

CG2

CM2
-Z

CM2

CM3

CG1
-Z

CG1

CG3

MB
-Z

MB

MB1

CA2
-Z

CA2

CS1

CS2

D-□

-X□

Technical data

Auto Switch Mounting 2

Proper Auto Switch Mounting Position (Detection at stroke end) Single Acting, Spring Return Type (S)/Spring Extend Type (T)

Proper Auto Switch Mounting Position: Single Acting/Spring Return Type (S)

(mm)

Auto switch model	Bore size	A Dimensions							B
		Up to 25 st	26 to 50 st	51 to 75 st	76 to 100 st	101 to 125 st	126 to 150 st	151 to 200 st	
D-A9□ (V)	20	54	54	79	79	104	—	—	20
	25	54	54	79	79	104	129	129	20
	32	55	55	80	80	105	130	130	21
	40	59.5	59.5	84.5	84.5	109.5	134.5	134.5	23
D-M9□ (V) D-M9□W (V) D-M9□A (V)	20	58	58	83	83	108	—	—	24
	25	58	58	83	83	108	133	133	24
	32	59	59	84	84	109	134	134	25
	40	63.5	63.5	88.5	88.5	113.5	138.5	138.5	27
D-C7 D-C8 D-C73C D-C80C	20	54.5	54.5	79.5	79.5	104.5	—	—	20.5
	25	54.5	54.5	79.5	79.5	104.5	129.5	129.5	20.5
	32	55.5	55.5	80.5	80.5	105.5	130.5	130.5	21.5
	40	60	60	85	85	110	135	135	23.5
D-H7□W D-H7□ D-H7C D-H7BA D-H7NF	20	53.5	53.5	78.5	78.5	103.5	—	—	19.5
	25	53.5	53.5	78.5	78.5	103.5	128.5	128.5	19.5
	32	54.5	54.5	79.5	79.5	109.5	129.5	129.5	20.5
	40	59	59	84	84	109	134	134	22.5
D-B5 D-B6	20	48.5	48.5	73.5	73.5	98.5	—	—	14.5
	25	48.5	48.5	73.5	73.5	98.5	123.5	123.5	14.5
	32	49.5	49.5	74.5	74.5	99.5	124.5	124.5	15.5
	40	54	54	79	79	104	129	129	17.5
D-G5NT D-G59F	20	50	50	75	75	100	—	—	16
	25	50	50	75	75	100	125	125	16
	32	51	51	76	76	101	126	126	17
	40	55.5	55.5	80.5	80.5	105.5	130.5	130.5	19
D-B59W	20	51.5	51.5	76.5	76.5	101.5	—	—	17.5
	25	51.5	51.5	76.5	76.5	101.5	126.5	126.5	17.5
	32	52.5	52.5	77.5	77.5	102.5	127.5	127.5	18.5
	40	56.5	56.5	81.5	81.5	106.5	131.5	131.5	20.5

Note) In the actual setting, adjust them after confirming the auto switch operating condition.

Proper Auto Switch Mounting Position: Single Acting/Spring Extend Type (T)

(mm)

Auto switch model	Bore size	A	B Dimensions						
			Up to 25 st	26 to 50 st	51 to 75 st	76 to 100 st	101 to 125 st	126 to 150 st	151 to 200 st
D-A9□ (V)	20	29	45	45	70	70	95	—	—
	25	29	45	45	70	70	95	120	120
	32	30	46	46	71	71	96	121	121
	40	35	47.5	47.5	72.5	72.5	97.5	122.5	122.5
D-M9□ (V) D-M9□W (V) D-M9□A (V)	20	33	49	49	74	74	99	—	—
	25	33	49	49	74	74	99	124	124
	32	34	50	50	75	75	100	125	125
	40	39	51.5	51.5	76.5	76.5	101.5	126.5	126.5
D-C7 D-C8 D-C73C D-C80C	20	29.5	45.5	45.5	70.5	70.5	95.5	—	—
	25	29.5	45.5	45.5	70.5	70.5	95.5	120.5	120.5
	32	30.5	46.5	46.5	71.5	71.5	96.5	121.5	121.5
	40	35.5	48	48	73	73	98	123	123
D-H7□W D-H7□ D-H7C D-H7BA D-H7NF	20	28.5	44.5	44.5	69.5	69.5	94.5	—	—
	25	28.5	44.5	44.5	69.5	69.5	94.5	119.5	119.5
	32	29.5	45.5	45.5	70.5	70.5	95.5	120.5	120.5
	40	34.5	47	47	72	72	97	122	122
D-B5 D-B6	20	23.5	39.5	39.5	64.5	64.5	89.5	—	—
	25	23.5	39.5	39.5	64.5	64.5	89.5	114.5	114.5
	32	24.5	40.5	40.5	65.5	65.5	90.5	115.5	115.5
	40	29.5	42	42	67	67	92	117	117
D-G5NT D-G59F	20	25	41	41	66	66	91	—	—
	25	25	41	41	66	66	91	116	116
	32	26	42	42	67	67	92	117	117
	40	31	43.5	43.5	68.5	68.5	93.5	118.5	118.5
D-B59W	20	26.5	42.5	42.5	67.5	67.5	92.5	—	—
	25	26.5	42.5	42.5	67.5	67.5	92.5	117.5	117.5
	32	27.5	43.5	43.5	68.5	68.5	93.5	118.5	118.5
	40	32	45	45	70	70	95	120	120

Note) In the actual setting, adjust them after confirming the auto switch operating condition.

Proper Auto Switch Mounting Position (Detection at stroke end)

Proper Auto Switch Mounting Position: Direct Mount Type (CG1R, CG1KR)

(mm)

Auto switch model	D-A9□ D-A9□V		D-M9□ D-M9□V D-M9□W D-M9□WV D-M9□A D-M9□AV		D-C7 D-C8 D-C73C D-C80C		D-B5 D-B6		D-B59W		D-H7□W D-H7NF D-H7BA D-H7□ D-H7C		D-G59F D-G5NT	
	A	B	A	B	A	B	A	B	A	B	A	B	A	B
20	8	20	12	24	8.5	20.5	2.5	14.5	5.5	17.5	7.5	19.5	4	16
25	8	20	12	24	8.5	20.5	2.5	14.5	5.5	17.5	7.5	19.5	4	16
32	9	21	13	25	9.5	21.5	3.5	15.5	6.5	18.5	8.5	20.5	5	17
40	14	23	18	27	14.5	23.5	8.5	17.5	11.5	20.5	13.5	22.5	10	19
50	16	28	20	32	16.5	28.5	10.5	22.5	13.5	25.5	17.5	27.5	14	24
63	16	28	20	32	16.5	28.5	10.5	22.5	13.5	25.5	17.5	27.5	14	24

Note) In the actual setting, adjust them after confirming the auto switch operating condition.

Proper Auto Switch Mounting Position: End Lock Cylinder (CBG1)

(mm)

Auto switch model	Locking position	D-A9□ D-A9□V		D-M9□ D-M9□V D-M9□W D-M9□WV D-M9□A D-M9□AV		D-C7 D-C8 D-C73C D-C80C		D-B5 D-B6		D-B59W		D-H7□ D-H7C D-H7□W D-H7BA D-H7NF		D-G5□W D-K59W D-G59F D-G5 D-K5 D-G5NT D-G5BA	
		A	B	A	B	A	B	A	B	A	B	A	B	A	B
20	Head side	29	32	33	36	29.5	32.5	23.5	26.5	26.5	29.5	28.5	31.5	25	28
	Rod side	40	20 (28)	44	24 (32)	40.5	20.5 (28.5)	34.5	14.5 (22.5)	37.5	17.5 (25.5)	39.5	19.5 (27.5)	36	16 (24)
	Double sides	40	32	44	36	40.5	32.5	34.5	26.5	37.5	29.5	39.5	31.5	36	28
25	Head side	29	32	33	36	29.5	32.5	23.5	26.5	26.5	29.5	28.5	31.5	25	28
	Rod side	40	20 (28)	44	24 (32)	40.5	20.5 (28.5)	34.5	14.5 (22.5)	37.5	17.5 (25.5)	39.5	19.5 (27.5)	36	16 (24)
	Double sides	40	32	44	36	40.5	32.5	34.5	26.5	37.5	29.5	39.5	31.5	36	28
32	Head side	30	31	34	35	30.5	31.5	24.5	25.5	27.5	28.5	29.5	30.5	26	27
	Rod side	40	21 (29)	44	25 (33)	40.5	21.5 (29.5)	34.5	15.5 (23.5)	37.5	18.5 (26.5)	39.5	20.5 (28.5)	36	17 (25)
	Double sides	40	31	44	35	40.5	31.5	34.5	25.5	37.5	28.5	39.5	30.5	36	27
40	Head side	35	37	39	41	35.5	37.5	29.5	31.5	32	34.5	34.5	36.5	31	33
	Rod side	44	23 (32)	48	27 (36)	44.5	23.5 (32.5)	38.5	17.5 (26.5)	41	20.5 (29.5)	43.5	22.5 (31.5)	40	19 (28)
	Double sides	44	37	48	41	44.5	37.5	38.5	31.5	41	34.5	43.5	36.5	40	33
50	Head side	42	45	46	49	42.5	45.5	36.5	39.5	39.5	42.5	41.5	44.5	38	41
	Rod side	54	28 (40)	58	32 (44)	54.5	28.5 (40.5)	48.5	22.5 (34.5)	51.5	25.5 (37.5)	53.5	27.5 (39.5)	50	24 (36)
	Double sides	54	45	58	49	54.5	45.5	48.5	39.5	51.5	42.5	53.5	44.5	50	41
63	Head side	42	45	46	49	42.5	45.5	36.5	39.5	39.5	42.5	41.5	44.5	38	41
	Rod side	54	28 (40)	58	32 (44)	54.5	28.5 (40.5)	48.5	22.5 (34.5)	51.5	25.5 (37.5)	53.5	27.5 (39.5)	50	24 (36)
	Double sides	54	45	58	49	54.5	45.5	48.5	39.5	51.5	42.5	53.5	44.5	50	41
80	Head side	—	—	—	—	—	—	—	—	46.5	52.5	49.5	55.5	—	—
	Rod side	—	—	—	—	—	—	—	—	62.5	30.5 (44.5)	65.5	33.5 (47.5)	64	32 (46)
	Double sides	—	—	—	—	—	—	—	—	62.5	52.5	65.5	55.5	64	54
100	Head side	—	—	—	—	—	—	—	—	46.5	52.5	49.5	55.5	—	—
	Rod side	—	—	—	—	—	—	—	—	62.5	30.5 (44.5)	65.5	33.5 (47.5)	64	32 (46)
	Double sides	—	—	—	—	—	—	—	—	62.5	52.5	65.5	55.5	64	54

Note 1) Figures in parentheses are for the long stroke type.

Note 2) In the actual setting, adjust them after confirming the auto switch operating condition.

CG1

CGP

CG2

CG2

CG2

CG2

CG2

CG3

CG1

CG1

CG3

MB

MB

MB1

CA2

CA2

CA2

CS1

CS2

D-□

-X□

Technical data

Auto Switch Mounting 3

Minimum Auto Switch Mounting Stroke

Auto switch model	No. of auto switch mounted				
	1	2		n	
		Different surfaces	Same surface	Different surfaces	Same surface
D-M9□	5	15 <small>Note 1)</small>	40 <small>Note 1)</small>	$20 + 35 \frac{(n-2)}{2}$ <small>(n = 2, 4, 6...)</small> <small>Note 3)</small>	$55 + 35 (n-2)$ <small>(n = 2, 3, 4, 5...)</small>
D-M9□W	10	15 <small>Note 1)</small>	40 <small>Note 1)</small>	$20 + 35 \frac{(n-2)}{2}$ <small>(n = 2, 4, 6...)</small> <small>Note 3)</small>	$55 + 35 (n-2)$ <small>(n = 2, 3, 4, 5...)</small>
D-M9□A	10	25	40 <small>Note 1)</small>	$25 + 35 \frac{(n-2)}{2}$ <small>(n = 2, 4, 6...)</small> <small>Note 3)</small>	$60 + 35 (n-2)$ <small>(n = 2, 3, 4, 5...)</small>
D-M9□V	5	20	35	$20 + 35 \frac{(n-2)}{2}$ <small>(n = 2, 4, 6...)</small> <small>Note 3)</small>	$35 + 35 (n-2)$ <small>(n = 2, 3, 4, 5...)</small>
D-A9□V	5	15	25	$15 + 35 \frac{(n-2)}{2}$ <small>(n = 2, 4, 6...)</small> <small>Note 3)</small>	$25 + 35 (n-2)$ <small>(n = 2, 3, 4, 5...)</small>
D-M9□WV D-M9□AV	10	20	35	$20 + 35 \frac{(n-2)}{2}$ <small>(n = 2, 4, 6...)</small> <small>Note 3)</small>	$35 + 35 (n-2)$ <small>(n = 2, 3, 4, 5...)</small>
D-C7□ D-C80	10	15	50	$15 + 45 \frac{(n-2)}{2}$ <small>(n = 2, 4, 6...)</small> <small>Note 3)</small>	$50 + 45 (n-2)$ <small>(n = 2, 3, 4, 5...)</small>
D-H7□ D-H7□W D-H7BA D-H7NF	10	15	60	$15 + 45 \frac{(n-2)}{2}$ <small>(n = 2, 4, 6...)</small> <small>Note 3)</small>	$60 + 45 (n-2)$ <small>(n = 2, 3, 4, 5...)</small>
D-C73C D-C80C	10	15	65	$15 + 50 \frac{(n-2)}{2}$ <small>(n = 2, 4, 6...)</small> <small>Note 3)</small>	$65 + 50 (n-2)$ <small>(n = 2, 3, 4, 5...)</small>
D-B5□ D-B64 D-G5□ D-K59□	10	15	75	$15 + 50 \frac{(n-2)}{2}$ <small>(n = 2, 4, 6...)</small> <small>Note 3)</small>	$75 + 55 (n-2)$ <small>(n = 2, 3, 4, 5...)</small>
D-B59W	15	20	75	$20 + 50 \frac{(n-2)}{2}$ <small>(n = 2, 4, 6...)</small> <small>Note 3)</small>	$75 + 55 (n-2)$ <small>(n = 2, 3, 4, 5...)</small>

Note 3) When "n" is an odd number, an even number that is one larger than this odd number is used for the calculation.

Note 1) Auto switch mounting

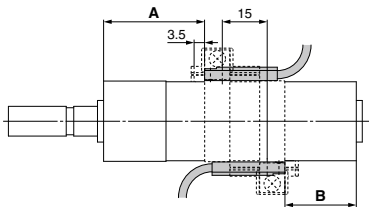
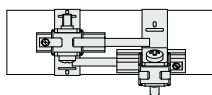
Auto switch model	With 2 auto switches	
	Different surfaces	Same surface
	 <p>Correct auto switch mounting position is 3.5 mm from the back face of the switch holder.</p>	 <p>The auto switch is mounted by slightly displacing it in a direction (cylinder tube circumferential exterior) so that the auto switch and lead wire do not interfere with each other.</p>
D-M9□ D-M9□W	Less than 20 stroke <small>Note 2)</small>	Less than 55 stroke <small>Note 2)</small>
D-M9□A	Less than 20 stroke <small>Note 2)</small>	Less than 60 stroke <small>Note 2)</small>
D-A9□	—	Less than 50 stroke <small>Note 2)</small>

Note 2) Minimum stroke for mounting auto switches in the other mounting styles mentioned in Note 1.

Operating Range

Auto switch model	Bore size (mm)							
	20	25	32	40	50	63	80	100
D-A9□ (V)	7	6	8	8	8	9	—	—
D-M9□ (V) D-M9□W (V) D-M9□A (V)	4.5	5.0	4.5	5.5	5.0	5.5	—	—
D-C7/C80 D-C73C/C80C	8	10	9	10	10	11	—	—
D-B5□/B64 D-B59W	8	10	9	10	10	11	11	11
D-H7□/H7□W D-H7NF/H7BA	4	4	4.5	5	6	6.5	—	—
D-H7C	7	8.5	9	10	9.5	10.5	—	—
D-G5□/G5□W/G59F D-G5BA/K59/K59W	4	4	4.5	5	6	6.5	6.5	7
D-G5NT	4	4	4.5	5	6	6.5	6.5	7
D-G5NB	35	40	40	45	45	45	45	50

* Since this is a guideline including hysteresis, not meant to be guaranteed. (Assuming approximately ±30% dispersion.)
There may be the case it will vary substantially depending on an ambient environment.

Auto Switch Mounting Bracket: Part No.

Auto switch model	Bore size (mm)							
	ø20	ø25	ø32	ø40	ø50	ø63	ø80	ø100
D-M9□ (V) D-M9□W (V) D-A9□ (V)	Note 1) BMA3-020	Note 1) BMA3-025	Note 1) BMA3-032	Note 1) BMA3-040	Note 1) BMA3-050	Note 1) BMA3-063	—	—
D-M9□A (V)	Note 2) BMA3-020S	Note 2) BMA3-025S	Note 2) BMA3-032S	Note 2) BMA3-040S	Note 2) BMA3-050S	Note 2) BMA3-063S	—	—
D-C7□/C80 D-C73C/C80C D-H7□ D-H7□W D-H7NF	BMA2-020A	BMA2-025A	BMA2-032A	BMA2-040A	BMA2-050A	BMA2-063A	—	—
D-H7BAL	BMA2-020AS	BMA2-025AS	BMA2-032AS	BMA2-040AS	BMA2-050AS	BMA2-063AS	—	—
D-B5□/B64 D-B59W D-G5□/K59 D-G5□W/K59W D-G5BA/G59F D-G5NT D-G5NB	BA-01	BA-02	BA-32	BA-04	BA-05	BA-06	BA-08	BA-10

Note 1) Set part number which includes the auto switch mounting band (BMA2-□□□A) and the holder kit (BJ5-1/Switch bracket: Transparent).

Note 2) Set part number which includes the auto switch mounting band (BMA2-□□□AS/Stainless steel screw) and the holder kit (BJ4-1/Switch bracket: White).

Note 3) For the D-M9□A (V) type auto switch, do not install the switch bracket on the indicator light.

[Stainless Steel Mounting Screw Kit]

The following stainless steel mounting screw kit is available. Use it in accordance with the operating environment. (Since the auto switch mounting bracket is not included, order it separately.)

BBA3: For D-B5/B6/G5/K5 types

Note 3) Refer to pages 1655 and 1656 for details on the BBA3.

The above stainless steel screws are used when a cylinder is shipped with the G5BA auto switch. When only an auto switch is shipped independently, the BBA3 is attached.

(1) BMA2-□□□A (S) is a set of "c" and "d" in the figure.

(2) BJ□-1 is a set of "a" and "b" in the figure.

BJ4-1 (Switch bracket: White)

BJ5-1 (Switch bracket: Transparent)

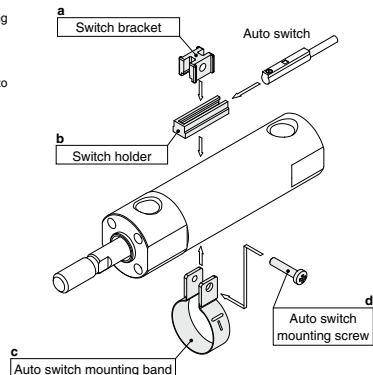

CG1

CGP

CG2-Z

CG2

CM2-Z

CM2

CM3

CG1-Z

CG1

CG3

MB-Z

MB

MB1

CA2-Z

CA2

CS1

CS2

D-□







-X□

Technical data

Auto Switch Mounting 4

Cylinder Bracket, by Stroke/Auto Switch Mounting Surfaces

st: Stroke (mm)

Auto switch model	Basic style, Foot style, Flange style, Clevis style			Trunnion style		
	1 (Rod cover side)	2 (Different surfaces)	2 (Same surface)	1 (Rod cover side)	2 (Different surfaces)	2 (Same surface)
Switch mounting surface	Port surface 	Port surface 	Port surface 			
Switch type						
D-A9□ (V) D-M9□ (V) D-M9□W (V) D-M9□A (V)	10 st or more	15 to 44 st	45 st or more	10 st or more	15 to 44 st	45 st or more
D-C7/C8	10 st or more	15 to 49 st	50 st or more	10 st or more	15 to 49 st	50 st or more
D-H7□/H7□W D-H7BA/H7NF	10 st or more	15 to 59 st	60 st or more	10 st or more	15 to 59 st	60 st or more
D-C73C/C80C/H7C	10 st or more	15 to 64 st	65 st or more	10 st or more	15 to 64 st	65 st or more
D-B5/B6/G5/K5 D-G5□W/K59W/G5BA D-G59F/G5NT	10 st or more	15 to 74 st	75 st or more	10 st or more	15 to 74 st	75 st or more
D-B59W	15 st or more	20 to 74 st	75 st or more	15 st or more	20 to 74 st	75 st or more

* Trunnion style is not available for bore sizes ø80 and ø100.

Other than the applicable auto switches listed in "How to Order", the following auto switches can be mounted. For detailed specifications, refer to pages 1559 to 1673.

Type	Model	Electrical entry	Features	Applicable bore size
Reed auto switch	D-H7A1, H7A2, H7B	Grommet (In-line)	—	ø20 to ø63
	D-H7NW, H7PW, H7BW		Diagnostic indication (2-color indication)	
	D-H7BA		Water resistant (2-color indication)	
	D-G5NT		With timer	ø20 to ø100
Solid state auto switch	D-B53	Grommet (In-line)	—	ø20 to ø63
	D-C73, C76		—	
	D-C80		Without indicator light	ø20 to ø63

* For solid state auto switches, auto switches with a pre-wired connector are also available. Refer to pages 1626 and 1627 for details.

* Normally closed (NC = b contact) solid state auto switches (D-F9G/F9H types) are also available. Refer to page 1577 for details

* Wide range detection type, solid state switches (D-G5NB type) are also available. Refer to page 1619 for details.