

Stainless Steel Cylinder

Series CJ5-S Series CG5-S

ø10, ø16

ø20, ø25, ø32, ø40, ø50, ø63, ø80, ø100

Applicable for use in an environment with water splashing such as food processing, etc.

CJ5
CG5

HY

Water
Resistant

For use with grease for food processing machines (Approved by NSF-H1)

All stainless steel specifications (External parts)

Stainless steel 304 is used for external metal parts. Corrosion resistance is improved even in environments with exposure to water.

Special scraper (Standard)

Prevents water from entering the cylinder.

Relation of Liquid Entry and Sliding Distance

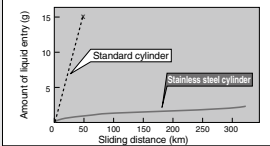

Conditions

Working fluid Air
 Pressure 0.5 MPa
 Liquid Water-soluble coolant
 Piston speed 200 mm/s
 Operating frequency... 60 cpm



Special scraper

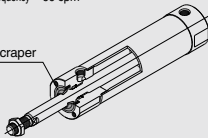

Exterior configuration reduces residual liquid

- Electropolishing of mounting bracket surfaces makes them smoother to prevent build-up of liquids and foreign matter.
- Plugs are provided for unused mounting threads (Series CG5-S) to prevent residue build-up in the threads.

Two types of seal material

(Nitrile rubber) (Fluororubber)

NBR or FKM can be selected to accommodate the application.

Can be disassembled (Series CG5-S ø20 to 40)

Since seals are replaceable, this extends the life of the cylinder.

(Before disassembly, be sure to refer to the section regarding maintenance under "Specific Product Precautions" on page 1072.)



This product cannot be used in the food zone. Refer to the Product Specific Precautions (page 1071) for details.

Series Variations

Series	Seal material	Bore size (mm)									Applicable auto switch		
		10	16	20	25	32	40	50	63	80		100	
CJ5-S	NBR	●	●										Water resistant D-H7BAL
CG5-S	FKM			●	●	●	●	●	●	●	●	●	Water resistant D-G5BAL

D-

-X

Technical data

Stainless Steel Cylinder

Series CJ5-S

ø10, ø16

How to Order

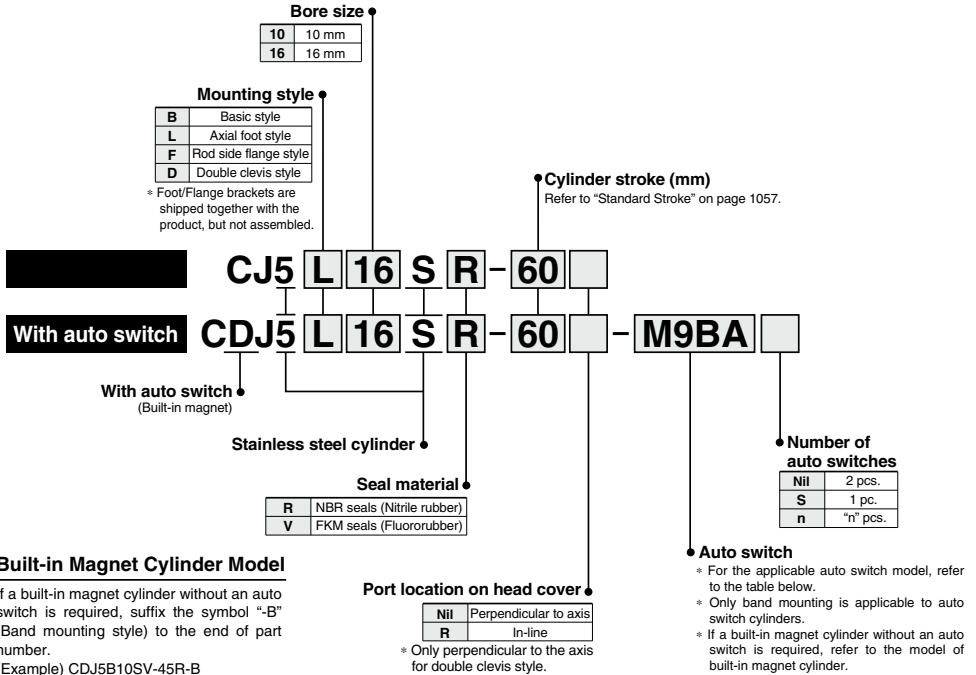

Applicable Auto Switches

Refer to pages 1559 to 1673 for further information on auto switches.

Type	Special function	Electrical entry	Indicator light	Wiring (Output)	Load voltage		Auto switch model		Lead wire length (m)*					Pre-wired connector	Applicable load	
					DC		Band mounting(ø10, ø16)		0.5	1	3	5	IC circuit		Relay, PLC	
					24 V	5 V, 12 V	Perpendicular	In-line	(Nil)	(M)	(L)	(Z)				
Solid state auto switch	Water resistant (2-color indication)	Grommet	Yes	3-wire(NPN)	24 V	5 V, 12 V	M9NAV	M9NA	○	○	●	○	○	—		
				3-wire(PNP)			M9PAV	M9PA	○	○	●	○				
				2-wire			M9BAV	M9BA	○	○	●	○				

* Lead wire length symbols: Nil0.5 m (Example) D-M9NA
M1 m (Example) D-M9NAM
L3 m (Example) D-M9NAL
Z5 m (Example) D-M9NAZ

* Solid state auto switches marked with "○" are produced upon receipt of order.

* For details about auto switches with pre-wired connector, refer to pages 1626 and 1627.

Mounting Bracket Part No.

Mounting bracket	Bore size (mm)		Description
	10	16	
Foot	CJ-L016 Stainless steel	CJK-L016 Stainless steel	Foot x 1
Flange	CJ-F016 Stainless steel	CJK-F016 Stainless steel	Flange x 1
T-bracket*	CJ-T010 Stainless steel	CJ-T016 Stainless steel	T-bracket x 1

* T-bracket is applicable to the double clevis style (D).

Grease pack for stainless steel cylinders/Part no.: GR-R-010 (10 g)

Specifications



Symbol

Double acting,
Single rod, Rubber bumper

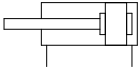

Bore size (mm)	10	16
Action	Double acting, Single rod	
Fluid	Air	
Proof pressure	1 MPa	
Maximum operating pressure	0.7 MPa	
Minimum operating pressure	0.1 MPa	
Ambient and fluid temperature	Without auto switch: -10 to 70°C With auto switch: -10 to 60°C	
Cushion	Rubber bumper	
Lubrication	Not required (Non-Lube)	
Stroke length tolerance	+1.0 0	
Piston speed	50 to 750 mm/s	
Allowable kinetic energy	0.035 J	0.090 J
Mounting style	Basic style, Axial foot style, Rod side flange style, Double clevis style	

CJ5
CG5

HY□

Water
Resistant

Standard Stroke

(mm)

Bore size (mm)	Standard stroke	Maximum manufacturable stroke
10	15, 30, 45, 60, 75, 100, 125, 150	400
16	15, 30, 45, 60, 75, 100, 125, 150, 175, 200	

* Manufacture of intermediate strokes at 1 mm intervals is possible. (Spacers are not used.)

* For the one with auto switch, refer to the minimum stroke for auto switch mounting. (P. 1069)

Mounting Style and Accessory

●: Supplied with the product. ○: Please order separately.

Mounting		Basic style	Axial foot style	Rod side flange style	Double clevis style *
Standard equipment	Mounting nut	●	●	●	—
	Rod end nut	●	●	●	●
	Clevis pin	—	—	—	●
Option	Single knuckle joint	○	○	○	○
	Double knuckle joint (With pin) *	○	○	○	○
	T-bracket	—	—	—	○
	Rod end cap	Flat type	○	○	○
Round type		○	○	○	○

* Pin and retaining ring are shipped together with double clevis and double knuckle joint.

Weight

(g)

Bore size (mm)		10	16
Basic weight *		52	96
Additional weight per each 15 mm of stroke		4	6.5
Mounting bracket weight	Axial foot style	22	22
	Rod side flange style	16	16
	Double clevis style (With pin) **	6	16

* Mounting nut and rod end nut are included in the basic weight.

** Mounting nut is not included in double clevis style.

Calculation: (Example) **CJ5L10SR-45**

- Basic weight 52 g (ø10)
- Additional weight 4 g/15 stroke
- Cylinder stroke 45 stroke
- Mounting bracket weight 22 g (Axial foot type)
52 + 4/15 × 45 + 22 = 86 g

D-□

-X□

Technical
data

Series CJ5-S

Construction (Not able to disassemble.)

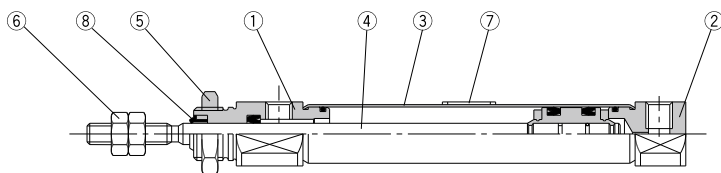

Component Parts

No.	Description	Material	
1	Rod cover	Stainless steel 304	
2	Head cover	Stainless steel 304	
3	Cylinder tube	Stainless steel 304	
4	Piston rod	Stainless steel 304	
5	Mounting nut	Stainless steel 304	
6	Rod end nut	Stainless steel 304	
7	Label protector	PET	
8	Water resistant scraper	CJ5□□SR	NBR
		CJ5□□SV	FKM

Note) Component part material and surface treatment other than listed above are the same as the standard type of Series CJ2.

Dimensions

Basic style (B): $C\Box J5B\Box S\overset{R}{V}$

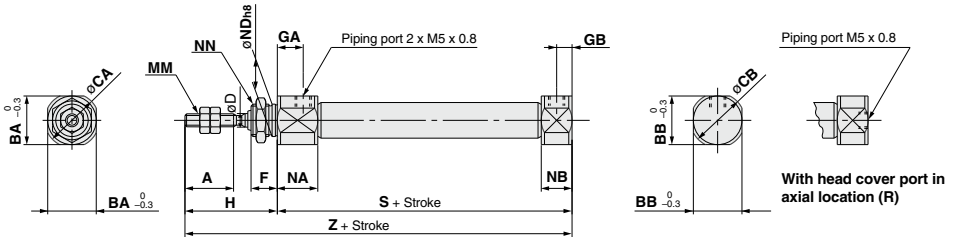

**CJ5
CG5**
HY
Water
Resistant

																(mm)	
Bore size (mm)	A	BA	BB	CA	CB	D	F	GA	GB	H	MM	NN	NA	NB	NDh8	S	Z
10	15	15	12	17	14	4	8	8	5	28	M4 x 0.7	M10 x 1.0	12.5	9.5	10 ⁰ _{-0.022}	46	74
16	15	18.3	18.3	20	20	5	8	8	5	28	M5 x 0.8	M12 x 1.0	12.5	9.5	12 ⁰ _{-0.027}	47	75

Axial foot style (L): $C\Box J5L\Box S\overset{R}{V}$

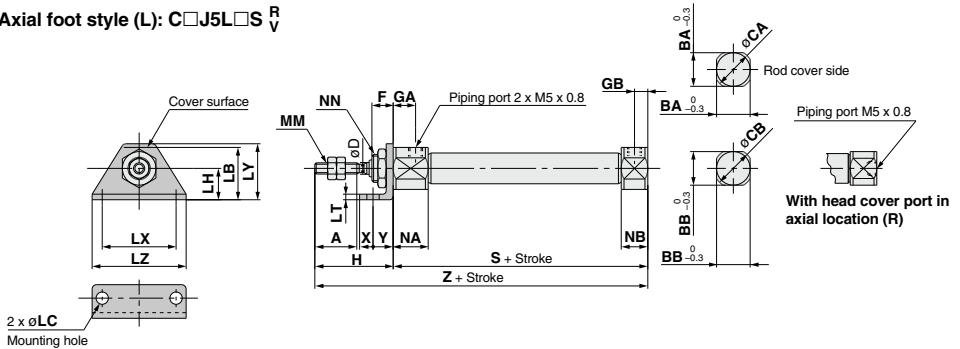

																			(mm)						
Bore size (mm)	A	BA	BB	CA	CB	D	F	GA	GB	H	LB	LC	LH	LT	LX	LY	LZ	MM	NN	NA	NB	S	X	Y	Z
10	15	15	12	17	14	4	8	8	5	28	21.5	5.5	14	2.5	33	25	42	M4 x 0.7	M10 x 1.0	12.5	9.5	46	6	9	74
16	15	18.3	18.3	20	20	5	8	8	5	28	23	5.5	14	2.5	33	25	42	M5 x 0.8	M12 x 1.0	12.5	9.5	47	6	9	75

D-
-X
Technical
data

Series CJ5-S

Dimensions

Rod side flange style (F): C□J5F□S^R_V

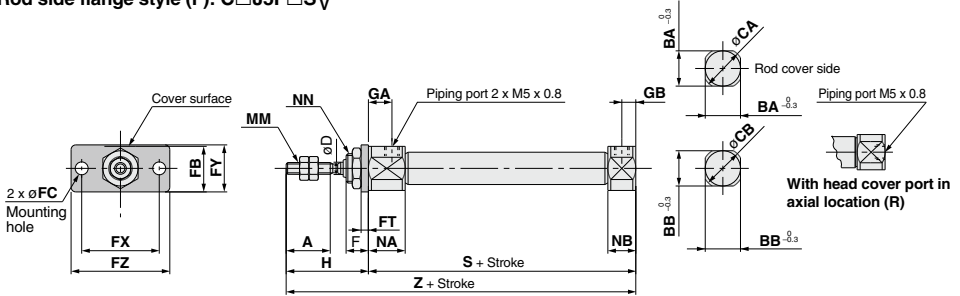

(mm)

Bore size (mm)	A	BA	BB	CA	CB	D	F	FB	FC	FT	FX	FY	FZ	GA	GB	H	MM	NN	NA	NB	S	Z
10	15	15	12	17	14	4	8	17.5	5.5	2.5	33	20	42	8	5	28	M4 x 0.7	M10 x 1.0	12.5	9.5	46	74
16	15	18.3	18.3	20	20	5	8	19	5.5	2.5	33	20	42	8	5	28	M5 x 0.8	M12 x 1.0	12.5	9.5	47	75

Double clevis style (D): C□J5D□S^R_V

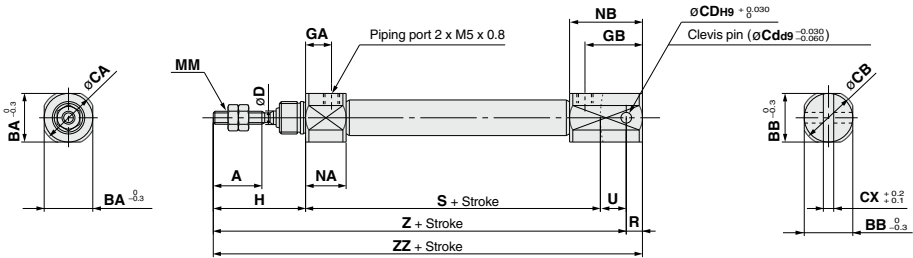

(mm)

Bore size (mm)	A	BA	BB	CA	CB	CD (Cd)	CX	D	GA	GB	H	MM	NA	NB	R	S	U	Z	ZZ
10	15	15	12	17	14	3.3	3.2	4	8	18	28	M4 x 0.7	12.5	22.5	5	46	8	82	87
16	15	18.3	18.3	20	20	5	6.5	5	8	23	28	M5 x 0.8	12.5	27.5	8	47	10	85	93

* Clevis pin and retaining ring are shipped together.

Series CJ5-S Accessory Dimensions

Single Knuckle Joint

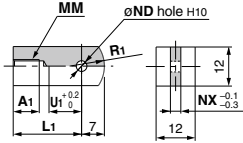

Material: Stainless steel 304

Part no.	Applicable bore size (mm)	A1	L1	MM	NDH10	NX	R1	U1
I-J010SUS	10	8	21	M4 x 0.7	3.3 ^{+0.048} ₀	3.1	8	9
I-J016SUS	16	8	25	M5 x 0.8	5 ^{+0.048} ₀	6.4	12	14

Clevis Pin

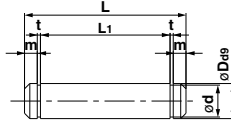

Material: Pin and retaining ring both stainless steel 304

Part no.	Applicable bore size (mm)	Dda9	d	L	L1	m	t	Applicable retaining ring
CD-J010	10	3.3 ^{+0.020} _{-0.060}	3	15.2	12.2	1.2	0.3	Type C 3.2
CD-Z015SUS	16	5 ^{+0.020} _{-0.060}	4.8	22.7	18.3	1.5	0.7	Type C 5

* Retaining rings are included.

Knuckle Pin

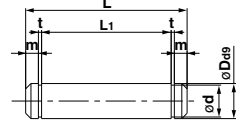

Material: Pin and retaining ring both stainless steel 304

Part no.	Applicable bore size (mm)	Dda9	d	L	L1	m	t	Applicable retaining ring
CD-J010	10	3.3 ^{+0.020} _{-0.060}	3	15.2	12.2	1.2	0.3	Type C 3.2
IY-J015SUS	16	5 ^{+0.020} _{-0.060}	4.8	16.6	12.2	1.5	0.7	Type C 5

* Clevis pin is used instead for ø10.

* Retaining rings are included.

Double Knuckle Joint

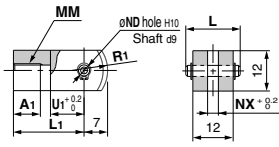

* Knuckle pin and retaining ring are packaged together.

Material: Stainless steel 304

Part no.	Applicable bore size (mm)	A1	L	L1	MM	NDa9
Y-J010SUS	10	8	15.2	21	M4 x 0.7	3.3 ^{+0.020} _{-0.060}
Y-J016SUS	16	11	16.6	21	M5 x 0.8	5 ^{+0.020} _{-0.060}

Part no.	NDH10	NX	R1	U1
Y-J010SUS	3.3 ^{+0.048} ₀	3.2	8	10
Y-J016SUS	5 ^{+0.048} ₀	6.5	12	10

Mounting Nut

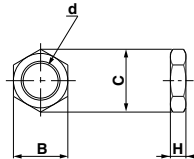

Material: Stainless steel 304

Part no.	Applicable bore size (mm)	B	C	d	H
SNJ-016SUS	10	14	16.2	M10 x 1.0	4
SNKJ-016SUS	16	17	19.6	M12 x 1.0	4

Rod End Nut

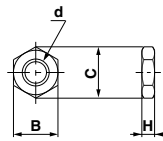

Material: Stainless steel 304

Part no.	Applicable bore size (mm)	B	C	d	H
NTJ-010SUS	10	7	8.1	M4 x 0.7	3.2
NTJ-015SUS	16	8	9.2	M5 x 0.8	4

T-bracket

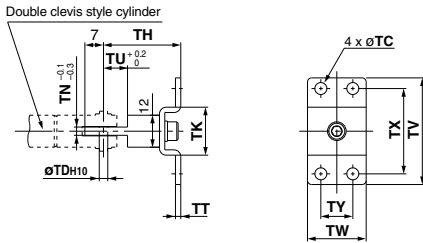

Material: Stainless steel 304

Part no.	Applicable bore size (mm)	TC	TDH10	TH	TK	TN	TT	TU	TV	TW	TX	TY
CJ-T010SUS	10	4.5	3.3 ^{+0.048} ₀	29	18	3.1	2	9	40	22	32	12
CJ-T016SUS	16	5.5	5 ^{+0.048} ₀	35	20	6.4	2.5	14	48	28	38	16

Rod End Cap

Flat type/CJ-CF□□□

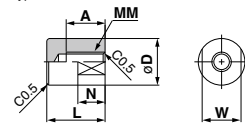

Round type/CJ-CR□□□

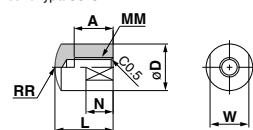

Material: Polycacetal

Part no.	Applicable bore size (mm)	A	D	L	MM	N	R	W
CJ-CF010	10	8	10	13	M4 x 0.7	6	10	8
CJ-CF016	16	10	12	15	M5 x 0.8	7	12	10

CJ5
CG5

HY□

Water
Resistant

D-□

-X□

Technical
data

Stainless Steel Cylinder

Series CG5-S

ø20, ø25, ø32, ø40, ø50, ø63, ø80, ø100

How to Order

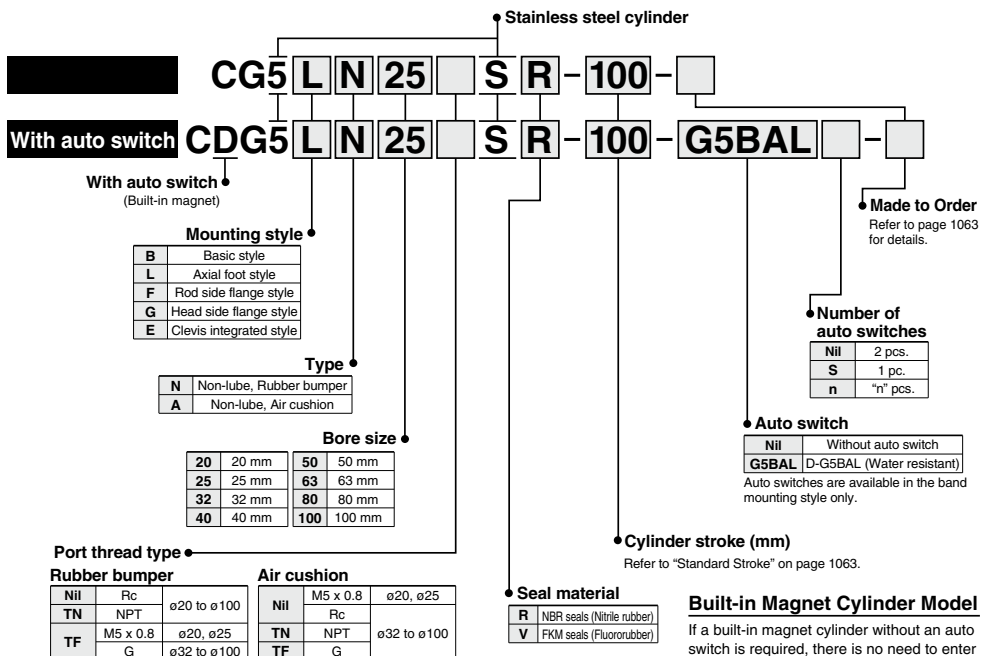

Applicable Auto Switches Refer to pages 1559 to 1673 for further information on auto switches.

Type	Special function	Electrical entry	Indicator light	Wiring (Output)	Load voltage		Auto switch model	Lead wire length (m)*		Pre-wired connector	Applicable load
					DC			3 (L)	5 (Z)		
Solid state auto switch	Water resistant (2-color indication)	Grommet	Yes	2-wire	24 V	12 V	G5BA	●	○	○	Relay, PLC

* Lead wire length symbols: 3 m.....L (Example) G5BAL
5 m.....Z (Example) G5BAZ

* Solid state auto switches marked with "○" are produced upon receipt of order.

• For details about auto switches with pre-wired connector, refer to pages 1626 and 1627.

Mounting Bracket Part No.

Mounting bracket	Min. order	Bore size (mm)								Description
		20	25	32	40	50	63	80	100	
Foot	2 (Note)	CG-L020SUS	CG-L025SUS	CG-L032SUS	CG-L040SUS	CG-L050SUS	CG-L063SUS	CG-L080SUS	CG-L100SUS	Foot x 2 Bracket mounting bolt x 4
Flange	1	CG-F020SUS	CG-F025SUS	CG-F032SUS	CG-F040SUS	CG-F050SUS	CG-F063SUS	CG-F080SUS	CG-F100SUS	Flange x 1 Bracket mounting bolt x 4
Pivot bracket	1	CG-E020SUS		CG-E032SUS		CG-E050SUS		CG-E080SUS		Clevis pin x 1 Retaining ring x 2

(Note) When ordering the foot bracket, order 2 pcs. per cylinder.

Grease pack for stainless steel cylinders/Part no.: GR-R-010 (10 g)

Specifications



Symbol

Double acting,
Single rod, Rubber bumper

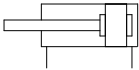

Air cushion

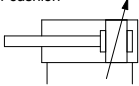

Bore size (mm)	20	25	32	40	50	63	80	100
Action	Double acting, Single rod							
Fluid	Air							
Proof pressure	1.5 MPa							
Maximum operating pressure	1.0 MPa							
Minimum operating pressure	0.05 MPa							
Ambient and fluid temperature	Without auto switch: -10 to 70°C With auto switch: -10 to 60°C							
Cushion	Rubber bumper, Air cushion							
Lubrication	Not required (Non-lube)							
Piston speed	50 to 1000 mm/s						50 to 700 mm/s	
Stroke length tolerance	Up to 1000 st +1.4 ₀ mm, Up to 1200 st +1.8 ₀ mm						Up to 1000 st +1.4 ₀ mm, Up to 1500 st +1.8 ₀ mm	
Mounting style	Basic style, Axial foot style, Rod side flange style, Head side flange style, Clevis integrated style							

CJ5
CG5

HY□

Water
Resistant

Standard Stroke

Bore size (mm)	Standard stroke	Long stroke	Maximum manufacturable stroke
20	25, 50, 75, 100, 125, 150, 200	201 to 350	1500
25	25, 50, 75, 100, 125, 150, 200 250, 300	301 to 400	
32		301 to 450	
40		301 to 800	
50, 63		301 to 1200	
80		301 to 1400	
100		301 to 1500	

* Manufacture of intermediate strokes at 1 mm intervals is possible. (Spacers are not used.)

* Long stroke applies to the axial foot style and the rod side flange style. If other mounting brackets are used, or the length exceeds the long stroke limit, the stroke should be determined based on the stroke selection table (front matter 34, CG1).



Made to Order Specifications
(For details, refer to pages 1675 to 1818.)

Symbol	Specifications
-XA□	Change of rod end shape
-XB6	Heat resistant cylinder (150°C)*

* Heat resistant grease (non-food grease) is used.

Accessory

Mounting		●...Supplied with the product.	○...Please order separately.				
		Basic style	Axial foot style	Rod side flange style	Head side flange style	Clevis integrated style	
Standard equipment	Rod end nut	●	●	●	●	●	
	Single knuckle joint	○	○	○	○	○	
Option	Double knuckle joint (With pin & retaining ring)	○	○	○	○	○	
	Pivot bracket (With pin and retaining ring)	—	—	—	—	○	

Weight

Bore size (mm)		20	25	32	40	50	63	80	100
Basic weight	Basic style	0.32	0.42	0.61	0.97	1.78	2.73	5.20	8.13
	Axial foot style	0.40	0.53	0.72	1.13	2.12	3.19	5.91	9.50
	Flange style	0.43	0.53	0.71	1.12	2.04	3.25	5.86	9.29
	Clevis integrated style	0.37	0.48	0.72	1.12	2.17	3.26	6.48	9.94
Pivot bracket		0.08	0.08	0.18	0.18	0.46	0.46	1.65	1.65
Single knuckle joint		0.04	0.07	0.07	0.11	0.22	0.22	0.53	0.78
Double knuckle joint (with pin)		0.05	0.09	0.09	0.18	0.33	0.33	0.73	1.07
Additional weight per each 50 mm of stroke		0.06	0.08	0.14	0.18	0.27	0.33	0.50	0.73
Additional weight with air cushion		0.02	0.02	0.03	0.02	0.06	0.07	0.14	0.16

Calculation: (Example) **CG5LA 20SR-100**
(Foot style ø20, 100 stroke)

- Basic weight..... 0.40 kg (Foot style ø20)
- Additional stroke weight 0.06 kg/50 ST
- Air cylinder stroke 100 ST
- Additional air cushion weight 0.02 kg
- 0.40 + 0.06 x 100/50 + 0.02 = 0.54 kg

D-□

-X□

Technical
data

Series CG5-S

Construction

With rubber bumper

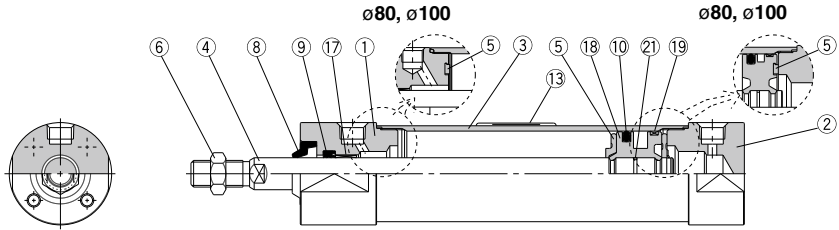

With air cushion

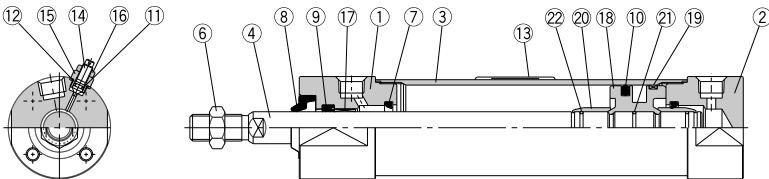

Component Parts

No.	Description	Material
1	Rod cover	Stainless steel 304
2	Head cover	Stainless steel 304
3	Cylinder tube	Stainless steel 304
4	Piston rod	Stainless steel 304 / Hard chrome plated
5	Bumper	Urethane
6	Rod end nut	Stainless steel 304
7	Cushion seal	Urethane
14	Cushion valve	Stainless steel 304
15	Valve retainer	Stainless steel 304
16	Lock nut	Stainless steel 304
17	Bushing	Bearing alloy
18	Piston	Aluminum alloy
19	Wearing	Resin
20	Cushion ring	Aluminum alloy

Note 1) Component part material and surface treatment other than listed above are the same as the standard type of Series CG1.

Note 2) For cylinders with an auto switch, the piston is fixed with a magnet.

No.	Description	Material	
		CG5□□□SR	CG5□□□SV
8	Water resistant scraper	NBR	FKM
9	Rod seal		
10	Piston seal		
11	Valve seal		
12	Valve retainer gasket		
21	Piston gasket		
22	Cushion ring gasket	PET	
13	Label protector	PET	

Replacement Parts/Seal Kit

Bore size (mm)	Rubber bumper		Air cushion	
	CG5□N□SR	CG5□N□SV	CG5□A□SR	CG5□A□SV
20	CG5N20SR-PS	CG5N20SV-PS	CG5A20SR-PS	CG5A20SV-PS
25	CG5N25SR-PS	CG5N25SV-PS	CG5A25SR-PS	CG5A25SV-PS
32	CG5N32SR-PS	CG5N32SV-PS	CG5A32SR-PS	CG5A32SV-PS
40	CG5N40SR-PS	CG5N40SV-PS	CG5A40SR-PS	CG5A40SV-PS
Contents	Set of ⑨ and ⑩ above		Set of ⑨, ⑩, ⑪ and ⑫ above	

* Seal kit includes a grease pack (10 g).

Order with the following part number when only the grease pack is needed.

Grease pack part number: GR-R-010 (10 g)

⚠ Caution

When disassembling cylinders with bore sizes of $\varnothing 20$ through $\varnothing 40$, grip the double flat part of either the tube cover or the rod cover with a vise and loosen the other side with a wrench or a monkey wrench, etc., and then remove the cover. When retightening, tighten approximately 2 degrees more than the original position. (Cylinders with $\varnothing 50$ or larger bore sizes are tightened with a large tightening torque and cannot be disassembled.)

Dimensions

Basic style (B): C□G5BN□S_V^R: With rubber bumper

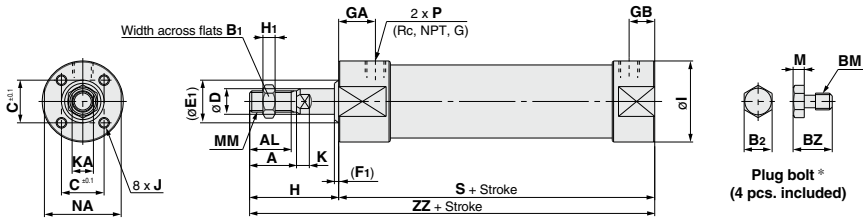

**CJ5
CG5**
HY
Water
Resistant

Bore size (mm)	Stroke range	Rc, NPT port			G port			A	AL	B ₁	B ₂	BM	BZ	C	D	E ₁	F ₁	H	H ₁	I	J	K	KA	M	MM	NA	S	ZZ
		GA	GB	P	GA	GB	P	18	15.5	13	7	M4 x 0.7	9	16.5	8	15	3	35	5	31	M4 x 0.7 depth 7	5	6	3	M8 x 1.25	29	83	118
20	Up to 350	18	12	1/8	18	12	M5 x 0.8	22	19.5	17	8	M5 x 0.8	9.5	18.5	10	17	3	40	6	33	M5 x 0.8 depth 8	6.5	8	3.5	M10 x 1.25	29	83	123
32	Up to 450	18	12	1/8	16	10	1/8	22	19.5	17	8	M5 x 0.8	9.5	20	12	19	3	40	6	38	M5 x 0.8 depth 8	10	3.5	M10 x 1.25	35.5	85	125	
40	Up to 800	19	13	1/8	16	10	1/8	30	27	19	10	M6 x 1.0	12	26	16	23	3	50	8	47	M6 x 1.0 depth 12	6	14	4	M14 x 1.5	44	93	143
50	Up to 1200	21	14	1/4	19	12	1/4	35	32	27	13	M8 x 1.25	15.5	32	20	28	3	58	11	58	M8 x 1.25 depth 12	7	18	5.5	M18 x 1.5	55	109	167
63	Up to 1200	21	14	1/4	19	12	1/4	35	32	27	17	M10 x 1.5	19	38	20	28	3	58	11	72	M10 x 1.5 depth 16	7	18	7	M18 x 1.5	69	109	167
80	Up to 1400	28	20	3/8	25	17	3/8	40	37	32	17	M10 x 1.5	19	50	25	33	3	71	13	89	M10 x 1.5 depth 22	10	22	7	M22 x 1.5	80	130	201
100	Up to 1500	29	20	1/2	26	17	1/2	40	37	41	19	M12 x 1.75	24	60	30	38	3	71	16	110	M12 x 1.75 depth 23	10	26	8	M26 x 1.5	100	131	202

* Install plug bolts, which are included, in any unused mounting holes.

Basic style (B): C□G5BA□S_V^R: With air cushion

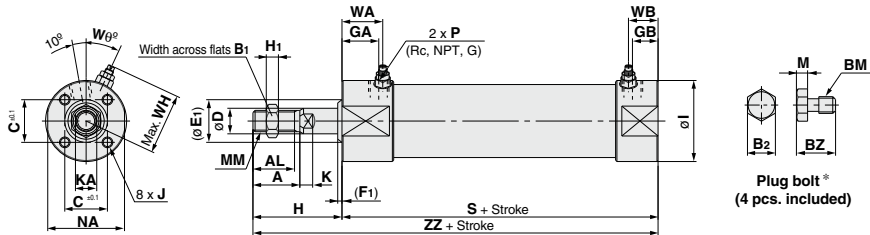

Bore size (mm)	Stroke range	Rc, NPT port			G port			A	AL	B ₁	B ₂	BM	BZ	C	D	E ₁	F ₁	H	H ₁	I	J	K	KA	M	MM	NA	S
		GA	GB	P	GA	GB	P	18	15.5	13	7	M4 x 0.7	9	16.5	8	15	3	35	5	31	M4 x 0.7 depth 7	5	6	3	M8 x 1.25	29	83
20	Up to 350	18	12	M5 x 0.8	18	12	M5 x 0.8	22	19.5	17	8	M5 x 0.8	9.5	18.5	10	17	3	40	6	33	M5 x 0.8 depth 8	5.5	8	3.5	M10 x 1.25	29	83
25	Up to 400	18	12	M5 x 0.8	18	12	M5 x 0.8	22	19.5	17	8	M5 x 0.8	9.5	20	12	19	3	40	6	38	M5 x 0.8 depth 8	5.5	10	3.5	M10 x 1.25	35.5	85
32	Up to 450	18	12	1/8	16	10	1/8	22	19.5	17	8	M5 x 0.8	9.5	20	12	19	3	40	6	38	M5 x 0.8 depth 8	6.5	10	3.5	M10 x 1.25	35.5	85
40	Up to 800	19	13	1/8	16	10	1/8	30	27	19	10	M6 x 1.0	12	26	16	23	3	50	8	47	M6 x 1.0 depth 12	6	14	4	M14 x 1.5	44	93
50	Up to 1200	21	14	1/4	19	12	1/4	35	32	27	13	M8 x 1.25	15.5	32	20	28	3	58	11	58	M8 x 1.25 depth 12	7	18	5.5	M18 x 1.5	55	109
63	Up to 1200	21	14	1/4	19	12	1/4	35	32	27	17	M10 x 1.5	19	38	20	28	3	58	11	72	M10 x 1.5 depth 16	7	18	7	M18 x 1.5	69	109
80	Up to 1400	28	20	3/8	25	17	3/8	40	37	32	17	M10 x 1.5	19	50	25	33	3	71	13	89	M10 x 1.5 depth 22	10	22	7	M22 x 1.5	80	130
100	Up to 1500	29	20	1/2	26	17	1/2	40	37	41	19	M12 x 1.75	24	60	30	38	3	71	16	110	M12 x 1.75 depth 23	10	26	8	M26 x 1.5	100	131

* Install plug bolts, which are included, in any unused mounting holes.

Bore size (mm)	WA	WB	WH	W ₀	ZZ
20	22	16	23	30°	118
25	22	16	25	30°	123
32	22	16	28.5	25°	125
40	22	16	33	20°	143
50	25	18	40.5	20°	167
63	25	18	47.5	20°	167
80	30	22	60.5	20°	201
100	31	22	71	20°	202

D-□
X-□
Technical
data

Series CG5-S

Dimensions

Axial foot style (L): $C\Box G5L^N_A\Box S^R_V$

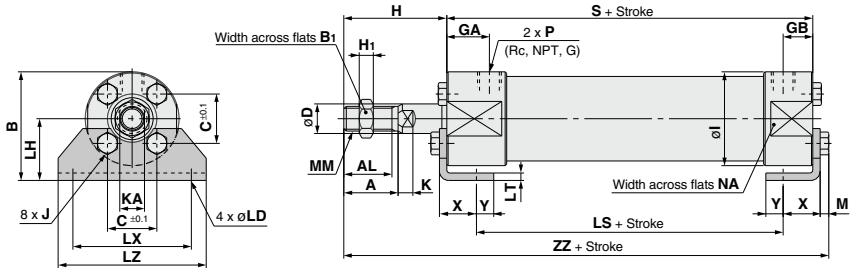

Bore size (mm)	Stroke range	Rc, NPT port			G port			A	AL	B ₁	B	C	D	H	H ₁	I	J	K	KA	LD	LH	LS	LT	LX	LZ	M
		GA	GB	P	GA	GB	P																			
20	Up to 350	18	12	1/8 (1)	18	12	M5 x 0.8	18	15.5	13	37.5	16.5	8	35	5	31	M4 x 0.7	5	6	6	22	59	3	40	50	3
25	Up to 400	18	12	1/8 (1)	18	12	M5 x 0.8	22	19.5	17	41.5	18.5	10	40	6	33	M5 x 0.8	5.5	8	6	25	59	3	44	60	3.5
32	Up to 450	18	12	1/8	16	10	1/8	22	19.5	17	44	20	12	40	6	38	M5 x 0.8	5.5	10	7.2	25	59	3	44	60	3.5
40	Up to 800	19	13	1/8	16	10	1/8	30	27	19	53.5	26	16	50	8	47	M6 x 1.0	6	14	7.2	30	66	3	54	75	4
50	Up to 1200	21	14	1/4	19	12	1/4	35	32	27	69	32	20	58	11	58	M8 x 1.25	7	18	10	40	74	4	66	90	5.5
63	Up to 1200	21	14	1/4	19	12	1/4	35	32	27	81	38	20	58	11	72	M10 x 1.5	7	18	12	45	74	4	82	110	7
80	Up to 1400	28	20	3/8	25	17	3/8	40	37	32	99.5	50	25	71	13	89	M10 x 1.5	10	22	12	55	82	4	100	130	7
100	Up to 1500	29	20	1/2	26	17	1/2	40	37	41	125	60	30	71	16	110	M12 x 1.75	10	26	14	70	83	6	120	160	8

* Foot brackets and plug bolts are installed when shipped from factory.

Note 1) ø20 and ø25 cylinders with an air cushion: M5 x 0.8

Note 2) Refer to the basic type (B)/CG5BA□S* for the dimensions of air cushion needles.

Bore size (mm)	MM	NA	S	X	Y	ZZ
20	M8 x 1.25	29	83	15	7	124
25	M10 x 1.25	29	83	15	7	129.5
32	M10 x 1.25	35.5	85	16	6	131.5
40	M14 x 1.5	44	93	16.5	6.5	150
50	M18 x 1.5	55	109	21.5	11.5	176.5
63	M18 x 1.5	69	109	21.5	11.5	178
80	M22 x 1.5	80	130	28	17	212
100	M26 x 1.5	100	131	30	15	216

Rod side flange style (F): $C\Box G5F^N_A\Box S^R_V$

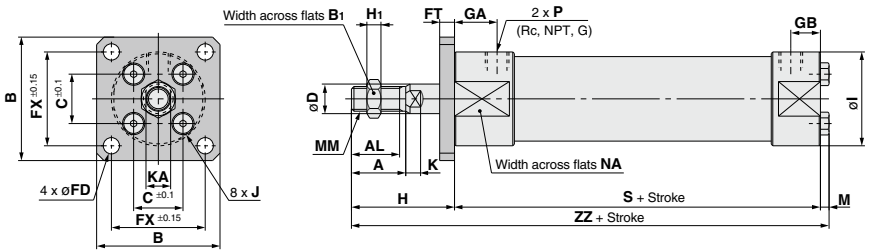

Bore size (mm)	Stroke range	Rc, NPT port			G port			A	AL	B ₁	B	C	D	FX	FD	FT	H	H ₁	I	J	K	KA	M	MM	NA	S	ZZ
		GA	GB	P	GA	GB	P																				
20	Up to 350	18	12	1/8 (1)	18	12	M5 x 0.8	18	15.5	13	50	16.5	8	36	5.5	6	35	5	31	M4 x 0.7	5	6	3	M8 x 1.25	29	83	121
25	Up to 400	18	12	1/8 (1)	18	12	M5 x 0.8	22	19.5	17	50	18.5	10	36	5.5	6	40	6	33	M5 x 0.8	5.5	8	3.5	M10 x 1.25	29	83	126.5
32	Up to 450	18	12	1/8	16	10	1/8	22	19.5	17	50	20	12	38	6.6	6	40	6	38	M5 x 0.8	5.5	10	3.5	M10 x 1.25	35.5	85	128.5
40	Up to 800	19	13	1/8	16	10	1/8	30	27	19	60	26	16	46	6.6	6	50	8	47	M6 x 1.0	6	14	4	M14 x 1.5	44	93	147
50	Up to 1200	21	14	1/4	19	12	1/4	35	32	27	75	32	20	58	9	9	58	11	58	M8 x 1.25	7	18	5.5	M18 x 1.5	55	109	172.5
63	Up to 1200	21	14	1/4	19	12	1/4	35	32	27	90	38	20	70	11	9	58	11	72	M10 x 1.5	7	18	7	M18 x 1.5	69	109	174
80	Up to 1400	28	20	3/8	25	17	3/8	40	37	32	100	50	25	82	11	9	71	13	89	M10 x 1.5	10	22	7	M22 x 1.5	80	130	208
100	Up to 1500	29	20	1/2	26	17	1/2	40	37	41	125	60	30	100	14	10	71	16	110	M12 x 1.75	10	26	8	M26 x 1.5	100	131	210

* Flange bracket and plug bolt are installed when shipped from factory.

Note 1) ø20 and ø25 cylinders with an air cushion: M5 x 0.8

Note 2) Refer to the basic type (B)/CG5BA□S* for the dimensions of air cushion needles.

Dimensions

Head side flange style (G): \square C□G5G^N_A□S^R_V

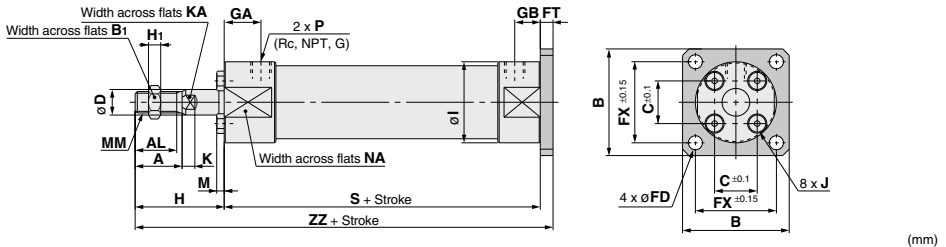

Bore size (mm)	Stroke range	Rc, NPT port			G port			G port																			
		GA	GB	P	GA	GB	P	A	AL	B ₁	B	C	D	FX	FD	FT	H	H ₁	I	J	K	KA	M	MM	NA	S	ZZ
20	Up to 200	18	12	1/8 (1)	18	12	M5 x 0.8	18	15.5	13	50	16.5	8	36	5.5	6	35	5	31	M4 x 0.7	5	6	3	M8 x 1.25	29	83	124
25	Up to 300	18	12	1/8 (1)	18	12	M5 x 0.8	22	19.5	17	50	18.5	10	36	5.5	6	40	6	33	M5 x 0.8	5.5	8	3.5	M10 x 1.25	29	83	129
32	Up to 300	18	12	1/8	16	10	1/8	22	19.5	17	50	20	12	38	6.6	6	40	6	38	M5 x 0.8	5.5	10	3.5	M10 x 1.25	35.5	85	131
40	Up to 500	19	13	1/8	16	10	1/8	30	27	19	60	26	16	46	6.6	6	50	8	47	M6 x 1.0	6	14	4	M14 x 1.5	44	93	149
50	Up to 600	21	14	1/4	19	12	1/4	35	32	27	75	32	20	58	9	9	58	11	58	M8 x 1.25	7	18	5.5	M18 x 1.5	55	109	176
63	Up to 600	21	14	1/4	19	12	1/4	35	32	27	90	38	20	70	11	9	58	11	72	M10 x 1.5	7	18	7	M18 x 1.5	69	109	176
80	Up to 750	28	20	3/8	25	17	3/8	40	37	32	100	50	25	82	11	9	71	13	89	M10 x 1.5	10	22	7	M22 x 1.5	80	130	210
100	Up to 750	29	20	1/2	26	17	1/2	40	37	41	125	60	30	100	14	10	71	16	110	M12 x 1.75	10	26	8	M26 x 1.5	100	131	212

* Foot brackets and plug bolts are installed when shipped from factory.
 Note 1) ø20 and ø25 cylinders with an air cushion: M5 x 0.8
 Note 2) Refer to the basic type (B)/CG5BA□S^R for the dimensions of air cushion needles.

Integral clevis style (E): \square C□G5E^N_A□S^R_V

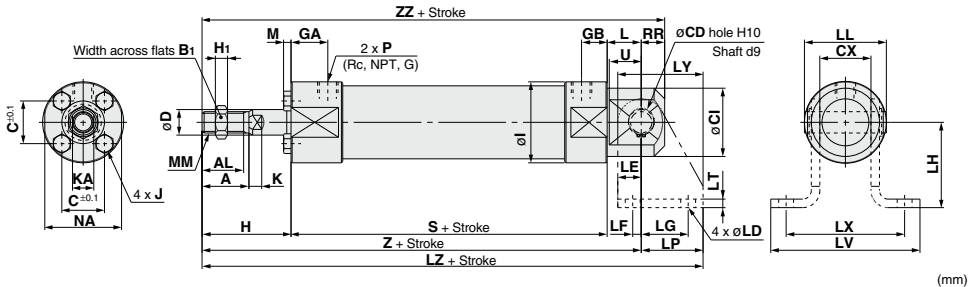

Bore size (mm)	Stroke range	Rc, NPT port			G port			G port																	
		GA	GB	P	GA	GB	P	A	AL	B ₁	C	CD(Hole)	CI	CX	D	H	H ₁	I	J	K	KA	L	M	MM	NA
20	Up to 200	18	12	1/8 (1)	18	12	M5 x 0.8	18	15.5	13	16.5	8 ^{+0.058/0}	25	16 ^{0/-0.2}	8	35	5	31	M4 x 0.7	5	6	14	3	M8 x 1.25	29
25	Up to 300	18	12	1/8 (1)	18	12	M5 x 0.8	22	19.5	17	18.5	8 ^{+0.058/0}	27	16 ^{0/-0.2}	10	40	6	33	M5 x 0.8	5.5	8	14	3.5	M10 x 1.25	29
32	Up to 300	18	12	1/8	16	10	1/8	22	19.5	17	20	10 ^{+0.058/0}	32	24 ^{0/-0.2}	12	40	6	38	M5 x 0.8	5.5	10	16	3.5	M10 x 1.25	35.5
40	Up to 500	19	13	1/8	16	10	1/8	30	27	19	26	10 ^{+0.058/0}	40	24 ^{0/-0.2}	16	50	8	47	M6 x 1.0	6	14	16	4	M14 x 1.5	44
50	Up to 600	21	14	1/4	19	12	1/4	35	32	27	32	14 ^{+0.070/0}	50	40 ^{0/-0.2}	20	58	11	58	M8 x 1.25	7	18	22	5.5	M18 x 1.5	55
63	Up to 600	21	14	1/4	19	12	1/4	35	32	27	38	14 ^{+0.070/0}	60	40 ^{0/-0.2}	20	58	11	72	M10 x 1.5	7	18	22	7	M18 x 1.5	69
80	Up to 750	28	20	3/8	25	17	3/8	40	37	32	50	22 ^{+0.084/0}	75	60 ^{0/-0.3}	25	71	13	89	M10 x 1.5	10	22	33	7	M22 x 1.5	80
100	Up to 750	29	20	1/2	26	17	1/2	40	37	41	60	22 ^{+0.084/0}	90	60 ^{0/-0.3}	30	71	16	110	M12 x 1.75	10	26	33	8	M26 x 1.5	100

Bore size (mm)	RR	S	U	Z	ZZ	Pivot bracket	CD(Shaft)												
							LD	LE	LF	LG	LH	LL	LP	LT	LV	LX	LY	LZ	
20	9	83	13	132	141	CG-E020SUS	8 ^{+0.040/0.075}	7	9	2	14	30	27.6	21	3	56.5	42	30	153
25	9	83	13	137	146	CG-E020SUS	8 ^{+0.040/0.075}	7	9	2	14	30	27.6	21	3	56.5	42	30	158
32	11	85	15	141	152	CG-E032SUS	10 ^{+0.040/0.075}	7	11	4	22	40	38.4	29	4	70.5	56	40	170
40	11	93	15	159	170	CG-E032SUS	10 ^{+0.040/0.075}	7	11	4	22	40	38.4	29	4	70.5	56	40	188
50	15	109	21	189	204	CG-E050SUS	14 ^{+0.050/0.093}	12	15	5	25	50	59.6	35	6	106.5	84	50	224
63	15	109	21	189	204	CG-E050SUS	14 ^{+0.050/0.093}	12	15	5	25	50	59.6	35	6	106.5	84	50	224
80	23	130	32	234	257	CG-E080SUS	22 ^{+0.065/0.117}	14	23	6	40	80	87.2	57	9	144.5	120	80	291
100	23	131	32	235	258	CG-E080SUS	22 ^{+0.065/0.117}	14	23	6	40	80	87.2	57	9	144.5	120	80	292

* Plug bolts are installed when shipped from factory.
 * Pivot bracket (with clevis pin and snap ring) are optional. (Not included.)
 Note 1) ø20 and ø25 cylinders with an air cushion: M5 x 0.8
 Note 2) Refer to the basic type (B)/CG5BA□S^R for the dimensions of air cushion needles.

Series CG5-S

Accessory Dimensions

Single Knuckle Joint

Material: Stainless steel 304

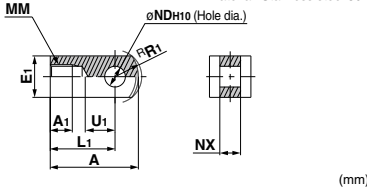

Part no.	Applicable bore size (mm)	A	A1	E1	L1	MM	NDH10	NX	R1	U1
I-G02SUS	20	34	8.5	□16	25	M8 x 1.25	8 ^{+0.058} ₀	8 ^{-0.2} _{-0.4}	10.3	11.5
I-G03SUS	25, 32	41	10.5	□20	30	M10 x 1.25	10 ^{+0.058} ₀	10 ^{-0.2} _{-0.4}	12.8	14
I-G04SUS	40	42	14	□22	30	M14 x 1.5	10 ^{+0.058} ₀	18 ^{-0.3} _{-0.5}	12	14
I-G05SUS	50, 63	56	18	□28	40	M18 x 1.5	14 ^{+0.070} ₀	22 ^{-0.3} _{-0.5}	16	20
I-G08SUS	80	71	21	□38	50	M22 x 1.5	18 ^{+0.070} ₀	28 ^{-0.3} _{-0.5}	21	27
I-G10SUS	100	79	21	□45	55	M26 x 1.5	22 ^{+0.084} ₀	32 ^{-0.3} _{-0.5}	24	31

Knuckle Joint Pin

Material: Stainless steel 440 (Pin)
Stainless steel 304 (Retaining ring)

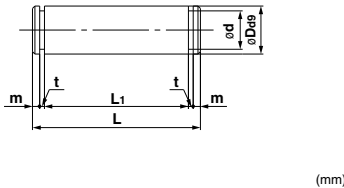

Part no.	Applicable bore size (mm)	dD9	d	L	L1	m	t	Applicable retaining ring
IY-G02SUS	20	8 ^{-0.040} _{-0.078}	7.6	21	16.2	1.5	0.9	Type C 8 for axis
IY-G03SUS	25, 32	10 ^{-0.040} _{-0.078}	9.6	25.6	20.2	1.55	1.15	Type C 10 for axis
IY-G04SUS	40	10 ^{-0.040} _{-0.078}	9.6	41.6	36.2	1.55	1.15	Type C 10 for axis
IY-G05SUS	50, 63	14 ^{-0.050} _{-0.093}	13.4	50.6	44.2	2.05	1.15	Type C 14 for axis
IY-G08SUS	80	18 ^{-0.050} _{-0.093}	17	64	56.2	2.55	1.35	Type C 18 for axis
IY-G10SUS	100	22 ^{-0.065} _{-0.117}	21	72	64.2	2.55	1.35	Type C 22 for axis

* Retaining rings are included.

Clevis Pin

Material: Stainless steel 440 (Pin)
Stainless steel 304 (Retaining ring)

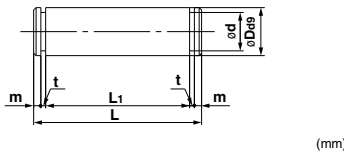

Part no.	Applicable bore size (mm)	dD9	d	L	L1	m	t	Applicable retaining ring
CD-E02SUS	20, 25	ø8 ^{-0.040} _{-0.078}	7.6	27.6	22.8	1.5	0.9	Type C 8 for axis
CD-E03SUS	32, 40	ø10 ^{-0.040} _{-0.078}	9.6	38.4	33	1.55	1.15	Type C 10 for axis
CD-E05SUS	50, 63	ø14 ^{-0.050} _{-0.093}	13.4	59.6	53.2	2.05	1.15	Type C 14 for axis
CD-E08SUS	80, 100	ø22 ^{-0.065} _{-0.117}	21	87.2	79.4	2.55	1.35	Type C 22 for axis

* Retaining rings are included.

Double Knuckle Joint

Material: Stainless steel 440 (Pin)
Stainless steel 304 (Bracket, retaining ring)

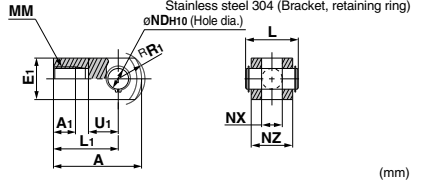

Part no.	Applicable bore size (mm)	A	A1	E1	L	L1	MM	NDH10	NX	NZ	R1	U1	Applicable pin no.
Y-G02SUS	20	34	8.5	16.21	25	M8 x 1.25	8 ^{+0.058} ₀	8 ^{+0.058} ₀	8 ^{+0.058} ₀	8 ^{+0.058} ₀	10.3	11.5	IY-G02SUS
Y-G03SUS	25, 32	41	10.5	20	25.6	30	M10 x 1.25	10 ^{+0.058} ₀	10 ^{+0.058} ₀	10 ^{+0.058} ₀	12.8	14	IY-G03SUS
Y-G04SUS	40	42	16	22	41.6	30	M14 x 1.5	10 ^{+0.058} ₀	18 ^{+0.058} ₀	18 ^{+0.058} ₀	12	14	IY-G04SUS
Y-G05SUS	50, 63	56	20	25	50.6	40	M18 x 1.5	14 ^{+0.070} ₀	22 ^{+0.070} ₀	22 ^{+0.070} ₀	16	20	IY-G05SUS
Y-G08SUS	80	71	21	35	64	50	M22 x 1.5	18 ^{+0.070} ₀	28 ^{+0.070} ₀	28 ^{+0.070} ₀	21	27	IY-G08SUS
Y-G10SUS	100	79	24	40	72	55	M26 x 1.5	22 ^{+0.084} ₀	32 ^{+0.084} ₀	32 ^{+0.084} ₀	24	31	IY-G10SUS

* Knuckle joint pins and retaining rings are included.

Pivot Bracket

Material: Stainless steel 440 (Pin)
Stainless steel 304 (Bracket, retaining ring)

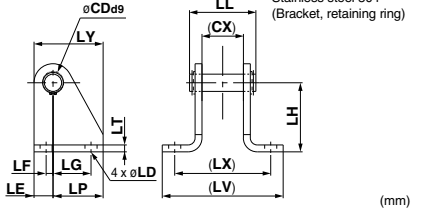

Part no.	Applicable bore size (mm)	CD (Retaining ring)	CX	LD	LE	LF	LG	LH	LL	LP	LV	LX	LY
CG-E020SUS	20, 25	8 ^{-0.040} _{-0.078}	16	7	9	2	14	30	27.6	21	3	56.5	42
CG-E032SUS	32, 40	10 ^{-0.040} _{-0.078}	24	7	11	4	22	40	38.4	29	4	70.5	56
CG-E050SUS	50, 63	14 ^{-0.050} _{-0.093}	40	12	15	5	25	50	59.6	35	6	106.5	84
CG-E080SUS	80, 100	22 ^{-0.065} _{-0.117}	60	14	23	6	40	80	87.2	57	9	144.5	120

* Clevis pins and retaining rings are included.

Rod End Nut

Material: Stainless steel 304

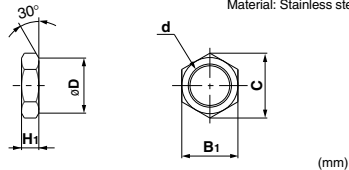

Part no.	Applicable bore size (mm)	B1	C	D	d	H1
NT-02SUS	20	13	(15)	12.5	M8 x 1.25	5
NT-03SUS	25, 32	17	(19.6)	16.5	M10 x 1.25	6
NT-G04SUS	40	19	(21.9)	18	M14 x 1.5	8
NT-05SUS	50, 63	27	(31.2)	26	M18 x 1.5	11
NT-08SUS	80	32	(37.0)	31	M22 x 1.5	13
NT-10SUS	100	41	(47.3)	39	M26 x 1.5	16

Series CJ5-S/CG5-S Auto Switch Mounting

Proper Auto Switch Mounting Position (Detection at stroke end) and Its Mounting Height

Series CJ5-S
D-M9□A(V)
D-H7BA

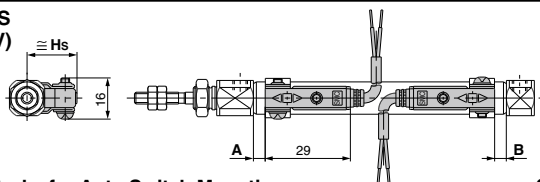

Minimum Stroke for Auto Switch Mounting

Mounting bracket	Basic style, Foot style, Flange style, Clevis style		
Number of auto switches	1 (Rod cover side)	2 (Different sides)	2 (Same side)
	Switch mounting side	Port side	Port side
Switch type			
Minimum stroke (mm)	10	15	60

Auto Switch Mounting Bracket / Part No.

Auto switch model	Bore size (mm)	
	ø10	ø16
D-M9□A D-M9□AV	BJ6-010S (Note 1)	BJ6-016S (Note 1)
D-H7BA	BJ2-010S	BJ2-016S

* With stainless steel mounting screws.

Note 1) Set part number which includes the auto switch mounting band (BJ2-□□□S) and the holder kit (BJ4-1/Switch bracket; White).

Note 2) For D-M9□A(V), avoid the indicator LED for mounting the switch bracket.

Series CG5-S
D-G5BA

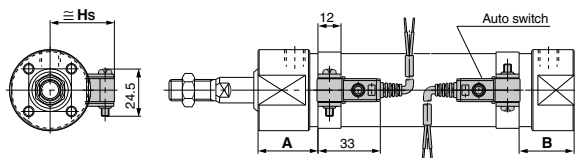

Minimum Stroke for Auto Switch Mounting

Mounting bracket	Basic style, Foot style, Flange style, Clevis style		
Number of auto switches	1 (Rod cover side)	2 (Different sides)	2 (Same side)
	Switch mounting side	Port side	Port side
Switch type			
Minimum stroke (mm)	10	15	75

Auto Switch Mounting Bracket / Part No.

Auto switch model	Bore size (mm)									
	20	25	32	40	50	63	80	100		
D-G5BA	NBA-088S	NBA-106S	BGS1-032S	BAF-04S	-05S	BAF-06S	BAF-08S	BAF-10S		

* With stainless steel mounting screws.

Operating Range

Auto switch model	Bore size (mm)	
	10	16
D-H7BA	5	5

* Since this is a guideline including hysteresis, not meant to be guaranteed. (Assuming approximately ±30% dispersion) There may be the case to change substantially depending on an ambient environment.

Proper Auto Switch Mounting Position and Its Mounting Height

Applicable bore size (mm)	Auto switch model D-H7BA		
	A	B	Hs
10	0	0	17
16	0.5	0.5	20.5

Note) Adjust the auto switch after confirming the operating condition in the actual setting.

Operating Range

Auto switch model	Bore size (mm)							
	20	25	32	40	50	63	80	100
D-G5BA	5	5	5.5	6	7	7.5	7.5	8

* Since this is a guideline including hysteresis, not meant to be guaranteed. (Assuming approximately ±30% dispersion) There may be the case to change substantially depending on an ambient environment.

Proper Auto Switch Mounting Position and Its Mounting Height

Applicable bore size (mm)	Auto switch model D-G5BA		
	A	B	Hs
20	31.5	24	26
25	31.5	24	28.5
32	32.5	25	33
40	37	28	36.5
50	45.5	36	42
63	45.5	36	48.5
80	56	46	57.5
100	57	46	68

Note) Adjust the auto switch after confirming the operating condition in the actual setting.

CJ5
CG5

HY□

Water
Resistant

D-□

-X□

Technical
data

Technical Data: Chemical Resistance Table

⊙ : No influence or almost no influence
 ○ : Some influence, but operational depending on conditions
 △ : Avoid use if possible
 × : Substantial influence, not suitable for use
 — : Not tested

Chemical Resistance Table

Parts		Body		Seal		Water resistant auto switch	
Material		Stainless steel	Aluminum*	Nitrile rubber	Fluororubber	Resin casing	Lead wire
Chemical (Concentration weight %, Temperature °C)	Symbol	Stainless steel 304	Al	NBR (-10 to 60°C)	FKM (-40 to 150°C)	PBT (-10 to 60°C)	PVC (-10 to 60°C)
		Inorganic salt	1 Hydrochloric acid (20%, Room temperature)	×	×	○	⊙
	2 Chromic acid (25%, 70°C)	○	×	×	⊙	⊙	○
	3 Boric acid	○	×	⊙	⊙	⊙	○
	4 Sulfuric acid (30%, Room temperature)	×	×	⊙	⊙	⊙	○
	5 Phosphoric acid (50%, Room temperature)	○	×	⊙	⊙	⊙	○
	6 Ammonium hydroxide (28%)	○	○	○	×	⊙	○
Inorganic alkali	7 Sodium hydroxide (30%, Room temperature)	⊙	×	⊙	△	⊙	×
	8 Calcium hydroxide	△	×	⊙	⊙	⊙	⊙
	9 Magnesium hydroxide	○	○	⊙	⊙	⊙	⊙
Organic solvent	10 Acetylene	⊙	△	⊙	⊙	⊙	⊙
	11 Formic acid (25%, Room temperature)	○	△	×	△	△	△
	12 Citric acid	△	×	⊙	⊙	△	○
	13 Acetic acid (10%, Room temperature)	⊙	△	△	○	⊙	○
	14 Lactic acid (5%, 20°C)	○	×	⊙	⊙	⊙	○
Others (oil, gas, etc.)	15 Linseed oil	⊙	○	⊙	⊙	△	△
	16 Potassium chloride	○	△	⊙	⊙	⊙	⊙
	17 Calcium chloride	○	⊙	⊙	⊙	⊙	⊙
	18 Mineral oil	⊙	⊙	⊙	⊙	⊙	△
	19 Sodium hypochlorite (2%, Room temperature)	○	×	×	⊙	⊙	△
	20 Sodium chloride	○	—	⊙	⊙	⊙	⊙
	21 Carbon dioxide	⊙	⊙	⊙	⊙	⊙	⊙
	22 Natural gas	⊙	⊙	⊙	⊙	⊙	⊙
	23 Boric acid	○	×	⊙	⊙	⊙	○

* Unless noted otherwise, the solution concentration is in a saturated state.

* Chemical resistance is a guide that applies only to the stainless steel cylinder parts, and does not guarantee the performance of air cylinders (auto switches).
 Be sure to perform a verification test before operating.

*) Reference data



Series CJ5-S/CG5-S Stainless Steel Cylinder Specific Product Precautions 1

Be sure to read before handling. Refer to front matter 57 for Safety Instructions and pages 3 to 12 for Actuator and Auto Switch Precautions.

Caution on Design

Warning

- Note the weight of the stainless steel products.**
Since the weight of stainless steel cylinders is approximately 1.5 to 3 times heavier than the standard products (with aluminum body), be careful when calculating weight estimates. Also, when mounting the cylinder on equipment where vibration is expected, avoid using single side brackets such as the flange style, and use double side brackets such as the foot style instead.

Caution

- Adjust the speed control for the environment in which it will be used.**
Speed adjustment may be changed depending on the environment.
- Dust may accumulate on this product's mounting screws and brackets in some operating conditions.**
Measures must be applied depending on the operating conditions when mounting.

Selection

Warning

- Generally, use nitrile rubber (NBR) seals with liquids that do not contain chlorine and sulfur, and use fluoro rubber (FKM) seals with liquids that contain chlorine and sulfur.**
However, depending on the type and the brand of liquid (such as cleaning solvent) that splashes on the cylinder, the operating life of seals may be reduced dramatically. In cases where special additives are used, or where liquid caused trouble with the conventional nitrile or fluoro rubber seals in the past, request an investigation or set up a test period for the use of the seals.
- Even the fluoro rubber specification may not be applicable depending on the type of chemicals and the operating temperature. Therefore, be sure to verify the seal's applicability before use.**

Mounting

Warning

- Do not rotate the cover.**
If a cover is rotated when installing a cylinder or screwing a fitting into the port, it is likely to damage the junction part with cover.
- When using pins, apply grease, etc., in order to prevent them from degrading of shape and rusting.**

Operating Precautions

Warning

- For details about operating precautions, refer to page 174 for Series CM2 and page 310 for Series CG1.**

Caution

- If cleaning the rotating part, grease may leak out, which shortens product service life. Thus, cleaning must be as infrequent as possible.**
- If excess water gets into mounting holes, unwanted bacteria may reproduce. Plug them with plug bolts or external covers to avoid this.**

Operating Environment

Warning

- Fully consider the compatibility of stainless steel.**
The corrosion resistance of stainless steel is not effective against all media and corrosive environments. Corrosion proceeds rapidly with strong hydrochloric acid, hydrofluoric acid, and high temperature ammonium gas, etc. Therefore its compatibility to the environment must be considered carefully.
- Do not operate cylinders with auto switches in environments where oil and chemicals are used.**
Please contact SMC when operating in environments with coolants, cleaning solvents, various oils or chemicals, as it may cause adverse effects (faulty insulation, malfunction due to swelling of the potting resin, and hardening of lead wires, etc) to auto switches even in a short period of time. Even with the fluoro rubber seal specification, the auto switch related parts (switch body, mounting bracket, and built-in magnet) are identical to the standard specifications. Therefore, consult with SMC regarding the cylinder's compatibility (such as chemical resistance) with an environment (chemicals, etc.) before operating.

- Do not immerse the cylinder in water or chemicals.**

When the cylinder is operated in a condition with water pressure, the fluid leaks into the cylinder in the early stages. In the worst case, the fluid may back flow inside the piping and damage the solenoid valve.

Caution

- Avoid installing and using a cylinder inside a food zone.**

- <Not installable>
Food zone An environment where food which will be sold as merchandize, directly touches the cylinder's components.
- <Installable>
Splash zone An environment where food which will not be sold as merchandize, directly touches the cylinder's components.
- Non-food zone An environment where there is no contact with food.

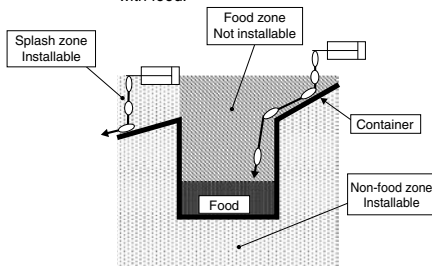

- When cleaning solvent or chemicals splashes on a cylinder, the service life may be extremely shortened. Please contact SMC for details.**
- When cleaning cylinders with steam, do it as quickly as possible, keeping the cylinder's temperature range in mind.**
- When cleaning cylinders with a brush, etc., do not apply excessive force to the weaker parts, such as auto switch lead wire, etc.**

CJ5
CG5

HY □

Water
Resistant

D □

-X □

Technical
data



Series CJ5-S/CG5-S Stainless Steel Cylinder Specific Product Precautions 2

Be sure to read before handling. Refer to front matter 57 for Safety Instructions and pages 3 to 12 for Actuator and Auto Switch Precautions.

Maintenance

Warning

1. If this cylinder is lubricated, it may cause malfunctions.

If grease other than designated is used, it may also cause malfunctions.

- Order with the following part number when only the grease for maintenance is needed.
Grease pack part number for stainless steel cylinders
Grease for food processing machines: GR-R-010 (10 g)

2. Do not wipe grease attached to the rotating part of the air cylinder.

If grease attached to the rotating part is forcibly wiped off, it may cause malfunctions.

If the cylinder is operated for a long period of time, the rotating part may become black. In such cases, wipe the grease attached to the rotating part and reapply fresh grease to enable the cylinder to operate for a long period of time.

(Wipe the grease with water. Using alcohol or solvents may damage seals.)

Precautions for Series CG5-S

1. Sealant* is used on the threads of the connecting sections of the cover and the cylinder tube for air-tight construction. When disassembling the cylinder, the old sealant must be completely removed, and new sealant must be applied before re-assembling.

* Loctite® 542 (medium strength) or equivalent

2. $\phi 50$ or larger bore size cylinders cannot be disassembled.

When disassembling cylinders with bore sizes of $\phi 20$ through $\phi 40$, grip the double flat part of either the head cover or the rod cover with a vise and loosen the other side with a wrench or a monkey wrench, etc., and then remove the cover. When re-tightening, tighten approximately 2 degrees more than the original position. (Cylinders with $\phi 50$ or larger bore sizes are tightened with a large tightening torque and cannot be disassembled. Please contact SMC when disassembly is required.)

Stainless Steel Cylinder

Series CG5-S

∅20, ∅25, ∅32, ∅40, ∅50, ∅63, ∅80, ∅100

How to Order

Without Auto Switch CG5 L N 25 TN S R 100 X165US

With Auto Switch CDG5 L N 25 TN S R 100 G5BAL X165US

With auto switch (built-in magnet)

Mounting

B	Basic type
L	Axial foot type
F	Front flange type
G	Rear flange type
E	Integral clevis type

Type

N	Non-lube, rubber bumper
A	Non-lube, air cushion

Bore size

20	20mm	50	50mm
25	25mm	63	63mm
32	32mm	80	80mm
40	40mm	100	100mm

The 20 to 63mm bore sizes are made in the US in both Metric and Inch rod threads. The 80 and 100mm are made in Japan in Metric rod only. The 80 and 100mm with inch rod thread will be made in the US on a future date. Please inquire with SMC when ordering.

Thread option

Nil	PT ports
TN	NPT ports

Stainless steel cylinder

Inch rod thread
(Only available with "TN" port option. Currently only available on the 20 to 63mm bore sizes.)

Number of auto switches

Nil	2 pcs.
S	1 pc.
n	"n" pcs.

Auto switch type/Band mount type

Nil	Without auto switch (built-in magnet)
G5BAL	D-G5BAL (water resistant)
G5BASAPC	D-G5BASAPC (water resistant) 3 pin M8 connector, 0.5M lead

Auto switches are available in the band mount type only.

Cylinder stroke (mm)
Refer to the standard stroke table on page 8.

Seal material

R	NBR
V	FKM

Mounting bracket part numbers

Mounting bracket	Bore size (mm)							
	20	25	32	40	50	63	80	100
Axial foot <small>Note 1)</small>	CG-L020SUS	CG-L025SUS	CG-L032SUS	CG-L040SUS	CG-L050SUS	CG-L063SUS	CG-L080SUS	CG-L100SUS
Flange	CG-F020SUS	CG-F025SUS	CG-F032SUS	CG-F040SUS	CG-F050SUS	CG-F063SUS	CG-F080SUS	CG-F100SUS
Trunnion bracket <small>Note 2)</small>	CG-E020SUS		CG-E032SUS		CG-E050SUS		CG-E080SUS	

Note 1) Order two foot brackets for each cylinder.

Note 2) Includes clevis pin and snap ring.

Auto switch mounting bracket part numbers (band mount type)

Auto switch model	Bore size (mm)							
	20	25	32	40	50	63	80	100
D-G5BA	NBA-088S	NBA-106S	BGS1-032S	BAF-04S	BAF-05S	BAF-06S	BAF-08S	BAF-10S

* Includes stainless steel mounting screws.

Rod and Porting Combinations

Combination	Bore Size
Metric Rod / PT Ports	20 to 100mm
Metric Rod / NPT Ports (TN Option Only)	20 to 100mm
Inch Rod / NPT Ports (TN & X165US Option)	20 to 63mm

Grease pack for stainless steel cylinders/Part number: GR-R-010 (10g)

Auto switch specifications

D-G5BA (With indicator light)/Band mount type	
Auto switch model	D-G5BA
Wiring type	2 wire
Output type	—
Applicable load	24VDC relay, PLC
Power supply voltage	—
Current consumption	—
Load voltage	24VDC (10 to 28VDC)
Load current	5 to 40mA
Internal voltage drop	4V or less
Leakage current	0.8mA or less at 24VDC
Indicator light	Actuated position Red LED lights up Optimum operating position ... Green LED lights up

* Use caution during operation as residue may collect on auto switches.

* Refer to pages 15 through 17 for auto switch related items.

* Auto switches with M8 and M12 connectors are available as standard product. See page 17 for other options besides lead wire.

Specifications



JIS symbol

Double acting/Single rod

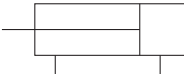

Minimum stroke for mounting auto switches

Model	Number of auto switches	
	2 pcs.	1 pc.
D-G5BA	15mm	10mm

Refer to page 15 for details.

Action	Double acting single rod	
Fluid	Air	
Proof pressure	1.5MPa	
Maximum operating pressure	1.0MPa	
Minimum operating pressure	0.05MPa	
Ambient and fluid temperature	Without auto switch: -10 to 70°C, With auto switch: -10 to 60°C	
Cushion	Rubber bumper, Air cushion	
Piston speed	ø20 to ø63	50 to 1000mm/s
	ø80, ø100	50 to 700mm/s
Thread tolerance	JIS class 2	
Stroke length tolerance	ø20 to ø63	to 1000 ^{+1.4} ₀ mm, to 1200 ^{+1.5} ₀ mm
	ø80, ø100	to 1000 ^{+1.4} ₀ mm, to 1500 ^{+1.5} ₀ mm
Mounting	Basic type, Axial foot type, Front flange type, Rear flange type, Integral clevis type	

Standard Strokes

(mm)

Bore size	Standard stroke ^{Note 1)}	Long stroke
20	25, 50, 75, 100, 125, 150, 200	201 to 350
25	25, 50, 75, 100, 125, 150, 200, 250, 300	301 to 400
32		301 to 450
40		301 to 800
50, 63		301 to 1200
80		301 to 1400
100		301 to 1500

Note 1) All non-standard strokes are produced upon receipt of order. (Spacers are not used on intermediate strokes.)

Accessories

Mounting		Basic type	Axial foot type	Front flange type	Rear flange type	Integral clevis type
Standard	Rod end nut	●	●	●	●	●
Optional	Single knuckle joint	●	●	●	●	●
	Double knuckle joint (with pin & snap ring)	●	●	●	●	●
	Trunnion bracket (with pin & snap ring)	—	—	—	—	●

Weights

(kg)

Bore size		20	25	32	40	50	63	80	100
Standard weight	Basic type	0.32	0.42	0.61	0.97	1.78	2.73	5.20	8.13
	Axial foot type	0.40	0.53	0.72	1.13	2.12	3.19	5.91	9.50
	Flange type	0.43	0.53	0.71	1.12	2.04	3.25	5.86	9.29
	Integral clevis type	0.37	0.48	0.72	1.12	2.17	3.26	6.48	9.94
Trunnion bracket		0.08	0.08	0.18	0.18	0.46	0.46	1.65	1.65
Single knuckle joint		0.04	0.07	0.07	0.11	0.22	0.22	0.53	0.78
Double knuckle joint (with pin)		0.05	0.09	0.09	0.18	0.33	0.33	0.73	1.07
Additional weight per 50mm of stroke		0.06	0.08	0.14	0.18	0.27	0.33	0.50	0.73
Additional weight with air cushion		0.02	0.02	0.03	0.02	0.06	0.07	0.14	0.16

Calculation (Example) CG5LA 20SR-100
(Foot type ø20, 100mm stroke)

- Basic weight 0.40kg (Foot type ø20)
 - Additional stroke weight 0.06kg/50mm stroke
 - Air cylinder stroke 100mm
 - Additional air cushion weight 0.02kg
- 0.40 + 0.06 x 100/50 + 0.02 = 0.54kg

Series CG5-S

Construction

With rubber bumper

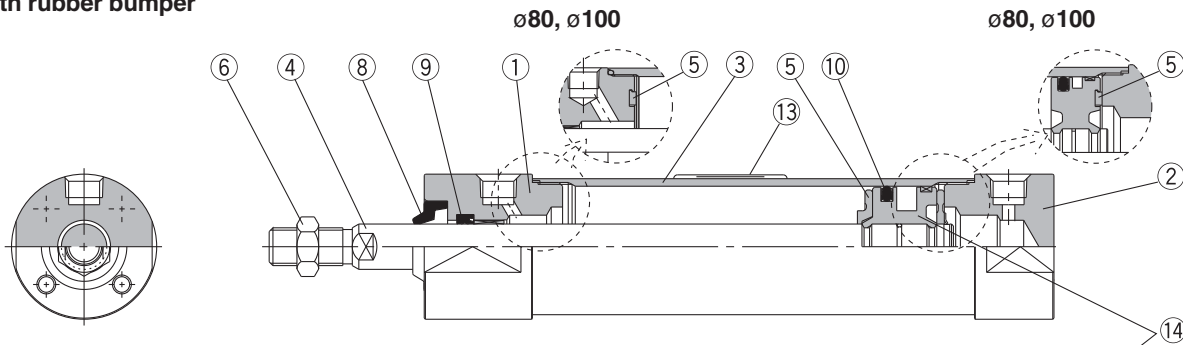

With air cushion

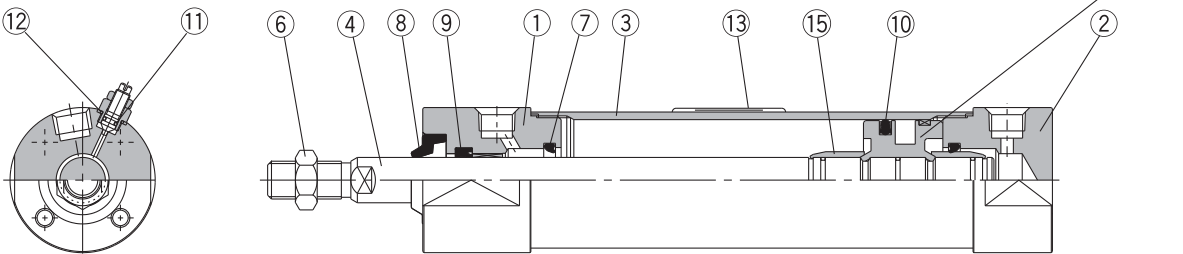

Parts list Note1)

No.	Description	Material
1	Rod cover	SUS304
2	Head cover	SUS304
3	Cylinder tube	SUS304
4	Piston rod	SUS304
5	Bumper	Urethane
6	Rod end nut	SUS304
7	Cushion seal	Urethane

Note1) Magnets are installed on pistons of cylinders equipped with auto switches.

No.	Description	Material	
		CG5□□□SR	CG5□□□SV
8	Water resistant scraper	NBR	FKM
9	Rod seal		
10	Piston seal		
11	Valve seal		
12	Valve retainer gasket	PET	
14	Piston	Aluminum alloy	
15	Cushion ring	Brass	

Replacement parts: Water resistant scraper (Part No.8) Note)

Bore size	NBR Wiper (R option)	FKM Wiper (V option)
20	SDB-8	SDB-8F
25	SDB-10	SDB10F
32	SDB-12	SDB12F
40	SDB-16	SDB-16F
50	SDB-20	SDB-20F
63	SDB-20	SDB-20F
80	SDB-25	SDB-25F
100	SDB-30	SDB-30F

Note) The scraper is held into the Rod cover with a light press fit. The scraper can be carefully pried out, and replaced with a press fit using a manual arbor press.

Replacement parts: Seal kits Note)

Bore size	Rubber bumper		Air cushion	
	CG5□N□SR	CG5□N□SV	CG5□A□SR	CG5□A□SV
20	CG5N20SR-PS	CG5N20SV-PS	CG5A20SR-PS	CG5A20SV-PS
25	CG5N25SR-PS	CG5N25SV-PS	CG5A25SR-PS	CG5A25SV-PS
32	CG5N32SR-PS	CG5N32SV-PS	CG5A32SR-PS	CG5A32SV-PS
40	CG5N40SR-PS	CG5N40SV-PS	CG5A40SR-PS	CG5A40SV-PS
50*	CG5N50SR-PS	CG5N50SV-PS	CG5A50SR-PS	CG5A50SV-PS
63*	CG5N63SR-PS	CG5N63SV-PS	CG5A63SR-PS	CG5A63SV-PS
80*	CG5N80SR-PS	CG5N80SV-PS	CG5A80SR-PS	CG5A80SV-PS
100*	CG5N100SR-PS	CG5N100SV-PS	CG5A100SR-PS	CG5A100SV-PS
Contents	Nos. 9 and 10 above		Nos. 9, 10, 11 and 12 above	

Note) A grease pack (GR-R-010, 10g) is included in seal kits.

Note) Water Resistant Scraper is not included in the Seal Kit, and must be purchased separately.

* Bore sizes 50mm and larger can be difficult to disassemble. Contact SMC when disassembly/repair is required on the larger sizes. See page 44 for more information regarding seal replacement. Note) A grease pack (GR-R-010, 10g) is included in seal kits.

Dimensions

Basic type (B)/C□G5BN□S \bar{R} : With rubber bumper

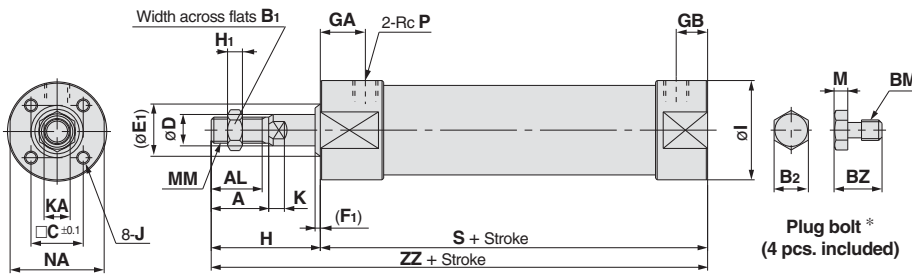

X165US inch rod option dimensional changes

Dim. Bore size	A	AL	B1	H	H1	MM	ZZ
20	14	12.7	11.0	25.4	4.0	1/4-28	108.4
25	14	12.7	12.6	28.4	4.8	5/16-24	111.4
32	21	19	17.3	41.4	6.4	7/16-20	126.4
40	19	16.6	17.3	41.4	6.4	7/16-20	134.4
50	22.4	19.8	18.8	52.6	7.9	1/2-20	161.6
63	22.4	19.8	18.8	52.6	7.9	1/2-20	161.6
80*	25.4	22.9	23.9	63.5	9.7	5/8-18	193.5
100*	31.8	29.3	27.8	69.9	10.7	3/4-16	200.9

* 80 and 100mm-X165US are a future release.

(mm)

Bore size (mm)	Stroke range	A	AL	B1	B2	BM	BZ	C	D	E1	F1	GA	GB	H	H1	I	J	K	KA	M	MM	NA	P	S	ZZ
20	to 350	18	15.5	13	7	M4 x 0.7	9	16.5	8	15	3	18	12	35	5	31	M4 x 0.7 depth 7	5	6	3	M8 x 1.25	29	1/8	83	118
25	to 400	22	19.5	17	8	M5 x 0.8	9.5	18.5	10	17	3	18	12	40	6	33	M5 x 0.8 depth 8	5.5	8	3.5	M10 x 1.25	29	1/8	83	123
32	to 450	22	19.5	17	8	M5 x 0.8	9.5	20	12	19	3	18	12	40	6	38	M5 x 0.8 depth 8	5.5	10	3.5	M10 x 1.25	35.5	1/8	85	125
40	to 800	30	27	19	10	M6 x 1.0	12	26	16	23	3	19	13	50	8	47	M6 x 1.0 depth 12	6	14	4	M14 x 1.5	44	1/8	93	143
50	to 1200	35	32	27	13	M8 x 1.25	15.5	32	20	28	3	21	14	58	11	58	M8 x 1.25 depth 16	7	18	5.5	M18 x 1.5	55	1/4	109	167
63	to 1200	35	32	27	17	M10 x 1.5	19	38	20	28	3	21	14	58	11	72	M10 x 1.5 depth 16	7	18	7	M18 x 1.5	69	1/4	109	167
80	to 1400	40	37	32	17	M10 x 1.5	19	50	25	33	3	28	20	71	13	89	M10 x 1.5 depth 22	10	22	7	M22 x 1.5	80	3/8	130	201
100	to 1500	40	37	41	19	M12 x 1.75	24	60	30	38	3	29	20	71	16	110	M12 x 1.75 depth 23	10	26	8	M26 x 1.5	100	1/2	131	202

* Install plug bolts, which are included, in any unused mounting holes.

Basic type (B)/C□G5BA□S \bar{R} : With air cushion

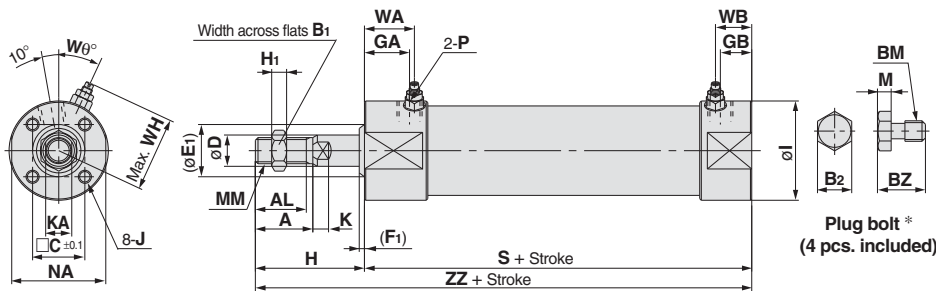

X165US inch rod option dimensional changes

Dim. Bore size	A	AL	B1	H	H1	MM	ZZ
20	14	12.7	11.0	25.4	4.0	1/4-28	108.4
25	14	12.7	12.6	28.4	4.8	5/16-24	111.4
32	21	19	17.3	41.4	6.4	7/16-20	126.4
40	19	16.6	17.3	41.4	6.4	7/16-20	134.4
50	22.4	19.8	18.8	52.6	7.9	1/2-20	161.6
63	22.4	19.8	18.8	52.6	7.9	1/2-20	161.6
80*	25.4	22.9	23.9	63.5	9.7	5/8-18	193.5
100*	31.8	29.3	27.8	69.9	10.7	3/4-16	200.9

* 80 and 100mm-X165US are a future release.

(mm)

Bore size (mm)	Stroke range	A	AL	B1	B2	BM	BZ	C	D	E1	F1	GA	GB	H	H1	I	J	K	KA	M	MM	NA
20	to 350	18	15.5	13	7	M4 x 0.7	9	16.5	8	15	3	18	12	35	5	31	M4 x 0.7 depth 7	5	6	3	M8 x 1.25	29
25	to 400	22	19.5	17	8	M5 x 0.8	9.5	18.5	10	17	3	18	12	40	6	33	M5 x 0.8 depth 8	5.5	8	3.5	M10 x 1.25	29
32	to 450	22	19.5	17	8	M5 x 0.8	9.5	20	12	19	3	18	12	40	6	38	M5 x 0.8 depth 8	5.5	10	3.5	M10 x 1.25	35.5
40	to 800	30	27	19	10	M6 x 1.0	12	26	16	23	3	19	13	50	8	47	M6 x 1.0 depth 12	6	14	4	M14 x 1.5	44
50	to 1200	35	32	27	13	M8 x 1.25	15.5	32	20	28	3	21	14	58	11	58	M8 x 1.25 depth 16	7	18	5.5	M18 x 1.5	55
63	to 1200	35	32	27	17	M10 x 1.5	19	38	20	28	3	21	14	58	11	72	M10 x 1.5 depth 16	7	18	7	M18 x 1.5	69
80	to 1400	40	37	32	17	M10 x 1.5	19	50	25	33	3	28	20	71	13	89	M10 x 1.5 depth 22	10	22	7	M22 x 1.5	80
100	to 1500	40	37	41	19	M12 x 1.75	24	60	30	38	3	29	20	71	16	110	M12 x 1.75 depth 23	10	26	8	M26 x 1.5	100

* Install plug bolts, which are included, in any unused mounting holes.

(mm)

Bore size (mm)	P	S	WA	WB	WH	Wθ	ZZ
20	M5 x 0.8	83	22	16	23	30°	118
25	M5 x 0.8	83	22	16	25	30°	123
32	1/8	85	22	16	28.5	25°	125
40	1/8	93	22	16	33	20°	143
50	1/4	109	25	18	40.5	20°	167
63	1/4	109	25	18	47.5	20°	167
80	3/8	130	30	22	60.5	20°	201
100	1/2	131	31	22	71	20°	202

Series CG5-S

Dimensions

Axial foot type (L)/C□G5LN□S_V^R

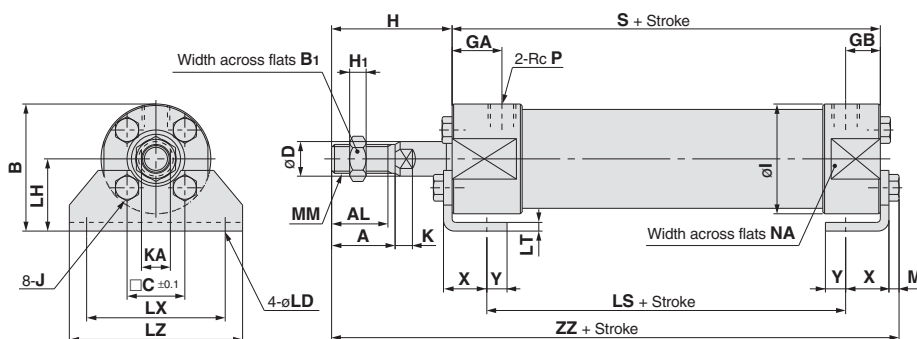

X165US inch rod option dimensional changes

Dim. Bore size	A	AL	B1	H	H1	MM	ZZ
20	14	12.7	11.0	25.4	4.0	1/4-28	114.4
25	14	12.7	12.6	28.4	4.8	5/16-24	117.9
32	21	19	17.3	41.4	6.4	7/16-20	132.9
40	19	16.6	17.3	41.4	6.4	7/16-20	141.4
50	22.4	19.8	18.8	52.6	7.9	1/2-20	171.1
63	22.4	19.8	18.8	52.6	7.9	1/2-20	172.6
80*	25.4	22.9	23.9	63.5	9.7	5/8-18	204.5
100*	31.8	29.3	27.8	69.9	10.7	3/4-16	214.9

* 80 and 100mm-X165US are a future release.

(mm)

Bore size (mm)	Stroke range	A	AL	B1	B	C	D	GA	GB	H	H1	I	J	K	KA	LD	LH	LS	LT	LX	LZ	M	MM	NA	P	S	X	Y	ZZ
20	to 350	18	15.5	13	37.5	16.5	8	18	12	35	5	31	M4 x 0.7	5	6	6	22	59	3	40	50	3	M8 x 1.25	29	1/8	83	15	7	124
25	to 400	22	19.5	17	41.5	18.5	10	18	12	40	6	33	M5 x 0.8	5.5	8	6	25	59	3	44	60	3.5	M10 x 1.25	29	1/8	83	15	7	129.5
32	to 450	22	19.5	17	44	20	12	18	12	40	6	38	M5 x 0.8	5.5	10	7.2	25	59	3	44	60	3.5	M10 x 1.25	35.5	1/8	85	16	6	131.5
40	to 800	30	27	19	53.5	26	16	19	13	50	8	47	M6 x 1.0	6	14	7.2	30	66	3	54	75	4	M14 x 1.5	44	1/8	93	16.5	6.5	150
50	to 1200	35	32	27	69	32	20	21	14	58	11	58	M8 x 1.25	7	18	10	40	74	4	66	90	5.5	M18 x 1.5	55	1/4	109	21.5	11.5	176.5
63	to 1200	35	32	27	81	38	20	21	14	58	11	72	M10 x 1.5	7	18	12	45	74	4	82	110	7	M18 x 1.5	69	1/4	109	21.5	11.5	178
80	to 1400	40	37	32	99.5	50	25	28	20	71	13	89	M10 x 1.5	10	22	12	55	82	4	100	130	7	M22 x 1.5	80	3/8	130	28	17	212
100	to 1500	40	37	41	125	60	30	29	20	71	16	110	M12 x 1.75	10	26	14	70	83	6	120	160	8	M26 x 1.5	100	1/2	131	30	15	216

* Foot brackets and plug bolts are installed before shipment from factory.

Front flange type (F)/C□G5FN□S_V^R

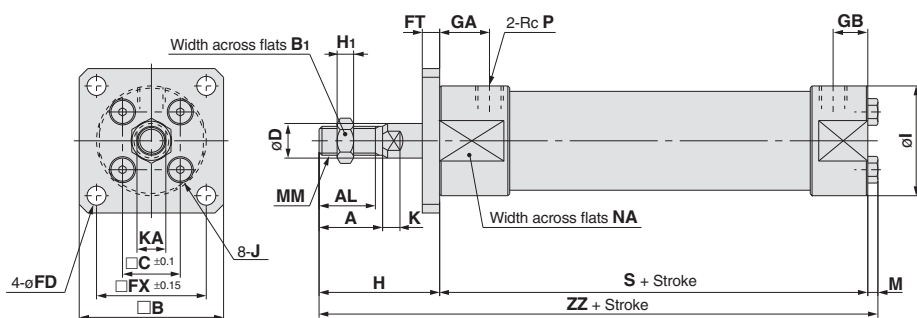

X165US inch rod option dimensional changes

Dim. Bore size	A	AL	B1	H	H1	MM	ZZ
20	14	12.7	11.0	25.4	4.0	1/4-28	111.4
25	14	12.7	12.6	28.4	4.8	5/16-24	114.9
32	21	19	17.3	41.4	6.4	7/16-20	129.9
40	19	16.6	17.3	41.4	6.4	7/16-20	138.4
50	22.4	19.8	18.8	52.6	7.9	1/2-20	167.1
63	22.4	19.8	18.8	52.6	7.9	1/2-20	168.6
80*	25.4	22.9	23.9	63.5	9.7	5/8-18	200.5
100*	31.8	29.3	27.8	69.9	10.7	3/4-16	208.9

* 80 and 100mm-X165US are a future release.

(mm)

Bore size (mm)	Stroke range	A	AL	B1	B	C	D	FX	FD	FT	GA	GB	H	H1	I	J	K	KA	M	MM	NA	P	S	ZZ
20	to 350	18	15.5	13	50	16.5	8	36	5.5	6	18	12	35	5	31	M4 x 0.7	5	6	3	M8 x 1.25	29	1/8	83	121
25	to 400	22	19.5	17	50	18.5	10	36	5.5	6	18	12	40	6	33	M5 x 0.8	5.5	8	3.5	M10 x 1.25	29	1/8	83	126.5
32	to 450	22	19.5	17	50	20	12	38	6.6	6	18	12	40	6	38	M5 x 0.8	5.5	10	3.5	M10 x 1.25	35.5	1/8	85	128.5
40	to 800	30	27	19	60	26	16	46	6.6	6	19	13	50	8	47	M6 x 1.0	6	14	4	M14 x 1.5	44	1/8	93	147
50	to 1200	35	32	27	75	32	20	58	9	9	21	14	58	11	58	M8 x 1.25	7	18	5.5	M18 x 1.5	55	1/4	109	172.5
63	to 1200	35	32	27	90	38	20	70	11	9	21	14	58	11	72	M10 x 1.5	7	18	7	M18 x 1.5	69	1/4	109	174
80	to 1400	40	37	32	100	50	25	82	11	9	28	20	71	13	89	M10 x 1.5	10	22	7	M22 x 1.5	80	3/8	130	208
100	to 1500	40	37	41	125	60	30	100	14	10	29	20	71	16	110	M12 x 1.75	10	26	8	M26 x 1.5	100	1/2	131	210

* Foot brackets and plug bolts are installed before shipment from factory.

Dimensions

Rear flange type (G)/C□G5GN□S_V^R

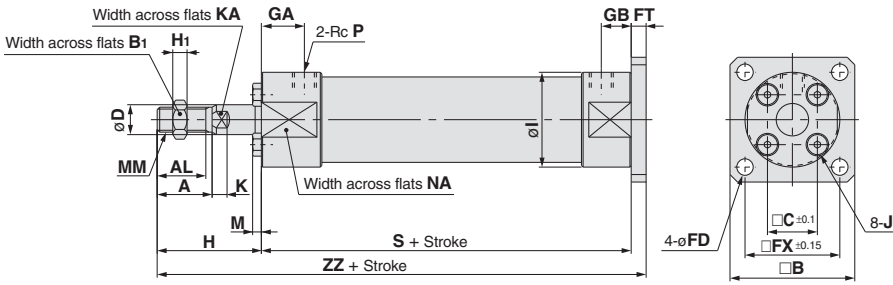

X165US inch rod option dimensional changes

Dim. Bore size	A	AL	B1	H	H1	MM	ZZ
20	14	12.7	11.0	25.4	4.0	1/4-28	114.4
25	14	12.7	12.6	28.4	4.8	5/16-24	117.4
32	21	19	17.3	41.4	6.4	7/16-20	132.4
40	19	16.6	17.3	41.4	6.4	7/16-20	140.4
50	22.4	19.8	18.8	52.6	7.9	1/2-20	170.6
63	22.4	19.8	18.8	52.6	7.9	1/2-20	170.6
80*	25.4	22.9	23.9	63.5	9.7	5/8-18	202.5
100*	31.8	29.3	27.8	69.9	10.7	3/4-16	210.9

* 80 and 100mm-X165US are a future release. (mm)

Bore size (mm)	Stroke range	A	AL	B1	B	C	D	FX	FD	FT	GA	GB	H	H1	I	J	K	KA	M	MM	NA	P	S	ZZ
20	to 200	18	15.5	13	50	16.5	8	36	5.5	6	18	12	35	5	31	M4 x 0.7	5	6	3	M8 x 1.25	29	1/8	83	124
25	to 300	22	19.5	17	50	18.5	10	36	5.5	6	18	12	40	6	33	M5 x 0.8	5.5	8	3.5	M10 x 1.25	29	1/8	83	129
32	to 300	22	19.5	17	50	20	12	38	6.6	6	18	12	40	6	38	M5 x 0.8	5.5	10	3.5	M10 x 1.25	35.5	1/8	85	131
40	to 500	30	27	19	60	26	16	46	6.6	6	19	13	50	8	47	M6 x 1.0	6	14	4	M14 x 1.5	44	1/8	93	149
50	to 600	35	32	27	75	32	20	58	9	9	21	14	58	11	58	M8 x 1.25	7	18	5.5	M18 x 1.5	55	1/4	109	176
63	to 600	35	32	27	90	38	20	70	11	9	21	14	58	11	72	M10 x 1.5	7	18	7	M18 x 1.5	69	1/4	109	176
80	to 750	40	37	32	100	50	25	82	11	9	28	20	71	13	89	M10 x 1.5	10	22	7	M22 x 1.5	80	3/8	130	210
100	to 750	40	37	41	125	60	30	100	14	10	29	20	71	16	110	M12 x 1.75	10	26	8	M26 x 1.5	100	1/2	131	212

* Flange brackets and plug bolts are installed before shipment from factory.

Integral clevis type (E)/C□G5EN□S_V^R

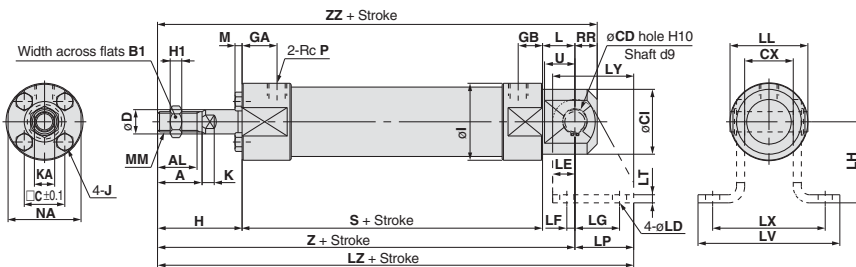

X165US inch rod option dimensional changes

Dim. Bore size	A	AL	B1	H	H1	MM	Z	ZZ	LZ
20	14	12.7	11.0	25.4	4.0	1/4-28	122.4	131.4	143.4
25	14	12.7	12.6	28.4	4.8	5/16-24	125.4	134.4	146.4
32	21	19	17.3	41.4	6.4	7/16-20	142.4	153.4	171.4
40	19	16.6	17.3	41.4	6.4	7/16-20	150.4	161.4	179.4
50	22.4	19.8	18.8	52.6	7.9	1/2-20	183.6	198.6	218.6
63	22.4	19.8	18.8	52.6	7.9	1/2-20	183.6	198.6	218.6
80*	25.4	22.9	23.9	63.5	9.7	5/8-18	225.6	248.6	282.6
100*	31.8	29.3	27.8	69.9	10.7	3/4-16	233.9	256.9	290.9

* 80 and 100mm-X165US are a future release. (mm)

Bore size (mm)	Stroke range	A	AL	B1	C	CD (hole)	CI	CX	D	GA	GB	H	H1	I	J	K	KA	L	M	MM	NA	P
20	to 200	18	15.5	13	16.5	8 ^{+0.058} ₀	25	16 ⁰ _{-0.2}	8	18	12	35	5	31	M4 x 0.7	5	6	14	3	M8 x 1.25	29	1/8
25	to 300	22	19.5	17	18.5	8 ^{+0.058} ₀	27	16 ⁰ _{-0.2}	10	18	12	40	6	33	M5 x 0.8	5.5	8	14	3.5	M10 x 1.25	29	1/8
32	to 300	22	19.5	17	20	10 ^{+0.058} ₀	32	24 ⁰ _{-0.2}	12	18	12	40	6	38	M5 x 0.8	5.5	10	16	3.5	M10 x 1.25	35.5	1/8
40	to 500	30	27	19	26	10 ^{+0.058} ₀	40	24 ⁰ _{-0.2}	16	19	13	50	8	47	M6 x 1.0	6	14	16	4	M14 x 1.5	44	1/8
50	to 600	35	32	27	32	14 ^{+0.070} ₀	50	40 ⁰ _{-0.2}	20	21	14	58	11	58	M8 x 1.25	7	18	22	5.5	M18 x 1.5	55	1/4
63	to 600	35	32	27	38	14 ^{+0.070} ₀	60	40 ⁰ _{-0.2}	20	21	14	58	11	72	M10 x 1.5	7	18	22	7	M18 x 1.5	69	1/4
80	to 750	40	37	32	50	22 ^{+0.084} ₀	75	60 ⁰ _{-0.3}	25	28	20	71	13	89	M10 x 1.5	10	22	33	7	M22 x 1.5	80	3/8
100	to 750	40	37	41	60	22 ^{+0.084} ₀	90	60 ⁰ _{-0.3}	30	29	20	71	16	110	M12 x 1.75	10	26	33	8	M26 x 1.5	100	1/2

Bore size (mm)	RR	S	U	Z	ZZ	Trunnion bracket	CD (shaft)	LD	LE	LF	LG	LH	LL	LP	LT	LV	LX	LY	LZ
20	9	83	13	132	141	CG-E020SUS	8 ^{-0.040} _{-0.076}	7	9	2	14	30	27.6	21	3	56.5	42	30	153
25	9	83	13	137	146	CG-E020SUS	8 ^{-0.040} _{-0.076}	7	9	2	14	30	27.6	21	3	56.5	42	30	158
32	11	85	15	141	152	CG-E032SUS	10 ^{-0.040} _{-0.076}	7	11	4	22	40	38.4	29	4	70.5	56	40	170
40	11	93	15	159	170	CG-E032SUS	10 ^{-0.040} _{-0.076}	7	11	4	22	40	38.4	29	4	70.5	56	40	188
50	15	109	21	189	204	CG-E050SUS	14 ^{-0.050} _{-0.093}	12	15	5	25	50	59.6	35	6	106.5	84	50	224
63	15	109	21	189	204	CG-E050SUS	14 ^{-0.050} _{-0.093}	12	15	5	25	50	59.6	35	6	106.5	84	50	224
80*	23	130	32	234	257	CG-E080SUS	22 ^{-0.065} _{-0.117}	14	23	6	40	80	87.2	57	9	144.5	120	80	291
100*	23	131	32	235	258	CG-E080SUS	22 ^{-0.065} _{-0.117}	14	23	6	40	80	87.2	57	9	144.5	120	80	292

* Plug bolts are installed before shipment from factory. * Trunnion brackets (with clevis pin and snap ring) are optional. (Not included.)

Series CG5-S

Accessory Dimensions

Single knuckle joint

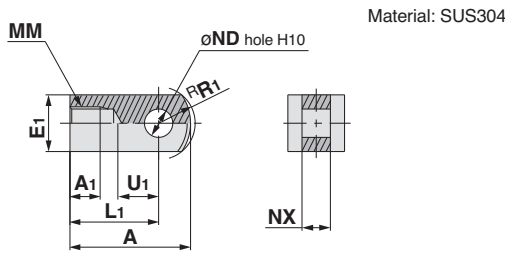

(mm)

Part no.	Applicable bore size (mm)	A	A ₁	E ₁	L ₁	MM	ND _{H10}	NX	R ₁	U ₁
I-G02SUS	20	34	8.5	□16	25	M8 x 1.25	8 ^{+0.058} ₀	8 ^{-0.2} _{-0.4}	10.3	11.5
I-G03SUS	25, 32	41	10.5	□20	30	M10 x 1.25	10 ^{+0.058} ₀	10 ^{-0.2} _{-0.4}	12.8	14
I-G04SUS	40	42	14	□22	30	M14 x 1.5	10 ^{+0.058} ₀	18 ^{-0.3} _{-0.5}	12	14
I-G05SUS	50, 63	56	18	□28	40	M18 x 1.5	14 ^{+0.070} ₀	22 ^{-0.3} _{-0.5}	16	20
I-G08SUS	80	71	21	□38	50	M22 x 1.5	18 ^{+0.070} ₀	28 ^{-0.3} _{-0.5}	21	27
I-G10SUS	100	79	21	□45	55	M26 x 1.5	22 ^{+0.084} ₀	32 ^{-0.3} _{-0.5}	24	31

Not applicable for -X165US option

Double knuckle joint

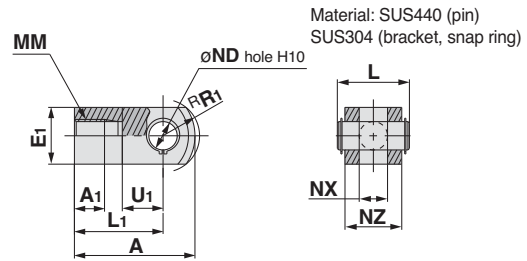

(mm)

Part no.	Applicable bore size (mm)	A	A ₁	E ₁	L	L ₁	MM	ND _{H10}	NX	NZ	R ₁	U ₁	Applicable pin no.
Y-G02SUS	20	34	8.5	16	21	25	M8 x 1.25	8 ^{+0.058} ₀	8 ^{+0.4} _{+0.2}	16	10.3	11.5	IY-G02SUS
Y-G03SUS	25, 32	41	10.5	20	25.6	30	M10 x 1.25	10 ^{+0.058} ₀	10 ^{+0.4} _{+0.2}	20	12.8	14	IY-G03SUS
Y-G04SUS	40	42	16	22	41.6	30	M14 x 1.5	10 ^{+0.058} ₀	18 ^{+0.5} _{+0.3}	36	12	14	IY-G04SUS
Y-G05SUS	50, 63	56	20	25	50.6	40	M18 x 1.5	14 ^{+0.070} ₀	22 ^{+0.5} _{+0.3}	44	16	20	IY-G05SUS
Y-G08SUS	80	71	23	35	64	50	M22 x 1.5	18 ^{+0.070} ₀	28 ^{+0.5} _{+0.3}	56	21	27	IY-G08SUS
Y-G10SUS	100	79	24	40	72	55	M26 x 1.5	22 ^{+0.084} ₀	32 ^{+0.5} _{+0.3}	64	24	31	IY-G10SUS

Not applicable for -X165US option

Knuckle joint pin

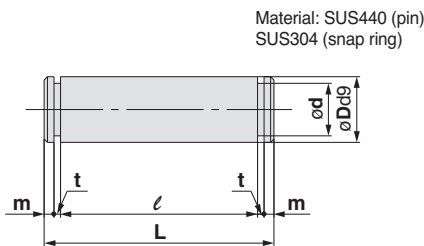

(mm)

Part no.	Applicable bore size (mm)	Dd9	d	L	l	m	t	Snap ring
IY-G02SUS	20	8 ^{-0.040} _{-0.076}	7.6	21	16.2	1.5	0.9	C type 8 for shaft
IY-G03SUS	25, 32	10 ^{-0.040} _{-0.076}	9.6	25.6	20.2	1.55	1.15	C type 10 for shaft
IY-G04SUS	40	10 ^{-0.040} _{-0.076}	9.6	41.6	36.2	1.55	1.15	C type 10 for shaft
IY-G05SUS	50, 63	14 ^{-0.050} _{-0.093}	13.4	50.6	44.2	2.05	1.15	C type 14 for shaft
IY-G08SUS	80	18 ^{-0.050} _{-0.093}	17	64	56.2	2.55	1.35	C type 18 for shaft
IY-G10SUS	100	22 ^{-0.065} _{-0.117}	21	72	64.2	2.55	1.35	C type 22 for shaft

Trunnion bracket

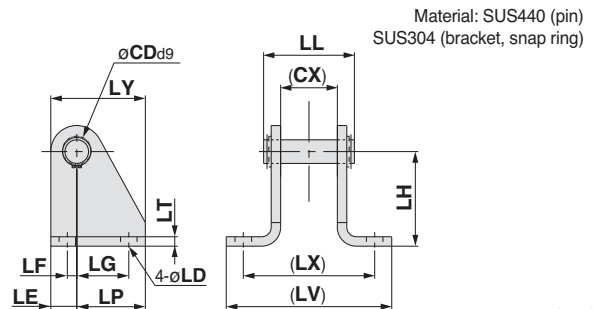

(mm)

Part no.	Applicable bore size (mm)	CD (snap ring)	CX	LD	LE	LF	LG	LH	LL	LP	LT	LV	LX	LY
CG-E020SUS	20, 25	8 ^{-0.040} _{-0.076}	16	7	9	2	14	30	27.6	21	3	56.5	42	30
CG-E032SUS	32, 40	10 ^{-0.040} _{-0.076}	24	7	11	4	22	40	38.4	29	4	70.5	56	40
CG-E050SUS	50, 63	14 ^{-0.050} _{-0.093}	40	12	15	5	25	50	59.6	35	6	106.5	84	50
CG-E080SUS	80, 100	22 ^{-0.065} _{-0.117}	60	14	23	6	40	80	87.2	57	9	144.5	120	80

Accessory Dimensions

Clevis pin

Material: SUS440 (pin)
SUS304 (snap ring)

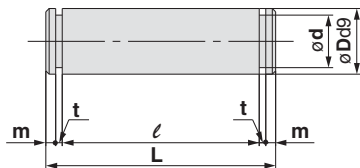

(mm)

Part no.	Applicable bore size (mm)	Dd9	d	L	l	m	t	Snap ring
CD-E02SUS	20, 25	ø8 ^{-0.040} / _{-0.076}	7.6	27.6	22.8	1.5	0.9	C type 8 for shaft
CD-E03SUS	32, 40	ø10 ^{-0.040} / _{-0.076}	9.6	38.4	33	1.55	1.15	C type 10 for shaft
CD-E05SUS	50, 63	ø14 ^{-0.050} / _{-0.093}	13.4	59.6	53.2	2.05	1.15	C type 14 for shaft
CD-E08SUS	80, 100	ø22 ^{-0.065} / _{-0.117}	21	87.2	79.4	2.55	1.35	C type 22 for shaft

Rod end nut

Material: SUS304

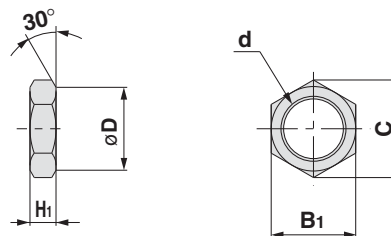

(mm)

Metric

Part no.	Applicable bore size (mm)	B ₁	C	D	d	H ₁
NT-02SUS	20	13	(15)	12.5	M8 x 1.25	5
NT-03SUS	25, 32	17	(19.6)	16.5	M10 x 1.25	6
NT-G04SUS	40	19	(21.9)	18	M14 x 1.5	8
NT-05SUS	50, 63	27	(31.2)	26	M18 x 1.5	11
NT-08SUS	80	32	(37.0)	31	M22 x 1.5	13
NT-10SUS	100	41	(47.3)	39	M26 x 1.5	16

(mm)

Inch (for X165US option cylinders)

Part no.	Applicable bore size (mm)	B ₁	C	d	H ₁
JM-025-SUS	20	11.0	12.4	1/4 -28	4.0
JM-03-SUS	25	12.6	14.2	5/16 -24	4.8
JM-045-SUS	32, 40	17.3	19.6	7/16 -20	6.4
JM-05-SUS	50, 63	18.8	21.4	1/2 -20	7.9
JM-08-SUS	80	23.9	27.4	5/8 -18	9.7
JM-10-SUS	100	28.7	33	3/4 -16	10.7

Series CJ5-S/CG5-S Auto Switch Specifications

Auto Switch Common Specifications

Type	Solid State Switch
Operating time	1 ms or less
Impact resistance	1000m/s ²
Insulation resistance	50MΩ or more at 500VDC (between lead wire and case)
Withstand voltage	1000VAC for 1 min. (between lead wire and case)
Ambient temperature	-10 to 60°C
Enclosure	IEC529 standard IP67, JISC0920 watertight construction

Lead Wire Length

The standard lead wire length for water resistant 2 color indication solid state auto switches is 3 meters. (0.5m and 1.0m is available on switches with the wired connector.)

For solid state switches with flexible specification, enter "-61" after the lead wire length.

(Example) D-H7BA- 61

Flexible specification

Lead Wire Color Changes

2 wire

	Old	New
Output (+)	Red	Brown
Output (-)	Black	Blue

Lead wire colors of SMC switches have been changed as shown below in order to meet NECA Standard 0402 for production beginning September, 1996 and thereafter. Special care should be taken regarding wire polarity during the time that the old colors still coexist with the new colors.

Auto Switch Mounting Positions and Minimum Mountable Strokes

D-H7BA

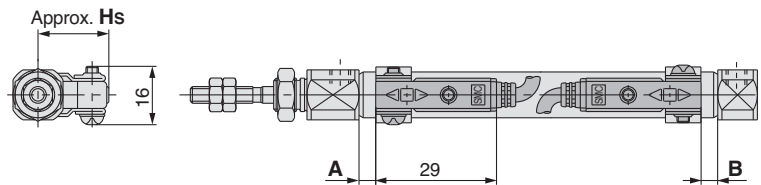

Minimum strokes for auto switch mounting

Mounting bracket	Basic type, Foot type, Flange type, Clevis type		
Number of switches	1 pc. (Rod cover side)	2 pcs. (Different sides)	2 pcs. (Same side)
Mounting surface	Port surface 	Port surface 	Port surface
Switch type			
Minimum stroke (mm)	10	15	60

Auto switch mounting positions

Applicable bore size (mm)	Auto switch model	D-H7BA		
		A	B	HS
10		0	0	17
16		0.5	0.5	20.5

D-G5BA

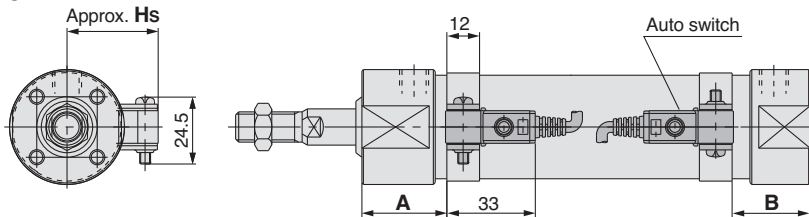

Minimum strokes for auto switch mounting

Mounting bracket	Basic type, Foot type, Flange type, Clevis type		
Number of switches	1 pc. (Rod cover side)	2 pcs. (Different sides)	2 pcs. (Same side)
Mounting surface	Port surface 	Port surface 	Port surface
Switch type			
Minimum stroke (mm)	10	15	75

Auto switch mounting position

Applicable bore size (mm)	Auto switch model	D-G5BA		
		A	B	HS
20		31.5	24	26
25		31.5	24	28.5
32		32.5	25	33
40		37	28	36.5
50		45.5	36	42
63		45.5	36	48.5
80		56	46	57.5
100		57	46	68