

# Series 10-11-CUJ

ø6, ø8, ø10, ø12, ø16, ø20  
Mini Free Mount Cylinder

## How to Order

**10 - C D UJ B 6 8 D F8N**

● Double acting

● Clean series

10	Relief type
11	Vacuum suction type

● Mounting direction

**B** Lateral mounting

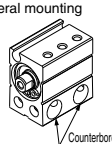

**S\*** Axial mounting

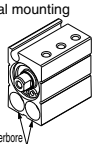

● Bore size

6	6 mm
8	8 mm
10	10 mm
12	12 mm
16	16 mm
20	20 mm

● Stroke

Refer to the table below.

● Number of auto switches

Nil	2 pcs.
S	1 pc.

\* M9□ includes one auto switch.

● Built-in magnet

Nil	No
D	Yes (Built-in)



● Auto switch

Nil	Without auto switch
-----	---------------------

\* For the applicable auto switch model, refer to next page.

● Rod end thread

Nil	Rod end female thread
M	Rod end male thread

\* The minimum stroke for auto switch mounting and operating range are the same as standard products.

## Model

\* Bore sizes 12, 16, 20 only

Relief type	Model	Bore size (mm)	Port size	Lubrication	Action	Standard stroke (mm)	Auto switch mounting	Cushion	
	Relief type	10-CUJ□6	6	M3 x 0.5	Non-lube	Double acting, Single rod	4, 6, 8, 10, 15	○	None
10-CUJ□8		8	M3 x 0.5	4, 6, 8, 10, 15, 20					
10-CUJ□10		10	M3 x 0.5	4, 6, 8, 10, 15, 20					
10-CUJ□12		12	M3 x 0.5	5, 10, 15, 20, 25, 30					
10-CUJ□16		16	M3 x 0.5	5, 10, 15, 20, 25, 30					
10-CUJ□20	20	M5 x 0.8	5, 10, 15, 20, 25, 30, 35, 40, 45, 50	Rubber bumper					
Vacuum suction type	11-CUJ□6	6	M3 x 0.5				4, 6, 8, 10, 15		None
	11-CUJ□8	8	M3 x 0.5				4, 6, 8, 10, 15, 20		
	11-CUJ□10	10	M3 x 0.5				4, 6, 8, 10, 15, 20		
	11-CUJ□12	12	M3 x 0.5				5, 10, 15, 20, 25, 30		
	11-CUJ□16	16	M3 x 0.5	5, 10, 15, 20, 25, 30					
	11-CUJ□20	20	M5 x 0.8	5, 10, 15, 20, 25, 30, 35, 40, 45, 50	Rubber bumper				

## Specifications

Bore size (mm)	6	8	10	12	16	20
<b>Action</b>	Double acting					
<b>Fluid</b>	Air					
<b>Proof pressure</b>	1.05 MPa					
<b>Minimum operating pressure</b>	Double acting	0.15 MPa	0.1 MPa	0.07 MPa	0.05 MPa	
<b>Maximum operating pressure</b>	0.7 MPa					
<b>Ambient and fluid temperature</b>	Without auto switch: -10°C to 70°C (No freezing). With auto switch: -10°C to 60°C (No freezing)					
<b>Cushion</b>	None			Rubber bumper		
<b>Lubrication</b>	Non-lube					
<b>Piston speed</b>	50 to 400 mm/s					
<b>Stroke length tolerance</b>	+0.5 0			+1.0 0		
<b>Mounting</b>	Through-hole			CUJB: Through-hole (Lateral, axial direction: 2 locations each) CUJS: Through-hole (Axial direction: 2 locations)		
<b>Grease</b>	Fluorine grease					
<b>Cleanliness class (ISO class)</b>	10-: Class 4, 11-: Class 3					

## Suction Flow Rate of Vacuum Suction Type (Reference values)

Bore size	Suction flow rate L/min (ANR)
6/8	2
10	3
12	4
16	6
20	8

**Auto Switch Specifications** (Refer to the **WEB catalog** for detailed specifications and auto switches not in the following table.)

Type	Special function	Electrical entry	Indicator light	Wiring (Output)	Load voltage		Auto switch model		Lead wire length (m)*			Applicable load		
					DC	AC	Electrical entry direction		0.5 (Nil)	3 (L)	5 (Z)			
							Perpendicular	In-line						
Solid state auto switch	—	Grommet	Yes	3-wire (NPN)	24 V	5 V, 12 V	—	—	M9N	●	●	○	—	Relay, PLC
								F8N	—	●	●	○		
				—	M9B	●	●	○						
				F8B	—	●	●	○						
				2-wire		12 V								

\* Lead wire length symbols: 0.5 m.....Nil (Example) F8N  
 3 m.....L (Example) F8NL  
 \* Auto switches marked with "○" are produced upon receipt of order.

Refer to page 889 for the applicable auto switch list.

**Auto switch Proper Mounting Position (Detection at Stroke End)**

D-F8□

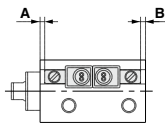

D-M9□/M9□W/M9□A

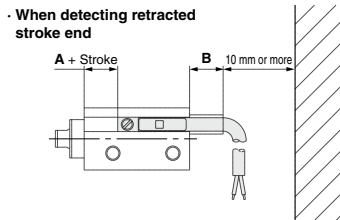
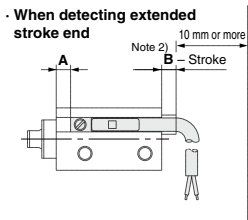

Bore size (mm)	D-F8□				D-M9□/M9□W D-M9□A			
	Double acting		Single acting		Double acting		Single acting	
	A	B	A	B	A	B	A	B
6								
8	1	1	1	1	3	7	3	7
10								
12	2	1	3.5	1	4	7	5.5	7
16	3	1	3	1	5	6.5	5	6.5
20	5	2	5	2	7	6	7	6

Note 1) Solid state auto switch D-M9□/M9□W/M9□A: With 1 pc.  
 Note 2) Provide a clearance of 10 mm or more in addition to the above dimensions to prevent the lead wire interference.  
 Note 3) Adjust the mounting position after confirming the auto switch operation.

**Dimensions**  $\phi 6$  to  $\phi 10$

$\frac{10}{11}$ -C(D)UJB

Note 1) The angular position of the width across flats with respect to the tube is not fixed.

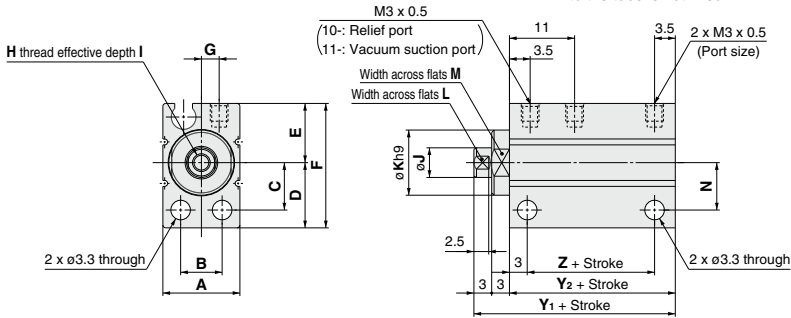

**Rod end male thread**

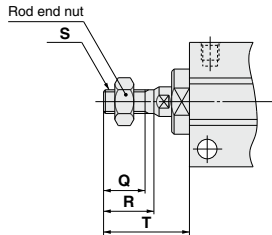

**Rod end nut (Accessory)**

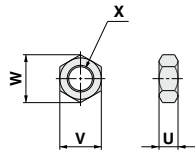

**Rod end male thread** (mm)

Bore size	Q	R	S	T
6	5.5	6.5	M3 x 0.5	12.5
8	7	8.5	M4 x 0.7	14.5
10	9	10.5	M5 x 0.8	16.5

(mm)

Part no.	Applicable bore size	U	V	W	X
<b>NTJ-006A</b>	6	2.4	5.5	6.4	M3 x 0.5
<b>NTJ-010A</b>	8	3.2	7	8.1	M4 x 0.7
<b>NTJ-015A</b>	10	4	8	9.2	M5 x 0.8

**Standard**

Bore size	A	B	C	D	E	F	G	H	I	J	K	L	M	N
6	13	7	7	10	9	19	3	M2.5 x 0.45	5	4	9	3.5	8	7
8	13	7	8	11	10	21	3	M3 x 0.5	6	5	11	4.5	10	8
10	13.5	7	8.5	11.5	10.5	22	3.2	M3 x 0.5	6	6	12	5	11	8.5

Bore size	Without magnet			Built-in magnet		
	Y <sub>1</sub>	Y <sub>2</sub>	Z	Y <sub>1</sub>	Y <sub>2</sub>	Z
6	24	18	11.5	29	23	16.5
8	24	18	11.5	29	23	16.5
10	24	18	11.5	29	23	16.5

**Dimensions**  $\varnothing 12$  to  $\varnothing 20$

$\frac{10}{11}$ -C(D)UJB

**Lateral mounting**

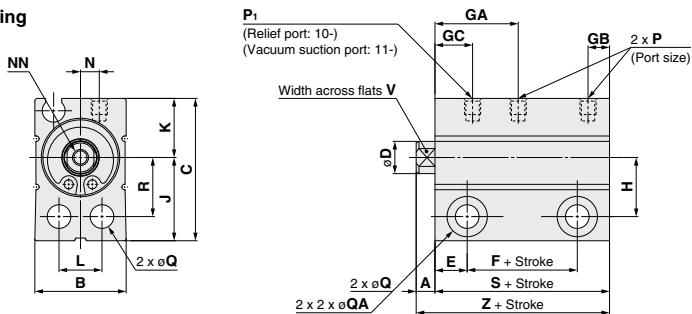

**Axial mounting**

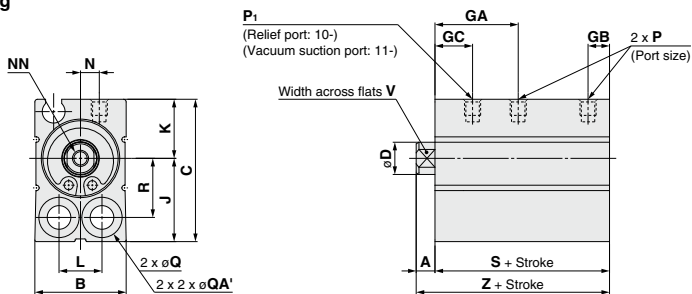

**Rod end male thread**

**Rod end nut**

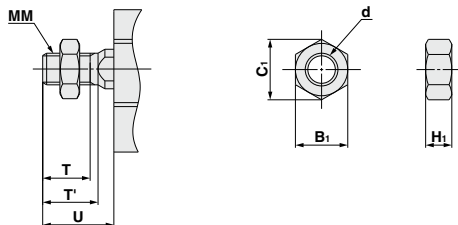

(mm)					
Part no.	Bore size (mm)	d	H <sub>1</sub>	B <sub>1</sub>	C <sub>1</sub>
<b>NTJ-015A</b>	12	M5 x 0.8	4	8	9.2
<b>NT-015A</b>	16	M6 x 1	5	10	11.5
<b>NT-02</b>	20	M8 x 1.25	5	13	15

(mm)																
Bore size (mm)	A	B	C	D	E	GB	GC	H	J	K	L	MM	NN	N	P <sub>1</sub>	P
12	3.5	17	26.5	6	6	4	7	11	15.5	11	8	M5 x 0.8	M3 x 0.5 effective depth of thread 6	3.5	M3 x 0.5	M3 x 0.5
16	3.5	21	29.5	8	6	4	8.5	12.5	17	12.5	11.5	M6 x 1	M4 x 0.7 effective depth of thread 8	5.5	M3 x 0.5	M3 x 0.5
20	4.5	25	36	10	7	5.5	8.5	15.5	21	15	13.5	M8 x 1.25	M5 x 0.8 effective depth of thread 7	7	M5 x 0.8	M5 x 0.8

Bore size (mm)	Q	QA	QA'	R	T	T'	U	V	Without magnet				Built-in magnet			
									F	GA	S	Z	F	GA	S	Z
									12	4.4 through	Counterbore diameter 7.5, depth 7	Counterbore diameter 7.5, depth 5.5	11	9	10.5	14
16	4.4 through	Counterbore diameter 7.5, depth 7	Counterbore diameter 7.5, depth 5.5	12.5	10	12	15.5	6	13.5	17.5	25.5	29	18	18	30	33.5
20	5.5 through	Counterbore diameter 9.5, depth 9	Counterbore diameter 9.5, depth 6.5	15.5	12	14	18.5	8	15.5	18.5	29.5	34	19.5	18.5	33.5	38

## ⚠ Specific Product Precautions

Be sure to read this before handling.

### Design

#### ⚠ Warning

Do not use an exhaust center. If its use cannot be avoided, use an lurching prevention circuit, or consult with SMC.

### Mounting

#### ⚠ Caution

1. When mounting a mini free mount cylinder, tighten the bolts with the proper tightening torque.

Applicable bore size (mm)	Bolt	Proper tightening torque (N·m)*
<b>6</b>	M3 x 0.5	1.06±20% (0.848 to 1.272)
<b>8</b>		
<b>10</b>		
<b>12</b>	M4 x 0.7	3.27±20% (2.61 to 3.92)
<b>16</b>		
<b>20</b>	M5 x 0.8	6.6±20% (5.28 to 7.92)

\* Torque coefficient: 0.2

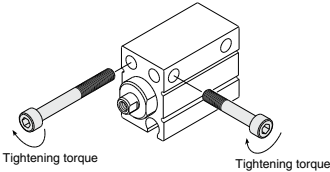

2. Mounting the bolt from the rod side with a  $\phi 12$  to  $\phi 20$  lateral mounting body may result in interference with the workpiece. Use an axial mounting body.

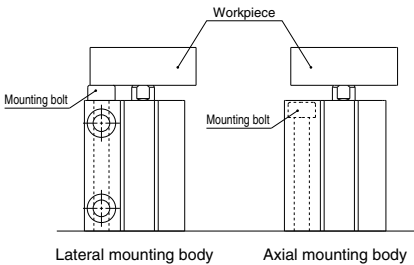

3. Use caution especially when multiple cylinders are used in parallel such as stacking because the dimensions of the body's width have plus tolerances. Contact SMC for information on a product with body width dimensions having different tolerances. ( $\phi 6$ ,  $\phi 8$ ,  $\phi 10$  only)

4. If the cylinder's mounting surface is not sufficiently flat, it may result in malfunction. We recommend that the cylinder's mounting surface flatness should be 1/100 mm or less.

### Allowable Kinetic Energy

#### ⚠ Caution

When driving an inertial load, operate a cylinder with kinetic energy within the allowable value. The range in the chart below that is delineated by bold solid lines indicates the relationship between load mass and maximum driving speeds.

Bore size (mm)	6	8	10	12	16	20
Piston speed (m/s)	0.05 to 0.5					
Allowable kinetic energy (J)	$6.25 \times 10^{-3}$	$9.35 \times 10^{-3}$	$12.5 \times 10^{-3}$	0.030	0.053	0.077

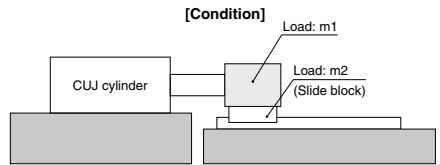
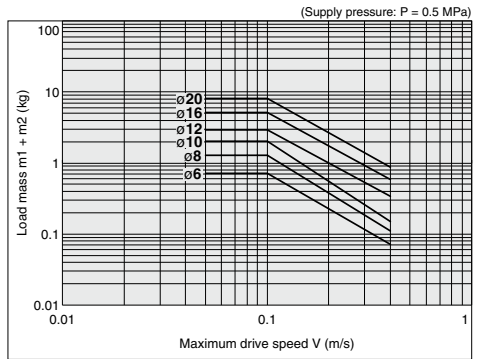

Directional Control Valves  
 Air Cylinders  
 Rotary Actuators  
 Air Grippers  
 Air Preparation Equipment  
 Modular F. R.  
 Pressure Control Equipment  
 Fittings & Tubing  
 Flow Control Equipment  
 Pressure Switches/ Pressure Sensors

## ⚠ Specific Product Precautions

Be sure to read this before handling.

### Selection

Strictly observe the limiting range of lateral load on a piston rod. (Refer to the graphs below.) If this product is used beyond the limits, it may shorten the machine life or cause damage.

**Double acting, Female thread, Without magnet  
(Without auto switch)**

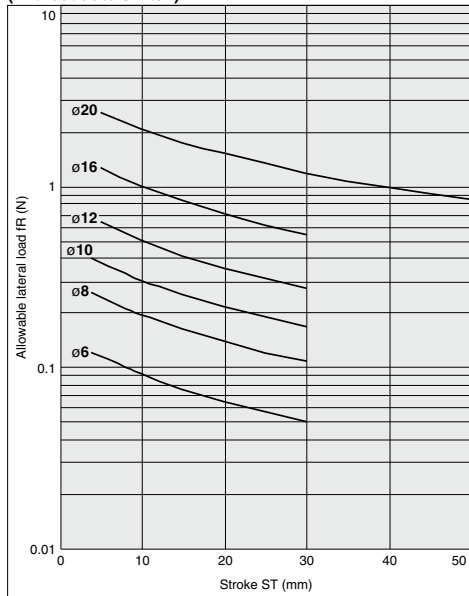

**Double acting, Female thread, With magnet  
(With auto switch)**

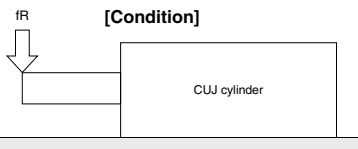
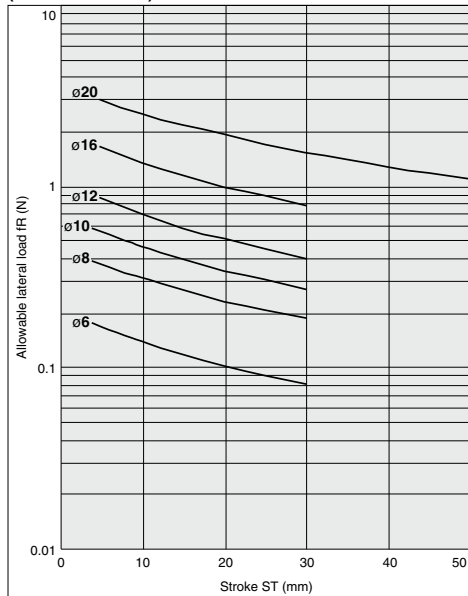

## ⚠ Caution

Adjust the cylinder drive speed by installing a speed controller, beginning at a low speed and gradually adjusting to the specified speed.