

Series 11-22-MXP/MXPJ6

ø6, ø10, ø12, ø16
Air Slide Table

RoHS

How to Order

● **Clean series**
11 Vacuum suction type

11 — MXP 12 — 15 — — — M9N — —

22 — MXP 12 — 15 — — — M9N — —

● **Copper, fluorine and silicone-free + Low particle generation**
22 Vacuum suction type

● **Bore size - Stroke (mm)**

6	5, 10
10	10, 20
12	15, 25
16	20, 30

● **Adjuster option**

Nil	Rubber stopper
C	Metal stopper
H	Without adjuster

* Adjuster for the 11-MXP6 series is available for one side only. Without adjuster type is not available for the 11-MXP6 series.

● **Number of auto switches**

Nil	2 pcs.
S	1 pc.
n	n pcs.

● **Auto switch**

Nil	Without auto switch
-----	---------------------

* Refer to the table below for auto switch part numbers.

● **Magnet/Switch rail**

Nil	With magnet and rail
N	Without magnet and rail

* Auto switch cannot be mounted on types without magnet and rail (N).



11-MXP

How to Order MXPJ6

● **Clean series**
11 Vacuum suction type

11 — MXPJ6 — 10

22 — MXPJ6 — 10

● **Copper, fluorine and silicone-free + Low particle generation**
22 Vacuum suction type

* With auto switch type is not available for the 11-MXPJ6 series.

● **Stroke**

5	5 mm
10	10 mm



11-MXPJ6

Auto Switch Specifications (Refer to the WEB catalog for detailed specifications and auto switches not in the following table.)

Type	Special function	Electrical entry	Indicator light	Wiring (Output)	Load voltage		Auto switch model		Lead wire length (m) [*]		Applicable load	
					DC	AC	Electrical entry direction		0.5 (Nil)	3 (L)		
Reed auto switch	—	Grommet	Yes	2-wire	24 V	12 V	100 V	A93	●	●	—	Relay, PLC
Solid state auto switch	—	Grommet	Yes	3-wire (NPN)	24 V	12 V	—	M9N	●	●	—	Relay, PLC
				2-wire		M9B		●	●	—		

* Lead wire length symbols 0.5 m.....Nil (Example) A93
3 m.....L A93L

PLC: Programmable Logic Controller

Refer to page 889 for the applicable auto switch list.

Specifications

Model	11-22-MXPJ6	11-22-MXP6	11-22-MXP10	11-22-MXP12	11-22-MXP16
Bore size (mm)	6	6	10	12	16
Piping port size	M3 x 0.5		M5 x 0.8		
Fluid	Air				
Action	Double acting				
Operating pressure	0.15 to 0.7 MPa				
Proof pressure	1.05 MPa				
Ambient and fluid temperature	-10 to 60°C				
Operating speed range (Average operating speed)*1	30 to 200 mm/s				
Cushion	Rubber bumper	Rubber bumper (Rubber stopper)			
		—	Rubber bumper (Without adjuster)		
		No (Metal stopper)			
Lubrication	Non-lube				
Adjuster	—	Standard equipment (MXP6 : Adjustable on one side only)			
Stroke adjustment range	Rubber stopper	—	0 to 5 mm on one side only	0 to 3 mm at both ends	
	Metal stopper	—	0 to 6 mm on one side only	0 to 5 mm at both ends	0 to 4 mm at both ends
Stroke length tolerance	±0.05 mm				
Grease	11-: Fluorine grease				
	22-: Lithium soap based grease				
Cleanliness class (ISO class)	Without adjuster	Class 3	—	Class 3	
	Rubber stopper	—	Class 4	Class 4	
	Metal stopper	—	Class 6	Class 6	

*1 Average operating speed: Speed that the stroke is divided by a period of time from starting the operation to reaching the end.

Suction Flow Rate of Vacuum Type (Reference values)

Size	Suction flow rate L/min (ANR)
6	1
10	3
12	4
16	6

Directional Control Valves

Air Cylinders

Rotary Actuators

Air Grippers

Air Preparation Equipment

Modular F. R.

Pressure Control Equipment

Fittings & Tubing

Flow Control Equipment

Pressure Switches/ Pressure Sensors

Auto Switch Proper Mounting Position (Detection at Stroke End)

11-22-MXP6

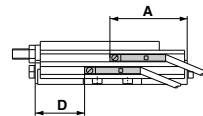
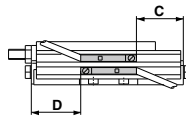
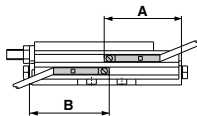

Reed auto switch D-A93

Model	Stroke (mm)				Auto switch operating range
	10	15	20	30	
11-22-MXP6	A	34.5	—	—	5
	B	35.5	—	—	
	C	14.5	—	—	
	D	15.5	—	—	

Solid state auto switch D-M9B, D-M9N

Model	Stroke (mm)		Auto switch operating range	
	5	10		
11-22-MXP6	A	25.5	30.5	3
	B	26.5	31.5	
	C	13.5	18.5	
	D	14.5	19.5	

11-22-MXP10, 12, 16

· Electrical entry from outside

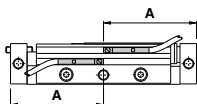

· Electrical entry from inside

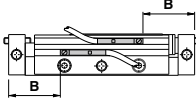

· Parallel electrical entry

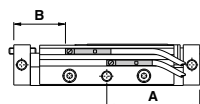

Reed auto switch D-A93

Model		Stroke (mm)					Auto switch operating range
		10	15	20	25	30	
11-22-MXP10	A	35	—	45	—	—	5
	B	15	—	25	—	—	
11-22-MXP12	A	—	40.5	—	50.5	—	
	B	—	20.5	—	30.5	—	
11-22-MXP16	A	—	—	51	—	59	
	B	—	—	31	—	39	

Solid state auto switch D-M9B, D-M9N

Model		Stroke (mm)					Auto switch operating range
		10	15	20	25	30	
11-22-MXP10	A	31	—	41	—	—	3.5
	B	19	—	29	—	—	
11-22-MXP12	A	—	36.5	—	46.5	—	
	B	—	24.5	—	34.5	—	
11-22-MXP16	A	—	—	47	—	55	
	B	—	—	35	—	43	

Dimensions: 11-22-MXPJ6

11-22-MXPJ6-5

* Since the body and table are made of a magnetic substance, it could become magnetized if touched by a magnet, etc. This could cause auto switch malfunction.

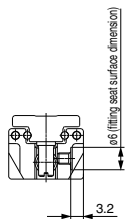
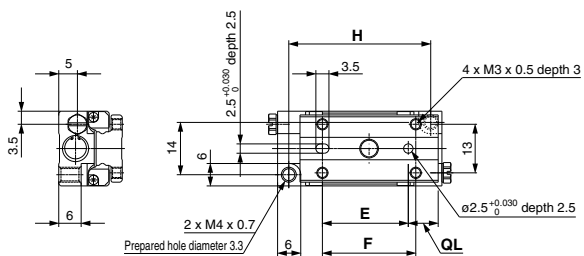

Section AA

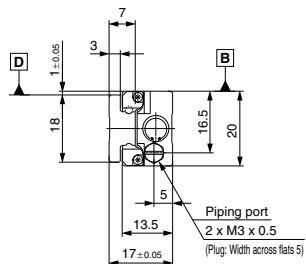
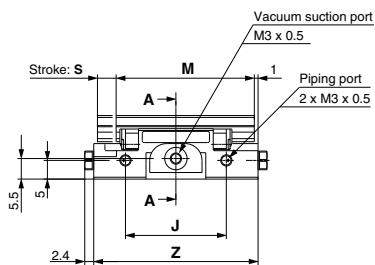

B **D** — Mounting base side

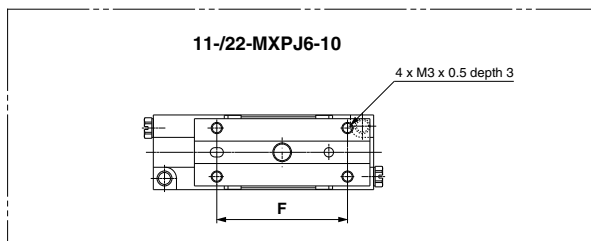
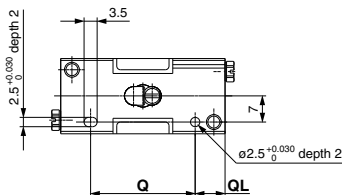

(mm)

Model	E	F	H	J	M	Q	QL	S	Z
11-22-MXPJ6-5	23	25	38	27	37	28	8	5	44
11-22-MXPJ6-10	30	35	53	42	47	37	11	10	59

Dimensions: 11-22-MXP6

11-22-MXP6-5

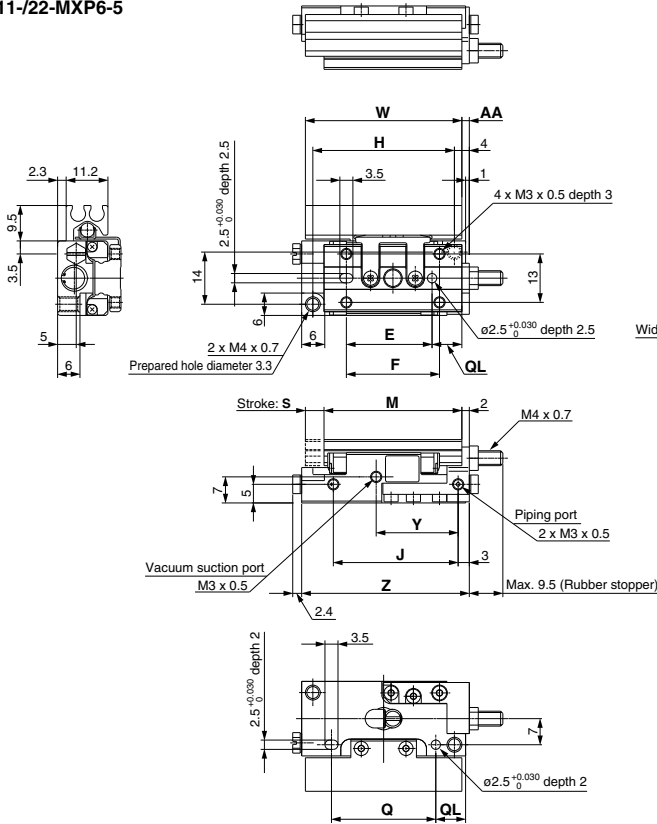

* Since the body and table are made of a magnetic substance, it could become magnetized if touched by a magnet, etc. This could cause auto switch malfunction.

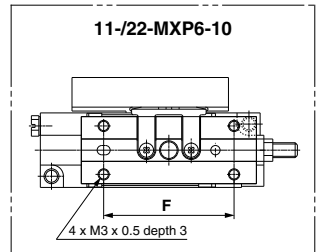
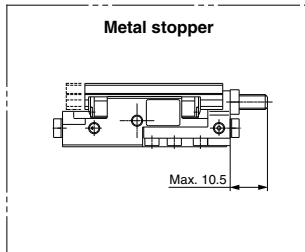
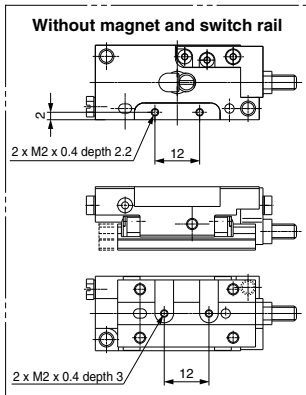
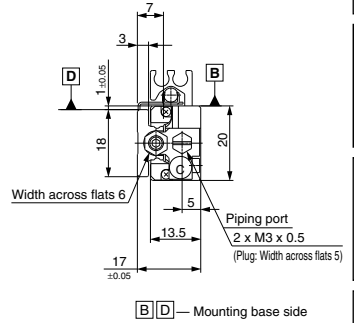

Model	E	F	H	J	M	Q	QL	S	W	Y	Z	AA
11-22-MXP6-5	23	25	38	33.5	37	28	8	5	42	23.5	45	2
11-22-MXP6-10	30	35	53	48.5	47	37	11	10	42	30	60	9.5

Directional Control Valves

Air Cylinders

Rotary Actuators

Air Grippers

Air Preparation Equipment

Modular F. R.

Pressure Control Equipment

Fittings & Tubing

Flow Control Equipment

Pressure Switches/ Pressure Sensors

Dimensions: 11-22-MXP10

11-22-MXP10-10

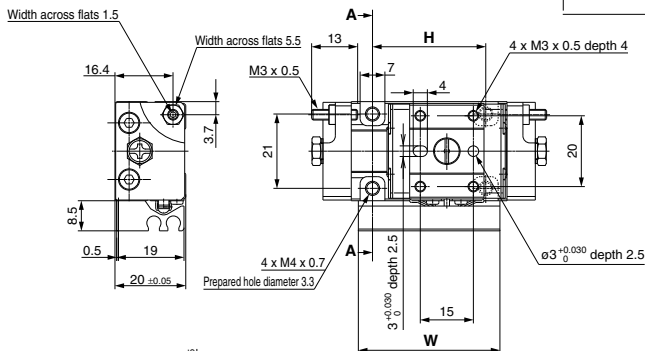
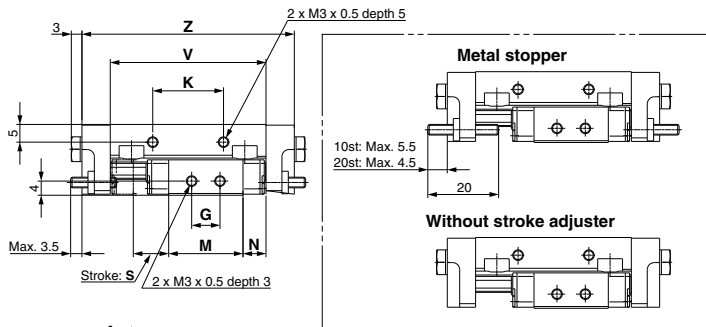

Piping port
2 x M5 x 0.8
(Plug: Width across flats 7)

* Since the body and table are made of a magnetic substance, it could become magnetized if touched by a magnet, etc. This could cause auto switch malfunction.

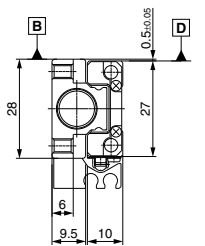

Section AA

B D — Mounting base side

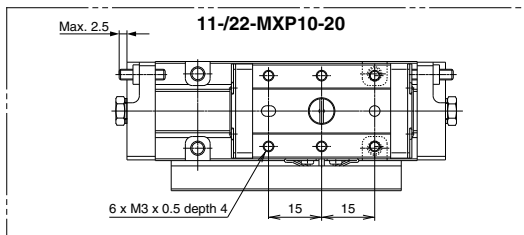
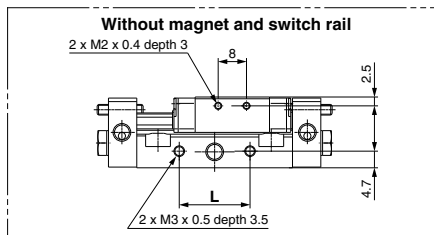
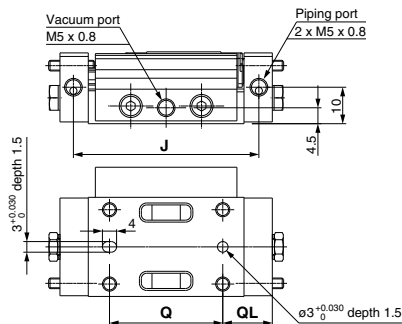

(mm)

Model	G	H	J	K	L	M	N	Q	QL	S	V	W	Z
11-22-MXP10-10	8	32	52.4	20	20	21	6.5	32	14	10	44	40	60
11-22-MXP10-20	20	50	82.4	36	36	39	7.5	50	20	20	74	65	90

Dimensions: 11-22-MXP12

11-22-MXP12-15

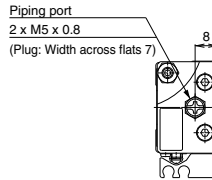
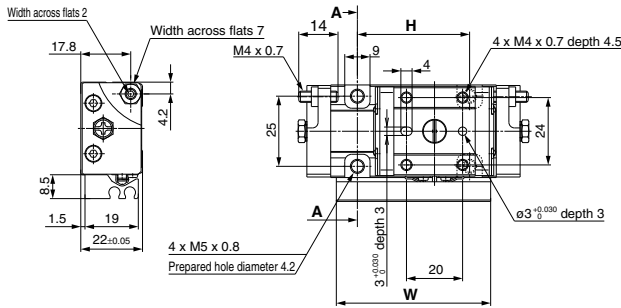
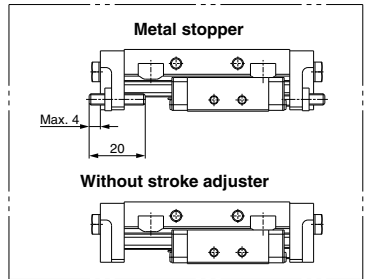
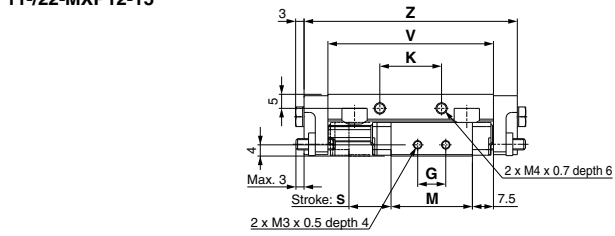

* Since the body and table are made of a magnetic substance, it could become magnetized if touched by a magnet, etc. This could cause auto switch malfunction.

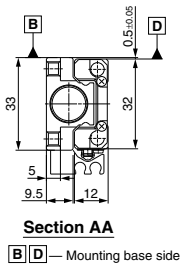

Section AA

B | D — Mounting base side

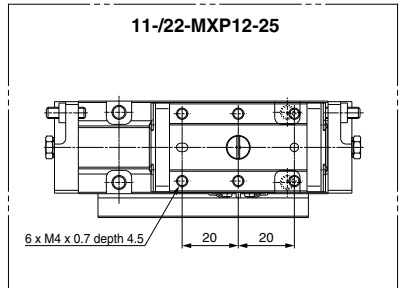
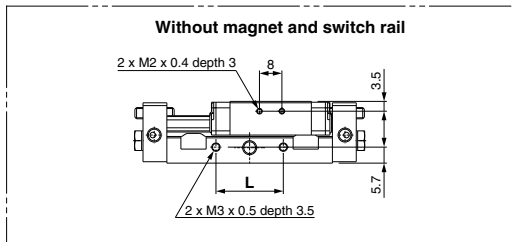
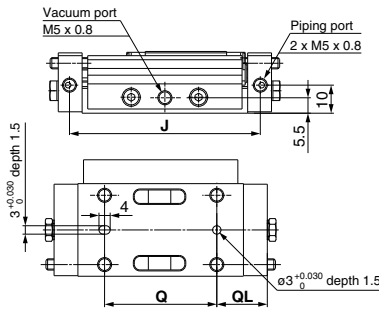

Model	G	H	J	K	L	M	Q	QL	S	V	W	Z
11-22-MXP12-15	10	40	68	22	24	29	40	18	15	59	55	76
11-22-MXP12-25	30	60	98	40	42	49	60	23	25	89	75	106

(mm)

Dimensions: 11-22-MXP16

11-22-MXP16-20

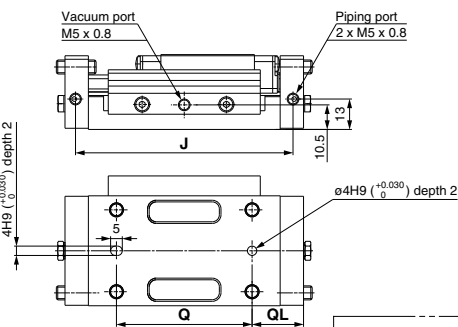
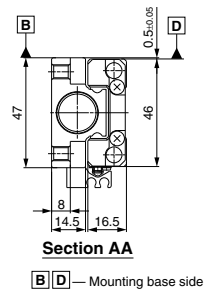
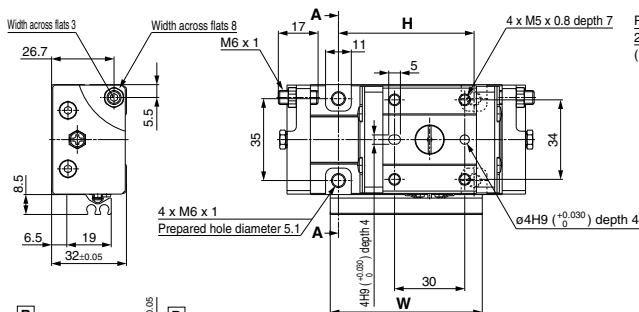
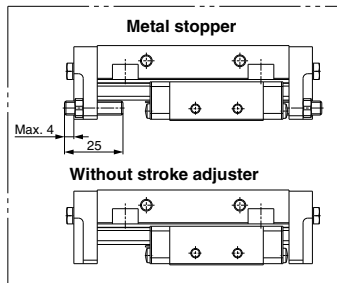
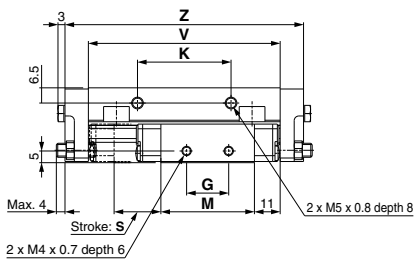

* Since the body and table are made of a magnetic substance, it could become magnetized if touched by a magnet, etc. This could cause auto switch malfunction.

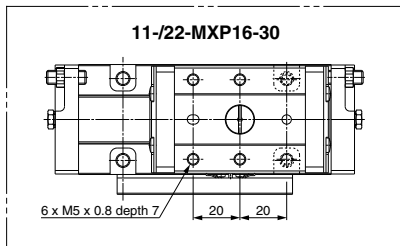
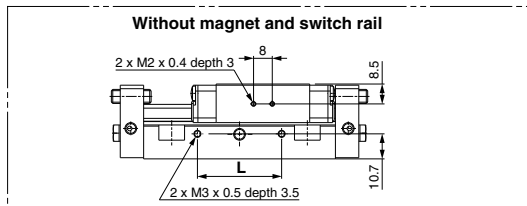

	(mm)											
Model	G	H	J	K	L	M	Q	QL	S	V	W	Z
11-22-MXP16-20	18	58	93	40	36	40	58	22	20	82	65	102
11-22-MXP16-30	28	70	119	50	42	56	70	29	30	108	75	128

Made to Order

Anti-corrosive guide unit	-X42
---------------------------	------

11-/22-MXP	Standard model no.	-X42
------------	--------------------	------

11-/22-MXPJ6	Standard model no.	-X42
--------------	--------------------	------

Martensitic stainless steel is used for the body, table and guide block. Use this treatment if more effective anti-corrosiveness is necessary.

Anti-corrosive treatment ^(Note 2) is applied to the body, table and guide block.

Note 1) Dimensions are the same as standard type.

Note 2) Special anti-corrosive treatment makes the body, table and guide block black.

⚠ Specific Product Precautions

Be sure to read this before handling.

Mounting

⚠ Caution

Mount the body on a flat surface in case of 11-/22-MXPJ6 series.

The 11-/22-MXPJ6 series has an opening on the bottom surface of the body and the opening is connected to the vacuum suction port. Sufficient vacuum suction may not be achieved in presence of any clearances.

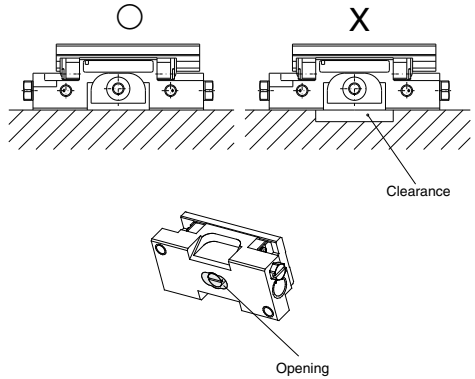

Directional Control Valves

Air Cylinders

Rotary Actuators

Air Grippers

Air Preparation Equipment

Modular F. R.

Pressure Control Equipment

Fittings & Tubing

Flow Control Equipment

Pressure Switches/ Pressure Sensors