

Solid State Auto Switch: Short Type

Produced upon receipt of order



Overall length reduced by **32%**

22 mm → 15 mm

Protrusion from the actuator end surface has been reduced.

Specifications are the same as those of the standard product (D-M9□).

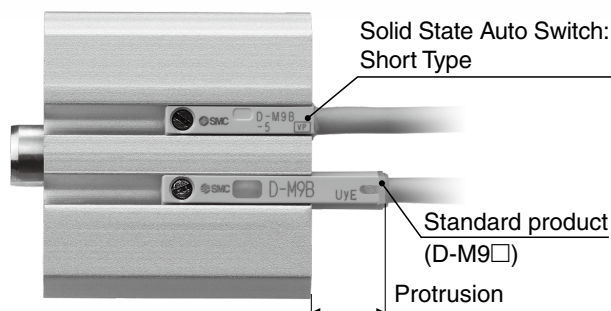

How to Order

D-M9 **B** **L** - **5**

Wiring/Output type

B	2-wire
N	3-wire, NPN
P	3-wire, PNP

Lead wire length

Nil	0.5 m
M	1 m
L	3 m
Z	5 m

Specifications

Auto switch model	D-M9N□-5	D-M9P□-5	D-M9B□-5
Wiring type	3-wire		2-wire
Output type	NPN	PNP	—
Applicable load	IC circuit, Relay, PLC		24 VDC relay, PLC
Power supply voltage	5, 12, 24 VDC (4.5 to 28 V)		
Current consumption	10 mA or less		
Load voltage	28 VDC or less	—	24 VDC (10 to 28 VDC)
Load current	40 mA or less		2.5 to 40 mA
Internal voltage drop	0.8 V or less at 10 mA (2 V or less at 40 mA)		4 V or less
Leakage current	100 μA or less at 24 VDC		0.8 mA or less
Indicator light	Red LED lights up when turned ON.		
Standards	CE marking, RoHS		

Dimensions

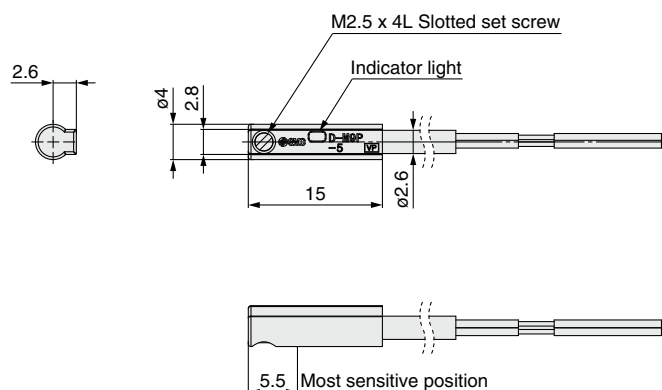

Oilproof Heavy-duty Lead Wire Specifications

Auto switch model	D-M9N□-5	D-M9P□-5	D-M9B□-5
Sheath	Outside diameter [mm]	ø2.6	
	Number of cores	3 cores (Brown/Blue/Black)	2 cores (Brown/Blue)
Insulator	Outside diameter [mm]	ø0.88	
	Effective area [mm ²]	0.15	
Conductor	Strand diameter [mm]	ø0.05	
	Min. bending radius [mm] (Reference value)	17	

Weight

Auto switch model	D-M9N□-5	D-M9P□-5	D-M9B□-5
Lead wire length	0.5 m (Nil)	7	6
	1 m (M)	13	11
	3 m (L)	35	31
	5 m (Z)	57	51

D-M9□-5



17-E683

D-M9□-5

Auto Switch Proper Mounting Position (Detection at stroke end)

■ The A and B dimensions are equivalent to the dimensions of the standard product (D-M9□) + 0.5 mm.

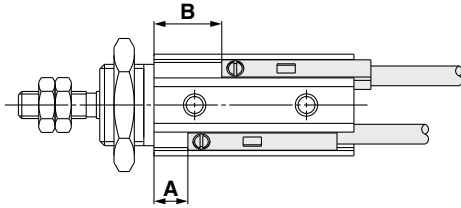

■ Actuators in which the protrusion from the body end surface can be eliminated by mounting the D-M9□-5

Description	Series	Note
Air Cylinder	CJP2	
Mini Free Mount Cylinder	CUJ	Excludes ø6, ø8, ø10, and ø12 (See right side.)
Free Mount Cylinder	CU	
Compact Cylinder	CQS	
Compact Cylinder: Guide Rod Type	CQM	
Compact Slide	MXH	Excludes ø6 (See right side.)
Air Slide Table	MXJ	
Platform Cylinder	CXT	
Dual Rod Cylinder	CXSJ	Excludes ø6 and ø10 (See right side.)
Rotary Clamp Cylinder	MK	
Escapements	MI□	
Parallel Type Air Gripper	MHZ2	Excludes ø6 (See right side.)
Parallel Type Air Gripper	MHZJ2	Excludes ø6 and ø10 (See right side.)
Parallel Type Air Gripper	MHZL2	Excludes ø10 (See right side.)
Low Profile Air Gripper	MHF2	
Parallel Type Air Gripper	MHS□	Excludes the center pusher (cylinder type) (See right side.)
Angular Type Air Gripper	MHC2	Excludes ø6 and ø10 (See right side.)
180° Angular Type Air Gripper: Cam Type	MHY2	
180° Angular Type Air Gripper: Rack & Pinion Type	MHW2	Excludes ø20 and ø25 (See right side.)

■ Protrusion from the body end surface

Mini Free Mount Cylinder [mm]

Model	Bore size	Protrusion
CUJ	6	0.5
	8	0.5
	10	0.5
	12	0.5

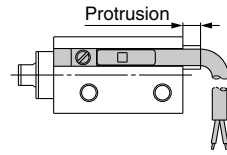

Compact Slide [mm]

Model	Bore size	Protrusion
MXH	6	1

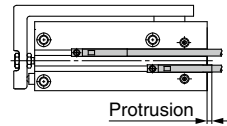

Dual Rod Cylinder [mm]

Model	Bore size	Protrusion
CXSJ	6	3
	10	0.5

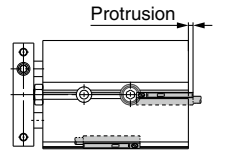

Parallel Type Air Gripper [mm]

Model	Bore size	Finger position	Protrusion
MHZ2	6	Open	4.5
		Closed	6.5
MHZL2	10	Closed	1.5
MHZJ2	6	Open	4.5
		Closed	6.5
	10	Closed	0.5

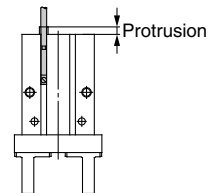

Parallel Type Air Gripper: MHS Center Pusher (Cylinder Type) [mm]

Model	Bore size	Rod position	Protrusion
MHS3	32	Retracted	2.5
	40	Retracted	1.5
	50	Retracted	1
	60	Retracted	0.5

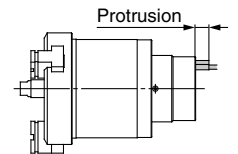

Angular Type Air Gripper [mm]

Model	Bore size	Finger position	Protrusion
MHC2	6	Closed	2.5
	10	Closed	1

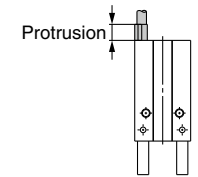

180° Angular Type Air Gripper: Rack & Pinion Type [mm]

Model	Bore size	Finger position	Protrusion
MHW2	20	Closed	0.5
	25	Closed	0.5

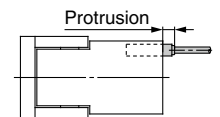

* Adjust the auto switch after confirming the operating conditions in the actual setting.

⚠ Safety Instructions Be sure to read the "Handling Precautions for SMC Products" (M-E03-3) and "Operation Manual" before use.