

Flow Controller for Air

Applicable fluid Dry air, N₂

New



RoHS

Flow rate control range

9 to 300 L/min

- Operational differential pressure range:
0.05 to 0.5 MPa
- Time to reach the set flow rate:
0.5 seconds or less
(When the operating differential pressure is 0.3 MPa and the flow rate is set to 300 L/min)
- Flow rate accuracy: $\pm 3\%$ F.S.
- Grease-free

Lightweight
850 g

Built-in linear motor

FLOW CONTROLLER
PFCQ SERIES

3-Screen Display

Digital Flow Monitor
PFG310-X105 [p.12](#)



PFCQ Series



CAT.ES100-153A

Compact

Actual size

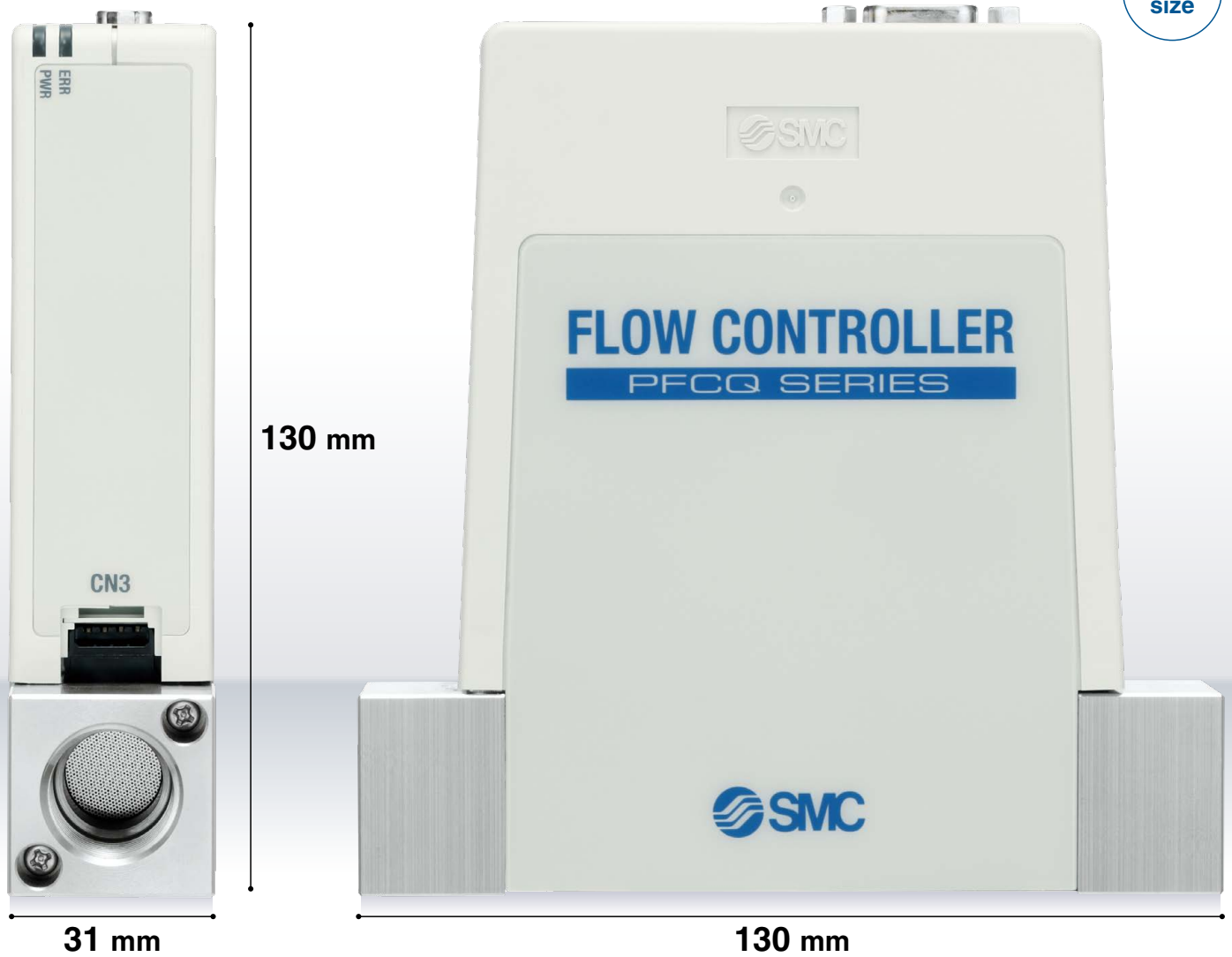

Applications

N₂ Purge

To the FOUP of the load port

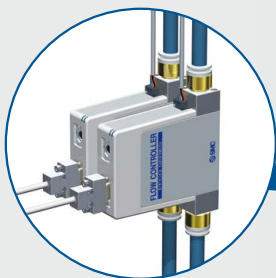

To the EFEM (Equipment Front End Module)

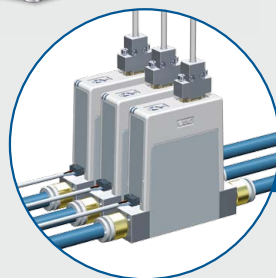

Working Principle

This product has a built-in linear motor which changes the valve opening by moving the valve element mounted to the linear motor, and thereby adjusting the flow rate inside the valve.

When the flow rate command signal is input to the product, the internal operation circuit performs a comparison calculation with the flow rate measured by the flow sensor. The product drives the linear motor based on that value to control the flow rate. When the linear motor is de-energized, the valve is closed by the attractive force of the permanent magnet mounted to the linear motor (Normally closed).

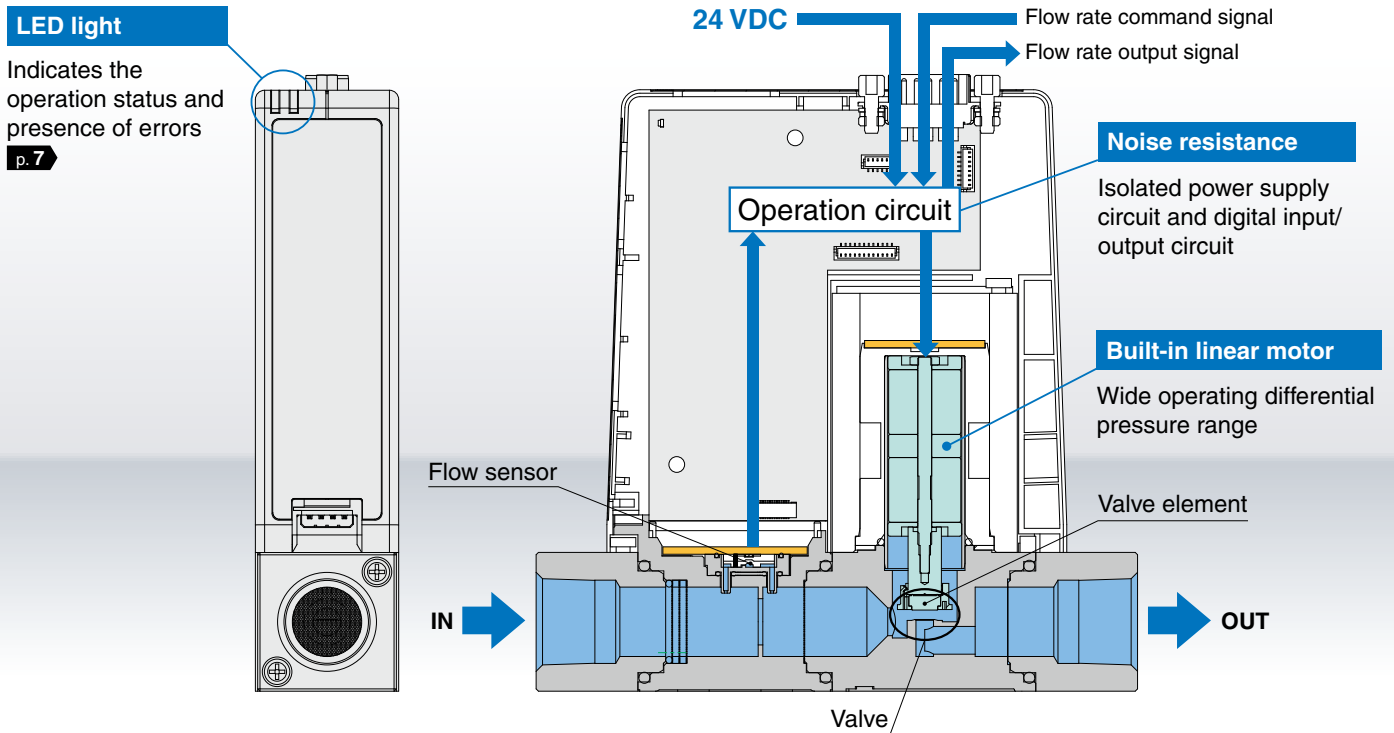

For the N₂ filling of food packages to prevent oxidization

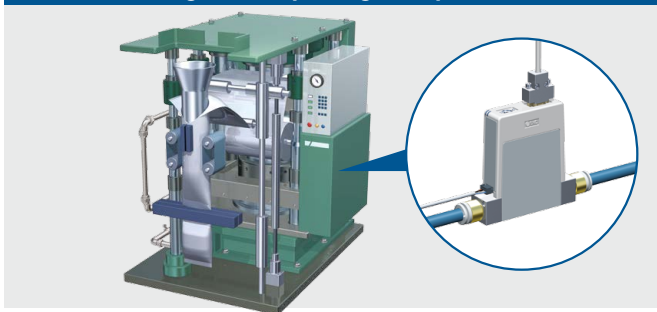

For the control of metal wire tension

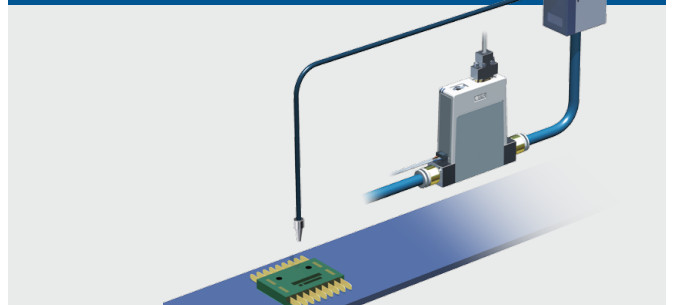

For silicon wafer N₂ purging

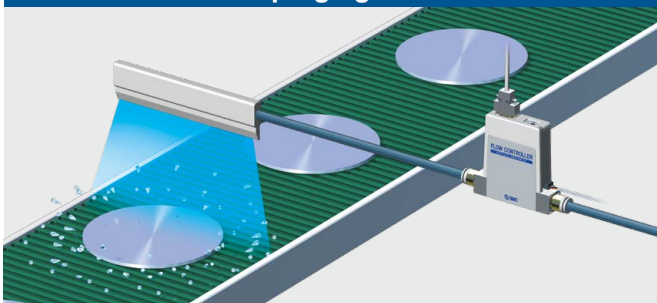

For air blow

- For flow control of N₂ gas to prevent lead frame oxidation
- N₂ blow prevents the distortion of camera images due to air turbulence.

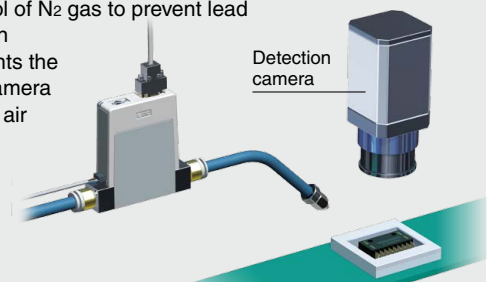

3-Screen Display Digital Flow Monitor

PFG310-X105 p. 12



Allows for the monitoring of remote lines

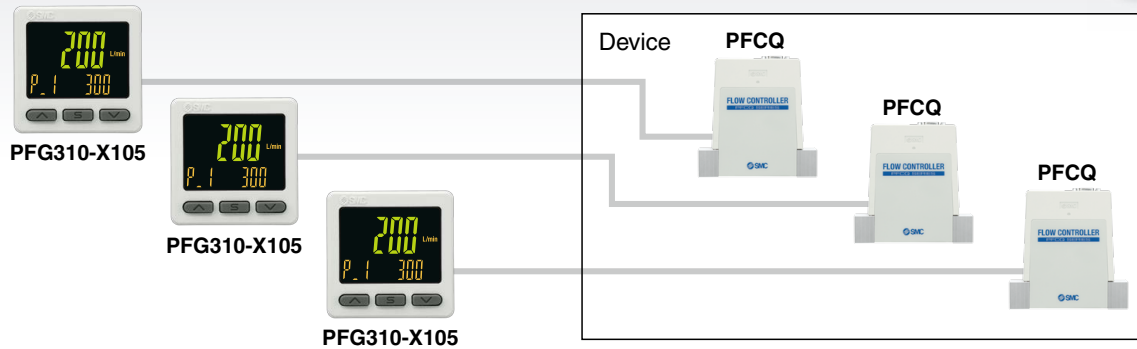

It is possible to change the settings while checking the measured value.

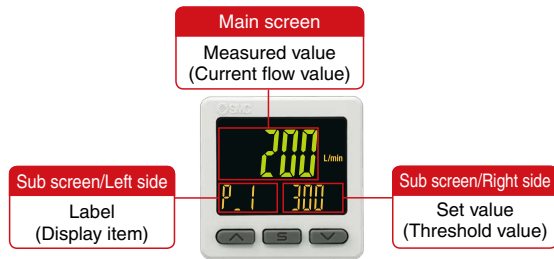

The sub screen can be switched by pressing the up/down buttons.

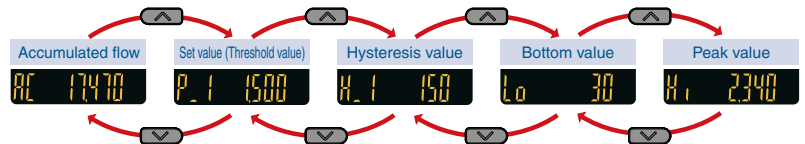

* Either "Input of line name" or "Display OFF" can be added via the function settings.

Convenient functions

● Security code

The key locking function keeps unauthorized persons from tampering with the settings.

● Power saving function

Power consumption is reduced by turning off the monitor.

Current consumption*1	Reduction rate*2
25 mA or less	Approx. 50% reduction

*1 During normal operation

*2 In power saving mode

Functions

- Output operation
- Simple setting mode
- Display color
- Accumulated value hold
- Peak/Bottom value display
- Setting of a security code
- Key-lock function
- Reset to the default settings
- Display with zero cut-off setting
- Selection of the display on the sub screen
- Error display function
- Copy function
- Selection of power saving mode

CONTENTS

Flow Controller for Air PFCQ Series

How to Order	p. 4	Construction: Parts in Contact with Fluid	p. 9
Specifications	p. 5	Dimensions	p. 10
Parts Descriptions and Functions	p. 6	Options/Accessories	p. 11
Functional Characteristics	p. 6	Specific Product Precautions	p. 13
Lighting Up of LEDs and Error Measures	p. 7		
Internal Circuits and Wiring Examples	p. 8		

Flow Controller for Air

PFCQ Series

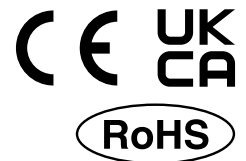

How to Order

PFCQ531-04-A1C-SM

Flow controller for air
(Display separate type)

Rated flow range (Flow range)

31	9 to 300 L/min
-----------	----------------

Port size

04	Rc1/2
-----------	-------

Input/Output specifications
Analog input/output type

Symbol	IN1	INA	OUT1	OUTA
A1	Common for NPN and PNP	Analog 1 to 5 V	NPN	Analog 1 to 5 V
A2	Common for NPN and PNP	Analog 4 to 20 mA	NPN	Analog 4 to 20 mA
A3	Common for NPN and PNP	Analog 1 to 5 V	PNP	Analog 1 to 5 V
A4	Common for NPN and PNP	Analog 4 to 20 mA	PNP	Analog 4 to 20 mA

Display **p.12**

Nil	None
M	With display*1

*1 The following items are included in the shipment.
Digital flow monitor
Lead wire: Lead wire with connector (2 m)
Connector: Sensor connector

Bracket

Nil	None
S	With bracket



* The bracket is shipped together with the product but does not come assembled.

Power supply cable

Nil	None
C	With power supply cable (3 m)

Options/Accessories

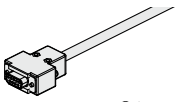
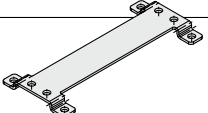
p. 11, 12

Description	Part no.	Note
Power supply cable	PFCQ531-H1-3	
Bracket	PFCQ531-B1	 (with 4 x hexagon socket head cap screws)
Protective plug	PFCQP-910S-31	 (Accessory)

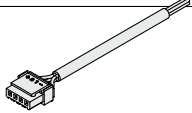
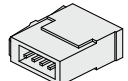
Description	Part no.	Note
Digital flow monitor	PFG310-XY-M-Y-X105	 p. 12
Lead wire with connector	ZS-33-D	 (for connection with the digital flow monitor)
Sensor connector	ZS-28-C-1	 (for connection with the digital flow monitor)

Specifications

General Specifications

Model		PFCQ531-04-A□
Fluid	Applicable fluid	Dry air, N ₂ (The air quality grade is JIS B 8392-1 1.1.2 to 1.6.2 and ISO 8573-1 1.1.2 to 1.6.2*1)
	Detection method	Thermal type
Flow ^{*2, *3}	Rated control flow rate range ^{*4}	9 to 300 L/min
	Set control flow rate range ^{*5}	3 to 300 L/min
	Standard operational differential pressure	300 kPa
Pressure	Operational differential pressure range ^{*6}	50 to 500 kPa
	Operating pressure range ^{*7}	50 to 800 kPa
	Proof pressure	1.0 MPa
	Mounting orientation	Downward orientation not allowed
External leakage		10 cm ³ /min or less
Environmental resistance	Enclosure	IP40
	Withstand voltage	1000 VAC for 1 min between terminals and housing
	Insulation resistance	50 MΩ or more (500 VDC measured via megohmmeter) between terminals and housing
	Operating temperature range	Operating: 5 to 45°C (Accuracy guarantee: 15 to 35°C) Stored: -10 to 60°C (No freezing and condensation)
	Operating humidity range	Operating/Stored: 35 to 85% RH (No condensation)
Standards		CE, UKCA, RoHS
Piping		Rc1/2
Main materials of parts in contact with fluid		PPS, FKM, Stainless steel 303, Stainless steel 304, Stainless steel 316, Electroless nickel plating, Si, Au, GE4F, DLC
Weight	Body	850 g
	Power supply cable	210 g
	Bracket	30 g

*1 Use fluid that is compliant with JIS B 8392-1 1.1.2 to 1.6.2, ISO8573-1 1.1.2 to 1.6.2. Using the following pneumatic circuit satisfies the air quality class described above.

Example of recommended pneumatic circuit (Compressed air line)

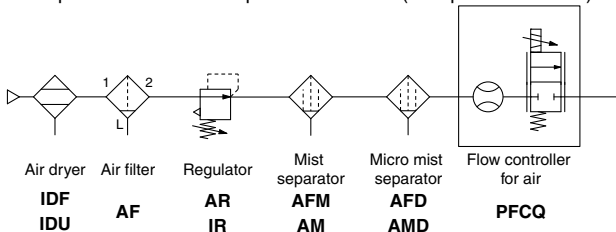

- *2 Flow rate converted to a volume at 0°C and 1 atm (atmosphere)
- *3 For the relationship between the operational differential pressure and the controllable flow rate, refer to "Controllable range".
- *4 The accuracy may not be satisfied outside of the rated controlled flow rate because the flow rate control is unstable.
- *5 The set controlled flow rate range is the settable flow rate range.
- *6 The operational differential pressure range is the differential pressure required for this product to operate normally.
- *7 The operating pressure range is the pressure range that can be applied to the primary side (IN side) of the product.

Controllable range

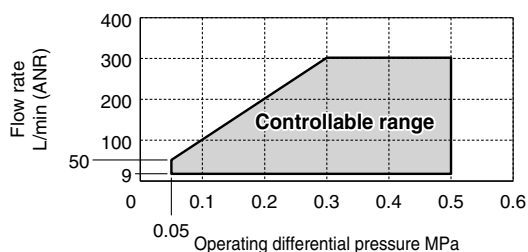

Electrical Specifications

Model		PFCQ531-04-A□	
Electrical	Power supply voltage	Main power supply: 24 VDC ±10%, Signal power supply: 24 VDC ±10%	
	Current consumption	Main power supply: 0.5 A or less, Signal power supply: 0.05 A or less	
	Protection	Power supply polarity protection	
Control specification	Valve driving actuator	Linear motor	
	Control accuracy	±3% F.S. (at an operating differential pressure of 0.3 MPa and temperature of 25 °C)	
	Repeatability	±1% F.S.	
	Temperature characteristics*1	±2% F.S. (15 to 35°C, 25°C standard) ±5% F.S. (0 to 50°C, 25°C standard)	
	Pressure characteristics*2	±2% F.S. (Standard operating differential pressure basis)	
	Settling time*3	0.5 s or less	
	Control command method	Analog input	
	State when de-energized*4	Closed (Normally closed)	
	Analog input	Input mode	Flow rate command signal
		Voltage	Input type
Input impedance			Approx. 1 MΩ
Current		Input type	4 to 20 mA
	Input impedance	250 Ω or less	
Analog output	Output mode	Flow rate output signal	
	Voltage	Output type	1 to 5 V
		Output impedance	Approx. 1 kΩ
	Current	Output type	4 to 20 mA
Load impedance		50 to 600 Ω	
Switch input	Input type	1 point (Photo-coupler isolation)	
	Input mode	Valve fully open command	
	Internal resistance	5 kΩ	
Switch output	Output type	1 point (NPN open collector, PNP open collector)	
	Output mode	Error output	
	Switch operation	Reversed output	
	Max. load current	80 mA	
	Max. applied voltage (NPN only)	30 VDC	
	Internal voltage drop	1.5 V or less (at load current of 80 mA)	
	Delay time	5 ms or less	
	Protection	Switch output polarity protection, Over current protection	
Flow rate display output	Output mode	For connection with the digital flow monitor PFG310	
	Output type	4 to 20 mA	
	Load impedance	50 to 600 Ω	
Display	LED indicator	2 points (power supply, error)	

- *1 Indicates the amount of fluctuation in the control accuracy when the temperature changes within the operating temperature range.
- *2 Indicates the amount of fluctuation in the control accuracy when the pressure changes within the operating pressure range.
- *3 The time when an operational differential pressure of 0.3 MPa, temperature of 25°C, power supply voltage of 24 VDC, command flow rate of a step signal from 3% to 100% is input, the flow rate is set within ±3% F.S. of the command flow rate. The settling time may be longer in other operating conditions.
- *4 This product is not suitable for applications which require the flow to be shut off completely.
If it is necessary to completely shut off the flow rate, install a stop valve, etc. separately.

Parts Descriptions and Functions

Name	Function
Power supply (PWR) LED	When 24 V power is supplied and the system starts the operation, this LED turns ON and flashes.
Error (ERR) LED	This LED turns ON and flashes when fully open or when an error occurs.
D-sub connector (CN1)	This connector has connections for power supply, flow rate command signal, switch input signal, flow rate output signal, and switch output signal. For information on pin numbers and functions, refer to "Internal circuits and wiring examples".
Flow rate display connector (CN3)	This connector is for connecting to the digital flow monitor PFG310 (optional) to display the flow rate. When not using the digital flow monitor, mount the protective plug on the connector.
Piping port	This port is a connection port for piping. The IN side is for inlet and the OUT side is for outlet.
F.G.	Frame ground. A grounding cable must be connected to the F.G.
Protective plug	When not using the digital flow monitor, mount the protective plug on the flow rate display connector.

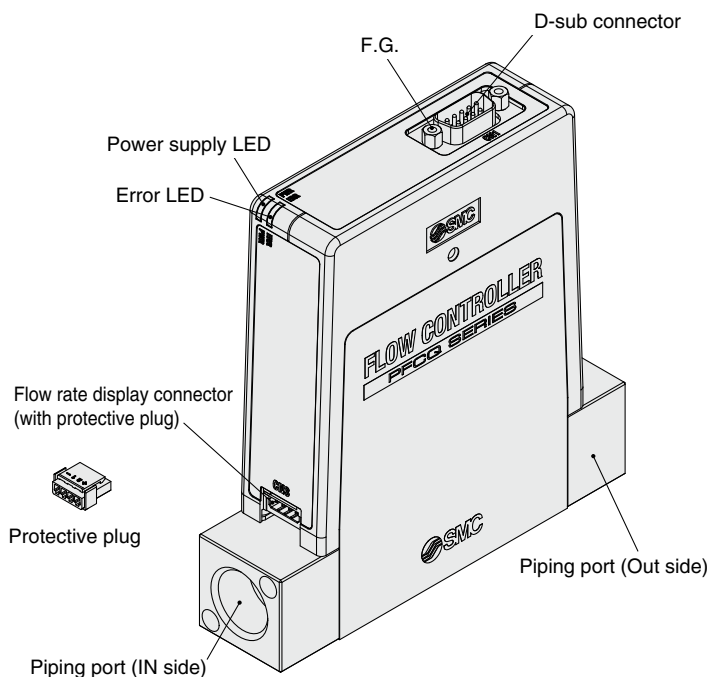

Functional Characteristics

Name	Description
Analog input operation	The flow rate is controlled according to the analog input INA (flow rate command signal).
Valve fully open operation	When the switch input IN1 is turned on when the valve is closed, the valve is fully opened. During an analog input operation, the valve fully open operation is not available.
Valve closed	When the analog input (flow command signal) becomes smaller than 1.04 V (4.16 mA), energization of the linear motor is stopped and the valve is closed.
Flow rate output signal	The currently flowing flow rate is outputted as 1-5 V or 4-20 mA.
Switch output	An ERROR signal is output. [Refer to Table 1.]

[Table 1] OUT1 Optional Output Functions

Name	Description
ERROR	OFF only when an error occurs

Analog input (Flow rate command signal)

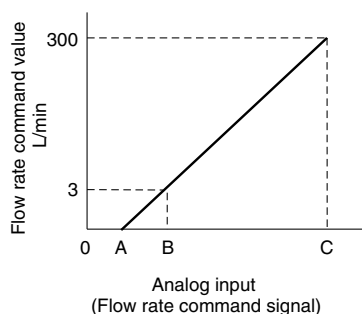

Input type	Flow rate command signal range		
	0 L/min: A	Set controlled flow rate Minimum value: B	Set controlled flow rate Maximum value: C
Voltage input	1 V	1.04 V	5 V
Current input	4 mA	4.16 mA	20 mA

* A signal smaller than the minimum value of the set controlled flow rate turns off the current to the linear motor, which closes the valve.

Analog output (Flow rate output signal)

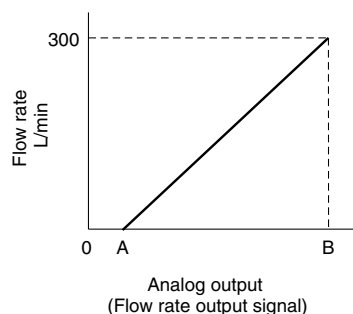









Input type	A	B
Voltage output	1 V	5 V
Current output	4 mA	20 mA











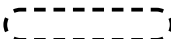

Lighting Up of LEDs and Error Measures

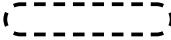
Based on the LED colour, turning ON and flashing of the power supply LED and the error LED at the top of the product, the product status can be confirmed.

Normal Operation

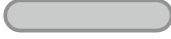
Name	Power supply LED	Error LED	Description	Action
Analog input operation	 Green ON	 Green ON	During analog input operation	
Valve fully open operation	 Green ON	 Blinking green	During valve fully open operation	
Valve closed	 Green ON	 OFF	Because the analog input (INA) is smaller than 1.04 VDC (4.16 mA), the current to the motor is turned off and the valve is closed.	
Power OFF	 OFF	 OFF	The internal microcomputer is not operating (valve closed) because the main power supply is not turned on or the voltage of the main power supply is small (21.6 VDC or less).	Apply a voltage of 24 VDC \pm 10% to the main power supply.

Error Generation

Name	Power supply LED	Error LED	Contents	Measures
Switch input error	 (Red) LED is ON	 LED is OFF	Switch input is ON at the end of the analog input operation. ⇒Turns off current to the linear motor and closes the valve.	Reset the signal. Alternatively, turn on the main power supply again when the analog input is set to 1 VDC (4 mA) or less and switch input is OFF.
Analog input error	 (Red) LED is ON	 LED is OFF	Analog input is larger than 1.04 VDC (4.16 mA) at the end of valve fully open operation. ⇒Turns off current to the linear motor and closes the valve.	Reset the signal. Alternatively, turn on the main power supply again when the analog input is set to 1 VDC (4 mA) or less and switch input is OFF.
Input error at power ON	 (Red) LED is ON	 LED is OFF	The analog input is 1.04 VDC (4.16 mA) or more when the power supply is turned on or switch input is ON. ⇒Turns off current to the linear motor and closes the valve.	Reset the signal. Alternatively, turn on the main power supply again when the analog input is set to 1 VDC (4 mA) or less and switch input is OFF.
Switch output over current error	 (Red) LED is ON	 (Green) LED is ON	The current applied to the switch output has exceeded the specified value. ⇒Turns off current to the linear motor and closes the valve.	Check the electric circuit of the switch output, take measures for the cause, and turn on the main power supply again by referring to "Internal circuits and wiring examples".
Signal power supply outside the range	 (Red) LED is ON	 (Green) LED is ON	The voltage of the signal power supply is lower than the specified value. ⇒Turns off current to the linear motor and closes the valve.	Apply a voltage of 24 VDC \pm 10% to the signal power supply and turn on the main power supply by referring to "Internal circuits and wiring examples".
Temperature error	 (Red) LED is ON	 (Red) Flashes	The product temperature exceeded the specified value. ⇒Turns off current to the linear motor and closes the valve.	Take measures by referring to "Specific product precautions". Reset the signal or turn on the power supply again after the product surface temperature has reached around the same level as the ambient temperature.
Device abnormality error	 (Red) LED is ON	 (Red) LED is ON	There is an error in parts in a device such as a sensor or motor. ⇒Turns off current to the linear motor and closes the valve.	Please contact your local sales representative for more details.

Error reset

If an error occurs, the product turns off current to the motor and closes the valve. After taking measures described in "Measures" reset the error following the method below.

(1) Reset the signal

Turn off the analog input INA and the switch input IN1 for at least 1 sec.

(2) Turn on the main power supply again

Turn off the main power supply (for at least 1 sec) and turn it on again.

Note: When turning on the power supply, do not supply compressed fluid to the IN side.

Internal Circuits and Wiring Examples

NPN output supported

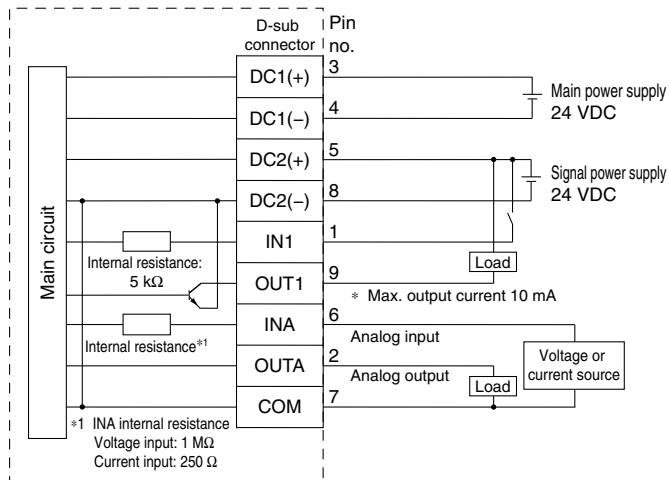

PNP output supported

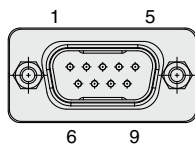
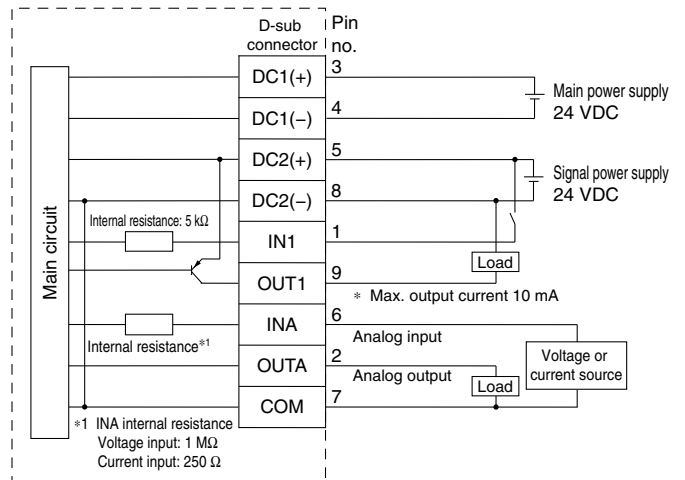

D-sub connector
(9 pins, plug)
#4-40 UNC

Input/Output Signal

Pin no.	Input/Output	Name	Description
1	Input	IN1	Refer to the details of the switch input IN1.
2	Output	OUTA	Flow rate output signal
3	Input	DC1(+)	Main power supply 24 VDC
4	Input	DC1(-)	Main power supply 0 VDC*1, *2
5	Input	DC2(+)	Signal power supply 24 VDC
6	Input	INA	Flow rate command signal
7	Input/Output	COM	INA and OUTA 0 VDC*1, *3
8	Input	DC2(-)	Signal power supply 0 VDC*2, *3
9	Output	OUT1	Refer to the details of the switch output OUT1.

*1 The main power supply 0 VDC side (Pin No. 4) and the INA and OUTA 0 VDC side (Pin No. 7) are insulated inside the product.

*2 The main power supply 0 VDC side (Pin No. 4) and the signal power supply 0 VDC side (Pin No. 8) are insulated inside the product.

*3 The signal power supply 0 VDC side (Pin No. 8) and the INA and OUTA 0 VDC side (Pin No. 7) are connected inside the product.

IN1 Input Details

Name	Description
OPEN	Valve fully open command

OUT1 Output Details

Name	Description
ERROR	OFF only when an error occurs

Construction: Parts in Contact with Fluid

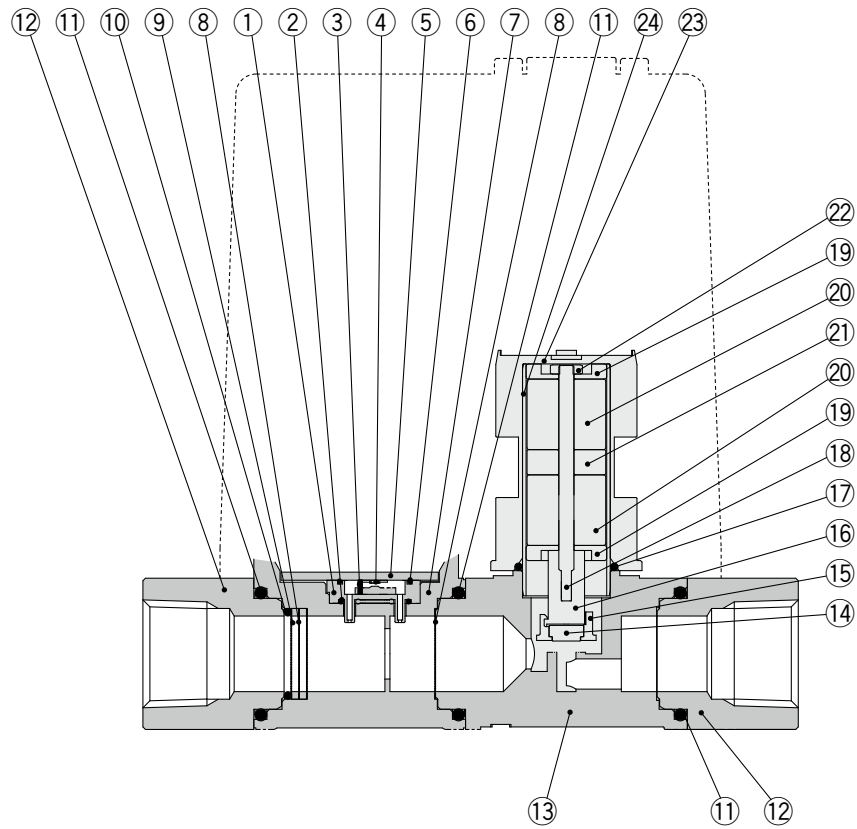

Component Parts

No.	Description	Material	Note
1	Sensor body	Resin	
2	Gasket	FKM	
3	Flow rectifier	Stainless steel	
4	Sensor chip	Silicon	
5	Printed circuit board	GE4F	
6	Gasket	FKM	
7	Body	Resin	
8	Mesh	Stainless steel	
9	Spacer	Resin	
10	O-ring	FKM	
11	O-ring	FKM	
12	Attachment	Stainless steel	

No.	Description	Material	Note
13	Valve body	Resin	
14	Poppet	FKM	
15	Retainer	Resin	
16	Valve	Stainless steel	
17	O-ring	FKM	
18	Shaft	Stainless steel	
19	Wear ring	Stainless steel	DLC
20	Magnet	—	Ni plated
21	Ring	Carbon steel	Ni plated
22	Nut	Stainless steel	
23	Motor body	Resin	
24	Tube	Stainless steel	

Dimensions

PFCQ531-04-□□

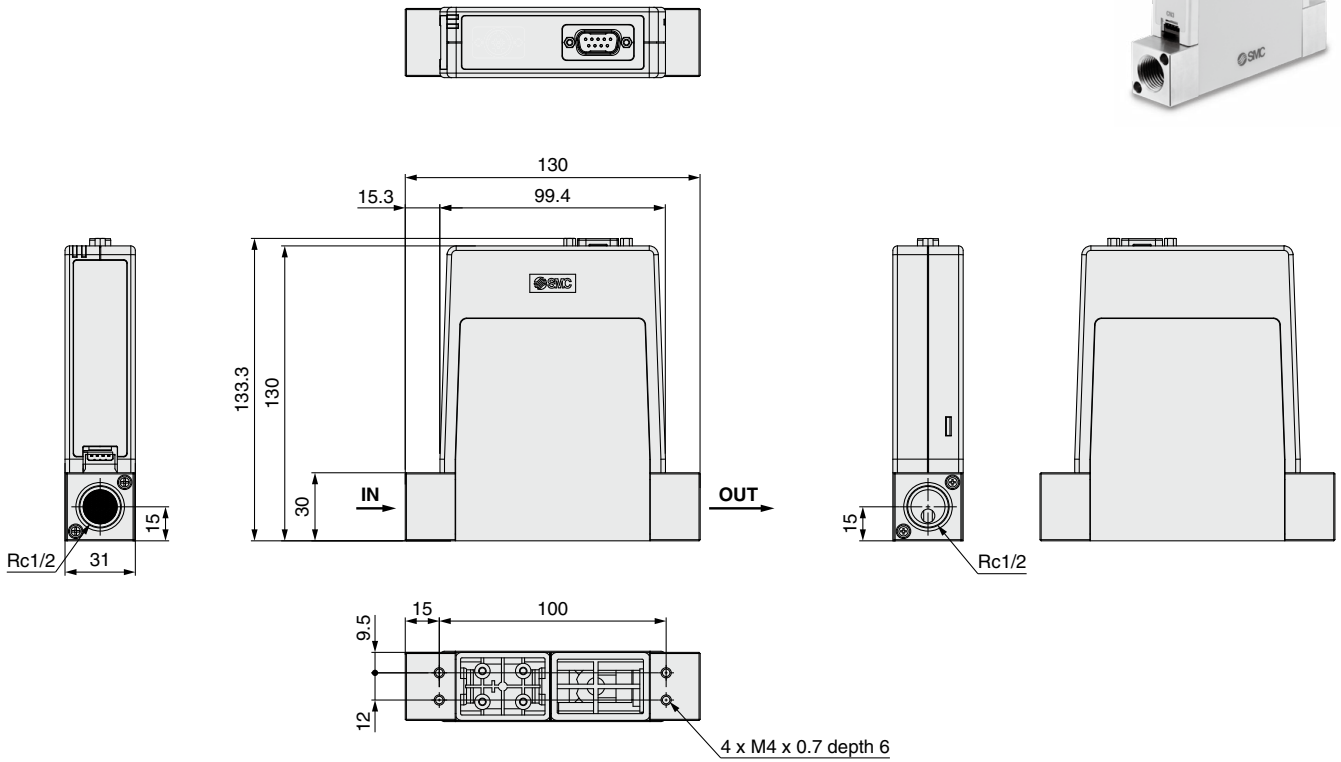

With bracket: PFCQ531-04-□□-S

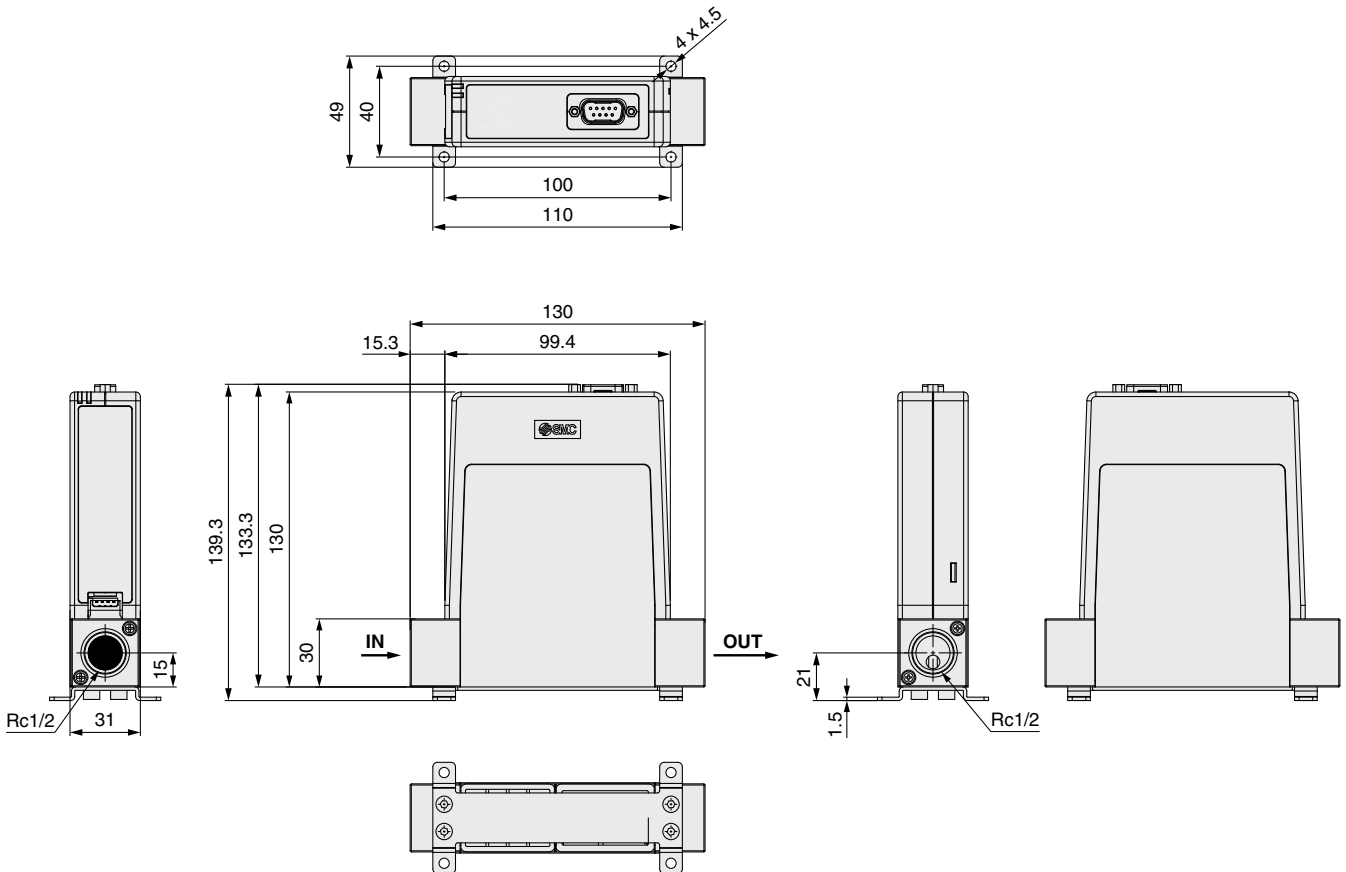

PFCQ Series

Options/Accessories

Power Supply Cable: PFCQ531-H1-3

Specifications

Item	Description
Connector	D-sub connector, 9-pin socket #4-40 UNC
Sheath O.D.	ø6.8
Minimum bending radius	54 mm
Number of cores	10 cores (5 x 2 P)
Nominal cross section of the conductor	AWG26 equivalent
Insulator O.D.	1 mm

D-sub connector

Pin no.	Name	Lead wire color
1	IN1	White
2	OUTA	Yellow
3	DC1(+)	Red
4	DC1(-)	Black
5	DC2(+)	Orange
6	INA	Pink
7	COM	Brown/Gray
8	DC2(-)	Purple
9	OUT1	Blue
FG	FG	Green

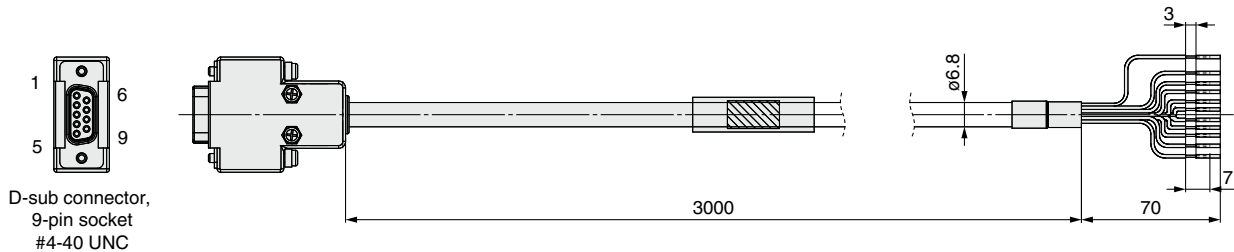
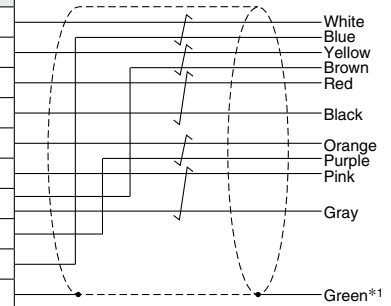

*1 Be sure to ground the FG wire (green).

Lead Wire with Connector: ZS-33-D

Pin no.	Name	Lead wire color
1	DC(+)	Brown
2	N.C.	White
3	OUTM	Black
4	DC(-)	Blue

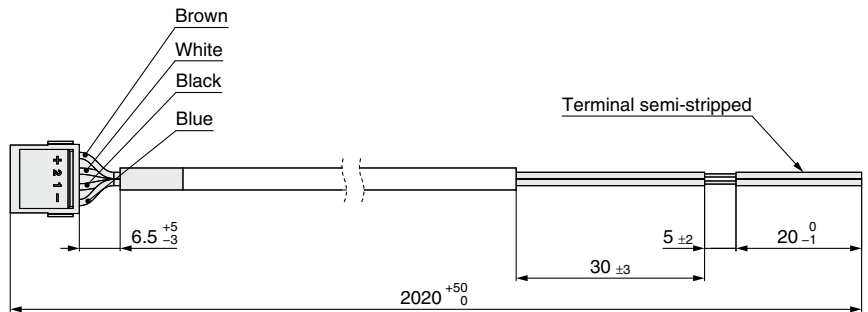

Sensor Connector: ZS-28-C-1

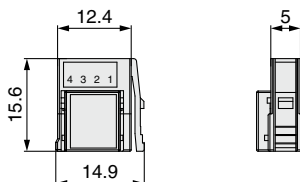

Pin no.	Name	Lead wire color*2
1	DC(+)	Brown
2	N.C.	White
3	DC(-)	Blue
4	OUTM*1	Black

*1 4 to 20 mA

*2 Lead wire with connector: The lead wire color of the lead wire with a connector when connected to the ZS-33-D

Protective Plug (Accessory): PFCQP-910S-31

* When not using the digital flow monitor, mount the protective plug on the flow rate display connector.

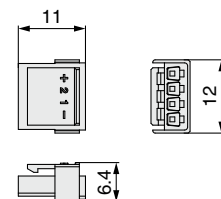

Digital Flow Monitor: PFG310-XY-M-Y-X105**Specifications**

Model		PFG310-XY-M-Y-X105	
Applicable SMC flow controller	Model	PFCQ531	
	Rated flow range*1	3 to 300 L/min	
Flow	Set point range	Instantaneous flow	-15 to 315 L/min
		Accumulated flow	0 to 999,999,999,999 L
	Smallest settable increment	Instantaneous flow	1 L/min
		Accumulated flow	1 L
Accumulated value hold function*2	Intervals of 2 or 5 minutes can be selected. The stored accumulated flow is held even when the power supply is OFF.		
Accuracy	Display accuracy	±0.5% F.S. ± Min. display unit (Ambient temperature at 25°C)	
	Repeatability	±0.1% F.S. ± Min. display unit	
	Temperature characteristics	±0.5% F.S. (Ambient temperature: 0 to 50°C, 25°C standard)	
Display	Display mode	Select from Instantaneous flow or Accumulated flow.	
	Unit	Instantaneous flow	L/min
		Accumulated flow	L, L x 10 ⁶
	Display range	Instantaneous flow	-15 to 315 L/min
		Accumulated flow*3	0 to 999,999,999,999 L
	Min. display unit	Instantaneous flow	1 L/min
		Accumulated flow	1 L
	Display type	LCD	
	Number of displays	3-screen display (Main screen, Sub screen)	
	Display color	1) Main screen: Red/Green, 2) Sub screen: Orange	
Number of display digits	1) Main screen: 5 digits (7 segments) 2) Sub screen: 7 digits (7 segments)		
Indicator LED	LED ON when switch output is ON. OUT1/2: Orange		
Digital filter*4	Select from 0.00, 0.05 to 0.1 s (increments of 0.01 s), 0.1 to 1.0 s (increments of 0.1 s), 1 to 10 s (increments of 1 s), 20 s, or 30 s.		
Environmental resistance	Enclosure	IP40	
	Withstand voltage	1000 VAC for 1 min between terminals and housing	
	Insulation resistance	50 MΩ or more (500 VDC measured via megohmmeter) between terminals and housing	
	Operating temperature range	Operating: 0 to 50°C, Stored: -10 to 60°C (No condensation or freezing)	
Operating humidity range	Operating/Stored: 35 to 85% RH (No condensation or freezing)		
Standards	CE/UKCA marking		
Weight	Body	25 g (Excluding the power supply/output connection lead wire)	
	Lead wire with connector	+39 g	

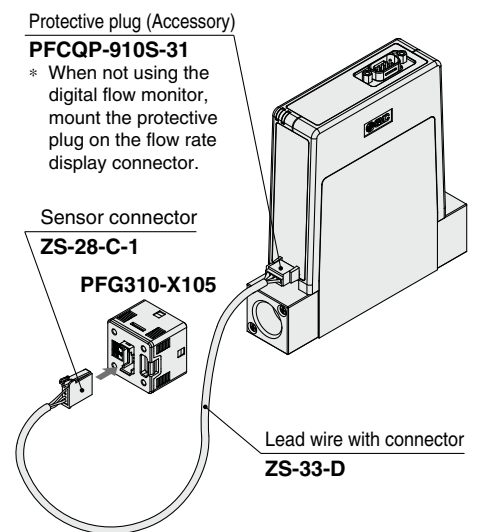

More information can be viewed here.

Connection Example

*1 Rated flow range of the applicable flow controller

*2 When using the accumulated value hold function, use the operating conditions to calculate the product life, and do not exceed it. The max. access limit of the memory device is 1.5 million times. If the product is operated 24 hours per day, the product life will be as follows:

- 5 min interval: life is calculated as 5 min x 1.5 million = 7.5 million min = 14.3 years
- 2 min interval: life is calculated as 2 min x 1.5 million = 3 million min = 5.7 years

If the accumulated value external reset is repeatedly used, the product life will be shorter than the calculated life.

*3 The accumulated flow display is the upper 6-digit and lower 6-digit (total of 12 digits) display. When the upper digits are displayed, x 10⁶ lights up.

*4 The response time indicates when the set value is 90% in relation to the step input.

* Products with tiny scratches, marks, or display color or brightness variations which do not affect the performance of the product are verified as conforming products.

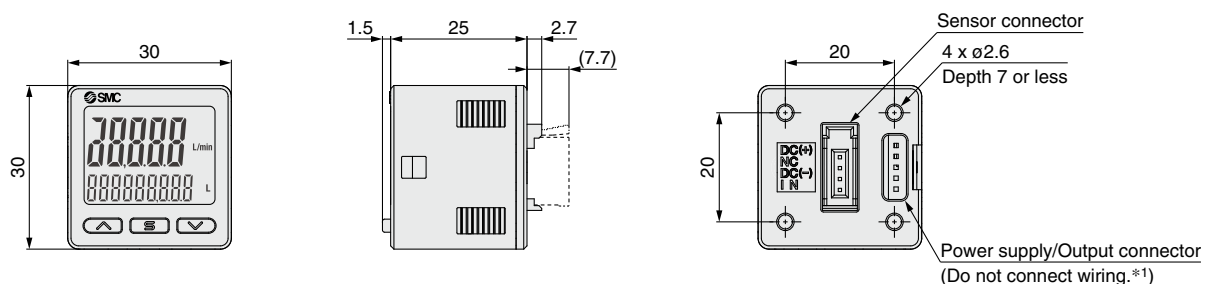
Dimensions

*1 The equipment may be damaged, accuracy may deteriorate, or vibrations may occur.



PFCQ Series

Specific Product Precautions 1

Be sure to read this before handling the products. Refer to the back cover for safety instructions. For flow switch precautions, refer to the “Handling Precautions for SMC Products” and the “Operation Manual” on the SMC website: <https://www.smcworld.com>

Design/Selection

Warning

- 1. Take into account the behaviour when the valve is fully open.**
In valve fully open operation, a high flow rate may be applied. Make sure that the design will not cause injury to human bodies or damage devices and equipment.
- 2. Take into account the behaviour in the event of an error or power failure.**
If the flow rate command signal exceeds the input range, an error occurs such as the product temperature exceeding 70°C, or no power is supplied to the product due to power failure, the valve will close and the fluid will no longer flow. Make sure that the design will not cause injury to human bodies or damage devices and equipment.
- 3. Take into account the behaviour when the device is restarted after an error occurrence or power failure.**
Design the system so that human injury or equipment damage will not occur upon the restart of operation of the whole system.

Caution

- 1. This product is not suitable for applications which require the flow to be shut off completely.**
If it is necessary to shut off the flow completely, install a stop valve, etc. separately.
- 2. For details of the compressed air quality, refer to JIS B 8392-1 1.1.2 to 1.6.2 and ISO8573-1 1.1.2 to 1.6.2 and use compliant fluid.**
The specifications may not be satisfied due to a failure or stains attached to the flow sensor.
- 3. Use the product at a pressure and flow rate within the specifications.**
If the product is used at a pressure outside the specifications, the flow rate on the inlet side may be insufficient or the product may malfunction or may not satisfy the specifications.
- 4. If the fluid on the IN side (inlet) of the product is turbulent, accurate measurement may not be possible.**
If a valve, etc. is used on the IN side (inlet) of the product, flow turbulence may be caused due to changes in the effective area, resulting in an error in the flow rate measurement. If this is the case, place the valve, etc. away from the product and provide a straight piping section with a length of at least 80 mm on the IN side of the product.
- 5. Be sure to prepare the main power supply and the signal power supply separately.**
If one power supply is shared between them, malfunction due to noise may be caused or the specified characteristics may not be satisfied.
- 6. Do not short-circuit the main power supply 0 VDC (DC1(-)), INA and OUTA 0 VDC (COM).**
Otherwise, the specified accuracy may not be satisfied due to the effect of the current flowing through the main power supply.
- 7. Be aware of magnetism.**
Because a strong rare-earth magnet is used, it may have a magnetic effect on items outside the product. To avoid the effect of the magnetism, place the relevant item away from the product. If an item is placed 100 mm away from the product, the magnetic flux density from the product is 1 mT or less.

Design/Selection

Caution

- 8. Make sure that the fluid in the piping on the IN (inlet) and OUT (outlet) sides of the product can be exhausted.**
The product is normally closed (closed when de-energized). Provide an exhaust valve, etc. on the piping so that the fluid can be exhausted when performing maintenance.
- 9. Ensure sufficient space for maintenance activities.**
Design the system allowing the required space for maintenance and inspection.
- 10. SMC products are not intended for use as instruments for legal metrology.**
Measurement instruments that SMC manufactures or sells have not been qualified by type approval tests relevant to the metrology (measurement) laws of each country. Therefore, SMC products cannot be used for business or certification obtained by the metrology (measurement) laws of each country.

Handling

Warning

- 1. Do not touch the product until its surface temperature has reached around the same level as the ambient temperature during de-energizing or after power shutdown.**
The surface temperature of the product can increase up to approximately 70°C depending on the operating conditions. Energizing alone may also cause the temperature to increase. Do not touch the product during operation or when energized to prevent burns or other injuries.
- 2. Do not apply fluid to the OUT side (outlet) with a pressure higher than the pressure on the IN side (inlet)**
Failing to do so may cause the valve to open and the fluid to flow backward.

Caution

- 1. When not using the digital flow monitor, mount the protective plug on the flow rate display connector.**
If a foreign matter such as a metal fragment enters inside the flow rate display connector, short-circuit may occur, causing the product to be damaged.
- 2. Allow the product to warm up for at least 10 minutes after the power supply is turned on.**
Otherwise, the specified accuracy may not be satisfied due to temperature drift.
- 3. Be sure to input the flow rate command signal after supplying fluid to the IN side (inlet).**
If fluid is supplied after the flow rate command signal is input, fluid at the flow rate range or more is applied, the specified accuracy cannot be satisfied, and control may be unstable.
- 4. Make sure that the pressure on the IN (inlet) and OUT (outlet) sides will not fluctuate.**
If the pressure on the IN side or the OUT side varies, the flow rate may vary.



PFCQ Series

Specific Product Precautions 2

Be sure to read this before handling the products. Refer to the back cover for safety instructions. For flow switch precautions, refer to the “Handling Precautions for SMC Products” and the “Operation Manual” on the SMC website: <https://www.smcworld.com>

Handling

Caution

- 5. When the flow rate command signal is 1 VDC (4 mA) or less, the internal valve is closed.**

To input the flow rate command signal again after setting it to 1 VDC (4 mA) or less, wait for at least 1 second before inputting the next signal.

Mounting

Warning

- 1. Do not install the product in a place subject to vibrations and impacts.**

It will cause failure or malfunction.

- 2. Mount this product on a flat surface.**

If the mounting surface is distorted or not flat, an excessive force may be applied to the product, causing fluid leakage, malfunction, or failure.

- 3. When mounting a fitting, apply a wrench or adjustable wrench at the metal part (attachment) to mount the fitting.**

Applying the wrench at other parts may cause the product to fail.

- 4. Remove dirt and dust from inside of the piping by means of air blow, before attaching to the product.**

Such a place is likely to cause a malfunction or breakage.

Caution

- 1. Perform installation and piping according to the fluid flow direction indicated on the product label.**

Power Supply

Warning

- 1. Use a power supply that has low noise between lines and between the power and ground.**

In cases where noise is high, an isolation transformer should be used.

Grounding

Warning

- 1. Be sure to carry out grounding in order to ensure the noise tolerance.**

Otherwise, it may cause a malfunction, damage, electric shock or fire. Do not share the earth with devices or equipment that generates a strong electromagnetic noise.

Operating Environment

Warning

- 1. Do not install the product in an environment containing flammable gas, explosive gas, or corrosive gas.**

It could lead to fire, explosion, or corrosion.

- 2. Do not use the product in a place where dust, water, chemicals, or oil scatter or in a oil vapor atmosphere.**

It will cause failure or malfunction.

- 3. Do not use the product in an area where a magnetic field is generated.**

Failing to do so may cause malfunction.

- 4. Do not use the product in a place where surges are generated.**

If a device or equipment that generate large surges (magnetic type lifter, high frequency inductive furnace, motor, etc.) is located near the product, the product internal circuit elements may be deteriorated or damaged.

Consider countermeasures against surge sources and prevent the lines from mixing with each other.

Safety Instructions

These safety instructions are intended to prevent hazardous situations and/or equipment damage. These instructions indicate the level of potential hazard with the labels of “**Caution**,” “**Warning**” or “**Danger**.” They are all important notes for safety and must be followed in addition to International Standards (ISO/IEC)*1), and other safety regulations.

 **Danger** : **Danger** indicates a hazard with a high level of risk which, if not avoided, will result in death or serious injury.

 **Warning**: **Warning** indicates a hazard with a medium level of risk which, if not avoided, could result in death or serious injury.

 **Caution**: **Caution** indicates a hazard with a low level of risk which, if not avoided, could result in minor or moderate injury.

*1) ISO 4414: Pneumatic fluid power - General rules and safety requirements for systems and their components
ISO 4413: Hydraulic fluid power - General rules and safety requirements for systems and their components
IEC 60204-1: Safety of machinery - Electrical equipment of machines - Part 1: General requirements
ISO 10218-1: Robots and robotic devices - Safety requirements for industrial robots - Part 1: Robots etc.

Warning

1. The compatibility of the product is the responsibility of the person who designs the equipment or decides its specifications.

Since the product specified here is used under various operating conditions, its compatibility with specific equipment must be decided by the person who designs the equipment or decides its specifications based on necessary analysis and test results. The expected performance and safety assurance of the equipment will be the responsibility of the person who has determined its compatibility with the product. This person should also continuously review all specifications of the product referring to its latest catalog information, with a view to giving due consideration to any possibility of equipment failure when configuring the equipment.

2. Only personnel with appropriate training should operate machinery and equipment.

The product specified here may become unsafe if handled incorrectly. The assembly, operation and maintenance of machines or equipment including our products must be performed by an operator who is appropriately trained and experienced.

3. Do not service or attempt to remove product and machinery/equipment until safety is confirmed.

1. The inspection and maintenance of machinery/equipment should only be performed after measures to prevent falling or runaway of the driven objects have been confirmed.
2. When the product is to be removed, confirm that the safety measures as mentioned above are implemented and the power from any appropriate source is cut, and read and understand the specific product precautions of all relevant products carefully.
3. Before machinery/equipment is restarted, take measures to prevent unexpected operation and malfunction.

4. Our products cannot be used beyond their specifications. Our products are not developed, designed, and manufactured to be used under the following conditions or environments. Use under such conditions or environments is not covered.

1. Conditions and environments outside of the given specifications, or use outdoors or in a place exposed to direct sunlight.
2. Use for nuclear power, railways, aviation, space equipment, ships, vehicles, military application, equipment affecting human life, body, and property, fuel equipment, entertainment equipment, emergency shut-off circuits, press clutches, brake circuits, safety equipment, etc., and use for applications that do not conform to standard specifications such as catalogs and operation manuals.
3. Use for interlock circuits, except for use with double interlock such as installing a mechanical protection function in case of failure. Please periodically inspect the product to confirm that the product is operating properly.

Caution

We develop, design, and manufacture our products to be used for automatic control equipment, and provide them for peaceful use in manufacturing industries.

Use in non-manufacturing industries is not covered.

Products we manufacture and sell cannot be used for the purpose of transactions or certification specified in the Measurement Act.

The new Measurement Act prohibits use of any unit other than SI units in Japan.

Limited warranty and Disclaimer/ Compliance Requirements

The product used is subject to the following “Limited warranty and Disclaimer” and “Compliance Requirements”.

Read and accept them before using the product.

Limited warranty and Disclaimer

1. The warranty period of the product is 1 year in service or 1.5 years after the product is delivered, whichever is first.*2)
Also, the product may have specified durability, running distance or replacement parts. Please consult your nearest sales branch.
2. For any failure or damage reported within the warranty period which is clearly our responsibility, a replacement product or necessary parts will be provided.
This limited warranty applies only to our product independently, and not to any other damage incurred due to the failure of the product.
3. Prior to using SMC products, please read and understand the warranty terms and disclaimers noted in the specified catalog for the particular products.

*2) **Vacuum pads are excluded from this 1 year warranty.**

A vacuum pad is a consumable part, so it is warranted for a year after it is delivered.

Also, even within the warranty period, the wear of a product due to the use of the vacuum pad or failure due to the deterioration of rubber material are not covered by the limited warranty.

Compliance Requirements

1. The use of SMC products with production equipment for the manufacture of weapons of mass destruction (WMD) or any other weapon is strictly prohibited.
2. The exports of SMC products or technology from one country to another are governed by the relevant security laws and regulations of the countries involved in the transaction. Prior to the shipment of a SMC product to another country, assure that all local rules governing that export are known and followed.

Safety Instructions

Be sure to read the “Handling Precautions for SMC Products” (M-E03-3) and “Operation Manual” before use.

SMC Corporation

Akihabara UDX 15F,
4-14-1, Sotokanda, Chiyoda-ku, Tokyo 101-0021, JAPAN
Phone: 03-5207-8249 Fax: 03-5298-5362
<https://www.smcworld.com>
© 2023 SMC Corporation All Rights Reserved

Specifications are subject to change without prior notice and any obligation on the part of the manufacturer.

D-G