

# 3-Screen Display

New

# Condensation Checker (Digital Temperature & Humidity Switch)



RoHS IP65

**New** A relative humidity under pressure (inside piping) display function has been added.

IO-Link

## Visualization of relative humidity

Real-time monitoring

Digital display

Main display	
Relative humidity (Atmospheric pressure/Under pressure)	
Sub display From page 5	
Temperature, set value, atmospheric pressure relative humidity, relative humidity under pressure, etc.	



\* A variety of display options can be selected via the F10 function selection mode.

Relative humidity [% R.H.]

Display/Setting range	0 to 100
Display accuracy	±5% R.H. ±1 digit

Temperature [°C]

Display/Setting range	-5 to 55
Display accuracy	±3°C ±1 digit

\* The accuracy is relative to the atmospheric pressure relative humidity.

## Remote/Condition monitoring

Remote confirmation via switch output preventing condensation problems!

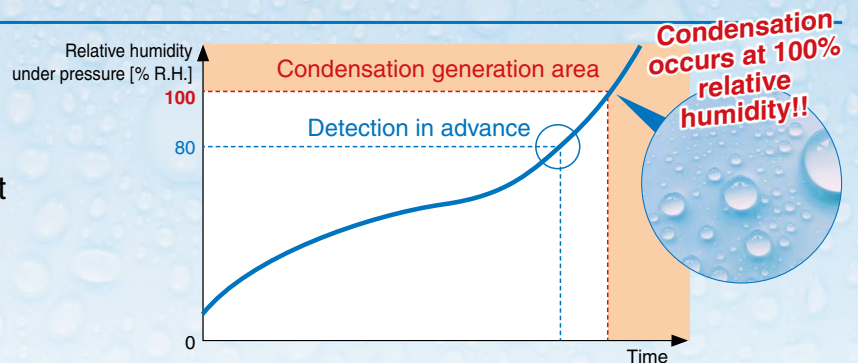

## Protect important equipment from moisture.

### Malfunction of air blowers/air drivers

Generation of water droplets



### Equipment failure and frequent replacement

Malfunction of valves and actuators due to dripping grease

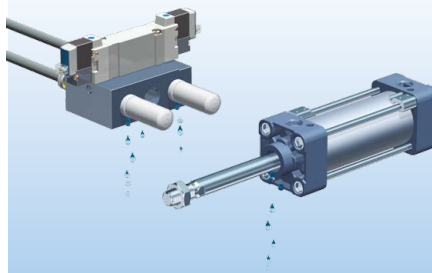

### Reduced dryer dehumidification performance

High load on the dryer in summer



**PSH Series**



CAT.ES100-161A <sup>Ⓐ</sup>

# Condensation problem inside piping

**Case 1** Although a dryer was installed...

Summer ambient temperature  
Increased outlet side consumption flow rate  
Pressure drop  
Drop in dryer processing capacity

**Condensation generated**

**Case 2** Although a dryer was installed for dehumidifying purposes...

Degradation of film module  
Increased outlet side consumption flow rate  
Drop in dryer processing capacity

**Condensation generated**

**Case 3** Although a line filter or mist separator was installed...

Passage of water vapor (gas)  
Water droplets can be removed, but water vapor cannot be removed and remains.

**Condensation generated**

A condensation checker can prevent such problems!

- Allows for the visualization of humidity inside piping
- Detects abnormalities prior to condensation generation

- Can be easily connected to any pipe you want to monitor
- Compact size allows for easy installation



- Aids in preventing condensation problems in advance
- Aids in dryer selection and installation as well as in gauging replacement timing
- Easy installation, Space saving

# Water resistant!

Measurement with stable accuracy is possible even when it is humid inside the piping!

Measures the status of humidity inside the piping (under pressure) as **relative humidity under atmospheric pressure after depressurizing to atmospheric pressure**

When the sensor is inside piping (under pressure)

High humidity

Air  
Water steam

Concerns about declining sensor measurement accuracy  
The sensor part absorbs water due to continuous high-humidity conditions.

When the sensor is under atmospheric pressure

Low humidity

\* Image of moisture released to atmospheric pressure

Air  
Water steam

By reducing pressure to atmospheric pressure

- Air expands
- Water vapor pressure drops

Reduced impact on the sensor  
Less water is absorbed when measuring under atmospheric pressure.

Temperature/humidity sensor measurement principles

Water molecule  
Moisture-sensitive film  
Lines of electric force  
Electrode  
Silicon chips

The moisture-sensitive film that absorbs water molecules in the air measures the relative humidity based on the dielectric constant that changes when water molecules are taken in.  
\* The measurement accuracy/responsiveness changes when water is absorbed in high-humidity conditions.

\* The atmospheric pressure relative humidity value displayed is lower than that of the relative humidity inside piping (under pressure). For the relative humidity conversion method, refer to "Set value (threshold value) setting" on page 3.

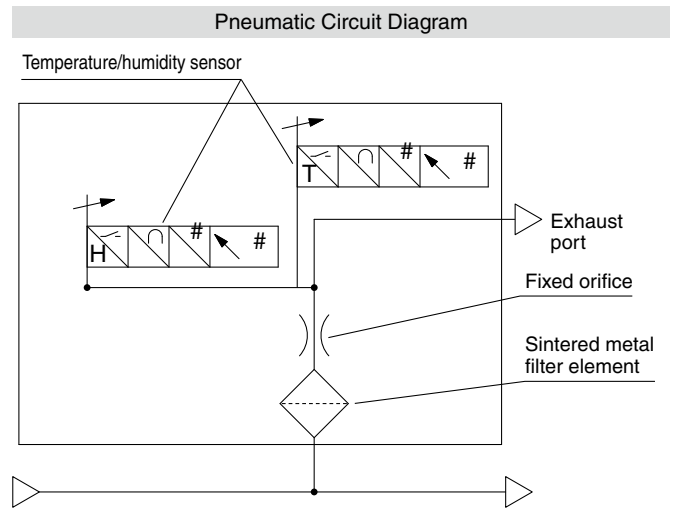
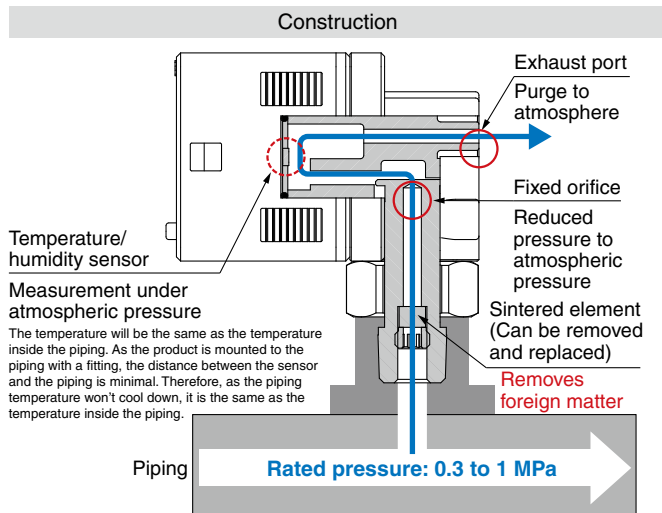

# Application Example

## ● For problems with condensation, water droplets, and dehumidification in general pneumatic systems

### Malfunction of air blowers/air drivers

Generation of water droplets



### Equipment failure and frequent replacement

Malfunctioning of valves and actuators caused by dripping grease

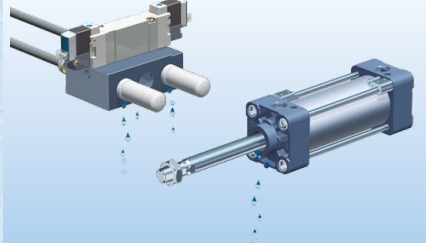

### The outflow of drain to the outlet side

Decomposition of auto drain caused by rusting inside pipes



For when water droplets adhere to workpieces due to air blow

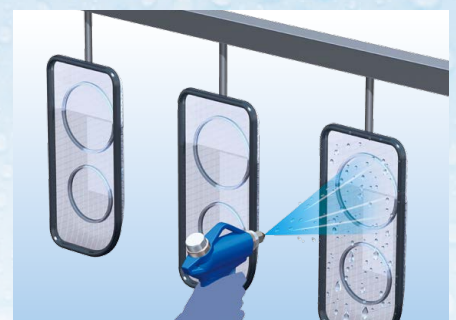
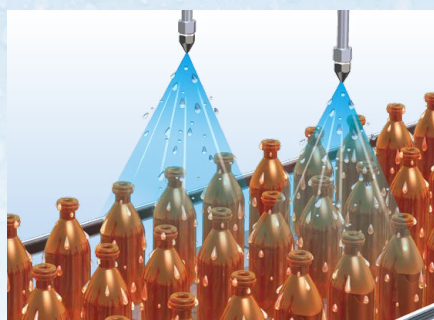
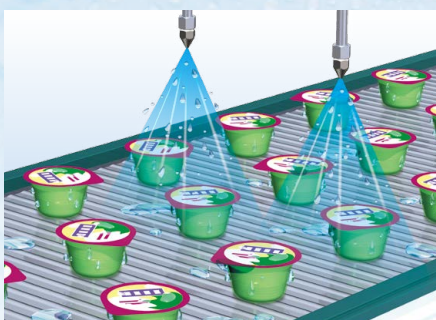

## ● Machine tools

### For bearing oil air control

Prevents bearing seizure and damage due to poor lubrication

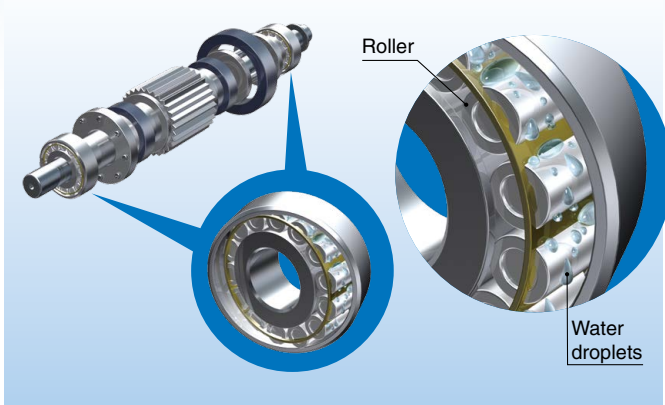

### For linear scale purge air control

Reduces optical sensor lens fogging and measurement accuracy failure

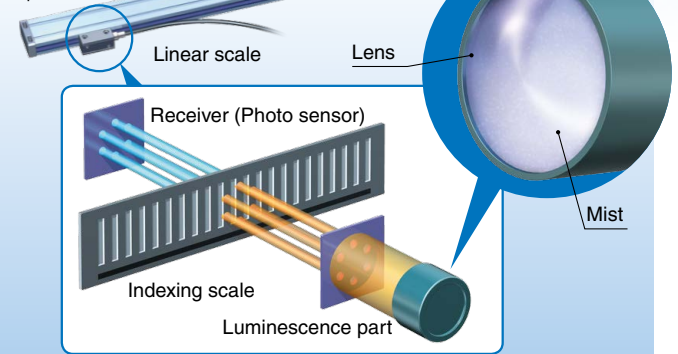

## ● Laser related equipment

### For machining head purge air control

Reduces laser machining head lens fogging and machining defects

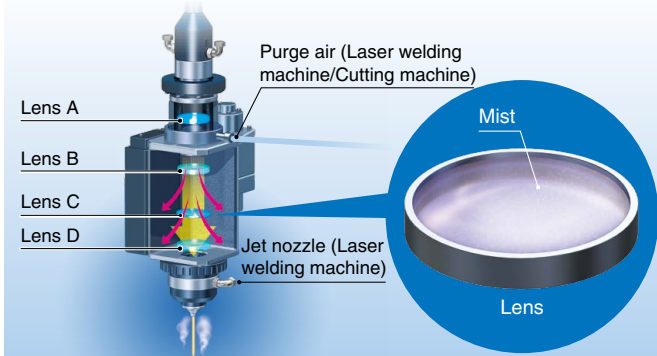

## ● Food processing machines

### For the control of blow air when opening packaging bags

Reduces mold generation due to water contamination

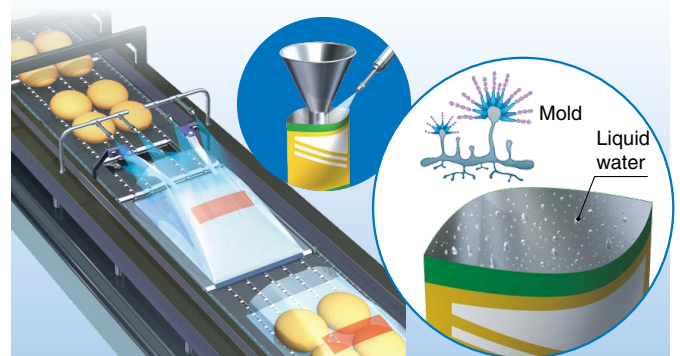

## Set value (threshold value) setting

### Relative humidity under pressure-atmospheric pressure relative humidity (Simple conversion tables)

The relative humidity inside the piping (under pressure) and the atmospheric pressure relative humidity can be converted as shown below so long as the temperature inside the piping (measured via the condensation checker) and the atmospheric pressure (ambient) temperature are the same.

The relative humidity under pressure display function allows for the relative humidity according to the set pressure value to be converted as shown below.

#### Conversion magnification list

Operating pressure [MPa]	Magnification	
	Under pressure → Atmospheric pressure	Atmospheric pressure → Under pressure
0.3	1/4	4
0.35	1/4.5	4.5
0.4	1/5	5
0.45	1/5.5	5.5
0.5	1/6	6
0.7	1/8	8
0.9	1/10	10

\* For more information on the simple conversion formula, refer to the technical data on page 15.

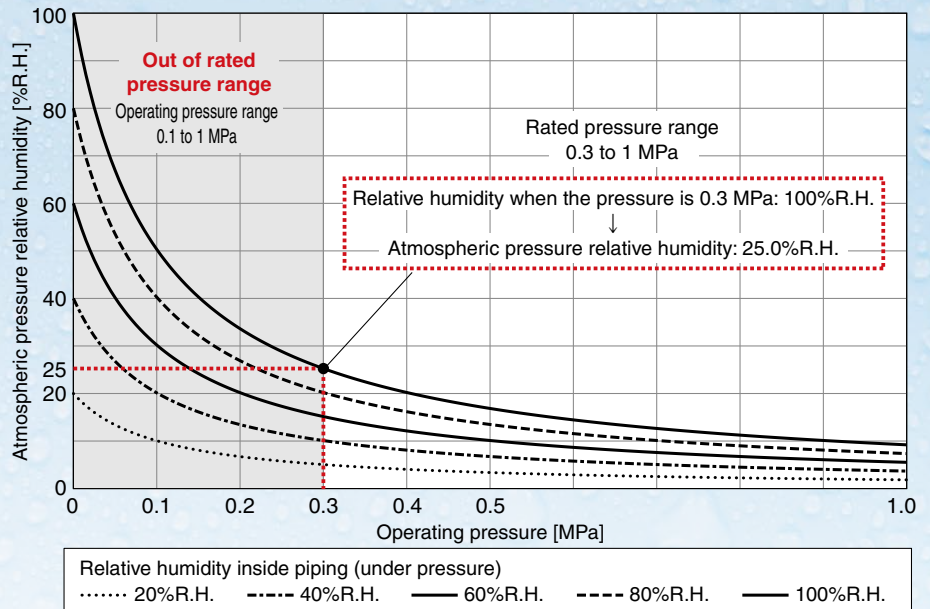

### Model Selection Software Humidity conversion/condensed water (drain) calculation software

Supports conversion related to humidity for humidity control

- When the temperature inside piping differs from the atmospheric pressure (ambient) temperature
- Dew point to relative humidity or relative humidity to dew point conversion

Refer to the SMC website before use.



### Example of air blow/purge air humidity abnormality detection

\* When releasing air blow/purge air from inside piping (under pressure) to a component (atmosphere)

Setting the set value (threshold value) allows for condensation generation to be detected in advance!

Condensation is generated (When the relative humidity inside piping is 100%R.H.)

Relative humidity Inside piping (under pressure)\*1 : 100.0%R.H.  
Atmospheric pressure : 20.0%R.H.

Condensation generation is prevented (Detection when the relative humidity inside piping is 80%R.H.)

Relative humidity Inside piping (under pressure)\*1: When the under pressure value is displayed and the threshold value is 80.0%R.H.  
Atmospheric pressure: When the atmospheric pressure value is displayed and the threshold value is 16.0%R.H.

\*1 Calculated value

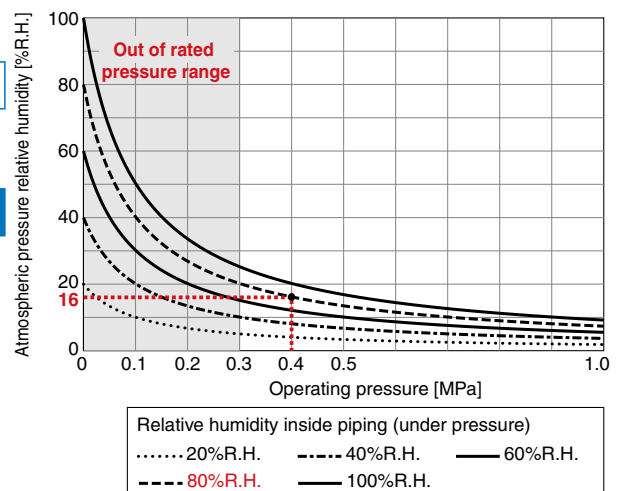

#### Example of operating conditions

Operating pressure : 0.4 MPa  
Temperature inside piping : 25°C (Measured by the condensation checker)  
Ambient temperature : 25°C

- \* Due to the 0.4 MPa operating pressure, the atmospheric pressure relative humidity is 5 times (1/5 times) the relative humidity inside piping.
- \* When the temperature inside piping and the atmospheric pressure (ambient) temperature are the same

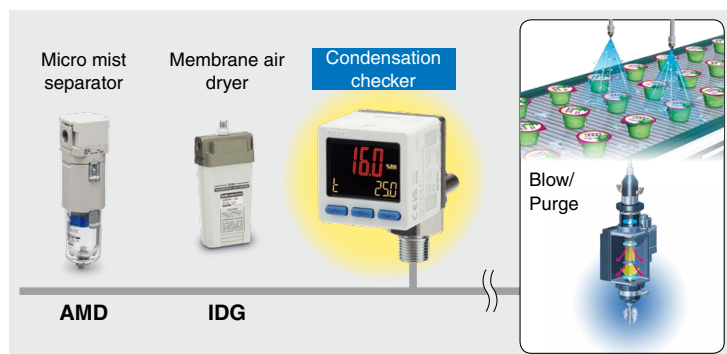

### Detection example of when the refrigerated air dryer humidity is abnormal

\* When the processing capacity of the refrigerated air dryer drops

**Setting the threshold value allows for the detection of an abnormality before condensation is generated!**

**Normal conditions** Pressure dew point : 10°Cdp (IDF/IDU specification)

Relative humidity Inside piping (under pressure)\*1 : 52.5%R.H.  
Atmospheric pressure : 8.8%R.H.

**Dryer processing capacity drop**

**Abnormal conditions** Pressure dew point: Equivalent to 20°Cdp (Pressure dew point = ambient temperature)

Relative humidity Inside piping (under pressure)\*1: When the under pressure value is displayed and the threshold value is 100.0%R.H.  
Atmospheric pressure: When the atmospheric pressure value is displayed and the threshold value is 16.7%R.H.

\*1 Calculated value

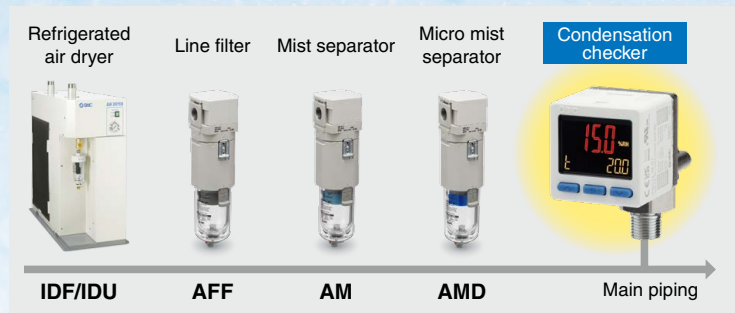
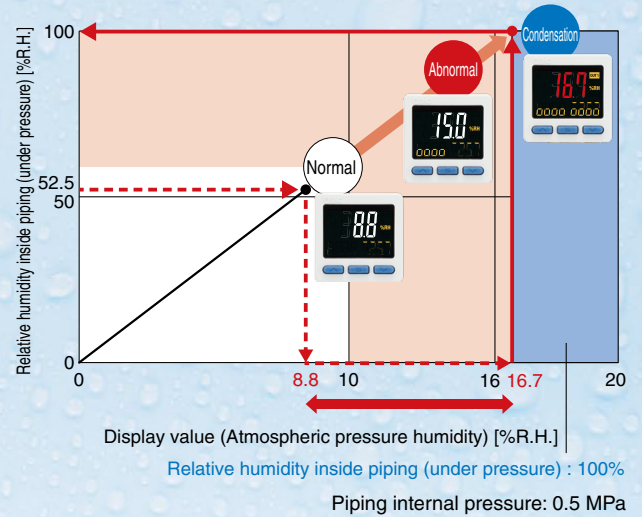

#### Example of operating conditions

Operating pressure : 0.5 MPa  
Temperature inside piping : 20°C (Measured by the condensation checker)  
Ambient temperature : 20°C  
\* Due to the 0.5 MPa operating pressure, the atmospheric pressure relative humidity is 6 times (1/6 times) the relative humidity inside piping.  
\* When the temperature inside piping and the atmospheric pressure (ambient) temperature are the same

### Example of deciding to install a membrane air dryer and confirming the effectiveness

\* When installing a membrane air dryer after confirming like likelihood of condensation/water droplet generation

**Visualization of the effectiveness of the membrane air dryer is possible via the condensation checker!**  
(Be sure to take the pressure dew point/operating pressure and the accuracy of the condensation checker's atmospheric pressure relative humidity into consideration.)

**Current situation** \* There is a risk of condensation generation when the relative humidity in the piping is 80%R.H.

Relative humidity Inside piping (under pressure)\*1 : 80.0%R.H.  
Atmospheric pressure : 20.0%R.H.  
Pressure dew point\*1 : 16.4°Cdp

**Installation of membrane air dryer**

**Benefits** \* Relative humidity in piping : 32.4%R.H. ← 80%R.H.

Relative humidity Inside piping (under pressure)\*1: When the under pressure value is displayed and the threshold value is 32.4%R.H.  
Atmospheric pressure: When the atmospheric pressure value is displayed and the threshold value is 8.1%R.H.  
Pressure dew point\*1: 3.0°Cdp

\*1 Calculated value

#### Caution

This product's ability to detect low dew points is limited.  
If measurement of the exact dew point is required, use a dew point meter.

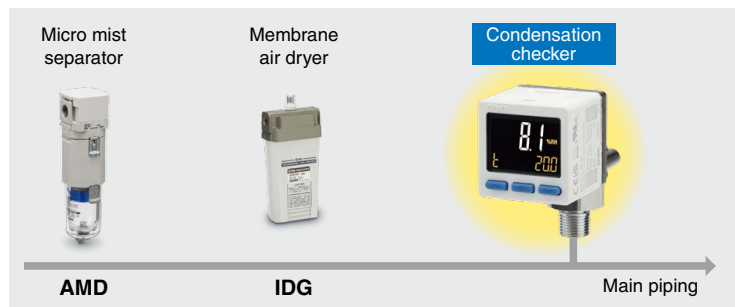

#### Example of operating conditions

Operating pressure : 0.3 MPa  
Temperature inside piping : 20°C (Measured by the condensation checker)  
Ambient temperature : 20°C  
\* Due to the 0.3 MPa operating pressure, the atmospheric pressure relative humidity is 4 times (1/4 times) the relative humidity inside piping.  
\* When the temperature inside piping and the atmospheric pressure (ambient) temperature are the same

### When the temperature inside the piping (measured via the condensation checker) and the atmospheric pressure (ambient) temperature are different

\* For more information on calculation methods, refer to "Changes in temperature inside piping" in the technical data on page 16.

### Example of membrane air dryer high humidity status confirmation

**Numerical confirmation**  
Confirmation via output Constant monitoring

**Visual confirmation**  
Confirmation via color Operator confirmation

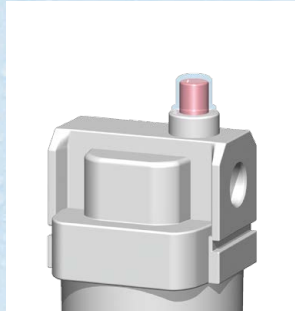

### Simple 3-Step Setting

When the SET button is pressed and the set value (P\_1) is being displayed, the set value (threshold value) can be set. When the SET button is pressed and the hysteresis (H\_1) is being displayed, the hysteresis value can be set.

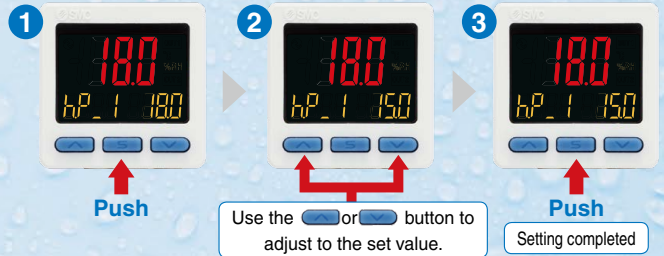

Items for 3-step setting (Sub-display)  
OUT1 set value/hysteresis, OUT2 set value/hysteresis, Operating pressure set value

### Relative humidity under pressure display function

By inputting the operating pressure, the calculation and display of the relative humidity under pressure from the atmospheric pressure relative humidity is possible.

\* When the temperature inside the piping and the condensation checker display temperature are different, correction of the display value is required.

Switching between atmospheric pressure relative humidity display and relative humidity under pressure display is possible.

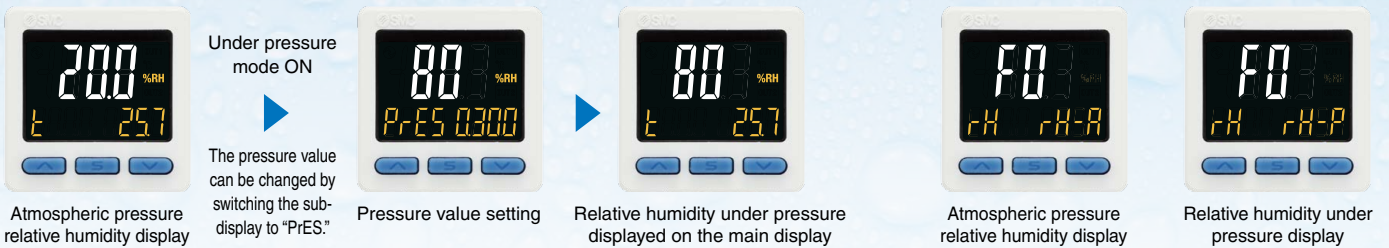

### Visualization of set items/status (sub-display)

The display can be switched via the up and down buttons. The following are display examples.

\*1 3-step setting is possible.

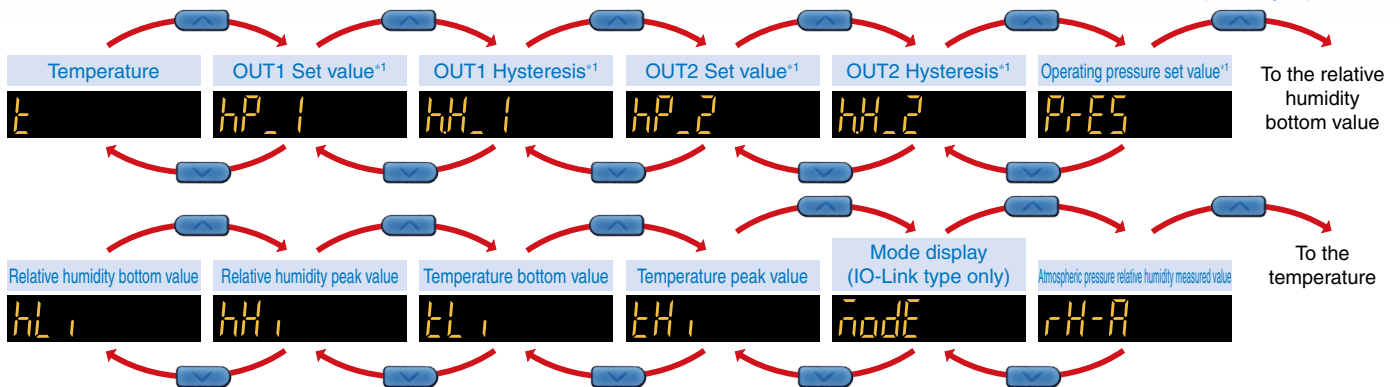

### Level bar display

The level bar shows the difference from the set value.

● Relative humidity inside piping (under pressure)

○ Atmospheric pressure relative humidity (Condensation checker display)

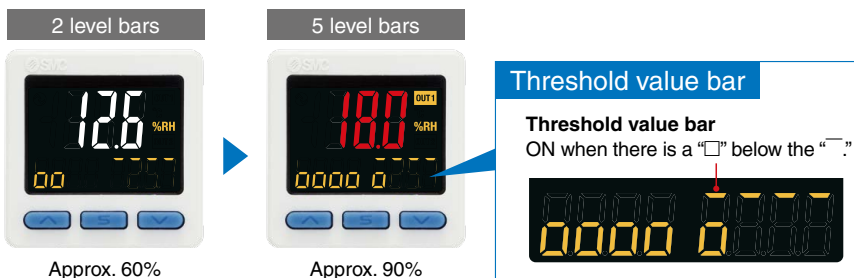

\* When the piping internal pressure is 0.4 MPa, the temperature inside piping and the atmospheric pressure (ambient) temperature are set to 25°C, and the set value (threshold value) is 90%



## Analog free span

The analog span point (5 V) can be set between 10 and 100%R.H.

**Example** For relative humidity

Analog output

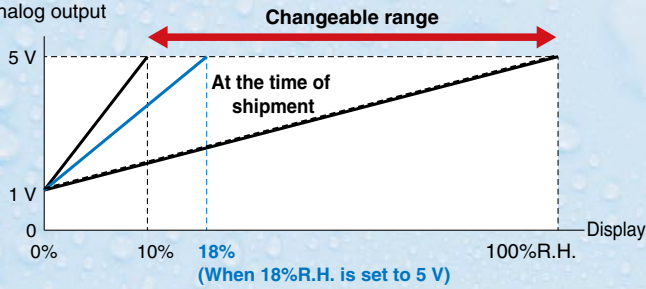

## 2-color display type

The abnormal condition can be confirmed at a glance by the change in color.



Output OFF (White)



Output ON (Red)

## Relative humidity ↔ Temperature (Switchable)

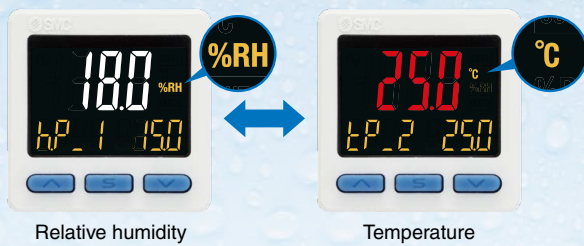

Main screen	Temperature ↔ Relative humidity (Atmospheric pressure/Under pressure)
OUT1	Temperature ↔ Relative humidity (Atmospheric pressure/Under pressure)
OUT2	Temperature ↔ Relative humidity (Atmospheric pressure/Under pressure)
Analog output	Temperature ↔ Relative humidity (Atmospheric pressure/Under pressure)

\* Switching between atmospheric pressure relative humidity display and relative humidity under pressure display is possible via function selection mode (F0).

## NPN/PNP switching function

A single unit supports both NPN and PNP. Therefore, the number of items to keep in stock can be reduced.

Press the "UP" or "DOWN" key to select the switch output specification.



NPN output



PNP output



# CONTENTS

---

## **3-Screen Display** Condensation Checker (Digital Temperature & Humidity Switch) *PSH Series*



How to Order .....	p. 7
Accessories Part Number .....	p. 7
Specifications .....	p. 8
Settable Range .....	p. 10
Internal Circuits and Wiring Examples .....	p. 11
Dimensions .....	p. 12
Technical Data .....	p. 15
Safety Instructions .....	Back cover

3-Screen Display



IO-Link



Condensation Checker (Digital Temperature & Humidity Switch)



# PSH Series



## How to Order

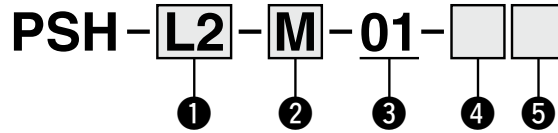

### 1 Output specification

Symbol	Description*1	At the time of factory shipment*2 (Relative humidity under pressure display)
<b>L2</b>	IO-Link/Switch output 1 + Switch output 2 (Switch output: NPN or PNP switching type)	OFF
<b>LL</b>		ON
<b>RT</b>	Switch output 1 + Switch output 2 + Analog voltage output (Switch output: NPN or PNP switching type)	OFF
<b>RR</b>		ON

\*1 Switch output 1/2, analog voltage output can be set to relative humidity or temperature.  
\*2 The display mode at the time of factory shipment is different, but the product specifications are the same.

### 2 Units specification

Symbol	Description
<b>Nil</b>	Units selection function*1
<b>M</b>	SI units only*2

\*1 Under the New Measurement Act, switches with the units selection function are no longer allowed for use in Japan. A unit label is supplied.  
\*2 Fixed units: % R.H., °C

### 3 Piping specification

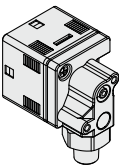

Symbol	Description
<b>01</b>	R1/8 

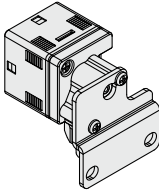
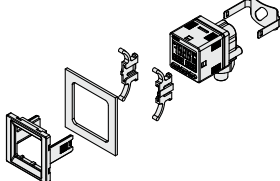
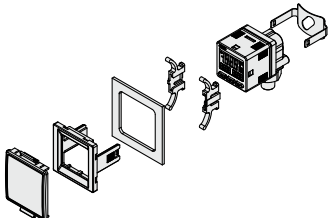
### 5 Option 2

Symbol	Description
<b>Nil</b>	None
<b>A</b>	Bracket  ZS-55-A
<b>B</b>	Panel mount adapter  ZS-55-B
<b>D</b>	Panel mount adapter + Front protection cover  ZS-55-D

\* When mounting with a panel mount adapter, there are conditions that need to be met for UL compliance. For details, refer to the operation manual.

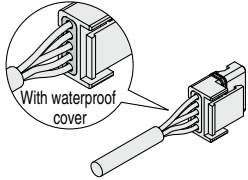
### 4 Option 1

Symbol	Description
<b>Nil</b>	None
<b>W</b>	Lead wire with connector (2 m, Waterproof)  ZS-46-5F
<b>V</b>	Lead wire with connector (2 m, Waterproof, With connector mold cover (straight))  ZS-46-5F-X525
<b>R</b>	Lead wire with connector (2 m, Waterproof, With connector mold cover (right angle))  ZS-46-5F-X526

\* When "V" is selected for option 1, the panel mount adapter cannot be used.

## Accessories Part Number

When an accessory is required separately, order using the part number listed below.

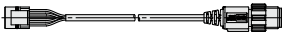
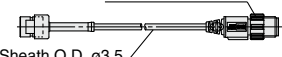
Description	Part no.	Note
Bracket	<b>ZS-55-A</b>	—
Panel mount adapter	<b>ZS-55-B</b>	—
Panel mount adapter + Front protection cover	<b>ZS-55-D</b>	—
Lead wire with connector	<b>ZS-46-5F</b>	5-core, 2 m, Waterproof
Lead wire with M12 connector*1	<b>ZS-46-5FM12</b>	
Lead wire with connector + With connector cover	<b>ZS-46-5F-X472</b>	M12-4 pin, Waterproof Connector size M12  Sheath O.D. ø3.5
Lead wire with connector + With connector mold cover (straight)	<b>ZS-46-5F-X525</b>	5-core, 2 m, Waterproof
Lead wire with connector + With connector mold cover (right angle)	<b>ZS-46-5F-X526</b>	5-core, 2 m, Waterproof
Front protection cover	<b>ZS-35-01</b>	—
Sintered metal filter element	<b>EBD-3.8-3-2</b>	Min. purchase quantity: 10 pcs.

\*1 Analog voltage output is not available.

Refer to the operation manual on the SMC website for the "Specific Product Precautions."



## Specifications

Model		PSH	
<b>Applicable fluid</b>		Air, Non-corrosive gas JIS B 8392-1 1.1.2 to 1.6.2, ISO 8573-1 1.1.2 to 1.6.2	
<b>Temperature</b>	<b>Rated temperature range</b>	0 to 50°C	
	<b>Display and Set temperature range</b>	-5 to 55°C	
	<b>Display and minimum settable increment</b>	0.1 °C	
<b>Relative humidity</b>	<b>Display and Set relative humidity range</b>	0 to 100% R.H. (No condensation)	
	<b>Display and minimum settable increment</b>	0.1% R.H.*4	
<b>Pressure</b>	<b>Rated pressure range</b>	0.3 to 1 MPa	
	<b>Operating pressure range</b>	0.1 to 1 MPa	
	<b>Minimum unit setting</b>	0.001 MPa	
<b>Flow rate consumption</b>		5 L/min (Pressure: 1 MPa) (Reference: Approx. 3 L/min or less at 0.3 MPa)	
<b>Power supply</b>	<b>Power supply voltage</b>	18 to 30 VDC (Including ripple)	
	<b>Current consumption</b>	35 mA or less	
	<b>Protection</b>	Polarity protection	
<b>Accuracy*1, *2</b>	<b>Temperature</b>	<b>Display accuracy</b>	±3°C ±1 digit
		<b>Analog output accuracy*3</b>	±3.5 °C
	<b>Relative humidity</b>	<b>Display accuracy</b>	±5% R.H. ±1 digit*5, *6
		<b>Analog output accuracy*3</b>	±5.5% R.H.
<b>Switch output</b>	<b>Output type</b>	Select from NPN or PNP open collector output.	
	<b>Output mode</b>	Hysteresis mode, Window comparator mode, Error output	
		Output OFF	
	<b>Switch operation</b>	Normal output, Reversed output	
	<b>Max. load current</b>	10 mA	
	<b>Max. applied voltage (NPN only)</b>	30 V	
	<b>Internal voltage drop (Residual voltage)</b>	1.5 V or less (at load current of 10 mA)	
	<b>Hysteresis</b>	<b>Hysteresis mode</b>	Variable from 0
<b>Window comparator mode</b>			
<b>Short circuit protection</b>		Yes	
<b>Analog output</b>	<b>Output type</b>	1 to 5 V*7	
	<b>Output impedance</b>	Approx. 1 kΩ	
<b>Digital filter</b>		0.0 to 60.00 s (0.01 increments)*8	
<b>Display</b>	<b>Units</b>	°C, °F, % R.H.	
	<b>Display type</b>	LCD	
	<b>Number of screens</b>	3-screen display (Main screen, Sub screen x 2)	
	<b>Display color</b>	1) Main screen: White/Red	
		2) Sub screen: Orange	
	<b>Number of display digits</b>	1) Main screen: 3 1/2 digits, 7 segments	
2) Sub screen: 4 digits, 7 segments			
<b>Indicator light</b>		Light is ON when switch output is ON. OUT1, OUT2: Orange	
<b>Environmental resistance</b>	<b>Enclosure rating</b>	IP65	
	<b>Withstand voltage</b>	1000 VAC for 1 min between terminals and housing	
	<b>Insulation resistance</b>	50 MΩ or more (using 500 VDC Mega) between terminals and housing	
	<b>Ambient temperature range</b>	Operating: 0 to 50°C, Storage: -10 to 60°C (No condensation or freezing)	
<b>Ambient humidity range</b>		Operating, Storage: 35 to 85% R.H. (No condensation)*9	
<b>Standards</b>		CE/UKCA (EMC and RoHS directive), UL/CSA (E508758)	
<b>Length of lead wire with connector</b>		2 m	

- \*1 This is the overall accuracy, including the effects of factors such as temperature and repetition.
- \*2 Applicable only when using within the rated pressure range.
- \*3 When using a product with an analog output function. Select temperature or relative humidity using the settings.
- \*4 When the relative humidity under pressure is displayed, it is 1%R.H.
- \*5 The accuracy is relative to the atmospheric pressure relative humidity.  
The relative humidity display of the relative humidity under pressure is a calculated value that includes errors in operating pressure and air pressure.
- \*6 When using within the rated pressure range. The range in which relative humidity can change under atmospheric pressure changes depending on the operating pressure.  
For details, refer to page 10. If the product is used outside the rated pressure range, the accuracy is not guaranteed.
- \*7 Relative humidity: 1 to 5 V output for 0 to 100% R.H. Temperature: 1 to 5 V output for 0 to 50°C.
- \*8 This is the 90% response time to a step input in the internal sensor signal.
- \*9 Do not store in airtight conditions without air exchange.
- \* If the piping contains gases such as oil mist or organic solvents, it may not be possible to meet the specified accuracy or it may cause a malfunction.
- \* Although SMC strive to improve quality, products are considered to be of good quality if there are slight scratches, dirt, display color, uneven brightness, etc. on the exterior that do not affect the performance.

# PSH Series

## Specifications

### Piping Specifications and Weights

Model		PSH
Port size		R1/8
Materials in contact with fluid	Sensor pressure receiving area	Silicon, etc.
	Piping port	SUS303, CAC403, C3604 (Electroless nickel plating), ZDC2 (Nickel plating)
		Glass-fibre epoxy resin
		O-ring: EPDM, FKM
Weight	Body	103 g
	Lead wire with connector	+39 g (For option 1: W), +40 g (For option 1: V, R)

### Cable Specifications

Conductor cross section		0.15 mm <sup>2</sup> (AWG26)
Insulator	Outside diameter	1.0 mm
	Color	Brown, Blue, Black, White, Grey (5-core)
Sheath	Outside diameter	ø3.5

### Communication Specifications (For IO-Link)

IO-Link type	Device															
IO-Link version	V1.1															
Communication speed	COM2 (38.4 kbps)															
Configuration file	IODD file*1															
Minimum cycle time	3.8 ms															
Process data length	Input data: 6 bytes, Output data: 0 bytes															
On request data communication	Supported															
Data storage function	Supported															
Event function	Supported															
Vendor ID	131 (0 x 0083)															
Device ID	PSH-L2 (-M)-*: 728 (0x0002D8) PSH-LL (-M)-*: 729 (0x0002D9)															
Process data	Bit	47...32														
	Item	Relative humidity measurement value (16-bit signed integer)														
	Bit	31...16														
	Item	Temperature measurement value (16-bit signed integer)														
	Bit	15	14	13	12 to 11	10	9	8	7	6	5	4	3	2	1	0
	Item	System error diagnostic	Error diagnostic	Fixed output	0	Relative humidity under pressure display	Temperature diagnostic	0				Temperature SW2	Temperature SW1	Relative humidity SW2	Relative humidity SW1	

\*1 The configuration file can be downloaded from the SMC website, <https://www.smcworld.com>

## Settable Range

The settable range is the range within which the switch output can be set.

### Settable Relative Humidity Range

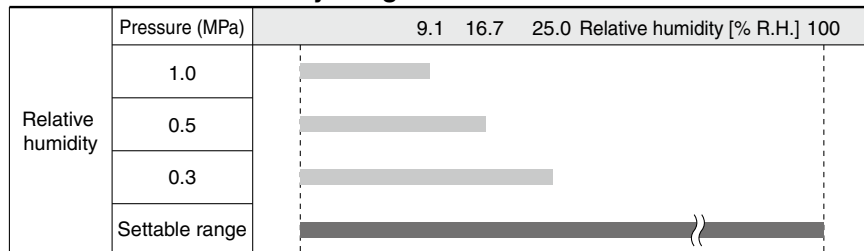

### Settable Temperature Range

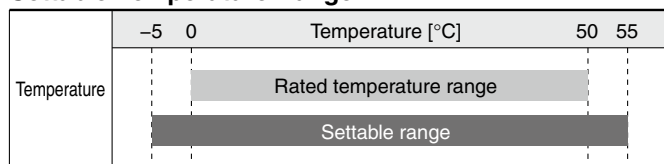

The range of atmospheric pressure and relative humidity that the condensation checker can measure changes depending on the pressure inside the piping (under pressure). For example, if the pressure inside the pipe (under pressure) is 0.3 MPa and the relative humidity is 100% (maximum value), the atmospheric pressure relative humidity when released into the atmosphere will be 25.0%R.H..

If the pressure inside the pipe (under pressure) is 0.3 MPa, the measurable range of the condensation checker is 25.0%R.H..

Atmospheric pressure relative humidity  $\pm 5\%$  is guaranteed only when used within the rated pressure range (0.3 to 1.0 MPa).

### Relationship between displayed value (atmospheric pressure relative humidity) and relative humidity inside piping (under pressure)

\* When the temperature inside piping and the atmospheric pressure (ambient) temperature are the same

#### When the piping internal pressure is 0.3 MPa

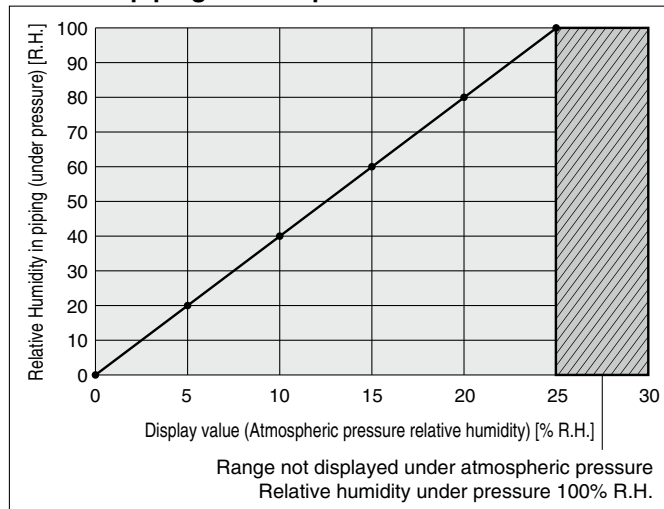

#### When the piping internal pressure is 0.7 MPa

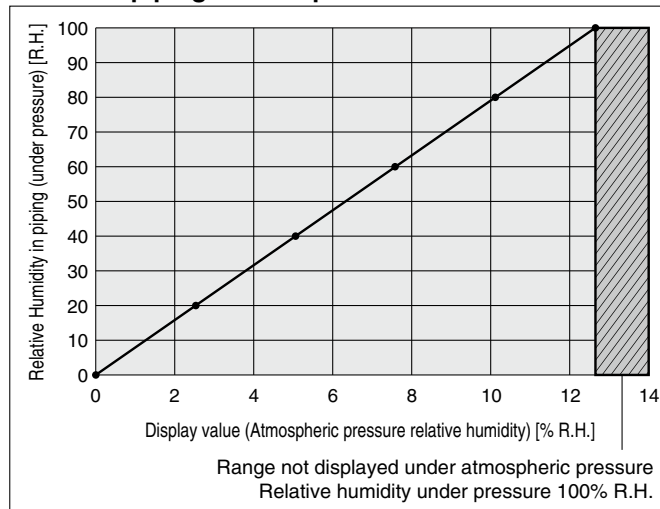

#### When the piping internal pressure is 0.5 MPa

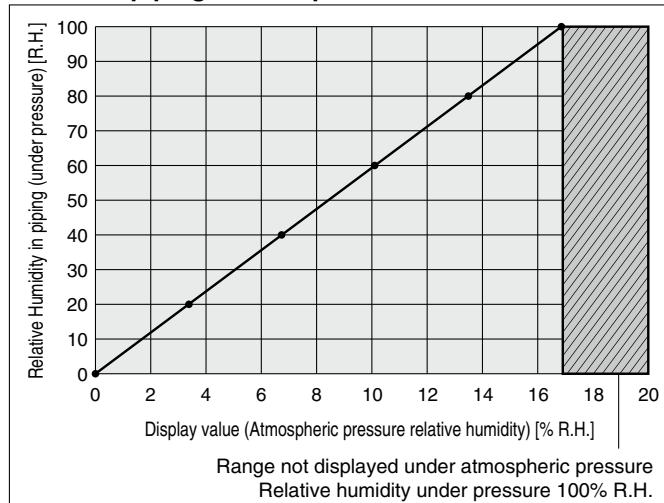

#### When the piping internal pressure is 0.9 MPa

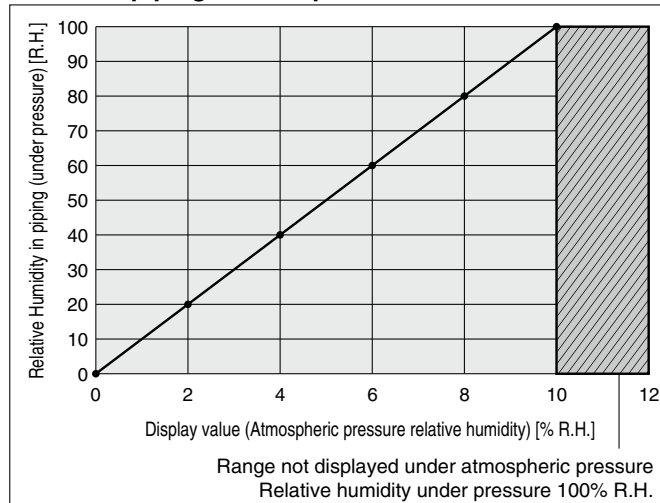

## Internal Circuits and Wiring Examples

**-L2/-LL: IO-Link/Switch output 1 + Switch output 2**  
**When used as a switch output device**

**Setting of NPN open collector 2 outputs**

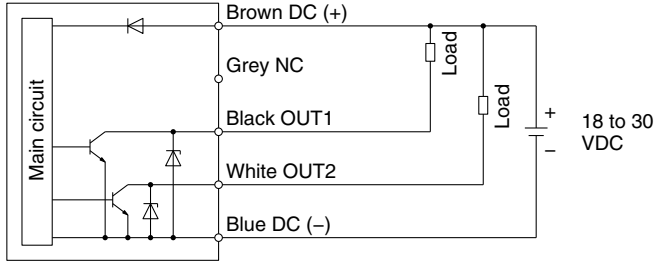

**Setting of PNP open collector 2 outputs**

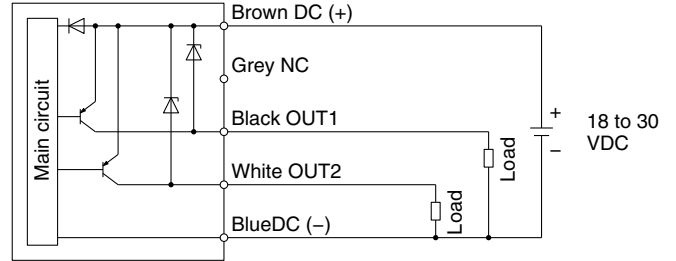

**When used as an IO-Link device**

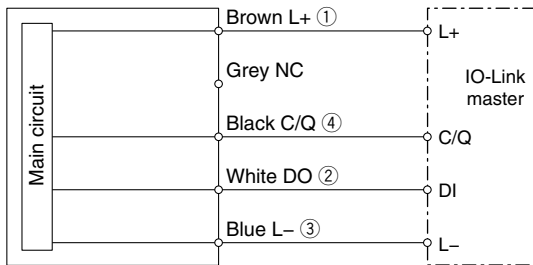

**-RT/-RR: Switch output 2 + Analog voltage output**

**NPN setting**

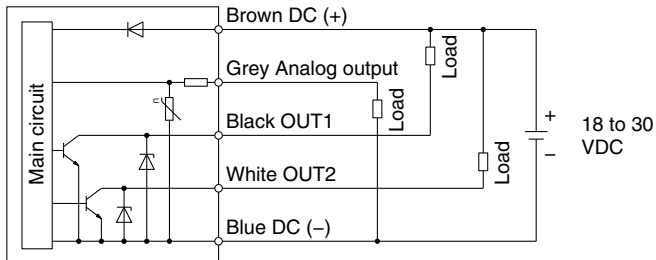

**PNP setting**

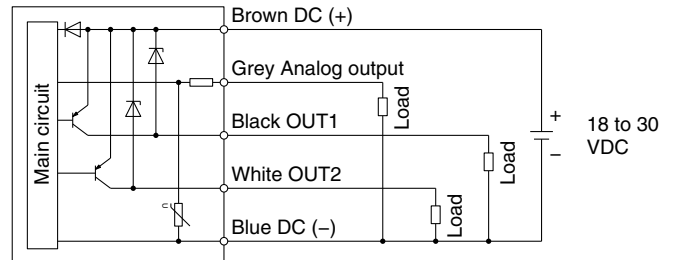

**Dimensions**

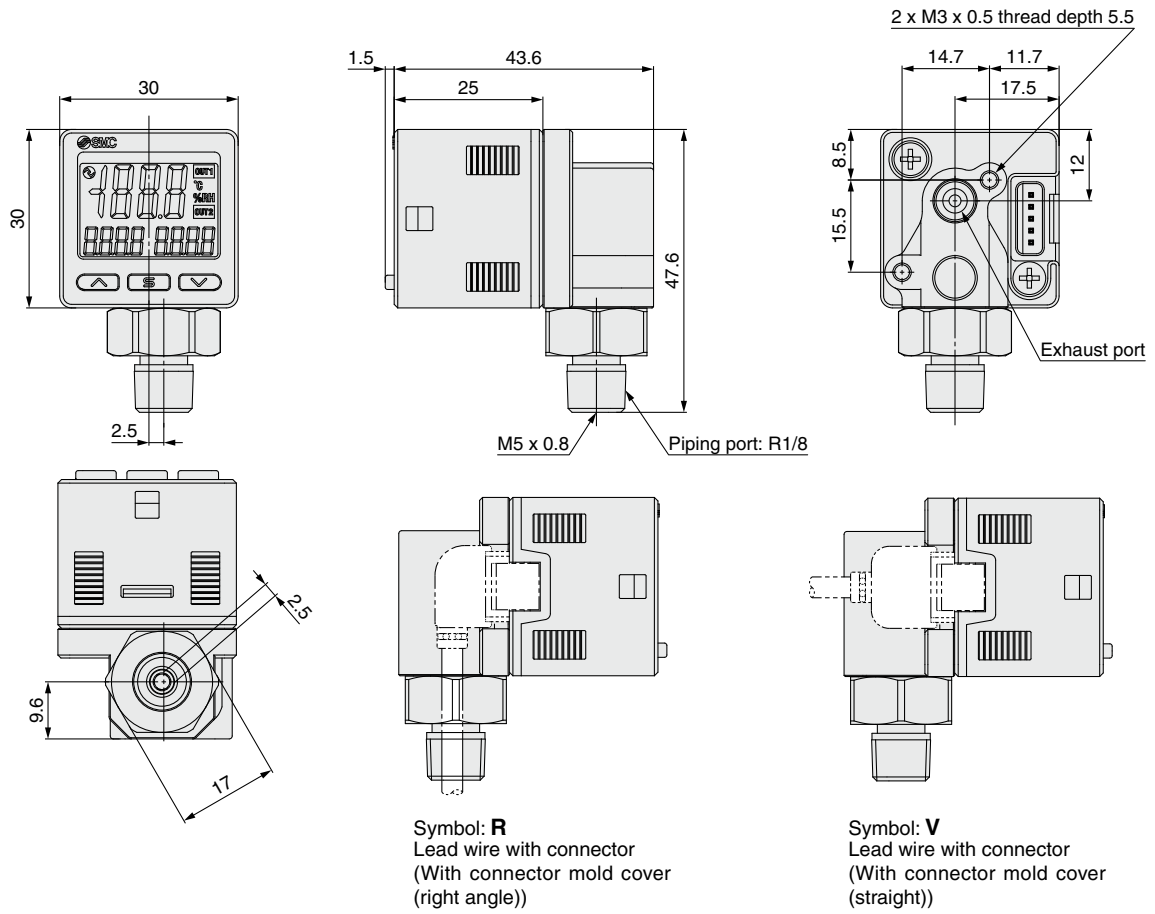

**Bracket mounting dimensions**

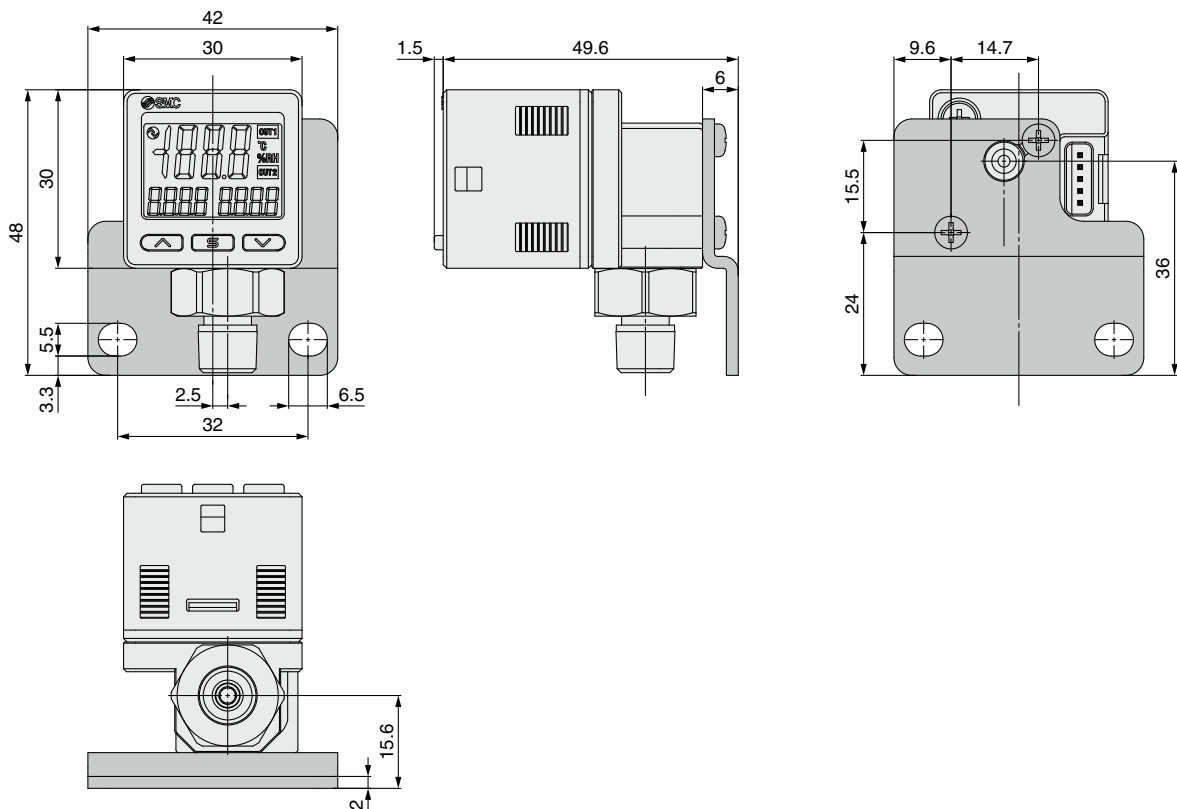

# PSH Series

## Dimensions

### Panel mount adapter mounting dimensions

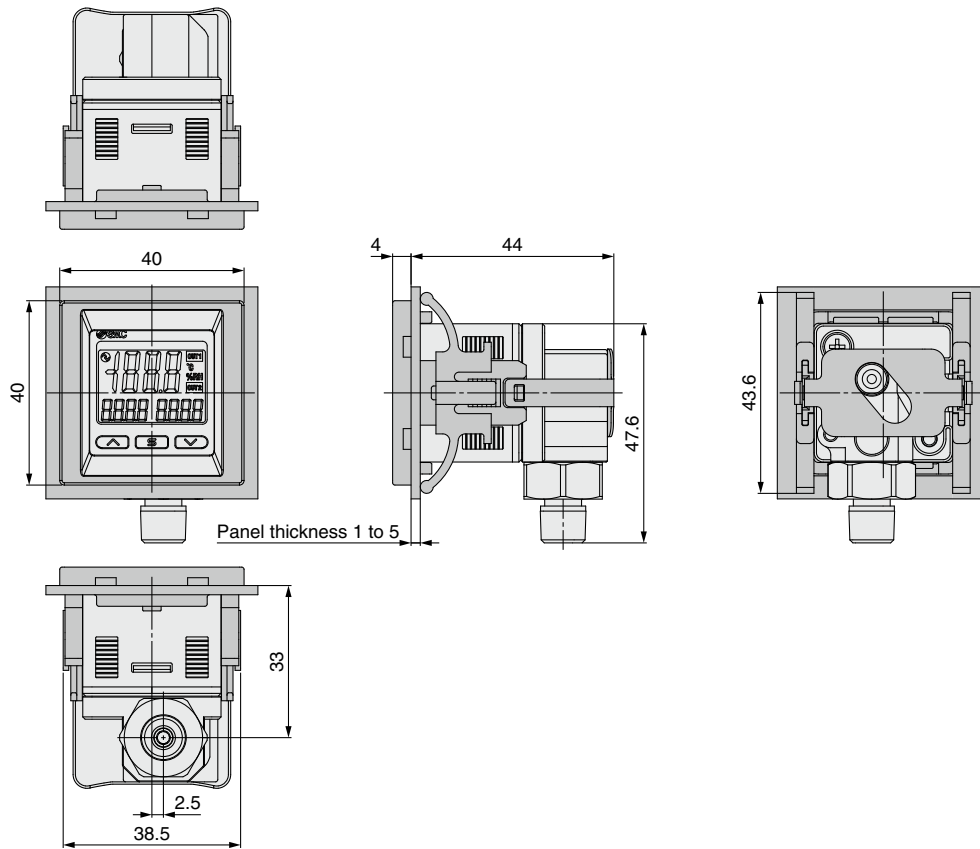

### Panel mount adapter + front protection cover mounting dimensions

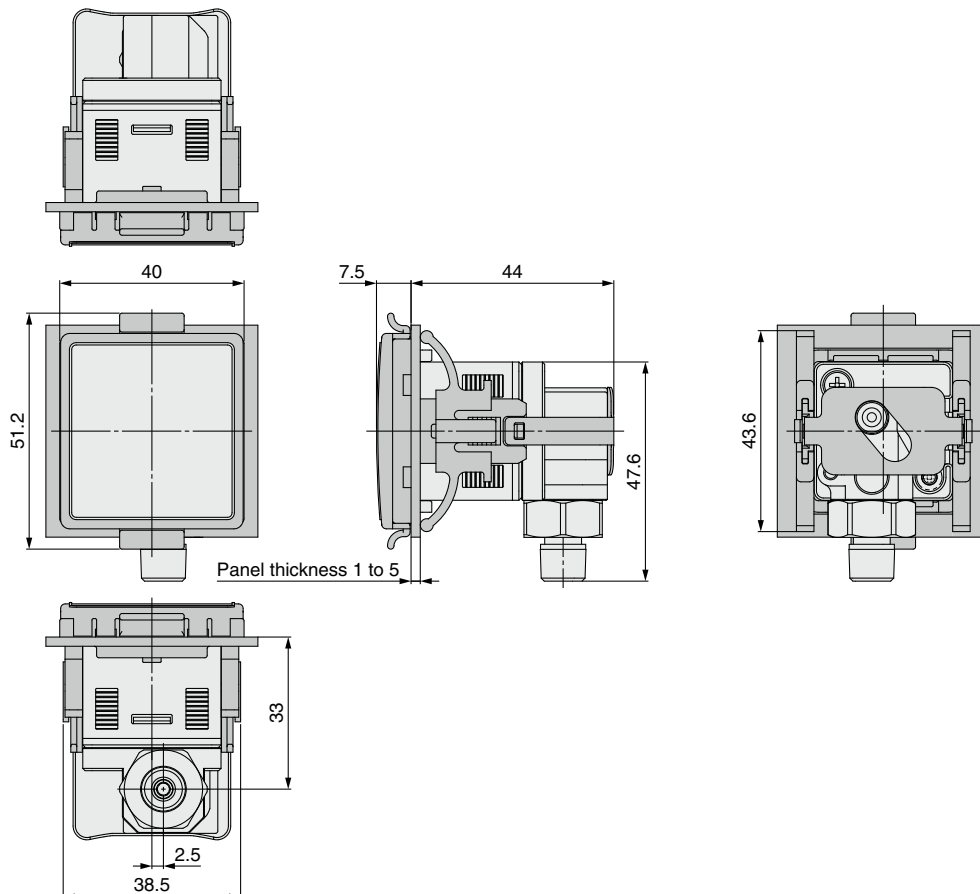



## Dimensions

### Panel cutout dimensions

#### Individual mounting

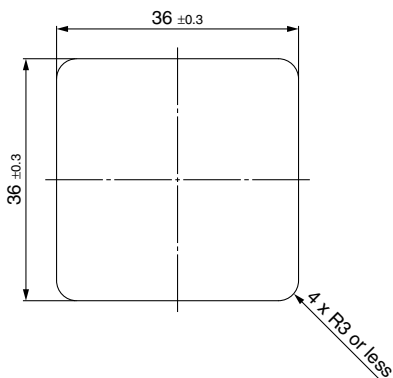

#### Multiple (2 pcs. or more) closely mounted <Horizontal>

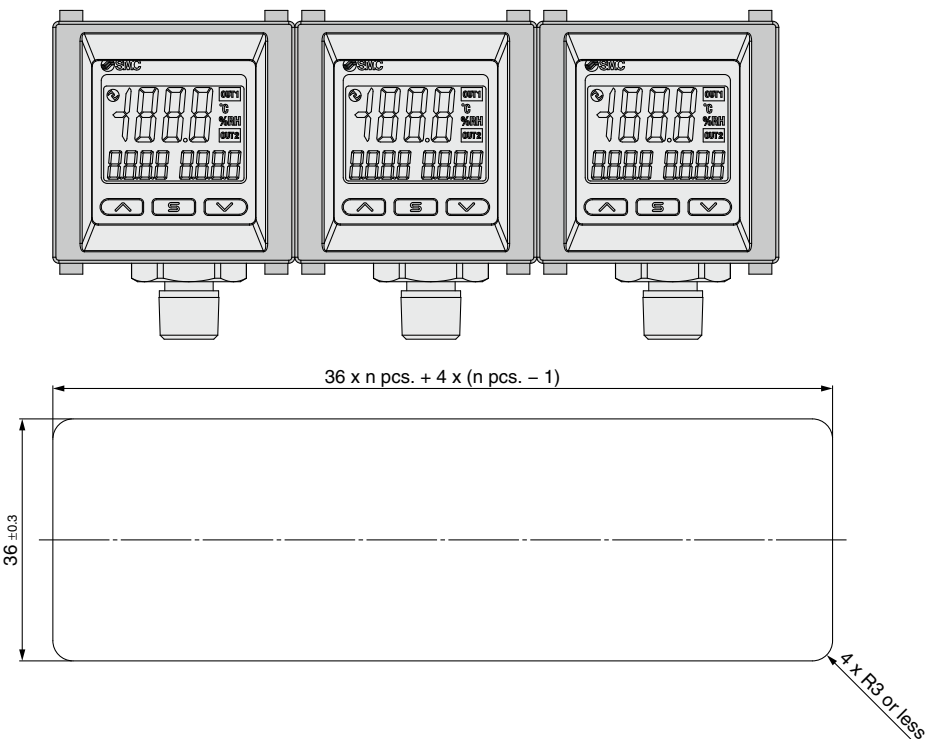

#### Lead wire with connector (Part no.: ZS-46-5F)

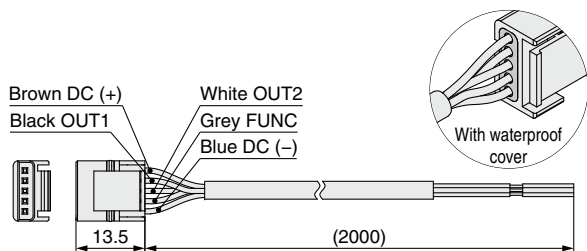

#### Lead wire with M12 connector (Part no.: ZS-46-5FM12)

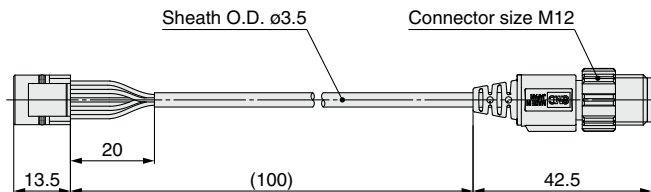

#### Lead wire with connector (With connector mold cover (straight)) (Part no.: ZS-46-5F-X525)

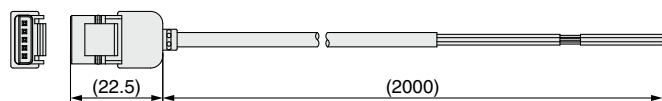

#### Lead wire with M12 connector (With connector cover) (Part no.: ZS-46-5F-X472)

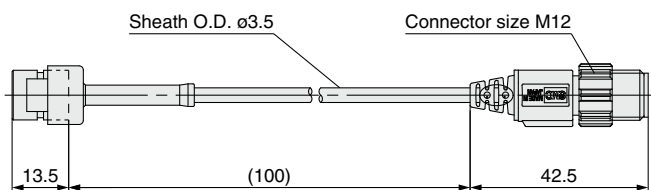

#### Lead wire with connector (With connector mold cover (right angle)) (Part no.: ZS-46-5F-X526)

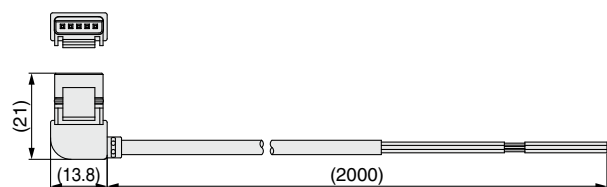

The connector pin assignment is the same as that of the ZS-46-5FM12.

#### Connector pin assignment

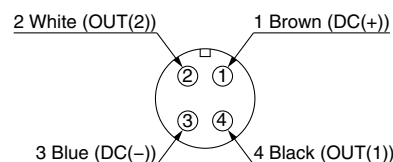

# PSH Series

# Technical Data

## Relative Humidity in Piping (under pressure) ⇔ Atmospheric Pressure Relative Humidity (condensation checker display) Simple Conversion Formula

Relative Humidity is proportional to operating pressure at constant temperature.

Relative Humidity conversion guideline for inside piping (under pressure): It is possible to calculate from the condensation checker display value using the following multiplier.

For 0.3 MPa ⇒ 4 times, For 0.5 MPa ⇒ 6 times, For 0.7 MPa ⇒ 8 times, For 0.9 MPa ⇒ 10 times.

When the operating pressure is 0.4 MPa

$$\text{Relative Humidity in piping (under pressure)} = \frac{0.4 \text{ [MPa]} + 0.1 \text{ [MPa]}}{0.1 \text{ [MPa]}} \times 5 \text{ times} \times \text{Atmospheric pressure relative humidity (condensation checker display value)}$$

$$\text{Atmospheric pressure relative humidity (condensation checker display value)} = \frac{0.1 \text{ [MPa]}}{0.4 \text{ [MPa]} + 0.1 \text{ [MPa]}} \times 1/5 \text{ times} \times \text{In piping (below pressure) relative humidity}$$

## Model Selection Software Setting Examples

### Model Selection Software Humidity conversion/condensed water (drain) calculation software

Supports conversion related to humidity for humidity control

●When the temperature inside piping and the atmospheric pressure (ambient) temperature are different

●Dew point to relative humidity or relative humidity to dew point conversion Refer to the SMC website before use.



#### To determine the threshold value of the condensation checker

\* When the temperature inside piping and the atmospheric pressure (ambient) temperature are the same

Calculation of the relative humidity inside piping (under pressure) ⇒ atmospheric pressure relative humidity

##### Before conversion

Input the status under pressure.

➔① Pressure, ② temperature, and ③ relative humidity under pressure

##### After conversion

Input the status detected by the condensation checker.

➔④ Atmospheric pressure (0 MPa), ⑤ temperature (Same temperature as before conversion)

#### To calculate the relative humidity inside piping (under pressure) from the condensation checker display value

Calculation of the atmospheric pressure relative humidity ⇒ relative humidity inside piping (under pressure)

##### Before conversion

Input the status detected by the condensation checker.

➔Condensation checker ① atmospheric pressure (0 MPa), ② temperature, display value/threshold value (relative humidity)

##### After conversion

Input the status under pressure.

➔④ Pressure, and ⑤ temperature under pressure (Same temperature as before conversion)

Before conversion			
Select the air humidity you are aware of and enter the humidity and condition.			
<input checked="" type="radio"/> Relative humidity <input type="radio"/> Atmospheric dew point <input type="radio"/> Pressure dew point			
Pressure (P <sub>1</sub> )	0.4	MPa	[0~10]
Temperature (T <sub>1</sub> )	20	°C	[-99~99]
Relative humidity	90	%	[0.1~100]
Atmospheric dew point	-4.5	°C	[-99~99]
Pressure dew point	18.3	°C	[-99~99]



after conversion			
Calculation is performed when the air to be calculated is P <sub>2</sub> and T <sub>2</sub> . Enter P <sub>2</sub> and T <sub>2</sub> .			
Pressure (P <sub>2</sub> )	0	MPa	[0~10]
Temperature (T <sub>2</sub> )	20	°C	[-99~99]
Relative humidity	18	%	[0.1~100]
Atmospheric dew point	-4.5	°C	[-99~99]
Pressure dew point	-4.5	°C	[-99~99]

## When the temperature inside piping changes

The relative humidity changes according to the temperature. If the temperature inside piping changes due to the distance from the monitoring point, the relative humidity can be calculated using SMC's "Model Selection Software."

**Example: To confirm the conditions on a cold day when water droplets are often generated by the cylinder**

\* The condensation checker cannot be installed close to a cylinder, so it is installed at a distance.

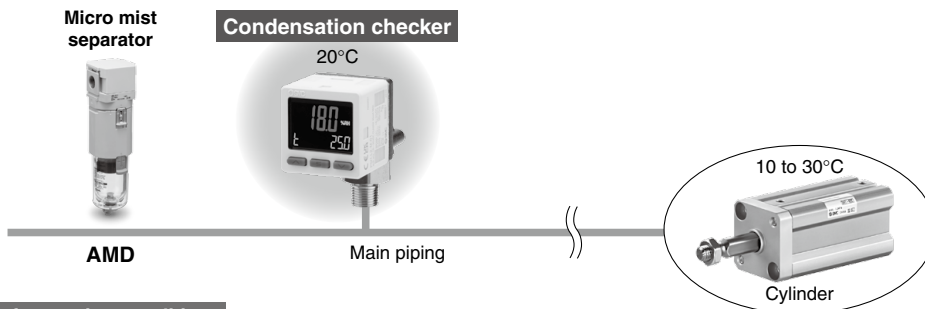

### Example of operating conditions

- ① Operating pressure : 0.3MPa
- ② Temperature inside piping: 20°C (Condensation checker display value)
- ③ Temperature inside piping near cylinder: 10°C
- ④ Atmospheric pressure relative humidity inside piping: 12% (Condensation checker display value)

Before conversion				after conversion			
Select the air humidity you are aware of and enter the humidity and condition.				Calculation is performed when the air to be calculated is P <sub>2</sub> and T <sub>2</sub> . Enter P <sub>2</sub> and T <sub>2</sub> .			
<input checked="" type="radio"/> Relative humidity <input type="radio"/> Atmospheric dew point <input type="radio"/> Pressure dew point							
Pressure (P <sub>1</sub> )	0	MPa	[0~10]	Pressure (P <sub>2</sub> )	0.3	MPa	[0~10]
Temperature (T <sub>1</sub> )	20	°C	[-99~99]	Temperature (T <sub>2</sub> )	10	°C	[-99~99]
Relative humidity	12	%	[0.1~100]	Relative humidity	91.4	%	[0.1~100]
Atmospheric dew point	-9.1	°C	[-99~99]	Atmospheric dew point	-9.1	°C	[-99~99]
Pressure dew point	-9.1	°C	[-99~99]	Pressure dew point	8.7	°C	[-99~99]

The relative humidity inside the terminal piping (under pressure) is 91.4%R.H.

Input the atmospheric pressure (MPa) for the pressure (P1).

When the temperature rises in the conditions shown on the above  
 When the temperature near the cylinder rises to 30°C, the relative humidity inside piping can be calculated as follows.  
 (Measure the temperature as required.)

Before conversion				after conversion			
Select the air humidity you are aware of and enter the humidity and condition.				Calculation is performed when the air to be calculated is P <sub>2</sub> and T <sub>2</sub> . Enter P <sub>2</sub> and T <sub>2</sub> .			
<input checked="" type="radio"/> Relative humidity <input type="radio"/> Atmospheric dew point <input type="radio"/> Pressure dew point							
Pressure (P <sub>1</sub> )	0	MPa	[0~10]	Pressure (P <sub>2</sub> )	0.3	MPa	[0~10]
Temperature (T <sub>1</sub> )	20	°C	[-99~99]	Temperature (T <sub>2</sub> )	30	°C	[-99~99]
Relative humidity	12	%	[0.1~100]	Relative humidity	26.4	%	[0.1~100]
Atmospheric dew point	-9.1	°C	[-99~99]	Atmospheric dew point	-9.1	°C	[-99~99]
Pressure dew point	-9.1	°C	[-99~99]	Pressure dew point	8.7	°C	[-99~99]

The relative humidity inside the terminal piping (under pressure) is 26.4%R.H.

## When the temperature inside piping changes

---

### ⚠ Caution

#### Condensation Checker precautions

Do not separate the condensation checker from the fluid to be measured.

\* Measurement accuracy and responsiveness performance will be reduced.

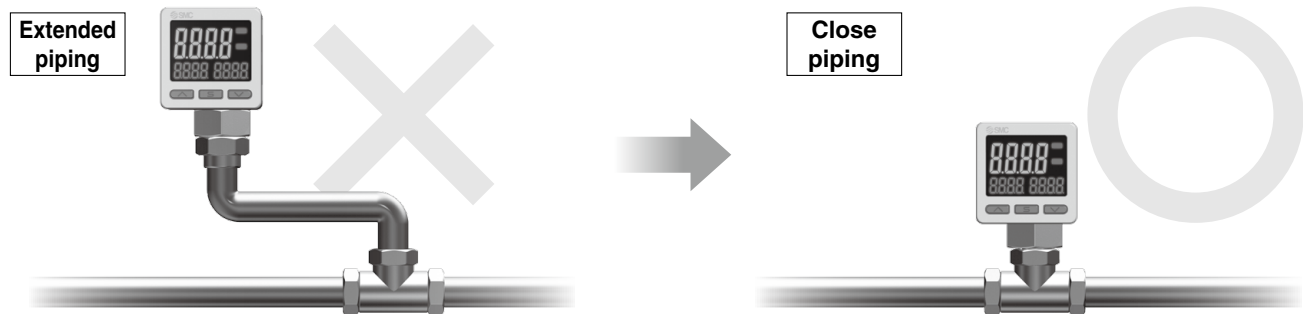



If the product is separated from the original piping, accurate measurements will no longer be possible due to external disturbances such as temperature variation in the extended piping. In addition, increasing the distance from the original piping slows down the temperature transmission and the response.

Direct mounting to the piping is recommended.

## Safety Instructions

These safety instructions are intended to prevent hazardous situations and/or equipment damage. These instructions indicate the level of potential hazard with the labels of “**Caution**,” “**Warning**” or “**Danger**.” They are all important notes for safety and must be followed in addition to International Standards (ISO/IEC)\*1), and other safety regulations.

 **Danger** : **Danger** indicates a hazard with a high level of risk which, if not avoided, will result in death or serious injury.

 **Warning**: **Warning** indicates a hazard with a medium level of risk which, if not avoided, could result in death or serious injury.

 **Caution**: **Caution** indicates a hazard with a low level of risk which, if not avoided, could result in minor or moderate injury.

\*1) ISO 4414: Pneumatic fluid power - General rules and safety requirements for systems and their components  
ISO 4413: Hydraulic fluid power - General rules and safety requirements for systems and their components  
IEC 60204-1: Safety of machinery - Electrical equipment of machines - Part 1: General requirements  
ISO 10218-1: Robots and robotic devices - Safety requirements for industrial robots - Part 1: Robots etc.

### Warning

#### 1. The compatibility of the product is the responsibility of the person who designs the equipment or decides its specifications.

Since the product specified here is used under various operating conditions, its compatibility with specific equipment must be decided by the person who designs the equipment or decides its specifications based on necessary analysis and test results. The expected performance and safety assurance of the equipment will be the responsibility of the person who has determined its compatibility with the product. This person should also continuously review all specifications of the product referring to its latest catalog information, with a view to giving due consideration to any possibility of equipment failure when configuring the equipment.

#### 2. Only personnel with appropriate training should operate machinery and equipment.

The product specified here may become unsafe if handled incorrectly. The assembly, operation and maintenance of machines or equipment including our products must be performed by an operator who is appropriately trained and experienced.

#### 3. Do not service or attempt to remove product and machinery/equipment until safety is confirmed.

1. The inspection and maintenance of machinery/equipment should only be performed after measures to prevent falling or runaway of the driven objects have been confirmed.
2. When the product is to be removed, confirm that the safety measures as mentioned above are implemented and the power from any appropriate source is cut, and read and understand the specific product precautions of all relevant products carefully.
3. Before machinery/equipment is restarted, take measures to prevent unexpected operation and malfunction.

#### 4. Our products cannot be used beyond their specifications. Our products are not developed, designed, and manufactured to be used under the following conditions or environments. Use under such conditions or environments is not covered.

1. Conditions and environments outside of the given specifications, or use outdoors or in a place exposed to direct sunlight.
2. Use for nuclear power, railways, aviation, space equipment, ships, vehicles, military application, equipment affecting human life, body, and property, fuel equipment, entertainment equipment, emergency shut-off circuits, press clutches, brake circuits, safety equipment, etc., and use for applications that do not conform to standard specifications such as catalogs and operation manuals.
3. Use for interlock circuits, except for use with double interlock such as installing a mechanical protection function in case of failure. Please periodically inspect the product to confirm that the product is operating properly.

### Caution

**We develop, design, and manufacture our products to be used for automatic control equipment, and provide them for peaceful use in manufacturing industries.**

**Use in non-manufacturing industries is not covered.**

Products we manufacture and sell cannot be used for the purpose of transactions or certification specified in the Measurement Act.

The new Measurement Act prohibits use of any unit other than SI units in Japan.

### Limited warranty and Disclaimer/ Compliance Requirements

The product used is subject to the following “Limited warranty and Disclaimer” and “Compliance Requirements”.

Read and accept them before using the product.

#### Limited warranty and Disclaimer

1. The warranty period of the product is 1 year in service or 1.5 years after the product is delivered, whichever is first.\*2)  
Also, the product may have specified durability, running distance or replacement parts. Please consult your nearest sales branch.
2. For any failure or damage reported within the warranty period which is clearly our responsibility, a replacement product or necessary parts will be provided.  
This limited warranty applies only to our product independently, and not to any other damage incurred due to the failure of the product.
3. Prior to using SMC products, please read and understand the warranty terms and disclaimers noted in the specified catalog for the particular products.

\*2) **Vacuum pads are excluded from this 1 year warranty.**

A vacuum pad is a consumable part, so it is warranted for a year after it is delivered. Also, even within the warranty period, the wear of a product due to the use of the vacuum pad or failure due to the deterioration of rubber material are not covered by the limited warranty.

#### Compliance Requirements

1. The use of SMC products with production equipment for the manufacture of weapons of mass destruction (WMD) or any other weapon is strictly prohibited.
2. The exports of SMC products or technology from one country to another are governed by the relevant security laws and regulations of the countries involved in the transaction. Prior to the shipment of a SMC product to another country, assure that all local rules governing that export are known and followed.

## Safety Instructions

Be sure to read the “Handling Precautions for SMC Products” (M-E03-3) and “Operation Manual” before use.

## SMC Corporation

Akihabara UDX 15F,  
4-14-1, Sotokanda, Chiyoda-ku, Tokyo 101-0021, JAPAN  
Phone: 03-5207-8249 Fax: 03-5298-5362  
<https://www.smcworld.com>  
© 2024 SMC Corporation All Rights Reserved

Specifications are subject to change without prior notice and any obligation on the part of the manufacturer.

D-G