

Line Filter

FH34/44/54/64 Series

Rated Pressure: 3.5, 7, 14, 21 MPa



Compact, solid, and safe design

The case and cover have undergone testing in which they were subjected 100,000 times to impacts equivalent 1.5 times the rated pressure (confirming to MIL standard).

Easy element replacement

The element is extracted from the top, and secured in place by inserting an O-ring seal. The element can be installed and removed easily, simplifying maintenance.

Reliable outlet side

A firm seal is secured through a special configuration combining a pressure clamp from an O-ring around the inner perimeter of the case with support from the cover, and there is no resistance when the cover is installed and removed.

Large drain exhaust port

The large M24 drain exhaust port assures rapid drainage.

Easy fluid flow direction reversal

Simply turn the cover 180° relative to the case mounting base to reverse the fluid flow direction.

Clogging sensor

The filter can be mounted with a differential pressure indicator (reset type) or differential pressure indication switch (common with visual, non-reset type).



Specifications

Fluid		Hydraulic fluid	
Operating pressure		Max. 3.5 MPa	Max. 7, 14, 21 MPa
Operating temperature		Max. 80°C	
Main material	Cover/Case ^{Note 1)}	Aluminum die-cast (3/8, 1/2, 3/4, 1)	Cast iron
	O-ring	Aluminum casted (1 1/4, 1 1/2, 2)	
Element	Material	NBR or FKM ^{Note 2)}	
	Nominal filtration	Paper	
	Differential pressure resistance	5, 10, 20 μm	
	Differential pressure indicator operating pressure (Element replacement differential pressure)	0.6 MPa	
Relief valve open pressure		0.275 MPa	
		0.35 MPa	

Note 1) There may be scratches, discoloration, slight paint peeling, or other defects which do not affect the product's function or performance.

Note 2) The material of the O-rings and seals differs depending on the hydraulic fluid used. Petroleum, Water-glycol, Emulsion: NBR; Phosphoric ester: FKM

Model/Rated Flow Rate

Operating pressure	Model		Port size		Rated flow rate (L/min)		
	Threaded connection	Flange connection	Threaded Rc	Flange SSA			
Max. 3.5 MPa	FH340-03		—	3/8	—	10	
	FH340-04		—	1/2	—	20	
	FH342-06		—	3/4	20 (3/4 ^A)	50	
	FH342-08		—	1	25 (1 ^B)	80	
	FH340-10		FH341-10	1 1/4	32 (1 1/4 ^B)	120	
	FH340-12		FH341-12	1 1/2	40 (1 1/2 ^B)	160	
	—		FH341-16	—	50 (2 ^B)	260	
	FH440-03		—	3/8	—	10	
	FH440-04		FH441-04	1/2	15 (1/2 ^B)	20	
	FH440-06		FH441-06	3/4	20 (3/4 ^B)	50	
Max. 7 MPa	FH440-08		1	25 (1 ^B)	80		
	FH440-10		FH441-10	1 1/4	32 (1 1/4 ^B)	120	
	FH440-12		FH441-12	1 1/2	40 (1 1/2 ^B)	160	
	—		FH441-16	—	50 (2 ^B)	260	
	—		FH441-20	—	65 (2 1/2 ^B)	450	
	—		FH441-24	—	80 (3 ^B)	600	
	Max. 14 MPa	FH540-03		—	3/8	—	10
		FH540-04		FH541-04	1/2	15 (1/2 ^B)	20
		FH540-06		FH541-06	3/4	20 (3/4 ^B)	50
		FH540-08		FH541-08	1	25 (1 ^B)	80
FH540-10		FH541-10	1 1/4	32 (1 1/4 ^B)	120		
FH540-12		FH541-12	1 1/2	40 (1 1/2 ^B)	160		
—		FH541-16	—	50 (2 ^B)	260		
FH640-03		—	3/8	—	10		
FH640-04		FH641-04	1/2	15 (1/2 ^B)	20		
FH640-06		FH641-06	3/4	20 (3/4 ^B)	50		
Max. 21 MPa	FH640-08		FH641-08	1	25 (1 ^B)	80	
	FH640-10		FH641-10	1 1/4	32 (1 1/4 ^B)	120	
	FH640-12		FH641-12	1 1/2	40 (1 1/2 ^B)	160	
	—		FH641-16	—	50 (2 ^B)	260	

Note 1) Tapered female thread connection conforming to JIS B 0203 is compatible.

Flanges conforming to JIS B 2291 (21 MPa piping flanges for hydraulic use) SSA are compatible.

Accessory/Option

Description	Part no.	Model	Note
Differential pressure indicator	CB-48H	FH34 [‡] to FH44 [‡]	Petroleum, Water-glycol, Emulsion
	CB-48H-V	FH44 [‡]	Phosphoric ester
	CB-52H	FH342	Petroleum, Water-glycol, Emulsion
	CB-52H-V		Phosphoric ester
	CB-64H	FH54 [‡] to FH64 [‡]	Petroleum, Water-glycol, Emulsion
	CB-64H-V	FH64 [‡]	Phosphoric ester
Differential pressure indication switch (N.C. and N.O. common)	CB-49H	FH34 [‡] to FH44 [‡]	Petroleum, Water-glycol, Emulsion
	CB-49H-V	FH44 [‡]	Phosphoric ester
	CB-53H	FH342	Petroleum, Water-glycol, Emulsion
	CB-53H-V		Phosphoric ester
	CB-65H	FH54 [‡] to FH64 [‡]	Petroleum, Water-glycol, Emulsion
	CB-65H-V	FH64 [‡]	Phosphoric ester
Blanking cap (for differential pressure indication part)	AG-9H	FH34 [‡] to FH64 [‡]	Petroleum
	AG-9H-W		Water-glycol, Emulsion
	AG-9H-V		Phosphoric ester
	AG-12H	FH342	Petroleum
	AG-12H-W		Water-glycol, Emulsion
	AG-12H-V		Phosphoric ester

How to Order

FH 3 40 - 03 - 0 0 0 - P 005 L

Hydraulic filter

Operating pressure (Max.)

3	3.5 MPa
4	7 MPa
5	14 MPa
6	21 MPa

Construction/Connection

40	Element upward removal	Threaded
42*	Element upward removal	Flange

* Indicates 42 for 3.5 MPa, Port sizes 3/4 and 1.

Port size

Symbol	Threaded Rc	Flange SSA
03	3/8	—
04	1/2	15 (1/2 ^B)
06	3/4	20 (3/4 ^B)
08	1	25 (1 ^B)
10	1 1/4	32 (1 1/4 ^B)
12	1 1/2	40 (1 1/2 ^B)
16	—	50 (2 ^B)
20	—	65 (2 1/2 ^B)
24	—	80 (3 ^B)

Note) For selection from thread and flange, refer to "Model/Rated Flow Rate" on page 510.

Differential pressure indication

0	None
1	Differential pressure indicator
2	Differential pressure indication switch ^{Note)}
4*	Differential pressure indicator
5*	Differential pressure indication switch ^{Note)}

Note) N.C. and N.O. common
* Construction 42 only

Relief valve

0	With relief valve
1	None

Nominal filtration

005	5 μm
010	10 μm
020	20 μm

Note) The paper elements for water-glycol or emulsion is 10 μm only.

Fluid direction

Nil	IN left
L	IN right

Element

P	Paper
M*	Micromesh

* The micromesh element is a made to order specification (X0).

Made to Order

Nil	None (Standard)
X0	Micromesh element equipped

Note) [Click here for details](#)

Hydraulic fluid

0	Petroleum	N
1	Water-glycol, Emulsion	W
2	Phosphoric ester	V

Note) N, W and V refer to the hydraulic fluid symbol indicated at the end of the element part number.

Replacement Element Part No. (Including O-ring for element)

Port size	5 μm	10 μm	20 μm	Element size
03 (3/8 ^B), 04 (1/2 ^B)	EP910-005N	EP910-010N	EP910-020N	ø55 x 90
06 (3/4 ^B), 08 (1 ^B)	EP020-005N	EP020-010N	EP020-020N	ø74 x 117
10 (1 1/4 ^B), 12 (1 1/2 ^B)	EP120-005N	EP120-010N	EP120-020N	ø74 x 195
16 (2 ^B)	EP220-005N	EP220-010N	EP220-020N	ø88 x 282
20 (2 1/2 ^B), 24 (3 ^B)	EP820-005N	EP820-010N	EP820-020N	ø119 x 280

Note 1) The symbol at the end of the element part no. indicates the hydraulic fluid type.

N: Petroleum, V: Phosphoric ester, W: Water-glycol, Emulsion (10 μm only)

Note 2) Refer to page 528 for micromesh elements.

Note 3) Above elements require one element per filter.

Construction/Seal List

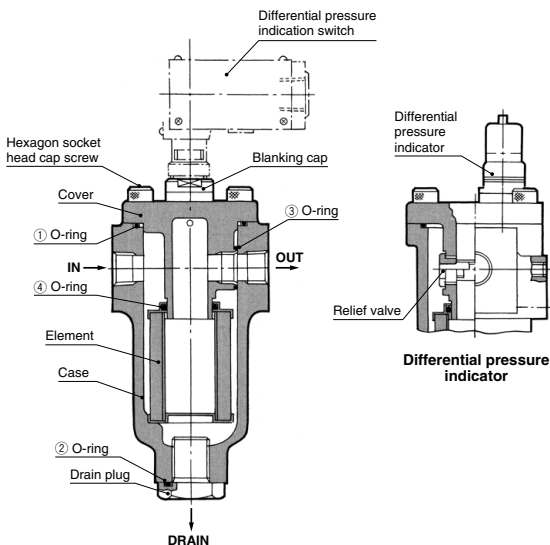

Replacement O-ring/Seal List (One each of the seal and O-ring types listed below are required per filter.)

Applicable hydraulic fluid	Port size	Applicable hydraulic fluid	Material	① O-ring order no. (Nominal size)	② O-ring order no. (Nominal size)	③ O-ring order no. (Nominal size)	④ O-ring order no. (Nominal size)
Petroleum, Water-glycol, Emulsion	FH340 03 to 04	NBR-90	FKM-90	KA00617 (G80)	KA00630	KA00468 (P22A)	KA00471 (P30)
				FH34 06 to 08		KA00611 (G105)	KA00079 (P32)
	FR4C to 6C 03 to 04			KA00615 (G85)		KA00074 (P20)	KA00471 (P30)
	FR4C to 6C 06 to 08			KA00618 (G90)		KA00079 (P32)	KA00082 (P44)
	FR4C to 6C 10 to 12			KA00611 (G105)		KA00806 (P50)	KA00806 (P50)
	FR4C to 6C 16			KA00612M (G145)		KA00809 (P85)	KA00809 (P85)
	FR4C to 6C 20 to 24			KA01296M (G30)		KA00713 (P22A)	KA00104 (P30)
	FH340 03 to 04			KA02476 (G105)		KA00720 (P32)	KA00107 (P44)
	FR4C to 6C 03 to 04			KA01759 (G85)		KA00102 (P20)	KA00104 (P30)
	FR4C to 6C 06 to 08			KA02477 (G90)		KA00720 (P32)	KA00107 (P44)
FR4C to 6C 10 to 12	KA02476 (G105)	KA00722 (P40)	KA00107 (P44)				
FR4C to 6C 16	KA02476 (G105)	KA00636 (P50)	KA00636 (P50)				
FR4C to 6C 20 to 24	KA01760 (G145)	KA00725 (P85)	KA00725 (P85)				

Note) The material and nominal size notations are based on JISB2401.

FH34/44/54/64 Series

Flow Rate Characteristics

FH34/44 Series

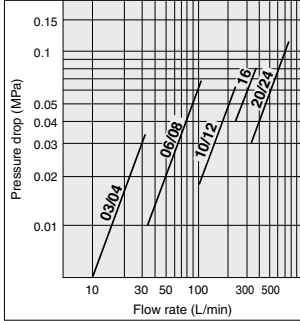

Conditions Fluid: Turbine oil Class 2 VG56
 Measured pressure: 3.5, 7 MPa
 Viscosity: 45 mm²/s
 Filter material: Paper
 Nominal filtration: 10 μm

FH54 Series

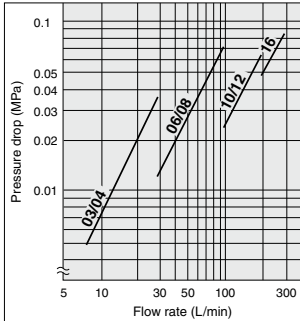

Conditions Fluid: Turbine oil Class 2 VG56
 Measured pressure: 14 MPa
 Viscosity: 45 mm²/s
 Filter material: Paper
 Nominal filtration: 10 μm

FH64 Series

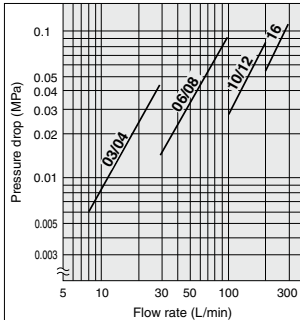

Conditions Fluid: Turbine oil Class 2 VG56
 Measured pressure: 21 MPa
 Viscosity: 45 mm²/s
 Filter material: Paper
 Nominal filtration: 10 μm

Differential Pressure Indication

Two indication methods are available: differential pressure indicator and differential pressure indication switch. These can be mounted on all filter models.

■ Differential pressure indicator

- Operating pressure—0.275 MPa
- Once a value is displayed, it will continue to be displayed until reset, even if the pump is stopped. (Reset type)
- Perform element replacement when the red ring floats up and covers the entire view port.

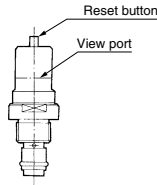

■ Differential pressure indication switch

- Operating pressure—0.275 MPa
- When a value has been displayed, it will be automatically reset when the pump is stopped. (Non-reset type)
- This is a visual dual-purpose. Perform element replacement when the switch has actuated (when the red ring floats up and covers the entire view port).
- N.C. and N.O. common

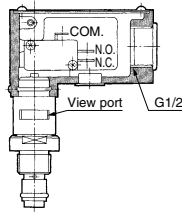

* Refer to page 529 for "Microswitch for differential pressure indication switch".

Handling Precautions

① Mounting

- Confirm INLET and OUTLET before mounting. Then connect so that the drain is oriented downward. For maintenance, make sure to provide sufficient space above the filter for removing the element.

② Operation

- The hydraulic fluid used becomes high viscosity when the temperature is low during the winter, etc., and the differential pressure indicator or the switch may activate. If this occurs, wait until the oil temperature rises by a warm-up operation, then check if this is caused by clogging.
- Once the differential pressure indicator is actuated, the indication continues to be displayed until the indicator is reset (by depressing the reset button), even if the pump stops operating.

Reset after replacing the element and restarting operation, or after normal operation starts in cold weather such as during winter.

- When using a differential pressure indication switch and if a filter clogged signal is incorporated into the sequence circuit of the machine, make sure to design the system so the filter clogged signal does not operate until normal operation starts.

③ Element replacement

- When the pressure difference reaches 0.275 MPa during operation (actuating the differential pressure indicator), stop operation, drain the oil from the case, and replace the element.
- When replacing the element, check the O-rings and replace them if they are damaged.
- When installing and removing an element, do not scratch or damage it by touching the corners of the case, etc.

④ Others

- For the top cover O-ring, use a product of hardness 90 to prevent leaks or damage.
- If there is back pressure, install a check valve on the outlet side to prevent damage to the element.
- Turn the top cover 180° to reverse the oil flow direction.
- Use an auxiliary pipe or the like and apply force evenly when tightening the hexagon socket head cap screws on the cover and case.

Dimensions

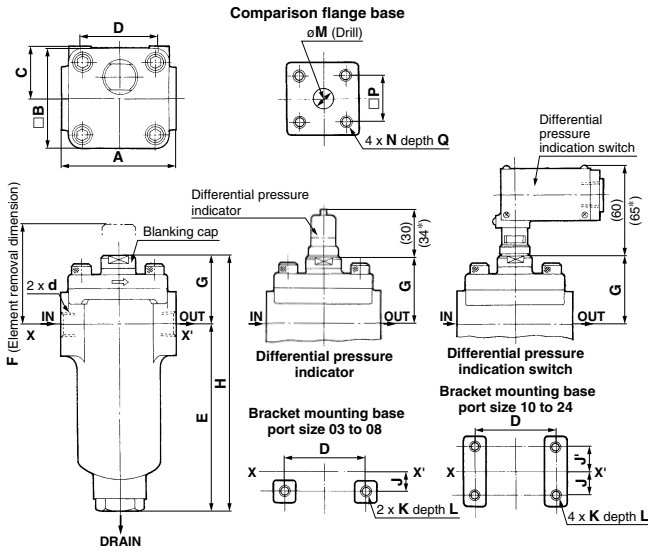

Companion Flange Bolt Dimensions

Port size	Model	Bolt dimension	Flange (JIS B291)	O-ring (JIS B240-1-A)
04	FH441	M10 x 1.5 x 30	SSA15	G25
	FH541	M10 x 1.5 x 40		
06	FH341	M10 x 1.5 x 30	SSA20	G30
	FH441	M10 x 1.5 x 40		
08	FH341	M12 x 1.75 x 40	SSA25	G35
	FH441	M12 x 1.75 x 45		
10	FH341	M12 x 1.75 x 40	SSA32	G40
	FH441	M12 x 1.75 x 45		
12	FH341	M16 x 2 x 50	SSA40	G50
	FH441	M16 x 2 x 60		
16	FH341	M16 x 2 x 50	SSA50	G60
	FH441	M16 x 2 x 60		
20	FH441	M20 x 2.5 x 65	SSA65	G75
24	FH441	M22 x 2.5 x 65	SSA80	G85

Note 1) The companion flange mounting base conforms to JIS B 2291 (21 MPa pipe flanges for hydraulic use) SSA.

Note 2) This filter does not include any companion flange, companion flange bolt, and O-ring.

(*): Internal dimensions for FH342 type

Model	d		A	B	C	D	E	F	G	H	J	J'	K	L	M	N	P	Q	Weight (kg)
	Threaded Rc	Flange SSA																	
FH340-03	3/8	—	105	96	50	80	156	275	57	213	5	—	2 x M8 x 1.25	19	—	—	—	—	1.8
FH340-04	1/2	—	136	120	65	60	175	340	61	236	0	—	2 x M10 x 1.5	15	—	—	—	—	2.5
FH342-06	3/4	—	150	106	56	100	255	435	87	342	50	0	4 x M10 x 1.5	23	32	4 x M12 x 1.75	56	17	4.6
FH342-08	1	—	155	120	70	120	356	545	94	450	60	0	4 x M12 x 1.75	28	46	4 x M16 x 2	65	20	6.4
FH440-03	3/8	—	100	80	45	60	157	285	62	219	0	—	2 x M8 x 1.25	14	—	—	—	—	4.5
FH440-04	1/2	15 (1/2 ^ø)	135	108	57	80	177	330	73	250	0	—	2 x M10 x 1.5	18	16	4 x M10 x 1.5	36	12	8.7
FH440-06	3/4	20 (3/4 ^ø)	150	108	56	100	255	435	87	342	50	0	4 x M10 x 1.5	18	25	4 x M12 x 1.75	48	17	12.2
FH440-08	1	25 (1 ^ø)	160	120	65	92	354	540	94	448	60	0	4 x M12 x 1.75	22	46	4 x M16 x 2	65	20	18.1
FH441-10	1 1/4	32 (1 1/4 ^ø)	220	170	100	130	385	615	119	504	40	25	4 x M12 x 1.75	22	60	4 x M20 x 2.5	92	27	35.9
FH441-12	1 1/2	40 (1 1/2 ^ø)	105	86	45	70	147	285	62	209	0	—	2 x M8 x 1.25	14	—	—	—	—	5.2
FH441-16	—	50 (2 ^ø)	145	108	56	100	177	330	73	250	0	—	2 x M10 x 1.5	18	16	4 x M10 x 1.5	36	12	9.7
FH441-20	—	65 (2 1/2 ^ø)	150	108	56	100	255	435	87	342	50	0	4 x M12 x 1.75	22	25	4 x M12 x 1.75	48	17	12.8
FH441-24	—	80 (3 ^ø)	180	126	70	120	356	545	94	450	60	0	4 x M12 x 1.75	22	46	4 x M16 x 2	73	20	20.4
FH540-03	3/8	—	120	98	51	90	147	285	62	209	0	—	2 x M10 x 1.5	18	—	—	—	—	6.9
FH540-04	1/2	15 (1/2 ^ø)	155	124	65	120	177	330	73	250	0	—	2 x M10 x 1.5	18	16	4 x M10 x 1.5	36	22	12.9
FH540-06	3/4	20 (3/4 ^ø)	180	124	65	125	255	435	87	342	50	0	4 x M12 x 1.75	22	25	4 x M12 x 1.75	56	22	19.8
FH540-08	1	25 (1 ^ø)	180	124	65	125	255	435	87	342	50	0	4 x M12 x 1.75	22	32	4 x M12 x 1.75	56	22	19.8
FH540-10	1 1/4	32 (1 1/4 ^ø)	200	144	75	145	356	545	94	450	60	0	4 x M12 x 1.75	22	46	4 x M16 x 2	73	30	29
FH540-12	1 1/2	40 (1 1/2 ^ø)																	
FH541-16	—	50 (2 ^ø)																	
FH640-03	3/8	—																	
FH640-04	1/2	15 (1/2 ^ø)																	
FH640-06	3/4	20 (3/4 ^ø)																	
FH640-08	1	25 (1 ^ø)																	
FH640-10	1 1/4	32 (1 1/4 ^ø)																	
FH640-12	1 1/2	40 (1 1/2 ^ø)																	
FH641-16	—	50 (2 ^ø)																	

Note) Tapered female thread conforming to JIS B 0203 is compatible.

Flanges conforming to JIS B 2291 (21 MPa pipe flanges for hydraulic use) SSA are compatible.