

# Self-align Fittings H/DL/L/LL Series

RoHS

## Flared ridge ferrule

Prevents accidental loss of ferrule when inserting tubing into the fitting body.

## Hardened ridge ferrule

Prevents breakage of ferrule when tightening nut.

## Flared I.D.

Provides low flow resistance inside the fitting.

## Wide variety of types and sizes

Ten types and five tube O.D.'s provide a wide range of fittings that will fit any application.

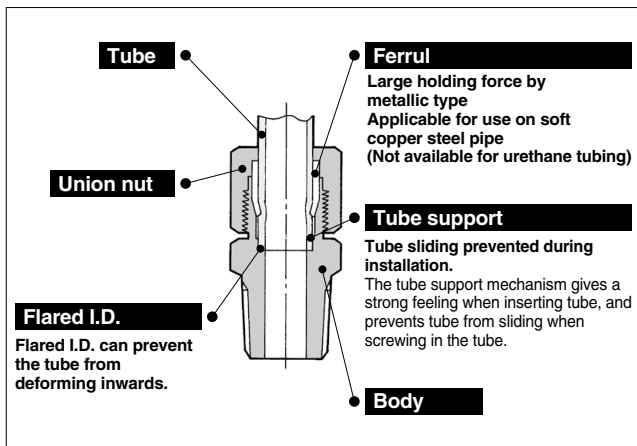

## Specifications

Applicable tubing material		Nylon, Soft nylon, Soft copper steel pipe (C1220T-0)
Applicable tubing O.D.		ø4, ø6, ø8, ø10, ø12
Maximum operating pressure		1 MPa
Proof pressure		10 MPa
Fluid		Air
Thread	Mounting section	JIS B 0203 (Taper thread for piping)
	Nut section	JIS B 0205 (Metric fine thread)
Seal on the threads <sup>(1)</sup>		None or with sealant

Note 1) Male elbow, Male branch tee, Male run tee with sealant is manufactured upon receipt of order. Suffix "S" to the end of part number if w/ sealant is desired.

## Principal Parts Material

Body	C3604, C3771BE
Nut	C3604
Ferrul	C2700



Made to Order

Symbol	Specifications
X2	Applicable to non-copper type (With electroless nickel plated)

Add -X2 at the end of the model number.  
Ex.) H04-01-X2

KQ2

KQB2

KS  
KX

KM

KF

M

H/DL  
L/LL

KC

KK

KK130

DM

KDM

KB

KR

KA

KQG2

KG

KFG2

MS

KKA

KP

LQ

MQR

T

IDK

# H/DL/L/LL Series

## Model

### Male connector

H P. 203



Use to pipe in the same direction from female thread. Most general type.

### Male run tee

DY P. 204



Use to branch line in the same direction from female thread and in 90° direction.

### Male elbow

DL P. 203



Use to pipe at right angles to female thread. Most general type.

### Bulkhead union

DE P. 204



Use to connect tubes through a panel.

### Union tee

DT P. 203



Use to connect tubes in both 90° directions.

### Bulkhead connector

DEF P. 204



Use to connect male thread and tube through a panel.

### Female connector

DHF P. 203



Use to pipe from male thread such as pressure gauge.

### Plug

DP P. 205



Use to plug unused fittings.

### Male branch tee

DT P. 204



Use to branch line from female thread in both 90° directions.

### Swivel elbow

L P. 205



Use to pipe at right angles to female thread. Swiveled at any direction.

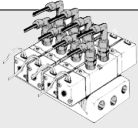

### Swivel extended elbow

LL P. 205



Use to pipe at right angles to female thread. Swiveled at any direction. Solid piece moves fittings up from workpiece.

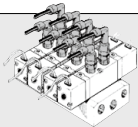

## Male Connector: H

Applicable tubing O.D. (mm)	Connection threads R	Model	H1 (width across flats)	H2 (width across flats)	L	M	A*	Effective area (mm <sup>2</sup> )	Weight (g)	
4	1/8	H04-01	10	10	24.2	15	23.1	4	10	
	1/4	H04-02	14	10	28.6					
6	1/8	H06-01	10	12	24.2	16	23.1	11	12	
	1/4	H06-02	14		28.6				19	
	3/8	H06-03	17		30				24.8	31
8	1/8	H08-01	12	14	24.2	16	23.1	20	16	
	1/4	H08-02	14		28.6				21	
	3/8	H08-03	17		30				24.8	30
10	1/4	H10-02	14	17	28.6	17	23.1	34	28	
	3/8	H10-03	17		30				24.8	37
	1/2	H10-04	22		33.2				25.9	53
12	1/4	H12-02	17	19	29.6	17	24.1	51	30	
	3/8	H12-03	17		30				24.8	39
	1/2	H12-04	22		33.2				25.9	59

\* Reference dimensions after R thread installation.

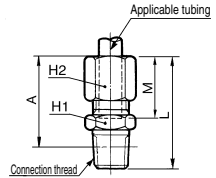

## Male Elbow: DL

Applicable tubing O.D. (mm)	Connection threads R	Model	H1 (width across flats)	H2 (width across flats)	L1	L2	M	A*	Effective area (mm <sup>2</sup> )	Weight (g)		
4	1/8	DL04-01	10	10	23.5	17	15	19.6	3.5	23		
	1/4	DL04-02								19	30	
6	1/8	DL06-01	10	12	23.5	17	16	19.6	9	25		
	1/4	DL06-02								19	31	
	3/8	DL06-03								14	26.5	22
8	1/8	DL08-01	12	14	24.5	18	16	22.6	19	32		
	1/4	DL08-02								21	21.6	38
	3/8	DL08-03								14	26.5	22
10	1/4	DL10-02	14	17	26.5	23	17	25.8	31	51		
	3/8	DL10-03								22	24.5	57
	1/2	DL10-04								17	28.5	27
12	1/4	DL12-02	17	19	28.5	25	17	29.6	43	76		
	3/8	DL12-03								26	30.3	85
	1/2	DL12-04								27	29.4	91

\* Reference dimensions after R thread installation.

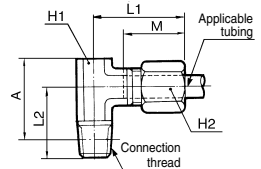
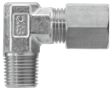

## Union Tee: DT

Applicable tubing O.D. (mm)	Model	H1 (width across flats)	H2 (width across flats)	L	M	Effective area (mm <sup>2</sup> )	Weight (g)
4	DT04-00	10	10	23.5	15	5.7	32
6	DT06-00	10	12	23.5	16	14	36
8	DT08-00	12	14	24.5	16	25	47
10	DT10-00	14	17	26.5	17	49	70
12	DT12-00	17	19	28.5	17	55	70

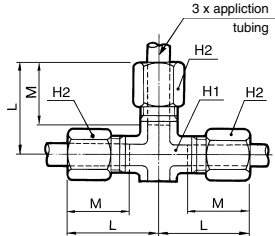

## Female Connector: DHF

Applicable tubing O.D. (mm)	Connection threads Rc	Model	H1 (width across flats)	H2 (width across flats)	L1	L2	M	Effective area (mm <sup>2</sup> )	Weight (g)
4	1/4	DHF04-02	17	10	30.3	16	15	4	27
6	1/4	DHF06-02	17	12	30.8	16.5	16	11	28
	3/8	DHF06-03							19
8	1/4	DHF08-02	17	14	29.8	15.5	16	20	30
10	1/4	DHF10-02	17	17	30.8	16.5	17	34	37
12	1/4	DHF12-02	17	19	30.8	16.5	17	51	40

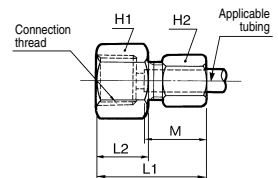

KQ2

KQB2

KS  
KX

KM

KF

M

H/DL  
L/LL

KC

KK

KK130

DM

KDM

KB

KR

KA

KQG2

KG

KFG2

MS

KKA

KP

LQ

MQR

T

IDK

# H/DL/L/LL Series

## Male Branch Tee: DT



Applicable tubing O.D. (mm)	Connection threads R	Model	H1 (width across flats)	H2 (width across flats)	L1	L2	M	A*	Effective area (mm <sup>2</sup> )	Weight (g)
4	1/8	DT04-01	10	10	23.5	17	15	19.6	5.7	33
	1/4	DT04-02				19				44
6	1/8	DT06-01	10	12	23.5	17	16	19.6	14	35
	1/4	DT06-02				19				44
	3/8	DT06-03	14	22	24.5	70				
8	1/8	DT08-01	12	14	24.5	18	16	21.6	25	45
	1/4	DT08-02				21				52
	3/8	DT08-03	14	22	24.5	73				
10	1/4	DT10-02	14	17	26.5	23	17	24.5	49	72
	3/8	DT10-03				22				78
	1/2	DT10-04	17	27	29.4	120				
12	1/4	DT12-02	17	19	28.5	25	17	29.6	55	106
	3/8	DT12-03				26				111
	1/2	DT12-04	27	120						

\* Reference dimensions after R thread installation.

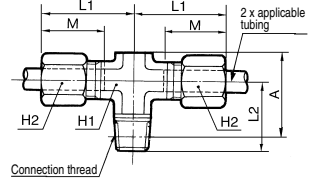

## Male Run Tee: DY



Applicable tubing O.D. (mm)	Connection threads R	Model	H1 (width across flats)	H2 (width across flats)	L1	L2	M	A*	Effective area (mm <sup>2</sup> )	Weight (g)
4	1/8	DY04-01	10	10	23.5	17	15	36.5	6.9	32
	1/4	DY04-02				19				40
6	1/8	DY06-01	10	12	23.5	17	16	36.5	16	36
	1/4	DY06-02				19				42
	3/8	DY06-03	14	22	42.2	66				
8	1/8	DY08-01	12	14	24.5	18	16	38.5	32	44
	1/4	DY08-02				21				51
	3/8	DY08-03	14	22	42.2	69				
10	1/4	DY10-02	14	17	26.5	23	17	43.5	56	70
	3/8	DY10-03				22				77
	1/2	DY10-04	17	27	47.3	116				
12	1/4	DY12-02	17	19	28.5	25	17	47.5	62	106
	3/8	DY12-03				26				112
	1/2	DY12-04	27	119						

\* Reference dimensions after R thread installation.

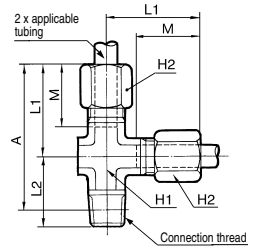

## Bulkhead Union: DE



Applicable tubing O.D. (mm)	Model	H1 (width across flats)	H2 (width across flats)	L	M	Effective area (mm <sup>2</sup> )	Mounting hole	Mounting plate thickness	Weight (g)
4	DE04-00	10	10	47.5	15	4	9	4 max.	29
6	DE06-00	12	12	50.5	16	11	11	4 max.	43
8	DE08-00	14	14	52.5	16	20	13	6 max.	62
10	DE10-00	17	17	55.5	17	34	15	7 max.	93
12	DE12-00	19	19	56.5	17	51	17	7 max.	112

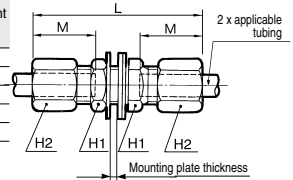

## Bulkhead Connector: DEF



Applicable tubing O.D. (mm)	Connection threads Rc	Model	H1 (width across flats)	H2 (width across flats)	H3 (width across flats)	L1	L2	M	Effective area (mm <sup>2</sup> )	Mounting hole	Mounting plate thickness	Weight (g)
6	1/4	DEF06-02	17	12	12	46.5	15	16	11	11	4 max.	48
8	3/8	DEF08-03	19	14	14	50.5	17	16	20	13	6 max.	66
10	3/8	DEF10-03	19	17	17	53.5	17	17	34	15	7 max.	89
12	3/8	DEF12-03	19	19	19	54.5	17	17	51	17	7 max.	104

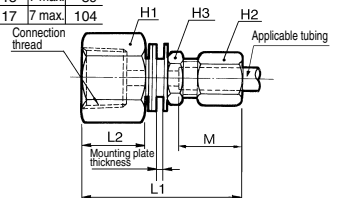

**Plug: DP**



Applicable fitting (mm)	Model	L	øD	Weight (g)
4	DP-04	8	5.6	0.2
6	DP-06		7.6	0.5
8	DP-08		9.6	0.8
10	DP-10		11.6	1.2
12	DP-12		13.6	1.6

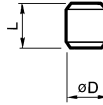

**Swivel Elbow: L**



Applicable tubing O.D. (mm)	Connection thread R	Model	H1 (width across flats)	H2 (width across flats)	H3 (width across flats)	H4 (width across flats)	L1	L2	M	A*	Effective area (mm <sup>2</sup> )	Weight (g)
4	1/8	L04-01	10	10	14	10	21.8	30	15	32.7	3.5	33
	1/4	L04-02				14		34.4		34.7		40
6	1/8	L06-01	12	10	14	10	21.8	30	16	33.8	9	36
	1/4	L06-02				14		34.4		35.8		43
	3/8	L06-03				17		35.8		37.5		55
	1/2	L06-04				22		37.8		40.7		68
8	1/8	L08-01	14	12	17	12	23.3	31	16	36	19	46
	1/4	L08-02				14		35.4		36.7		52
	3/8	L08-03				17		36.8		39.7		61
	1/2	L08-04				22		37.8		42.4		76
10	1/4	L10-02	17	14	19	17	23.3	36.4	17	40.7	31	68
	3/8	L10-03				17		37.8		42.4		76
	1/2	L10-04				22		41		43.5		96
	3/4	L10-05				27		43		46.7		118
12	1/4	L12-02	19	17	22	17	24.3	39.4	17	44.9	43	86
	3/8	L12-03				17		39.8		45.6		94
	1/2	L12-04				22		43		46.7		118
	3/4	L12-05				27		46.7		49.8		143

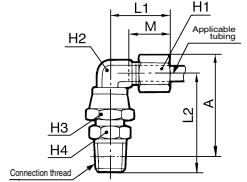

\* Reference dimensions after R thread installation.

**Swivel Extended Elbow: LL**



Applicable tubing O.D. (mm)	Connection thread R	Model	H1 (width across flats)	H2 (width across flats)	H3 (width across flats)	H4 (width across flats)	L1	L2	M	A*	Effective area (mm <sup>2</sup> )	Weight (g)
4	1/8	LL04-01	10	10	14	10	21.8	50	15	52.7	3.5	45
	1/4	LL04-02				14		54.4		54.7		53
6	1/8	LL06-01	12	10	14	10	21.8	51	16	54.8	9	47
	1/4	LL06-02				14		55.4		56.8		44
	3/8	LL06-03				17		56.8		58.5		66
	1/2	LL06-04				22		57		60.7		83
8	1/8	LL08-01	14	12	17	12	23.3	52	16	57	19	63
	1/4	LL08-02				14		56.4		60.7		77
	3/8	LL08-03				17		57.8		62.7		89
	1/2	LL08-04				22		59.8		64.4		98
10	3/8	LL10-03	17	14	19	17	23.3	58.4	17	62.7	31	98
	1/2	LL10-04				17		59.8		65.5		117
	3/4	LL10-05				22		63		67.8		121
	1/2	LL10-06				27		66		69.7		153
12	1/4	LL12-02	19	17	22	17	24.3	62.4	17	67.8	43	121
	3/8	LL12-03				17		62.8		68.5		129
	1/2	LL12-04				22		66		69.7		153
	3/4	LL12-05				27		69.7		72.8		178

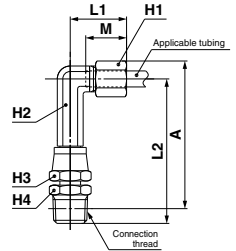

\* Reference dimensions after R thread installation.

- KQ2
- KQB2
- KS
- KX
- KM
- KF
- M
- H/DL
- L/LL
- KC
- KK
- KK130
- DM
- KDM
- KB
- KR
- KA
- KQG2
- KG
- KFG2
- MS
- KKA
- KP
- LQ
- MQR
- T
- IDK

# H/DL/L/LL Series

## Swivel Type/Parts No.

### Swivel type fitting parts lineup

The body of elbow connectors and extended elbow connectors are compatible with almost any fitting. (Except "L-04" and "LL-04" which are for the body of  $\phi 6$  tube.) Swivel fittings, elbow (L) and (LL) constitute the combination with a male connector (H) and connector as shown in the diagram.

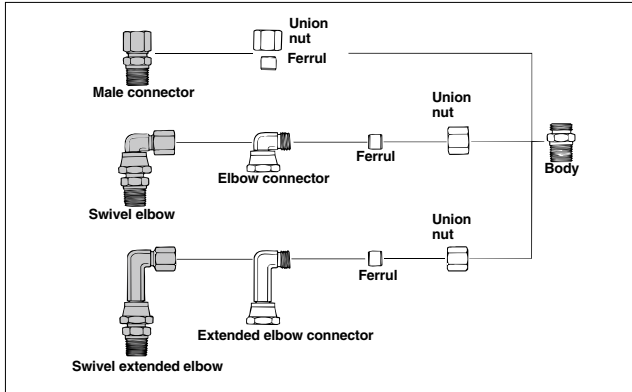

Note) How to install elbow fittings

After tightening by hand, tighten an additional 1/6 to 1/3 turn with a wrench.

Union Nut: N			Elbow Connector: L		Ferrul: S			Extended Elbow Connector: LL	
Part no.	Applicable tubing O.D.	Weight (g)	Part no.	Applicable tubing O.D.	Part no.	Applicable tubing O.D.	Weight (g)	Part no.	Applicable tubing O.D.
N-04	$\phi 4$	5	L-04	$\phi 4$	S-04	$\phi 4$	0.7	LL-04	$\phi 4$
N-06	$\phi 6$	7	L-06	$\phi 6$	S-06	$\phi 6$	1.1	LL-06	$\phi 6$
N-08	$\phi 8$	8	L-08	$\phi 8$	S-08	$\phi 8$	1.4	LL-08	$\phi 8$
N-10	$\phi 10$	13	L-10	$\phi 10$	S-10	$\phi 10$	1.7	LL-10	$\phi 10$
N-12	$\phi 12$	14	L-12	$\phi 12$	S-12	$\phi 12$	2.0	LL-12	$\phi 12$

## ⚠ Precautions

Be sure to read this before handling the products.  
 Refer to back page 50 for Safety Instructions and pages 13 to 17 for Fittings and Tubing Precautions.

## Installation

### ⚠ Caution

1. Cut the tube perpendicular to the tube axis a little longer than the required length. (Use tube cutter TK-1, 2 or 3.)
2. Then, push the cut tube in until it comes to the flared edge, and tighten the nut by hand.
3. Furthermore, give the nut an additional 1.5 turns with a tightening tool. Leave no space between the screwed-in nut and the tube in-line with the tube axis. If tightened insufficiently, nut may be loosened and it may result in air leakage or may come off.
4. When using soft copper tube, first tighten the nut by hand and then give it an additional one turn with wrench. Use JIS H3300, equivalent to seamless tube C1220T-0, as soft copper tube. If using any other type, it may cause the air leakage or tube to come off.