





The models IDF1E to 11E and IDU3E to 6E have been revised. For details, refer to catalog no. ES30-8A. Similar updating for other IDF/IDU models is scheduled to follow shortly.

Accessories (Option)

Description	Features	Specifications	Applicable dryer	Dimensions
Transformer separately installed 	This is for power supply and voltage other than standard.	Max. ambient temperature 40°C (Relative humidity 85% or less)	All models	14-17-30
Base integrated with transformer 	This is the base for integrating the transformer and air dryer.	—	IDU3D to 15C IDF4D to 75C	14-17-30
Dust proof filter set 	Avoids decreasing of air dryer performance even in dusty atmosphere.	Max. ambient temperature 40°C	IDU3D to 75C IDF1D to 75C	14-17-30
Bypass piping set 	Easy bypass piping (connect this set to the air dryer), realizing substantial reduction of man-hours at the site.	Max. operating pressure 1.0MPa Max. operating temperature 60°C	IDU3D to 75C IDF1D to 75C	14-17-31

How to Order

Transformer separately installed

IDF — TR **1500** — **5**

Volume

Symbol	Volume	Applicable dryer
500	500 VA	IDU3D-1 to 11C-1, IDF1D-1 to 11C-1
1000	1 kVA	IDU15C-1, IDF15C-1
1500	1.5 kVA	IDU22C1-3, 37C1-3, IDF22C1-3, 37C1-3
4000	4 kVA	IDU55C-3, 75C-3, IDF55C-3, 75C-3
7000	7 kVA	IDF120D
9000	9 kVA	IDF150D
11000	11 kVA	IDF190D
13000	13 kVA	IDF240D
18000	18 kVA	IDF370B

Supply voltage

Symbol	Primary voltage	Secondary voltage	Model
1	110VAC (50Hz), 110 to 120VAC (60Hz)	100VAC (50Hz) 100 to 110VAC (60Hz)	Single phase Compound
2	200, 220, 230, 240VAC (50Hz), 200 to 260VAC (60Hz)		
3	380, 400, 415VAC (50Hz), 380 to 420VAC (60Hz)		
4	420, 440, 480VAC (50Hz), 420 to 520VAC (60Hz)		
5	220VAC (50Hz), 220 to 240VAC (60Hz)	200VAC (50Hz) 200 to 220VAC (60Hz)	Three phase Single turn
6	380, 400, 415VAC (50Hz), 380 to 440VAC (60Hz)		
7	440, 460VAC (50Hz), 440 to 500VAC (60Hz)		
8	220, 240, 380, 400, 415, 440VAC (50/60Hz)	200VAC (50/60Hz)	Three phase Compound

Refer to page 14-17-29 for dimensions.

Base integrated with transformer

IDF — TB **2**

Size order

Symbol	Applicable dryer
1	IDU3D, IDF4D
2	IDU4D to 15C, IDF6D to 15C
3	IDF22C1
4	IDF37C1 to 75C

Not available for IDF1D to 3D, IDF22C to 75C. Refer to page 14-17-30 for dimensions.

Dust proof filter set

IDU — FL **22** C

Applicable dryer

Symbol	Dryer	Symbol	Dryer	Symbol	Dryer
3	IDU3D	6	IDU6D	22	IDU22C1
4	IDU4D	8	IDU8D	37	IDU37C1
		11	IDU11C	55	IDU55C
		15	IDU15C	75	IDU75C

IDF — FL **22** C

Applicable dryer

Symbol	Dryer	Symbol	Dryer	Symbol	Dryer
1	IDF1D	6	IDF6D	22	IDF22C1
2	IDF2D	8	IDF8D	37	IDF37C1
3	IDF3D	11	IDF11C	55	IDF55C
4	IDF4D	15	IDF15C	75	IDF75C

IDF — FL **120** D

Applicable dryer

Symbol	Dryer
120	IDF120D
150	IDF150D
190	IDF190D
240	IDF240D

Bypass piping set

IDU — BP **22** C

Applicable dryer

Symbol	Dryer	Symbol	Dryer	Symbol	Dryer
3	IDU3D	6	IDU6D	22	IDU22C1
4	IDU4D	8	IDU8D	37	IDU37C1
		11	IDU11C	55	IDU55C
		15	IDU15C	75	IDU75C

IDF — BP **22** C

Applicable dryer

Symbol	Dryer	Symbol	Dryer	Symbol	Dryer
1	IDF1D	6	IDF6D	22	IDF22C1
2	IDF2D	8	IDF8D	37	IDF37C1
3	IDF3D	11	IDF11C	55	IDF55C
4	IDF4D	15	IDF15C	75	IDF75C

Cannot be mounted on models with option "A" (IDF6D to 75C). Available as Special Order Product.

Accessories (Options)

The models IDF1E to 11E and IDU3E to 6E have been revised. For details, refer to catalog no. ES30-8A. Similar updating for other IDF/IDU models is scheduled to follow shortly.

Base Integrated with Transformer

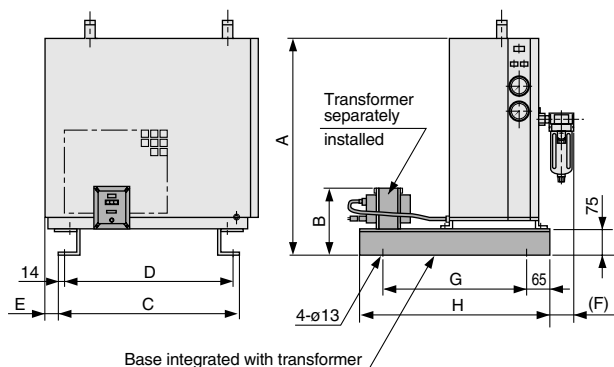

Part No.	Dryer	Transformer	A	B	C	D	E	F	G	H	Weight (kg)	
IDF-TB3	IDF22C1	IDF-TR1500-5		327							83	
		IDF-TR1500-6	755	379	628	600					92	
		IDF-TR1500-7										95
IDF-TB4	IDF37C1	IDF-TR1500-5	805	327	708	680					104	
		IDF-TR1500-6		379			51	69	675	805	142	
		IDF-TR1500-7										163
	IDF55C	IDF-TR4000-5	925	379	728	700						170
		IDF-TR4000-6		419								154
		IDF-TR4000-7										175
IDF75C	IDF-TR4000-5	975	379	728	700						182	
	IDF-TR4000-6		419									

Part No.	Dryer	Transformer	A	B	C	D	E	F	G	H	Weight (kg)	
IDF-TB1	IDF4D-1	IDF-TR500-1		171							33	
		IDF-TR500-2	681	217	356	328					37	
		IDF-TR500-3.4		284			53				46	
	IDU3D-1	IDF-TR500-1		171								30
		IDF-TR500-2	584	217	376	348						34
		IDF-TR500-3.4		284								43
IDF-TB2	IDF6D-1	IDF-TR500-1		171							39	
		IDF-TR500-2	595	217	470	442					44	
		IDF-TR500-3.4		284							53	
	IDF8D-1	IDF-TR500-1		171								39
		IDF-TR500-2	595	217	470	442						44
		IDF-TR500-3.4		284			55	69			53	
	IDF11C-1	IDF-TR500-1		171								54
		IDF-TR500-2	645	217	490	462						59
	IDF15C-1	IDF-TR500-3.4		284								68
		IDF-TR1000-1		199								60
	IDF15C-1	IDF-TR1000-2	695	217	490	462				427	557	66
		IDF-TR1000-3.4		284								78
	IDU4D-1	IDF-TR500-1		171								38
		IDF-TR500-2	681	217	466	438	53					43
		IDF-TR500-3.4		284								52
	IDU6D-1	IDF-TR500-1		171								50
		IDF-TR500-2	785	217	470	442						55
	IDU8D-1	IDF-TR500-3.4		284								64
IDF-TR500-1			171								54	
IDU11C-1	IDF-TR500-2	885	217	470	442						59	
	IDF-TR500-3.4		284			55	69				68	
	IDF-TR500-1		171								66	
IDU15C-1	IDF-TR500-2	985	217	490	462						71	
	IDF-TR500-3.4		284								80	
	IDF-TR1000-1		199								76	
IDU15C-1	IDF-TR1000-2	1035	217	490	462						82	
	IDF-TR1000-3.4		284								94	

Note) Weight includes air dryer and transformer.
Not available for IDF1D to 3D, IDU22C to 75C.

Dust proof filter set

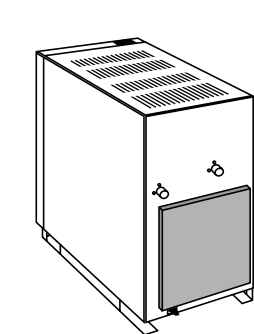

(IDF-FL1C, 2C, 3C, 4C,
IDU-FL3C, 4C)

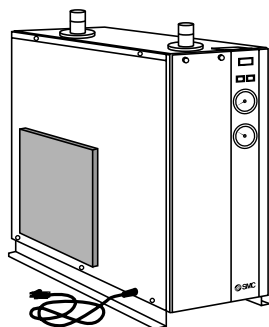

(IDF-FL6C, 8C, 11C, 15C)

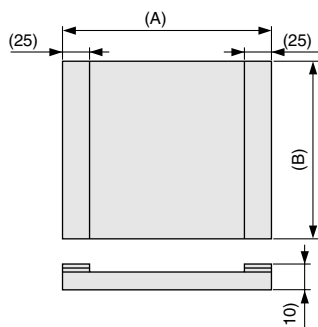

Part No.	Dryer	A	B
IDF-FL1C	IDF1D	180	145
IDF-FL2C	IDF2D	180	145
IDF-FL3C	IDF3D	225	180
IDF-FL4C	IDF4D	225	180
IDF-FL6C	IDF6D	345	270
IDF-FL8C	IDF8D	345	270
IDF-FL11C	IDF11C	365	270
IDF-FL15C	IDF15C	385	310
IDF-FL22C	IDF22C1	430	310
IDF-FL37C	IDF37C1	555	380
IDF-FL55C	IDF55C	600	410
IDF-FL75C	IDF75C	640	510
IDF-FL120D	IDF120D	360	420
		440	420
IDF-FL150D	IDF150D	360	420
		440	420
IDF-FL190D	IDF190D	250	480
		750	480
		440	670
IDF-FL240D	IDF240D	440	670
		600	670

Part No.	Dryer	A	B
IDU-FL3C	IDU3D	245	265
IDU-FL4C	IDU4D	240	300
IDU-FL6C	IDU6D	400	170
		345	270
IDU-FL8C	IDU8D	405	270
		345	
IDU-FL11C	IDU11C	395	310
		365	270
IDU-FL15C	IDU15C	395	310
		385	
IDU-FL22C	IDU22C1	480	430
		430	310
IDU-FL37C	IDU37C1	605	475
		555	345
IDU-FL55C	IDU55C	605	475
		600	410
IDU-FL75C	IDU75C	625	550
		640	510