

## 3-Screen Display

# High-Precision Digital Pressure Switch

For Air **1.0** MPa/ **1.6** MPa ISE70 ISE71

New



RoHS

IP67

## IO-Link

It is possible to change the settings while checking the measured value.

### Main screen

Measured value (Current pressure value)

### Sub screen

Label (Display item),  
Set value (Threshold value)

### Visualisation of Settings

Set value (Threshold value)	P.1
Hysteresis value	H.1
Peak value	H.H.1
Bottom value	H.Lo



## Angled display Good visibility from various mounting positions

Front



Top



Bottom



## Rotating display

Display rotates 336° after installation.



## 3 setting modes p. 2

- 3-step setting mode
- Simple setting mode
- Function selection (detailed setting) mode

# ISE70/71 Series



CAT.EUS100-123A-UK

## Visualisation of Settings

The sub screen (label) shows the item to be set.

**Current model**

**New ISE70/71**

### Mode Examples

**Hysteresis mode**

Normal output	Set value (Threshold value)	Reversed output	Set value (Threshold value)
P_1 0.500		n_1 0.500	
Hysteresis	Set hysteresis value		
H_1 0.050			

**Window comparator mode**

Normal output/ Lo side	Set value (Threshold value)	Normal output/ Hi side	Set value (Threshold value)
P_L 0.300		P_H 0.600	
Reversed output/ Lo side	Set value (Threshold value)	Reversed output/ Hi side	Set value (Threshold value)
n_L 0.300		n_H 0.600	

## Simple 3-Step Setting

When the SET button is pressed and the set value (P\_1) is being displayed, the set value (threshold value) can be set. When the SET button is pressed and the hysteresis (H\_1) is being displayed, the hysteresis value can be set.

1. Push SET button.
2. Use the UP or DOWN button to adjust to the set value.
3. Push SET button. Setting complete.

### With a snap shot function for set value reading

Pressing the UP and DOWN buttons simultaneously for a minimum of 1 second will make the set value (threshold value) the same as the current pressure value.

**Snap shot function**

Pressing the UP and DOWN buttons simultaneously for a minimum of 1 second will make the set value (threshold value) the same as the current pressure value.

Setting start → Release the buttons after "..." is displayed on the right side sub screen. → Setting complete

## NPN/PNP Switch Function

Both NPN and PNP are available. The number of stock items can be reduced.

Select NPN or PNP

NPN PNP

## Other Sub Screen Display

The peak value or bottom value, or both values can be displayed on one screen!

\* Peak and bottom values are maintained even if the power supply is cut.

Peak value	Bottom value	Peak/Bottom value
H_H 0.589	H_L 0.35	0.589 0.35
Label (Peak) Peak value	Label (Bottom) Bottom value	Peak value Bottom value

Output mode/Output type display		Rated range display	Level bar display	Pressure unit display			
Hysteresis mode	Window comparator mode	Positive pressure range		kPa	MPa	psi*1	bar*1
Normal output	Reversed output			KPA	MPA	PSI	BAR

\*1 "psi" and "bar" can be selected when the units selection function is available.  
\* A combination of the displays shown above and the set values can be displayed on the 2 sub screens.

## Convenient Functions

### Security code

The key-lock function keeps unauthorized persons from tampering with the settings.

### Power saving mode

Power consumption is reduced by turning off the monitor. (Reduce power consumption by approx. 60 %.)

### Resolution switch function

Reduces monitor flickering.

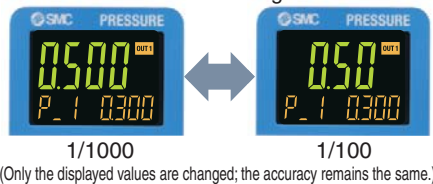

### Applied pressure error

When applied pressure exceeds the rated pressure, the pressure application is counted as an applied pressure error (the maximum number of applied pressure errors is 1000 counts)



The number of applied pressure errors



## 3 Setting Modes

Select the setting mode that best meets your needs.

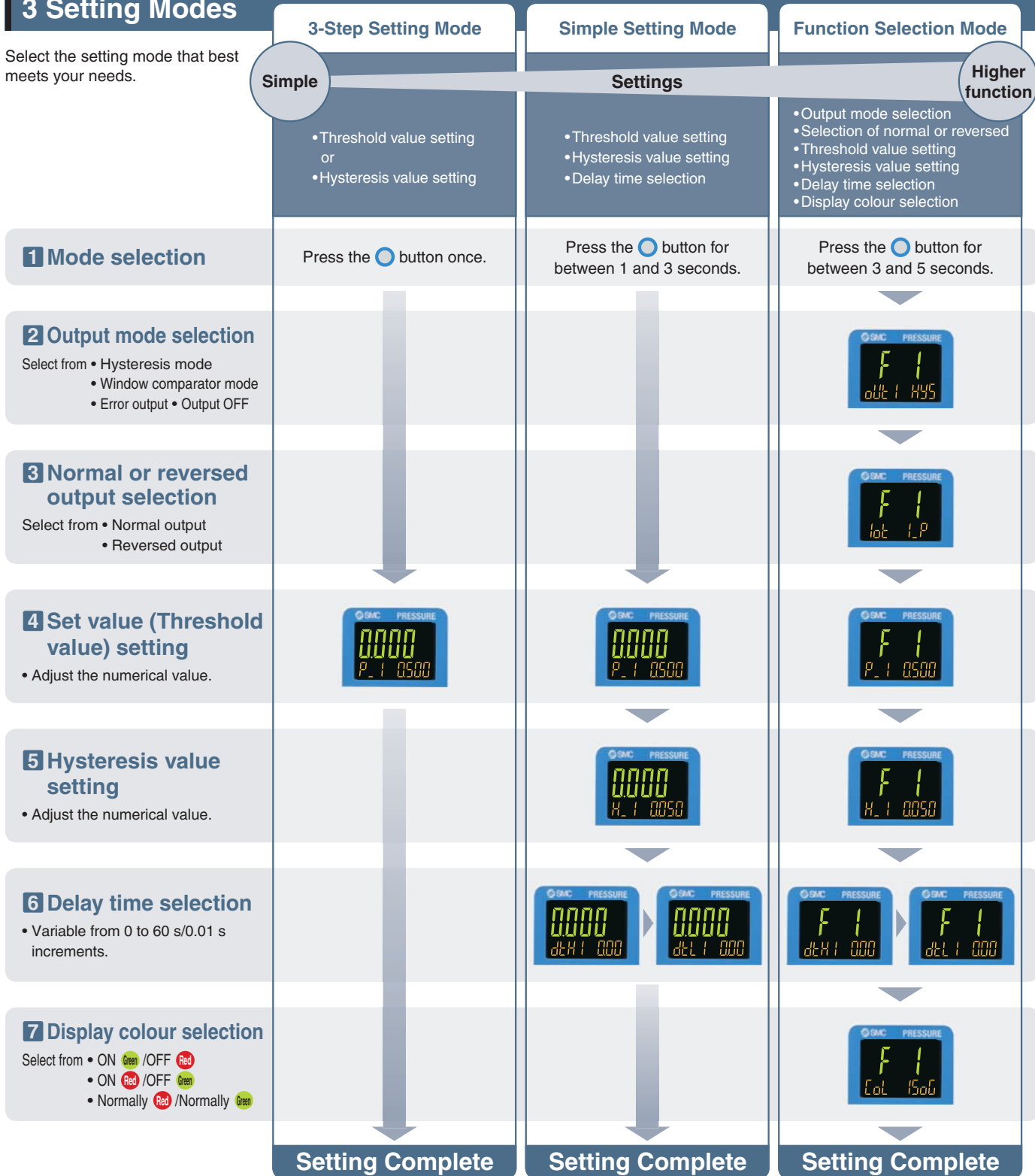

\* The chart above shows the OUT1 operation. The Function Selection Mode for OUT2 is set using "F2". "2" is displayed instead of "1" in the illustration above. (Example) P\_1 → P\_2

## IO-Link Compatible

Visualisation of operation/equipment status. Remote monitoring and control by communication

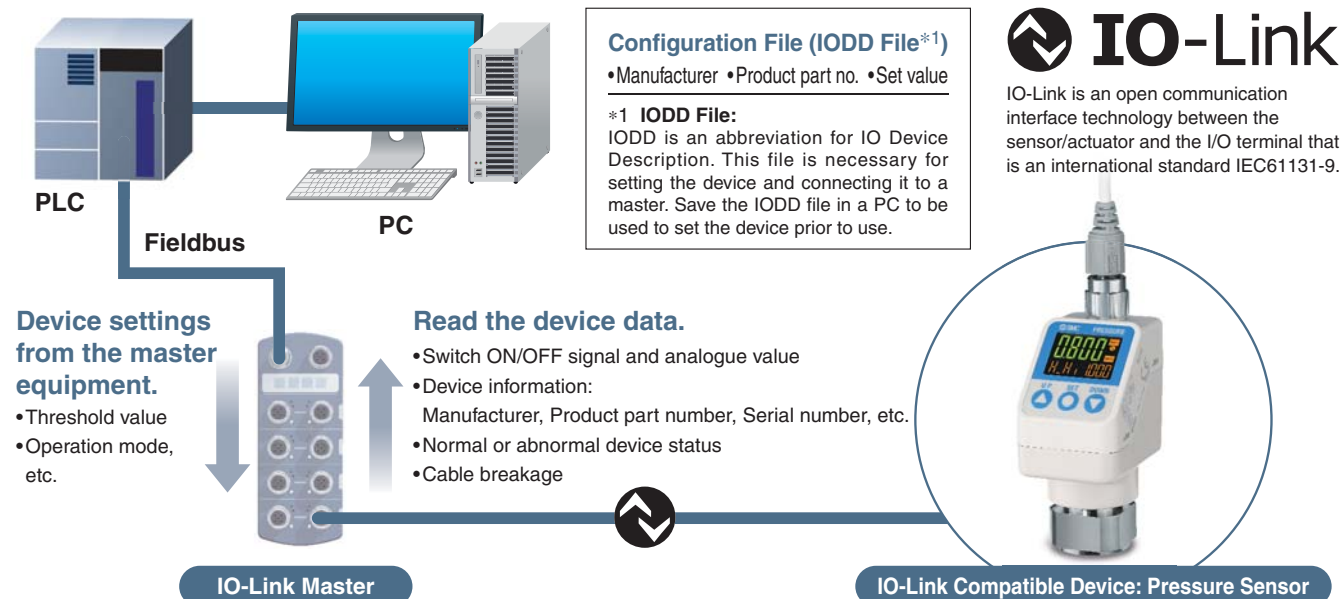

## Implement diagnostic bits in the process data

The diagnostic bit in the cyclic process data makes it easy to find problems with the equipment. It is possible to find problems with the equipment in real time using cyclic (cycle) data and to monitor problems in detail with noncyclic (aperiodic) data.

### Process Data

Bit offset	Item	Note
0	OUT1 output	0: OFF 1: ON
1	OUT2 output	0: OFF 1: ON
2	Diagnosis	0: Normal 1: Abnormal
3 to 15	Measured pressure value	Unsigned 13 bit

### Diagnosis items

- Internal product malfunction
- Outside of zero-clear range
- Outside of rated pressure range
- Upper temperature limit exceeded inside the product.

Bit offset	15	14	13	12	11	10	9	8	7	6	5	4	3	2	1	0
Item	Measured pressure value													Diagnosis	OUT2	OUT1

## Display function

Displays the output communication status and the presence of communication data.

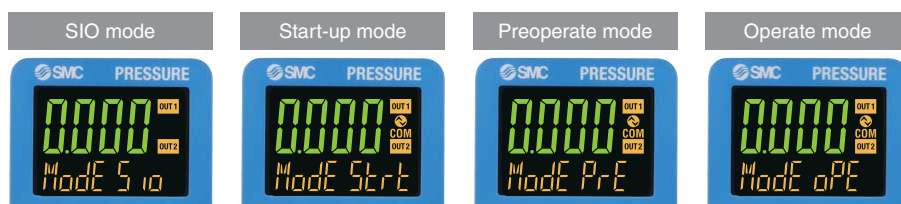

### Operation and Display

Communication with master	IO-Link status indicator light	Status	Screen display*3	Description	
Yes	COM*1	IO-Link mode	Operate	Mode OPE	Normal communication status (readout of measured value)  At the start of communication
			Start up	Mode Start	
			Preoperate	Mode Pre	
No	OFF	SIO mode	Version does not match	Er 15 1.10	IO-Link version does not match with master. Mismatch because master version is 1.0.  Back-up and re-store required due to data storage lock  Normal communication was not received for 1 second or longer.
			Lock	Mode Loc	
			Communication disconnection	Mode OPE Mode Start Mode Pre	
	OFF	SIO mode	Mode S IO	General switch output	

\*1 COM indicator is ON when communication with the master is established. \*2 In IO-Link mode, the IO-Link indicator is ON or flashes. \*3 When the sub screen is set to Mode.

# 3-Screen Display High-Precision Digital Pressure Switch: For Air

## ISE70/71 Series



### How to Order

For positive pressure

**ISE70** - **F02** - **L2** - **M** [ ] [ ]

#### Pressure range

Symbol	Description
<b>ISE70</b>	0 to 1 MPa
<b>ISE71</b>	0 to 1.6 MPa

#### Piping specification

Symbol	Description
<b>02</b>	Rc1/4
<b>N02</b>	NPT1/4
<b>F02</b>	G1/4*1

\*1 ISO1179-1 compliant

#### Output specification\*1

Symbol	Description
<b>L2</b>	IO-Link: Switch output 1 + Switch output 2 (Switch output: NPN or PNP switching type)

\*1 Refer to pages 5 and 6 for details.

#### Option 2

Symbol	Description
—	Operation manual
<b>Y</b>	None
<b>K</b>	Operation manual + Calibration certificate
<b>T</b>	Calibration certificate

#### Option 1

Symbol	Description
—	None
<b>S</b>	Lead wire with M12 connector (Straight, 5 m)
<b>L</b>	Lead wire with M12 connector (Right-angled, 5 m)

#### Unit specification

Symbol	Description
—	Units selection function
<b>M</b>	SI unit only*1

\*1 Fixed unit: MPa, kPa

For pressure switch precautions and specific product precautions, refer to the "Operation Manual" on the SMC website.

### Options/Part Nos.

When only optional parts are required, order with the part numbers listed below.

Description	Part no.	Note
Lead wire with M12 connector: Straight	<b>ZS-31-B</b>	Lead wire length: 5 m
Lead wire with M12 connector: Right-angled	<b>ZS-31-C</b>	Lead wire length: 5 m

# ISE70/71 Series

## Specifications

Model		ISE70	ISE71	
<b>Applicable fluid</b>		Air, Non-corrosive gas, Non-flammable gas		
<b>Pressure</b>	<b>Rated pressure range</b>	0 to 1.000 MPa	0 to 1.600 MPa	
	<b>Display/Set pressure range</b>	-0.105 to 1.050 MPa	-0.105 to 1.680 MPa	
	<b>Display/Smallest settable increment</b>	0.001 MPa	0.001 MPa	
	<b>Withstand pressure</b>	1.5 MPa	2.4 MPa	
<b>Power supply</b>	<b>Power supply voltage</b>	<b>When used as a switch output device</b>	12 to 24 VDC $\pm 10\%$ with 10 % voltage ripple or less	
		<b>When used as an IO-Link device</b>	18 to 30 VDC, including ripple (p-p) 10%	
	<b>Current consumption</b>	35 mA or less		
	<b>Protection</b>	Polarity protection		
<b>Accuracy</b>	<b>Display accuracy</b>	$\pm 2\%$ F.S. $\pm 1$ digit (Ambient temperature of 25 $\pm 3$ °C)		
	<b>Repeatability</b>	$\pm 0.5\%$ F.S.		
	<b>Temperature characteristics</b>	$\pm 2\%$ F.S. (25°C standard)		
<b>Switch output (SIO mode)</b>	<b>Output type</b>	Select from NPN or PNP open collector output.		
	<b>Output mode</b>	Hysteresis, Window comparator, Error output, Output OFF		
	<b>Switch operation</b>	Normal output, Reversed output		
	<b>Maximum load current</b>	80 mA		
	<b>Maximum applied voltage</b>	30 V (NPN output)		
	<b>Internal voltage drop (Residual voltage)</b>	1.5 V or less (at load current of 80 mA)		
	<b>Delay time*1</b>	1.5 ms or less, variable from 0 to 60 s/0.01 s increments		
	<b>Hysteresis</b>	<b>Hysteresis mode</b>	Variable from 0*2	
		<b>Window comparator mode</b>		
<b>Short circuit protection</b>	Yes			
<b>Display</b>	<b>Unit*3</b>	MPa, kPa, kgf/cm <sup>2</sup> , bar, psi		
	<b>Display type</b>	LCD		
	<b>Number of screens</b>	3-screen display (Main screen, Sub screen x 2)		
	<b>Display colour</b>	Main screen: Red/Green, Sub screen: Orange		
	<b>Number of display digits</b>	Main screen: 4 digits (7 segments), Sub screen: 4 digits (Upper 1 digit 11 segments, 7 segments for other)		
	<b>Indicator light</b>	Lights up when switch output is turned ON. OUT1, OUT2: Orange		
<b>Digital filter*4</b>	Variable from 0 to 30 s/0.01 s increments			
<b>Environment</b>	<b>Enclosure</b>	IP67		
	<b>Withstand voltage</b>	1000 VAC for 1 minute between terminals and housing		
	<b>Insulation resistance</b>	50 M $\Omega$ or more (500 VDC measured via megohmmeter) between terminals and housing		
	<b>Operating temperature range</b>	Operating: 0 to 50 °C, Stored: -10 to 60 °C (No condensation or freezing)		
	<b>Operating humidity range</b>	Operating/Stored: 35 to 85 % RH (No condensation)		
<b>Standards</b>	CE, RoHS			
<b>Piping</b>	<b>Port size</b>	Rc1/4, NPT1/4, G1/4		
	<b>Materials of parts in contact with fluid</b>	Sensor pressure receiving area: Silicon Piping port: C3604 (Electroless nickel plating), O-ring: HNBR		
<b>Weight</b>	<b>Body</b>	<b>Port size Rc1/4</b>	153 g	
		<b>Port size NPT1/4</b>	152 g	
		<b>Port size G1/4</b>	150 g	
	<b>Lead wire with connector</b>	139 g		
<b>Communication (IO-Link mode)</b>	<b>IO-Link type</b>	Device		
	<b>IO-Link version</b>	V1.1		
	<b>Communication speed</b>	COM2 (38.4 kbps)		
	<b>Configuration file</b>	IODD file*5		
	<b>Minimum cycle time</b>	2.3 ms		
	<b>Process data length</b>	Input data: 2 bytes, Output data: 0 byte		
	<b>On request data communication</b>	Yes		
	<b>Data storage function</b>	Yes		
	<b>Event function</b>	Yes		
<b>Vendor ID</b>	131 (0 x 0083)			

\*1 Value without digital filter (at 0 ms)

\*2 If the applied pressure fluctuates around the set value, the hysteresis must be set to a value more than the amount of fluctuation or chattering will occur.

\*3 Setting is only possible for models with the units selection function. Only MPa or kPa is available for models without this function.

\*4 The response time indicates when the set value is 90 % in relation to the step input.

\*5 The configuration file can be downloaded from the SMC website, <http://www.smcworld.com>

\* Products with tiny scratches, marks, or display colour or brightness variations which do not affect the performance of the product are verified as conforming products.

## Set Pressure Range and Rated Pressure Range

Set the pressure within the rated pressure range. The set pressure range is the range of pressure within which switch output can be set. The rated pressure range is the range of pressure that satisfies the specifications (accuracy, linearity, etc.) of the product. Although it is possible to set a value outside the rated pressure range, the specifications cannot be guaranteed even if the value stays within the set pressure range.

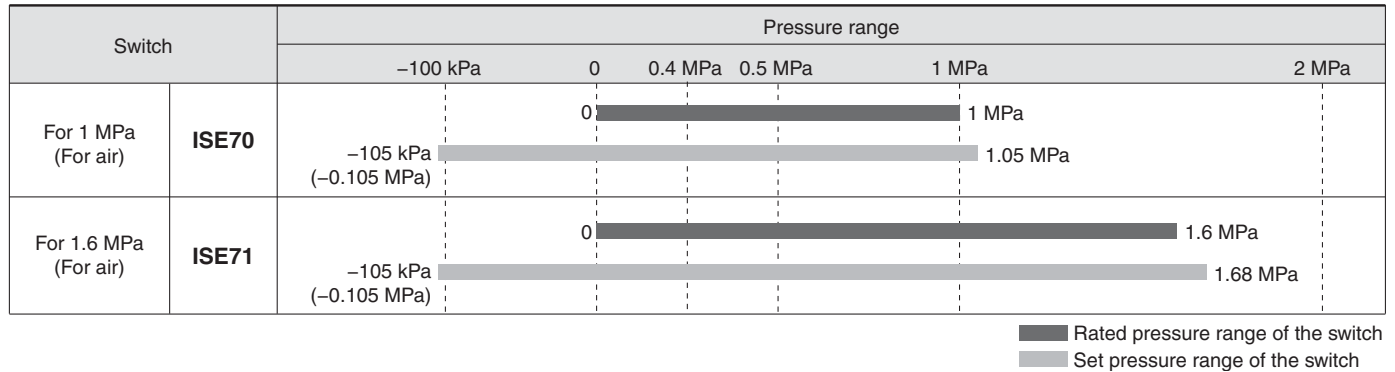

## Internal Circuits and Wiring Examples

### When used as a switch output device

#### Setting of NPN open collector 2 outputs

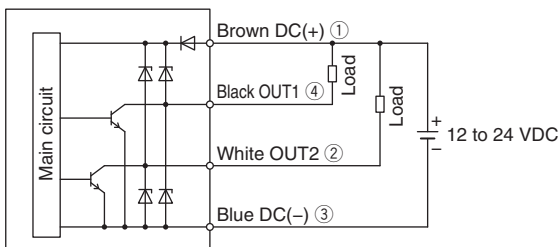

#### Setting of PNP open collector 2 outputs

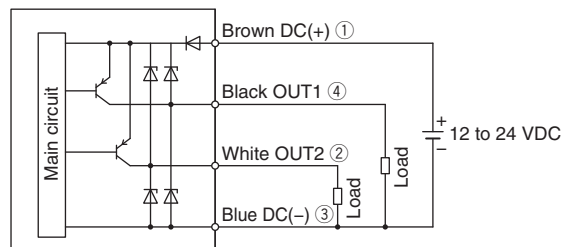

### When used as an IO-Link device

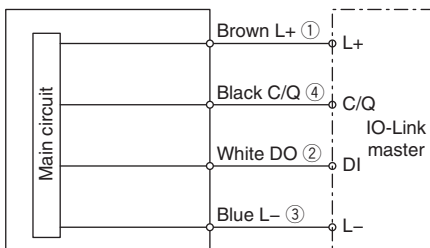

\* The numbers in the circuit diagrams show the connector pin layout.

# ISE70/71 Series

## Dimensions

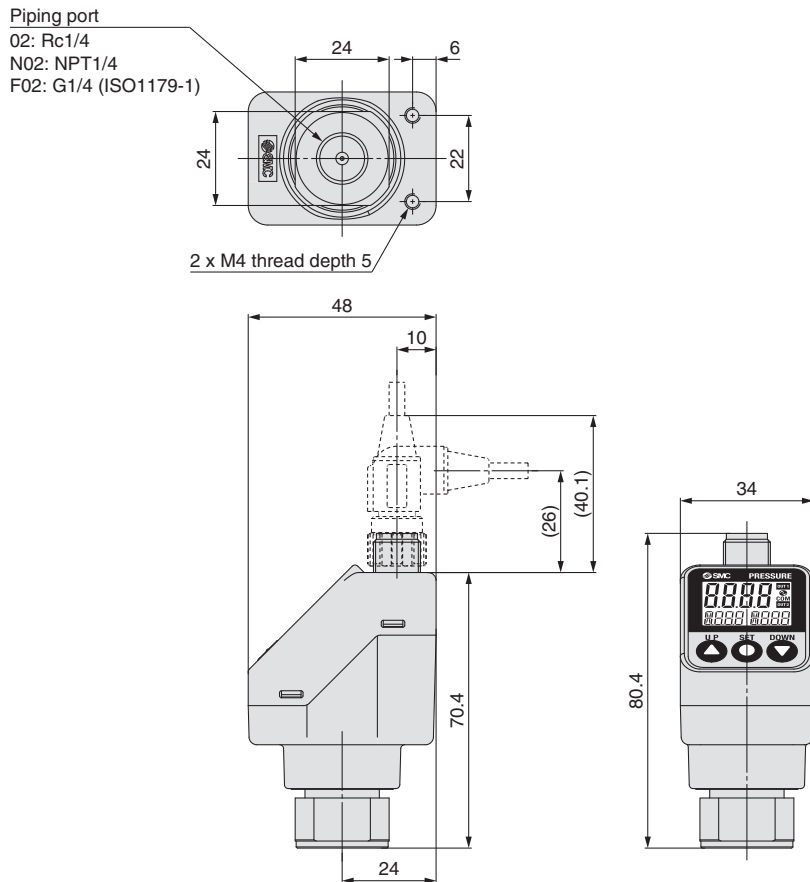

### Lead wire with M12 connector (Part no.: ZS-31-B)

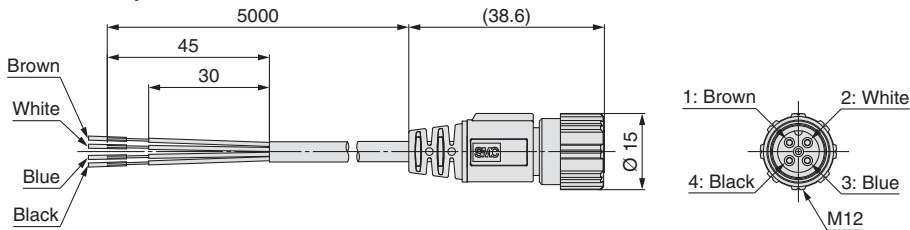

### (Part no.: ZS-31-C)

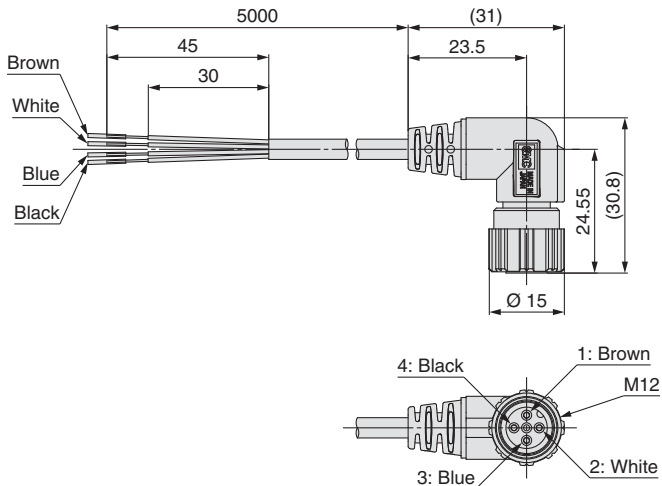

When used as a switch output device

No.	Description	Lead wire colour	Note
1	DC(+)	Brown	12 to 24 VDC
2	OUT2	White	Switch output 2
3	DC(-)	Blue	0 V
4	OUT1	Black	Switch output 1

When used as an IO-Link device

No.	Description	Lead wire colour	Note
1	L+	Brown	18 to 30 VDC
2	DO	White	Switch output 2
3	L-	Blue	0 V
4	C/Q	Black	Communication data (IO-Link)/ Switch output 1 (SIO)



# ISE70/71 Series

## Function Details

Display examples of the main and sub (set value) screens of each mode. (For ISE70/71 (for Positive pressure))

### Hysteresis mode Normal output

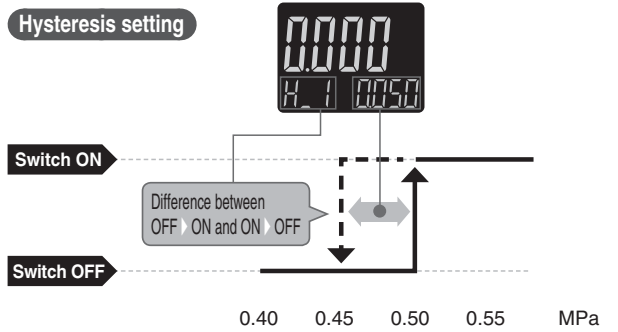
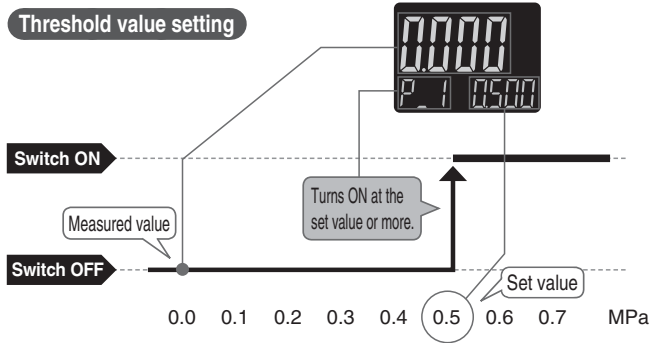

### Hysteresis mode Reversed output

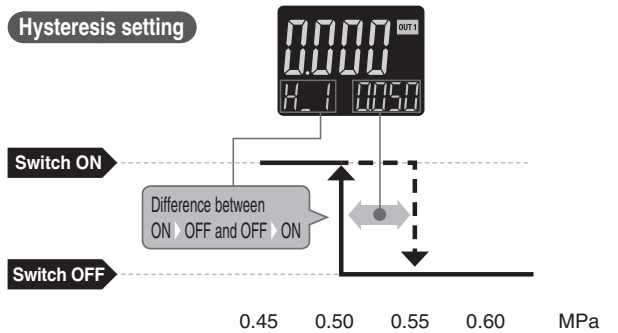
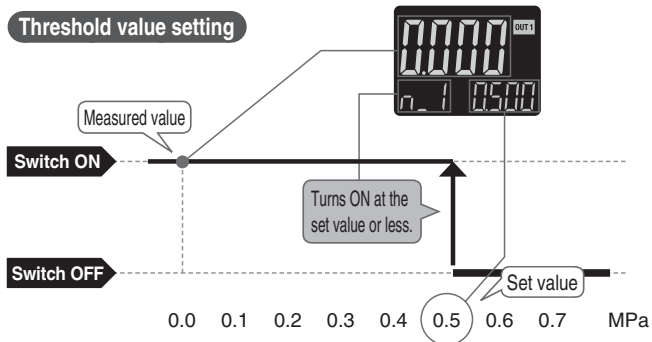

### Window comparator mode Normal output

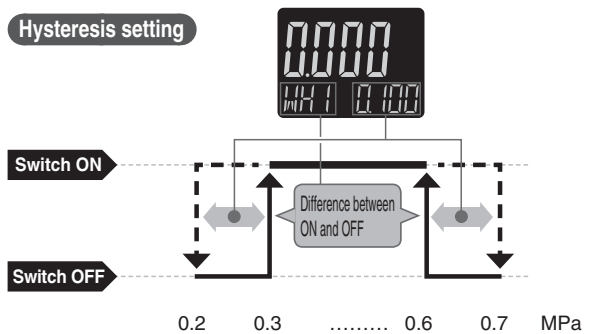
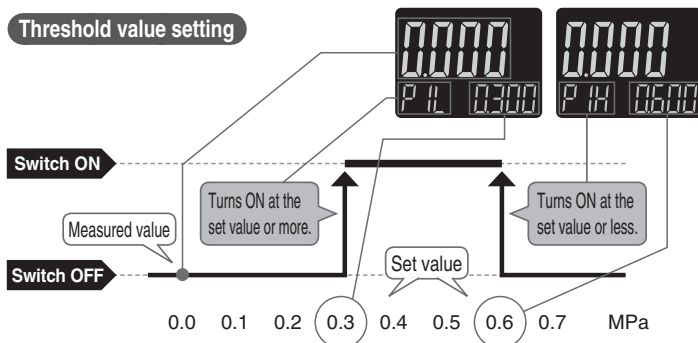

### Window comparator mode Reversed output

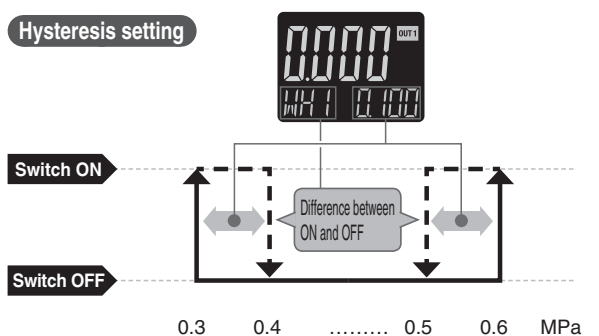
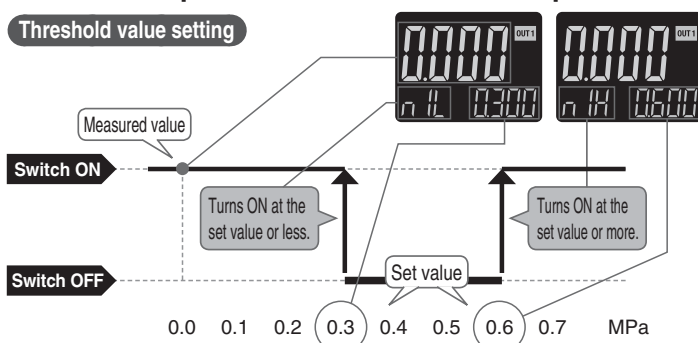

## Function Details

### A Auto-preset function (F4)

Auto-preset function, when selected in the initial setting, calculates and stores the set value from the measured pressure.

Using this function is possible to automatically determine the optimum set value based on the variation in measured pressure due to the repeated operation of the device.

#### Formula for Obtaining the Set Value

Set value (Threshold value)	Hysteresis value
$P_{-1}(P_{-2}) = A - (A-B)/4$	$H_{-1}(H_{-2}) =  (A-B)/2 $
$n_{-1}(n_{-2}) = B + (A-B)/4$	

A: Maximum pressure value in auto preset mode

B: Minimum pressure value in auto preset mode

\* When using with IO-Link, the set values cannot be changed by communication.

### B Display value fine adjustment function (F6)

Fine adjustment of the indicated value of the pressure sensor can be made within the range of  $\pm 5\%$  of the read value. (The scattering of the indicated value can be eliminated.)

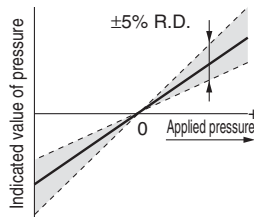

— Indicated value at a time of shipment  
 - - - Adjustable range of display value fine adjustment function

\* When the display value fine adjustment function is used, the set pressure value may change  $\pm 1$  digit.

### C Peak/Bottom value indication function

This function constantly detects and updates the maximum (minimum) pressure when the power is supplied, and allows to hold the maximum (minimum) pressure value.

The held value is maintained even if the power supply is cut. When the SET and DOWN buttons are simultaneously pressed for 1 second or longer, while “holding”, the held value will be reset.

### D Keylock function

Prevents operation errors such as accidentally changing setting values.

### E Zero-clear function

This function clears and resets the zero value on the display of measured pressure.

The indicated value can be adjusted within  $\pm 7\%$  F.S. of the pressure at a time of shipment from the factory.

### F Error display function

This function is to display error location and content when a problem or error has occurred.

Error name	Display	Description	Action
Over current error		The load current applied to the switch output has exceeded the maximum value.	Eliminate the cause of the over current by turning off the power supply and then turn it on again.
Residual pressure error		During zero-clear operation, pressure over $\pm 7\%$ F.S. is present. Note that the mode is returned to measurement mode automatically 1 second later. The zero clear range varies by $\pm 1\%$ F.S. due to variation between individual products.	Perform zero-clear operation again after restoring the applied pressure to an atmospheric pressure condition.
Applied pressure error		Supply pressure exceeds the maximum set pressure.	Reset applied pressure to a level within the set pressure range.
		Supply pressure is below the minimum set pressure.	
System error		Internal data error	Turn the power off and then on again. If the error cannot be solved, please contact SMC for investigation.
IO-Link master version error		IO-Link master and product version are not matched.	Align the master IO-Link version to the device.

If the error cannot be solved after the instructions above are performed, or errors other than above are displayed, please contact SMC for investigation.

## Function Details

### **G** Anti-chattering function (Simple setting mode or F1, F2)

A function to delay the switch output response time to prevent chattering or prevent the detection of temporary changes in source pressure. For example, large bore cylinders and ejectors consume a large volume of air in operation, therefore, the source pressure may decrease temporarily. The delay time can be set in the range of 0.00 to 60.00 [sec.] in 0.01 [sec.] increments.

<Principle>

This function averages pressure values measured during the response time set by the user and then compares the average pressure value with the pressure set point value to output the result on the switch.

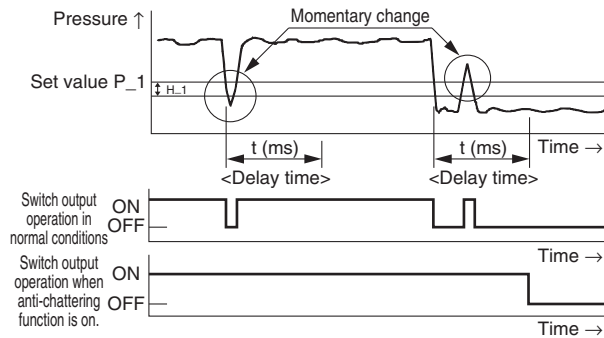

### **H** Units selection function (F0)

Display units can be switched with this function.

Model	Rated pressure range	Smallest settable increment				
		MPa	kPa	kgf/cm <sup>2</sup>	bar	psi
<b>ISE70</b>	0 to 1 MPa	0.001	1	0.01	0.01	0.1
<b>ISE71</b>	0 to 1.6 MPa					

### **I** Zero cut-off setting (F14)

When the pressure display value is close to zero, this function forces the display to zero. The range to display zero can be changed within the range of 0.0 to 10.0%.

Example: When the ISE70 (1 MPa range), zero-cut value = 1.0%, 0 is displayed in the range of -9 to 9 kPa.

### **J** Power saving mode (F80)

Power saving mode can be selected.

It shifts to the power saving mode without button operation for 30 seconds.

It is set to the normal mode (Power saving mode is OFF.) at a time of shipment from the factory.

(During power saving mode, [ECo] will flash in the sub screen and the operation light is ON (only when the switch is ON).)



### **K** Setting of security code (F81)

Users can select whether a security code must be entered to release key lock.

At a time of shipment from the factory, it is set such that the security code is not required.

## Safety Instructions

These safety instructions are intended to prevent hazardous situations and/or equipment damage. These instructions indicate the level of potential hazard with the labels of “Caution,” “Warning” or “Danger.” They are all important notes for safety and must be followed in addition to International Standards (ISO/IEC)\*1), and other safety regulations.

-  **Caution:** Caution indicates a hazard with a low level of risk which, if not avoided, could result in minor or moderate injury.
-  **Warning:** Warning indicates a hazard with a medium level of risk which, if not avoided, could result in death or serious injury.
-  **Danger:** Danger indicates a hazard with a high level of risk which, if not avoided, will result in death or serious injury.

- \*1) ISO 4414: Pneumatic fluid power – General rules relating to systems.
- ISO 4413: Hydraulic fluid power – General rules relating to systems.
- IEC 60204-1: Safety of machinery – Electrical equipment of machines. (Part 1: General requirements)
- ISO 10218-1: Manipulating industrial robots - Safety. etc.

### Warning

- 1. The compatibility of the product is the responsibility of the person who designs the equipment or decides its specifications.**  
Since the product specified here is used under various operating conditions, its compatibility with specific equipment must be decided by the person who designs the equipment or decides its specifications based on necessary analysis and test results. The expected performance and safety assurance of the equipment will be the responsibility of the person who has determined its compatibility with the product. This person should also continuously review all specifications of the product referring to its latest catalogue information, with a view to giving due consideration to any possibility of equipment failure when configuring the equipment.
- 2. Only personnel with appropriate training should operate machinery and equipment.**  
The product specified here may become unsafe if handled incorrectly. The assembly, operation and maintenance of machines or equipment including our products must be performed by an operator who is appropriately trained and experienced.
- 3. Do not service or attempt to remove product and machinery/equipment until safety is confirmed.**
  1. The inspection and maintenance of machinery/equipment should only be performed after measures to prevent falling or runaway of the driven objects have been confirmed.
  2. When the product is to be removed, confirm that the safety measures as mentioned above are implemented and the power from any appropriate source is cut, and read and understand the specific product precautions of all relevant products carefully.
  3. Before machinery/equipment is restarted, take measures to prevent unexpected operation and malfunction.
- 4. Contact SMC beforehand and take special consideration of safety measures if the product is to be used in any of the following conditions.**
  1. Conditions and environments outside of the given specifications, or use outdoors or in a place exposed to direct sunlight.
  2. Installation on equipment in conjunction with atomic energy, railways, air navigation, space, shipping, vehicles, military, medical treatment, combustion and recreation, or equipment in contact with food and beverages, emergency stop circuits, clutch and brake circuits in press applications, safety equipment or other applications unsuitable for the standard specifications described in the product catalogue.
  3. An application which could have negative effects on people, property, or animals requiring special safety analysis.
  4. Use in an interlock circuit, which requires the provision of double interlock for possible failure by using a mechanical protective function, and periodical checks to confirm proper operation.

## Limited warranty and Disclaimer/ Compliance Requirements

The product used is subject to the following “Limited warranty and Disclaimer” and “Compliance Requirements”. Read and accept them before using the product.

### Limited warranty and Disclaimer

1. The warranty period of the product is 1 year in service or 1.5 years after the product is delivered, whichever is first.\*2) Also, the product may have specified durability, running distance or replacement parts. Please consult your nearest sales branch.
2. For any failure or damage reported within the warranty period which is clearly our responsibility, a replacement product or necessary parts will be provided. This limited warranty applies only to our product independently, and not to any other damage incurred due to the failure of the product.
3. Prior to using SMC products, please read and understand the warranty terms and disclaimers noted in the specified catalogue for the particular products.

\*2) Vacuum pads are excluded from this 1 year warranty. A vacuum pad is a consumable part, so it is warranted for a year after it is delivered. Also, even within the warranty period, the wear of a product due to the use of the vacuum pad or failure due to the deterioration of rubber material are not covered by the limited warranty.

### Compliance Requirements

1. The use of SMC products with production equipment for the manufacture of weapons of mass destruction (WMD) or any other weapon is strictly prohibited.
2. The exports of SMC products or technology from one country to another are governed by the relevant security laws and regulations of the countries involved in the transaction. Prior to the shipment of a SMC product to another country, assure that all local rules governing that export are known and followed.

### Caution

- 1. The product is provided for use in manufacturing industries.**  
The product herein described is basically provided for peaceful use in manufacturing industries.  
If considering using the product in other industries, consult SMC beforehand and exchange specifications or a contract if necessary.  
If anything is unclear, contact your nearest sales branch.

### Caution

- SMC products are not intended for use as instruments for legal metrology.**  
Measurement instruments that SMC manufactures or sells have not been qualified by type approval tests relevant to the metrology (measurement) laws of each country. Therefore, SMC products cannot be used for business or certification ordained by the metrology (measurement) laws of each country.

## Safety Instructions

Be sure to read “Handling Precautions for SMC Products” (M-E03-3) before using.

### SMC Corporation (Europe)

Austria	☎ +43 (0)2262622800	www.smc.at	office@smc.at	Lithuania	☎ +370 5 2308118	www.smclt.lt	info@smclt.lt
Belgium	☎ +32 (0)33551464	www.smcpnematics.be	info@smcpneumatics.be	Netherlands	☎ +31 (0)205318888	www.smcpnematics.nl	info@smcpneumatics.nl
Bulgaria	☎ +359 (0)2807670	www.smc.bg	office@smc.bg	Norway	☎ +47 67129020	www.smc-norge.no	office@smc-norge.no
Croatia	☎ +385 (0)13707288	www.smc.hr	office@smc.hr	Poland	☎ +48 222119600	www.smc.pl	office@smc.pl
Czech Republic	☎ +420 541424611	www.smc.cz	office@smc.cz	Portugal	☎ +351 226166570	www.smc.eu	postpt@smc.smces.es
Denmark	☎ +45 70252900	www.smcdk.com	smc@smcdk.com	Romania	☎ +40 213205111	www.smcromania.ro	smcromania@smcromania.ro
Estonia	☎ +372 6510370	www.smcpnematics.ee	smc@smcpneumatics.ee	Russia	☎ +7 8127185445	www.smc-pneumatik.ru	info@smc-pneumatik.ru
Finland	☎ +358 207513513	www.smc.fi	smc@smc.fi	Slovakia	☎ +421 (0)413213212	www.smc.sk	office@smc.sk
France	☎ +33 (0)164761000	www.smc-france.fr	info@smc-france.fr	Slovenia	☎ +386 (0)73885412	www.smc.si	office@smc.si
Germany	☎ +49 (0)61034020	www.smc.de	info@smc.de	Spain	☎ +34 902184100	www.smc.eu	post@smc.smces.es
Greece	☎ +30 210 2717265	www.smchellas.gr	sales@smchellas.gr	Sweden	☎ +46 (0)86031200	www.smc.nu	post@smc.nu
Hungary	☎ +36 23513000	www.smc.hu	office@smc.hu	Switzerland	☎ +41 (0)523963131	www.smc.ch	info@smc.ch
Ireland	☎ +353 (0)14039000	www.smcpnematics.ie	sales@smcpneumatics.ie	Turkey	☎ +90 212 489 0 440	www.smcpnomatik.com.tr	info@smcpnomatik.com.tr
Italy	☎ +39 0292711	www.smcitalia.it	mailbox@smcitalia.it	UK	☎ +44 (0)845 121 522	www.smcpnematics.co.uk	sales@smcpneumatics.co.uk
Latvia	☎ +371 67817700	www.smc.lv	info@smclv.lv				

SMC CORPORATION Akihbara UDX 15F, 4-14-1, Sotokanda, Chiyoda-ku, Tokyo 101-0021, JAPAN Phone: 03-5207-8249 FAX: 03-5298-5362