

Blow Nozzles

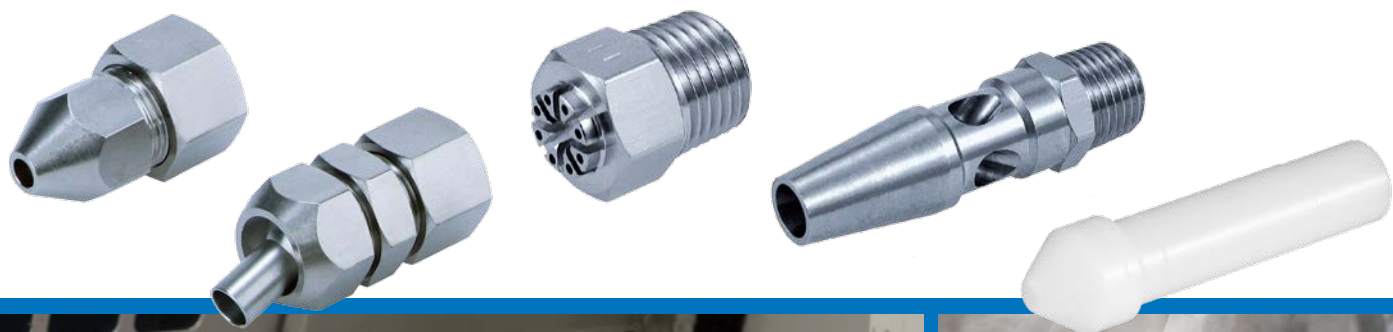

CONTENTS

Nozzle Selection Chart	p. 1
Nozzle Variations	p. 3
Applications	p. 6
Jet Shape and Impact Pressure Distribution Diagram	p. 7
Nozzles for Blowing KN Series	p. 9
Made to Order	p. 13
Related Products Vacuum Flow ZH-X226/X338/X249	p. 16

Equipment for Blowing	p. 20
Technical Data: Comparison Table (Thrust, Noise, Flow consumption, Air flow)	p. 22
Energy Saving Program	p. 23
Model Selection: Recommended Circuit Configuration for Blowing ...	p. 24
Glossary of Terms	p. 26
Safety Instructions	Back cover

What is the purpose of blowing?

Removal of foreign matter

Yes

Foreign matter type

1 Small foreign matter
(Dust, Cutting chips, etc.)

Removal of foreign matter across a wide area

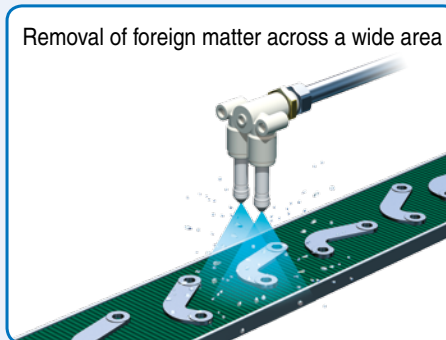

p. 4
Twin Nozzle
KQ2LU, KQ2U
+ KN-Q□A

2 Machining chips, oil, etc. after cutting



Fine adjustment of blowing direction and nozzle position

p. 11
Pivoting Nozzle
KNK Series

p. 14
Flexible Nozzle

KN-X1567

3 Water droplets, etc. after cleaning



p. 4
Bar Type

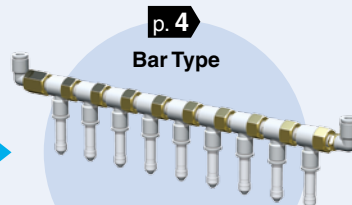

KQ2VF + KN-Q□A

No

No

Yes

Caution

The applications described here are for reference only. For actual usage in various other applications, please conduct thorough evaluation and validation testing in order to determine the feasibility under your actual usage conditions.

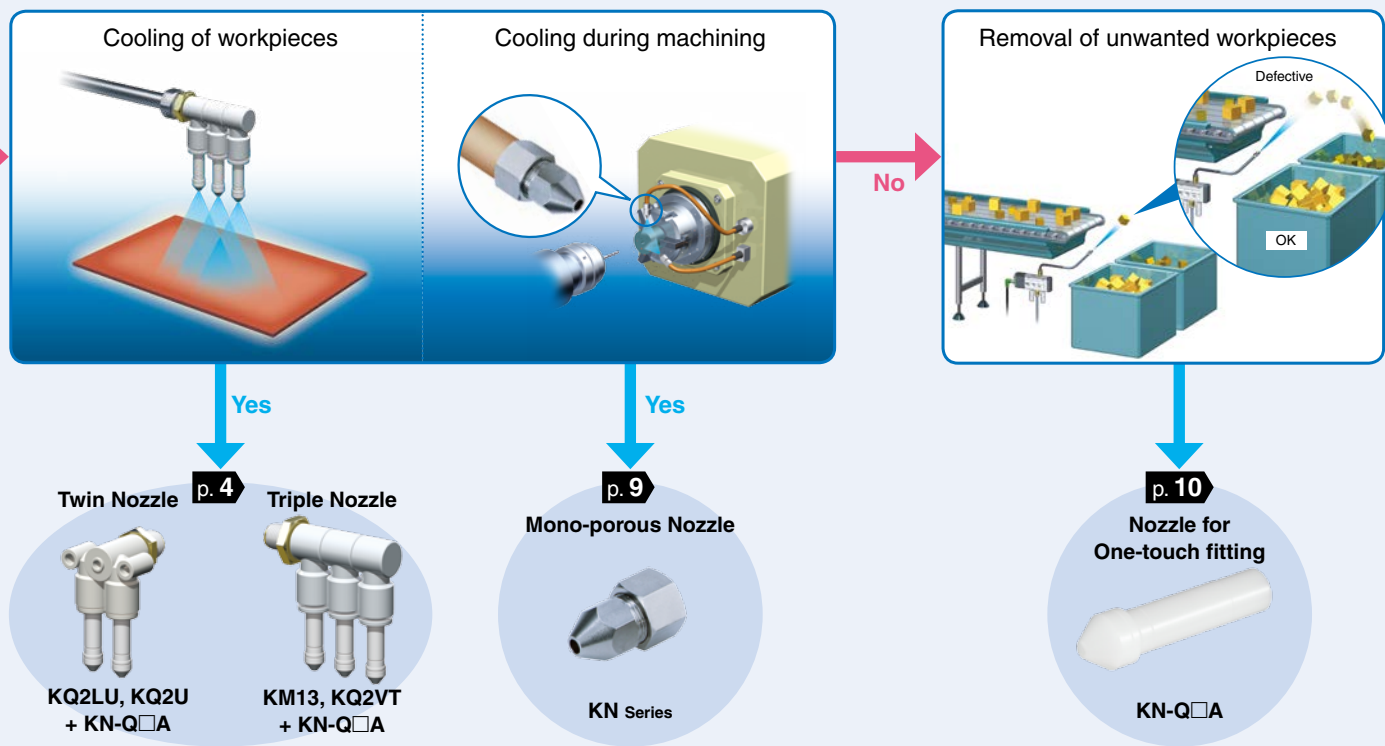

Others

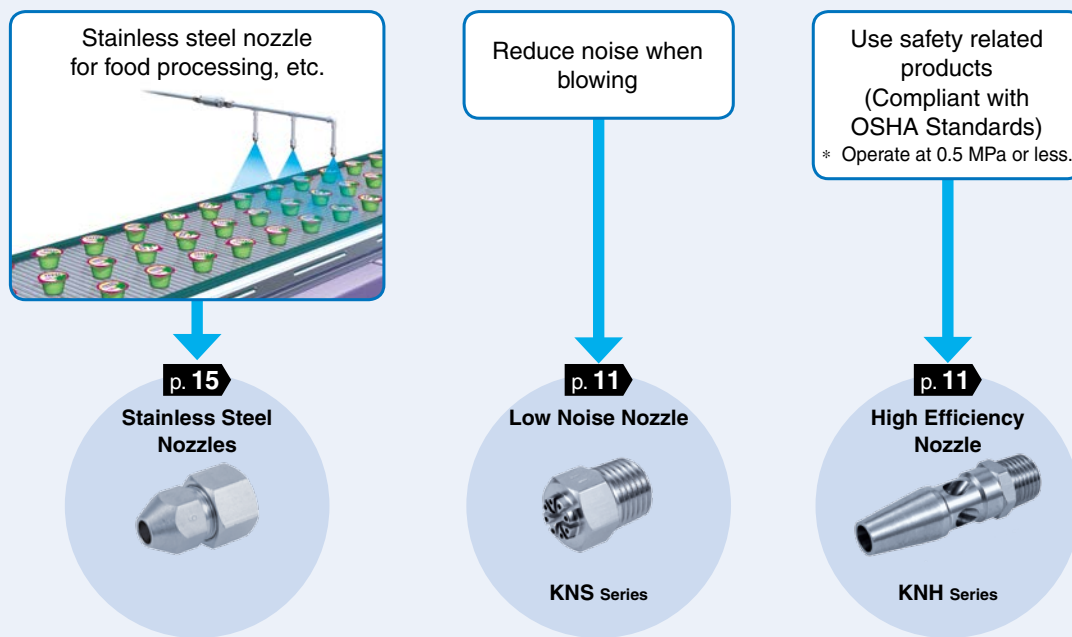

Caution The applications described here are for reference only. For actual usage in various other applications, please conduct thorough evaluation and validation testing in order to determine the feasibility under your actual usage conditions.

Related Products **p. 16**

High-flow blow can be performed.

Vacuum Flow ZH-X249

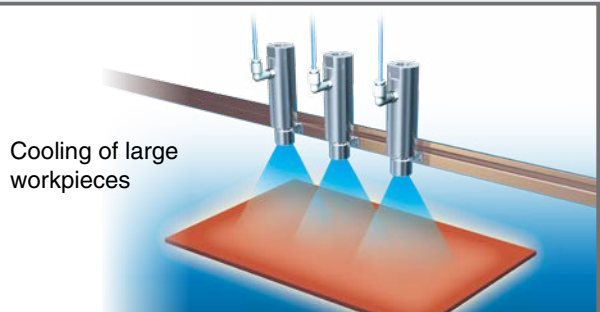

Nozzle Variations

High-pressure blow with minimal pressure loss

p. 9

Mono-porous Nozzle

KN Series

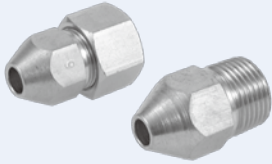

- Pressure loss is significantly reduced and increasing efficiency by implementing a design that uses a large conductance until just before the nozzle outlet.
- This enables a high-pressure blow with minimal pressure loss.
- Connection type: Self-align fitting, Male thread
- Nozzle cover (p. 12)

Nozzle diameter $\varnothing 1, \varnothing 1.5, \varnothing 2, \varnothing 2.5, \varnothing 3, \varnothing 3.5, \varnothing 4, \varnothing 6$
 $\varnothing 1, \varnothing 1.5, \varnothing 2, \varnothing 2.5, \varnothing 4, \varnothing 6, \varnothing 8$

Blow example

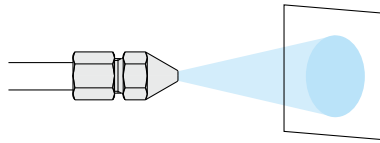

Nozzle length: 300 mm, 600 mm

p. 10

Copper Extension Nozzle

KNL Series

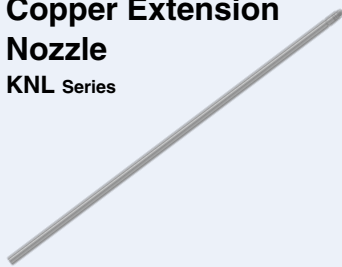

- Secluded and difficult to reach areas
- Blowing at high places, etc.
- With fitting (p. 10)
- Nozzle cover (p. 12)

Nozzle diameter $\varnothing 1.5, \varnothing 2, \varnothing 2.5, \varnothing 3$

Blow example

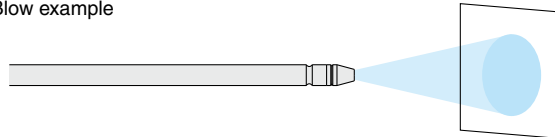

Fine adjustment of blow

p. 11

Pivoting Nozzle

KNK Series

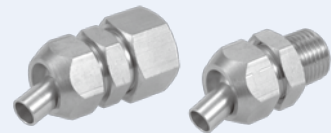

- The pivoting construction of the tip enables fine adjustment of the nozzle direction after setting.
- Connection type: Self-align fitting, Male thread

Nozzle diameter $\varnothing 4, \varnothing 6$

Blow example

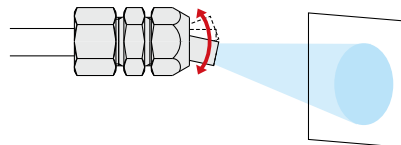

High impact pressure and large flow rate, Compliant with OSHA Standards

p. 11

High Efficiency Nozzle

KNH Series

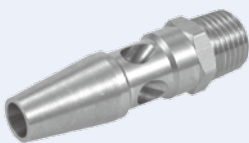

- Entrain the surrounding air increasing the blow flow rate through the nozzle
- Increases the blow flow to about double the supply air quantity
- This nozzle prevents any pressure buildup when the outlet is blocked for safety. (Compliant with OSHA Standards: Operate at 0.5 MPa or less.)

Nozzle diameter $\varnothing 1, \varnothing 1.5, \varnothing 2$

Blow example

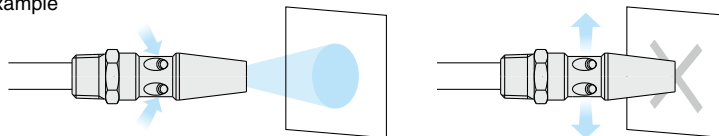

Compliant with OSHA Standards:

Air is discharged from the ports on the side of the product to prevent pressure building up when the outlet of the nozzle tip is blocked.

Noise reduction

p. 11

Low Noise Nozzle

KNS Series

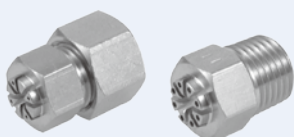

- Small-diameter multi-hole structure to reduce noise and provide a large blow flow rate
- Connection type: Self-align fitting, Male thread

Nozzle diameter $\varnothing 0.75 \times 4, \varnothing 1 \times 4, \varnothing 0.9 \times 8$
 $\varnothing 0.75 \times 4, \varnothing 1 \times 4, \varnothing 0.9 \times 8, \varnothing 1.1 \times 8$

Blow example

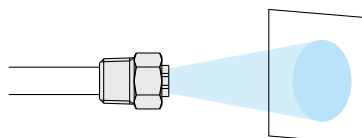

Nozzle Variations

Adjustable layout to match application

Nozzle for One-touch Fitting/Resin Type KN-Q□A

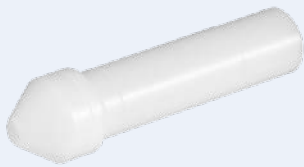

- Nozzle that fit One-touch fittings can be used to setup different blow system layouts.
- Uses highly efficient single hole nozzle to ensure high impact pressure.
- The nozzle diameter can be selected to change the impact pressure on the workpiece.
- This combination variation allows a significant reduction of air consumption by blowing an area wider than a comb-shaped nozzle.

Nozzle diameter	ø1, ø1.5, ø2, ø2.5, ø3
Applicable One-touch fitting size	ø6, ø8, ø10, ø12

Mounting examples * The nozzle size can be changed.



“Twin Nozzle”

Jet shape



Nozzle for One-touch fitting/
Resin type

KN-Q□A

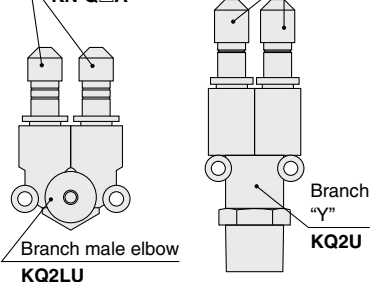

“Triple Nozzle”

Jet shape



Nozzle for One-touch fitting/
Resin type

KN-Q□A

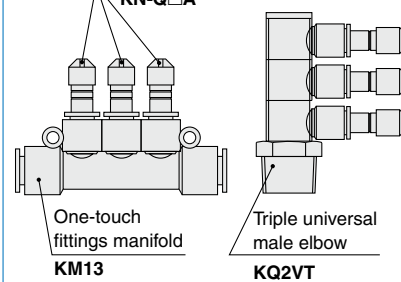

“High-thrust Type”

Jet shape

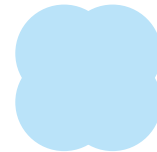

Nozzle for One-touch fitting/
Resin type

KN-Q□A

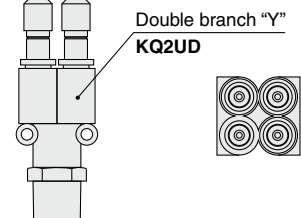

“Water-resistant Type”

Jet shape



Fitting: Stainless steel 316, Nozzle: POM
Nozzle for One-touch fitting/
Resin type

KN-Q□A

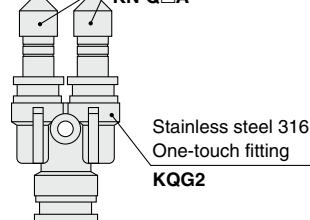

* Stainless steel products are available for heat resistance and anti-corrosion properties. Please contact SMC for further details.

“Bar Type Nozzle”

Jet shape



Nozzle for One-touch fitting/
Resin type

KN-Q□A

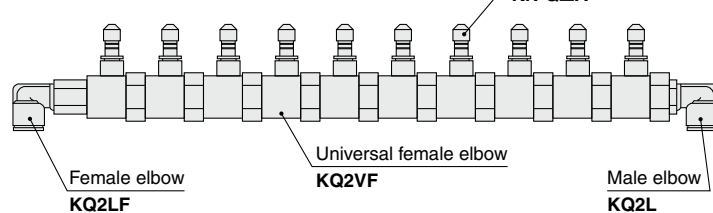

Caution The use of fittings not manufactured by SMC is extremely dangerous since the nozzle for One-touch fitting may be released with no warning. Make sure to purchase the One-touch fitting KQ2 series by SMC and use it in combination with the nozzle. For details on fittings, refer to the [Web Catalog](#).

Nozzle Variations

Made to Order

For blowers

p. 13

Blower Nozzle KN-R03-400-X1484

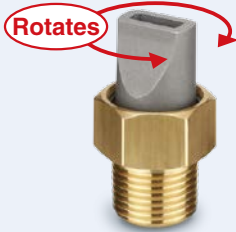

- The spray direction can be adjusted.
- Spray: Fan shape

Nozzle port size	4 x 11
Connection thread	R3/8

Blow example

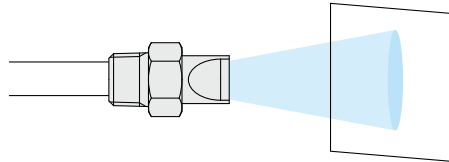

The nozzle position can be rotated after mounting.

p. 14

Bender Tube KN-06-150-X1567



- The nozzle position can be easily adjusted by using a flexible tube.
- The tube can be cut in any length.

Nozzle diameter	ø1.5
Connection thread	R1/8
Tube length	300 mm

Blow example

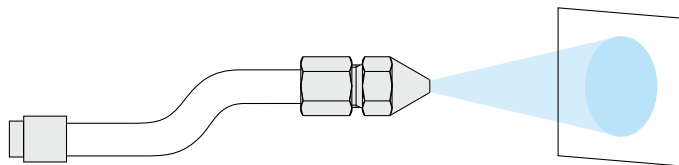

Improved corrosion resistance, heat resistance, and chemical resistance

p. 15

Stainless Steel Nozzles

- Use stainless steel nozzles for excellent anti-corrosion and chemical resistance properties
- Can be used in environments where contact with water or chemicals occurs

Material	Stainless steel 303, Stainless steel 304
----------	--

	With self-align fitting	Nozzle with male thread	Pivoting nozzle with male thread	High efficiency	High noise reduction	2-port nozzle	3-port nozzle
Applicable tubing O.D.	ø6	R1/8, R1/4	R1/4	R1/4	R1/4	R1/8	R1/4
Nozzle dia.	ø2.0	ø1.5, ø2.5	ø2.0	ø2.0	ø1.1 x 8	ø1.5 x 2	ø1.5 x 3

Related Products

High-flow blow can be performed.

p. 16

Vacuum Flow (ZH) ZH Series



- Entrain the surrounding air increasing the blow flow rate through the nozzle
- Increases the blow flow to about 2 to 4 times the supply air quantity





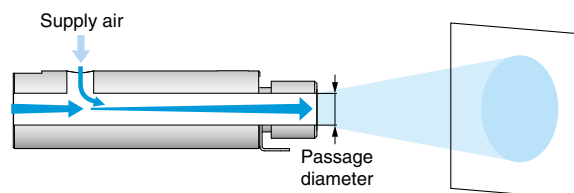

Fluid passage diameter	ø8, ø11.5, ø12
------------------------	----------------



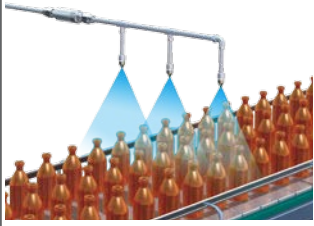

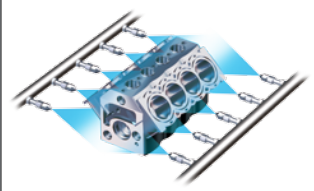
Blow example

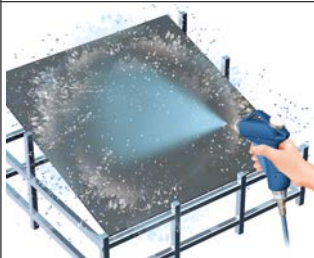

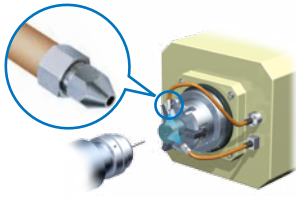

Applications



Nozzles for Blowing

Work process	Application example	Main series
Bottle cleaning	 High-pressure blow with minimal pressure loss Adjustable layout to match application	KN-Q□A p. 10 
Blowing water droplets off engine blocks	 High-pressure blow with minimal pressure loss Adjustable layout to match application Fine adjustment of blow	KN KNK KN-Q□A p. 9 to 11 
Water droplet removal		KNK p. 11 

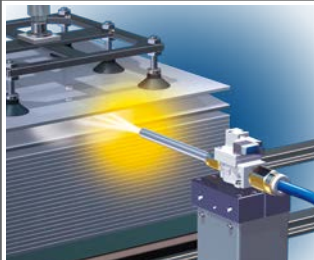



Work process	Application example	Main series
Cooling during machining		KN p. 9 
Blowing for deburring after machining		KN p. 9 



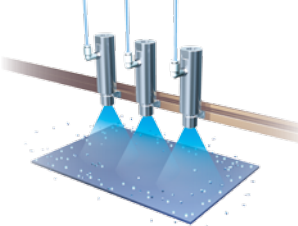

Nozzles for Impact Blow Guns/Blow Valves

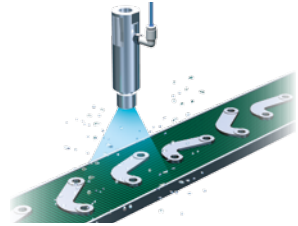
Work process	Application example	Main series
Blowing for separating laminated sheet	 	IBG1-12-10-□ 

Work process	Application example	Main series
Blowing for cleaning after machining	 	IBG1-12-10-□ 

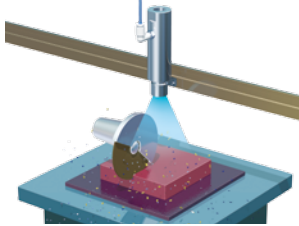
Related Products Vacuum Flow

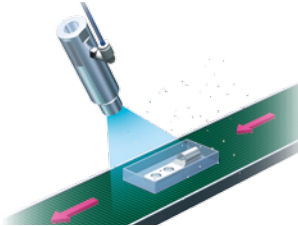
Work process	Application example	Main series
Pre-cleaning surfaces		ZH-X249 p. 16 
Removal of foreign matter on the surface		ZH-X249 p. 16 

Work process	Application example	Main series
Removal of machining chips during shearing		ZH-X249 p. 16 
Blowing away machining chips		ZH-X249 p. 16 

⚠ Caution The applications described here are for reference only. For actual usage in various other applications, please conduct thorough evaluation and validation testing in order to determine the feasibility under your actual usage conditions.

Jet Shape and Impact Pressure Distribution Diagram

Nozzle with Self-align Fitting KN Series Copper Extension Nozzle KNL Series **p. 9, 10**

- Standard blow nozzle
- Highly effective with low pressure loss
- A wide variety of nozzle diameters are available for selection.
- Can be used with One-touch fittings, copper piping, and other applications in addition to mounting on male and female threads

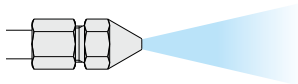

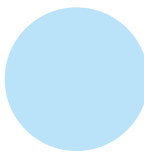
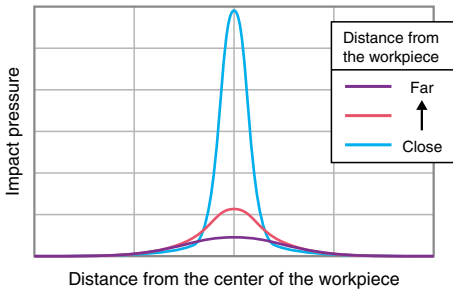
Jet shape	Pressure distribution diagram (Image)	Main applications
 <p>Distance from the workpiece: 100 mm</p>		General air blow purposes

High Efficiency Nozzle KNH Series **p. 11**

- Entrain the surrounding air and increases the blow flow rate
- Blow thrust improved by 10%
- OSHA Standards compliant product (Operate at 0.5 MPa or less.)

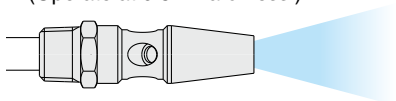

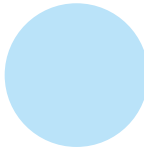
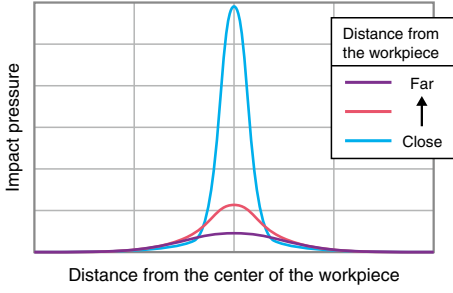
Jet shape	Pressure distribution diagram (Image)	Main applications
 <p>Distance from the workpiece: 100 mm</p>		General air blow purposes

Branch Male Elbow + Nozzle for One-touch Fitting/Resin Type KQ2LU + KN-Q□A (2 pcs.) **p. 4**

- A type with two nozzles (resin type) for One-touch fitting inserted in a branch elbow
- Can be used for blowing a wide area
- Provides high impact pressure and a jet shape similar to a general comb-shaped nozzle
- Low air consumption (Compared to a comb-shaped nozzle)

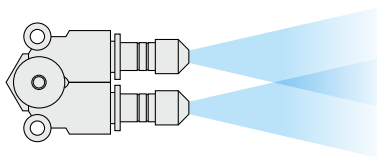

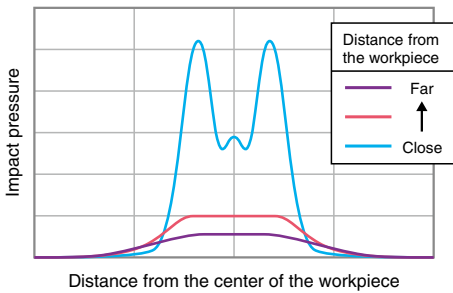
Jet shape	Pressure distribution diagram (Image)	Main applications
 <p>Distance from the workpiece: 100 mm</p>		Blowing off of water droplets Removal of defective workpieces Drying Removal of foreign matter Blowing water droplets off engine blocks Workpiece alignment

Jet Shape and Impact Pressure Distribution Diagram

One-touch Fittings Manifold + Nozzle for One-touch Fitting/ Resin Type

KM13 + KN-Q□A (3 pcs.)

p. 4

- Nozzle for One-touch fittings / resin type One-touch fittings manifold docking stations
- Optimum for blowing water, or other fluids off, a wide area
- For impact pressure and blowing area greater than a general comb-shaped nozzle!

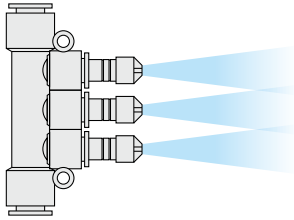

Jet shape	Pressure distribution diagram (Image)	Main applications
<p>Distance from the workpiece: 100 mm</p>		<p>Blowing off the water of a wide area</p> <p>Drying</p> <p>Removal of foreign matter</p> <p>Cooling</p>

Low Noise Nozzle with Self-align Fitting

KNS Series p. 11

- Designed to blow with 4 to 8 nozzles and high noise reduction. Can be used for a smaller area

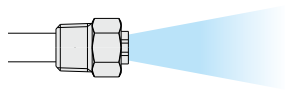

Jet shape	Pressure distribution diagram (Image)	Main applications
<p>Distance from the workpiece: 50 mm</p>		<p>Drying, Blowing off of water droplets</p> <p>Cooling: Highly precise cooling of resin-molded articles</p>

Nozzles for Blowing

KN Series

RoHS

Specifications

Nozzle (KN, KNK, KNH, KNS, KNL)

Applicable tubing material	Nylon, Soft nylon, Flexible copper pipe (C1220T-O), OST pipe	
Applicable tubing O.D.	ø4, ø6, ø8, ø10, ø12, ø16, ø20	
Fluid	Air, Coolant*1	
Max. operating pressure	1 MPa (0.3 MPa with OST pipe)	
Ambient and fluid temperatures	-5 to 60°C (No freezing)	
Threads	Mounting	JIS B 0203 (Taper threads for piping)
	Nut	JIS B 0205 (Metric fine thread)
Seal on the threads	None	
Copper-free (Standard)	Brass parts are all electroless nickel plated.	

*1 Excludes the KNS and KN-Q□A

Principal Parts Material

KN, KNK, KNH, KNS

Body, Nut	C3604
Sleeve (Self-align fitting type)	C2700
Nozzle (Pivoting type)	Stainless steel 303

KNL

Pipe	C1220T-0
Nozzle	C3604

Nozzle with self-align fitting/KN

[mm]



Model	Nozzle dia. øD	Applicable tubing O.D.	Width across flats		L ₁	M	Weight [g]
			H ₁	H ₂			
KN-04-100	ø1	ø4	10	10	27	15	13
KN-04-150	ø1.5	ø4	10	10	27.7	15	14
KN-06-100	ø1	ø6	12	12	30.1	16	19
KN-06-150	ø1.5	ø6	12	12	30.8	16	20
KN-06-200	ø2	ø6	12	12	31.5	16	22
KN-08-150	ø1.5	ø8	14	14	33.8	16	28
KN-08-200	ø2	ø8	14	14	34.6	16	30
KN-10-250	ø2.5	ø10	14	17	35.6	17	35
KN-10-300	ø3	ø10	14	17	36.3	17	36
KN-10-350	ø3.5	ø10	14	17	37.1	17	37
KN-10-400	ø4	ø10	14	17	29.5	17	30
KN-10-600	ø6	ø10	14	17	27.7	17	28
KN-12-350	ø3.5	ø12	17	19	40.4	17	54
KN-12-400	ø4	ø12	17	19	41.3	17	55
KN-12-600	ø6	ø12	17	19	31.2	17	40
KN-16-400	ø4	ø16	22	24	40.1	17	77
KN-16-600	ø6	ø16	22	24	38.4	17	79
KN-20-400	ø4	ø20	26	27	45.6	17	117
KN-20-600	ø6	ø20	26	27	43.9	17	112

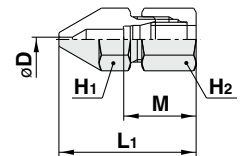

Nozzle with male thread/KN

[mm]



Model	Nozzle dia. øD	Connection thread	Width across flats	L ₁	A*1	Weight [g]
			H ₁			
KN-R01-100	ø1	R1/8	10	21.4	17.4	8
KN-R01-150	ø1.5	R1/8	10	21	17	8
KN-R02-100	ø1	R1/4	14	31.4	25.4	19
KN-R02-150	ø1.5	R1/4	14	31	25	20
KN-R02-200	ø2	R1/4	14	30.5	24.5	21
KN-R02-250	ø2.5	R1/4	14	30.1	24.1	21
KN-R02-600	ø6	R1/4	14	27.1	21.1	22
KN-R03-400	ø4	R3/8	17	31.8	25.4	36
KN-R03-600	ø6	R3/8	17	30.1	23.7	37
KN-R04-400	ø4	R1/2	22	41.8	33.6	75
KN-R04-600	ø6	R1/2	22	40.1	31.8	76
KN-R06-600	ø6	R3/4	27	49.6	40.1	149
KN-R06-800	ø8	R3/4	27	47.8	38	152
KN-R10-800	ø8	R1	36	62.8	52.4	328

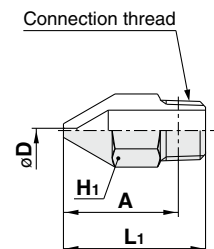

*1 Reference dimensions after R thread installation

Copper extension nozzle/KNL

[mm]

Model	Nozzle dia. ϕD	Outside diameter	L ₁	Weight [g]
KNL3-06-150	$\phi 1.5$	$\phi 6$	300	43
KNL3-06-200	$\phi 2$	$\phi 6$	300	43
KNL3-08-200	$\phi 2$	$\phi 8$	300	61
KNL3-08-250	$\phi 2.5$	$\phi 8$	300	61
KNL3-10-250	$\phi 2.5$	$\phi 10$	300	94
KNL3-10-300	$\phi 3$	$\phi 10$	300	94
KNL6-06-150	$\phi 1.5$	$\phi 6$	600	84
KNL6-06-200	$\phi 2$	$\phi 6$	600	84
KNL6-08-200	$\phi 2$	$\phi 8$	600	117
KNL6-08-250	$\phi 2.5$	$\phi 8$	600	117
KNL6-10-250	$\phi 2.5$	$\phi 10$	600	183
KNL6-10-300	$\phi 3$	$\phi 10$	600	183

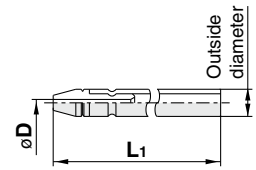

Copper extension nozzle set/VMG

[mm]

Model	Nozzle dia. D	Outside diameter	L ₁	L ₂ *1	L*1	Width across flats																													
						H ₁																													
VMG1-06-150-100	$\phi 1.5$	$\phi 6$	100	100	106	12																													
VMG1-06-200-100	$\phi 2$		150	150	156																														
VMG1-06-150-150	$\phi 1.5$						300	300	306																										
VMG1-06-200-150	$\phi 2$									600	600	606																							
VMG1-06-150-300	$\phi 1.5$												100	100	106																				
VMG1-06-200-300	$\phi 2$															150	150	156																	
VMG1-06-150-600	$\phi 1.5$	300				300													306																
VMG1-06-200-600	$\phi 2$		600	600	606																														
VMG1-08-250-100	$\phi 2.5$						$\phi 8$	100	106											14															
VMG1-08-300-100	$\phi 3$									150	150	156																							
VMG1-08-350-100	$\phi 3.5$												300	300	306																				
VMG1-08-250-150	$\phi 2.5$															600	600	606																	
VMG1-08-300-150	$\phi 3$	100				100													106																
VMG1-08-350-150	$\phi 3.5$		150	150	156																														
VMG1-08-250-300	$\phi 2.5$																				300	300	306												
VMG1-08-300-300	$\phi 3$																							600	600	606									
VMG1-08-350-300	$\phi 3.5$																										100	100	106						
VMG1-08-250-600	$\phi 2.5$																													150	150	156			
VMG1-08-300-600	$\phi 3$																																300	300	306
VMG1-08-350-600	$\phi 3.5$																																		

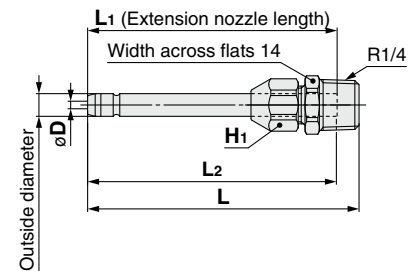

*1 Reference dimensions after installation
 * Copper extension nozzle and self-align fitting are included in the same package but do not come assembled. Refer to "How to attach extension nozzle" in the VMG series operation manual for assembly procedures.

Nozzle for One-touch fitting (Resin type)/KN-Q□A

[mm]

Model	Nozzle dia. ϕD	Applicable fitting size ϕd	L ₁	A*1	Weight [g]
KN-Q06A-100	$\phi 1$	$\phi 6$	35	21.8	1
KN-Q06A-150	$\phi 1.5$	$\phi 6$	35	21.8	1
KN-Q06A-200	$\phi 2$	$\phi 6$	35	21.8	1
KN-Q08A-150	$\phi 1.5$	$\phi 8$	39	24.8	2
KN-Q08A-200	$\phi 2$	$\phi 8$	39	24.8	2
KN-Q10A-200	$\phi 2$	$\phi 10$	43	27.4	3
KN-Q10A-250	$\phi 2.5$	$\phi 10$	43	27.4	3
KN-Q12A-250	$\phi 2.5$	$\phi 12$	45.5	28.5	4
KN-Q12A-300	$\phi 3$	$\phi 12$	45.5	28.5	4

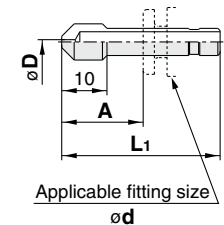

*1 Dimensions shown are for nozzle connected to the KQ2 series.

⚠ Warning [Mounting / Piping] Applicable nozzle: Nozzle for One-touch fitting (Resin/Metal type)
 When connecting the nozzle to the One-touch fitting, insert it securely until it cannot move any further. After setting the nozzle deep into the fitting, be sure to pull on the nozzle to confirm that it is firm and does not budge. If the nozzle is not secured all the way at the back of the fitting or if there is insufficient engagement with the One-touch fitting, the nozzle may dislodge during pressurization, which is dangerous and may result in injury or accident.

Nozzle for One-touch fitting (Metal type)/KN-Q□

[mm]

Model	Nozzle dia. ϕD	Applicable fitting size ϕd	L ₁	A	Weight [g]
KN-Q06-100	$\phi 1$	$\phi 6$	35	18	5
KN-Q06-150	$\phi 1.5$	$\phi 6$	35	18	5
KN-Q06-200	$\phi 2$	$\phi 6$	35	18	5
KN-Q08-150	$\phi 1.5$	$\phi 8$	39	20.5	9
KN-Q08-200	$\phi 2$	$\phi 8$	39	20.5	9
KN-Q10-200	$\phi 2$	$\phi 10$	43	22	16
KN-Q10-250	$\phi 2.5$	$\phi 10$	43	22	16
KN-Q12-250	$\phi 2.5$	$\phi 12$	45.5	24	23
KN-Q12-300	$\phi 3$	$\phi 12$	45.5	24	23

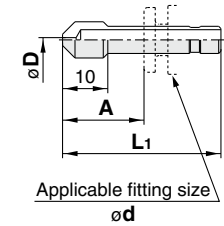

Connecting products with metal rods
 Products with metal rods cannot be connected to the KQ2 series One-touch fittings (Available as a special order). If connected, the metal rod cannot be retained by the chuck of the One-touch fitting and products with metal rods may project during pressurization, causing serious personal injury or accident. For details about One-touch fittings that can connect products with metal rods, contact SMC.

KN Series

Pivoting nozzle with self-align fitting/KNK

[mm]



Model	Nozzle dia. øD	Applicable tubing O.D.	Width across flats		L ₁	M	Weight [g]
			H ₁	H ₂			
KNK-10-400	ø4	ø10	17	17	41.7	17	44
KNK-10-600	ø6	ø10	17	17	41.7	17	44
KNK-12-400	ø4	ø12	17	19	41.2	17	44
KNK-12-600	ø6	ø12	17	19	41.2	17	44
KNK-16-400	ø4	ø16	17	24	41.8	17	64
KNK-16-600	ø6	ø16	17	24	41.8	17	64
KNK-20-400	ø4	ø20	17	27	43.8	17	77
KNK-20-600	ø6	ø20	17	27	43.8	17	77

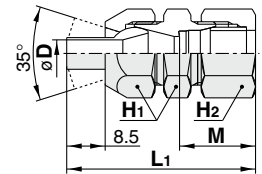

Pivoting nozzle with male thread/KNK

[mm]



Model	Nozzle dia. øD	Connection thread	Width across flats		L ₁	A*1	Weight [g]
			H ₁	H ₂			
KNK-R02-400	ø4	R1/4	17	17	38	31.9	32
KNK-R02-600	ø6	R1/4	17	17	38	31.9	32
KNK-R03-400	ø4	R3/8	17	17	39	32.4	40
KNK-R03-600	ø6	R3/8	17	17	39	32.4	40
KNK-R04-400	ø4	R1/2	17	22	42.2	34.1	54
KNK-R04-600	ø6	R1/2	17	22	42.2	34.1	54

*1 Reference dimensions after R thread installation

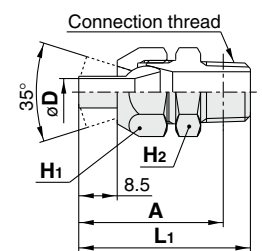

High efficiency nozzle/KNH (OSHA compliant: Operate at 0.5 MPa or less.)

[mm]

Amplifies the air blow flow rate (When operated at 0.5 MPa: amplifies by 2 to 3 times)



Model	Nozzle dia. øD	Connection thread	Width across flats	L ₁	A*1	Weight [g]
			H ₁			
KNH-R02-100	ø1	R1/4	14	52	46	38
KNH-R02-150	ø1.5	R1/4	14	52	46	38
KNH-R02-200	ø2	R1/4	14	52	46	38

*1 Reference dimensions after R thread installation

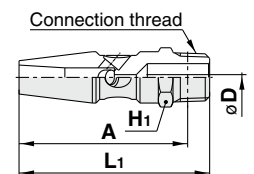

Low noise nozzle with self-align fitting/KNS

[mm]



Model	Nozzle dia. øD	Applicable tubing O.D.	Width across flats		L ₁	M	Weight [g]
			H ₁	H ₂			
KNS-08-075-4	ø0.75 x 4	ø8	12	14	24.3	16	17
KNS-08-100-4	ø1 x 4	ø8	12	14	24.3	16	17
KNS-10-075-4	ø0.75 x 4	ø10	14	17	24	17	24
KNS-10-090-8	ø0.9 x 8	ø10	14	17	24	17	24
KNS-10-100-4	ø1 x 4	ø10	14	17	24	17	24

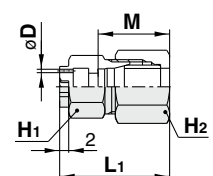

Low noise nozzle with male thread/KNS

[mm]



Model	Nozzle dia. øD	Connection thread	Width across flats	L ₁	A*1	Weight [g]
			H ₁			
KNS-R01-075-4	ø0.75 x 4	R1/8	12	18	14	9
KNS-R01-100-4	ø1 x 4	R1/8	12	18	14	9
KNS-R01-090-8	ø0.9 x 8	R1/8	12	18	14	9
KNS-R02-075-4	ø0.75 x 4	R1/4	14	20	14	13
KNS-R02-090-8	ø0.9 x 8	R1/4	14	20	14	13
KNS-R02-100-4	ø1 x 4	R1/4	14	20	14	13
KNS-R02-110-8	ø1.1 x 8	R1/4	14	20	14	13

*1 Reference dimensions after R thread installation

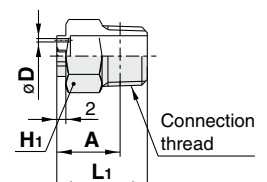

Made to Order
(For details, refer to pages 13 to 15.)

Description	
Blower Nozzle	p. 13
Bender Tube	p. 14
Stainless Steel Nozzles	p. 15

Sensing Heads

Specifications

Sensing head (KNP)

Applicable tubing O.D.	ø4
Fluid	Air
Max. operating pressure (at 20°C)	0.8 MPa
Ambient and fluid temperatures	-5 to 60°C (No freezing)

Principal Parts Material

KNP-1

Pressure spindle	Stainless steel 303
One-touch fitting	POM, NBR, Stainless steel 303, Stainless steel 304
Polyurethane tube (ø4, 1 m)	Polyurethane

KNP-2

Pipe	Stainless steel 304
One-touch fitting	POM, NBR, Stainless steel 304
Polyurethane tube (ø4, 1 m)	Polyurethane

Standard sensing head/KNP



Model	Nozzle dia. øD	Applicable tubing O.D.	Width across flats		M	L ₁	L ₂	Weight [g]
			H ₁	H ₂				
KNP-1	ø2.5	ø4	5	8	13.3	64.6	986.7	7

* A 1 m polyurethane tube is included.

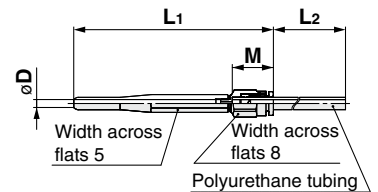

Needle sensing head/KNP



Model	Nozzle dia. øD	Applicable tubing O.D.	D ₂	M	L ₁	L ₂	L ₃	Weight [g]

* A 1 m polyurethane tube is included.

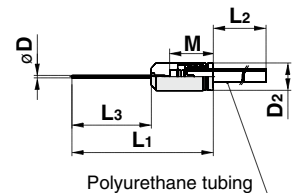

Use to measure workpiece impact pressure.

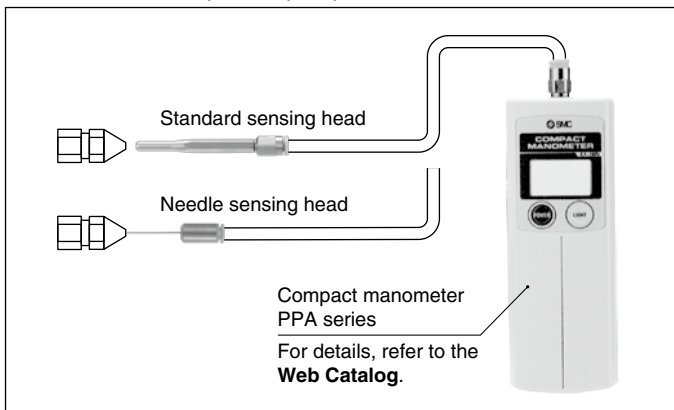

Nozzle Covers

Cover for male thread nozzle

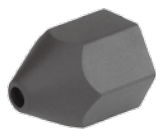

Nozzle cover model	Material	Applicable blow gun model	
		Model	Nozzle type
P5670129-01	HNBR	VMG1□□-□-01 to 04	Male thread nozzle ø1 to ø2.5
P5670129-01F	Fluororubber		
P5670129-02	HNBR	VMG1□□-□-05 to 07	Male thread nozzle ø3 to ø4
P5670129-02F	Fluororubber		

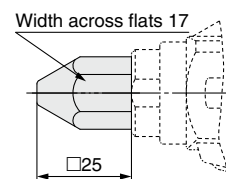

VMG1□□-□-1 to 04

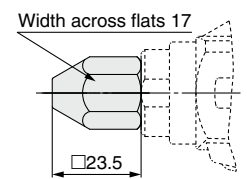

VMG1□□-□-05 to 07

Cover for copper extension nozzle



Nozzle cover model	Material	Applicable blow gun model	
		Model	Nozzle type
P5670129-11	HNBR	VMG1□□-□-31 to 38	ø6 copper extension nozzle
P5670129-11F	Fluororubber		

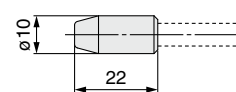

VMG1□□-□-31 to 38

Made to Order

Contact our sales office for delivery dates and prices as this is a special model.



1 Blower Nozzle KN-R03-400-X1484

- The spray direction can be adjusted after the nozzle has been mounted.
- Spray: Fan shape
- Material: Stainless steel (Nozzle)
Brass (Socket: R3/8)

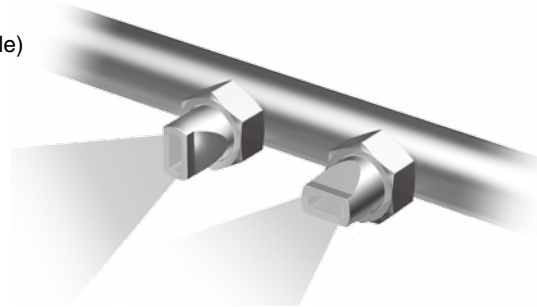

Rotates

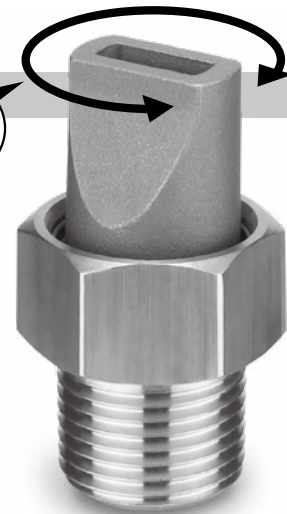

Nozzle Impact Pressure Distribution Diagram

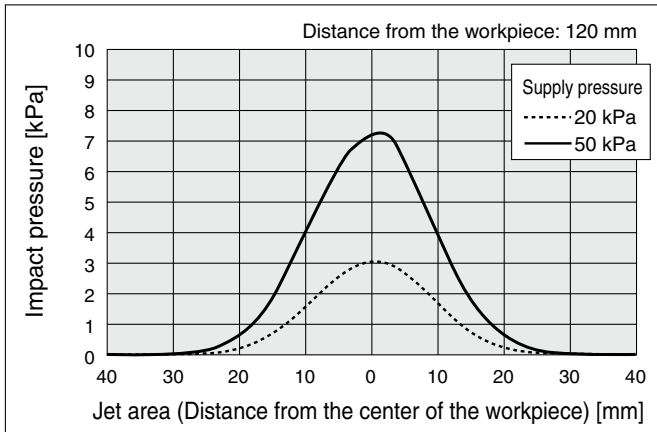

Application Example

For blowing water droplets off engine blocks

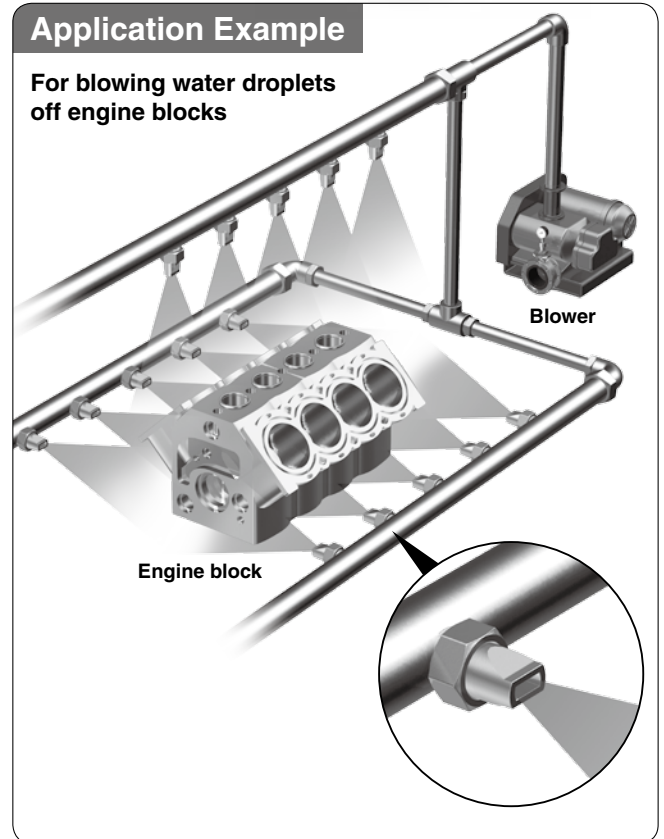

Specifications

Fluid	Air
Operating pressure range	1 MPa or less*1
Fluid temperature	-10 to 60°C
Nozzle port size	4 x 11
Connection thread	R3/8
Weight	45 g
Air source	Blower*1
Spray	Fan shape

*1 Compressor air can be used.

Dimensions

[mm]

KN-R03-400-X1484

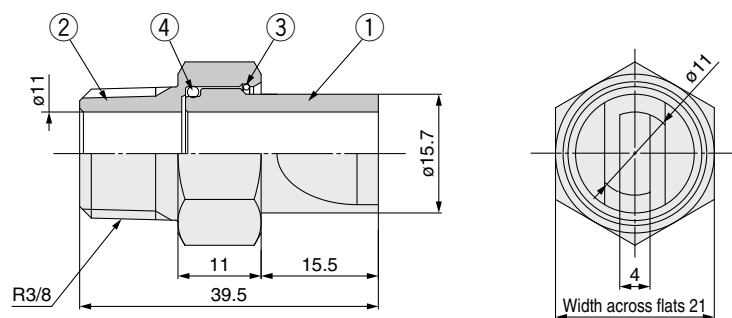

No.	Description	Material
1	Nozzle (4 x 11)	Stainless steel
2	Socket (R3/8)	Brass
3	Stopper	Stainless steel
4	O-ring	NBR

Made to Order

Contact our sales office for delivery dates and prices as this is a special model.



2 Bender Tube KN-06-150-X1567

- A metal bender tube and a single-hole nozzle combined in one unit, which allows the shape to be changed manually
- The nozzle diameter can be selected to adjust the impact pressure on the workpiece.
- Can be cut with a tube cutter (TK series made by SMC)



Dimensions

KN-06-150-X1567

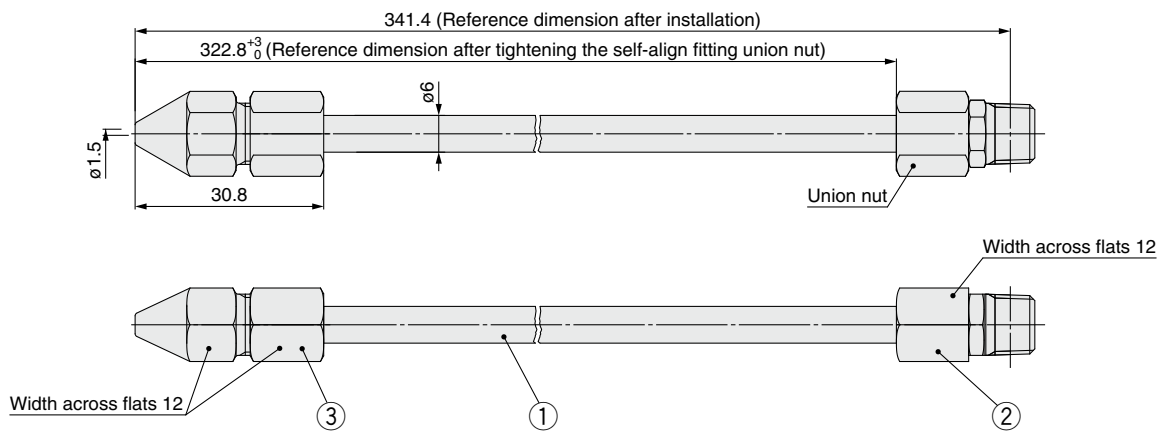

Made to Order

Contact our sales office for delivery dates and prices as this is a special model.



3 Stainless Steel Nozzles

- Use stainless steel nozzles for excellent anti-corrosion and chemical resistance properties
- Can be used in environments where contact with water or chemicals occurs

With male thread

Connection thread	R1/8
Nozzle dia.	ø1.5

Material:
Stainless steel 303



KN-R01-150-X13

Connection thread	R1/4
Nozzle dia.	ø2.5

Material:
Stainless steel 303



KN-R02-250-X13

Material:
Stainless steel 304



KN-R02-250-X49

With self-align fitting

Applicable tubing O.D.	ø6
Nozzle diameter	ø2.0

Material: Stainless steel 303

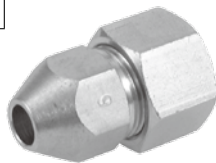

KN06-200-DPI00713

Pivoting nozzle with male thread

Connection thread	R1/4
Nozzle dia.	ø2.0

Material: Stainless steel 303



KNK-R02-200-X1524

High efficiency

Connection thread	R1/4
Nozzle dia.	ø2.0

Material:
Stainless steel 303

Material:
Stainless steel 304

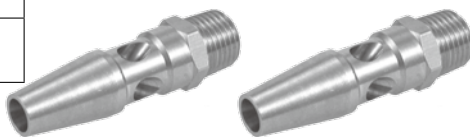

KNH-R02-200-X13

KNH-R02-200-X49

High noise reduction

Connection thread	R1/4
Nozzle dia.	ø1.1 x 8

Material: Stainless steel 303



KNS-R02-110-8-X13

2-port/3-port nozzle

Connection thread	R1/8
Nozzle dia.	ø1.5 x 2

Material: Stainless steel 304

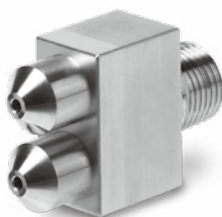

KN-DPW00079

Connection thread	R1/4
Nozzle dia.	ø1.5 x 3

Material: Stainless steel 304

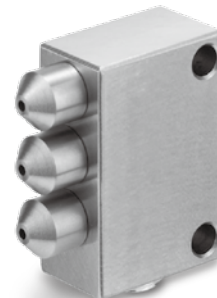

KN-DPZ00022

Please contact SMC for information on size options.

Related Products

Vacuum Flow

ZH-X226/X338/X249

High-flow blow **Max. 1550 L/min (ANR)** and vacuum **Max. 880 L/min (ANR)** can be performed by supplying compressed air.

Model	L/min (ANR)		
	Suction flow rate	Discharge flow rate	Air consumption
ZH-X226	405	700	297
ZH-X338	880	1550	570
ZH10-B-X249	820	1160	340

At 0.5 MPa supply pressure

Series Map

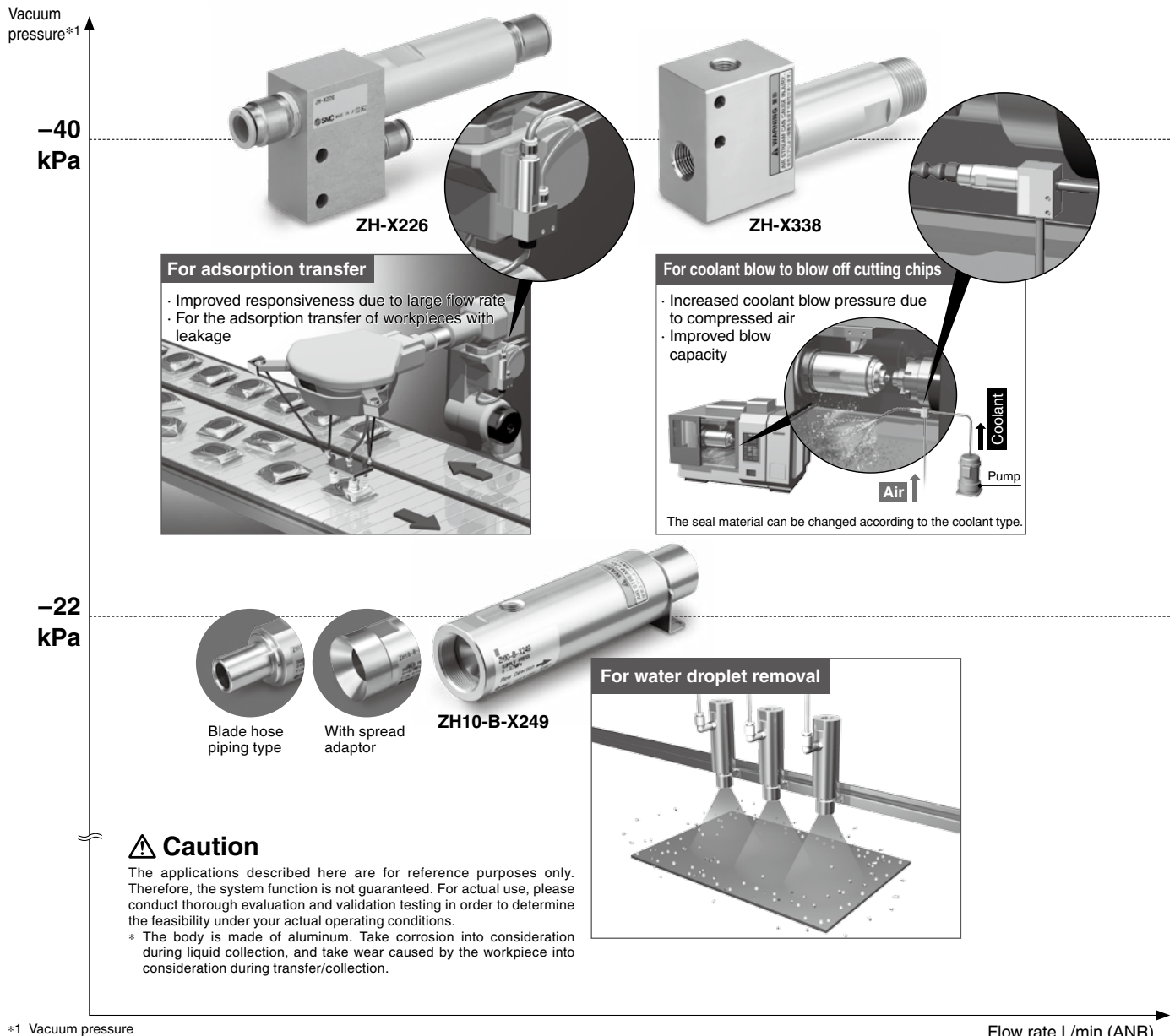

*1 Vacuum pressure at 0.5 MPa supply pressure

Flow rate L/min (ANR)

Related Product

Vacuum Flow

ZH-X226



Model/Specifications

Model	ZH-X226
Body material	Aluminum alloy
Seal material	NBR
Passage diameter	$\phi 8$
C [dm ³ /(s·bar)] (Effective area [mm ²])*1	0.83 (4.13)
Fluid	Air
Supply pressure range	0 to 0.7 MPa
Ambient and fluid temperatures [°C]	-5 to 80 (No freezing or condensation)
Weight [g]	240

*1 The C value and the effective area are theoretical values.

Exhaust Characteristics

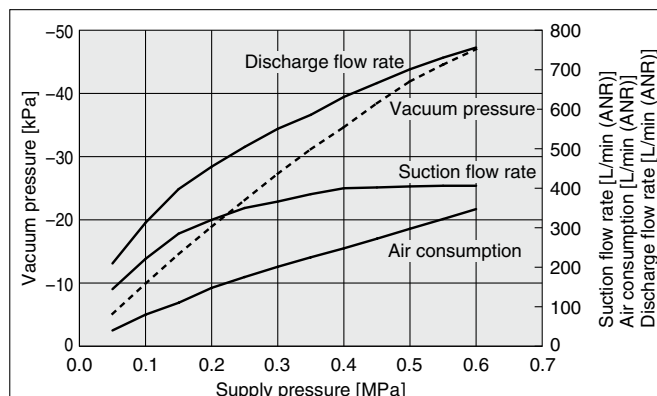

This data was acquired under SMC's measurement conditions. Therefore, the characteristics are not guaranteed. In addition, the data shows representative values and the performance may change depending on the piping conditions, etc. Be sure to conduct tests on the actual equipment to test for compatibility with the intended application.

Dimensions

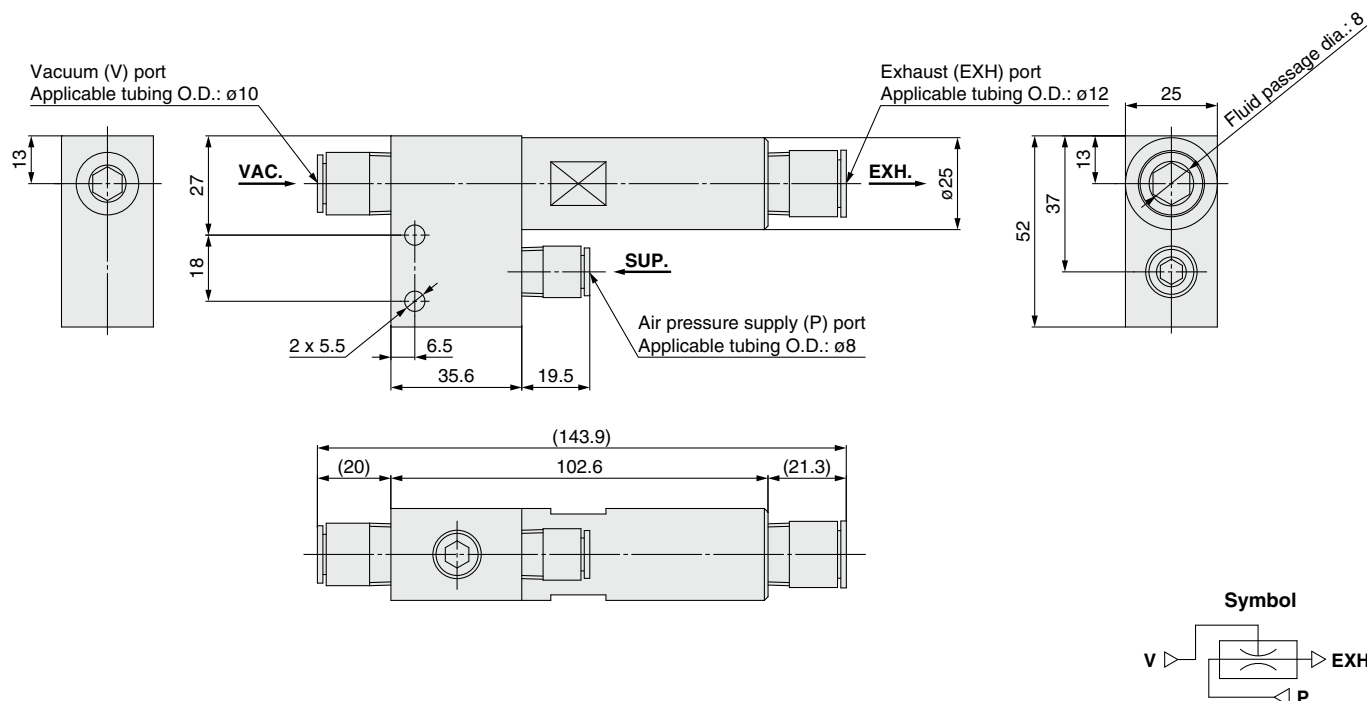

⚠ Specific Product Precautions

Be sure to read this before handling the products. For safety instructions and vacuum equipment precautions, refer to the **Web Catalog**: <https://www.smcworld.com>

Operating Precautions

⚠ Warning

1. Because suctioned matter is ejected together with the exhaust, do not direct an exhaust port at a person or other equipment.
2. Do not use in an atmosphere which contains corrosive gases, chemicals, organic solvents, sea water, water steam, or where there is direct contact with any of these.

Related Product

Vacuum Flow

ZH-X338

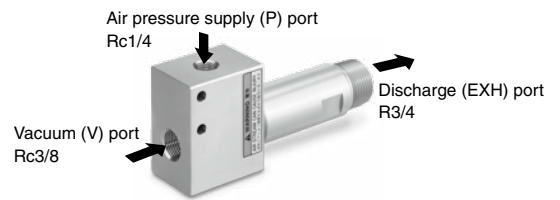

Model/Specifications

Model	ZH-X338
Body material	Aluminum alloy
Seal material	NBR
Passage diameter	ø12
C [dm ³ /(s·bar)] (Effective area [mm ²])*1	1.58 (7.92)
Fluid	Air
Supply pressure range	0 to 0.7 MPa
Ambient and fluid temperatures [°C]	-5 to 80 (No freezing or condensation)
Weight [g]	328

*1 The C value and the effective area are theoretical values.

* Refer to page 17 for specific product precautions.

Exhaust Characteristics

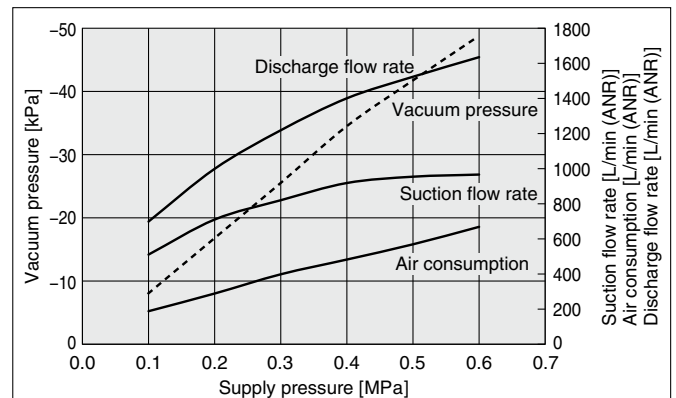

This data was acquired under SMC's measurement conditions. Therefore, the characteristics are not guaranteed. In addition, the data shows representative values and the performance may change depending on the piping conditions, etc. Be sure to conduct tests on the actual equipment to test for compatibility with the intended application.

Dimensions

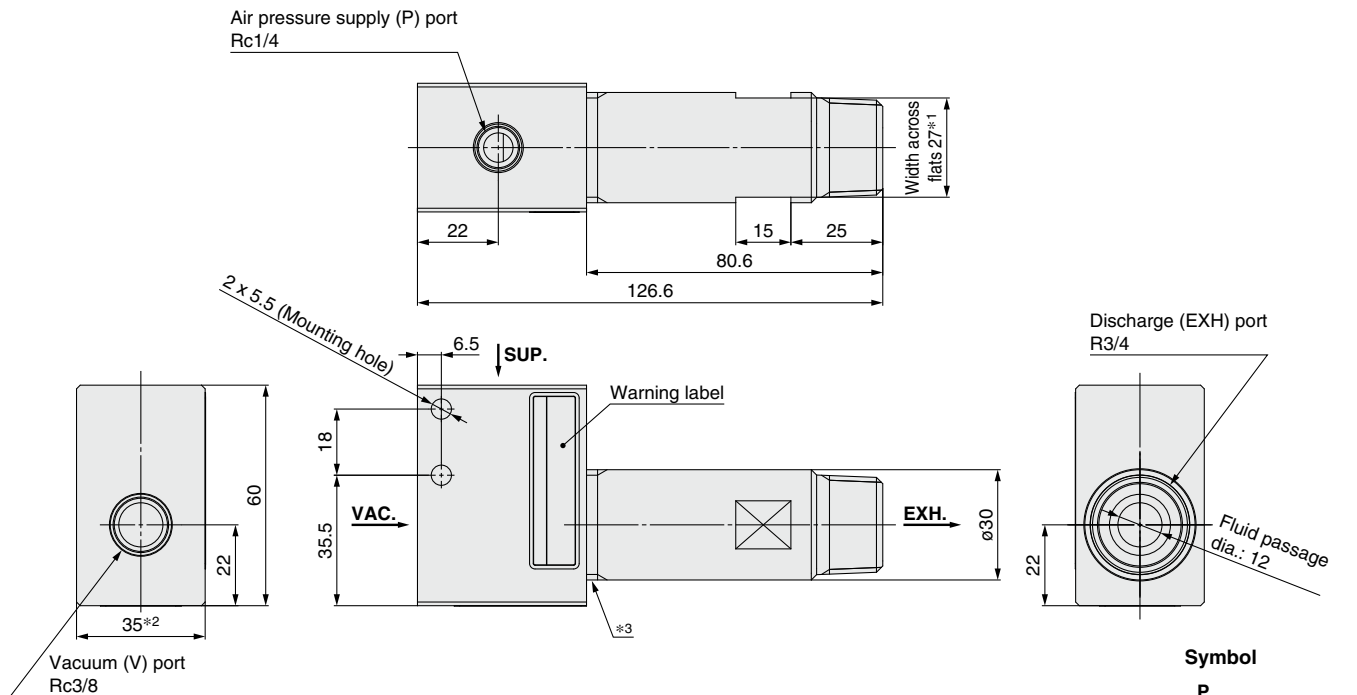

- *1 When connecting (or removing) piping, etc., to the exhaust (EXH) port, be sure to hold the width across flats.
- *2 When connecting (or removing) piping, etc., to the air pressure supply (P) port or the vacuum (V) port, be sure to hold the sides of the body.
- *3 If torque is applied to this thread part, the performance of the product may be affected.

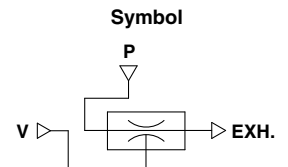

Related Product

Vacuum Flow

ZH10-B-X249

How to Order

ZH10 - B - X249

Suction port type

Nil	Screw piping type	P	Blade hose piping type	W	With spread adaptor
-----	-------------------	---	------------------------	---	---------------------

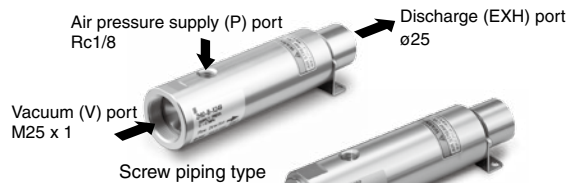

Screw piping type

Blade hose piping type

Vacuum (V) port ø19

With spread adaptor

Vacuum (V) port ø34

Specifications

Model	ZH10-B-X249	ZH10-B-X249P	ZH10-B-X249W
Body material	Aluminum alloy		
Seal material	NBR		
Passage diameter	ø11.5		
C [dm ³ /(s·bar)] (Effective area [mm ²])*1	0.94 (4.72)		
Fluid	Air		
Supply pressure range	0 to 0.7 MPa		
Ambient and fluid temperatures [°C]	-5 to 80 (No freezing or condensation)		
Weight [g]	250	267	278

*1 The C value and the effective area are theoretical values.

* Refer to page 17 for specific product precautions.

Exhaust Characteristics

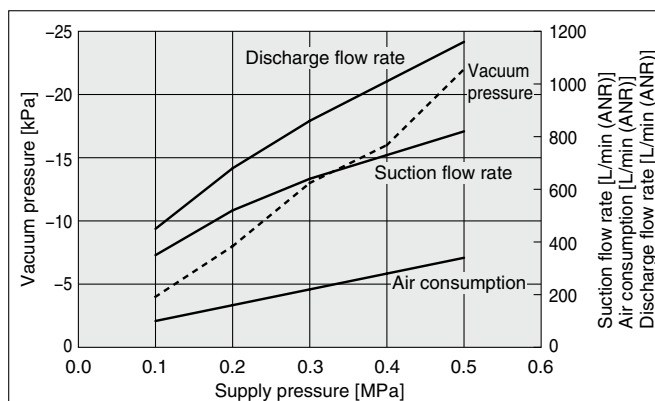

This data was acquired under SMC's measurement conditions. Therefore, the characteristics are not guaranteed. In addition, the data shows representative values and the performance may change depending on the piping conditions, etc. Be sure to conduct tests on the actual equipment to test for compatibility with the intended application.

Dimensions

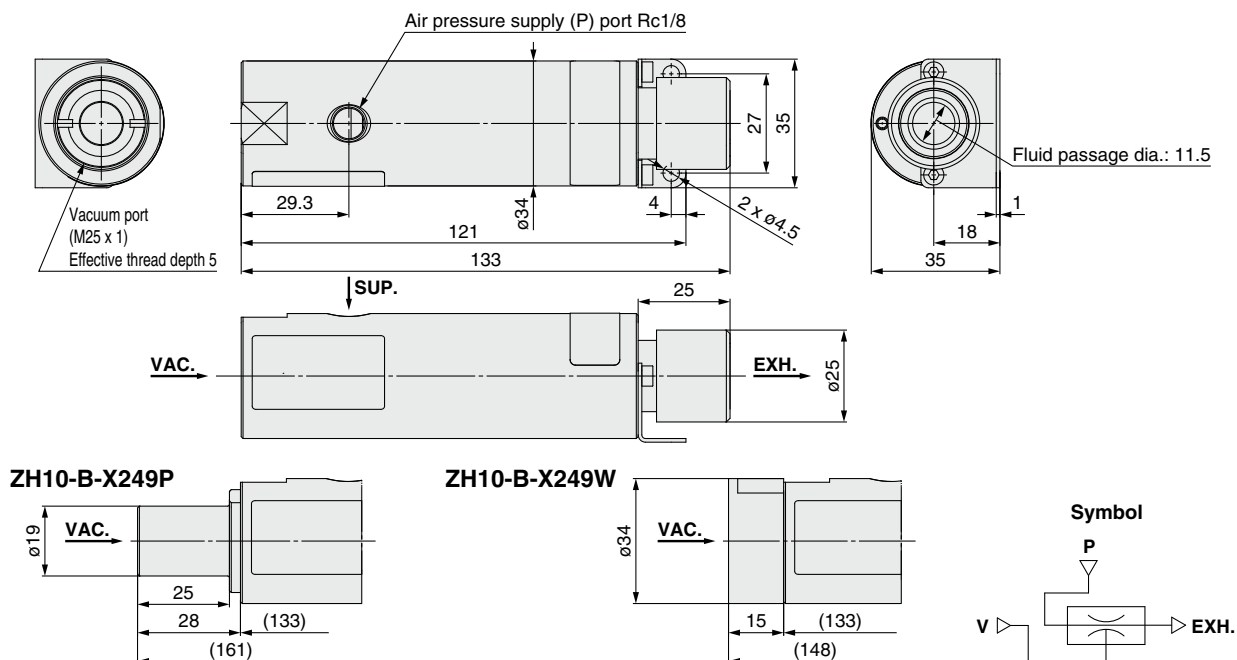

Equipment for Blowing

Blow Gun VMG



- A 20% reduction in power consumption can be achieved with the SMC "Blow gun" + "S coupler" + "Coil tube."
- Pressure loss: 1% or less (Nozzle diameter: $\phi 2.5$)
- Available nozzles:
Male thread nozzle, High efficiency nozzle with male thread, Low noise nozzle with male thread, Copper extension nozzle
- With flow rate adjustment function (-X54)



Available nozzles

KN series



Pulse Blow Valve AXTS040□-□□-X2



- The peak pressure of repeatedly colliding air permits efficient blowing.
- Air consumption: Reduced by 50% or more
- Pulse blow can be used by simply supplying air.

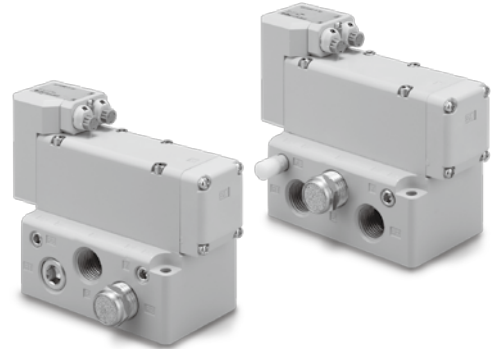

Air Saving Impact Blow Gun IBG



- Increased impact force due to higher peak pressure
- Drastic reduction in air consumption and labor time
- Application: It is capable of eliminating, in a short period of time, the dust, etc., that is difficult to remove with the existing blow gun.

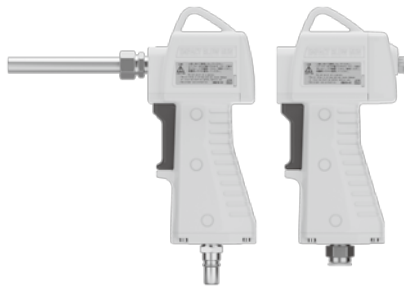

Available nozzles

Long nozzle



Long nozzle with a silencer



Impact Blow Valve IBV1□-X5/X7(-Q)



- Increased impact force due to higher peak pressure
- Drastic reduction in air consumption and labor time
- High peak pressure: 3 times or more (Compared with the existing model)
- Air consumption: 93% reduction
- Compact design allows for installation in narrow spaces.

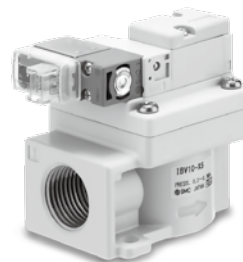

Available nozzles

Long nozzle



Long nozzle with a silencer



Pilot Operated 2-Port Solenoid Valve for Dry Air VQ20/30



- Applications: Air-blow, Blow-off of workpieces, etc.
- High-frequency operation is possible: High-speed response 7 ms or less (VQ20), 20 ms or less (VQ30)
- Easy piping with One-touch fittings
- The dust-tight, water-jet-proof enclosure (IP65) is compatible with the DIN terminal type.
- Manifold type no.: VV2Q22, VV2Q32

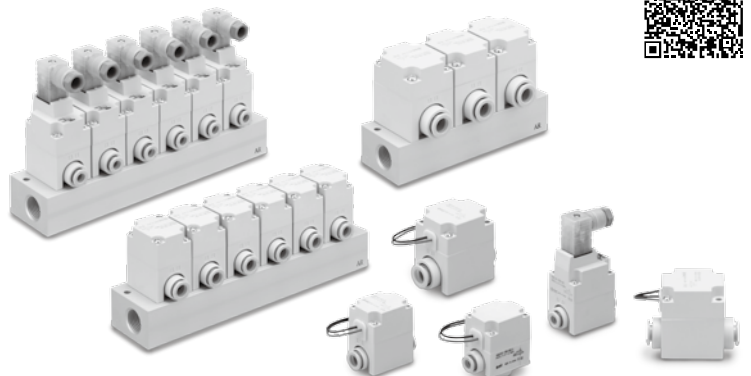

Equipment for Blowing

For Clean Blow

Clean Air Module LLB



- Modularized clean equipment (Reduced piping labor, Space saving)
Makes clean air easily available
- Nominal filtration rating: 0.01 μm (Filtration efficiency: 99.99%)
- Wetted parts: Grease-free, Silicone-free
- Assembled in a clean room, Shipped and packed in double packaging
- 24 combinations are available.



- Can perform the clean air blow of small workpieces with a flow rate of up to 100 L/min

Made to order

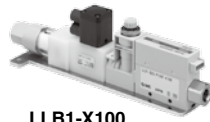

N₂ blow for the removal of lens dust

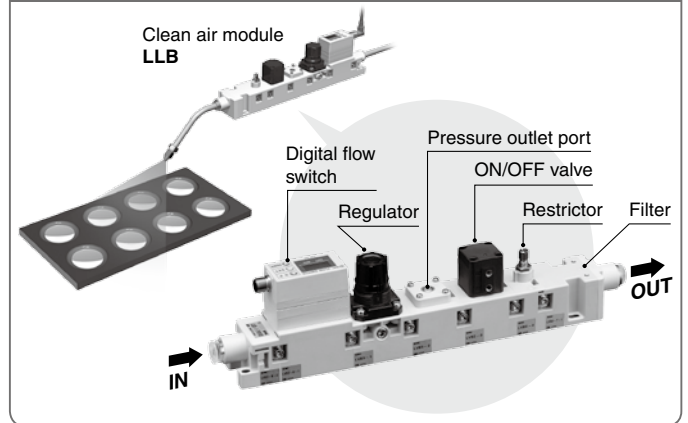

Bacteria Removal Filter/ Hollow Fiber Element SFDA



- Bacteria capture performance: LRV ≥ 9
Uses FDA/Food Sanitation Law compliant materials*1
*1 Parts in contact with fluid: Resin/Rubber
- Grease-free
- Contributes to the hygiene control of HACCP, etc., and FSSC22000 certification acquisition!
- Nominal filtration rating: 0.01 μm (Filtering efficiency: 99.99%)
- Initial pressure drop: 0.03 MPa (Inlet pressure 0.7 MPa, at max. flow rate)
- Flow rate: 500 L/min (ANR)



Clean One-touch Fittings for Blowing KP



- One-touch fittings for clean room blowing systems
- Completely oil-free (Fluoro-coated rubber portions)
- Wetted parts are non-metallic.
- Parts washed and assembled in a clean room, Packed in double packaging
- Can be used in a vacuum (-100 kPa)



Technical Data

Comparison Table (Thrust, Noise, Flow consumption, Air flow)

Pressure right before the nozzle: 0.2 MPa

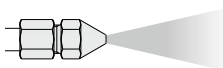
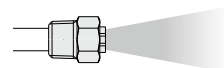
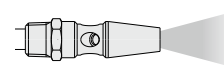
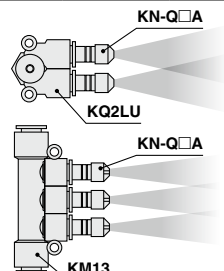
Pressure right before the nozzle: 0.2 MPa												
Mono-porous nozzle (KN series)				Low noise nozzle (KNS series)			High efficiency nozzle (KNH series)			Twin/Triple nozzle (KQ2LU, KM13 + KN-Q□A series)		
												
Thrust [N]	Nozzle diameter	Noise dB(A)	Flow consumption L/min (ANR)	Nozzle diameter x Number of nozzles	Noise dB(A)	Flow consumption L/min (ANR)	Nozzle diameter	Noise dB(A)	Air flow [Flow consumption L/min (ANR)]	Nozzle diameter x Number of nozzles	Noise dB(A)	Flow consumption L/min (ANR)
0.2	ø1	65	27									
0.3							ø1	76.2	103 [25]			
0.4										ø1 x 2	66.5	46
0.5	ø1.5	74	58	ø0.75 x 4	64	52						
0.6							ø1.5	81	169 [54]			
0.7										ø1 x 3	70	76
0.8				ø1.0 x 4	70	96						
0.9										ø1 x 4	69	93
1.0	ø2	81.8	105				ø2	88.6	220 [111]	ø1.5 x 2	77	112
1.3				ø0.9 x 8	71	133						
1.5	ø2.5	87.2	172							ø1.5 x 3	75.4	163
1.6												
1.9										ø2 x 2	83.4	205
2.0				ø1.1 x 8	77	237						
2.2												
2.3	ø3	91.7	220									
2.7										ø2.5 x 2	87.1	298
3.0												
3.1	ø3.5	95.6	337									
4.0	ø4	98.7	430							ø3 x 2	90.1	443
5.6												
9.0	ø6	104	1030									
16.3	ø8	109	1605									

Pressure right before the nozzle: 0.4 MPa

∴												
0.5	ø1	74.6	43				ø1	82	153 [41]			
0.8										ø1 x 2	75.3	78
0.9				ø0.75 x 4	72.6	87						
1.0	ø1.5	83	97									
1.1							ø1.5	90	231 [82]			
1.3										ø1 x 3	78.5	125
1.7				ø1.0 x 4	78.6	152				ø1 x 4	77.3	153
1.8												
1.9	ø2	91.4	176				ø2	91	308 [180]			
2.0										ø1.5 x 2	86	189
2.6				ø0.9 x 8	81.2	208						
2.7												
2.9	ø2.5	96.7	289							ø1.5 x 3	83.2	272
3.5												
3.6										ø2 x 2	93.5	338
4.0				ø1.1 x 8	87.6	391						
4.3												
4.4	ø3	101	363									
5.2										ø2.5 x 2	96.1	497
5.9	ø3.5	106	542									
6.4												
7.7	ø4	106	722							ø3 x 2	100	724
11.6												
17.6	ø6	110	1730									
30.9	ø8	112	3030									

Comparison Table (Thrust, Noise, Flow consumption, Air flow)

Pressure right before the nozzle: 0.6 MPa

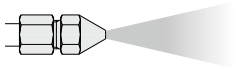
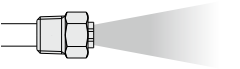
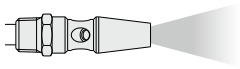
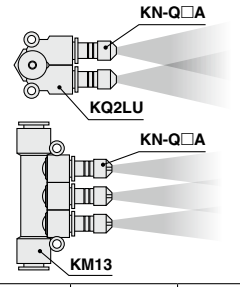
	Mono-porous nozzle (KN series)			Low noise nozzle (KNS series)			High efficiency nozzle (KNH series)			Twin/Triple nozzle (KQ2LU, KM13 + KN-Q□A series)		
												
Thrust [N]	Nozzle diameter	Noise dB(A)	Flow consumption L/min (ANR)	Nozzle diameter x Number of nozzles	Noise dB(A)	Flow consumption L/min (ANR)	Nozzle diameter	Noise dB(A)	Air flow [Flow consumption L/min (ANR)]	Nozzle diameter x Number of nozzles	Noise dB(A)	Flow consumption L/min (ANR)
∴												
0.7	ø1	79	60				ø1	84	202 [57]			
1.2										ø1 x 2	80	108
1.4				ø0.75 x 4	78	121						
1.5	ø1.5	86	135									
1.6							ø1.5	92	326 [125]			
1.9										ø1 x 3	83	177
2.3												
2.5				ø1.0 x 4	84	224				ø1 x 4	83	220
2.8							ø2	97	400 [253]			
2.9	ø2	95	243									
3.0										ø1.5 x 2	91	265
3.9				ø0.9 x 8	86	330						
4.1												
4.2										ø1.5 x 3	87	381
4.4	ø2.5	101	400									
5.3										ø2 x 2	98	475
5.4												
5.5												
5.9				ø1.1 x 8	93.1	554						
6.5	ø3	105	552									
7.6										ø2.5 x 2	100	694
8.7	ø3.5	109	771									
9.8												
11.1										ø3 x 2	103	1025
11.5	ø4	109	995									
17.5												
26.1	ø6	112	2430									
46.3	ø8	115	4320									

Energy Saving Program

- Allows you to perform various calculations necessary to improve the pneumatic energy saving
- Twenty different functions including air blow characteristics, pneumatics piping network, and combination of conductance
- Supports designing, current status analysis, and simulations for improvement



Model Selection

Recommended Circuit Configuration for Blowing

Optimization of an air blow system

For the optimization of an air blow system, it is important to make the ratio of the conductance of the components upstream and the conductance of the nozzle tip to the recommended value. By achieving this ratio, the system will allow high-pressure blow and flow rate reduction with a low pressure loss.

The conductance ratio recommended by SMC is 3:1 considering the energy-saving efficiency and installation cost.

* Conductance: Index of air flow ability

Optimization process

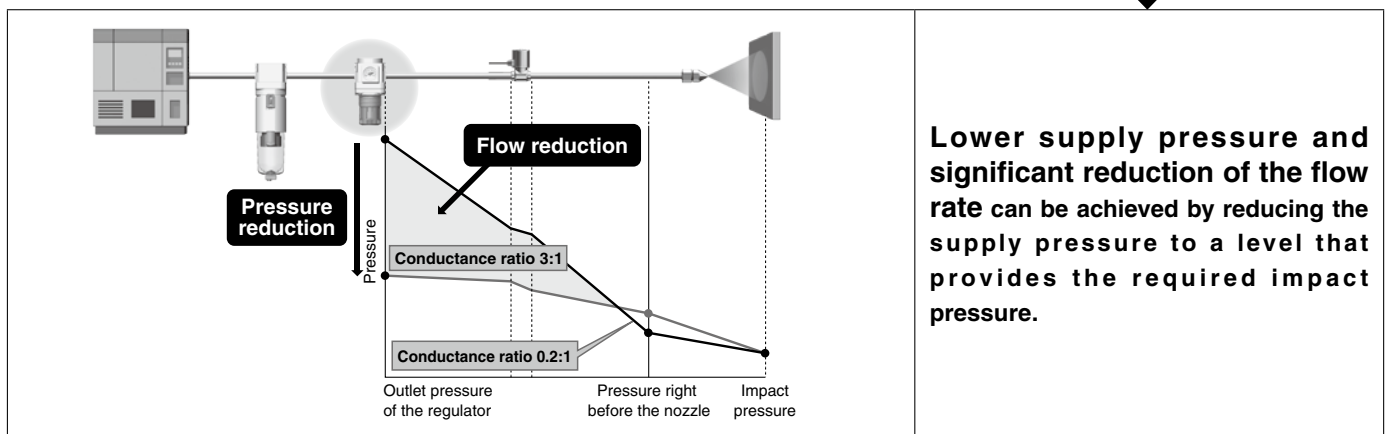
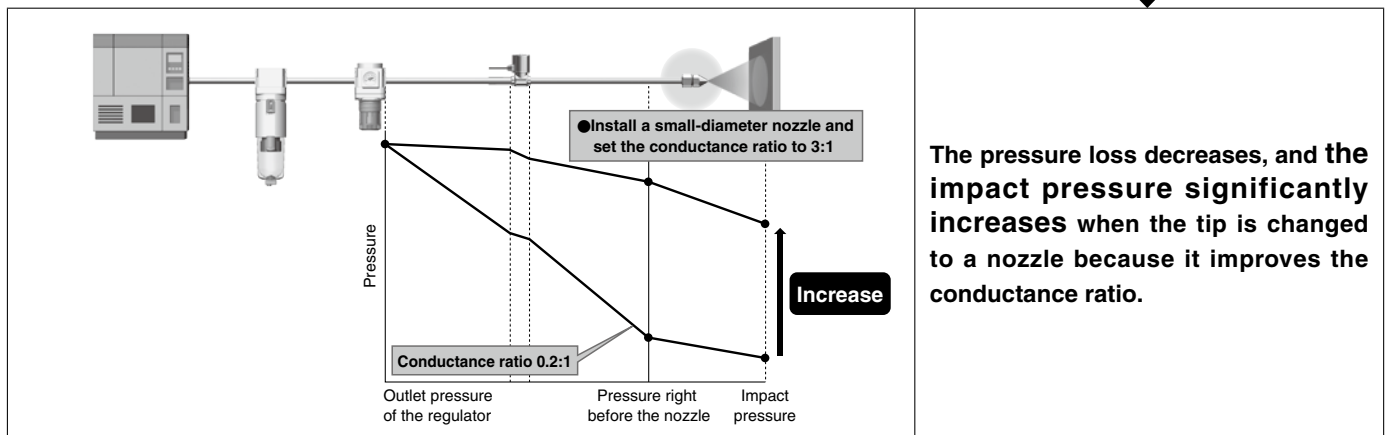
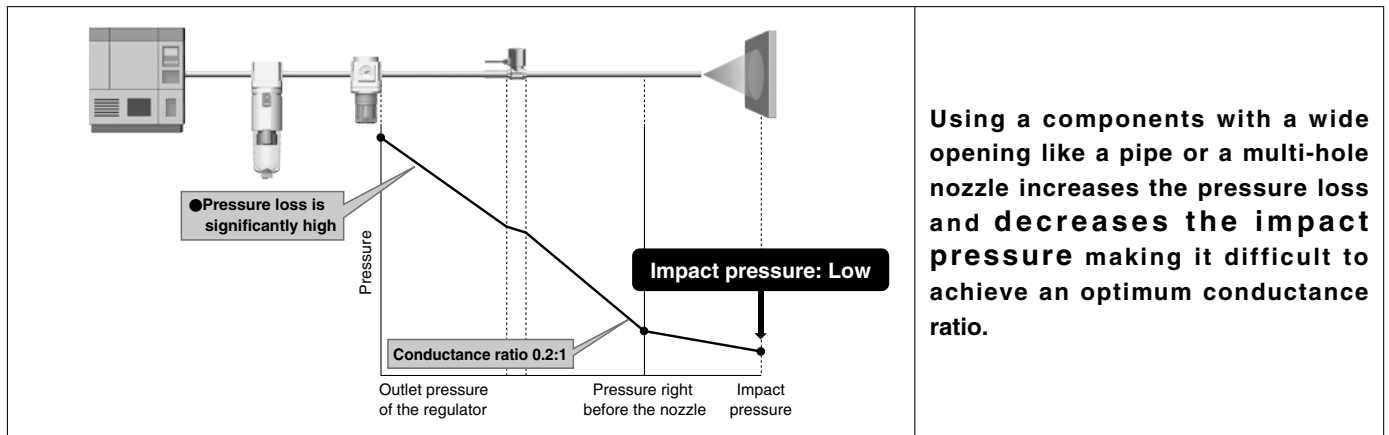

Optimization process complete

Piping lengths for conductance optimization

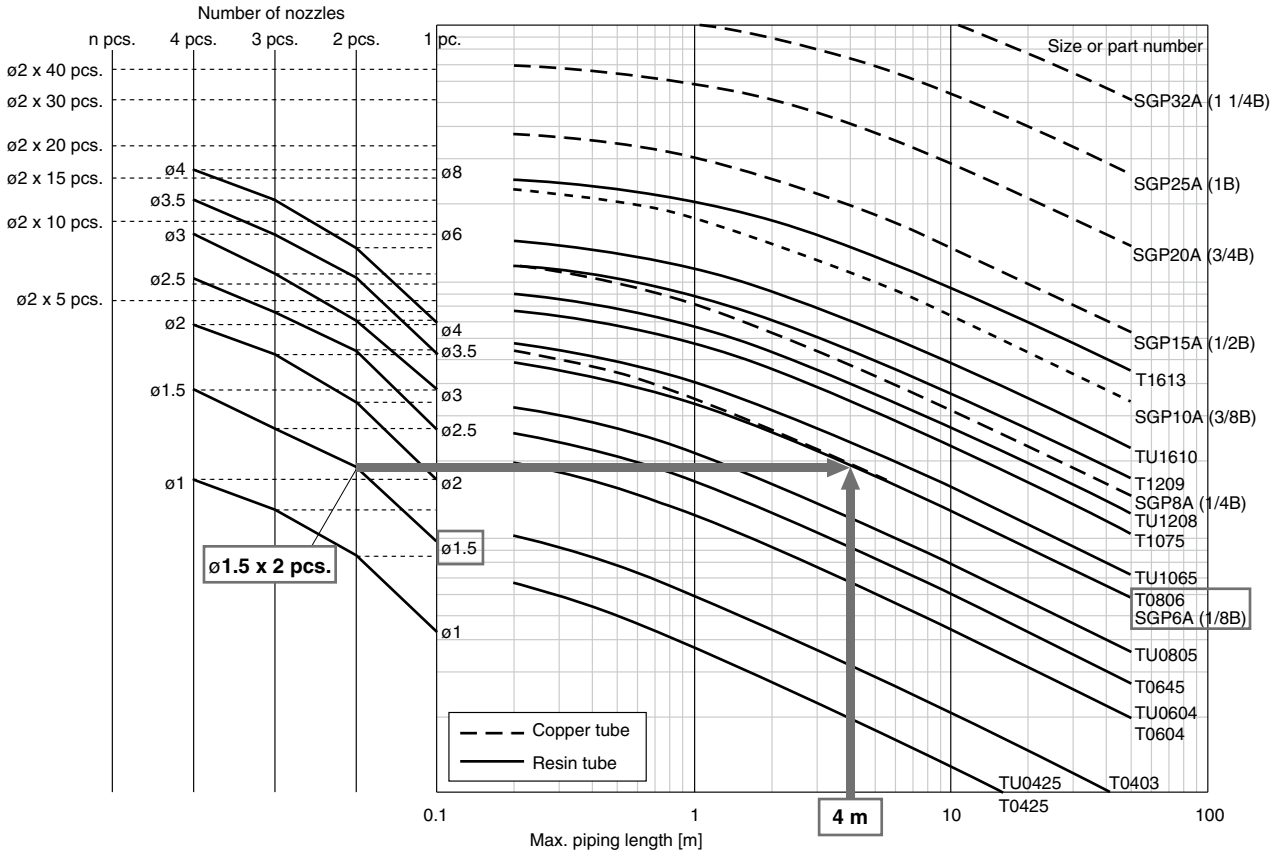

Optimization for 2-port valve with regulator model

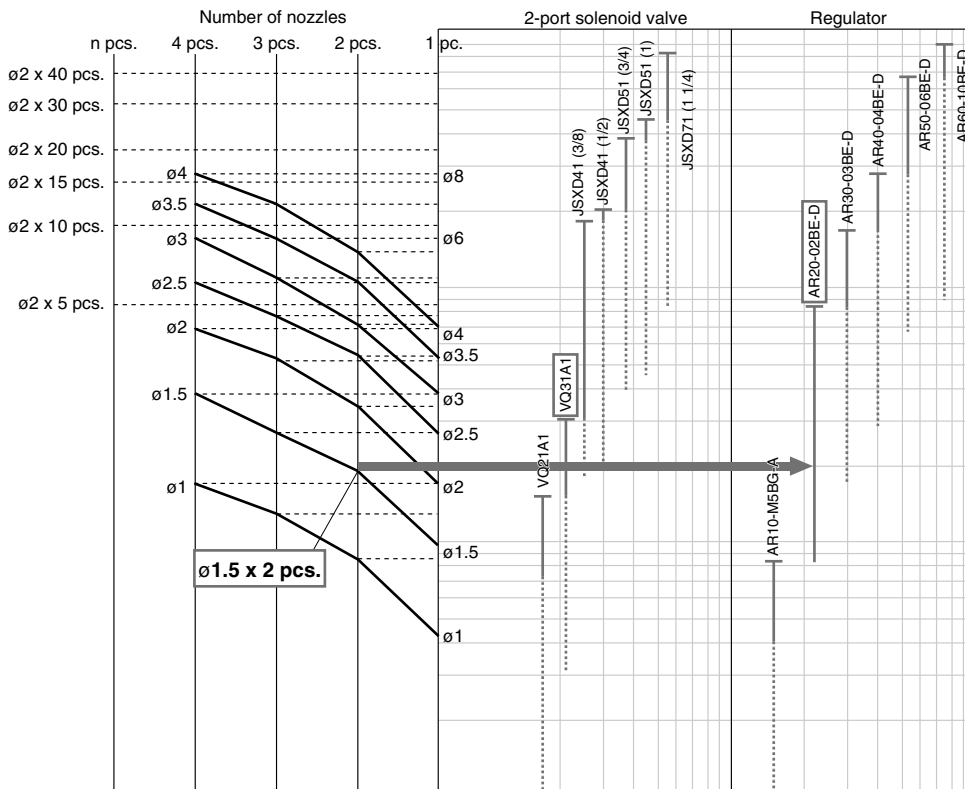

Glossary of Terms

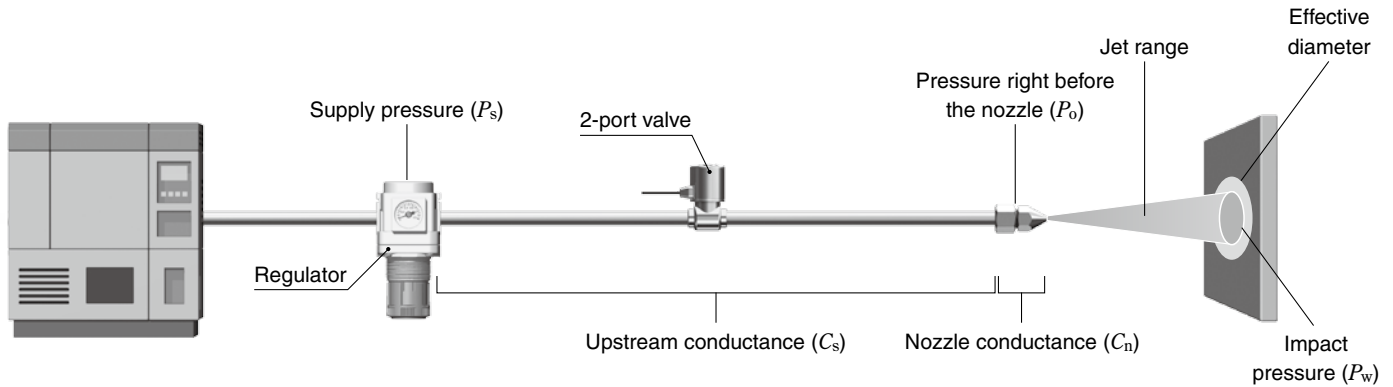

Term	Description
Pressure right before the nozzle (P_o)	The pressure right before the air is blown out from the nozzle. Pressure in the nozzle
Workpiece impact pressure (P_w)	Pressure when the air blown out of the nozzle collides with the workpiece
Conductance ratio	The ratio of conductance of the nozzle (C_n) and the upstream components (C_s) Setting the upstream side to 2 to 3 times the nozzle is recommended.
Pressure loss	Pressure loss of the supply pressure (difference between P_s and P_o) caused by the piping route. Lower pressure loss results in the better efficiency.
Jet range	Effective energy range inside the air that widens conically at the angle of 14 degrees from the nozzle opening
Effective diameter	The range in which the blowing effect is achieved in an area wider than the jet area
Potential core region	The range is equal to the nozzle diameter x 5. In this range, it interferes with the expansion thrust of the compressed air and the energy of the air blow cannot be used effectively.
Developing region	The range after the potential core region where the air blow thrust can be used effectively

* Conductance: Index of air flow ability

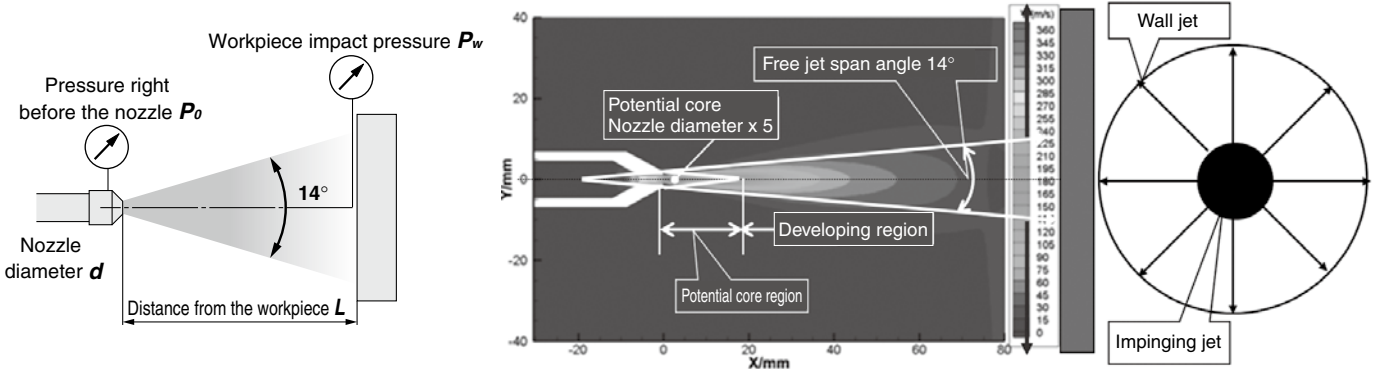

Air Blow System and Conductance

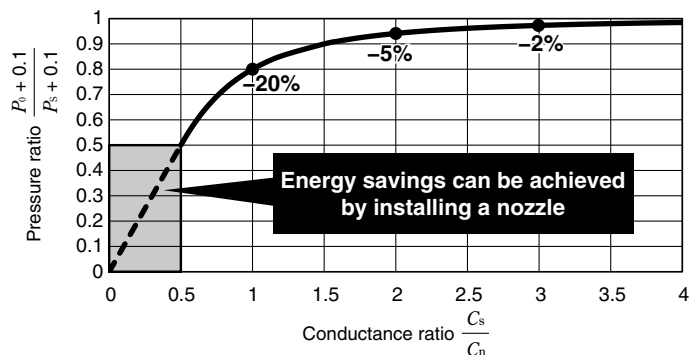
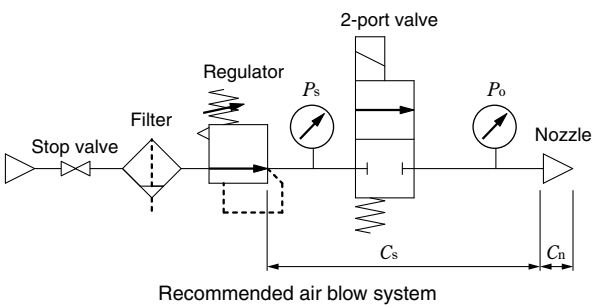



P_s : Supply pressure
 P_o : Pressure right before the nozzle
 C_s : Upstream conductance
 C_n : Nozzle conductance

} Pressure ratio $\frac{P_o + 0.1}{P_s + 0.1}$
 } Conductance ratio $\frac{C_s}{C_n}$

Safety Instructions

These safety instructions are intended to prevent hazardous situations and/or equipment damage. These instructions indicate the level of potential hazard with the labels of “**Caution**,” “**Warning**” or “**Danger**.” They are all important notes for safety and must be followed in addition to International Standards (ISO/IEC)*1), and other safety regulations.

 **Caution:** **Caution** indicates a hazard with a low level of risk which, if not avoided, could result in minor or moderate injury.

 **Warning:** **Warning** indicates a hazard with a medium level of risk which, if not avoided, could result in death or serious injury.

 **Danger :** **Danger** indicates a hazard with a high level of risk which, if not avoided, will result in death or serious injury.

*1) ISO 4414: Pneumatic fluid power – General rules relating to systems.
ISO 4413: Hydraulic fluid power – General rules relating to systems.
IEC 60204-1: Safety of machinery – Electrical equipment of machines.
(Part 1: General requirements)
ISO 10218-1: Manipulating industrial robots – Safety.
etc.

Warning

1. The compatibility of the product is the responsibility of the person who designs the equipment or decides its specifications.

Since the product specified here is used under various operating conditions, its compatibility with specific equipment must be decided by the person who designs the equipment or decides its specifications based on necessary analysis and test results. The expected performance and safety assurance of the equipment will be the responsibility of the person who has determined its compatibility with the product. This person should also continuously review all specifications of the product referring to its latest catalog information, with a view to giving due consideration to any possibility of equipment failure when configuring the equipment.

2. Only personnel with appropriate training should operate machinery and equipment.

The product specified here may become unsafe if handled incorrectly. The assembly, operation and maintenance of machines or equipment including our products must be performed by an operator who is appropriately trained and experienced.

3. Do not service or attempt to remove product and machinery/equipment until safety is confirmed.

1. The inspection and maintenance of machinery/equipment should only be performed after measures to prevent falling or runaway of the driven objects have been confirmed.
2. When the product is to be removed, confirm that the safety measures as mentioned above are implemented and the power from any appropriate source is cut, and read and understand the specific product precautions of all relevant products carefully.
3. Before machinery/equipment is restarted, take measures to prevent unexpected operation and malfunction.

4. Contact SMC beforehand and take special consideration of safety measures if the product is to be used in any of the following conditions.

1. Conditions and environments outside of the given specifications, or use outdoors or in a place exposed to direct sunlight.
2. Installation on equipment in conjunction with atomic energy, railways, air navigation, space, shipping, vehicles, military, medical treatment, combustion and recreation, or equipment in contact with food and beverages, emergency stop circuits, clutch and brake circuits in press applications, safety equipment or other applications unsuitable for the standard specifications described in the product catalog.
3. An application which could have negative effects on people, property, or animals requiring special safety analysis.
4. Use in an interlock circuit, which requires the provision of double interlock for possible failure by using a mechanical protective function, and periodical checks to confirm proper operation.

Caution

1. The product is provided for use in manufacturing industries.

The product herein described is basically provided for peaceful use in manufacturing industries.
If considering using the product in other industries, consult SMC beforehand and exchange specifications or a contract if necessary.
If anything is unclear, contact your nearest sales branch.

Limited warranty and Disclaimer/ Compliance Requirements

The product used is subject to the following “Limited warranty and Disclaimer” and “Compliance Requirements”.

Read and accept them before using the product.

Limited warranty and Disclaimer

1. The warranty period of the product is 1 year in service or 1.5 years after the product is delivered, whichever is first.*2)
Also, the product may have specified durability, running distance or replacement parts. Please consult your nearest sales branch.
2. For any failure or damage reported within the warranty period which is clearly our responsibility, a replacement product or necessary parts will be provided.
This limited warranty applies only to our product independently, and not to any other damage incurred due to the failure of the product.
3. Prior to using SMC products, please read and understand the warranty terms and disclaimers noted in the specified catalog for the particular products.

*2) Vacuum pads are excluded from this 1 year warranty.

A vacuum pad is a consumable part, so it is warranted for a year after it is delivered.
Also, even within the warranty period, the wear of a product due to the use of the vacuum pad or failure due to the deterioration of rubber material are not covered by the limited warranty.

Compliance Requirements

1. The use of SMC products with production equipment for the manufacture of weapons of mass destruction (WMD) or any other weapon is strictly prohibited.
2. The exports of SMC products or technology from one country to another are governed by the relevant security laws and regulations of the countries involved in the transaction. Prior to the shipment of a SMC product to another country, assure that all local rules governing that export are known and followed.

Caution

SMC products are not intended for use as instruments for legal metrology.

Measurement instruments that SMC manufactures or sells have not been qualified by type approval tests relevant to the metrology (measurement) laws of each country. Therefore, SMC products cannot be used for business or certification ordained by the metrology (measurement) laws of each country.

 **Safety Instructions** Be sure to read the “Handling Precautions for SMC Products” (M-E03-3) and “Operation Manual” before use.

SMC Corporation

Akihabara UDX 15F,
4-14-1, Sotokanda, Chiyoda-ku, Tokyo 101-0021, JAPAN
Phone: 03-5207-8249 Fax: 03-5298-5362
<https://www.smcworld.com>
© 2022 SMC Corporation All Rights Reserved

Specifications are subject to change without prior notice
and any obligation on the part of the manufacturer.

D-G

OSHA Standard Compliant Nozzle for One-touch Fitting

New

RoHS

Resin type



Stainless steel type

Fluid temperature

Max. 150°C

Compliant with OSHA Standard 1910.242(B)

The structure prevents closing of the discharge port. This is a safety design that limits the pressure to 30 psi even when an operator is touching the nozzle. (Operating pressure: 0.5 MPa or less)

Energy saving of air blowing

CO₂ emissions (Air consumption)

42% reduction

Significantly lowers the air consumption in comparison to a comb-shaped nozzle with a comparable blowing range.

* Compared at the same impact pressure

Low noise

Max. 8 dB(A) reduction

Lower noise than a nozzle with male thread when the impact pressure is the same

* When the impact pressure is 5 kPa

KNA nozzle

KNA(G)-Q10-180

76 dB(A)

Existing model

Nozzle for One-touch fitting
(Resin type)

KN-Q10A-200

84 dB(A)

Application Examples

Removal of foreign matter across a wide area

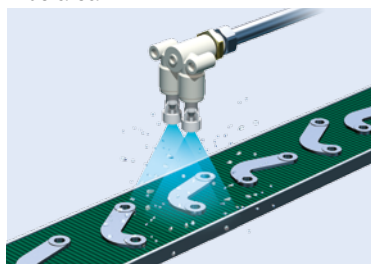

Cooling of workpieces

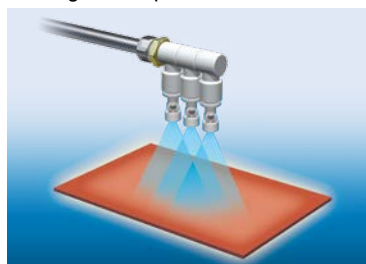

Blowing air on food products
(Stainless steel type)

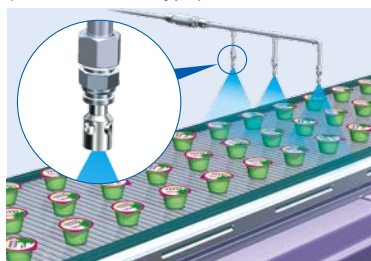

Connects to a restrictor (AS-X21, X214)
to allow flow rate adjustment at the nozzle

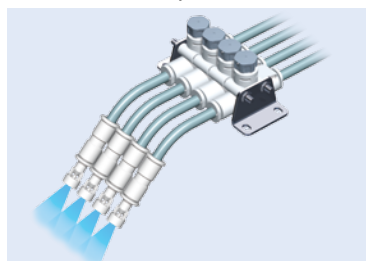

Applicable One-touch Fittings

One-touch Fittings

KQ2 Series



Rotary One-touch Fittings

KS/KX Series



Self-seal Fittings

KC Series



Piping Module

KB Series



Stainless Steel
One-touch Fittings

KG Series



Clean One-touch Fittings
for Blowing

KP Series



Metal One-touch Fittings

KQB2 Series



Stainless Steel 316 One-touch
Fittings

KQG2 Series



* Please use the product in accordance with the specifications provided in the catalogs/operation manuals. It is your responsibility to check the suitability for your workpiece and equipment.

KNA(G)-Q10-180



CAT.ES50-44A

OSHA Standard Compliant Nozzle for One-touch Fitting *KNA(G)-Q10-180*

Energy saving by improving the nozzle (reduction of compressed air)

The CO₂ emissions for total blowing hours per year (7000 h) when the KNA series is used is 12.2 t, compared to 20.8 t when a comb-shaped nozzle is used. This is a reduction of 42% (8.6 t).

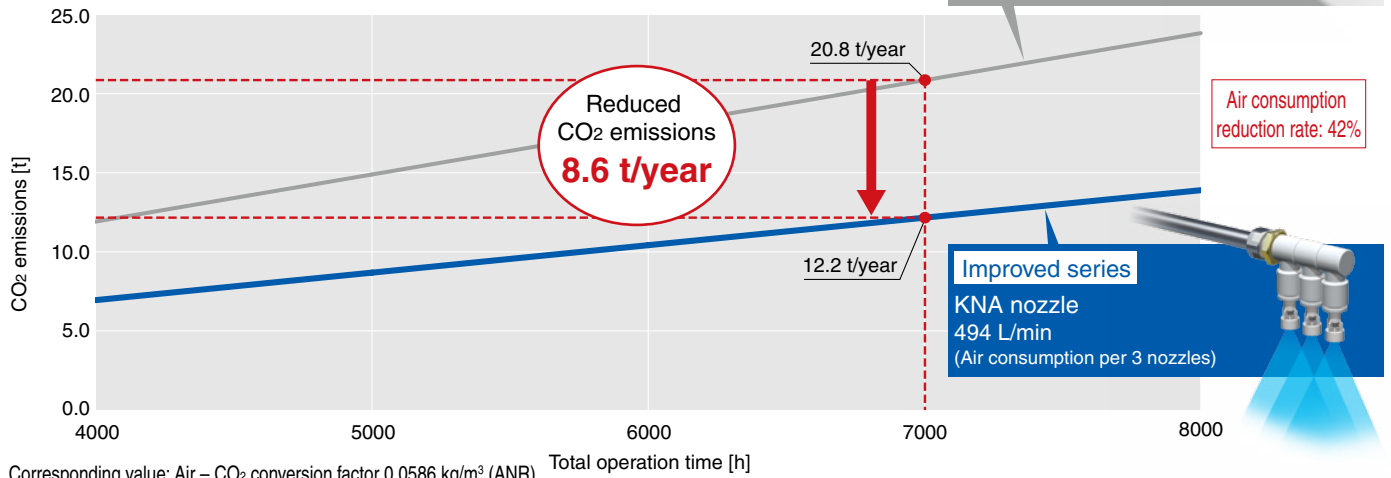

Corresponding value: Air – CO₂ conversion factor 0.0586 kg/m³ (ANR)

[Installation example]

	Existing series	Improved series
Nozzle series	Comb-shaped nozzle	KNA-Q10-180
Installation quantity (piece/line)	10	30
Installation quantity (line)	10	10

[Calculation conditions]

Blowing distance	80 mm
Impact pressure	10 kPa

[Work model]

Blow time	10 s/cycle
Frequency	12 cycles/h
Operating hours	10 h/day
Operating days	210 days/year
Total operation time per year	7000 h/year

* Compared at the same impact pressure

Adjustable layout to match application

Twin Nozzle

Branch male elbow
KQ2LU

Branch "Y"
KQ2U

Triple Nozzle

Triple universal male elbow
KQ2VT

Water-resistant Type

Stainless steel 316
One-touch fitting
KQG2U

Bar Type Nozzle

Female elbow
KQ2LF

Universal female elbow
KQ2VF

Male elbow
KQ2L

⚠ Caution

If the KNA series nozzle is used with a non-SMC fitting, it may come off, posing a serious risk to the user. It is recommended to use an SMC One-touch fitting with this product. Before operation, check that the nozzle is securely attached to the One-touch fitting and will not fall off. Refer to the **Web Catalog** for details on fittings.

OSHA Standard Compliant Nozzle for One-touch Fitting

RoHS

KNA(G)-Q10-180

Specifications

Model	KNA-Q10-180	KNAG-Q10-180
Material	PBT	Stainless steel 316
Fluid	Air	
Max. operating pressure	1 MPa	
Ambient and fluid temperatures	-5 to 60°C (No freezing)	-5 to 150°C (No freezing)
Nozzle diameter	Equivalent to $\phi 1.8$	
Weight	3 g	17 g
Applicable One-touch fitting size	$\phi 10$	



Resin type



Stainless steel type

Applicable One-touch Fittings

Series	Nozzle	
	Resin	Stainless steel
One-touch Fittings		
KQ2 Series	○	—
Rotary One-touch Fittings		
KS/KX Series	○	—
Self-seal Fittings		
KC Series	○	—
Piping Module		
KB Series	○	—
Stainless Steel One-touch Fittings		
KG Series	○	—
Clean One-touch Fittings for Blowing		
KP Series	○	—
Metal One-touch Fittings		
KQB2 Series	○	○
Stainless Steel 316 One-touch Fittings		
KQG2 Series	○	○

Dimensions

KNA-Q10-180/Resin type

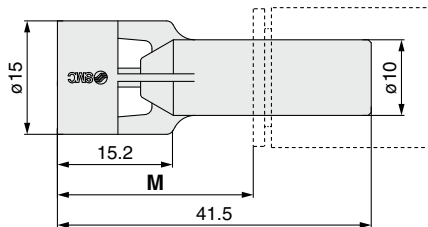

KNAG-Q10-180/Stainless steel type

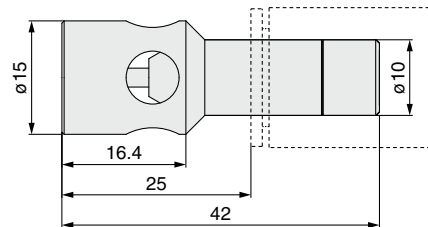

M	Applicable One-touch fitting							
	KQ2	KS/KX	KC	KB	KG	KP	KQB2	KQG2
M	25.9	20.5	17.5	20.5	20.5	18.5	24.5	24.5

⚠ Caution

If the KNA series nozzle is used with a non-SMC fitting, it may come off, posing a serious risk to the user. It is recommended to use an SMC One-touch fitting with this product. Before operation, check that the nozzle is securely attached to the One-touch fitting and will not fall off. Refer to the **Web Catalog** for details on fittings.

⚠ Specific Product Precautions

Be sure to read this before handling the products. Refer to the operation manual for safety instructions and other specific product precautions.

Design / Selection

⚠ Warning

1. Do not close the discharge port on the product side.

A discharge port is provided on the product side of the nozzle for safety to prevent pressure increase even when the nozzle outlet is closed.

This conforms to the OSHA Standard (1910.242(B))

(Limiting the pressure to 30 psi (0.21 MPa) or less when used with pressure of 0.5 MPa or less)

When the discharge port is closed, the pressure may increase above the standard value, and it may not be used safely.

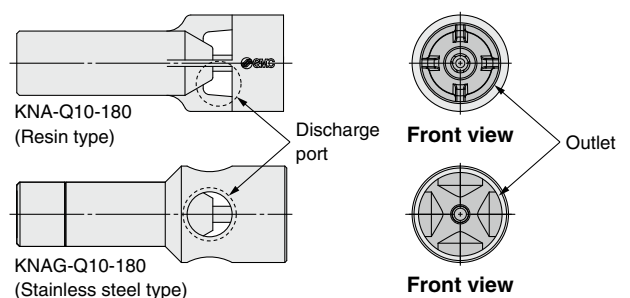

Safety Instructions

These safety instructions are intended to prevent hazardous situations and/or equipment damage. These instructions indicate the level of potential hazard with the labels of “**Caution**,” “**Warning**” or “**Danger**.” They are all important notes for safety and must be followed in addition to International Standards (ISO/IEC)*1), and other safety regulations.

 **Caution:** **Caution** indicates a hazard with a low level of risk which, if not avoided, could result in minor or moderate injury.

 **Warning:** **Warning** indicates a hazard with a medium level of risk which, if not avoided, could result in death or serious injury.

 **Danger :** **Danger** indicates a hazard with a high level of risk which, if not avoided, will result in death or serious injury.

*1) ISO 4414: Pneumatic fluid power – General rules relating to systems.
ISO 4413: Hydraulic fluid power – General rules relating to systems.
IEC 60204-1: Safety of machinery – Electrical equipment of machines.
(Part 1: General requirements)
ISO 10218-1: Manipulating industrial robots – Safety.
etc.

Warning

1. The compatibility of the product is the responsibility of the person who designs the equipment or decides its specifications.

Since the product specified here is used under various operating conditions, its compatibility with specific equipment must be decided by the person who designs the equipment or decides its specifications based on necessary analysis and test results. The expected performance and safety assurance of the equipment will be the responsibility of the person who has determined its compatibility with the product. This person should also continuously review all specifications of the product referring to its latest catalog information, with a view to giving due consideration to any possibility of equipment failure when configuring the equipment.

2. Only personnel with appropriate training should operate machinery and equipment.

The product specified here may become unsafe if handled incorrectly. The assembly, operation and maintenance of machines or equipment including our products must be performed by an operator who is appropriately trained and experienced.

3. Do not service or attempt to remove product and machinery/equipment until safety is confirmed.

1. The inspection and maintenance of machinery/equipment should only be performed after measures to prevent falling or runaway of the driven objects have been confirmed.
2. When the product is to be removed, confirm that the safety measures as mentioned above are implemented and the power from any appropriate source is cut, and read and understand the specific product precautions of all relevant products carefully.
3. Before machinery/equipment is restarted, take measures to prevent unexpected operation and malfunction.

4. Contact SMC beforehand and take special consideration of safety measures if the product is to be used in any of the following conditions.

1. Conditions and environments outside of the given specifications, or use outdoors or in a place exposed to direct sunlight.
2. Installation on equipment in conjunction with atomic energy, railways, air navigation, space, shipping, vehicles, military, medical treatment, combustion and recreation, or equipment in contact with food and beverages, emergency stop circuits, clutch and brake circuits in press applications, safety equipment or other applications unsuitable for the standard specifications described in the product catalog.
3. An application which could have negative effects on people, property, or animals requiring special safety analysis.
4. Use in an interlock circuit, which requires the provision of double interlock for possible failure by using a mechanical protective function, and periodical checks to confirm proper operation.

Caution

1. The product is provided for use in manufacturing industries.

The product herein described is basically provided for peaceful use in manufacturing industries.
If considering using the product in other industries, consult SMC beforehand and exchange specifications or a contract if necessary.
If anything is unclear, contact your nearest sales branch.

Limited warranty and Disclaimer/ Compliance Requirements

The product used is subject to the following “Limited warranty and Disclaimer” and “Compliance Requirements”.

Read and accept them before using the product.

Limited warranty and Disclaimer

1. The warranty period of the product is 1 year in service or 1.5 years after the product is delivered, whichever is first.*2)
Also, the product may have specified durability, running distance or replacement parts. Please consult your nearest sales branch.
2. For any failure or damage reported within the warranty period which is clearly our responsibility, a replacement product or necessary parts will be provided.
This limited warranty applies only to our product independently, and not to any other damage incurred due to the failure of the product.
3. Prior to using SMC products, please read and understand the warranty terms and disclaimers noted in the specified catalog for the particular products.

*2) Vacuum pads are excluded from this 1 year warranty.

A vacuum pad is a consumable part, so it is warranted for a year after it is delivered.
Also, even within the warranty period, the wear of a product due to the use of the vacuum pad or failure due to the deterioration of rubber material are not covered by the limited warranty.

Compliance Requirements

1. The use of SMC products with production equipment for the manufacture of weapons of mass destruction (WMD) or any other weapon is strictly prohibited.
2. The exports of SMC products or technology from one country to another are governed by the relevant security laws and regulations of the countries involved in the transaction. Prior to the shipment of a SMC product to another country, assure that all local rules governing that export are known and followed.

Caution

SMC products are not intended for use as instruments for legal metrology.

Measurement instruments that SMC manufactures or sells have not been qualified by type approval tests relevant to the metrology (measurement) laws of each country. Therefore, SMC products cannot be used for business or certification ordained by the metrology (measurement) laws of each country.

 **Safety Instructions** Be sure to read the “Handling Precautions for SMC Products” (M-E03-3) and “Operation Manual” before use.

SMC Corporation

Akihabara UDX 15F,
4-14-1, Sotokanda, Chiyoda-ku, Tokyo 101-0021, JAPAN
Phone: 03-5207-8249 Fax: 03-5298-5362
<https://www.smcworld.com>
© 2023 SMC Corporation All Rights Reserved

Specifications are subject to change without prior notice and any obligation on the part of the manufacturer.

D-G