

2 Phase Stepper Motor

Guide Rod Type

Without Motor Brake

Series LXP

Ball Bushing

Ball Screw
 $\varnothing 8\text{mm}/2\text{mm lead}$

How to Order

LXPB2 **BC** - Stroke **S** - F9N **1**

Home position switch

Nil	None
S	Yes (cable length 0.3m)

Auto switch type

Nil	None
-----	------

Refer to the table on the right for auto switch part numbers.

Number of auto switches

1	1 pc.
2	2 pcs.
⋮	⋮
6	6 pcs.

Auto switch types

Symbol	Model	Wiring/ Output type	Lead wire length (m)	Contact
Nil	Without auto switch			
F9N	D-F9N	3 wire/NPN	0.5	N.O. (A contact)
F9P	D-F9P	3 wire/PNP	0.5	N.O. (A contact)
F9G	D-F9G	3 wire/NPN	0.5	N.C. (B contact)
F9H	D-F9H	3 wire/PNP	0.5	N.C. (B contact)
F9GL	D-F9GL	3 wire/NPN	3	N.C. (B contact)
F9HL	D-F9HL	3 wire/PNP	3	N.C. (B contact)
F9B	D-F9B	2 wire	0.5	N.O. (A contact)
F9NL	D-F9NL	3 wire/NPN	3	N.O. (A contact)
F9PL	D-F9PL	3 wire/PNP	3	N.O. (A contact)
F9BL	D-F9BL	2 wire	3	N.O. (A contact)

Specifications

		Standard stroke	mm	50	75	100	125	150	175	200
Performance	Body weight	kg		2.0	2.2	2.3	2.6	2.8	2.9	3.1
	Operating temperature range	°C	5 to 40 (with no condensation)							
	Work load	kg	6 horizontal/5 vertical <small>Note 1)</small>							
	Speed	mm/s	to 30 <small>Note 2)</small>							
	Positioning repeatability	mm	±0.03							
Main parts	Motor	2 phase stepper motor (without brake)								
	Lead screw	Ball screw $\varnothing 8\text{mm}$, 2mm lead								
	Guide	Ball bushing								
Home position switch	Model	Photo micro sensor EE-SX673								
Driver	Model	LC6D-220AD (Refer to page 306 for details.)								
Positioning driver	Model	LC6C-220AD (Refer to page 309 for details.)								

Note 1) Based on the operating conditions, establish a separate guide when exceeding the maximum allowable lateral load.

Note 2) Since vibration may increase with low speed operation, use 2mm/s or more as a guide for speed.

Operating Conditions

Allowable lateral load (F)

Stroke	Load (N)
50	42
75	42
100	40
125	42
150	32
175	24
200	17

Allowable plate rotation torque (T)

Stroke	Torque (N.m)
50	2.87
75	2.47
100	2.17
125	2.38
150	2.16
175	1.98
200	1.82

Plate non-rotating accuracy (θ)

Non-rotating accuracy (θ)
±0.09°

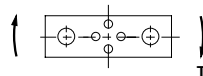
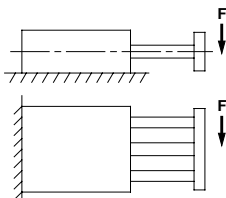
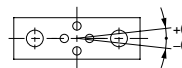

Refer to page 304 for deflection data.

Dimensions/LXPB2BC

Scale: 30%

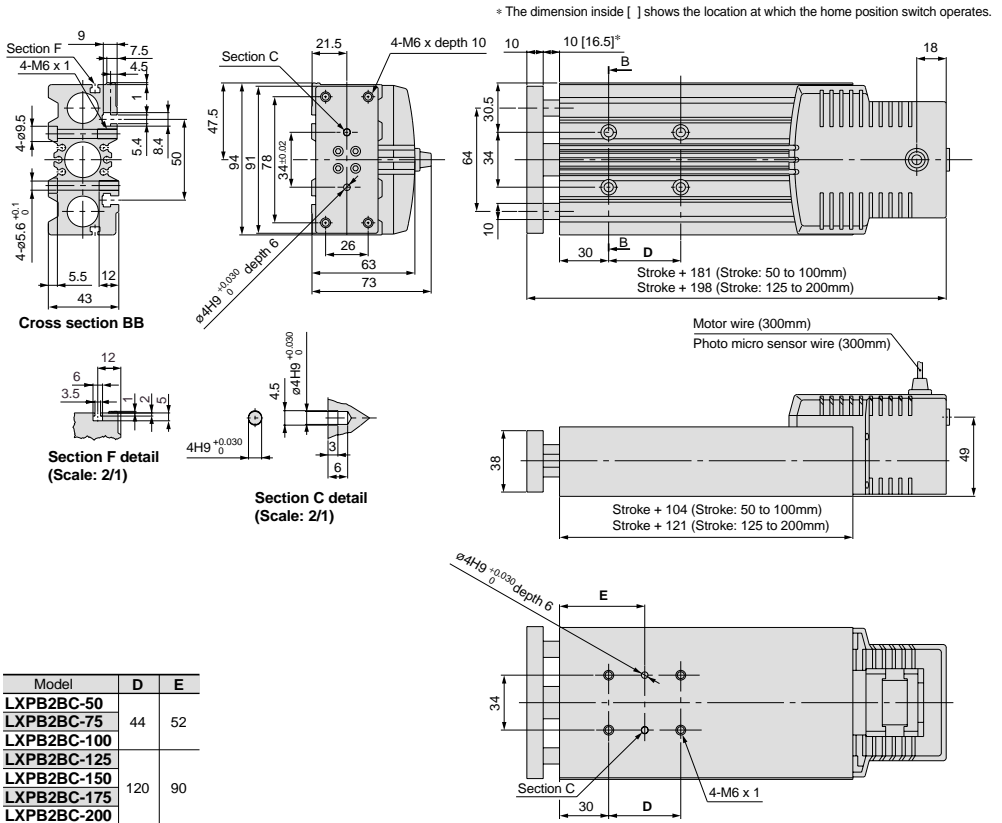

Refer to page 300 for mounting.

Positioning Time Guide (for Horizontal Mount)

For transfer load of 0kg

		Positioning time (sec)				
		1	10	50	100	200
Speed (mm/s)	10	0.2	1.1	5.1	10.1	20.1
	20	0.1	0.6	2.6	5.1	10.1
	30	0.1	0.4	1.7	3.4	6.7

For transfer load of 6kg

		Positioning time (sec)				
		1	10	50	100	200
Speed (mm/s)	10	0.2	1.1	5.1	10.1	20.1
	20	0.1	0.6	2.6	5.1	10.1
	30	0.1	0.4	1.7	3.4	6.7

For transfer load of 3kg

		Positioning time (sec)				
		1	10	50	100	200
Speed (mm/s)	10	0.2	1.1	5.1	10.1	20.1
	20	0.7	0.6	2.6	5.1	10.1
	30	0.1	0.4	1.7	3.4	6.7

Refer to page 303 for acceleration time.

2 Phase Stepper Motor

Without Motor Brake

Guide Rod Type

Series LXP

Ball Bushing

Ball Screw
 $\varnothing 8\text{mm}/5\text{mm lead}$

How to Order

LXPB2 **BD** - Stroke **S** - F9N **1**

Home position switch

Nil	None
S	Yes (cable length 0.3m)

Auto switch type

Nil	None
-----	------

Refer to the table on the right for auto switch part numbers.

Number of auto switches

1	1 pc.
2	2 pcs.
⋮	⋮
6	6 pcs.

Auto switch types

Symbol	Model	Wiring/ Output type	Lead wire length (m)	Contact
Nil	Without auto switch			
F9N	D-F9N	3 wire/NPN	0.5	N.O. (A contact)
F9P	D-F9P	3 wire/PNP	0.5	N.O. (A contact)
F9G	D-F9G	3 wire/NPN	0.5	N.C. (B contact)
F9H	D-F9H	3 wire/PNP	0.5	N.C. (B contact)
F9GL	D-F9GL	3 wire/NPN	3	N.C. (B contact)
F9HL	D-F9HL	3 wire/PNP	3	N.C. (B contact)
F9B	D-F9B	2 wire	0.5	N.O. (A contact)
F9NL	D-F9NL	3 wire/NPN	3	N.O. (A contact)
F9PL	D-F9PL	3 wire/PNP	3	N.O. (A contact)
F9BL	D-F9BL	2 wire	3	N.O. (A contact)

Specifications

Standard stroke		mm	50	75	100	125	150	175	200	
Performance	Body weight	kg	2.0	2.2	2.3	2.6	2.8	2.9	3.1	
	Operating temperature range	°C	5 to 40 (with no condensation)							
	Work load	kg	6 horizontal/5 vertical <small>Note 1)</small>							
	Speed	mm/s	to 80 <small>Note 2)</small>							
	Positioning repeatability	mm	±0.03							
Main parts	Motor	2 phase stepper motor (without brake)								
	Lead screw	Ball screw $\varnothing 8\text{mm}$, 5mm lead								
	Guide	Ball bushing								
Home position switch	Model	Photo micro sensor EE-SX673								
Driver	Model	LC6D-220AD (Refer to page 306 for details.)								
Positioning driver	Model	LC6C-220AD (Refer to page 309 for details.)								

Note 1) Based on the operating conditions, establish a separate guide when exceeding the maximum allowable lateral load.

Note 2) Since vibration may increase with low speed operation, use 5mm/s or more as a guide for speed.

Operating Conditions

Allowable lateral load (F)

Stroke	Load (N)
50	42
75	42
100	40
125	42
150	32
175	24
200	17

Allowable plate rotation torque (T)

Stroke	Torque (N·m)
50	2.87
75	2.47
100	2.17
125	2.38
150	2.16
175	1.98
200	1.82

Plate non-rotating accuracy (θ)

Non-rotating accuracy (θ)
±0.09°

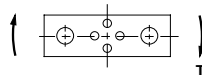
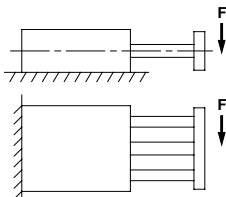
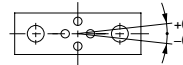

Refer to page 304 for deflection data.

Dimensions/LXPB2BD

Scale: 30%

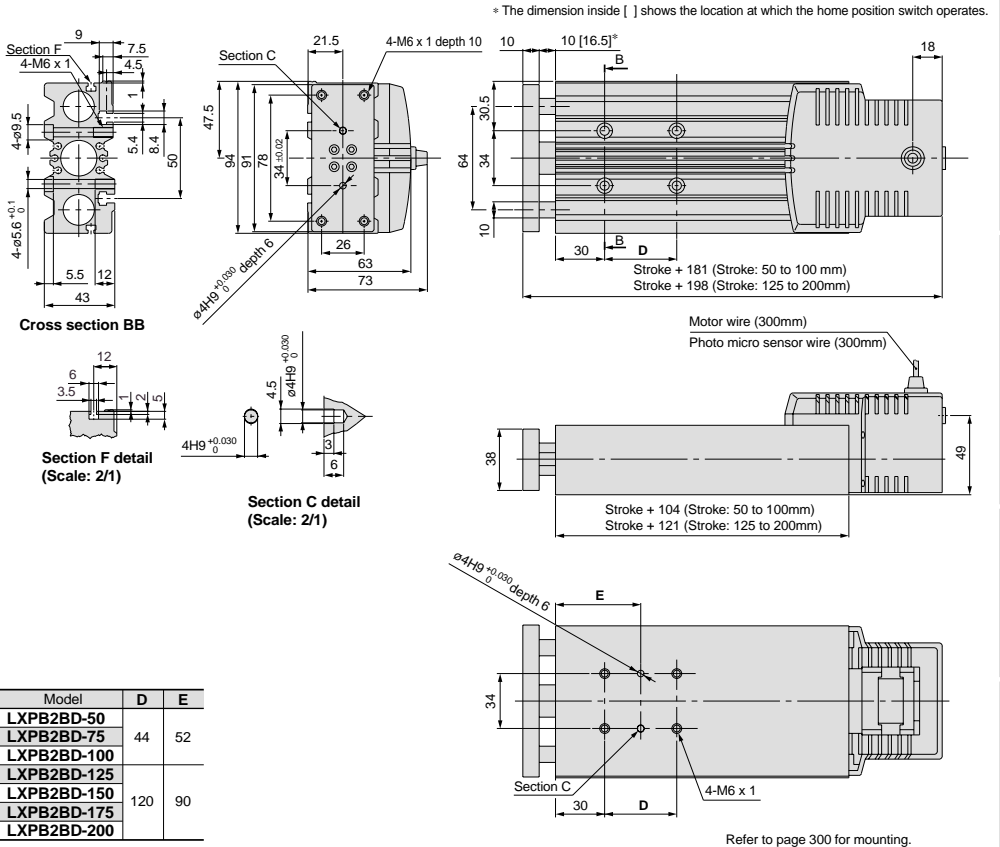

Positioning Time Guide (for Horizontal Mount)

For transfer load of 0kg

Positioning distance (mm)		Positioning time (sec)				
		1	10	50	100	200
Speed (mm/s)	10	0.2	1.1	5.1	10.1	20.1
	40	0.1	0.3	1.3	2.6	5.1
	80	0.1	0.2	0.7	1.3	2.6

For transfer load of 6kg

Positioning distance (mm)		Positioning time (sec)				
		1	10	50	100	200
Speed (mm/s)	10	0.2	1.1	5.1	10.1	20.1
	40	0.1	0.3	1.3	2.6	5.1
	80	0.1	0.2	0.7	1.3	2.6

For transfer load of 3kg

Positioning distance (mm)		Positioning time (sec)				
		1	10	50	100	200
Speed (mm/s)	10	0.2	1.1	5.1	10.1	20.1
	40	0.1	0.3	1.3	2.6	5.1
	80	0.1	0.2	0.7	1.3	2.6

Refer to page 303 for acceleration time.

2 Phase Stepper Motor

With Motor Brake

Guide Rod Type

Series LXP

Ball Bushing

Ball Screw
ø8mm/2mm lead

How to Order

LXPB2 **BC** — Stroke **S** B — **F9N** **1**

Home position switch

Nil	None
S	Yes (cable length 0.3m)

Auto switch type

Nil	None
-----	------

Refer to the table on the right for auto switch part numbers.

Number of auto switches

1	1 pc.
2	2 pcs.
⋮	⋮
6	6 pcs.

Auto switch types

Symbol	Model	Wiring/ Output type	Lead wire length (m)	Contact
Nil	Without auto switch			
F9N	D-F9N	3 wire/NPN	0.5	N.O. (A contact)
F9P	D-F9P	3 wire/PNP	0.5	N.O. (A contact)
F9G	D-F9G	3 wire/NPN	0.5	N.C. (B contact)
F9H	D-F9H	3 wire/PNP	0.5	N.C. (B contact)
F9GL	D-F9GL	3 wire/NPN	3	N.C. (B contact)
F9HL	D-F9HL	3 wire/PNP	3	N.C. (B contact)
F9B	D-F9B	2 wire	0.5	N.O. (A contact)
F9NL	D-F9NL	3 wire/NPN	3	N.O. (A contact)
F9PL	D-F9PL	3 wire/PNP	3	N.O. (A contact)
F9BL	D-F9BL	2 wire	3	N.O. (A contact)

Specifications

Standard stroke		mm	50	75	100	125	150	175	200	
Performance	Body weight	kg	2.2	2.4	2.5	2.8	3.0	3.1	3.3	
	Operating temperature range	°C	5 to 40 (with no condensation)							
	Work load	kg	6 horizontal/5 vertical (Note 1)							
	Speed	mm/s	to 30 (Note 2)							
	Positioning repeatability	mm	±0.03							
Main parts	Motor	2 phase stepper motor (with brake)								
	Lead screw	Ball screw ø8mm, 2mm lead								
	Guide	Ball bushing								
	Electromagnetic brake	Model	De-energized operating type							
		Static torque	0.1N·m or more							
Rated voltage		24VDC ±5%								
	Power consumption	5W								
Home position switch	Model	Photo micro sensor EE-SX673								
Driver	Model	LC6D-220AD (Refer to page 306 for details.)								
Positioning driver	Model	LC6C-220AD (Refer to page 309 for details.)								

Note 1) Based on the operating conditions, establish a separate guide when exceeding the maximum allowable lateral load.

Note 2) Since vibration may increase with low speed operation, use 2mm/s or more as a guide for speed.

Lifter Operation Range

This is the operating range for ball bushings. Use within the allowable thrust range.

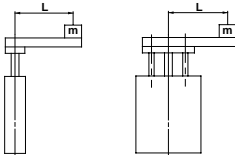

50 to 200mm stroke

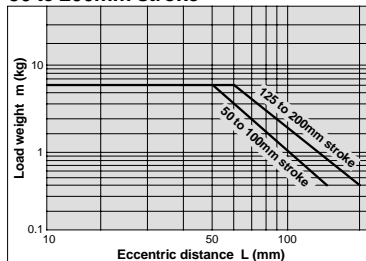

Operating Conditions

Allowable lateral load (F)

Stroke	Load (N)
50	42
75	42
100	40
125	42
150	32
175	24
200	17

Allowable plate rotation torque (T)

Stroke	Torque (N·m)
50	2.87
75	2.47
100	2.17
125	2.38
150	2.16
175	1.98
200	1.82

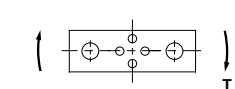
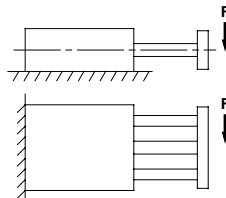
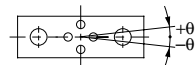

Plate non-rotating accuracy (θ)

Non-rotating accuracy (θ)
±0.09°



Refer to page 304 for deflection data.

Dimensions/LXPB2BC

Scale: 30%

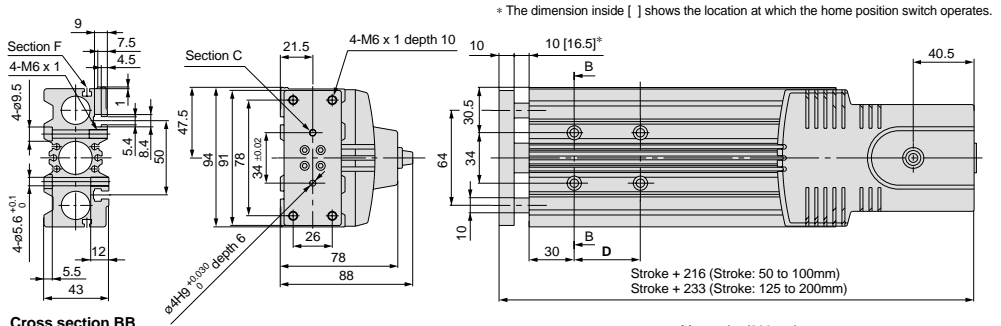

Cross section BB

Brake electrical circuit

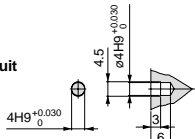
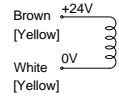

Section C detail (Scale: 2/1)

Motor wire (300mm)
Brake wire (300mm)
Photo micro sensor wire (300mm)

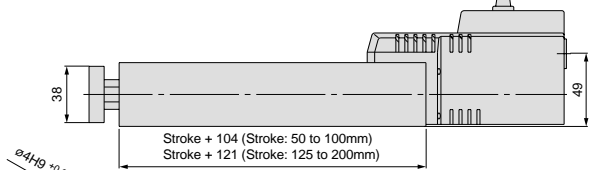

Note) A contact protection circuit is required when connecting a brake.

Model	D	E
LXPB2BC-50	44	52
LXPB2BC-75		
LXPB2BC-100		
LXPB2BC-125		
LXPB2BC-150	120	90
LXPB2BC-175		
LXPB2BC-200		

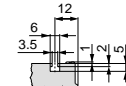

Section F detail (Scale: 2/1)

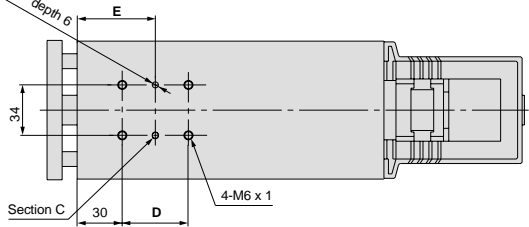

Refer to page 300 for mounting.

Positioning Time Guide (for Vertical Mount)

For transfer load of 0kg

Positioning distance (mm)	Positioning time (sec)					
	1	10	50	100	200	
Speed (mm/s)	10	0.2	1.1	5.1	10.1	20.1
	20	0.1	0.6	2.6	5.1	10.1
	30	0.1	0.4	1.7	3.4	6.7

For transfer load of 5kg

Positioning distance (mm)	Positioning time (sec)					
	1	10	50	100	200	
Speed (mm/s)	10	0.2	1.1	5.1	10.1	20.1
	20	0.1	0.6	2.6	5.1	10.1
	30	0.1	0.4	1.7	3.4	6.7

For transfer load of 2.5kg

Positioning distance (mm)	Positioning time (sec)					
	1	10	50	100	200	
Speed (mm/s)	10	0.2	1.1	5.1	10.1	20.1
	20	0.1	0.6	2.6	5.1	10.1
	30	0.1	0.4	1.7	3.4	6.7

Refer to page 303 for acceleration time.

2 Phase Stepper Motor

With Motor Brake

Guide Rod Type

Series LXP

Ball Bushing

Ball Screw
ø8mm/5mm lead

How to Order

LXPB2 **BD** — Stroke **S** B — **F9N** **1**

Home position switch

Nil	None
S	Yes (cable length 0.3m)

Auto switch type

Nil	None
-----	------

Refer to the table on the right for auto switch part numbers.

Number of auto switches

1	1 pc.
2	2 pcs.
⋮	⋮
6	6 pcs.

Auto switch types

Symbol	Model	Wiring/ Output type	Lead wire length (m)	Contact
Nil	Without auto switch			
F9N	D-F9N	3 wire/NPN	0.5	N.O. (A contact)
F9P	D-F9P	3 wire/PNP	0.5	N.O. (A contact)
F9G	D-F9G	3 wire/NPN	0.5	N.C. (B contact)
F9H	D-F9H	3 wire/PNP	0.5	N.C. (B contact)
F9GL	D-F9GL	3 wire/NPN	3	N.C. (B contact)
F9HL	D-F9HL	3 wire/PNP	3	N.C. (B contact)
F9B	D-F9B	2 wire	0.5	N.O. (A contact)
F9NL	D-F9NL	3 wire/NPN	3	N.O. (A contact)
F9PL	D-F9PL	3 wire/PNP	3	N.O. (A contact)
F9BL	D-F9BL	2 wire	3	N.O. (A contact)

Specifications

Standard stroke		mm	50	75	100	125	150	175	200	
Performance	Body weight	kg	2.2	2.4	2.5	2.8	3.0	3.1	3.3	
	Operating temperature range	°C	5 to 40 (with no condensation)							
	Work load	kg	6 horizontal/5 vertical (Note 1)							
	Speed	mm/s	to 80 (Note 2)							
	Positioning repeatability	mm	±0.03							
Main parts	Motor	2 phase stepper motor (with brake)								
	Lead screw	Ball screw ø8mm, 5mm lead								
	Guide	Ball bushing								
	Electromagnetic brake	Model	De-energized operating type							
		Static torque	0.1N·m or more							
Rated voltage		24VDC ±5%								
	Power consumption	5W								
Home position switch	Model	Photo micro sensor EE-SX673								
Driver	Model	LC6D-220AD (Refer to page 306 for details.)								
Positioning driver	Model	LC6C-220AD (Refer to page 309 for details.)								

Note 1) Based on the operating conditions, establish a separate guide when exceeding the maximum allowable lateral load.

Note 2) Since vibration may increase with low speed operation, use 5mm/s or more as a guide for speed.

Lifter Operation Range

This is the operating range for ball bushings. Use within the allowable thrust range.

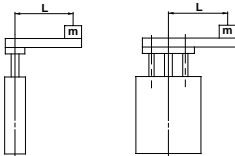

50 to 200mm stroke

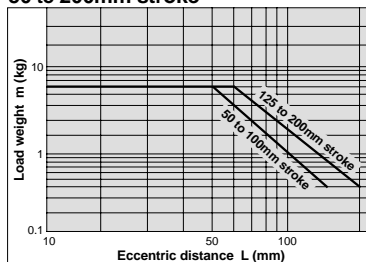

Operating Conditions

Allowable lateral load (F)

Stroke	Load (N)
50	42
75	42
100	40
125	42
150	32
175	24
200	17

Allowable plate rotation torque (T)

Stroke	Torque (N·m)
50	2.87
75	2.47
100	2.17
125	2.38
150	2.16
175	1.98
200	1.82

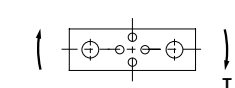
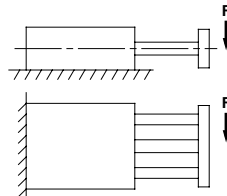
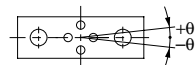

Plate non-rotating accuracy (θ)

Non-rotating accuracy (θ)
±0.09°



Refer to page 304 for deflection data.

Dimensions/LXPB2BD

Scale: 30%

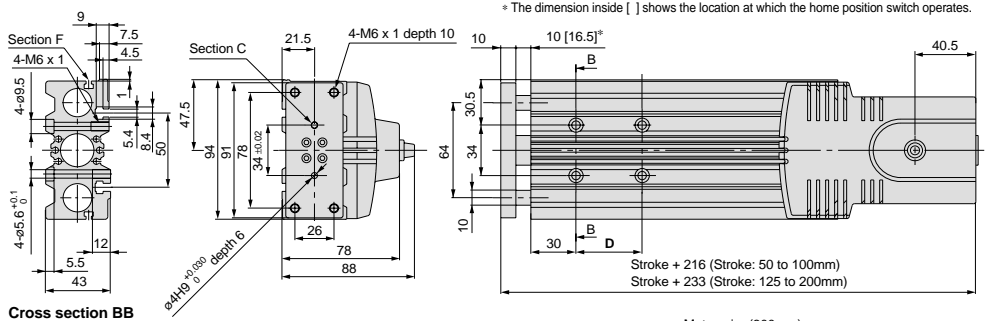

Cross section BB

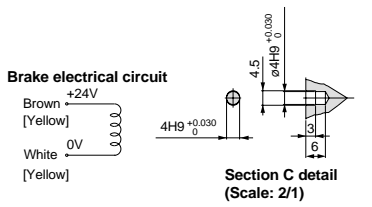

Brake electrical circuit

Section C detail (Scale: 2/1)

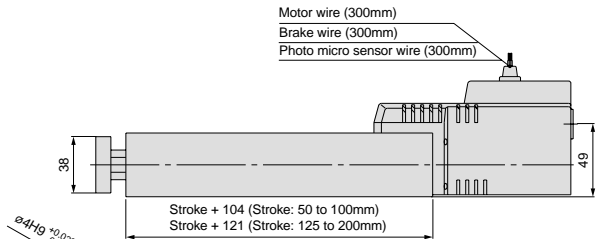

Note) A contact protection circuit is required when connecting a brake.

Model	D	E
LXPB2BD-50	44	52
LXPB2BD-75		
LXPB2BD-100		
LXPB2BD-125	120	90
LXPB2BD-150		
LXPB2BD-175		
LXPB2BD-200		

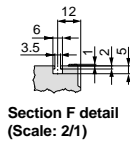

Section F detail (Scale: 2/1)

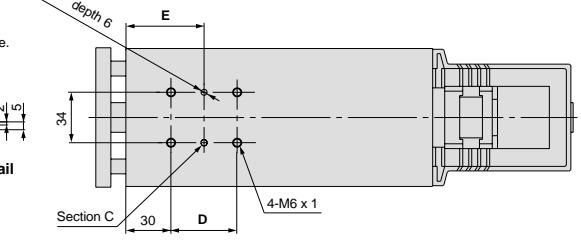

Refer to page 300 for mounting.

Positioning Time Guide (for Vertical Mount)

For transfer load of 0kg

Positioning distance (mm)		Positioning time (sec)				
		1	10	50	100	200
Speed (mm/s)	10	0.2	1.1	5.1	10.1	20.1
	40	0.1	0.3	1.3	2.6	5.1
	80	0.1	0.2	0.7	1.3	2.6

For transfer load of 5kg

Positioning distance (mm)		Positioning time (sec)				
		1	10	50	100	200
Speed (mm/s)	10	0.2	1.1	5.1	10.1	20.1
	40	0.1	0.3	1.3	2.6	5.1
	80	0.1	0.2	0.7	1.3	2.6

For transfer load of 2.5kg

Positioning distance (mm)		Positioning time (sec)				
		1	10	50	100	200
Speed (mm/s)	10	0.2	1.1	5.1	10.1	20.1
	40	0.1	0.3	1.3	2.6	5.1
	80	0.1	0.2	0.7	1.3	2.6

Refer to page 303 for acceleration time.

5 Phase Stepper Motor

Guide Rod Type

Without Motor Brake

Series LXP

Ball Bushing

Ball Screw
 $\varnothing 8\text{mm}/2\text{mm lead}$

How to Order

LXPB5 **BC** — Stroke **S** — **F9N** **1**

Home position switch

Nil	None
S	Yes (cable length 0.3m)

Auto switch type

Nil	None
-----	------

Refer to the table on the right for auto switch part numbers.

Number of auto switches

1	1 pc.
2	2 pcs.
⋮	⋮
6	6 pcs.

Auto switch types

Symbol	Model	Wiring/ Output type	Lead wire length (m)	Contact
Nil	Without auto switch			
F9N	D-F9N	3 wire/NPN	0.5	N.O. (A contact)
F9P	D-F9P	3 wire/PNP	0.5	N.O. (A contact)
F9G	D-F9G	3 wire/NPN	0.5	N.C. (B contact)
F9H	D-F9H	3 wire/PNP	0.5	N.C. (B contact)
F9GL	D-F9GL	3 wire/NPN	3	N.C. (B contact)
F9HL	D-F9HL	3 wire/PNP	3	N.C. (B contact)
F9B	D-F9B	2 wire	0.5	N.O. (A contact)
F9NL	D-F9NL	3 wire/NPN	3	N.O. (A contact)
F9PL	D-F9PL	3 wire/PNP	3	N.O. (A contact)
F9BL	D-F9BL	2 wire	3	N.O. (A contact)

Specifications

Standard stroke		mm	50	75	100	125	150	175	200
Performance	Body weight	kg	2.0	2.2	2.3	2.6	2.8	2.9	3.1
	Operating temperature range	°C	5 to 40 (with no condensation)						
	Work load	kg	6 horizontal/5 vertical <small>Note 1)</small>						
	Speed	mm/s	to 30 <small>Note 2)</small>						
	Positioning repeatability	mm	±0.03						
Main parts	Motor	5 phase stepper motor (without brake)							
	Lead screw	Ball screw $\varnothing 8\text{mm}$, 2mm lead							
	Guide	Ball bushing							
Home position switch	Model	Photo micro sensor EE-SX673							
Driver	Model	LC6D-507AD (Refer to page 306 details.)							

Note 1) Based on the operating conditions, establish a separate guide when exceeding the maximum allowable lateral load.

Note 2) Since vibration may increase with low speed operation, use 2mm/s or more as a guide for speed.

Operating Conditions

Allowable lateral load (F)

Stroke	Load (N)
50	42
75	42
100	40
125	42
150	32
175	24
200	17

Allowable plate rotation torque (T)

Stroke	Torque (N·m)
50	2.87
75	2.47
100	2.17
125	2.38
150	2.16
175	1.98
200	1.82

Plate non-rotating accuracy (θ)

Non-rotating accuracy (θ)
 $\pm 0.09^\circ$

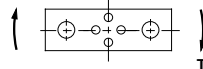
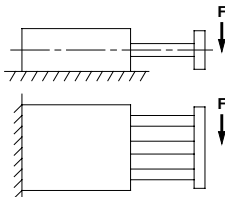
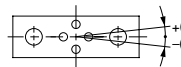

Refer to page 304 for deflection data.

Dimensions/LXPB5BC

Scale: 30%

* The dimension inside [] shows the location at which the home position switch operates.

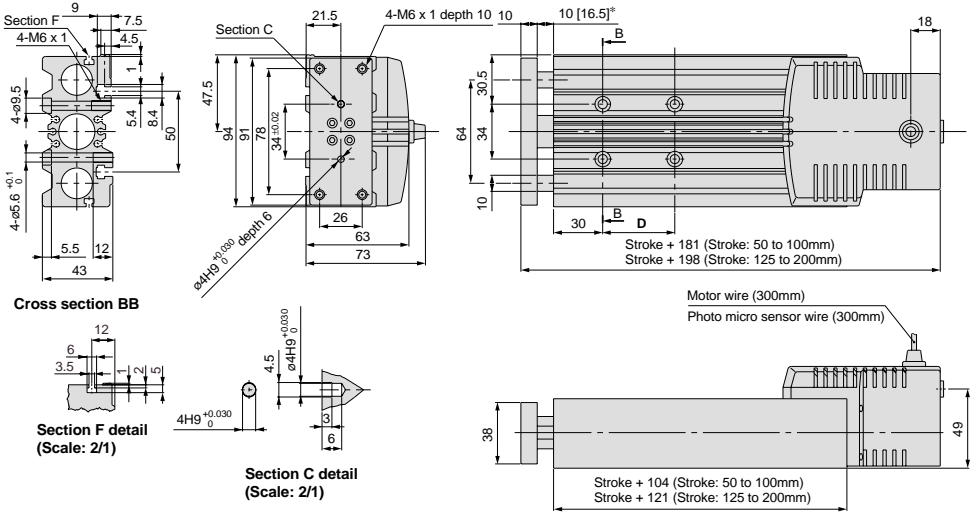

Model	D	E
LXPB5BC-50	44	52
LXPB5BC-75		
LXPB5BC-100		
LXPB5BC-125	120	90
LXPB5BC-150		
LXPB5BC-175		
LXPB5BC-200		

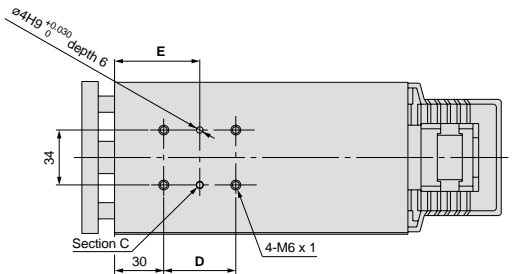

Refer to page 300 for mounting.

Positioning Time Guide (for Horizontal Mount)

For transfer load of 0kg

Positioning distance (mm)		Positioning time (sec)				
		1	10	50	100	200
Speed (mm/s)	10	0.2	1.1	5.1	10.1	20.1
	20	0.1	0.6	2.6	5.1	10.1
	30	0.1	0.4	1.7	3.4	6.7

For transfer load of 6kg

Positioning distance (mm)		Positioning time (sec)				
		1	10	50	100	200
Speed (mm/s)	10	0.2	1.1	5.1	10.1	20.1
	20	0.1	0.6	2.6	5.1	10.1
	30	0.1	0.4	1.7	3.4	6.7

For transfer load of 3kg

Positioning distance (mm)		Positioning time (sec)				
		1	10	50	100	200
Speed (mm/s)	10	0.2	1.1	5.1	10.1	20.1
	20	0.1	0.6	2.6	5.1	10.1
	30	0.1	0.4	1.7	3.4	6.7

Refer to page 303 for acceleration time.

5 Phase Stepper Motor

Guide Rod Type

Without Motor Brake

Series LXP

Ball Bushing

Ball Screw
 $\varnothing 8\text{mm}/5\text{mm}$ lead

How to Order

LXPB5 **BD** - Stroke **S** - F9N 1

Home position switch

Nil	None
S	Yes (cable length 0.3m)

Auto switch type

Nil	None
-----	------

Refer to the table on the right for auto switch part numbers.

Number of auto switches

1	1 pc.
2	2 pcs.
⋮	⋮
6	6 pcs.

Auto switch types

Symbol	Model	Wiring/ Output type	Lead wire length (m)	Contact
Nil	Without auto switch			
F9N	D-F9N	3 wire/NPN	0.5	N.O. (A contact)
F9P	D-F9P	3 wire/PNP	0.5	N.O. (A contact)
F9G	D-F9G	3 wire/NPN	0.5	N.C. (B contact)
F9H	D-F9H	3 wire/PNP	0.5	N.C. (B contact)
F9GL	D-F9GL	3 wire/NPN	3	N.C. (B contact)
F9HL	D-F9HL	3 wire/PNP	3	N.C. (B contact)
F9B	D-F9B	2 wire	0.5	N.O. (A contact)
F9NL	D-F9NL	3 wire/NPN	3	N.O. (A contact)
F9PL	D-F9PL	3 wire/PNP	3	N.O. (A contact)
F9BL	D-F9BL	2 wire	3	N.O. (A contact)

Specifications

Standard stroke		mm	50	75	100	125	150	175	200
Performance	Body weight	kg	2.0	2.2	2.3	2.6	2.8	2.9	3.1
	Operating temperature range	°C	5 to 40 (with no condensation)						
	Work load	kg	6 horizontal/5 vertical <small>Note 1)</small>						
	Speed	mm/s	to 80 <small>Note 2)</small>						
	Positioning repeatability	mm	±0.03						
Main parts	Motor	5 phase stepper motor (without brake)							
	Lead screw	Ball screw $\varnothing 8\text{mm}$, 5mm lead							
	Guide	Ball bushing							
Home position switch	Model	Photo micro sensor EE-SX673							
Driver	Model	LC6D-507AD (Refer to page 306 for details.)							

Note 1) Based on the operating conditions, establish a separate guide when exceeding the maximum allowable lateral load.

Note 2) Since vibration may increase with low speed operation, use 5mm/s or more as a guide for speed.

Operating Conditions

Allowable lateral load (F)

Stroke	Load (N)
50	42
75	42
100	40
125	42
150	32
175	24
200	17

Allowable plate rotation torque (T)

Stroke	Torque (N·m)
50	2.87
75	2.47
100	2.17
125	2.38
150	2.16
175	1.98
200	1.82

Plate non-rotating accuracy (θ)

Non-rotating accuracy (θ)
±0.09°

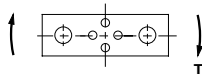
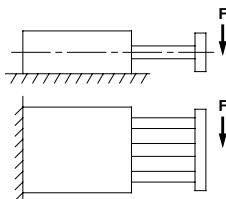
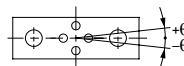

Refer to page 304 for deflection data.

Dimensions/LXPB5BD

Scale: 30%

* The dimension inside [] shows the location at which the home position switch operates.

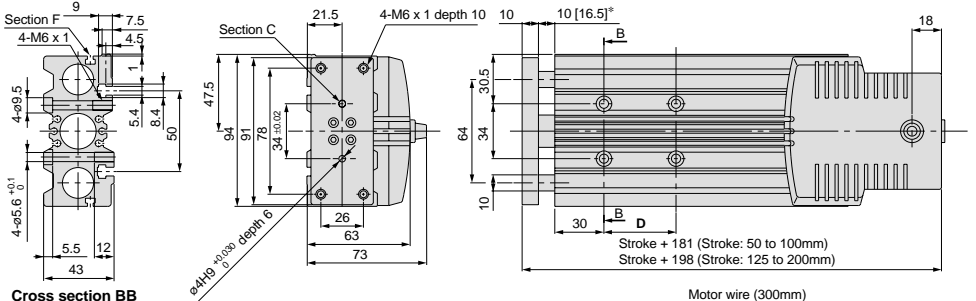

Cross section BB

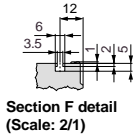

Section F detail (Scale: 2/1)

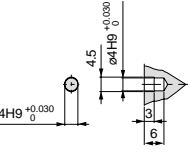

Section C detail (Scale: 2/1)

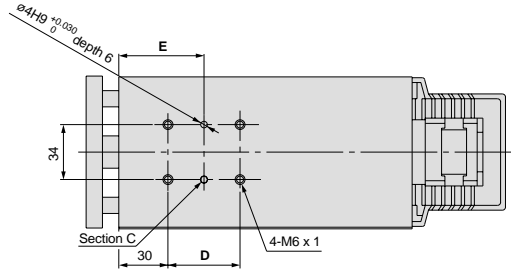
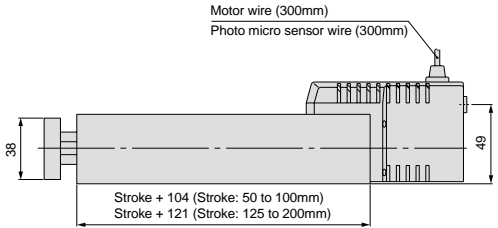

Model	D	E
LXPB5BD-50	44	52
LXPB5BD-75		
LXPB5BD-100		
LXPB5BD-125	120	90
LXPB5BD-150		
LXPB5BD-175		
LXPB5BD-200		

Refer to page 300 for mounting.

Positioning Time Guide (for Horizontal Mount)

For transfer load of 0kg

Positioning distance (mm)		Positioning time (sec)				
		1	10	50	100	200
Speed (mm/s)	10	0.2	1.1	5.1	10.1	20.1
	40	0.1	0.3	1.3	2.6	5.1
	80	0.1	0.2	0.7	1.3	2.6

For transfer load of 6kg

Positioning distance (mm)		Positioning time (sec)				
		1	10	50	100	200
Speed (mm/s)	10	0.2	1.1	5.1	10.1	20.1
	40	0.1	0.3	1.3	2.6	5.1
	80	0.1	0.2	0.7	1.3	2.6

For transfer load of 3kg

Positioning distance (mm)		Positioning time (sec)				
		1	10	50	100	200
Speed (mm/s)	10	0.2	1.1	5.1	10.1	20.1
	40	0.1	0.3	1.3	2.6	5.1
	80	0.1	0.2	0.7	1.3	2.6

Refer to page 303 for acceleration time.

5 Phase Stepper Motor

With Motor Brake

Guide Rod Type

Series LXP

Ball Bushing

Ball Screw
ø8mm/2mm lead

How to Order

LXPB5 **BC** - Stroke **S** B - **F9N** **1**

Home position switch

Nil	None
S	Yes (cable length 0.3m)

Auto switch type

Nil	None
-----	------

Refer to the table on the right for auto switch part numbers.

Number of auto switches

1	1 pc.
2	2 pcs.
⋮	⋮
6	6 pcs.

Auto switch types

Symbol	Model	Wiring/ Output type	Lead wire length (m)	Contact
Without auto switch				
Nil				
F9N	D-F9N	3 wire/NPN	0.5	N.O. (A contact)
F9P	D-F9P	3 wire/PNP	0.5	N.O. (A contact)
F9G	D-F9G	3 wire/NPN	0.5	N.C. (B contact)
F9H	D-F9H	3 wire/PNP	0.5	N.C. (B contact)
F9GL	D-F9GL	3 wire/NPN	3	N.C. (B contact)
F9HL	D-F9HL	3 wire/PNP	3	N.C. (B contact)
F9B	D-F9B	2 wire	0.5	N.O. (A contact)
F9NL	D-F9NL	3 wire/NPN	3	N.O. (A contact)
F9PL	D-F9PL	3 wire/PNP	3	N.O. (A contact)
F9BL	D-F9BL	2 wire	3	N.O. (A contact)

Specifications

		Standard stroke	mm	50	75	100	125	150	175	200	
Performance	Body weight	kg		2.2	2.4	2.5	2.8	3.0	3.1	3.3	
	Operating temperature range	°C		5 to 40 (with no condensation)							
	Work load	kg		6 horizontal/5 vertical <small>Note 1</small>							
	Speed	mm/s		to 30 <small>Note 2</small>							
	Positioning repeatability	mm		±0.03							
Main parts	Motor		5 phase stepper motor (with brake)								
	Lead screw		Ball screw ø8mm, 2mm lead								
	Guide		Ball bushing								
	Electromagnetic brake	Model		De-energized operating type							
		Static torque		0.1N·m or more							
Rated voltage			24VDC ±5%								
	Power consumption		5W								
Home position switch	Model		Photo micro sensor EE-SX673								
Driver	Model		LC6D-507AD (Details on page 306)								

Note 1) Based on the operating conditions, establish a separate guide when exceeding the maximum allowable lateral load.

Note 2) Since vibration may increase with low speed operation, use 5mm/s or more as a guide for speed.

Lifter Operation Range

This is the operating range for ball bushings. Use within the allowable thrust range.

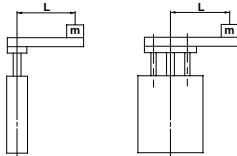

50 to 200mm stroke

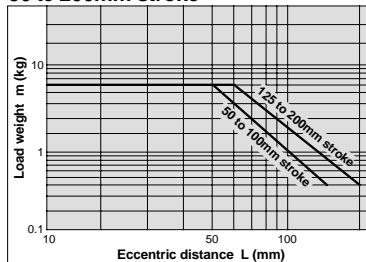

Operating Conditions

Allowable lateral load (F)

Stroke	Load (N)
50	42
75	42
100	40
125	42
150	32
175	24
200	17

Allowable plate rotation torque (T)

Stroke	Torque (N·m)
50	2.87
75	2.47
100	2.17
125	2.38
150	2.16
175	1.98
200	1.82

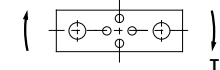
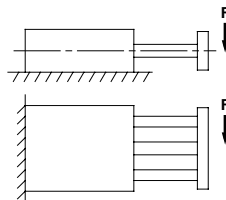
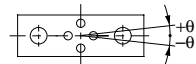

Plate non-rotating accuracy (θ)

Non-rotating accuracy (θ)
±0.09°



Refer to page 304 for deflection data.

Dimensions/LXPB5BC

Scale: 30%

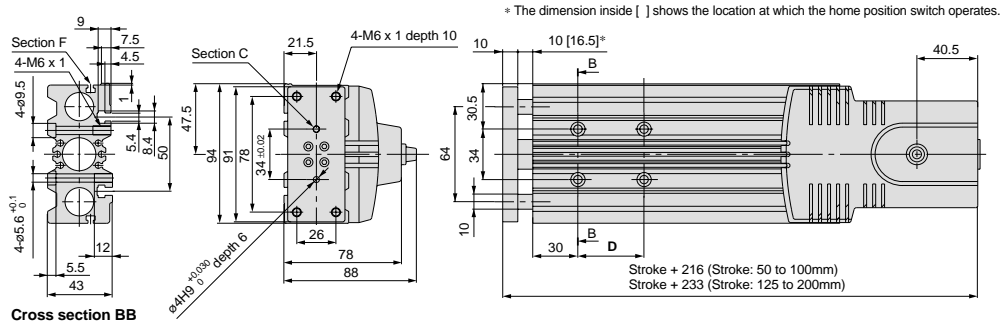

Cross section BB

Brake electrical circuit

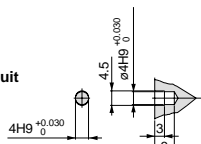

Section C detail (Scale: 2/1)

Note) A contact protection circuit is required when connecting a brake.

Model	D	E
LXPB5BC-50□B	44	52
LXPB5BC-75□B		
LXPB5BC-100□B		
LXPB5BC-125□B		
LXPB5BC-150□B	120	90
LXPB5BC-175□B		
LXPB5BC-200□B		

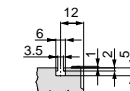

Section F detail (Scale: 2/1)

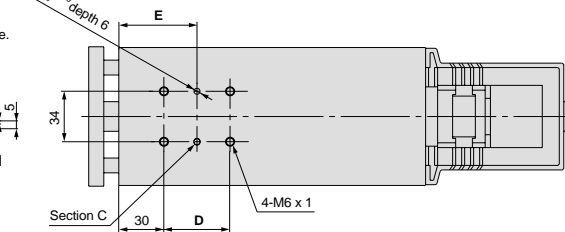
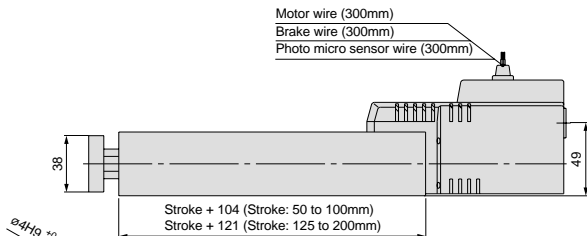

Refer to page 300 for mounting.

Positioning Time Guide (for Vertical Mount)

For transfer load of 0kg

Positioning distance (mm)		Positioning time (sec)				
		1	10	50	100	200
Speed (mm/s)	10	0.2	1.1	5.1	10.1	20.1
	20	0.1	0.6	2.6	5.1	10.1
	30	0.1	0.4	1.7	3.4	6.7

For transfer load of 5kg

Positioning distance (mm)		Positioning time (sec)				
		1	10	50	100	200
Speed (mm/s)	10	0.2	1.1	5.1	10.1	20.1
	20	0.1	0.6	2.6	5.1	10.1
	30	0.1	0.4	1.7	3.4	6.7

For transfer load of 2.5kg

Positioning distance (mm)		Positioning time (sec)				
		1	10	50	100	200
Speed (mm/s)	10	0.2	1.1	5.1	10.1	20.1
	20	0.1	0.6	2.6	5.1	10.1
	30	0.1	0.4	1.7	3.4	6.7

Refer to page 303 for acceleration time.

5 Phase Stepper Motor

With Motor Brake

Guide Rod Type

Series LXP

Ball Bushing

Ball Screw
ø8mm/5mm lead

How to Order

LXPB5 **BD** — Stroke **S** B — **F9N** **1**

Home position switch

Nil	None
S	Yes (cable length 0.3m)

Auto switch type

Nil	None
-----	------

Refer to the table on the right for auto switch part numbers.

Number of auto switches

1	1 pc.
2	2 pcs.
⋮	⋮
6	6 pcs.

Auto switch types

Symbol	Model	Wiring/ Output type	Lead wire length (m)	Contact
Nil	Without auto switch			
F9N	D-F9N	3 wire/NPN	0.5	N.O. (A contact)
F9P	D-F9P	3 wire/PNP	0.5	N.O. (A contact)
F9G	D-F9G	3 wire/NPN	0.5	N.C. (B contact)
F9H	D-F9H	3 wire/PNP	0.5	N.C. (B contact)
F9GL	D-F9GL	3 wire/NPN	3	N.C. (B contact)
F9HL	D-F9HL	3 wire/PNP	3	N.C. (B contact)
F9B	D-F9B	2 wire	0.5	N.O. (A contact)
F9NL	D-F9NL	3 wire/NPN	3	N.O. (A contact)
F9PL	D-F9PL	3 wire/PNP	3	N.O. (A contact)
F9BL	D-F9BL	2 wire	3	N.O. (A contact)

Specifications

Standard stroke		mm	50	75	100	125	150	175	200	
Performance	Body weight	kg	2.2	2.4	2.5	2.8	3.0	3.1	3.3	
	Operating temperature range	°C	5 to 40 (with no condensation)							
	Work load	kg	6 horizontal/5 vertical (Note 1)							
	Speed	mm/s	to 80 (Note 2)							
	Positioning repeatability	mm	±0.03							
Main parts	Motor	5 phase stepper motor (with brake)								
	Lead screw	Ball screw ø8mm, 5mm lead								
	Guide	Ball bushing								
	Electromagnetic brake	Model	De-energized operating type							
		Static torque	0.1N·m or more							
Rated voltage		24VDC ±5%								
	Power consumption	5W								
Home position switch	Model	Photo micro sensor EE-SX673								
Driver	Model	LC6D-507AD (Refer to page 306 for details.)								

Note 1) Based on the operating conditions, establish a separate guide when exceeding the maximum allowable lateral load.

Note 2) Since vibration may increase with low speed operation, use 5mm/s or more as a guide for speed.

Lifter Operation Range

This is the operating range for ball bushings. Use within the allowable thrust range.

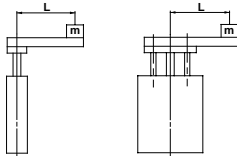

50 to 200mm stroke

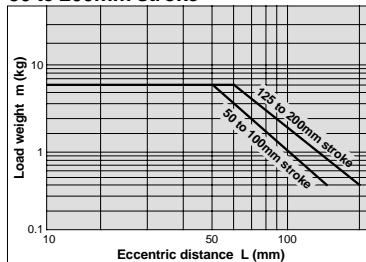

Operating Conditions

Allowable lateral load (F)

Stroke	Load (N)
50	42
75	42
100	40
125	42
150	32
175	24
200	17

Allowable plate rotation torque (T)

Stroke	Torque (N·m)
50	2.87
75	2.47
100	2.17
125	2.38
150	2.16
175	1.98
200	1.82

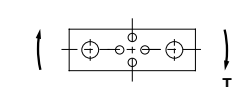
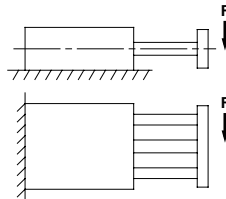
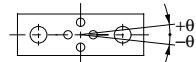

Plate non-rotating accuracy (θ)

Non-rotating accuracy (θ)
±0.09°



Refer to page 304 for deflection data.

Dimensions/LXPB5BD

Scale: 30%

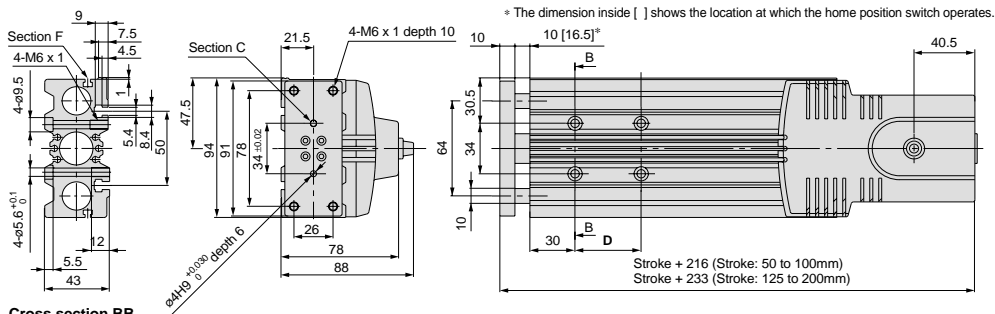

Cross section BB

Brake electrical circuit

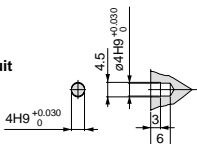
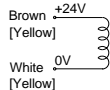

Section C detail (Scale: 2/1)

Motor wire (300mm)
Brake wire (300mm)
Photo micro sensor wire (300mm)

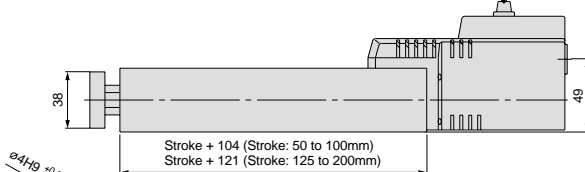

Note) A contact protection circuit is required when connecting a brake.

Model	D	E
LXPB5BD-50□B	44	52
LXPB5BD-75□B		
LXPB5BD-100□B		
LXPB5BD-125□B	120	90
LXPB5BD-150□B		
LXPB5BD-175□B		
LXPB5BD-200□B		

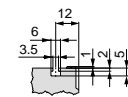

Section F detail (Scale: 2/1)

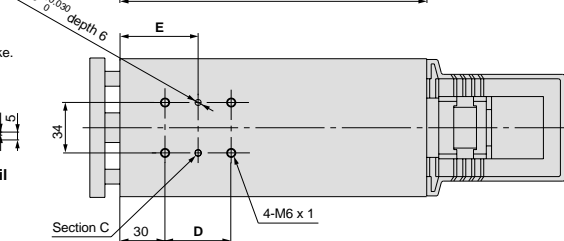

Refer to page 300 for mounting.

Positioning Time Guide (for Vertical Mount)

For transfer load of 0kg

Positioning distance (mm)		Positioning time (sec)				
		1	10	50	100	200
Speed (mm/s)	10	0.2	1.1	5.1	10.1	20.1
	40	0.1	0.3	1.3	2.6	5.1
	80	0.1	0.2	0.7	1.3	2.6

For transfer load of 5kg

Positioning distance (mm)		Positioning time (sec)				
		1	10	50	100	200
Speed (mm/s)	10	0.2	1.1	5.1	10.1	20.1
	40	0.1	0.3	1.3	2.6	5.1
	80	0.1	0.2	0.7	1.3	2.6

For transfer load of 2.5kg

Positioning distance (mm)		Positioning time (sec)				
		1	10	50	100	200
Speed (mm/s)	10	0.2	1.1	5.1	10.1	20.1
	40	0.1	0.3	1.3	2.6	5.1
	80	0.1	0.2	0.7	1.3	2.6

Refer to page 303 for acceleration time.

How to Order

Low Profile Slide Table Type **LXFH 5 B C 25** **GD 1 X60**

Guide Rod Type **LXPB 2 B C 50 B F9N 1 X60**

High Rigidity Slide Table Type **LXSH 2 B C 50 B F9N 1 X60**

Motor type

2	2 phase stepper motor
5	5 phase stepper motor

Lead screw type

B	Ball screw
---	------------

Lead screw lead

C	2mm
D	5mm

Stroke

Model	Stroke (mm)							
	25	50	75	100	125	150	175	200
LXF	●	●	●	●				
LXP		●	●	●	●	●	●	●
LXS		●	●	●	●	●		

Low particulate generation specification

Number of auto/proximity switches

1	1 pc.
2	2 pcs.
⋮	⋮
6	6 pcs.

Auto/Proximity switch type

Nil	None
-----	------

Refer to the tables below for auto/proximity switch part numbers.

Brake

Nil	Without brake
B	With brake

Home position switch

Nil	None
S	Yes (cable length 0.3m)

Auto switch types

Symbol	Model	Wiring/Output type	Lead wire length (m)	Contact	Applicable actuator
F9N	D-F9N	3 wire/NPN	0.5	N.O. (A contact)	LXP LXS
F9P	D-F9P	3 wire/PNP	0.5	N.O. (A contact)	
F9G	D-F9G	3 wire/NPN	0.5	N.C. (B contact)	
F9H	D-F9H	3 wire/PNP	0.5	N.C. (B contact)	
F9GL	D-F9GL	3 wire/NPN	3	N.C. (B contact)	
F9HL	D-F9HL	3 wire/PNP	3	N.C. (B contact)	
F9B	D-F9B	2 wire	0.5	N.O. (A contact)	
F9NL	D-F9NL	3 wire/NPN	3	N.O. (A contact)	
F9PL	D-F9PL	3 wire/PNP	3	N.O. (A contact)	
F9BL	D-F9BL	2 wire	3	N.O. (A contact)	

* When using both auto and proximity switches, list the proximity switch part number after the auto switch part number. Example) **F9N1G2**

Proximity switch types

Symbol	Model	Wiring/Output type	Lead wire length (m)	Contact	Applicable actuator
GN	With sensor rail and sensor plate, without proximity switch				
G	GXL-8F	3 wire/NPN	1	N.O. (A contact)	LXF LXS
GD	GXL-8FI	3 wire/NPN	1	N.O. (A contact)	
GB	GXL-8FB	3 wire/NPN	1	N.C. (B contact)	
GDB	GXL-8FIB	3 wire/NPN	1	N.C. (B contact)	
GU	GXL-8FU	2 wire/Solid state	1	N.O. (A contact)	
GUB	GXL-8FUB	2 wire/Solid state	1	N.C. (B contact)	

* Refer to page 318 for detailed specifications of proximity switches.

Specifications

Model	LXF	LXP	LXS
Guide type	Direct acting guide Stainless steel, With low particulate generating grease	Ball bushing Stainless steel, With low particulate generating grease	High rigidity direct acting guide Stainless steel, With low particulate generating grease
Lead screw	Ball screw ø8mm 2mm/5mm lead Black chrome coating + Special fluororesin coating, AFE grease (made by THK) applied		

For basic specifications such as allowable moment, refer to the "Standard" pages for equivalent products listed on Features pages 3 and 4.

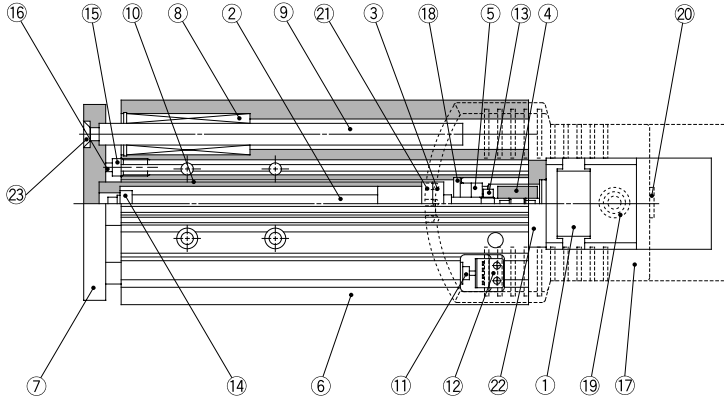
Construction**Series LXP**

LJ1

LG1

LC1

LX

LC6D/LC6C

Switches

Parts list

No.	Description	Material	Note
1	Motor	—	Stepper motor
2	Roller screw	Alloy steel	
3	Nut	Resin	
4	Coupling	—	
5	Bearing	—	
6	Body	Aluminum alloy	Anodized
7	Mounting plate	Mild steel	Nickel plated
8	Ball bushing	—	
9	Guide rod	Bearing steel	Chrome plated
10	Tube	Aluminum alloy	Anodized
11	Sensor pin	Stainless steel	

Parts list

No.	Description	Material	Note
12	Photo micro sensor	—	
13	Lock nut	Carbon steel	Black zinc chromated
14	Stopper nut	Aluminum alloy	
15	Bumper bolt	Bearing steel	Nickel plated
16	Bumper	Resin	
17	Motor cover	Resin	
18	Tension ring	Stainless steel	
19	Cable cap	—	
20	Plug	—	
21	Magnet	—	
22	Adaptor	Aluminum alloy	
23	Plate mounting bolt	Carbon steel	Nickel plated

Series LX

Mounting

Series LXP

Actuator mounting

1. Tapped holes			
Model	Bolt	Max. tightening torque N·m	Max. screw-in depth (/mm)
LXP	M6 x 1	7.4	12

2. Through holes			
Model	Bolt	Max. tightening torque N·m	Body thickness (/mm)
LXP	M5 x 0.8	4.4	37.5

3. T-slots			
Model	Bolt	Max. tightening torque N·m	Max. screw-in depth (/mm)
LXP	M5 x 0.8	7.4	8.5

Caution Use bolts at least 0.5mm shorter than the maximum screw-in depth, so they do not touch the body.

Work piece mounting

1. Front mount type			
Model	Bolt	Max. tightening torque N·m	Body thickness (/mm)
LXP	M6 x 1	7.4	10

Acceleration Time Guide/Slide Screw Specification (Horizontal)

LXFH5SA

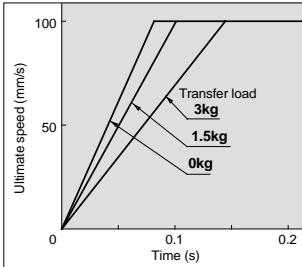

LXPB2SA/LXSH2SA

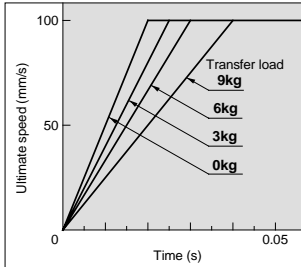

LXPB5SA/LXSH5SA

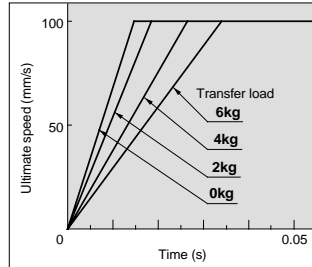

LXFH5SB

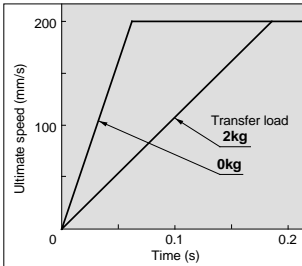

LXPB2SB/LXSH2SB

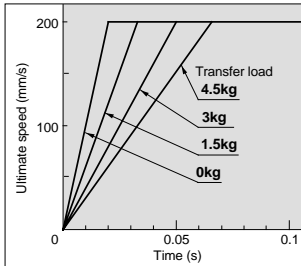

LXPB5SB/LXSH5SB

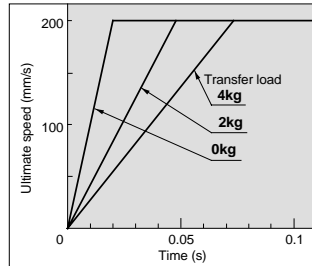

Acceleration Time Guide/Slide Screw Specification (Vertical)

LXPB2SA/LXSH2SA

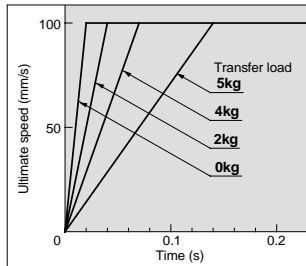

LXPB5SA/LXSH5SA

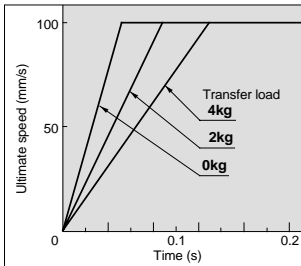

LXPB2SB/LXSH2SB

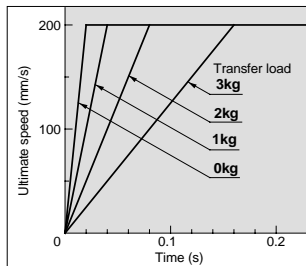

LXPB5SB/LXSH5SB

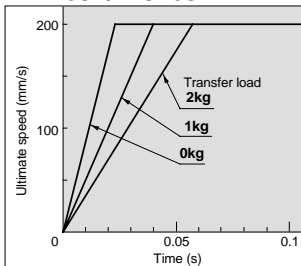

⚠ Caution

- Transfer loads should not exceed each model's work load specification.
- Determine the acceleration time based on the transfer load and ultimate speed.
- Operating over the graph ranges will cause loss of synchronism.
- The graphs are based on operation using an SMC DC power input type driver with halfstep energization.
- Data fluctuate depending on the operating conditions.

Acceleration Time Guide/Ball Screw Specification (Horizontal)

LXFH5BC

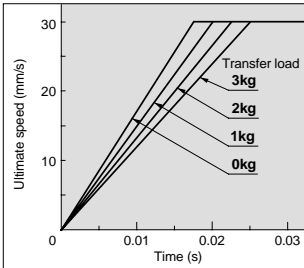

LXPB2BC/LXSH2BC

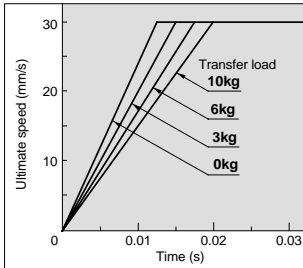

LXPB5BC/LXSH5BC

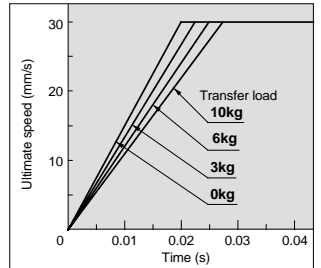

LXFH5BD

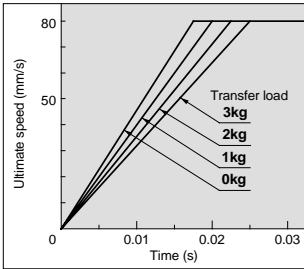

LXPB2BD/LXSH2BD

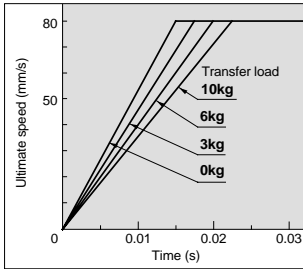

LXPB5BD/LXSH5BD

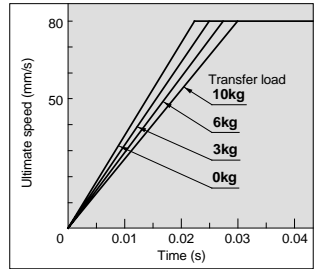

Acceleration Time Guide/Ball Screw Specification (Vertical)

LXPB2BC/LXSH2BC

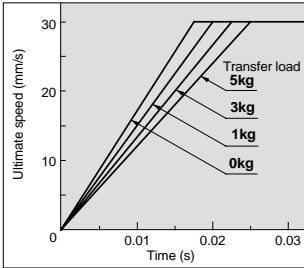

LXPB5BC/LXSH5BC

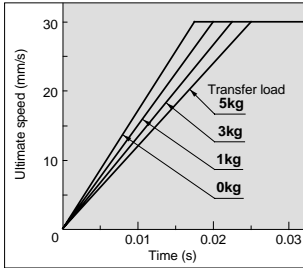

LXPB2BD/LXSH2BD

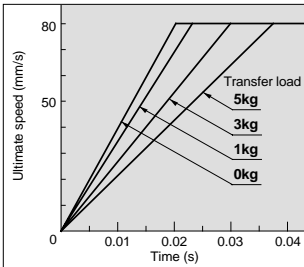

LXPB5BD/LXSH5BD

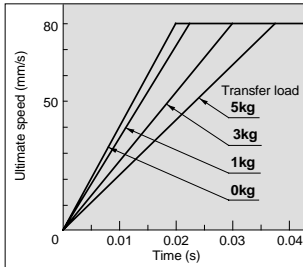

⚠ Caution

- Transfer loads should not exceed each model's work load specification.
- Determine the acceleration time based on the transfer load and ultimate speed.
- Operating over the graph ranges will cause loss of synchronism.
- The graphs are based on operation using an SMC DC power input type driver with halfstep energization.
- Data fluctuate depending on the operating conditions.

LJ1

LG1





LC1

LX

LC6D/LC6C

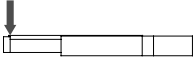
Switches

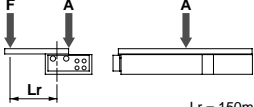
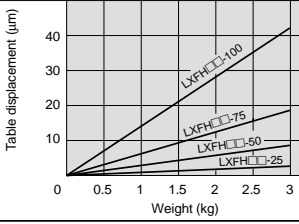
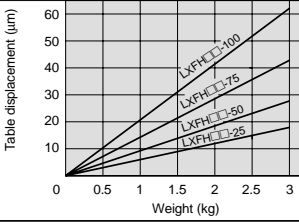
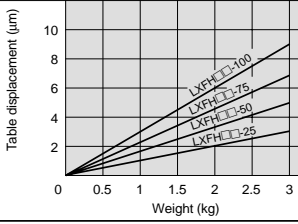
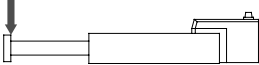
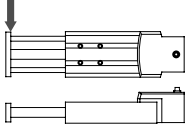
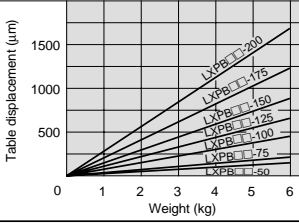
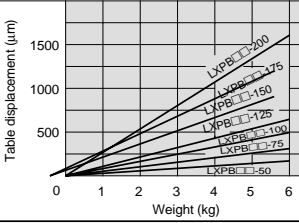
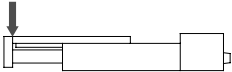
Table Deflection

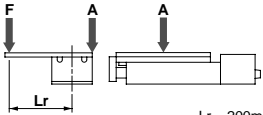
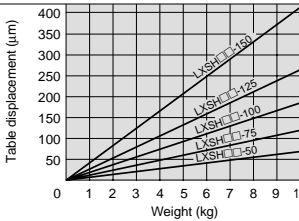
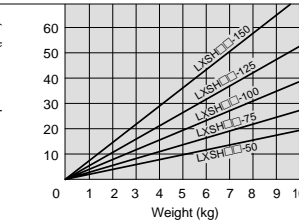
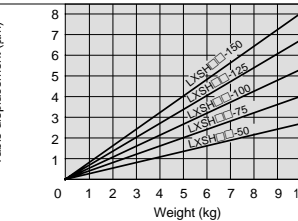
	Table displacement by pitch moment load	Table displacement by yaw moment load	Table displacement by roll moment load
LXF	<p>Displacement at the section indicated by the arrow when a load is applied to this section with the slide table fully extended.</p> 	<p>Displacement at the section indicated by the arrow when a load is applied to this section with the slide table fully extended.</p> 	<p>Displacement at "A" when a load is applied to "F" with the slide table retracted.</p>  <p style="text-align: right;">$L_r = 150\text{mm}$</p>
			
LXP	<p>Displacement at the section indicated by the arrow when a load is applied to this section with the electric actuator fully extended.</p> 	<p>Displacement at the section indicated by the arrow when a load is applied to this section with the electric actuator fully extended.</p> 	
			
LXS	<p>Displacement at the section indicated by the arrow when a load is applied to this section with the slide table fully extended.</p> 	<p>Displacement at the section indicated by the arrow when a load is applied to this section with the slide table fully extended.</p> 	<p>Displacement at "A" when a load is applied to "F" with the slide table retracted.</p>  <p style="text-align: right;">$L_r = 200\text{mm}$</p>
			



Applicable Actuators

D-F9	Series LXF*, LXP, LXS
D-Y7GL	Series LJ1 (non-standard motor)

* Cannot be mounted on Series LXF with ball screw specification.

Auto Switch Specifications

Auto switch part no.	D-F9N	D-F9P	D-F9B	D-F9G	D-F9H
Contact	N.O. (A contact)			N.C. (B contact)	
Electrical entry	In-line				
Wiring type	3 wire		2 wire	3 wire	
Output type	NPN	PNP	—	NPN	PNP
Applicable load	IC circuit, Relay, PLC		24VDC relay, PLC	IC circuit, Relay, PLC	
Power supply voltage	5, 12, 24VDC (4.5 to 28V)		—	5, 12, 24VDC (4.5 to 28V)	
Current consumption	10mA or less		—	10mA or less	
Load voltage	28VDC or less	—	24VDC (10 to 28VDC)	28VDC or less	—
Load current	40mA or less	80mA or less	5 to 40mA	40mA or less	80mA or less
Internal voltage drop	1.5V or less (0.8V or less at load current of 10mA)	0.8V or less	0.4V or less	1.5V or less (0.8V or less at load current of 10mA)	0.8V or less
Leakage current	100µA or less at 24VDC		80mA or less	100µA or less at 24VDC	
Indicator light	Red LED lights up when ON			Red LED lights up when OFF	

Auto switch internal circuits

Lead wire colors inside [] are those prior to conformity with IEC standards.

D-F9G, D-Y7GL

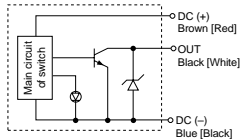

D-F9P, D-F9H

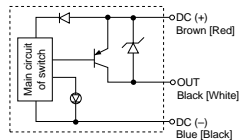

D-F9B

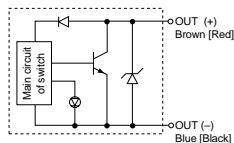

- Lead wire ——— Oil resistant heavy duty vinyl cord, ø2.7, 0.15mm² x 3 wire (Brown, Black, Blue [Red, White, Black]), 0.18mm² x 2 wire (Brown, Blue [Red, Black])
- Insulation resistance — 50MΩ or more at 500VDC (between lead wire and case)
- Withstand voltage — 1000VAC for 1 min. (between lead wire and case)
- Indication light — Lights when ON
- Ambient temperature — -10 to 60°C
- Operating time — 1ms or less
- Impact resistance — 1000m/s²

Auto switch part no.	D-Y7GL
Contact	N.C. (B contact)
Electrical entry	In-line
Wiring type	3 wire
Output type	NPN
Applicable load	IC circuit, Relay, PLC
Power supply voltage	5, 12, 24VDC (4.5 to 28V)
Current consumption	10mA or less
Load voltage	28VDC or less
Load current	40mA or less
Internal voltage drop	1.5V or less (0.8V or less at load current of 10mA)
Leakage current	100µA or less at 24VDC
Indicator light	Red LED lights up when OFF

Switches

Solid State Switch Connection and Examples

Basic Wiring

3 wire, NPN

(When the switch power supply and load power supply are the same)

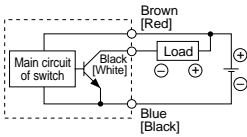

(When the switch power supply and load power supply are separate)

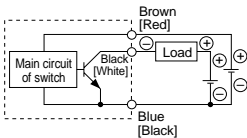

3 wire, PNP

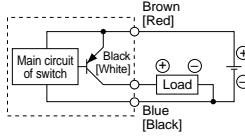

2 wire

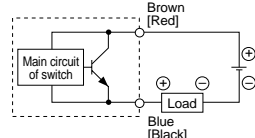
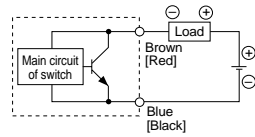

Examples of Connection to PLC

Sink input specifications, 3 wire, NPN

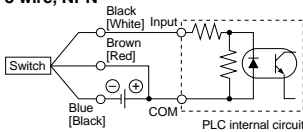

2 wire

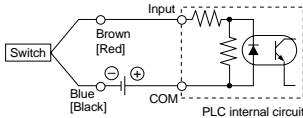

Source input specifications, 3 wire, PNP

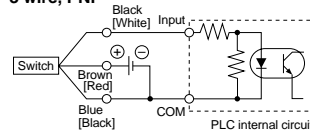

2 wire

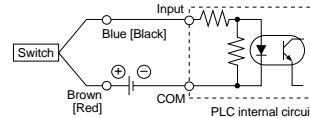

Connect according to the applicable PLC input specifications, as the connection method will vary depending on the PLC input specifications.

Connection Examples for AND (Series) and OR (Parallel)

3 wire, AND connection for NPN output

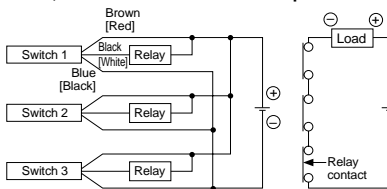

3 wire, OR connection for NPN output

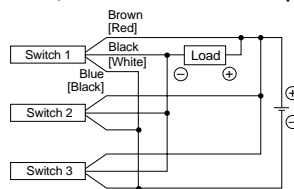

2 wire with 2 switch AND connection

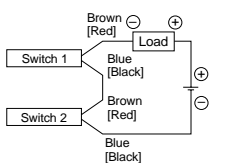

When two switches are connected in series, a load may malfunction because the load voltage will decline when in the ON state. The indicator lights will light up when both of the switches are in the ON state.

Load voltage at ON = Power supply voltage - Residual voltage x 2 pcs.
= 24V - 4V x 2 pcs.
= 16V

Example: Power supply voltage is 24VDC.
Internal voltage drop in switch is 4V.

2 wire with 2 switch OR connection

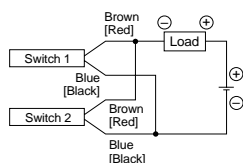

When two switches are connected in parallel, malfunction may occur because the load voltage will increase when in the OFF state.

Load voltage at OFF = Leakage current x 2 pcs. x Load impedance
= 1mA x 2pcs. = 3kΩ
= 6V

Example: Load impedance is 3kΩ.
Leakage current from switch is 1mA.

Solid-state Auto Switches for Direct Mounting Series D-M9N(V)/D-M9P(V)/D-M9B(V)



Grommet

- Reduced load currents for two-wire model (2.5 to 40 mA)
- Compliance with lead-free requirements
- Use of UL-approved lead wires (style 2844)



Internal circuits

D-M9N/M9NV

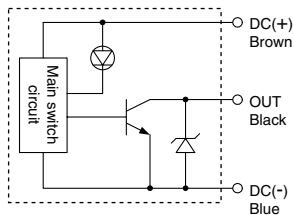

D-M9P/M9PV

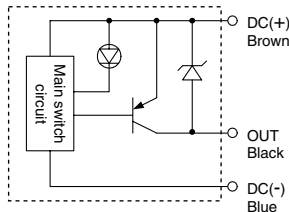

D-M9B/M9BV

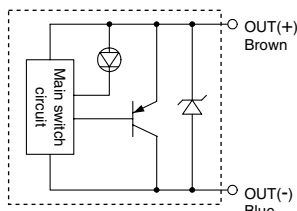

Auto Switch Specifications

PLC: Programmable Logic Controller

D-M9□/D-M9□V (with Indicator light)						
Model number	D-M9N	D-M9NV	D-M9P	D-M9PV	D-M9B	D-M9BV
Electrical entry	In-line	Perpendicular	In-line	Perpendicular	In-line	Perpendicular
Wiring	Three-wire			Two-wire		
Output	NPN		PNP		—	
Applicable load	Integrated circuit, relay and PLC				24 V DC relay and PLC	
Power voltage	5, 12, or 24 V DC (4.5 to 28 V DC)				—	
Current consumption	10 mA or less				—	
Load voltage	28 V DC or less		—		24 V DC (10 to 28 V DC)	
Load current	40 mA or less				2.5 to 40 mA	
Internal voltage drop	0.8 V or less				4 V or less	
Leakage current	100 μA max. at 24 V DC				0.8 mA or less	
Indicator light	Red LED lights when ON.					

- Lead wire: oil-proof heavy-duty vinyl cable
2.7 x 3.2 with elliptic cross-section, 0.15 mm², two cores (D-M9B),
or three cores (D-M9N and D-M9P)

Solid state switch specifications

Leakage current	3-wire: 100 μA or less; 2-wire: 0.8 mA max.
Operating time	1 ms or less
Impact resistance	1000 m/s ²
Insulation resistance	50 MΩ or more at 500 V DC (between lead wire and case)
Withstand voltage	1000 V AC for 1 min. (between lead wire and case)
Ambient temperature	-10°C to 60°C
Enclosure	IEC529 standard IP67, JIS C 0920 watertight construction

Weight

Unit: g

Model	D-M9N(V)	D-M9P(V)	D-M9B(V)
Lead wire length (m)	0.5	8	8
	3	41	41
	5	68	68

How to Order

Standard Model Number

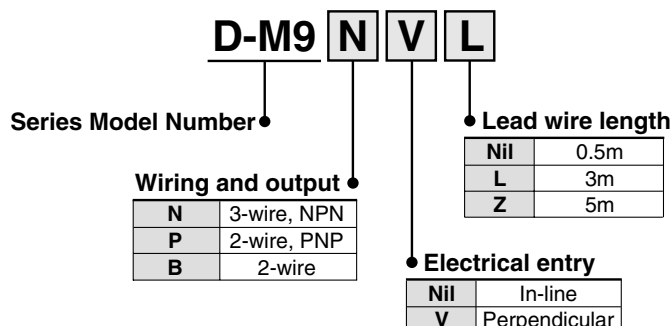

Series D-M9

Auto Switch Dimensions

D-M9□

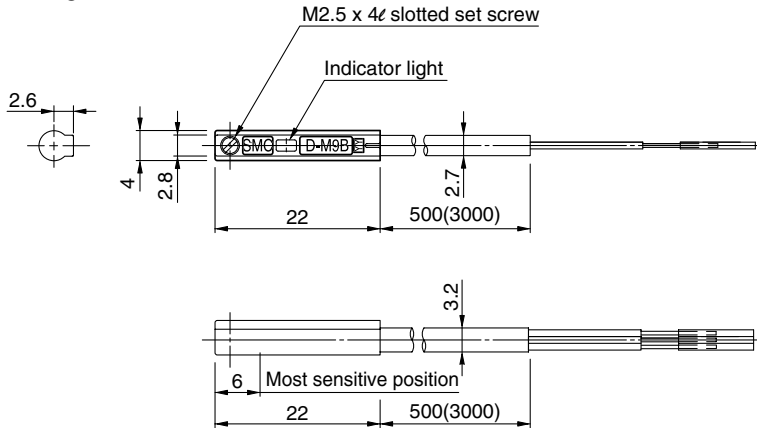

D-M9□V

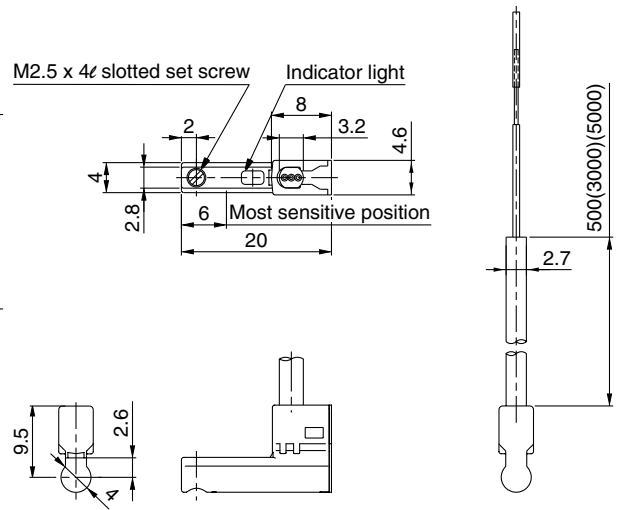

⚠ Specific Product Precautions

Be sure to read before handling. Contact SMC when the required specification is out of range.

Handling

⚠ Caution

Observe the following precautions when handling the product.

- The D-M9 series of auto switches is not overcurrent-protected. Faulty wiring or short circuit may result in breakage or burning-out of the switch.
- When stripping the cable clad, be careful about the orientation of the cable being stripped. The insulator may be accidentally torn or damaged depending on the orientation, as shown on the right.

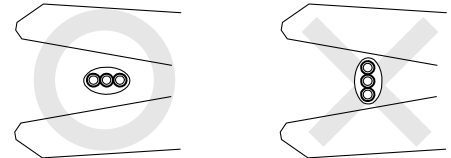

- We recommend the following tools

Manufacturer	Product name	Product number
VESSEL	Wire stripper	No 3000G
Tokyo Ideal	Strip master	45-089

* The stripper for the round shape cords (ø2.0) is for a 2-wire style.

- Please do not attach the switch with any other screws than those already attached to the auto switch body.

The operation range is shorter than that of the conventional models.

If the auto switch replaces the conventional model, it may not function depending on its application because the operation range is shorter. Refer to the examples below.

- In an application where at the end, the stopping position shifting range is larger than the operation range.**
For example, pushing a work against something, or pressing a work into a hole, or clamping a work.
- In an application where the auto switch is used to detect an intermediate stopping position. (Detecting time is shortened.)**

Note) Please contact SMC for the operation range details for each actuator.

The switch is damaged instantly when a load is shortened since short circuit protection is not built-in. Pay special attention to avoid reversing the connection of the brown lead of the power supply line and the black output line connection.

Standard Photo Micro Sensor for Home Position (OMRON Corporation)

Rating

Power supply voltage	5 to 24VDC $\pm 10\%$, Ripple (p-p) 10% or less		
Current consumption	35mA or less		
Control output	5 to 24VDC load current (Ic) 100mA, Residual voltage 0.8V or less Load current (Ic) 40mA, Residual voltage 0.4V or less		
Ambient temperature	Operation: -25° to 55° C (When stored: -30° to 80° C)		
Ambient humidity	Operation: 5 to 85%RH (When stored: 5 to 95%RH)		
Part no.	EE-SX672 equivalent	EE-SX673 equivalent	EE-SX674
Applicable actuator	LXF	LXP, LXS	LG1 (non-standard motor)

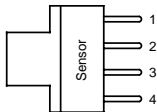

Terminal arrangement

1	Brown	Vcc \oplus
2	White	L*
3	Black	OUTPUT
4	Blue	GND (OV) \ominus

* Normally ON when light is blocked.
However, if the (L) terminal and \oplus terminal are shorted, it changes to ON when light enters.

Output level circuit

Operating condition of output transistor	ON when light enters	ON when light is blocked
Output circuit		
	<p>* Normally ON when light is blocked. However, if the (L) terminal and \oplus terminal are shorted, it changes to ON when light enters.</p>	
Time chart	<p>(“L” and “+” shorted)</p> <p>Light enters Light blocked</p> <p>Lighted indicator light (Red) Light ON Light Off</p> <p>Output Transistor ON OFF</p> <p>Load 1 (Relay) Operate Return</p> <p>Load 2 H L</p>	<p>(“L” and “+” open)</p> <p>Light enters Light blocked</p> <p>Lighted indicator light (Red) Light ON Light Off</p> <p>Output Transistor ON OFF</p> <p>Load 1 (Relay) Operate Return</p> <p>Load 2 H L</p>

LG1

LG1

LG1

LX

LC6D/LC6C

Switches