

M8/M12 Connector

Series *PCA/EX9/EX500*

Fieldwireable Connectors

Reduction in wiring time

The man-hours can be decreased because no exclusive tools (such as solder, crimped terminal) are required. Also, the wire length can be adjusted at the site.

QUICKON-ONE

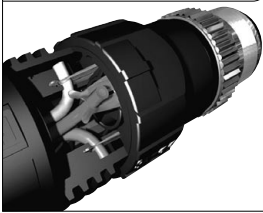

Piercecon®

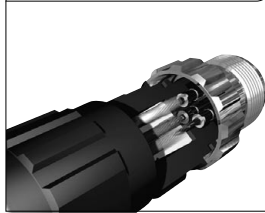

Spring-cage Connection



Conforming to IEC61076-2-101



SPEEDCON Reduction in wiring time

Just insert the connector and make 1/2 rotation.

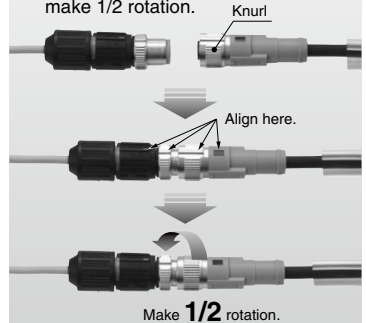

EX12□

EX140

EX180

EX260

EX250

EX600

EX500

EX510

PCA
EX□

IP67 (IEC60529)

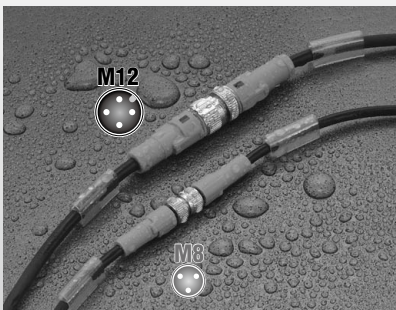

Conforming to IEC60947-5-2

The coloring and number indication to the electrical connection makes less wrong wiring.

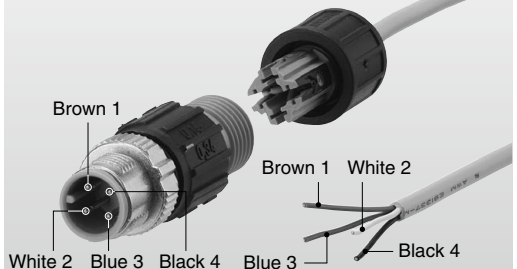

It provides the Fieldbus communication unit and input device applicable to

● Communication Cable/Connector ▶ P. 2158 to P. 2161

● It has a product lineup applicable to any communication standards.

The SMC Fieldbus (SI) Unit can be connected to the PLC (controller) and communication units of other manufacturers with cables with connectors and fieldwireable connectors (with shield) applicable to the standards of CC-Link, DeviceNet™, and PROFIBUS DP.



CC-Link

▶ P.2158

DeviceNet™

▶ P.2159

PROFI
BUS™

▶ P.2160

Communication cable	Fieldwireable communication connector	Terminal plug (Terminating resistor)
<div style="border: 1px solid black; border-radius: 10px; padding: 2px; display: inline-block; margin-bottom: 10px;">SPEEDCON</div> <p>Socket (Female)</p> <ul style="list-style-type: none"> ① For CC-Link ⑤ For DeviceNet™ ⑩ For PROFIBUS DP 	<p>Plug (Male)</p> <ul style="list-style-type: none"> ③ For CC-Link ⑦ For DeviceNet™ ⑫ For PROFIBUS DP 	<p>It is connected to the communication port of the communication unit connected at the end.</p> <div style="display: flex; justify-content: space-around; align-items: center;"> <div style="text-align: center;"> <p>⑨</p> <p>For DeviceNet™ (Plug)</p> </div> <div style="text-align: center;"> <p>⑭</p> <p>For PROFIBUS DP (Plug/B-coded)</p> </div> </div>
<div style="border: 1px solid black; border-radius: 10px; padding: 2px; display: inline-block; margin-bottom: 10px;">SPEEDCON</div> <p>Plug (Male)</p> <ul style="list-style-type: none"> ② For CC-Link ⑥ For DeviceNet™ ⑪ For PROFIBUS DP 	<p>Socket (Female)</p> <ul style="list-style-type: none"> ④ For CC-Link ⑧ For DeviceNet™ ⑬ For PROFIBUS DP 	

● Product Table

Description	Application	No.	SMC part no.	Name
Cable with connector	For Fieldbus communication	①	PCA-1567720	Communication cable for CC-Link (Socket)
		②	PCA-1567717	Communication cable for CC-Link (Plug)
		⑤	PCA-1557633	Communication cable for DeviceNet™ (Socket)
		⑥	PCA-1557646	Communication cable for DeviceNet™ (Plug)
		⑩	PCA-1557688	Communication cable for PROFIBUS DP (Socket/B-coded)
		⑪	PCA-1557691	Communication cable for PROFIBUS DP (Plug/B-coded)
Fieldwireable connector	For Fieldbus communication	③	PCA-1557617	Fieldwireable connector for CC-Link (Plug/Spring-caged)
		④	PCA-1557620	Fieldwireable connector for CC-Link (Socket/Spring-caged)
		⑦	PCA-1557659	Fieldwireable connector for DeviceNet™ (Plug/Spring-caged)
		⑧	PCA-1557662	Fieldwireable connector for DeviceNet™ (Socket/Spring-caged)
		⑫	PCA-1557701	Fieldwireable connector for PROFIBUS DP (Plug/B-coded/Spring-caged)
		⑬	PCA-1557714	Fieldwireable connector for PROFIBUS DP (Socket/B-coded/Spring-caged)
Terminal plug	For Fieldbus communication	⑨	PCA-1557675	Terminating resistor for DeviceNet™ (M12)
		⑭	PCA-1557727	Terminating resistor for PROFIBUS DP (M12/B-coded)

M8/M12 connector and the sensor/switch connected to them as a total system.

● Between Sensor/Switch and Input Device ▶ P. 2162 to P. 2165

● Connection between connectors and products

Pressure switch



Fieldwireable connector ▶ P.2163

It has a product lineup of the fieldwireable connector that does not need any special tools.
The lead wires can easily be made into M8/M12 connector by changing the wire length.

M8  Piercecon® connection

M12 SPEEDCON 

"QUICKON-ONE" connection

Cable with connector ▶ P.2164

The wiring can be changed accordingly.

M8  15

M12 SPEEDCON  18

M12 SPEEDCON  19

Input block

Input unit manifold
● Series EX500

Select the input block of the EX500 series according to the sensor output specification.

M12 

- EX500-IE3, 4
- EX500-IE1, 2
- EX500-IE5, 6

Manifold solenoid valve with input/output unit
● Series EX250

M12 



- EX250-IE1, 2
- EX250-IE3



Auto switch





Y connector ▶ P.2165

The input block reads 2 sensor signals with one port.
The wires of the auto switch and the pressure switch that has one output type can be decreased by unifying the signal wires using a Y connector.

M12 SPEEDCON  x 2 → M12 SPEEDCON  20

M12 SPEEDCON  x 2 → M12 SPEEDCON  21

M8  x 2 → M12 SPEEDCON 

M8/M12 connector (Fieldwireable/Pre-wired)

* 2-input type input block is the M12-type connector only.



Pre-wired type

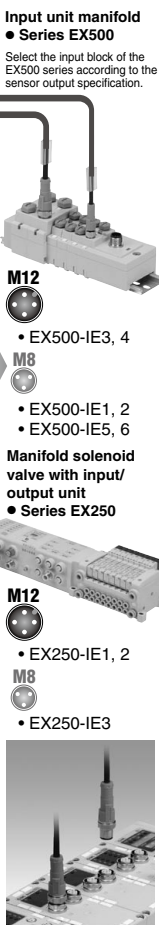



- EX1□
- EX140
- EX180
- EX260
- EX250
- EX600
- EX500
- EX510
- PCA EX□

● Product Table

Description	Application	No.	SMC part no.	Name
Cable with connector	For sensor 	16	PCA-1557769	Cable with M12 connector (4 pins/3 m)
		19	PCA-1557772	Cable with M8 connector (3 pins/3 m)
Fieldwireable connector	For sensor 	15	PCA-1557730	Fieldwireable connector (M8/3 pins/Plug/Piercecon® connection)
		16	PCA-1557743	Fieldwireable connector
		17	PCA-1557756	Fieldwireable connector (M12/4 pins/Plug/QUICKON-ONE connection/SPEEDCON)
Y connector	For sensor 	20	PCA-1557785	Y connector (2 x M12 (5 pins)-M12 (5 pins)/SPEEDCON)
		21	PCA-1557798	Y connector (2 x M8 (3 pins)-M12 (4 pins)/SPEEDCON)

Other M8/M12 Connector Accessories (EX500/EX250/EX9)

▶ P. 2166 to P. 2169

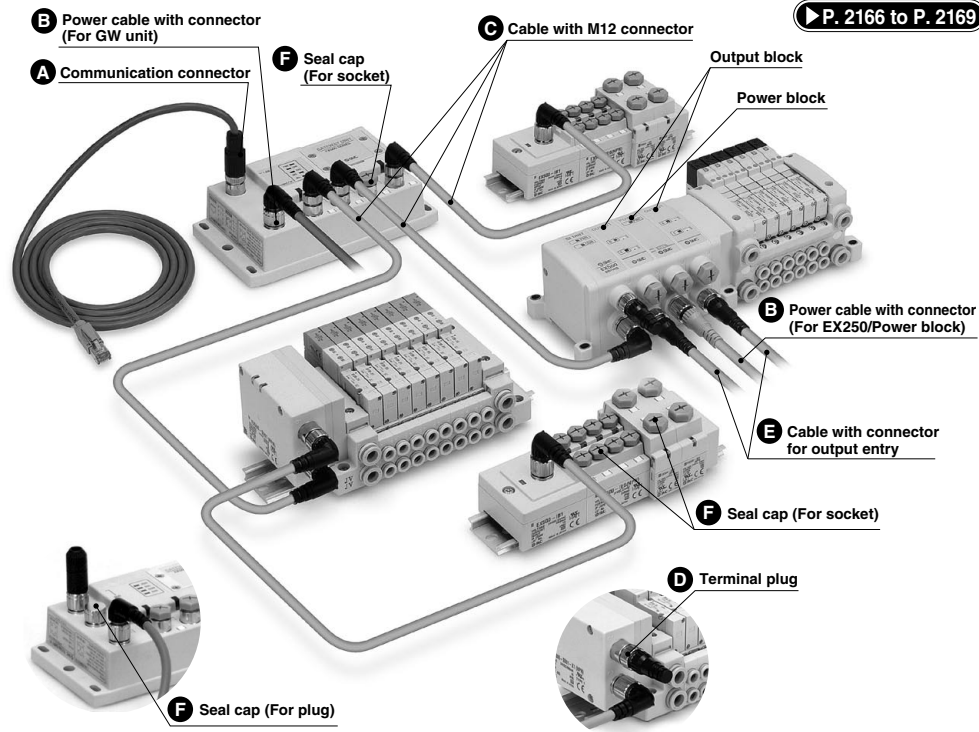

- | | | |
|--|---|---|
| <p>A Communication connector</p> <ul style="list-style-type: none"> • For DeviceNet™ (With cable) • For EtherNet/IP™ or EtherCAT (RJ45-M12, with cable) | <p>B Power cable with connector</p> <ul style="list-style-type: none"> • For GW unit (A-coded) • For EX250/Power block (B-coded) | <p>D Terminal plug (For EX500)</p> |
| <p>C Cable with M12 connector (For EX500)</p> | <p>E Cable with connector for output entry</p> | <p>F Seal cap</p> <ul style="list-style-type: none"> • For plug • For socket |

Other M8/M12 Connector Accessories (EX500/EX250/EX9)

Description	Application	No.	SMC part no.	Name
Cable with connector	For Fieldbus communication	A	EX500-AC□□□-DN	Communication cable for DeviceNet™ (Socket)
			EX9-AC020EN-PSRJ	Communication cable for EtherNet/IP™ or EtherCAT (M12 plug/D-coded-RJ45)
	For power supply	B	EX500-AP□□□-S	Power cable with connector (Socket/A-coded)
			EX9-AC□□□-1	Power cable with connector (Socket/B-coded)
	For EX500	C	EX500-AC□□□-SSPS	Cable with M12 connector (8 pins/Both straight)
			EX500-AC□□□-SAPA	Cable with M12 connector (8 pins/Both angle)
Terminal plug	For EX500	D	EX500-AC000-S	Terminal plug (M12/8 pins)
Seal cap	For plug	F	EX500-AWTP	Seal cap (M12/For plug)
			EX9-AWES	Seal cap (M8/For socket)
			EX9-AWTS	Seal cap (M12/For socket)



I N D E X

● Communication Cable/Connector

Example of Connection/Specifications

- CC-Link P.2158
- DeviceNet™ P.2159
- PROFIBUS DP P.2160

Dimensions P.2161

● Between Sensor/Switch and Input Device

Example of Connection P.2162

Specifications/Dimensions

- Fieldwireable connector P.2163
- Cable with connector P.2164
- Y connector P.2165

● Other Accessories

Example of Connection P.2166

How to Order/Dimensions P.2167

● Compatibility between Sensors and Fieldwireable Connectors P.2171

● American Wire Gauge Conversion Table P.2172

● Safety Instructions/Precautions P.2173

EX12□

EX140

EX180

EX260

EX250

EX600

EX500

EX510

PCA

EX□



Communication Cable/Connector

CC-Link

Example of Connection

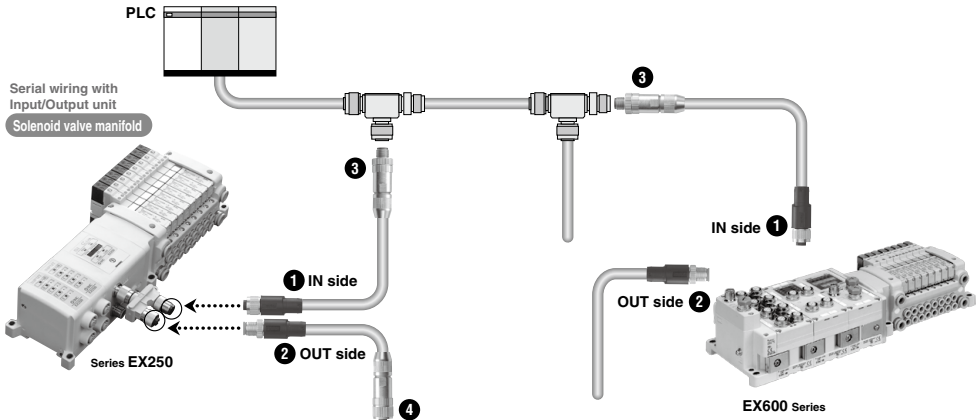

Specifications

Description		Communication cable (With one side connector)		Fieldwireable connector		
Part no.		PCA-1567720	PCA-1567717	PCA-1557617	PCA-1557620	
Product image						
		Socket	Plug	Plug	Socket	
Number of functional poles		M12: 4 poles				
Key type		A-coded (Normal key)				
Pin assignment						
		Plug, A-coded	Socket, A-coded	1: SLD (Shield wire) 2: DB (White) 3: DG (Yellow) 4: DA (Blue)		
Wiring (Note)	Fixed cable length	5 m		—		
	Cable O.D.	7.7 ±0.3 mm		Applicable cable	4.0 to 8.0 mm	
	Wire gauge (Stranded wire cross section)	0.5 mm ² /AWG20			0.14 to 0.5 mm ² /AWG26 to 20	
	Wire outer diameter (Including insulating material)	2.55 ±0.07 mm		—		
	Connection type	—		Spring-cage connection		
Rating/Performance	Rated current	—		4 A		
	Rated voltage	250 V		48 V		
	Contact resistance	—		≤5 mΩ		
	Insulation resistance	—		≥100 MΩ		
	Withstand voltage	—		1.4 kV		
	Ambient temperature	Connector	-25 to 90°C		-40 to 85°C	
			Cable	Operating	-20 to 60°C	
		Fixed		-20 to 60°C		—
	Protection class		IP67 (Only with screw tightened)			
	Allowable repeated insertion/withdrawal		200			
Cable retaining force		150 N/15 sec.		—		
Material	Material of knurl		Zinc die-cast		Brass	
	Contact (Surface treatment)		CuSn (Au plating (Ni plating))			
	Insulating material		Thermoplastic polyurethane (TPU)		Polyamide (PA6.6)	
	Material of sheath		Polyvinyl chloride (PVC)		—	
Weight		Approx. 306 g	Approx. 308 g	Approx. 48 g	Approx. 53 g	

Note) The shaded parts show the specifications for the applicable cable. Adaptation for the connector may vary on account of the conductor construction of the electric wire.

Communication Cable/Connector

M12



Example of Connection

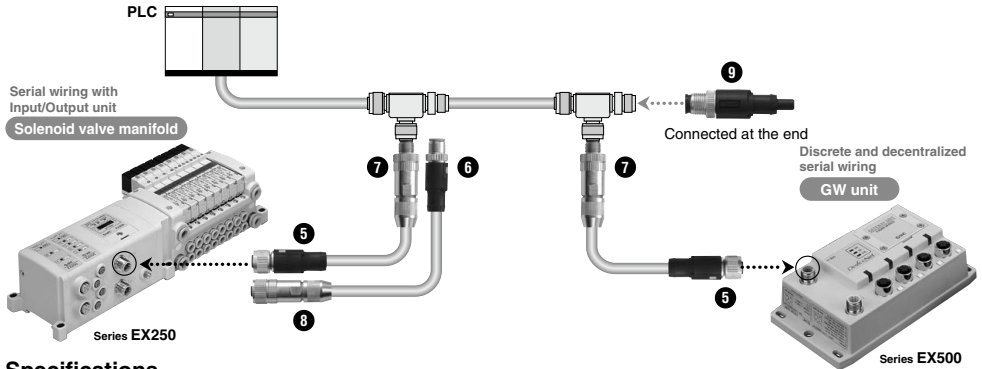

Specifications

Description		Communication cable (With one side connector)		Fieldwireable connector		Terminal plug	
Part no.		PCA-1557633	PCA-1557646	PCA-1557659	PCA-1557662	PCA-1557675	
Product image							
		Socket	Plug	Plug	Socket	For DeviceNet™ (Plug, A-coded)	
Number of functional poles		M12: 5 poles					
Key type		A-coded (Normal key)					
Pin assignment				DeviceNet™ / CANopen			
		Plug, A-coded	Socket, A-coded (Viewed from the plug/socket side)	1: DRAIN 2: V+ (Red) 3: V- (Black) 4: CAN H (White) 5: CAN L (Blue)	1: — 2: — 3: CAN GND 4: CAN H 5: CAN L	1: DRAIN: NC 2: V+: NC 3: V-: NC 4: CAN H 5: CAN L	
Wiring (Note)	Fixed cable length	5 m					
	Cable O.D.	6.70 ±0.3 mm			Applicable cable	4.0 to 8.0 mm	
		Power pair	0.33 mm ² /AWG22			—	
	Wire gauge (Stranded wire cross section)	Data pair	0.2 mm ² /AWG24			—	
		Power pair	1.4 ±0.05 mm			—	
Wire outer diameter (Including insulating material)	Data pair	2.05 ±0.10 mm			—		
Connection type		—				Spring-cage connection	
Rating/Performance	Rated current	4 A					
	Rated voltage	48 V					
	Contact resistance	≤5 mΩ					
	Insulation resistance	≥100 MΩ					
	Withstand voltage	1.0 kV					
	Ambient temperature	Connector	-25 to 90°C		-40 to 85°C		-25 to 90°C
		Cable	Operating	-20 to 75°C			—
			Fixed	-40 to 80°C			—
	Protection class	IP67 (Only with screw tightened)					
	Allowable repeated insertion/withdrawal	200					
Cable retaining force	150 N/15 sec.		—				
Material	Material of knurl	Zinc die-cast		Brass		Zinc die-cast	
	Contact (Surface treatment)	CuSn (Au plating (Ni plating))					
	Insulating material	Thermoplastic polyurethane (TPU)		Polyamide (PA6.6)		Thermoplastic polyurethane (TPU)	
	Material of sheath	Polyurethane (PUR)					
Weight	Approx. 308 g	Approx. 306 g	Approx. 47 g	Approx. 53 g	Approx. 12 g		

(Note) The shaded parts show the specifications for the applicable cable. Adaptation for the connector may vary on account of the conductor construction of the electric wire.

EX1□

EX140

EX180

EX260

EX250

EX600

EX500

EX510

PCA

EX□

Communication Cable/Connector

M12



PROFI
BUS

Example of Connection

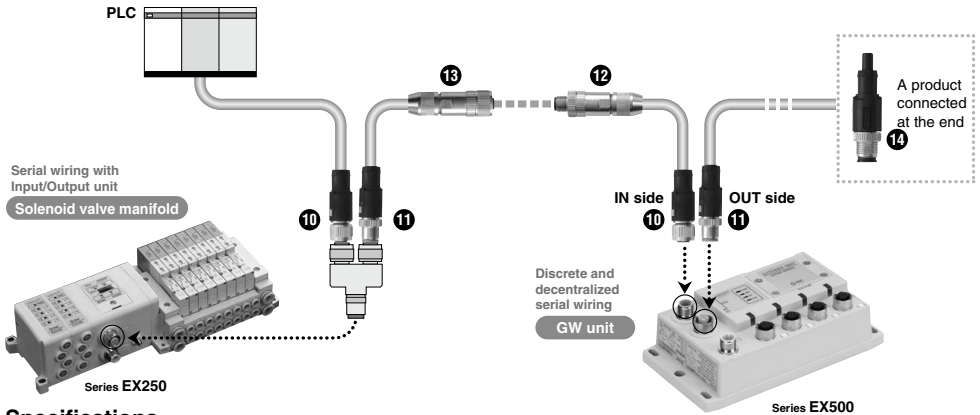

Specifications

Description		Communication cable (With one side connector)		Fieldwireable connector		Terminal plug	
Part no.		PCA-1557688	PCA-1557691	PCA-1557701	PCA-1557714	PCA-1557727	
Product image		10	11	12	13	14	
Number of functional poles		M12: 2 poles		M12: 3 poles		M12: 4 poles	
Key type		B-coded (Reverse key)					
Pin assignment		<p>Plug, B-coded (Viewed from the plug/socket side)</p>		<p>Plug, B-coded (Viewed from the plug/socket side)</p>		<p>1: VP 4: B Line 2: A Line 3: — 3: — 4: B Line (Red) 5: —</p>	
Wiring Note	Fixed cable length	5 m		—		—	
	Cable O.D.	7.80 ±0.2 mm		Applicable cable	4.0 to 8.0 mm		
	Wire gauge (Stranded wire cross section)	0.34 mm ² /AWG22			0.14 to 0.5 mm ² /AWG26 to 20		
	Wire outer diameter (Including insulating material)	2.55 ±0.07 mm		—		—	
Connection type	—		Spring-cage connection		—		
Rating/Performance	Rated current	4 A		—		—	
	Rated voltage	60 V		48 V		60 V	
	Contact resistance	—		≤5 mΩ		—	
	Insulation resistance	—		≥100 MΩ		—	
	Withstand voltage	—		1.4 kV		—	
	Ambient temperature	Connector	-25 to 90°C		-40 to 85°C		-25 to 90°C
		Cable	Operating	-20 to 80°C		—	
	Fixed		-40 to 85°C		—		—
	Protection class	IP67 (Only with screw tightened)					
	Allowable repeated insertion/withdrawal	200					
Cable retaining force	150 N/15 sec.		—		—		
Material	Material of knurl	Zinc die-cast		Brass		Zinc die-cast	
	Contact (Surface treatment)	CuSn (Au plating (Ni plating))					
	Insulating material	Polyamide (PA6.6)				Thermoplastic polyurethane (TPU)	
	Material of sheath	Polyurethane (PUR)		—		—	
Weight	Approx. 343 g	Approx. 356 g	Approx. 48 g	Approx. 54 g	Approx. 12 g		

Note) The shaded parts show the specifications for the applicable cable. Adaptation for the connector may vary on account of the conductor construction of the electric wire.

Dimensions

Communication cable (With one side connector)

CC-Link

- 1 PCA-1567720**
For CC-Link
(Socket)



Socket connector pin assignment
A-coded (Normal key)

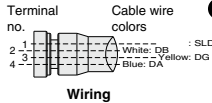
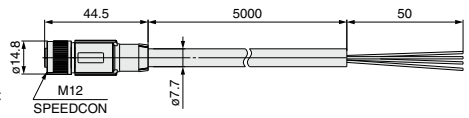

- 2 PCA-1567717**
For CC-Link
(Plug)



Plug connector pin assignment
A-coded (Normal key)

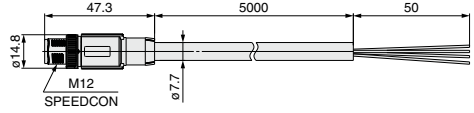

DeviceNet™

- 5 PCA-1557633**
For DeviceNet™
(Socket)



Socket connector pin assignment
A-coded (Normal key)

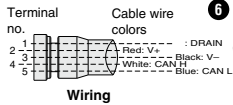
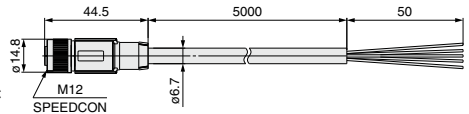

- 6 PCA-1557646**
For DeviceNet™
(Plug)



Plug connector pin assignment
A-coded (Normal key)

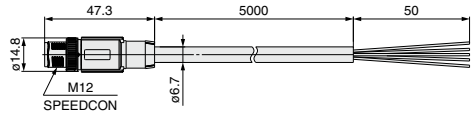

PROFI BUS

- 10 PCA-1557688**
For PROFIBUS DP
(Socket)



Socket connector pin assignment
B-coded (Reverse key)

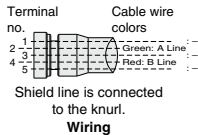
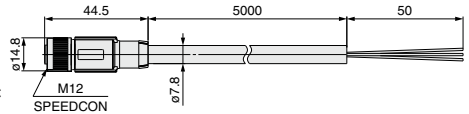

- 11 PCA-1557691**
For PROFIBUS DP
(Plug)



Plug connector pin assignment
B-coded (Reverse key)

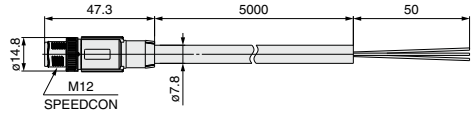

Fieldwireable connector

Plug

- 3 PCA-1557617** For CC-Link
7 PCA-1557659 For DeviceNet™
12 PCA-1557701 For PROFIBUS DP



A-coded
(Normal key)



B-coded
(Reverse key)

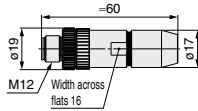

Socket

- 4 PCA-1557620** For CC-Link
8 PCA-1557662 For DeviceNet™
13 PCA-1557714 For PROFIBUS DP



A-coded
(Normal key)



B-coded
(Reverse key)

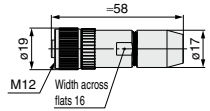

Terminal plug

DeviceNet™

- 9 PCA-1557675**
Terminating resistor
for DeviceNet™

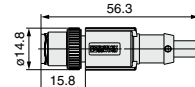

PROFI BUS

- 14 PCA-1557727**
Terminating resistor
for PROFIBUS DP

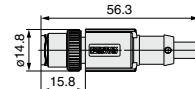

Between Sensor/Switch and Input Device

Example of Connection

1 Sensor with pre-wired connector
Direct connection between connectors

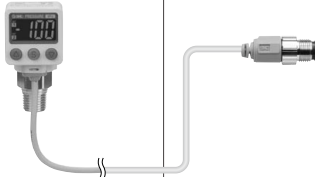

Cable with connector

▶ P.2164



Input block

Input unit manifold
● Series EX500



M12



● EX500-IE3, 4

M8



● EX500-IE1, 2
● EX500-IE5, 6

2 Sensor with lead wire entry
Lead wire → M8/M12 connector conversion

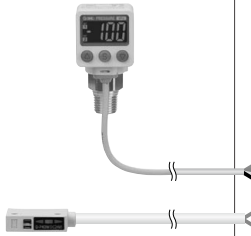

Fieldwireable connector ▶ P.2163

M12 SPEEDCON



"QUICKON-ONE" connection



M8 ferrecon connection



M12 SPEEDCON



18

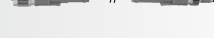

M8



19

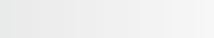

Manifold solenoid valve with input unit
● Series EX250

M12



● EX250-IE1, 2

M8



● EX250-IE3

3 Auto switch with pre-wired connector

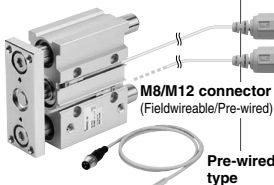

* Can be wired to the input block after converting 1-output signal to 2-output signal. (M12 only)

Y connector ▶ P.2165

M12 SPEEDCON x 2



20

M8 x 2



21

M12 SPEEDCON



18



Fieldwireable connector ▶ P.2163

M12 SPEEDCON



16



17



M8



15



4 Auto switch with lead wire entry
Lead wire → M8/M12 connector conversion

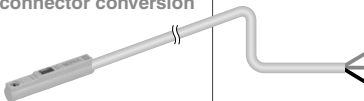



* Cut the cable into the necessary length, and wire with fieldwireable connectors.

Between Sensor/Switch and Input Device

Fieldwireable Connector

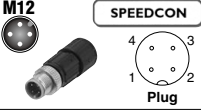
Specifications

Part no.	PCA-1557730	PCA-1557743	PCA-1557756	
Product image/Pin assignment	15 M8  Plug	16 M12 SPEEDCON  Plug	17 M12 SPEEDCON  Plug	
Number of functional poles	M8: 3 poles	M12: 4 poles		
Key type	—	A-coded (Normal key)		
Wiring (Note)	Applicable cable	3.0 to 5.0 mm	3.5 to 6.0 mm	4.0 to 8.0 mm
	Wire gauge (Stranded wire cross section)	0.14 to 0.25 mm ² /AWG26 to 24 0.25 to 0.34 mm ² /AWG24 to 22	0.14 to 0.34 mm ² /AWG26 to 22	0.34 to 0.75 mm ² /AWG22 to 18
	Core wire diameter (including insulating material)	1.0 to 1.6 mm	0.7 to 1.3 mm	1.3 to 2.5 mm
Connection type	Piercecon® connection	QUICKON-ONE connection		
Rated current	4 A			
Rated voltage	60 V	250 V		
Contact resistance	≤ 5 mΩ			
Insulation resistance	≥ 100 MΩ			
Withstand voltage	1.0 kV	1.4 kV		
Ambient temperature	-40 to 85°C	-25 to 80°C		
Protection class	IP67 (Only with screw tightened)			
Allowable repeated insertion/withdrawal	100	200		
Allowable number of repeated connection between conductors of the same cross section	10			
Material	Brass	Zinc die-cast		
Contact (Surface treatment)	CuZn (Au plating (Ni plating))			
Insulating material	Polyamide (PA6.6)			
Weight	Approx. 14 g	Approx. 13 g	Approx. 15 g	

Note) The shaded parts show the specifications for the applicable cable. Adaptation for the connector may vary on account of the conductor construction of the electric wire.

Dimensions

15 PCA-1557730

Fieldwireable connector (M8)

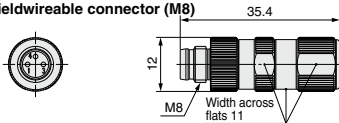

Plug connector pin assignment

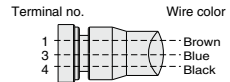

Wiring

16 PCA-1557743

Fieldwireable connector (M12)

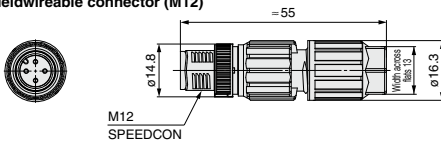

Plug connector pin assignment
A-coded (Normal key)

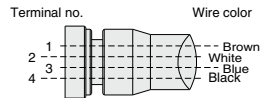

Wiring

17 PCA-1557756

Fieldwireable connector (M12)

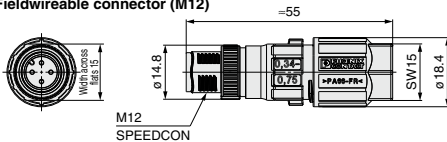

Plug connector pin assignment
A-coded (Normal key)

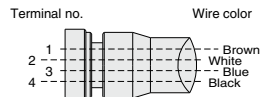



Wiring

Between Sensor/Switch and Input Device

Cable with Connector

Specifications

Part no.	PCA-1557769	PCA-1557772			
Product image					
Number of functional poles	M12: 4 poles	M8: 3 poles			
Key type	A-coded (Normal key)	—			
Wiring	Fixed cable length	3 m			
	Cable O.D.	4.7 ±0.15 mm	4.4 ±0.15 mm		
	Wire gauge (Stranded wire cross section)	0.34 mm ² /AWG22	0.25 mm ² /AWG24		
Rating/Performance	Rated current	4 A			
	Rated voltage	250 V	60 V		
	Contact resistance	≤5 mΩ			
	Insulation resistance	≥100 MΩ			
	Withstand voltage	1.4 kV	1.0 kV		
	Ambient temperature	Connector	-25 to 90°C		
			Cable	Operating	-5 to 80°C
				Fixed	-40 to 80°C
	Protection class	IP67 (Only with screw tightened)			
	Allowable repeated insertion/withdrawal	200			
Cable retaining force	150 N/15 sec.	250 N/15 sec.			
Material	Material of knurl	Zinc die-cast			
	Contact (Surface treatment)	CuSn (Au plating (Ni plating))			
	Insulating material	Thermoplastic polyurethane (TPU)			
	Material of sheath	Polyurethane Black (PUR Black)			
Weight	Approx. 111 g	Approx. 80 g			

Dimensions

18 PCA-1557769

Cable with M12 connector (4 poles)

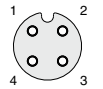
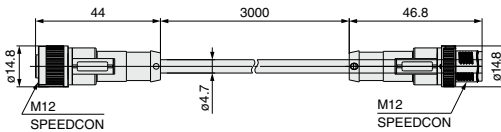

Socket connector pin assignment
A-coded (Normal key)

Wiring



Plug connector pin assignment
A-coded (Normal key)

19 PCA-1557772

Cable with M8 connector (3 poles)

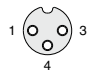
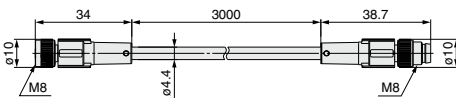

Socket connector pin assignment

Wiring



Plug connector pin assignment

Between Sensor/Switch and Input Device

Y Connector

Specifications

Part no.	PCA-1557785	PCA-1557798
Product image		
Number of functional poles	2 x M12: 5 poles – M12: 5 poles	2 x M8: 3 poles – M12: 4 poles
Key type	A-coded (Normal key)	
Rating/Performance	Rated current	4 A
	Rated voltage	60 V
	Contact resistance	≤ 5 mΩ
	Insulation resistance	≥ 100 MΩ
	Withstand voltage	1.0 kV
	Ambient temperature	-25 to 90°C
	Protection class	IP67 (Only with screw tightened)
Allowable repeated insertion/withdrawal	200	
Material	Material of knurl	Zinc die-cast
	Contact (Surface treatment)	CuZn (Au plating (Ni plating))
	Insulating material	Thermoplastic polyurethane (TPU)
Weight	Approx. 29 g	Approx. 13 g

Dimensions

20 PCA-1557785
Y connector
(2 x M12-M12)

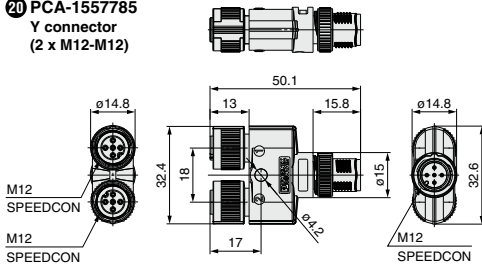

Socket connector
pin assignment
A-coded (Normal key)

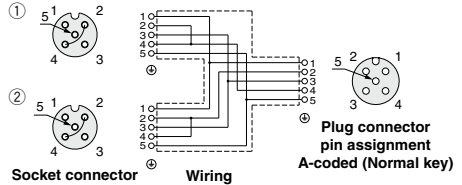

21 PCA-1557798
Y connector
(2 x M8-M12)

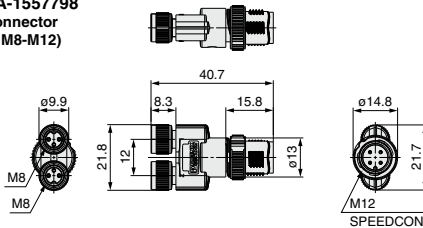

Socket connector
pin assignment

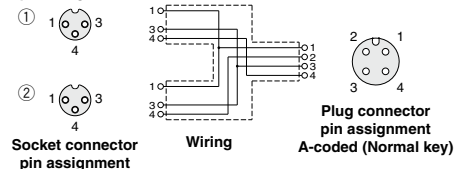

- EX1□
- EX140
- EX180
- EX260
- EX250
- EX600
- EX500
- EX510
- PCA EX□

Other Accessories

M8/M12 Connector Accessories (EX500/EX250/EX9)

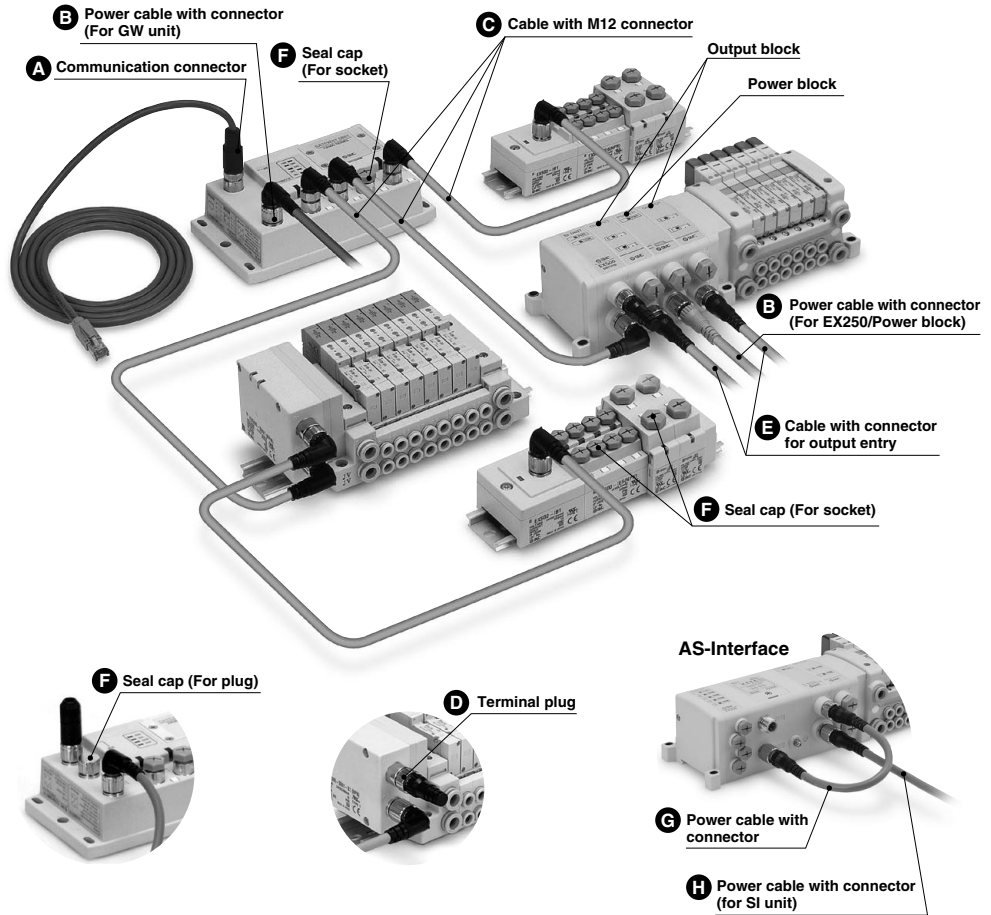

A Communication connector

- For DeviceNet™ (with cable)
- For EtherNet/IP™ or EtherCAT (RJ45-M12, with cable)

B Power cable with connector

- For GW unit (A-coded)
- For EX250/Power block (B-coded)

C Cable with M12 connector (For EX500)

D Terminal plug (For EX500)

E Cable with connector for output entry

F Seal cap

- For plug
- For socket

G Power cable with connector

H Power cable (for SI unit)

A Communication connector

For DeviceNet™

EX500-AC 050 - DN

Cable length (L)

010	1000 [mm]
050	5000 [mm]

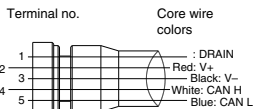
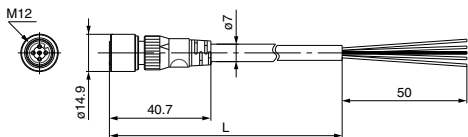

Socket connector pin arrangement

Wiring

For EtherCAT or PROFINET SI unit

EX9-AC 020 EN - PSRJ

Cable length (L)

010	1000 [mm]
020	2000 [mm]
030	3000 [mm]
050	5000 [mm]
100	10000 [mm]

Connector specification

PSRJ	M12 plug (Straight) ⇔ RJ-45 connector
------	--

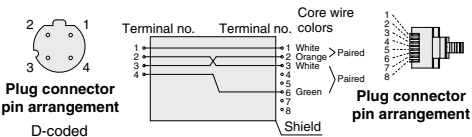
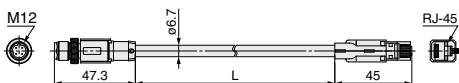

Plug connector pin arrangement
D-coded

Wiring (Straight cable)

B Power cable with connector (For GW unit, SI unit (A-coded))

EX500-AP 050 - S

Cable length (L)

010	1000 [mm]
050	5000 [mm]

Connector specification

S	Straight
A	Angle

Straight connector type

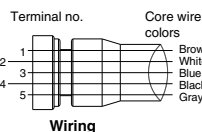
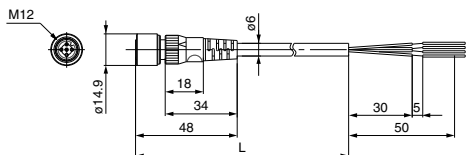

Socket connector pin arrangement

Wiring

Angle connector type

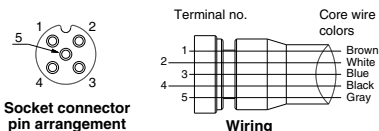
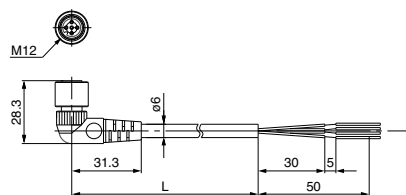

Socket connector pin arrangement

Wiring

EX10

EX140

EX180

EX260

EX250

EX600

EX500

EX510

PCA

EX

Other Accessories

M8/M12 Connector Accessories (EX500/EX250/EX9)

Ⓑ Power cable with connector (For EX250/Power block (B-coded))

EX9 – AC 050 – 1

Cable length (L)

010	1000 [mm]
030	3000 [mm]
050	5000 [mm]

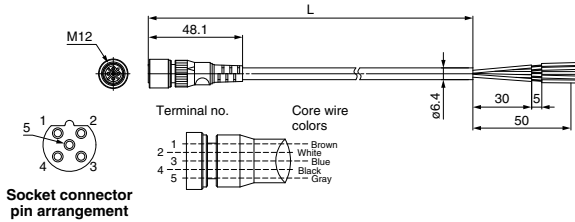

Ⓒ Cable with M12 connector

EX500 – AC 030 – SSPS

Cable length (L)

003	300 [mm]
005	500 [mm]
010	1000 [mm]
030	3000 [mm]
050	5000 [mm]

Connector specification

SSPS	Socket side: Straight, Plug side: Straight
SAPA	Socket side: Angle, Plug side: Angle

Straight connector type

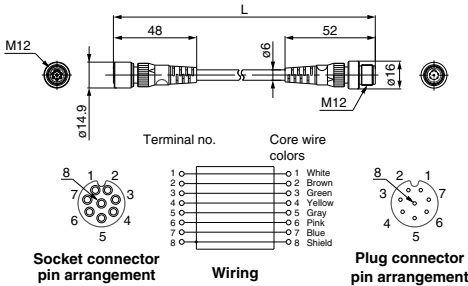

Angle connector type

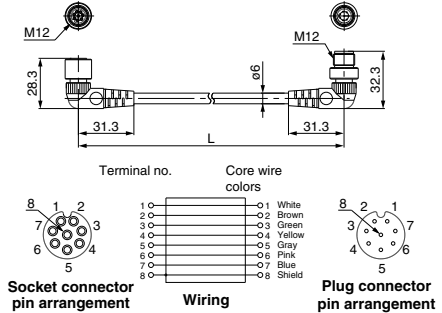

Ⓓ Terminal plug

This is used where an input unit manifold (input unit/input block) is not being used.
(If a terminal plug is not used, the GW unit's COM LED will not light up.)

EX500 – AC000 – S

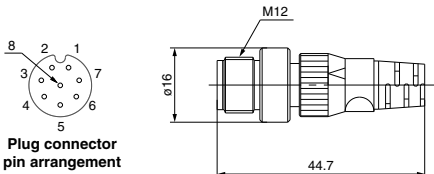

③ Cable with connector for output entry

EX9-AC 030-7

Cable length (L)

010	1000 [mm]
030	3000 [mm]

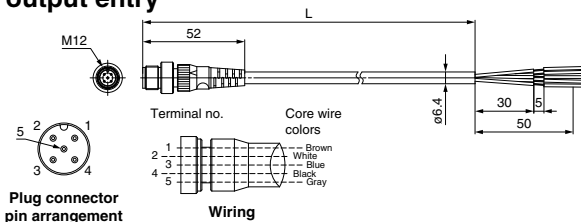

Plug connector pin arrangement

Wiring

④ Seal cap: M12 connector (For plug)

Use this on ports that are not being used for a M12 connector (plug). Use of this waterproof cap maintains the integrity of the enclosure.

Note) Tighten the waterproof cap with the prescribed tightening torque. (For M12: 0.1 N·m)

EX500-AWTP

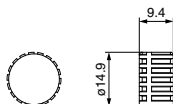

④ Seal cap: M8, M12 connector (For socket)/Accessories

Use this on ports that are not being used for a M8, M12 connector (socket).

Use of this waterproof cap maintains the integrity of the enclosure. (Waterproof cap is packed together with each unit.)

Note) Tighten the waterproof cap with the prescribed tightening torque. (For M8: 0.05 N·m, For M12: 0.1 N·m)

EX9-AW

Connector type

ES	M8 connector (For socket, 10 pcs.)
TS	M12 connector (For socket, 10 pcs.)

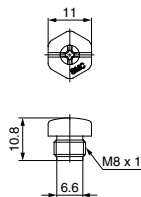

M8 connector (For socket)

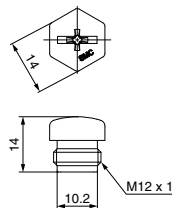

M12 connector (For socket)

EX12

EX140

EX180

EX260

EX250

EX600

EX500

EX510

PCA

EX

Other Accessories

M8/M12 Connector Accessories (EX500/EX250/EX9)

G Power cable with connector

Connects between the power supply connector for the power block and the SI unit power supply connector, bridging the external power supply, which is supplied with the power block, to the SI unit.

EX9-AC002-2

SI unit type	
2	EX250-SDN1 EX250-SMJ2 EX250-SCA1A } Compliant
3	EX250-SPR1 EX250-SEN1 } Compliant
4	EX250-SAS3/5 Compliant

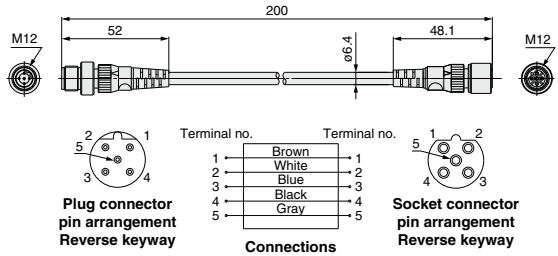

EX9-AC002-3

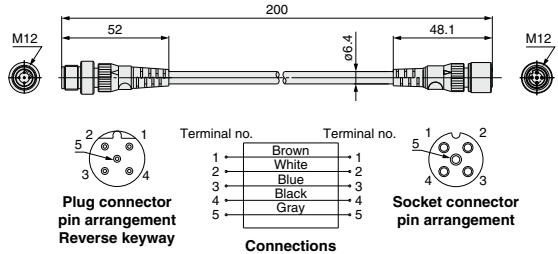

EX9-AC002-4

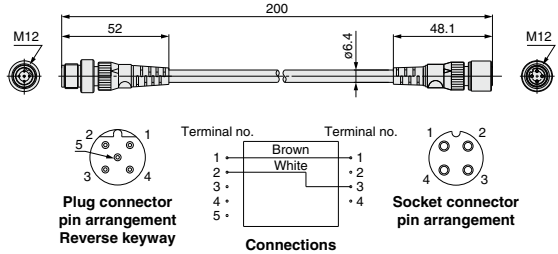

H AS-Interface power cable

Cable connecting between AS-Interface power supply line (for external devices) branch connector (M12) and the power block's power supply input connector.

EX9-AC010-5

Cable length (L)	
010	1000 [mm]
030	3000 [mm]
050	5000 [mm]

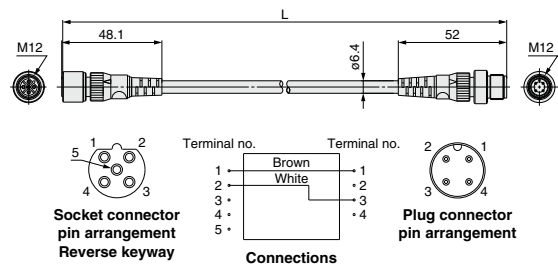

Compatibility between Sensors and Fieldwireable Connectors

● : Applicable

▲ : Applicable, but number of electric wire cores is limited. (Number of sensor lead wire cores is larger than the number of connector pins.)

△ : Connectable, but may not correspond to IP65/67 depending on installation method. X : Non-conformance

Auto Switch

Model	Cable part no.	Number of cores	Applicable connector			Cable specifications						Note	
			M8	M12	O.D.	Sheath		Insulator		Conductor			
			15	16		17	O.D.	Material	O.D.	Material	Nominal cross section		O.D.
D-P4DW□	Integrated type	2	X	X	●	ø6	PVC	ø1.9	PVC	0.5 mm ²	ø0.9	0.08 mm	
D-M9BA□ D-M9BAV□	Integrated type	2	●	△	X	2.7 x 3.2	PVC	ø0.9	PVC	0.15 mm ²	ø0.5	0.05 mm	
D-M9NA□ D-M9PA□ D-M9NAV□ D-M9PAV□	Integrated type	3	●	△	X	2.7 x 3.2	PVC	ø0.9	PVC	0.15 mm ²	ø0.5	0.05 mm	
D-M9B□ D-M9BV□ D-M9BW□ D-M9BWV□	Integrated type	2	●	△	X	2.7 x 3.2	PVC	ø0.9	PVC	0.15 mm ²	ø0.5	0.05 mm	
D-M9N□ D-M9P□ D-M9NV□ D-M9PV□ D-M9NW□ D-M9PW□ D-M9WV□ D-M9PWV□	Integrated type	3	●	△	X	2.7 x 3.2	PVC	ø0.9	PVC	0.15 mm ²	ø0.5	0.05 mm	

Pressure Switch

Model	Cable part no.	Number of cores	Applicable connector			Cable specifications						Note	
			M8	M12	O.D.	Sheath		Insulator		Conductor			
			15	16		17	O.D.	Material	O.D.	Material	Nominal cross section		O.D.
Z/ISE30A□	ZS-38-4□	4	●	●	X	ø3.5	PVC	ø1.0	PVC	0.20 mm ² (AWG26)	ø0.58	0.08 mm	
	ZS-38-3□	3											
ISE35□	ZS-32-A□	3	●	●	X	ø3.4	PVC	ø1.1	PVC	0.20 mm ² (AWG25)	ø0.58	0.08 mm	
Z/ISE40A□-□	Integrated type	5	▲	▲	X	ø3.5	PVC	ø0.95	PVC	0.15 mm ² (AWG26)	ø0.51	0.08 mm	
ISE70/75(H)□	ZS-31-B	4	▲	●	X	ø4.0	PVC	ø1.14	PVC	0.30 mm ² (AWG23)	ø0.72	0.08 mm	Straight
	ZS-31-C		▲	●	X								Angle
Z/ISE80□-□	Integrated type	5	▲	▲	X	ø3.5	PVC	ø0.95	PVC	0.15 mm ² (AWG26)	ø0.51	0.08 mm	
		4	▲	●	X								
		3	●	●	X								
ISA2□	ISA-8-A	4	X	X	●	ø6.0	PVC	ø1.72	PVC	0.53 mm ² (AWG21)	ø0.9	0.18 mm	Straight
	ISA-8-B		X	X	●								Angle

EX1□

EX140

EX180

EX260

EX250

EX600

EX500

EX510

PCA

EX□

Flow Switch

Model	Cable part no.	Number of cores	Applicable connector			Cable specifications						Note	
			M8	M12	O.D.	Sheath		Insulator		Conductor			
			15	16		17	O.D.	Material	O.D.	Material	Nominal cross section		O.D.
PF2A7□ PF2W7□	ZS-37-A	4	▲	●	X	ø4.0	PVC	ø1.14	PVC	AWG23	ø0.72	0.08 mm	Straight
	ZS-37-B		▲	●	X								Angle
PFM7□	ZS-33-D	4	▲	●	X	ø3.5	PVC	ø1.00	PVC	AWG26	ø0.50	0.08 mm	

Note) Information on cable specifications is based on specification sheets supplied by the manufacturer.

American Wire Gauge Conversion Table

This table shows to change American wire gauge (AWG) into a diameter.

The wire material is indicated as AWG (American wire gauge) in the documentations overseas.

Use the following table for conversion into diameter.

Wire size (AWG)	Diameter (mm)	Cross section (mm ²)
1	7.348	42.3846
2	6.543	33.6065
3	5.827	26.6538
4	5.189	21.1367
5	4.62	16.7554
6	4.115	13.2926
7	3.665	10.5443
8	3.264	8.3632
9	2.906	6.6292
10	2.588	5.2577
11	2.304	4.1671
12	2.052	3.3054
13	1.829	2.6260
14	1.628	2.0806
15	1.45	1.6505
16	1.29	1.3063

Wire size (AWG)	Diameter (mm)	Cross section (mm ²)
17	1.151	1.0400
18	1.024	0.8231
19	0.912	0.6529
20	0.813	0.5189
21	0.724	0.4115
22	0.643	0.3246
23	0.574	0.2586
24	0.511	0.2050
25	0.455	0.1625
26	0.404	0.1281
27	0.361	0.1023
28	0.32	0.0804
29	0.287	0.0647
30	0.254	0.0506
31	0.226	0.0401
32	0.203	0.0323

Wire size (AWG)	Diameter (mm)	Cross section (mm ²)
33	0.18	0.0254
34	0.16	0.0201
35	0.142	0.0158
36	0.127	0.0127
37	0.114	0.0102
38	0.102	0.0082
39	0.089	0.0062
40	0.079	0.0049
41	0.071	0.0040
42	0.064	0.0032
43	0.056	0.0025
44	0.051	0.0020
45	0.045	0.0016
46	0.04	0.0013



Cable/Connector Accessories Precautions

Be sure to read this before handling.

Wiring

⚠ Caution

1. Do not lay the wires while they are energized. It may give you an electric shock.
2. It should be cabled according to the connection diagram.
3. Check if it can be connected when using a sensor or switch.
4. When the cable sheath is stripped, confirm the stripping direction.

(For SMC switches with oblong cables)

The insulator may be split or damaged depending on the direction.

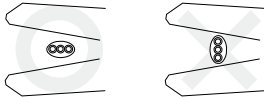

Tightening of Screw

⚠ Caution

1. It cannot maintain the enclosure (IP6○) or the screws may be loosened if they are not tightened sufficiently.
2. Check that they are tightened enough at appropriate intervals during the operation.

Connection and Disconnection of Connector

⚠ Caution

1. Be sure to turn the power off when connecting and disconnecting the connectors.
2. Do not touch surface of the engagement with wet hands.
3. Do not pull the cable out by holding the cable.
4. Note the key direction.

Especially for the SPEEDCON specifications, match the protrusion of the knurl (bracket) and the mark at the mold for insertion so that the SPEEDCON function can be maintained.

5. When engaging the connectors, insert the connectors enough until all the engagement surfaces can be hidden and tighten the screws not to damage the thread ridges.

Handling of Cable with Connector

⚠ Caution

1. Avoid repeatedly bending or stretching the cable and applying a heavy object or force to it.
2. Set up the cables to the place where they cannot be stepped on in order to prevent them being broken or damage to the connectors.

Install a protective cover in case it is used in the place stated above.

3. Do not pull the connector or cable unnecessarily. It may damage the connectors or break the cables.
4. Do not bend the cable at the root of the connector when installed.

Handling of Fieldwireable Connector

⚠ Caution

Common Precautions

1. Follow "Assembly Procedure" provided by SMC. If not, it may not maintain IP65/67.
2. Do not use it besides an original purpose.
3. This connector may only be operated when under no load.
4. The work by the wet hand causes the electric shock.
5. Never perform the repair.

Spring-cage Connection

1. Do not use it besides an original purpose.
2. This connector may only be operated when under no load.
3. The work by the wet hand causes the electric shock.
4. Never perform the repair.

QUICKON-ONE Connection

1. Connection between cables (with the same material and the same cross section) is 10 times at max.
2. PVC or PE is suitable for sheath material, however fluoro resin is not suitable for sheath material.
3. Only for flexible cable, not for solid cable.
4. When you remove the cable, pull the cable. However, if you remove the Cable gland, cable and the Splice ring remain to the body.

When you connect the cable again, screw the Splice ring approx. two turns into the Cable gland before using.

5. When you connect the cable again, cut and strip the cable.

Piercecon® Connection

1. Connection between cables (with the same material and the same cross section) is 10 times at max.
2. Only for flexible cable, not for solid cable.
3. If you connect the cable again, cut and strip the cable.

Operating Environment

⚠ Caution

1. Do not use in the atmosphere and environment over the rated specifications.
2. Do not use in the environment of corrosive gas or liquid splash.
3. Do not use in an environment where oil and chemicals are used.

Maintenance

⚠ Caution

1. Perform periodic inspection.

EX1□

EX140

EX180

EX260

EX250

EX600

EX500

EX510

PCA

EX□