

High Durability Series

# Longer Life Cylinder

New

RoHS

## New technology offers at least 4 times better durability

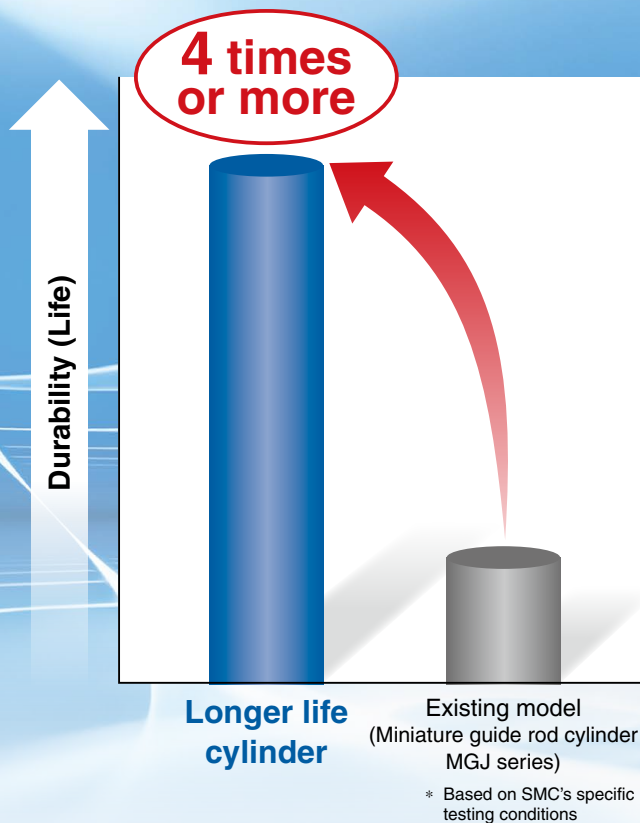

- Employs the same specification and mounting dimensions as the existing models, MGJ Miniature Guide Rod Cylinder series

### High Durability Series

High Durability Series is the series name for the "special specification" that offers superior durability and environmental resistance compared to standard products.

### Series Variations

Series	Action	Model	Bore size [mm]		Cushion	Standard stroke [mm]
			6	10		
Miniature guide rod cylinder MGJ series 	Double acting	<b>MGJ-XB24</b>	●	●	Rubber bumper	ø6 : 5, 10, 15 ø10: 5, 10, 15, 20

# MGJ-XB24



CAT.ES20-295A

## High Durability Series

# Longer Life Cylinder

# MGJ-XB24

ø6, ø10

RoHS

## How to Order

MGJ **6** - **10** - **F8N** **4** - XB24

Miniature guide rod cylinder

Longer life cylinder

### 1 Bore size

6	6 mm
10	10 mm

### 2 Standard stroke

Bore size [mm]	Standard stroke [mm]
6	5, 10, 15
10	5, 10, 15, 20

### 3 Auto switch

Nil	Without auto switch (Built-in magnet)
-----	---------------------------------------

### 4 Number of auto switches

Nil	2
S	1

**Applicable Auto Switches** / Refer to the **Web Catalog** for further information on auto switches.

Type	Special function	Electrical entry	Indicator light	Wiring (Output)	Load voltage		Auto switch model			Applicable load		
					DC	Direct mounting	Lead wire length [m]					
							0.5 (Nil)	3 (L)	5 (Z)			
Solid state auto switch	—	Grommet (Perpendicular)	Yes	3-wire (NPN)	24 V	5 V, 12 V	F8N	●	●	○	IC circuit	Relay, PLC
				3-wire (PNP)			F8P	●	●	○		
				2-wire	12 V	F8B	●	●	○	—		

\* Lead wire length symbols: 0.5 m..... Nil (Example) F8N  
 3 m..... L (Example) F8NL  
 5 m..... Z (Example) F8NZ

\* Auto switches marked with a "○" are produced upon receipt of order.  
 \* When using non-applicable auto switches, please contact SMC.  
 \* Auto switches are shipped together with the product but do not come assembled.



## Specifications

Bore size [mm]	6	10
<b>Action</b>	Double acting	
<b>Fluid</b>	Air	
<b>Proof pressure</b>	1.05 MPa	
<b>Max. operating pressure</b>	0.7 MPa	
<b>Min. operating pressure</b>	0.15 MPa	
<b>Ambient and fluid temperatures</b>	-10 to 60°C (No freezing)	
<b>Cushion</b>	Rubber bumper on both ends	
<b>Lubrication</b>	Non-lube	
<b>Piston speed</b>	50 to 500 mm/s*1	
<b>Stroke length tolerance</b>	+1.0 0 mm	
<b>Port size</b>	M3 x 0.5	
<b>Guide size</b>	ø5	ø6

\*1 Within allowable kinetic energy use only

## ⚠ Caution

This product should not be used as a stopper.

### Symbol

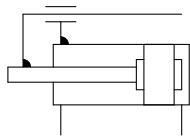

Rubber bumper

The mounting pitch and shape of this product with auto switch are the same as those of the Miniature Guide Rod Cylinder MGJ series with auto switch.  
For details, refer to the **Web Catalog**.

- Auto Switch Proper Mounting Position (Detection at stroke end)
- Auto Switch Mounting

## ⚠ Precautions

Refer to page 4 before handling the products.

The allowable rotational torque of the plate, non-rotating accuracy of the plate, allowable kinetic energy, allowable lateral load of the plate, and allowable eccentric load are equivalent to those of the Miniature Guide Rod Cylinder MGJ series. For details, refer to the **Web Catalog**.

## Dimensions

**ø6**

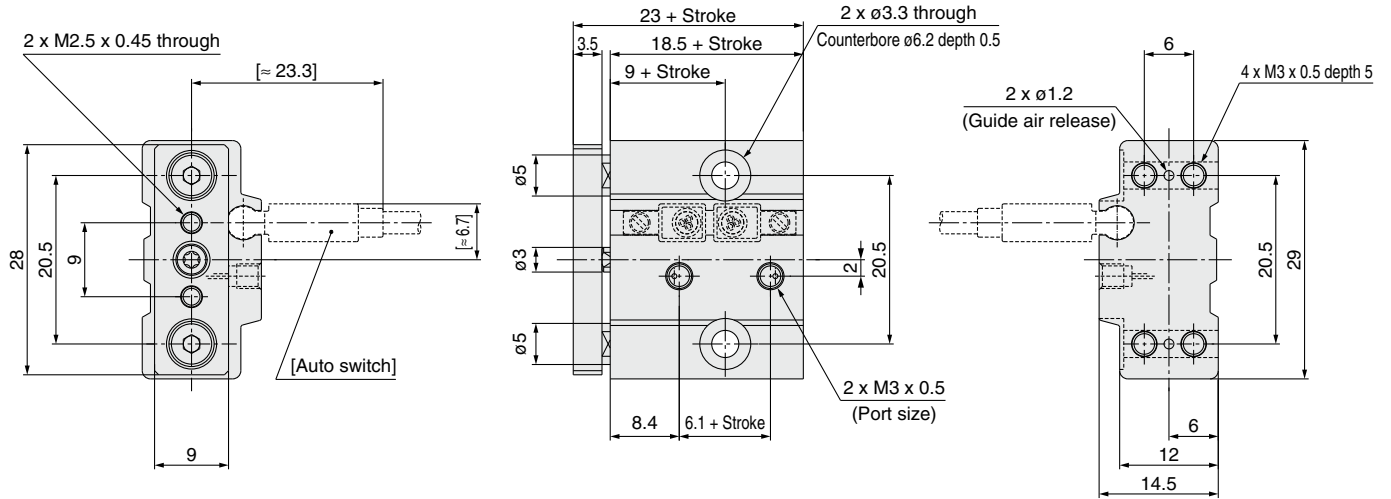

**ø10**

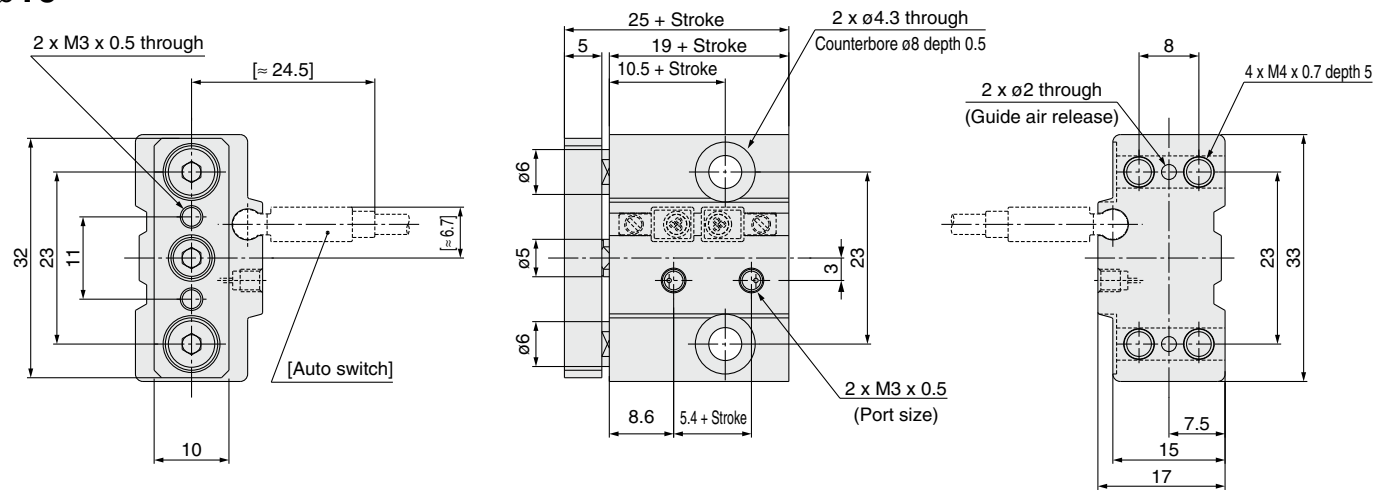

# Specific Product Precautions



Be sure to read this before handling the products. Refer to the back cover for safety instructions. For actuator and auto switch precautions, refer to the “Handling Precautions for SMC Products,” the “Operation Manual,” and miniature guide rod cylinder MGJ series specific product precautions on the SMC website: <https://www.smcworld.com>

## Mounting

### Warning

1. Never place your hands or fingers between the plate and the body.

Be very careful to prevent your hands or fingers from getting caught in the gap between the cylinder body and the plate when air is applied.

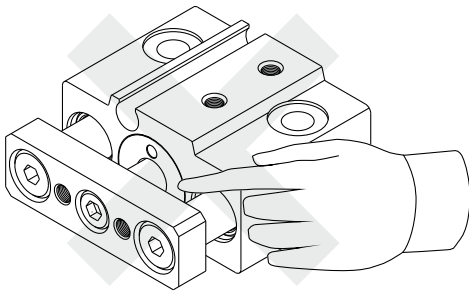

### Caution

1. Do not scratch or gouge the sliding portion of the piston rod and the guide rod.

Damaged seals, etc., will result in leakage or malfunction.

2. When mounting the miniature guide rod cylinder with screws, do not exceed the max. tightening torque. (The torque may vary depending on the material of the mounting side.)

Model	Bolt	Max. tightening torque [N·m]	
		Top mounting	Bottom mounting
MGJ6	M3 x 0.5	1.2	0.3
MGJ10	M4 x 0.7	2.7	0.7

Top mounting

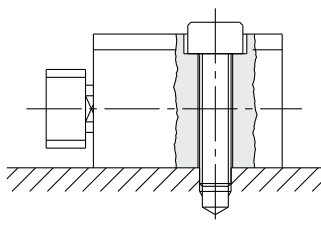

Bottom mounting

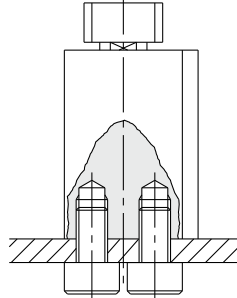

3. Keep the flatness of the mounting surface 0.02 mm or less.

When mounting the miniature guide rod cylinder to the application or when mounting a workpiece to the plate, it will cause operation failure if the flatness of the mounting surface is more than 0.02 mm.

4. Be sure that the piston rods are retracted when mounting loads.

If loads are mounted on the plate when the piston rods are extended, it can lead to distortion of the guide unit, resulting in a malfunction.

## Mounting

### Caution

5. When mounting the load with screws, do not exceed the max. tightening torque. (The torque may vary depending on the material of the load.)

Model	Bolt	Max. tightening torque [N·m]
MGJ6	M2.5 x 0.45	0.5
MGJ10	M3 x 0.5	1.0

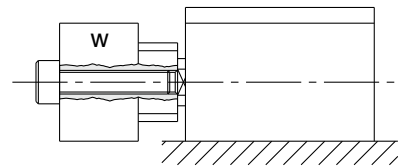

6. When the cylinder output is directly applied to the moving parts of the cylinder, such as when clamping a workpiece, be sure to apply the cylinder output to the center of the cylinder (along the rod axial line).

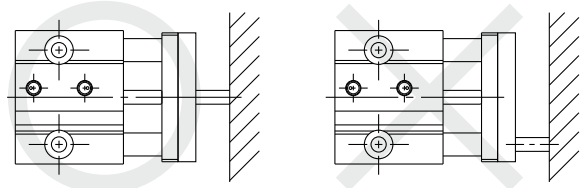

## Lubrication

### Caution

1. This product should be used without lubrication. The use of lubrication can cause a reduction in the products lifetime.

## Durability of The Cylinder

The durability of a longer life cylinder has been evaluated by comparison with the existing cylinders under SMC's test conditions.

The durability of a cylinder depends on the customer's operating conditions and operating environment.

Therefore, durability of four times or longer will not be guaranteed under all conditions.

## Others

### Caution

1. This product should not be used as a stopper.

## Safety Instructions

These safety instructions are intended to prevent hazardous situations and/or equipment damage. These instructions indicate the level of potential hazard with the labels of “**Caution**,” “**Warning**” or “**Danger**.” They are all important notes for safety and must be followed in addition to International Standards (ISO/IEC)\*1), and other safety regulations.

 **Caution:** **Caution** indicates a hazard with a low level of risk which, if not avoided, could result in minor or moderate injury.

 **Warning:** **Warning** indicates a hazard with a medium level of risk which, if not avoided, could result in death or serious injury.

 **Danger :** **Danger** indicates a hazard with a high level of risk which, if not avoided, will result in death or serious injury.

\*1) ISO 4414: Pneumatic fluid power – General rules relating to systems.  
ISO 4413: Hydraulic fluid power – General rules relating to systems.  
IEC 60204-1: Safety of machinery – Electrical equipment of machines.  
(Part 1: General requirements)  
ISO 10218-1: Manipulating industrial robots – Safety.  
etc.

### Warning

#### 1. The compatibility of the product is the responsibility of the person who designs the equipment or decides its specifications.

Since the product specified here is used under various operating conditions, its compatibility with specific equipment must be decided by the person who designs the equipment or decides its specifications based on necessary analysis and test results. The expected performance and safety assurance of the equipment will be the responsibility of the person who has determined its compatibility with the product. This person should also continuously review all specifications of the product referring to its latest catalog information, with a view to giving due consideration to any possibility of equipment failure when configuring the equipment.

#### 2. Only personnel with appropriate training should operate machinery and equipment.

The product specified here may become unsafe if handled incorrectly. The assembly, operation and maintenance of machines or equipment including our products must be performed by an operator who is appropriately trained and experienced.

#### 3. Do not service or attempt to remove product and machinery/equipment until safety is confirmed.

1. The inspection and maintenance of machinery/equipment should only be performed after measures to prevent falling or runaway of the driven objects have been confirmed.
2. When the product is to be removed, confirm that the safety measures as mentioned above are implemented and the power from any appropriate source is cut, and read and understand the specific product precautions of all relevant products carefully.
3. Before machinery/equipment is restarted, take measures to prevent unexpected operation and malfunction.

#### 4. Contact SMC beforehand and take special consideration of safety measures if the product is to be used in any of the following conditions.

1. Conditions and environments outside of the given specifications, or use outdoors or in a place exposed to direct sunlight.
2. Installation on equipment in conjunction with atomic energy, railways, air navigation, space, shipping, vehicles, military, medical treatment, combustion and recreation, or equipment in contact with food and beverages, emergency stop circuits, clutch and brake circuits in press applications, safety equipment or other applications unsuitable for the standard specifications described in the product catalog.
3. An application which could have negative effects on people, property, or animals requiring special safety analysis.
4. Use in an interlock circuit, which requires the provision of double interlock for possible failure by using a mechanical protective function, and periodical checks to confirm proper operation.

### Caution

#### 1. The product is provided for use in manufacturing industries.

The product herein described is basically provided for peaceful use in manufacturing industries.  
If considering using the product in other industries, consult SMC beforehand and exchange specifications or a contract if necessary.  
If anything is unclear, contact your nearest sales branch.

### Limited warranty and Disclaimer/ Compliance Requirements

The product used is subject to the following “Limited warranty and Disclaimer” and “Compliance Requirements”.

Read and accept them before using the product.

#### Limited warranty and Disclaimer

1. The warranty period of the product is 1 year in service or 1.5 years after the product is delivered, whichever is first.\*2)  
Also, the product may have specified durability, running distance or replacement parts. Please consult your nearest sales branch.
2. For any failure or damage reported within the warranty period which is clearly our responsibility, a replacement product or necessary parts will be provided.  
This limited warranty applies only to our product independently, and not to any other damage incurred due to the failure of the product.
3. Prior to using SMC products, please read and understand the warranty terms and disclaimers noted in the specified catalog for the particular products.

##### \*2) Vacuum pads are excluded from this 1 year warranty.

A vacuum pad is a consumable part, so it is warranted for a year after it is delivered.  
Also, even within the warranty period, the wear of a product due to the use of the vacuum pad or failure due to the deterioration of rubber material are not covered by the limited warranty.

#### Compliance Requirements

1. The use of SMC products with production equipment for the manufacture of weapons of mass destruction (WMD) or any other weapon is strictly prohibited.
2. The exports of SMC products or technology from one country to another are governed by the relevant security laws and regulations of the countries involved in the transaction. Prior to the shipment of a SMC product to another country, assure that all local rules governing that export are known and followed.

### Caution

#### SMC products are not intended for use as instruments for legal metrology.

Measurement instruments that SMC manufactures or sells have not been qualified by type approval tests relevant to the metrology (measurement) laws of each country. Therefore, SMC products cannot be used for business or certification ordained by the metrology (measurement) laws of each country.

 **Safety Instructions** Be sure to read the “Handling Precautions for SMC Products” (M-E03-3) and “Operation Manual” before use.

## SMC Corporation

Akihabara UDX 15F,  
4-14-1, Sotokanda, Chiyoda-ku, Tokyo 101-0021, JAPAN  
Phone: 03-5207-8249 Fax: 03-5298-5362  
<https://www.smcworld.com>  
© 2023 SMC Corporation All Rights Reserved

Specifications are subject to change without prior notice  
and any obligation on the part of the manufacturer.

D-G