

## SMC - Products for the Machine Tool Industry



**KQB2/KQG2 one-touch**

Rust-free or nickel plated design for temperatures 23 - 302°F



**TUZ hose**

Wear-resistant hose for use with drag chain cable covers



**Safety**

Safety valves according to the standard EN ISO 13849-1 (category 3 and 4)



**AL / LM lubricator systems**

Lubricator systems for various applications  
Jet lubricator systems, micro-mist lubricators, spray mist lubricators, drip lubricators



**HRS thermal chiller**

This regulates the temperature of the circulating fluids



**AEP / HEP suction module**

Coolant recovery using the Venturi suction principles

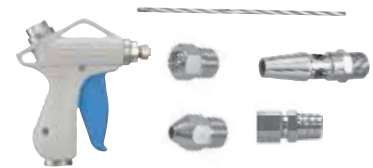

**VMG blow guns**

20% compressed air saving compared to conventional models

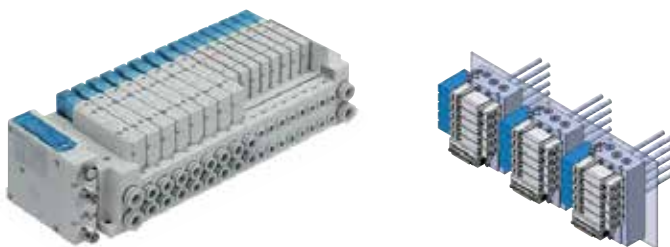

**New SY solenoid valves**

Cost savings can be achieved through the configuration flexibility which allows mixed valve sizes on a single manifold to match your flow requirements. compact design means reduced mounting footprint and lower material costs.



Circular plug IP67



Fixed connection cable IP67



D-Sub / ribbon IP40



Terminal block IP67

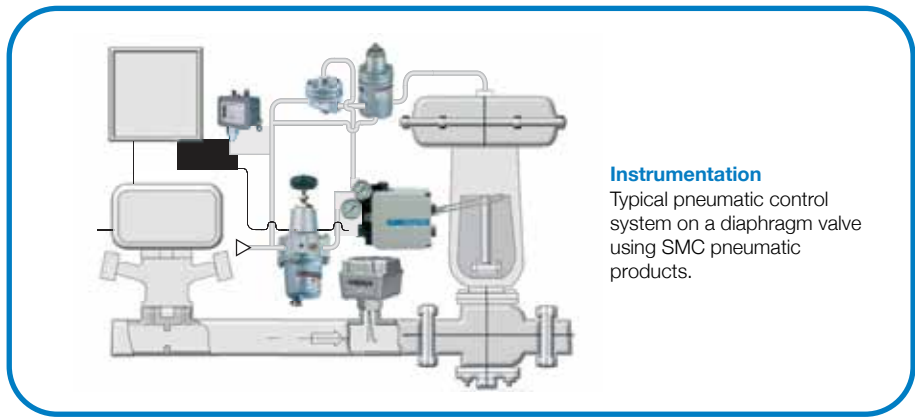
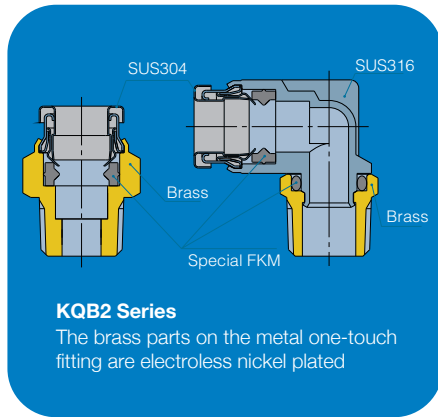

Machine tool manufacturers inevitably get involved with various automation technologies. Compressed air, coolants or other fluids they must be filtered, monitored, distributed and at times temperature controlled.

Valves, sensors, filters and temperature control devices with the relevant ancillary equipment e.g rust-free fittings or hoses compatible with drag chain cable covers can be used in for these typical applications.

Given the global presence of SMC, a world class supply chain is guaranteed for the entire product range. You can source SMC products anywhere at anytime regardless of where your business is conducted. When maintenance or repair work requires an SMC product you can be assured we will be there to support your business.

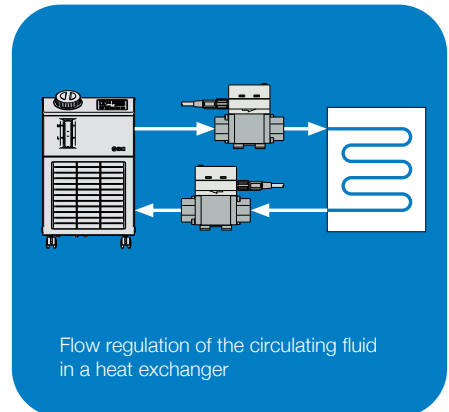
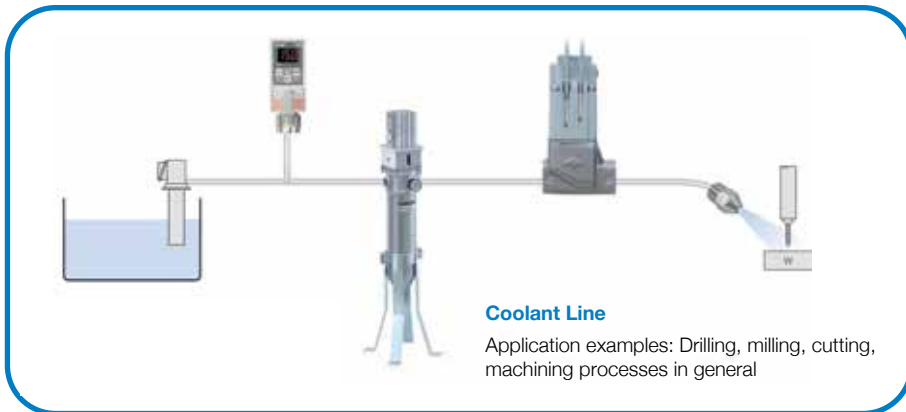
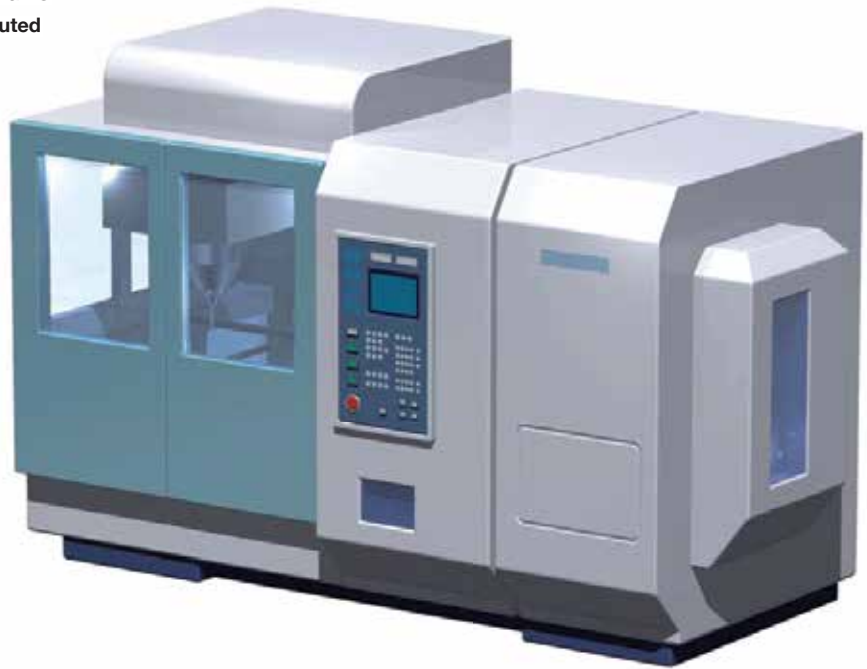



**Flow regulation line**

Media for standard applications: Water, oil, gas, vacuum, steam  
 Application examples: Sterilizer, car wash system, air-conditioning system, ice storage, moisteners, flushing machine, leak inspection device, field irrigation system, packing machine, laser units.



**ISE70 pressure switch**

Digital pressure switch for different media, up to 2175 psi, PNP/NPN with 2 outputs



**ZSE/ISE80 pressure switch**

Digital pressure switch for different media, -14.5 to 145 psi, PNP/NPN and analogue output



**ISE/ZSE30A pressure switch**

Digital pressure switch for compressed air and vacuum, 14.5 to 145 psi, PNP/NPN and analogue output



**PF3A/PF3W flow switch for air and water**

Flow and temperature measurement (Air or water models available) combined in the one device



**VX process valve**

Directly operated 2/2-port solenoid valve for air, vacuum, water and oil



**SGC coolant valve**

It controls the supply of coolant to the within the machine tool



**SGH High pressure coolant valve**

For grinding processes or deep-hole drilling applications with coolant pressures of 435 10 1015 psi

**FN1/FN4 filter**

Low maintenance filtering of coolants and flushing media. No filter element changes required



The impressive offer from SMC contains a variety of products for the flow regulation of different media for compressed air lines up to 2 inches.

Application examples are: Compressed air devices (drills, screwdrivers and wrenches), painting, powder coating, packing, grinding, brushing with wire brushes, polishing, sanding, shot blasting, general pneumatic control systems.



**AC air preparation unit**

Modular air preparation configured for your individual requirement

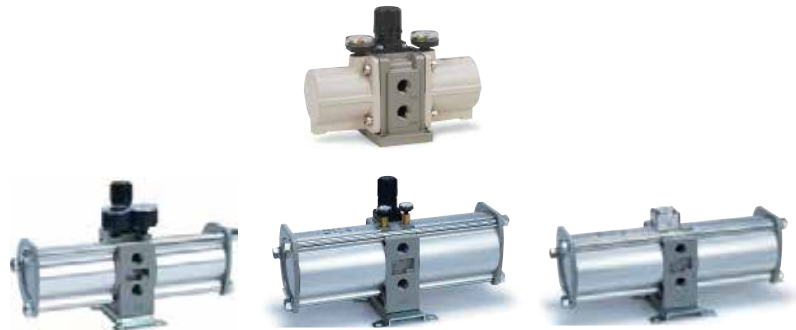

**VBA booster regulator**

It boosts the pressure of compressed air by four times, power-free operation



**IDFA refrigerated air dryer**

It reliably removes condensation from the compressed air



**IDH thermal air dryer**

It reliably removes condensation from the compressed air and controls the temperature it at the same time













**ARG, ACG, AWG**

Regulator and filter regulator with built-in pressure gauge in the handle

# Global Manufacturing, Distribution and Service Network

## Worldwide Subsidiaries

### North & South America

-  U.S.A. SMC Corporation of America
-  CANADA SMC Pneumatics (Canada) Ltd.
-  MEXICO SMC Corporation (México), S.A. de C.V.
-  BRAZIL SMC Pneumáticos do Brasil Ltda.
-  CHILE SMC Pneumatics (Chile) S.A.
-  COLOMBIA SMC Colombia Sucursal de SMC Chile S.A.
-  ARGENTINA SMC Argentina S.A.
-  BOLIVIA SMC Pneumatics Bolivia S.r.l.
-  VENEZUELA SMC Neumatica Venezuela S.A.
-  PERU (Distributor) IMPECO Automatización Industrial S.A.C.
-  ECUADOR (Distributor) ASSISTECH CIA. LTDA.













### Asia/Oceania

-  CHINA SMC (China) Co., Ltd.
-  CHINA SMC Pneumatics (Guangzhou) Ltd.
-  HONG KONG SMC Pneumatics (Hong Kong) Ltd.
-  TAIWAN SMC Pneumatics (Taiwan) Co., Ltd.
-  KOREA SMC Pneumatics Korea Co., Ltd.
-  SINGAPORE SMC Pneumatics (S.E.A.) Pte. Ltd.
-  MALAYSIA SMC Pneumatics (S.E.A.) Sdn. Bhd.
-  THAILAND SMC (Thailand) Ltd.
-  PHILIPPINES Shoketsu SMC Corporation
-  INDIA SMC Pneumatics (India) Pvt. Ltd.
-  ISRAEL (Distributor) Baccara Geva A.C.S. Ltd.
-  INDONESIA (Distributor) PT. Sinar Mutiara Cemerlang
-  VIETNAM (Distributor) Dy Dan Trading Co., Ltd.
-  PAKISTAN (Distributor) Jubilee Corporation

### Asia/Oceania

-  SRI LANKA (Distributor) Electro-Serv (Pvt.) Ltd.
-  IRAN (Distributor) Abzarchian Co. Ltd.
-  U.A.E. (Distributor) Machinery People Trading Co. L.L.C.
-  KUWAIT (Distributor) Esco Kuwait Equip & Petroleum App. Est.
-  SAUDI ARABIA (Distributor) Assaggaff Trading Est.
-  BAHRAIN (Distributor) Mohammed Jalal & Sons W.L.L. Technical & Automotive Services
-  SYRIA (Distributor) Miak Corporation
-  JORDAN (Distributor) Atafawok Trading Est.
-  BANGLADESH (Distributor) Chemie International
-  AUSTRALIA SMC Pneumatics (Australia) Pty. Ltd.
-  NEW ZEALAND SMC Pneumatics (N.Z.) Ltd.
-  JAPAN SMC Corporation

### Europe/Africa

-  GERMANY SMC Pneumatik GmbH
-  SWITZERLAND SMC Pneumatik AG
-  U.K. SMC Pneumatics (U.K.) Ltd.
-  FRANCE SMC Pneumatique SA
-  SPAIN / PORTUGAL SMC España S.A.
-  ITALY SMC Italia S.p.A.
-  GREECE SMC HELLAS E.P.E
-  IRELAND SMC Pneumatics (Ireland) Ltd.
-  NETHERLANDS (Associated company) SMC Pneumatics BV
-  BELGIUM (Associated company) SMC Pneumatics N.V./S.A.
-  DENMARK SMC Pneumatik A/S
-  AUSTRIA SMC Pneumatik GmbH (Austria)

### Europe/Africa

-  CZECH REPUBLIC SMC Industrial Automation CZ s.r.o.
-  HUNGARY SMC Hungary Ipari Automatizálási Kft.
-  POLAND SMC Industrial Automation Polska Sp. z o.o.
-  SLOVAKIA SMC Priemyselná Automatizácia Spol s.r.o.
-  SLOVENIA SMC Industrijska Avtomatika d.o.o.
-  BULGARIA SMC Industrial Automation Bulgaria EOOD
-  CROATIA SMC Industrijska Avtomatika d.o.o.
-  BOSNIA AND HERZEGOVINA (Distributor) A.M. Pneumatik d.o.o.
-  SERBIA (Distributor) Best Pneumatics d.o.o.
-  UKRAINE (Distributor) PNEUMOTEC Corp.
-  FINLAND SMC Pneumatics Finland Oy
-  NORWAY SMC Pneumatics Norway AS
-  SWEDEN SMC Pneumatics Sweden AB
-  ESTONIA SMC Pneumatics Estonia Oü
-  LATVIA SMC Pneumatics Latvia SIA
-  LITHUANIA (LIETUVA) UAB "SMC Pneumatics"
-  ROMANIA SMC Romania S.r.l.
-  RUSSIA SMC Pneumatik LLC.
-  KAZAKHSTAN SMC Kazakhstan, LLC.
-  TURKEY (Distributor) Entek Pnömatik Sanayi ve Ticaret Şirketi
-  MOROCCO (Distributor) Soraflex
-  TUNISIA (Distributor) Bymys
-  EGYPT (Distributor) Saadani Trading & Industrial Services
-  NIGERIA (Distributor) Faraday Engineering Company Ltd.
-  SOUTH AFRICA (Distributor) Hyflo Southern Africa (Pty.) Ltd.

## U.S. & Canadian Sales Offices

### WEST

- Austin
- Dallas
- Los Angeles
- Phoenix
- Portland
- San Francisco
- Vancouver



### EAST

- Atlanta
- Birmingham
- Boston
- Charlotte
- Nashville
- New Jersey
- Rochester
- Tampa
- Montreal

### CENTRAL

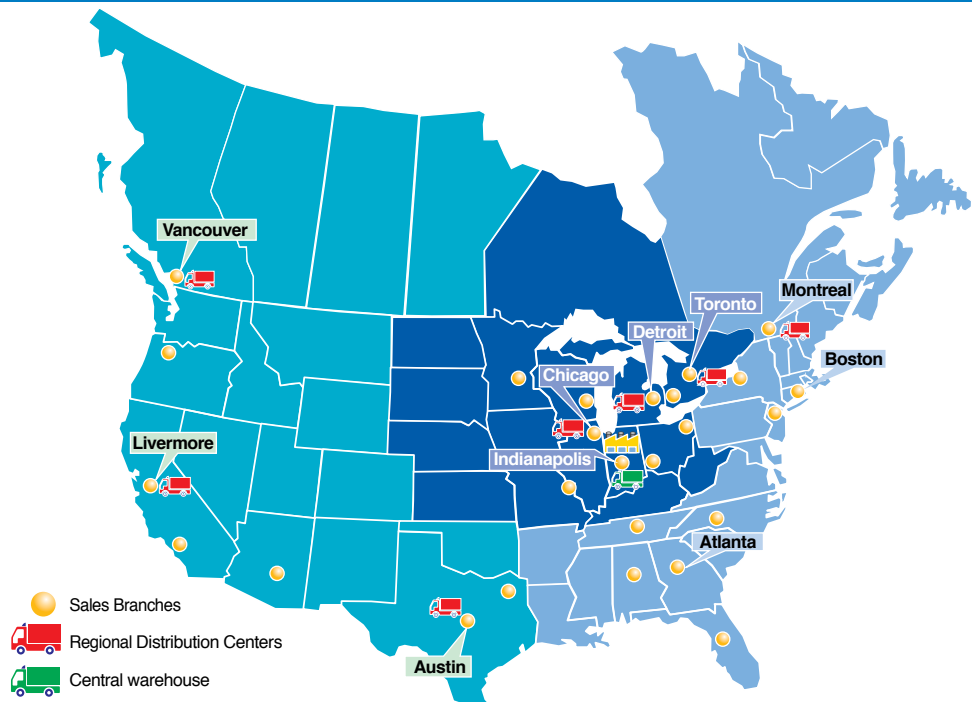
- Chicago
- Cincinnati
- Cleveland
- Detroit
- Indianapolis
- Milwaukee
- Minneapolis
- St. Louis
- Toronto
- Windsor



-  Sales Branches
-  Regional Distribution Centers
-  Central warehouse

**SMC Corporation of America**  
10100 SMC Blvd., Noblesville, IN 46060  
[www.smcusa.com](http://www.smcusa.com)

**SMC Pneumatics (Canada) Ltd.**  
[www.smcpcanada.com](http://www.smcpcanada.com)

**(800) SMC.SMC1 (762-7621)**  
e-mail: [sales@smcusa.com](mailto:sales@smcusa.com)

For International inquiries: [www.smcworld.com](http://www.smcworld.com)

