

Air Cylinder: Standard/Non-rotating Rod Double Acting/Single Acting, Single Rod/Double Rod

Series *NCM*

ø3/4", ø7/8", ø1 1/16", ø1 1/4", ø1 1/2", ø2"



Double Rod/Double End Mounting
Non-rotating Rod Option
Auto Switch Capable

CJ1

CJP

CJ2

CM2

CG1

MB

MB1

CA2

CS1

C76

C85

C95

CP95

NCM

NCA

D-

-X

20-

Data

Air Cylinder: Standard/Non-rotating Rod Double Acting/Single Acting, Single Rod/Double Rod Series *NCM*

Inch size: $\varnothing 3/4"$, $\varnothing 7/8"$, $\varnothing 1 1/16"$, $\varnothing 1 1/4"$, $\varnothing 1 1/2"$, $\varnothing 2"$

How to Order

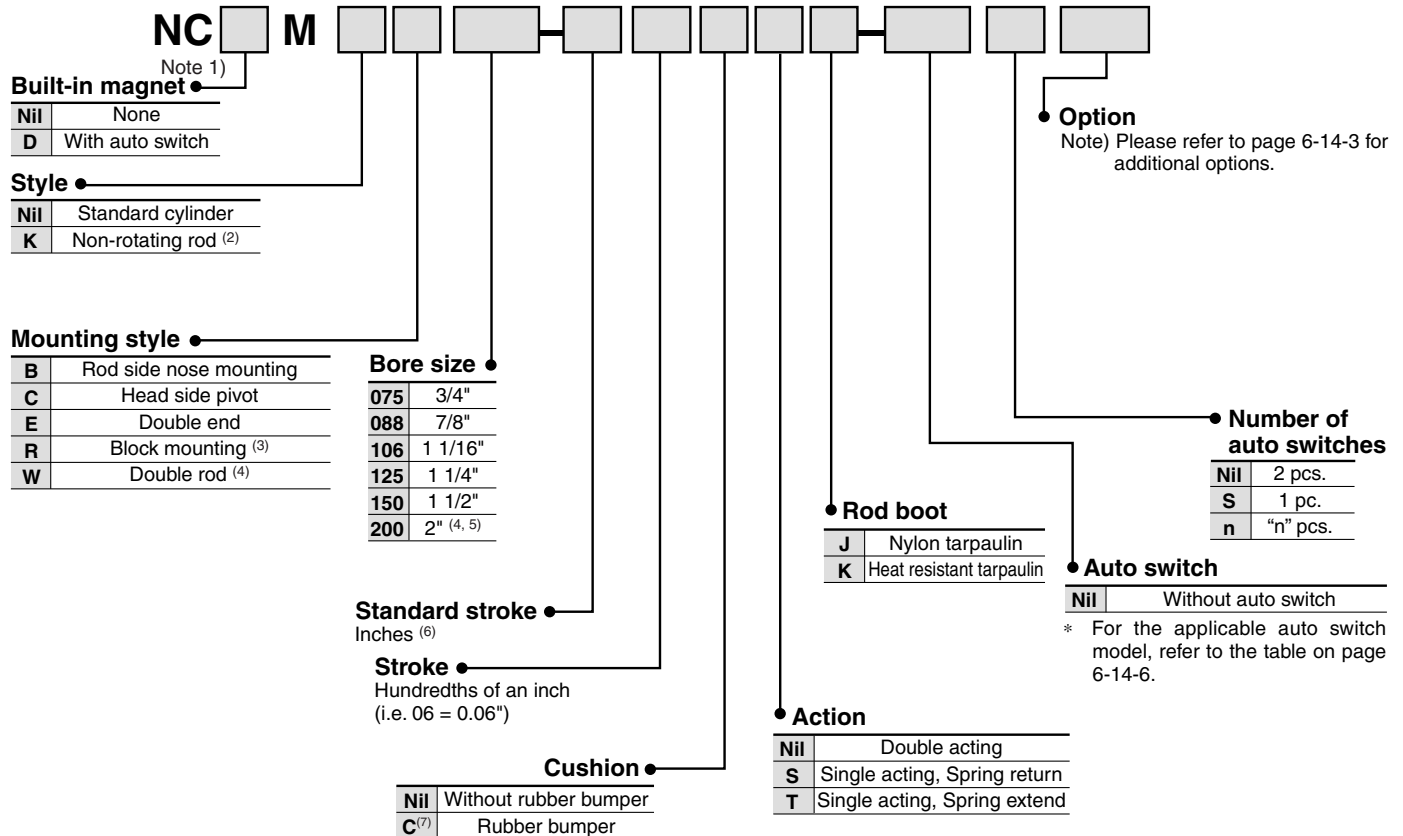

Note 1) Not available with block mount (R).

Note 2) Not available with spring extend (T), double rod (W), block mount (R), rod boot, or $\varnothing 2"$.

Note 3) Not offered in $\varnothing 7/8"$, $\varnothing 1 1/4"$, or $\varnothing 2"$ or with rod boot.

Note 4) Double acting only.

Note 5) Not available as standard with C, R mount, with rod boot.

Note 6) See specifications for standard and maximum stroke lengths.

Note 7) Rubber cushions are offered at no additional cost on $\varnothing 7/8"$ and $\varnothing 1 1/4"$. They are options on the other bore sizes. The "C" after the bore size must be included in either case. Cushion affects cylinder overall length of some models. Refer to dimensional data.

Auto Switch Specifications/Option Compatibility

Applicable Auto Switch/Refer to page 6-16-1 for further information on auto switches.

Type	Special function	Electrical entry	Indicator light	Wiring (Output)	Load voltage		Auto switch model	Lead wire length (m)*				Pre-wire connector	Applicable load		
					DC	AC		0.5 (Nil)	3 (L)	5 (Z)	None (N)				
Reed switch	—	Grommet	Yes	2-wire	24 V	12 V	100 V	C73	●	●	●	—	—	—	Relay, PLC
			No			5 V, 12 V	100 V or less	C80	●	●	—	—	IC circuit		
			Yes			—	—	B53	●	●	●	—			
			No			12 V	100 V, 200 V 200 V or less	B54 B64	●	●	●	—	—		
		Connector	Yes			—	—	C73C	●	●	●	●		—	—
			No			5 V, 12 V	24 V or less	C80C	●	●	●	●	—	IC circuit	
	Diagnostic indication (2-color indication)	Grommet	Yes			—	—	B59W	●	●	—	—	—	—	
Solid state switch	—	Grommet	Yes	3-wire (NPN)	24 V	—	5 V, 12 V	H7A1	●	●	○	—	○	IC circuit	Relay, PLC
				3-wire (PNP)			5 V, 12 V	H7A2	●	●	○	—	○		
	2-wire	12 V	H7B	●			●	○	—	○	—				
		5 V, 12 V	H7C	●			●	●	●	—					
	Diagnostic indication (2-color indication)	Grommet	Yes	3-wire (NPN)			5 V, 12 V	H7NW	●	●	○	—	○	IC circuit	
				3-wire (PNP)			5 V, 12 V	H7PW	●	●	○	—	○		
	Water resistant (2-color indication)	Grommet	Yes	2-wire			12 V	H7BW	●	●	○	—	○	—	
				4-wire (NPN)			5 V, 12 V	H7BA	—	●	○	—	○		
	With diagnostic output (2-color indication)	Grommet	Yes	3-wire (NPN)			5 V, 12 V	H7NF	●	●	○	—	○	IC circuit	
				2-wire			12 V	G59	●	●	○	—	○		
—	Grommet	Yes	2-wire	12 V	K59	●	●	○	—	○	—	—			

* Lead wire length symbols: 0.5 m Nil (Example) C73C
 3 m L (Example) C73CL
 5 m Z (Example) C73CZ
 None N (Example) C73CN

* Solid state switches marked with "○" are produced upon receipt of order.

• For details about auto switches with pre-wire connector, refer to page 6-16-60.

Option Compatibility

	Description	Note	NCM - Standard	NCDM	NCMW	NCMK	NCM-*J	NCM-*K	S	T	C	XB6	XB7	XB9	XC6
NCM	Standard		—												
NCDM	Auto switch capable		○	—											
NCMW	Double rod		○	○	—										
NCMK	Non-rotating	1	○	○	S	—									
NCM-*J	Nylon rod boot	1	○	○	S	S	—								
NCM-*K	Neoprone rod boot	1	○	○	S	S	N	—							
S	Spring return	1	○	○	S	S	S	S	—						
T	Spring extend	1	○	○	S	S	S	S	N	—					
C	Rubber bumper	2	○	○	○	S	S	O	N	O	—				
XB6	Heat resistant	1	○	S	O	N	S	S	O	N	N	—			
XB7	Cold resistant	1	○	S	O	N	S	S	O	N	N	N	—		
XB9	Low speed	1	○	○	S	N	S	S	N	N	O	N	N	—	
XC6	Stainless steel rod	3, 4	○	○	○	○	○	○	N	O	O	O	O	O	—
B	Rod side nose mounting		○	○	○	○	○	○	○	○	○	○	○	○	○
C	Head side pivot mounting	1	○	○	N	○	○	○	○	○	○	○	○	○	○
E	Double end mounting		○	○	N	○	○	○	○	○	○	○	○	○	○
R	Block mounting	1, 5, 6	○	○	S	S	N	N	O	O	O	S	S	O	O

○ Combination available to order
 S Available with special request
 N Not available

Note 1) This table is not applicable for ø200.

Note 2) Rubber cushion no additional charge on ø088 and ø125.

Note 3) Stainless steel rod standard on ø075 and ø088. Use XC6 option to get stainless steel rod nut.

Note 4) Non-rotating rod is stainless steel. Use XC6 option to get stainless steel rod nut.

Note 5) Block mount not available in ø088 and ø125.

Note 6) Block, Auto switch capable, S and T only available as special.

CJ1

CJP

CJ2

CM2

CG1

MB

MB1

CA2

CS1

C76

C85

C95

CP95

NCM

NCA

D-

-X

20-

Data

Specifications: Single Acting, Spring Return, Spring Extend

Specifications

Bore size (in)	075 (3/4")	088 (7/8")	106 (1 1/16")	125 (1 1/4")	150 (1 1/2")	200 (2")
Fluid	Air					
Maximum operating pressure	250 PSI/1.7 MPa					
Minimum operating pressure	25 PSI/0.18 MPa					
Ambient and fluid temperature	40 to 140°F/5 to 60 °F					
Piston speed	2 to 20 in/sec/50 to 500 mm/s					
Rubber bumper	Option (No additional charge on 7/8" and 1 1/4" bore)					
Lubrication	Not required (Pre-lubricated at Factory)					
Mounting	B, C, E, R					

Note) R mount available on 3/4", 1 1/16", and 1 1/2" bore only.

Standard Stroke

(in)

Mounting	Standard stroke	Maximum Stroke
Rod side nose (B)	1/2, 1, 1 1/2, 2, 3, 4	6
Double end (E)		
Head side pivot (C)		
Block mount (R)		

Note) Up to 18" available as special request.

Specifications: Single Acting Spring Return, Non Rotating Rod

Specifications

Bore size (in)	075 (3/4")	088 (7/8")	106 (1 1/16")	125 (1 1/4")	150 (1 1/2")
Fluid	Air				
Maximum operating pressure	250 PSI/1.7 MPa				
Minimum operating pressure	25 PSI/0.18 MPa				
Ambient and fluid temperature	40 to 140°F/5 to 60 °F				
Piston speed	2 to 20 in/sec/50 to 500 mm/s				
Rod material	Stainless steel 304				
Rubber bumper	Option (No additional charge on 7/8" and 1 1/4" bore)				
Non-rotating accuracy	± 2.0°		± 1.4°		
Maximum allowable torque	0.04 ft·Lbf (0.06 N·m)	0.09 ft·Lbf (0.13 N·m)	0.12 ft·Lbf (0.16 N·m)		

Standard Stroke Availability

(in)

Mounting	Standard stroke	Max. stroke
Rod side nose (B)	1/2, 1, 2, 3, 4, 5, 6	6
Double end mounting (E)	1/2, 1, 2, 3, 4, 5, 6	8
Head side pivot (C)	1/2, 1, 2, 3, 4, 5, 6	

Note 1) Minimum stroke for mounting auto switches: 0.6 inch for 2 switches, 0.4 inch for one switch.

Note 2) Spring Return up to 18" available as special request.

CJ1

CJP

CJ2

CM2

CG1

MB

MB1

CA2

CS1

C76

C85

C95

CP95

NCM

NCA

D-

-X

20-

Data

Series NCM

Specifications: Rod Boot

Rod Boot Material

Symbol	Material	Maximum ambient temperature
J	Nylon tarpaulin	140°F (60°C)
K	Heat resistant tarpaulin	230°F (110°C)*

* Maximum ambient temperature is for the rod boot only.

Maximum Stroke

Bore size (in)	Maximum stroke
3/4, 7/8, 1 1/16	12 STD.—16 Max.
1 1/4, 1 1/2, 2	12 STD.—26 Max.

Parts No. of Auto Switch Mounting Band

Auto switch part number	Bore size				
	075	088	106	125	150
D-G59, D-B54, D-B64, D-K59, D-B53	NBA-075	NBA-088	NBA-106	NBA-125	NBA-150
D-C73 D-H7A1	NBM2-075	NBM2-088	NBM2-106	NBM2-125	NBM2-150

Minimum Stroke for Auto Switches Mounting (NCDM)

(in)

Auto switch model	Number of switches				1
	2		n		
	On different surfaces	On the same surfaces	On different surfaces	On the same surfaces	
D-C7 D-C8	0.6	2.3	$0.6 + 1.8\left(\frac{n-2}{2}\right)$ (n = 2, 4, 6...)	$2.3 + 1.8(n-2)$	0.4
D-H7□ D-H7□W D-H7BAL D-H7NF	0.6	2.3			0.4
D-C73C C-C80C D-H7C	0.6	3.1	$0.6 + 2\left(\frac{n-2}{2}\right)$ (n = 2, 4, 6...)	$3.1 + 2(n-2)$	0.4
D-H7LF	0.8	2.8	$0.8 + 2\left(\frac{n-2}{2}\right)$ (n = 2, 4, 6...)	$2.8 + 2(n-2)$	0.4
D-B5 D-B6	0.6	2.7	$0.6 + 2\left(\frac{n-2}{2}\right)$ (n = 2, 4, 6...)	$2.7 + 2.2(n-2)$	0.4
D-B59W	0.8	2.9	$0.8 + 2\left(\frac{n-2}{2}\right)$ (n = 2, 4, 6...)	$2.9 + 2.2(n-2)$	0.6
D-G59 D-K59	0.6	2.8	$0.6 + 2\left(\frac{n-2}{2}\right)$ (n = 2, 4, 6...)	$2.8 + 2(n-2)$	0.4

Series NCM

Construction: Single Acting, Spring Extend

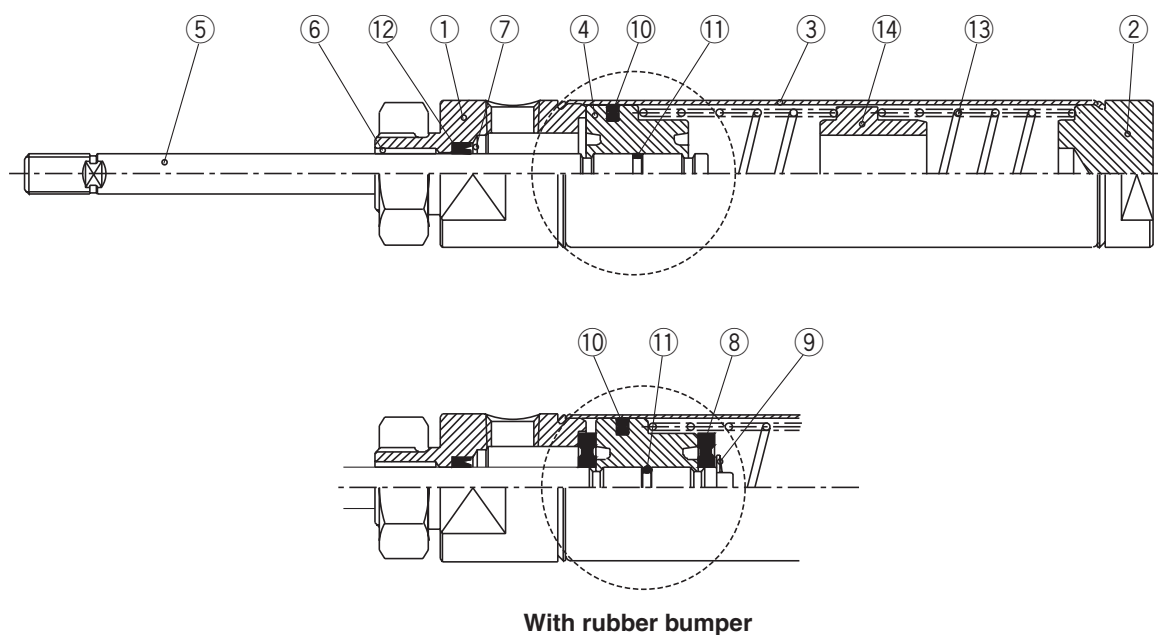

Component Parts

No.	Description	Material	Note
①	Rod cover	Aluminum alloy	Clear anodized
②	Head cover	Aluminum alloy	Clear anodized
③	Cylinder tube	Stainless steel	Stainless steel 304
④	Piston	Aluminum alloy	Chromated
⑤	Piston rod	3/4", 7/8"	Stainless steel
		1 1/16", 1 1/2", 1 1/4", 2"	Carbon steel
⑥	Bushing	Sintered BR	—
⑦	Snap ring	Spring steel	—
⑧	Rubber bumper	Urethane	—
⑨	Snap ring	Spring steel	—
⑩	Piston seal	NBR	—
⑪	Piston gasket	NBR	—
⑫	Rod seal	NBR	—
⑬	Spring	Piano wire	Chromated
⑭	Spring guide	Aluminum alloy	Chromated

Construction: Single Acting, Spring Return

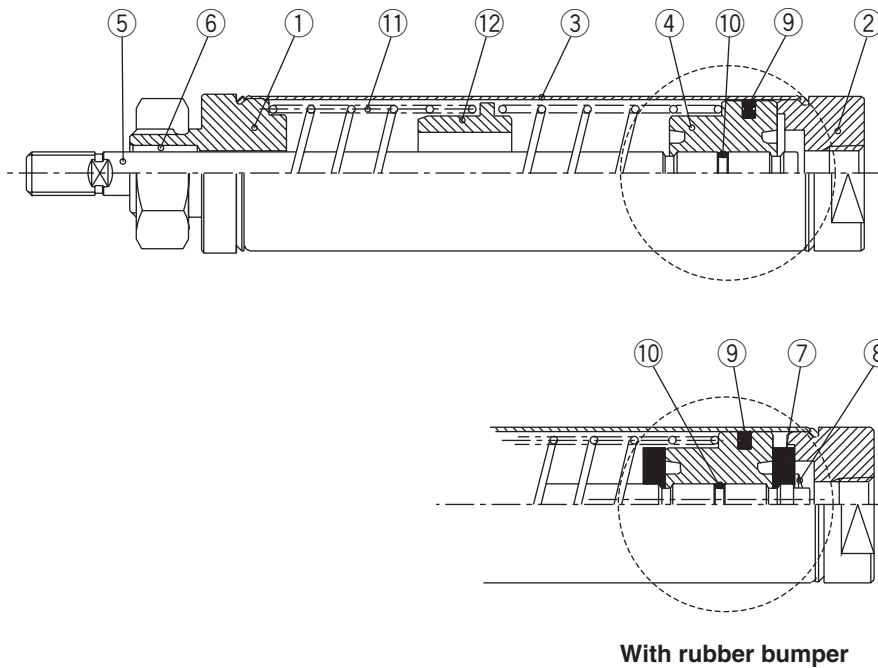

Component Parts

No.	Description	Material	Note
①	Rod cover	Aluminum alloy	Clear anodized
②	Head cover	Aluminum alloy	Clear anodized
③	Cylinder tube	Stainless steel	Stainless steel 304
④	Piston	Aluminum alloy	Chromated
⑤	Piston rod	3/4", 7/8"	Stainless steel
		1 1/16", 1 1/2", 1 1/4", 2"	Carbon steel
⑥	Bushing	Sintered BR	—
⑦	Rubber bumper	Urethane	—
⑧	Snap ring	Spring steel	—
⑨	Piston seal	NBR	—
⑩	Piston gasket	NBR	—
⑪	Spring	Piano wire	Chromated
⑫	Spring guide	Aluminum alloy	Chromated

CJ1

CJP

CJ2

CM2

CG1

MB

MB1

CA2

CS1

C76

C85

C95

CP95

NCM

NCA

D-

-X

20-

Data

Series NCM

Dimensions: Single Acting, Single Return

Rod side nose mounting Spring return: NCMB□-□S

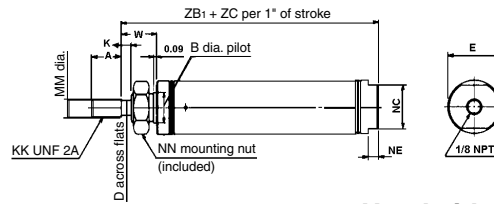

Double end mounting Spring return: NCME□-□S

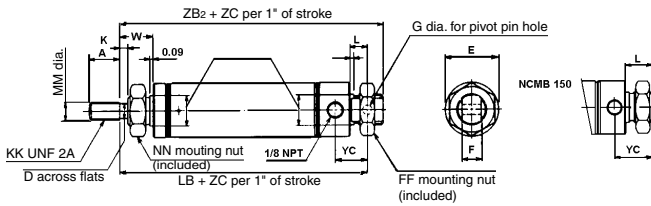

Head side pivot mounting Spring return: NCMC□-□S

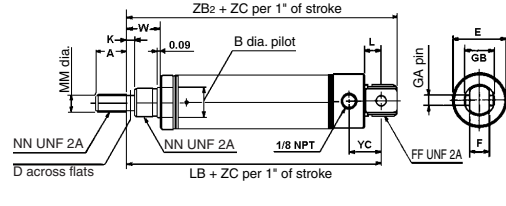

Bore size (in)	MM	KK	A	B	D	E	F	FF	G	GA	GB	K	NC	NE	NN	W	YC	ZC
075 (3/4")	0.250	1/4-28	0.50	0.496	—	0.86	0.38	5/8-18	0.251	0.250	0.75	—	0.62	0.12	1/2-20	0.44	0.62	1.69
088 (7/8")	0.250	1/4-28	0.50	0.624	—	0.93	0.38	5/8-18	0.251	0.250	0.75	—	0.75	0.18	5/8-18	0.50	0.62	1.56
106 (1 1/16")	0.312	5/16-24	0.50	0.624	0.25	1.12	0.38	5/8-18	0.251	0.250	0.75	0.12	0.88	0.24	5/8-18	0.62	0.62	1.56
125 (1 1/4")	0.437	7/16-20	0.75	0.749	0.38	1.32	0.50	3/4-16	0.251	0.250	0.75	0.25	1.06	0.25	3/4-16	0.88	0.78	1.81
150 (1 1/2")	0.437	7/16-20	0.75	0.749	0.38	1.56	0.62	3/4-16	0.376	0.375	1.00	0.25	1.25	0.25	3/4-16	0.88	0.78	1.69

(in)

Single Acting, Spring Return B, C, E Mounting without Magnet

(in)

Bore (in)	LB		ZB1		ZB2	
	No bumper	With bumper	No bumper	With bumper	No bumper	With bumper
075 (3/4")	2.28	2.28	1.50	1.50	2.56	2.56
088 (7/8")	2.22	2.47	1.59	1.84	2.50	2.75
106 (1 1/16")	2.66	2.79	2.06	2.19	2.94	3.07
125 (1 1/4")	3.13	3.38	2.41	2.66	3.53	3.78
150 (1 1/2")	3.12	3.25	2.44	2.57	3.50	3.63

Single Acting, Spring Return B, C Mounting with Magnet

(in)

Bore (in)	LB		ZB1		ZB2	
	No bumper	With bumper	No bumper	With bumper	No bumper	With bumper
075 (3/4")	2.41	1.53	1.63	1.75	2.69	2.81
088 (7/8")	2.47	2.59	1.84	1.97	2.75	2.88
106 (1 1/16")	2.79	2.91	2.19	2.32	3.06	3.19
125 (1 1/4")	3.38	3.50	2.66	2.78	3.79	3.91
150 (1 1/2")	3.25	3.38	2.56	2.68	3.63	3.75

Single Acting, Spring Return E Mounting with Magnet

(in)

Bore (in)	LB		ZB2	
	No bumper	With bumper	No bumper	With bumper
075 (3/4")	2.41	2.53	2.69	2.81
088 (7/8")	2.47	2.59	2.75	2.88
106 (1 1/16")	2.79	2.91	3.06	3.19
125 (1 1/4")	3.38	3.50	3.79	3.91
150 (1 1/2")	—	—	3.38	3.50

Single Acting, Spring Return Non-rotating B, C, E Mounting without Magnet

(in)

Bore (in)	LB		ZB1		ZB2		KK	MM
	No bumper	With bumper	No bumper	With bumper	No bumper	With bumper		
075 (3/4")	2.53	2.53	1.75	1.75	2.81	2.81	1/4-28	0.250
088 (7/8")	2.47	2.72	1.84	2.09	2.75	3.00	1/4-28	0.250
106 (1 1/16")	2.78	2.91	2.18	2.31	3.06	3.19	5/16-24	0.312
125 (1 1/4")	3.13	3.38	2.41	2.66	3.53	3.78	3/8-24	0.375
150 (1 1/2")	3.25	3.37	2.57	2.69	3.63	3.75	3/8-24	0.375

Dimensions: Single Acting, Spring Extend

Rod side nose mounting Spring extend: NCMB□-□T

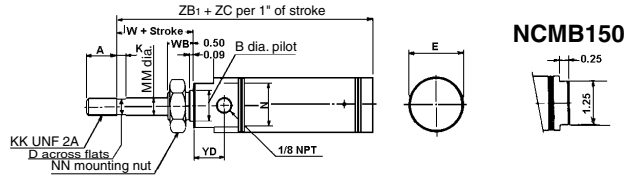

Double end mounting Spring extend: NCME□-□T

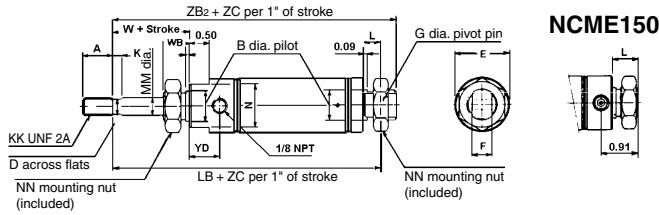

Head side pivot mounting Spring extend: NCMC□-□T

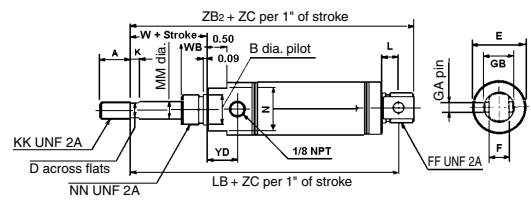

Bore size (in)	MM	KK	A	B	D	E	F	FF	G	GA	GB	K	LB	N	NN	W	WB	YD	ZC
075 (3/4")	0.250	1/4-28	0.50	0.624	—	0.86	0.38	5/8-18	0.251	0.250	0.75	—	2.44	0.75	5/8-18	0.50	0.50	0.45	2.69
088 (7/8")	0.250	1/4-28	0.50	0.624	—	0.93	0.38	5/8-18	0.251	0.250	0.75	—	2.62	0.75	5/8-18	0.50	0.50	0.45	2.56
106 (1 1/16")	0.312	5/16-24	0.50	0.624	0.25	1.12	0.38	5/8-18	0.251	0.250	0.75	0.12	2.78	0.88	5/8-18	0.62	0.50	0.55	2.81
125 (1 1/4")	0.437	7/16-20	0.75	0.749	0.38	1.32	0.50	3/4-16	0.251	0.250	0.75	0.25	3.76	1.06	3/4-16	0.88	0.62	0.75	2.81
150 (1 1/2")	0.437	7/16-20	0.75	0.749	0.38	1.56	0.62	—	—	0.375	1.00	0.25	3.88	1.25	3/4-16	0.88	0.62	0.63	3.00

Single Acting, Spring Extend B, C, E Mounting without Magnet

Bore (in)	LB		ZB1		ZB2	
	No bumper	With bumper	No bumper	With bumper	No bumper	With bumper
075 (3/4")	2.44	2.44	2.10	2.10	2.72	2.72
088 (7/8")	2.37	2.62	2.02	2.27	2.66	2.91
106 (1 1/16")	2.78	2.91	2.42	2.55	3.06	3.19
125 (1 1/4")	3.51	3.76	3.09	3.34	3.91	4.16
150 (1 1/2")	3.88	4.01	3.16	3.29	4.26	4.39

Single Acting, Spring Extend B, C, E Mounting with Magnet

Bore (in)	LB		ZB1		ZB2	
	No bumper	With bumper	No bumper	With bumper	No bumper	With bumper
075 (3/4")	2.56	2.69	2.23	2.36	2.85	2.97
088 (7/8")	2.62	2.75	2.27	2.40	2.91	3.03
106 (1 1/16")	2.91	3.03	2.55	2.68	3.19	3.31
125 (1 1/4")	3.76	3.88	3.34	3.47	4.19	4.29
150 (1 1/2")	4.00	4.12	3.29	3.41	4.38	4.50

Single Acting, Spring Extend E Mounting with Magnet

Bore (in)	LB		ZB2	
	No bumper	With bumper	No bumper	With bumper
075 (3/4")	2.56	2.69	2.85	2.97
088 (7/8")	2.62	2.75	2.91	3.03
106 (1 1/16")	2.91	3.03	3.19	3.31
125 (1 1/4")	3.76	3.88	4.16	4.21
150 (1 1/2")	—	—	4.12	4.25

CJ1

CJP

CJ2

CM2

CG1

MB

MB1

CA2

CS1

C76

C85

C95

CP95

NCM

NCA

D-

-X

20-

Data

Series NCM

Mounting Bracket Accessory

Foot bracket

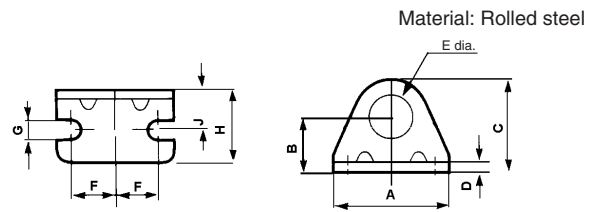

(in)

Part no.	Applicable bore	A	B	C	D	E	F	G	H	J
NCM-L075*	3/4", 7/8", 1 1/16"	1.89	0.81	1.36	0.12	0.63	0.75	0.27	0.98	0.56
NCM-L150	1 1/4", 1 1/2"	2.52	1.00	1.75	0.12	0.75	0.94	0.27	1.50	0.75
NCMK-L150	1 1/4", 1 1/2"	2.52	1.00	1.75	0.12	0.88	0.94	0.27	1.50	0.75
NCM-L200	2"	3.126	1.5	2.5	0.25	1.38	1.13	0.34	1.63	1.00

Note) NCM-L075 will not fit NCM*075*S (Single Acting). For this option use: NCM075-19-51046.
(F dimension=0.51")

Rod clevis

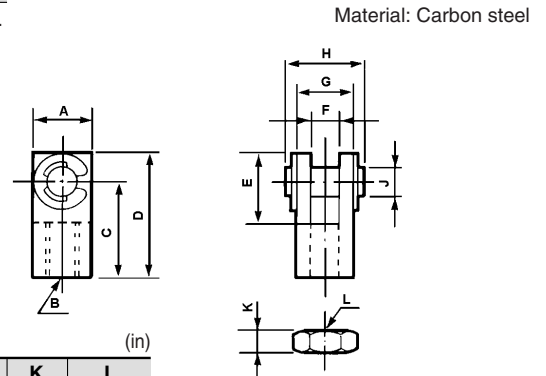

(in)

Part no.	Applicable bore	A	B	C	D	E	F	G	H	J	K	L
NY-075	3/4", 7/8"	0.51	1/4-28	0.94	1.18	0.69	0.25	0.51	0.71	0.25	0.16	1/4-28
NY-106	1 1/16"	0.51	5/16-24	0.94	1.18	0.69	0.25	0.51	0.71	0.25	0.19	5/16-24
NY-125	1 1/4", 1 1/2"	0.75	7/16-20	1.31	1.69	0.94	0.38	0.75	1.02	0.38	0.25	7/16-20
NY-G050	2"	0.75	1/2-20	1.32	1.69	0.94	0.38	0.75	1.02	0.38	0.31	1/2-20

Jam nut (Rod thread)

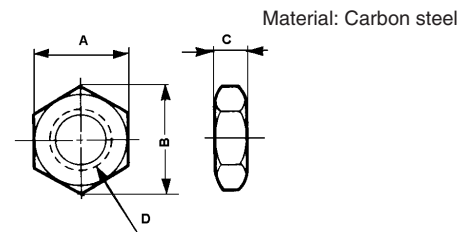

(in)

Part no.	Applicable bore	A	B	C	D
JM-025	3/4", 7/8"	0.44	0.51	0.16	1/4-28 UNF
JM-03	1 1/16"	0.50	0.50	0.19	5/16-24 UNF
JM-045	1 1/4", 1 1/2"	0.69	0.79	0.26	7/16-20 UNF
JM-04	1 1/4", 1 1/2" (Non-rotating)	0.56	0.65	0.23	3/8-24 UNF
JM-05	2"	0.75	0.87	0.32	1/2-20 UNF

Mounting Bracket Accessory

Material: Rolled steel

Pivot bracket (Head side pivot): NCMC

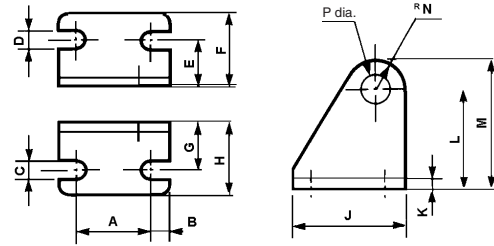

Part no.	Applicable bore	A	B	C	D	E	F	G	H	J	K	L	M	N	øP
NCM-PC075	3/4", 7/8", 1 1/16", 1 1/4"	0.75	0.18	0.27	0.27	0.44	0.79	0.44	0.79	1.101	0.12	0.88	1.18	0.31	0.255
NCM-PC150	1 1/2"	1	0.25	0.27	0.27	0.62	0.98	0.62	0.98	0.50	0.12	1.38	1.75	0.38	0.38

Pivot bracket (End mount): NCME

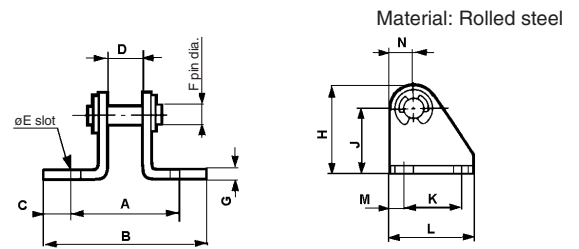

Part no.	Applicable bore	A	B	C	D	øE	F	G	H	J	K	L	M	N
NCM-PE075	3/4", 7/8", 1 1/16"	1.25	1.95	0.35	0.38	0.27	0.25	0.12	1.18	0.88	0.75	1.10	0.18	0.31
NCM-PE125	1 1/4", 1 1/2"	1.38	2.08	0.35	0.50	0.27	0.25	0.12	1.18	0.88	0.75	1.10	0.18	0.31
NCG-PC050	2"	2.12	3.00	0.44	0.75	0.27	0.38	0.24	1.75	1.38	1.00	1.50	0.25	0.37

Mounting nut (Nose mount thread)

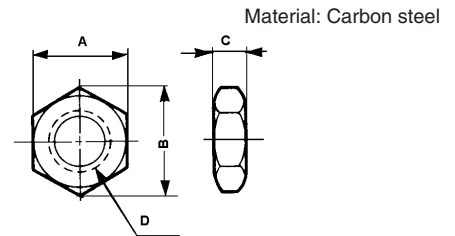

Part no.	Applicable bore	A	B	C	D
JM-08	3/4", 7/8", 1 1/16"	0.94	1.08	0.38	5/8-18 UNF
JM-10	1 1/4", 1 1/2"	1.12	1.30	0.42	3/4-16 UNF
JM-14	2"	1.61	1.86	0.43	1 1/4 -12 UNF

CJ1

CJP

CJ2

CM2

CG1

MB

MB1

CA2

CS1

C76

C85

C95

CP95

NCM

NCA

D-

-X

20-

Data

Series NCM

Double Acting/Single Rod/Band Mounting Auto Switch Mounting Position and Mounting Height

D-C7/C8

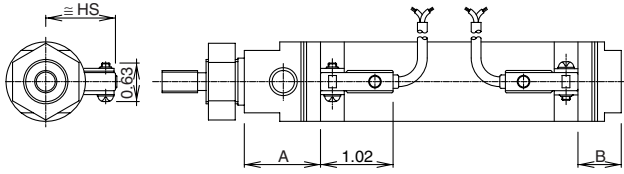

D-H7□/H7□W/H7□F/H7BAL□

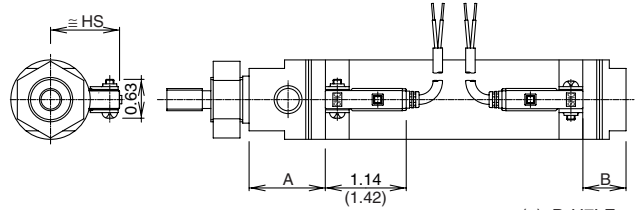

D-B5/B6/B59W

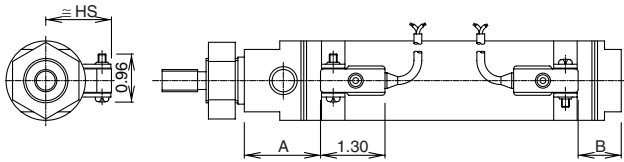

D-G59/K59

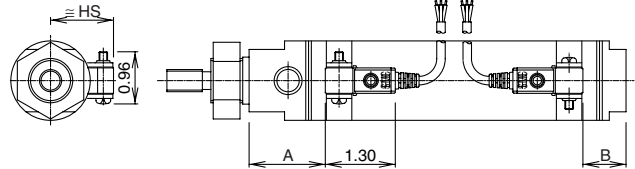

* () : D-H7LF

D-C73C/C80C

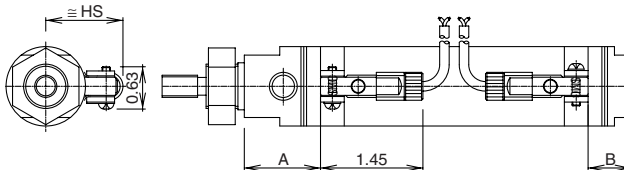

D-H7C

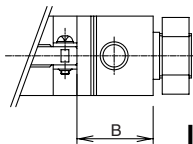
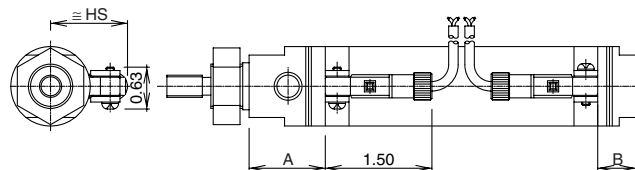

In case of NCDMC, NCDME

Auto Switch Mounting Position (NCDMB) (in)

Auto switch model	D-B5 D-B6		D-C7□ D-C80 D-C73C D-C80C		D-B59W		D-H7□ D-H7C D-H7□W D-H7BAL D-H7NF		D-H7LF		D-G59 D-K59	
	A	B	A	B	A	B	A	B	A	B	A	B
075 (3/4")	0.88	0.37	1.12	0.60	1.00	0.48	1.08	0.56	1.02	0.50	0.94	0.42
088 (7/8")	0.72	0.25	0.96	0.49	0.84	0.37	0.92	0.45	0.86	0.39	0.78	0.31
106 (1 1/16")	0.94	0.46	1.18	0.70	1.06	0.58	1.14	0.66	1.08	0.60	1.00	0.52
125 (1 1/4")	1.17	0.46	1.41	0.69	1.29	0.57	1.37	0.65	1.31	0.59	1.23	0.51
150 (1 1/2")	1.07	0.50	1.31	0.74	1.19	0.61	1.27	0.70	1.21	0.64	1.13	0.56
200 (2")	1.52	0.77	1.75	1.01	1.63	0.88	1.72	0.97	1.66	0.91	1.58	0.83

Auto Switch Mounting Position (NCDMC, NCDME) (in)

Auto switch model	D-B5 D-B6		D-C7□ D-C80 D-C73C D-C80C		D-B59W		D-H7□ D-H7C D-H7□W D-H7BAL D-H7NF		D-H7LF		D-G59 D-K59	
	A	B	A	B	A	B	A	B	A	B	A	B
075 (3/4")	0.88	0.80	1.12	1.03	1.00	0.91	1.08	1.00	1.02	0.94	0.94	0.86
088 (7/8")	0.72	0.53	0.96	0.76	0.84	0.64	0.92	0.72	0.86	0.66	0.78	0.59
106 (1 1/16")	0.94	0.70	1.18	0.94	1.06	0.81	1.14	0.90	1.08	0.84	1.00	0.76
125 (1 1/4")	1.17	0.79	1.41	1.02	1.29	0.90	1.37	0.98	1.31	0.92	1.23	0.85
150 (1 1/2")	1.07	0.70	1.31	0.93	1.19	0.81	1.27	0.89	1.21	0.83	1.13	0.75
200 (2")	1.52	1.14	1.75	1.38	1.63	1.25	1.72	1.34	1.66	1.28	1.58	1.20

Auto Switch Mounting Position (NCDMB-*C) (in)

Auto switch model	D-B5 D-B6		D-C7□ D-C80 D-C73C D-C80C		D-B59W		D-H7□ D-H7C D-H7□W D-H7BAL D-H7NF		D-H7LF		D-G59 D-K59	
	A	B	A	B	A	B	A	B	A	B	A	B
075 (3/4")	0.92	0.35	1.16	0.58	1.03	0.46	1.12	0.54	1.06	0.48	0.98	0.40
088 (7/8")	0.85	0.38	1.09	0.62	0.97	0.50	1.05	0.58	0.99	0.52	0.91	0.44
106 (1 1/16")	1.07	0.59	1.31	0.83	1.19	0.71	1.27	0.79	1.21	0.73	1.13	0.65
125 (1 1/4")	1.30	0.59	1.54	0.82	1.42	0.70	1.50	0.78	1.44	0.72	1.36	0.64
150 (1 1/2")	1.20	0.63	1.44	0.87	1.32	0.74	1.40	0.83	1.34	0.77	1.26	0.69
200 (2")	1.65	0.90	1.88	1.14	1.76	1.01	1.85	1.10	1.79	1.04	1.71	0.96

Auto Switch Mounting Position (NCDMC-*C, NCDME-*C) (in)

Auto switch model	D-B5 D-B6		D-C7□ D-C80 D-C73C D-C80C		D-B59W		D-H7□ D-H7C D-H7□W D-H7BAL D-H7NF		D-H7LF		D-G59 D-K59	
	A	B	A	B	A	B	A	B	A	B	A	B
075 (3/4")	0.92	0.78	1.16	1.01	1.03	0.89	1.12	0.98	1.06	0.92	0.98	0.84
088 (7/8")	0.85	0.66	1.09	0.89	0.97	0.77	1.05	0.85	0.99	0.79	0.91	0.72
106 (1 1/16")	1.07	0.83	1.31	1.07	1.19	0.94	1.27	1.03	1.21	0.97	1.13	0.89
125 (1 1/4")	1.30	0.92	1.54	1.15	1.42	1.03	1.50	1.11	1.44	1.05	1.36	0.98
150 (1 1/2")	1.20	0.83	1.44	1.06	1.32	0.94	1.40	1.02	1.34	0.96	1.26	0.88
200 (2")	1.65	1.27	1.88	1.51	1.76	1.38	1.85	1.47	1.79	1.41	1.71	1.33

Mounting Height (NCDM) (in)

Auto switch model	D-B5 D-B6 D-B59W D-H7C D-G59 D-K59		D-C7□ D-C80 D-H7□ D-H7□W D-H7BAL D-H7□F		C-C73C D-C80C	
	≅ HS		≅ HS		≅ HS	
075 (3/4")	0.98		0.87		0.96	
088 (7/8")	1.04		0.93		1.02	
106 (1 1/16")	1.14		0.98		1.12	
125 (1 1/4")	1.24		1.08		1.22	
150 (1 1/2")	1.36		1.20		1.34	
200 (2")	1.61		1.46		1.59	

Double Acting/Single Rod/Band Mounting Auto Switch Mounting Position and Mounting Height

D-C7/C8

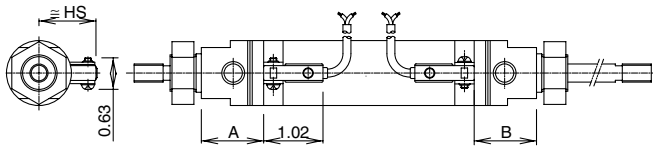

D-H7□/H7□W/H7□F/H7BAL□

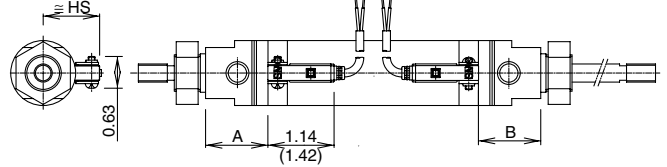

* () : D-H7LF

D-B5/B6/B59W

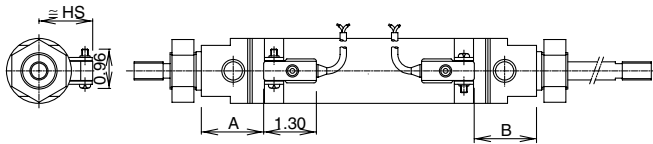

D-G59/K59

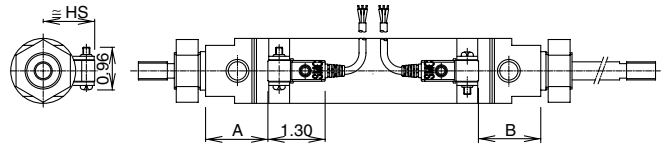

D-C73C/C80C

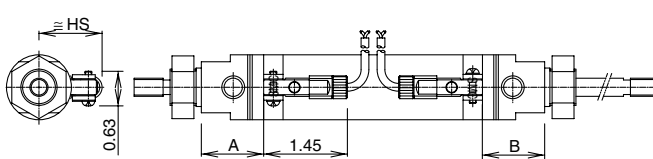

D-H7C

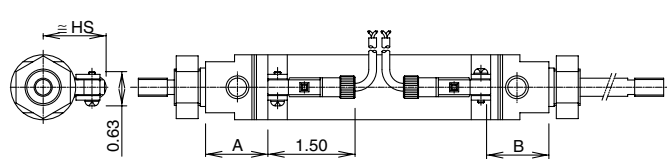

Auto Switch Mounting Position (NCDMW) (in)

Auto switch model	D-B5 D-B6		D-C7□ D-C80 D-C73C D-C80C		D-B59W		D-H7□ D-H7C D-H7□W D-H7BAL D-H7NF		D-H7LF		D-G59 D-K59	
	A	B	A	B	A	B	A	B	A	B	A	B
075 (3/4")	0.88	0.89	1.12	1.13	1.00	1.00	1.08	1.09	1.02	1.03	0.94	0.95
088 (7/8")	0.72	0.72	0.96	0.95	0.84	0.83	0.92	0.91	0.86	0.85	0.78	0.77
106 (1 1/16")	0.94	0.95	1.18	1.18	1.06	1.06	1.14	1.14	1.08	1.09	1.00	1.01
125 (1 1/4")	1.17	1.14	1.41	1.38	1.29	1.26	1.37	1.34	1.31	1.28	1.23	1.20
150 (1 1/2")	1.07	1.07	1.31	1.31	1.19	1.18	1.27	1.27	1.21	1.21	1.13	1.13
200 (2")	1.52	1.45	1.75	1.69	1.63	1.57	1.72	1.65	1.66	1.59	1.58	1.51

Auto Switch Mounting Position (NCDMW-*C) (in)

Auto switch model	D-B5 D-B6		D-C7□ D-C80 D-C73C D-C80C		D-B59W		D-H7□ D-H7C D-H7□W D-H7BAL D-H7NF		D-H7LF		D-G59 D-K59	
	A	B	A	B	A	B	A	B	A	B	A	B
075 (3/4")	0.92	0.87	1.16	1.11	1.03	0.98	1.12	1.07	1.06	1.01	0.98	0.93
088 (7/8")	0.85	0.85	1.09	1.08	0.97	0.96	1.05	1.04	0.99	0.98	0.91	0.90
106 (1 1/16")	1.07	1.08	1.31	1.31	1.19	1.19	1.27	1.27	1.21	1.22	1.13	1.14
125 (1 1/4")	1.30	1.27	1.54	1.51	1.42	1.39	1.50	1.47	1.44	1.41	1.36	1.33
150 (1 1/2")	1.20	1.20	1.44	1.44	1.32	1.31	1.40	1.40	1.34	1.34	1.26	1.26
200 (2")	1.65	1.58	1.88	1.82	1.76	1.70	1.85	1.78	1.79	1.72	1.71	1.64

Mounting Height (NCDM) (in)

Auto switch model	D-B5 D-B6 D-B59W D-H7C D-G59 D-K59		D-C7□ D-C80 D-H7□ D-H7□W D-H7BAL D-H7□F		C-C73C D-C80C	
	≅ HS		≅ HS		≅ HS	
075 (3/4")	0.98		0.87		0.96	
088 (7/8")	1.04		0.93		1.02	
106 (1 1/16")	1.14		0.98		1.12	
125 (1 1/4")	1.24		1.08		1.22	
150 (1 1/2")	1.36		1.20		1.34	
200 (2")	1.61		1.46		1.59	

CJ1

CJP

CJ2

CM2

CG1

MB

MB1

CA2

CS1

C76

C85

C95

CP95

NCM

NCA

D-

-X

20-

Data

Series NCM

Double Acting/Single Rod/Band Mounting Auto Switch Mounting Position and Mounting Height

D-C7/C8

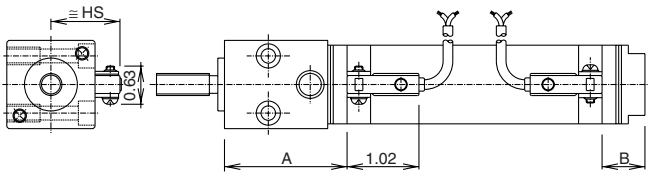

D-H7□/H7□W/H7□F/H7BAL□

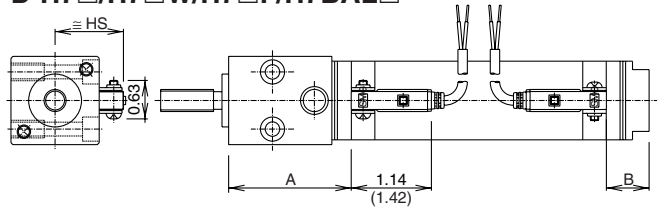

D-B5/B6/B59W

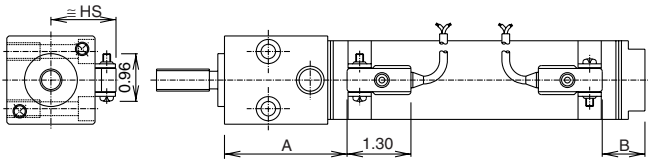

D-G59/K59

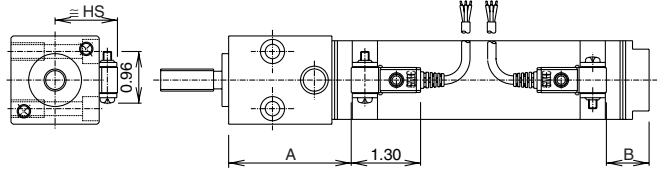

* (): D-H7LF

D-C73C/C80C

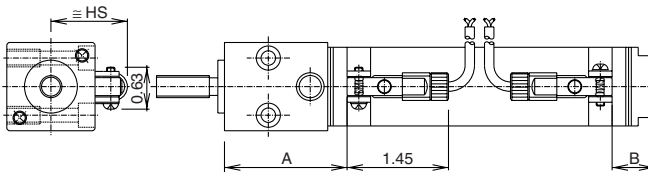

D-H7C

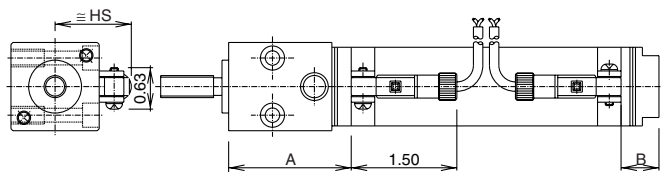

Auto Switch Mounting Position (NCDMR) (in)

Auto switch model	D-B5 D-B6		D-C7□ D-C80 D-C73C D-C80C		D-B59W		D-H7□ D-H7C D-H7□W D-H7BAL D-H7NF		D-H7LF		D-G59 D-K59	
	A	B	A	B	A	B	A	B	A	B	A	B
075 (3/4")	1.30	0.37	1.54	0.60	1.42	0.48	1.50	0.56	1.44	0.50	1.36	0.42
106 (1 1/16")	1.61	0.46	1.85	0.70	1.72	0.58	1.81	0.66	1.75	0.60	1.67	0.52
150 (1 1/2")	2.10	0.50	2.33	0.74	2.21	0.61	2.29	0.70	2.24	0.64	2.16	0.56

Auto Switch Mounting Position (NCDMR-※C) (in)

Auto switch model	D-B5 D-B6		D-C7□ D-C80 D-C73C D-C80C		D-B59W		D-H7□ D-H7C D-H7□W D-H7BAL D-H7NF		D-H7LF		D-G59 D-K59	
	A	B	A	B	A	B	A	B	A	B	A	B
075 (3/4")	1.30	0.37	1.54	0.60	1.42	0.48	1.50	0.56	1.44	0.50	1.36	0.42
106 (1 1/16")	1.61	0.46	1.85	0.70	1.72	0.58	1.81	0.66	1.75	0.60	1.67	0.52
150 (1 1/2")	2.10	0.50	2.33	0.74	2.21	0.61	2.29	0.70	2.24	0.64	2.16	0.56

Mounting Height (NCDM) (in)

Auto switch model	D-B5 D-B6 D-B59W D-H7C D-G59 D-K59		D-C7□ D-C80 D-H7□ D-H7□W D-H7BAL D-H7□F		C-C73C D-C80C	
	≅ HS		≅ HS		≅ HS	
075 (3/4")	0.98		0.87		0.96	
088 (7/8")	1.04		0.93		1.02	
106 (1 1/16")	1.14		0.98		1.12	
125 (1 1/4")	1.24		1.08		1.22	
150 (1 1/2")	1.36		1.20		1.34	
200 (2")	1.61		1.46		1.59	