

# Air Checker: Electronic Pressure Switch

## PS1000/PS1100/PS1200 Series

(For Positive Pressure) (For Vacuum, Residual Pressure) (For Vacuum)

Applicable fluid:  
Air, Non-corrosive gas, Non-flammable gas



Compact/lightweight  
electronic pressure switch

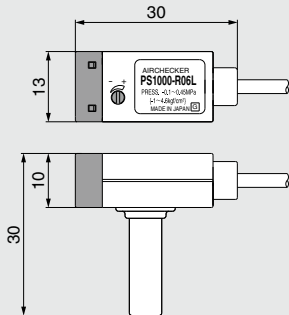
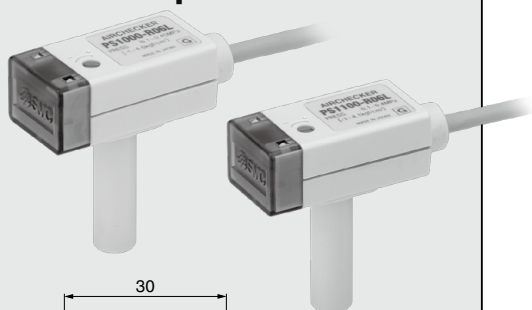

Addition of vacuum range (-100 to 0 kPa)  
Easy adjustment of pressure setting trimmer

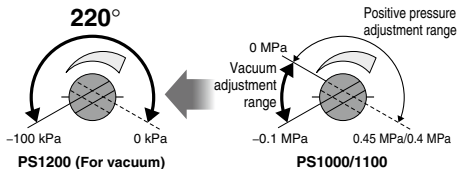

ZSE20
ISE20
ZSE30
ISE30
ZSE40
ISE40
ZSE10
ISE10
ISE70
ZSE80
ISE80
<b>PS</b>
ISA3
ISA2
ISE35
PSE
IS
ISG
ZSM1

### Easy mounting

Plug-in reducer port for One-touch fittings

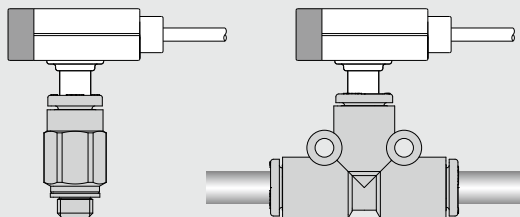

### High visibility

A large LED display for an easily visible switch

### 2-wire type

Applicable to either NPN or PNP output

# Air Checker: Electronic Pressure Switch

## PS1000/1100/1200 Series



### How to Order

PS 10 00 - R06 L - Q

#### Output specifications

10	For positive pressure
11	For vacuum and residual pressure
12	For vacuum

#### Piping specifications

R06	ø6 reducer
R07	1/4" reducer

#### Option (CE-compliant\*)

Nil	None
Q	CE-compliant

\* The PS1200 series is CE-compliant (with Q) only.

#### Lead wire length

L	3 m
---	-----

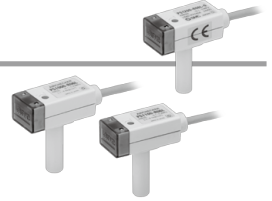

Refer to pages 11 and 12 for Pressure Switch Precautions. For details about the Specific Product Precautions, refer to the Operation Manual on the SMC website, <http://www.smcworld.com>

### Specifications

Model	PS1000	PS1100	PS1200
Switch output	Present pres. ≥ Setting pres.: ON		Present pres. ≤ Setting pres.: ON
Max. operating pressure	1 MPa		500 kPa
Set pressure range	-0.1 to 0.45 MPa	-0.1 to 0.4 MPa	-100 to 0 kPa
Fluid	Air/Non-corrosive gas/Non-flammable gas		
Indicator light	ON: When red LED turns on		
Temperature characteristics	±3% F.S.		
Repeatability	±1% F.S.		
Hysteresis	4% F.S. or less		10% F.S. or less
Load voltage	12 to 24 VDC ±10%, Ripple (p-p) 10% or less		
Load current	5 to 40 mA		
Leakage current	1 mA or less		
Internal voltage drop	5 V or less		
Operating temperature range	0 to 60°C (No condensation)		
Insulation resistance	2 MΩ or more (500 VDC measured via megohmmeter) between terminals and housing		
Withstand voltage	1000 VAC (in 50/60 Hz) for 1 minute between terminals and housing		
Weight	5 g (Excluding lead wire)		
Port size	R06: ø6 reducer, R07: 1/4" reducer		
Enclosure	IP40		
Lead wire	Grommet oilproof heavy-duty vinyl cable 2 cores, ø2.55, 3 m, Conductor area: 0.18 mm <sup>2</sup> , Insulator O.D.: 0.96 mm		
Wetted parts material	Pressured sensor part: Silicon, Body part: PBT, O-ring: HNBR		
Standards	CE (Option), RoHS		

## Switch Specifications

### PS1000, PS1100

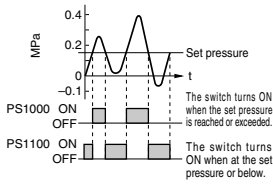

### PS1200

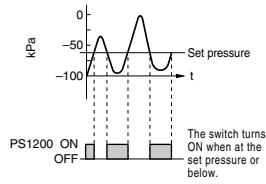

## Setting of Pressure Switch

- Use the pressure setting trimmer to set ON pressure.
- Rotate clockwise to increase the set pressure. For setting vacuum, rotate counterclockwise.
- To set, use a flat head screwdriver suited for the groove of the trimmer, and rotate it lightly with finger tip.

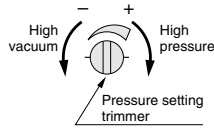

## Trimmer

Rotation angle of the trimmer is 220°.

There is a stop provided to prevent the trimmer from rotating beyond its limits. Rotation beyond the limit can damage the trimmer. Adjust the trimmer gently within the rotation angle.



## Internal Circuits and Wiring Examples

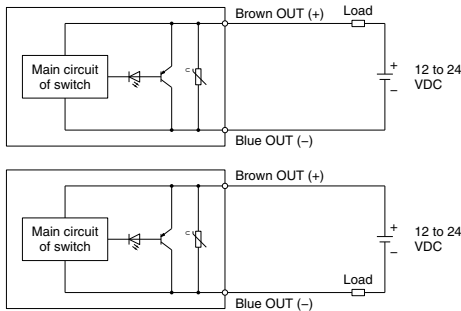

## Example of connection with a PLC (Sequence controller)

### For source type input unit

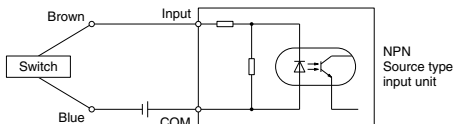

### For sink type input unit

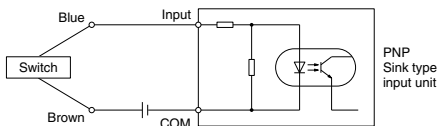

## Dimensions

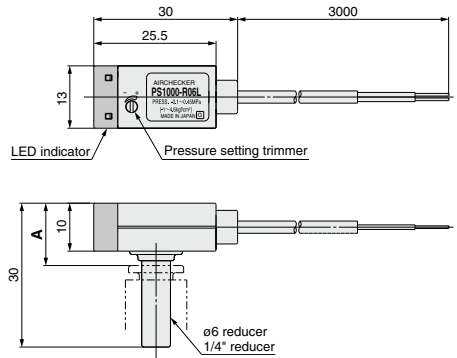

## Dimensions

Applicable One-touch fittings	A
KQ2H/L/T/S/Y06-M5	16
KQ2H/L07-M5	16
Other KQ2/KS series	13
KJ series	16

ZSE20  
ISE20

ZSE30  
ISE30

ZSE40  
ISE40

ZSE10  
ISE10

ISE70

ZSE80  
ISE80

PS

ISA3

ISA2

ISE35

PSE

IS

ISG

ZSM1