

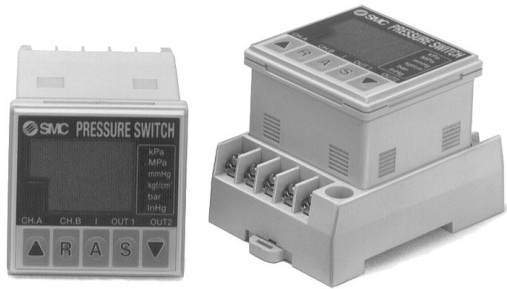

# Controller Series *PSE100*

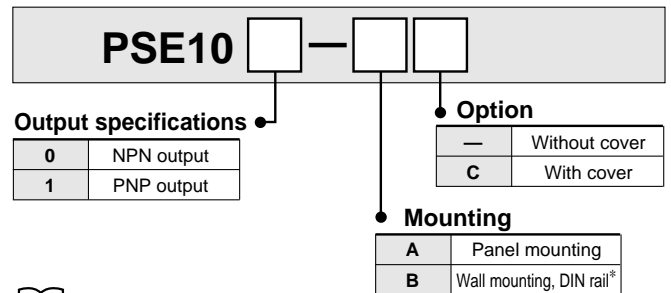

## How to Order



\*Refer to p.3.1-14 for DIN rail part number.

## Controller Specifications

Model	PSE100-□	PSE101-□
Output specifications	NPN Open Collector 30V 80mA max.	PNP Open Collector 80mA max.
Number of outputs	2CH X 2 outputs	
Pressure display range	-101 to 10kPa (For vacuum), -10 to 100kPa (For low press.), -0.1 to 1MPa (For high press.)	
Display resolution	0.1kPa (For vacuum, low pressure), 1kPa (For high pressure)	
Display unit	For vacuum pressure and low pressure	kPa, mmHg, kgf/cm <sup>2</sup> , bar, InHg
	For high pressure	kPa, MPa, kgf/cm <sup>2</sup> , bar
Operating display	Light at ON. (Switch output 1: Green, Switch output 2: Red)	
Frequency response	100Hz (10ms)	
Hysteresis	Hysteresis mode: Variable, Window comparator mode: Fixed (2% F.S.)	
Temp characteristics (25°C standard)	25 ± 10°C	±0.3% F.S. or less
	0 to 50°C	±0.5% F.S. or less
Repeatability	±0.2% F.S. or less	
Supply voltage	12 to 24V DC (Ripple ±10% or less)	
Current consumption	250mA or less	
Error display	Error display at 7 segment LED	
Display specifications	4 figures X 2, 7 segment LED display, Sampling cycle 4 times/sec.	
Self diagnostic function	Excess pressure, Excess current, NO sensor connection, Data error (Pressure presence at zero clear)	
Additional function	Auto preset: Possible to set adsorption confirmation by pressing button only.	
	Auto shift: Possible to zero clear by input terminal	
Operating temperature range	0 to 50°C (No condensation)	
Noise resistance	500Vp-p, Pulse width 1μs, Standing 1ns	
Voltage resistance	Between external terminal and case 1000V AC, 50/60Hz for 1 min.	
Insulation resistance	Between external terminal and case 2MΩ (500V DC by megameter)	
Vibration resistance	10 to 500Hz Width: 1.5mm or acceleration 98m/s <sup>2</sup> (at the smaller vibration) to X, Y, Z direction (2 hours)	
Shock resistance	980m/s <sup>2</sup> to X, Y, Z direction (3 times for each direction)	
Protective construction	Panel mounting type: IP66 (Used gasket at panel mount part only), Wall mounting, DIN rail type: IP40	
Mounting	A: Panel mounting, B: Wall mounting, DIN rail	
Weight	A: Approx. 90g B: Approx. 110 g	
Sensor connection	Supply voltage	Same as power supply
	Voltage input	1 to 5V (Input impedance 100KΩ)
	Current input	4 to 20mA (Input impedance 250Ω)

## Input/Output Circuit and Connection

### Connection diagram

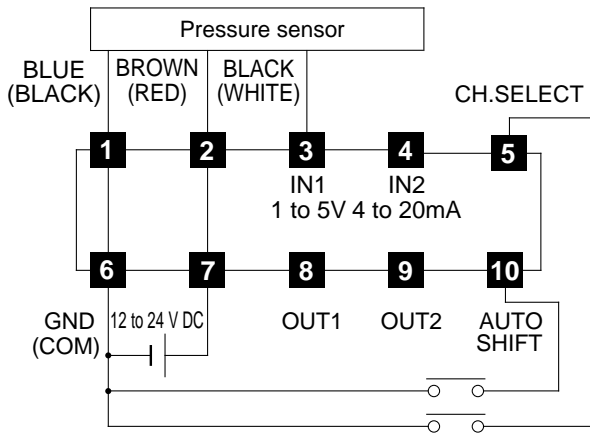

### Sensor connection

#### Voltage input type

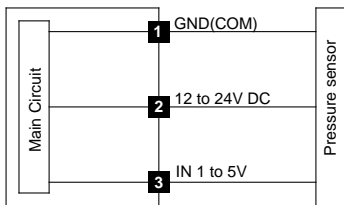

#### Current input type

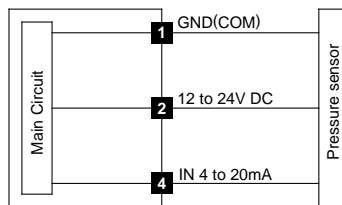

### Input/Output circuit diagram

#### NPN output circuit diagram

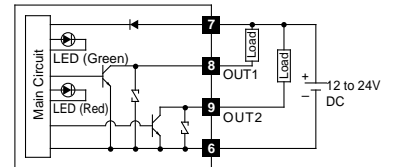

#### PNP output circuit diagram

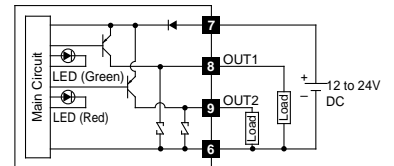

#### Input circuit diagram (Autoshift, channel selection)

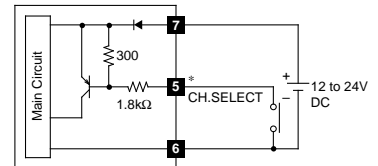

\*Same as **10** AUTO SHIFT.

#### How to use the auto shift function

Connect the autoshift terminal **10** to GND **6**. This forces the unit to accept a new zero point, the display will indicate "0". After disconnecting the autoshift terminal from GND, the display will indicate relative pressure based on the new zero point. Note) To invoke the autoshift function the autoshift terminal has to be connected to GND for at least 10 msec. LED1 will display "0" during connection to GND.

#### How to select channel

When CH.SELECT terminal **5** is open, channel A is selected. When it is connected to GND **6**, channel B is selected.

Note) There is a 10 msec. time delay from making contact and the actual selection of the channel.

## Description

Display of peak, bottom and absolute pressure (LED2)

Display of channels

UP button (▲)

Increases calibration value.

Reset button (R)

Clears abnormality. Displays "0".

Auto preset button (A)

Reads present pressure directly.

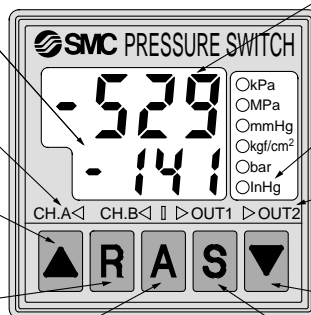

Display of present pressure (LED1)

Display of units

Display of outputs

Light turns on when output is ON.

DOWN button (▼)

Decreases calibration values.

Set button (S)

Changes calibration value and modes.

PSE

ZSE4  
ISE4

ZSE5  
ISE5

ZSE6  
ISE6

ZSE3  
ISE3

GS

PS

ISA

ZSE1  
ISE1

ZSE2  
ISE2

ZSP

IS□

ZSM

PF□

IF□

# PSE100

## Calibration Procedure

### Procedure

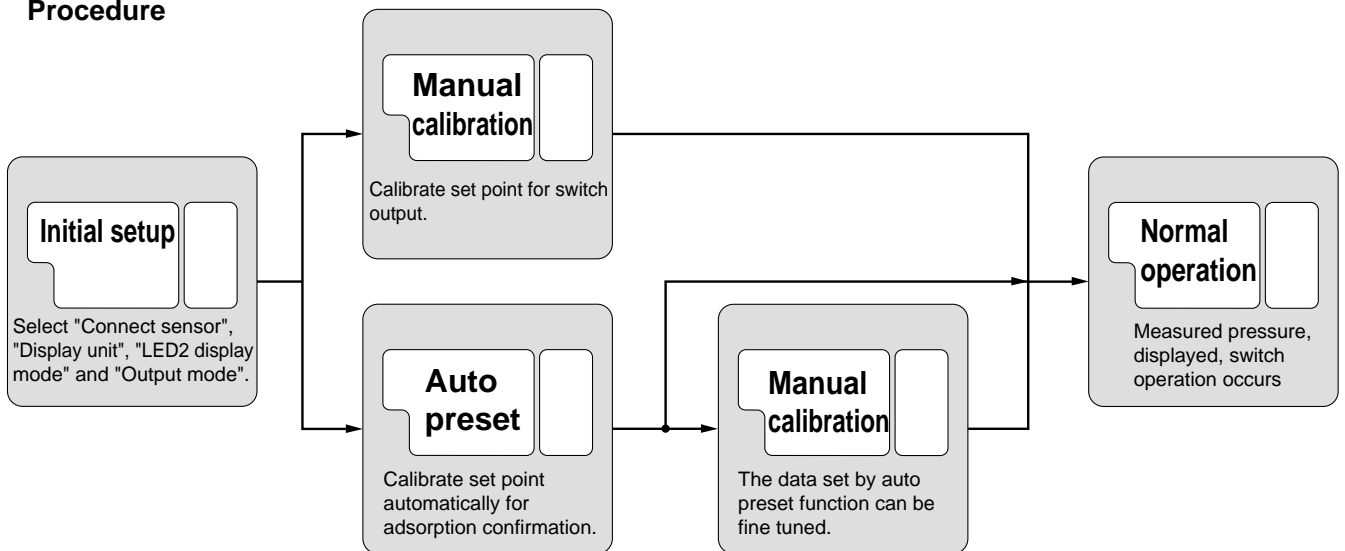

### Method of calibration/1, 2, 3

**Table 1** Sensor types and min. display unit

Sensor type	Display unit	kPa	MPa	mmHg	kgf/cm <sup>2</sup>	bar	InHg
PSE511(-100kPa)		-0.1	-	-1	-0.001	-0.001	-0.1
PSE512(100kPa)		0.1	-	1	0.001	0.001	0.1
PSE510, 520(1MPa)		1	0.001	-	0.01	0.01	-

**Table 2** LED2 display

LED2 (green) display indicates the following 3 mode options.

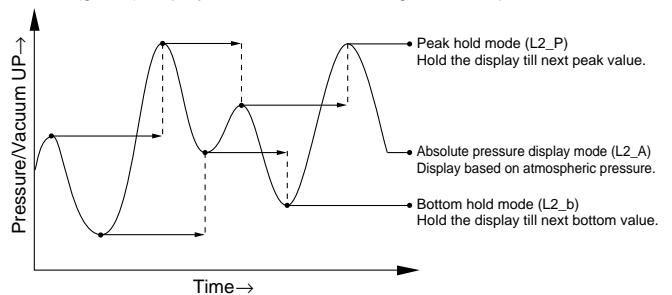

**Table 3** Output type

One output type can be selected from 4 types according to output modes and relation of each calibration values. Two separate outputs, OUT1 and OUT2, can be set per channel and two channels, A and B can be selected from outside.

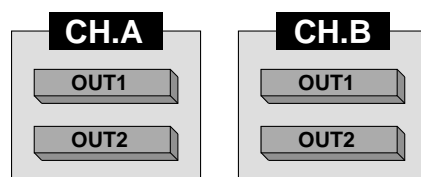

**CH.A** and **CH.B** can be selected by external signal.

Refer to p.3.1-8 "Channel selection" for further information.

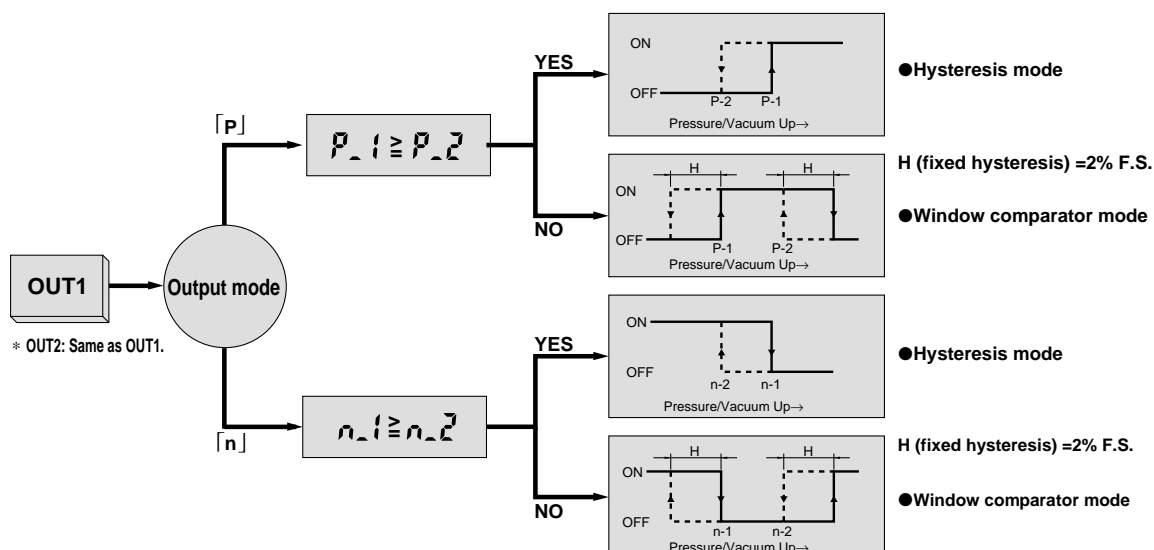

## Initial setup

### 1. Initial setup mode

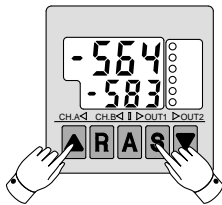

Press the button "S" at least 3 seconds while holding down the ▲ button.

### 2. Selection of "Connect sensor"

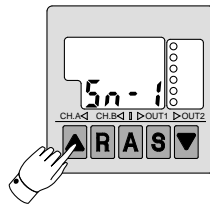

Select "Connect sensor" by pressing the ▲ button.  
LED2 display  
5n-1: PSE511 (For -100kPa)  
5n-2: PSE512 (For 100kPa)  
5n-3: PSE510/520 (For 1MPa)

### 3. Selection of "Display unit"

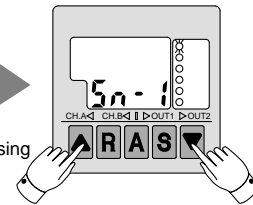

"Display unit" is entered by pressing the button "S".

Select "Display unit" by pressing the ▲ or ▼ button. (Refer to p.3.1-9 [Table 1](#).)

### 4. Selection of "LED2 display mode"

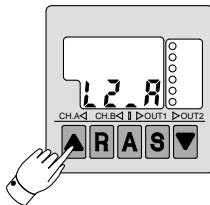

Select "LED2 display mode" by pressing the ▲ button.  
LED2 display  
L2-A: Absolute pressure  
L2-P: Peak hold  
L2-B: Bottom hold

(Refer to p.3.1-9 [Table 2](#).)

### 5. Selection of "OUT1 output mode"

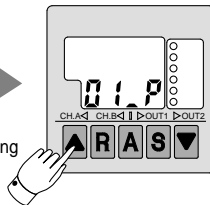

Select "OUT1 output mode" by pressing the ▲ button.  
LED2 display  
O1-P: Normal mode  
O1-N: Reversed output mode

(Refer to p.3.1-9 [Table 3](#).)

### 6. Selection of "OUT2 output mode"

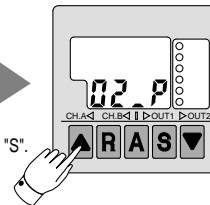

Select "OUT2 output mode" by pressing the ▲ button.  
LED2 display  
O2-P: Normal mode  
O2-N: Reversed output mode

PSE

ZSE4  
ISE4

ZSE5  
ISE5

ZSE6  
ISE6

ZSE3  
ISE3

GS

PS

ISA

ZSE1  
ISE1

ZSE2  
ISE2

ZSP

IS□

ZSM

PF□

IF□

## Manual calibration

### 1. Calibration value input mode (manual)

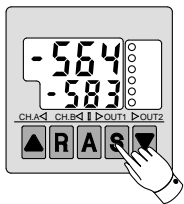

Press the button "S"  
3 seconds or less: Selected channel  
3 seconds or more: Not selected channel

### 2. Input set point value for OUT1 (1)

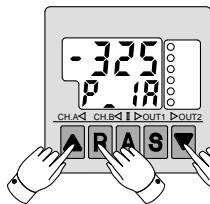

▲button: Increase set point value  
▼button: Decrease set point value  
R button: Reads the pressure value at that moment  
(Refer to p.3.1-9 [Table 3](#).)

### 3. Input set point value for OUT1 (2)

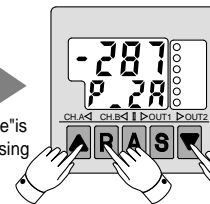

"OUT1(2) mode" is entered by pressing the button "S".

▲button: Increase set point value  
▼button: Decrease set point value  
R button: Reads the pressure value at that moment

### 4. Input set point value for OUT2 (3)

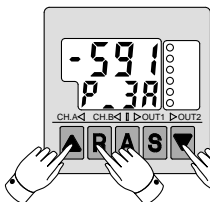

▲button: Increase set point value  
▼button: Decrease set point value  
R button: Reads the pressure value at that moment

### 5. Input set point value for OUT2 (4)

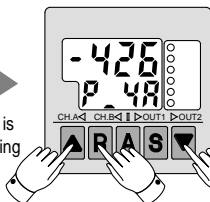

▲button: Increase set point value  
▼button: Decrease set point value  
R button: Reads the pressure value at that moment

By pressing the button "S" the calibration is completed.

# PSE100

## Calibration Procedure

### Auto preset

#### 1. Auto preset mode

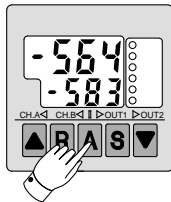

Press the button "A" for 3 to 6 seconds for selected channel, and for more than 6 seconds for not selected channel.

#### 2. Preparation for auto preset

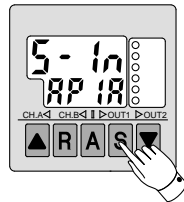

When the initial conditions for adsorption confirmation are met, press the button "S". Press the ▼ button when it is not required to calibrate OUT1.

#### 3. OUT1 auto preset

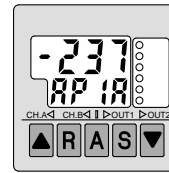

Repeat the steps adsorption and no adsorption several times. This will set the best values automatically.



After pressing button "S", OUT1 auto preset is completed.

(When the button "A" is pressed, calibration is not completed.)

#### 4. Preparation for auto preset

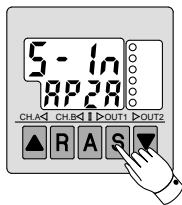

When the initial condition for adsorption confirmation are met, press the button "S". Press the ▼ button when it is not required to calibrate OUT2.

#### 5. OUT2 auto preset

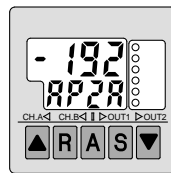

Repeat the steps adsorption and no adsorption several times. This will set the best values automatically.



After pressing button "S", OUT2 auto preset is completed.

(When the button "A" is pressed, calibration is not completed.)

\* Initial condition for adsorption confirmation means that conditions are met for operation to begin.

### Other function

#### Lock out

##### Lock out start

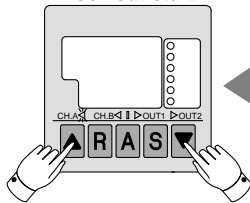

Press the ▼ and ▲ buttons simultaneously for at least 3 seconds. Display starts to blink.

##### Lock out release

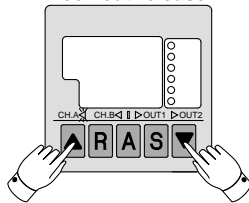

Press the ▲ and ▼ buttons simultaneously for at least 3 seconds. Lock out is released. During malfunction lockout is released automatically.

#### Reset display to "0"

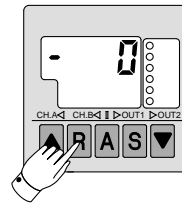

Press the button "R" for at least 3 seconds to reset the display to zero. If pressure is higher than  $\pm 2\%$  of rated pressure, reset of the display is not possible.

#### Clear auto shift

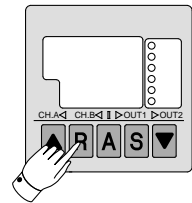

Press the button "R" for at least 2 seconds but no longer than 3 seconds. This clears the auto shift function.

## Error Codes

Error codes

Display	Cause	Solution
- F F F	Sensor is not connected.	Connect sensor.
F F F F	Operating pressure over max. limit.	Lower operating pressure.
E r r 1	Calibration data lost.	Contact SMC.
E r r 2 O U - 1	Current draw on Output 1 too high (>120mA).	Check load and/or wiring for Output 1.
E r r 2 O U - 2	Current draw on Output 2 too high (>120mA).	Check load and/or wiring for Output 2.
E r r 2 O U - A	Current draw on Output 1 and 2 too high (>120mA).	Check load and/or wiring for Output 1 and 2.
- - - -	Pressure is 2% above rated pressure during 0 clear.	Apply atmospheric pressure then do 0 clear.

## ⚠ Precautions

Be sure to read before handling. Refer to p.0-26 and 0-27 for Safety Instructions and common precautions on the products mentioned in this catalog, and refer to p.3.0-7 to 3.0-9 for precautions on every series.

### Wiring

#### ⚠ Warning

- ① Connect FG to ground when using switching power supply as a power source.
- ② Every input signal needs to be longer than 10ms to be recognized by the PSE.

### Installation

#### ⚠ Caution

- ① Front plate of the PSE100 meets IP66 rating. However if the panel mount adaptor is used and the instrument is not seated correctly, water might enter.
- ② As illustrated below, hook the nail located on the bottom of the body on the DIN rail and press down in the direction of the arrow. To remove from the DIN rail lift the switch up with a bladed screw driver, etc. in the direction of the arrow.
- ③ Be careful not to apply excessive force to the wiring during mounting on panel or DIN rail.

#### Panel mount

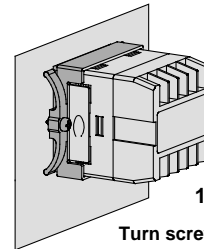

Turn screw 1/4 to 1/2 turn after panel makes contact with the sealing surface of the PSE.

#### Mounting on DIN rail

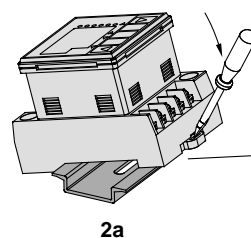

#### Removal from DIN rail

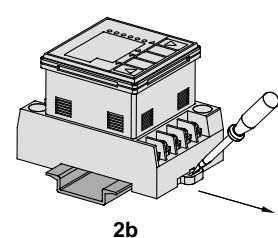

### Others

#### ⚠ Caution

1. Time delay for power on reset of controller is 0.5 seconds. Be aware that the output circuit is not active immediately after the power is connected.

PSE

ZSE4  
ISE4

ZSE5  
ISE5

ZSE6  
ISE6

ZSE3  
ISE3

GS

PS

ISA

ZSE1  
ISE1

ZSE2  
ISE2

ZSP

IS

ZSM

PF

IF

# PSE100

## Dimensions

### A: Panel mount

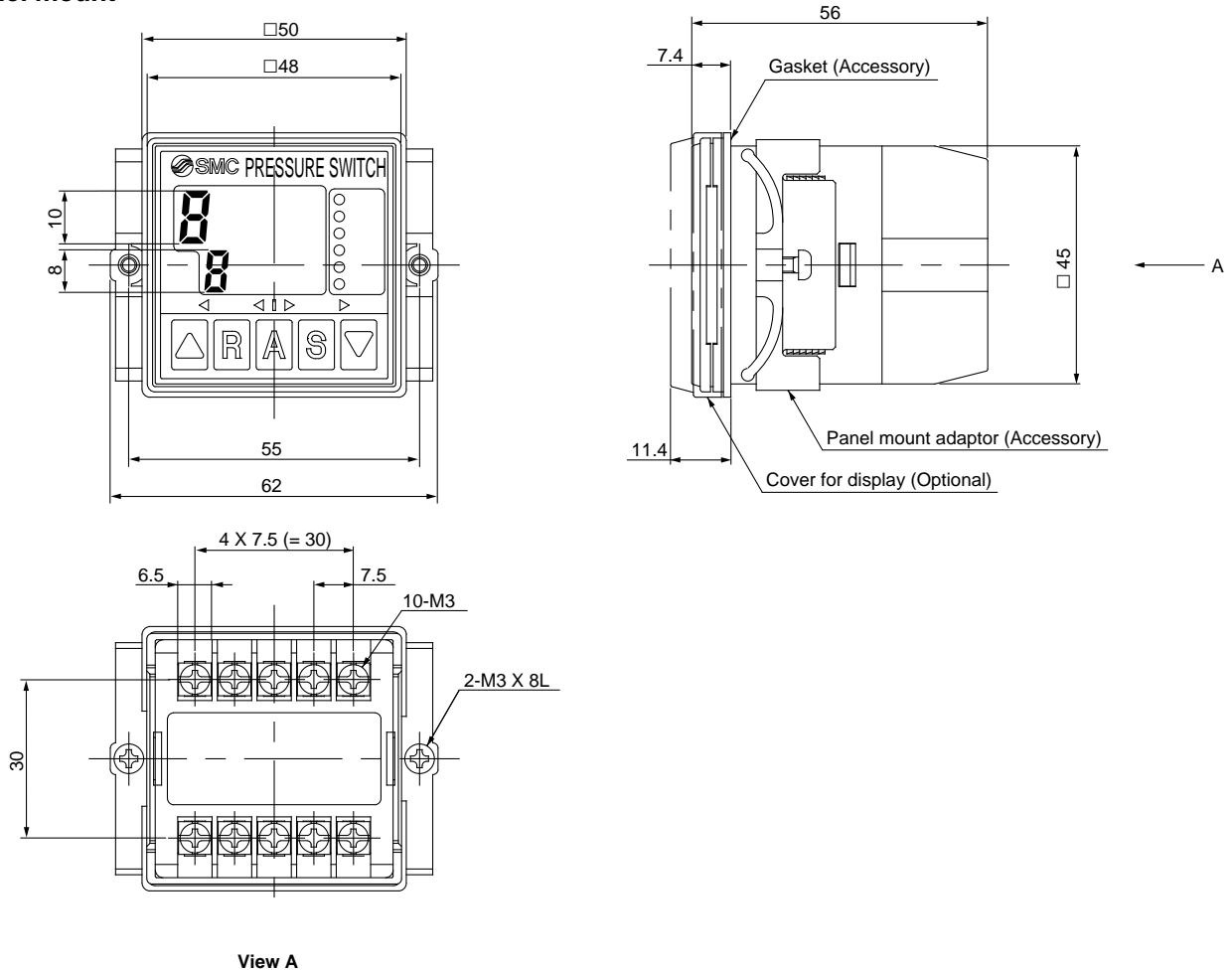

### Cutout dimensions for panel mount

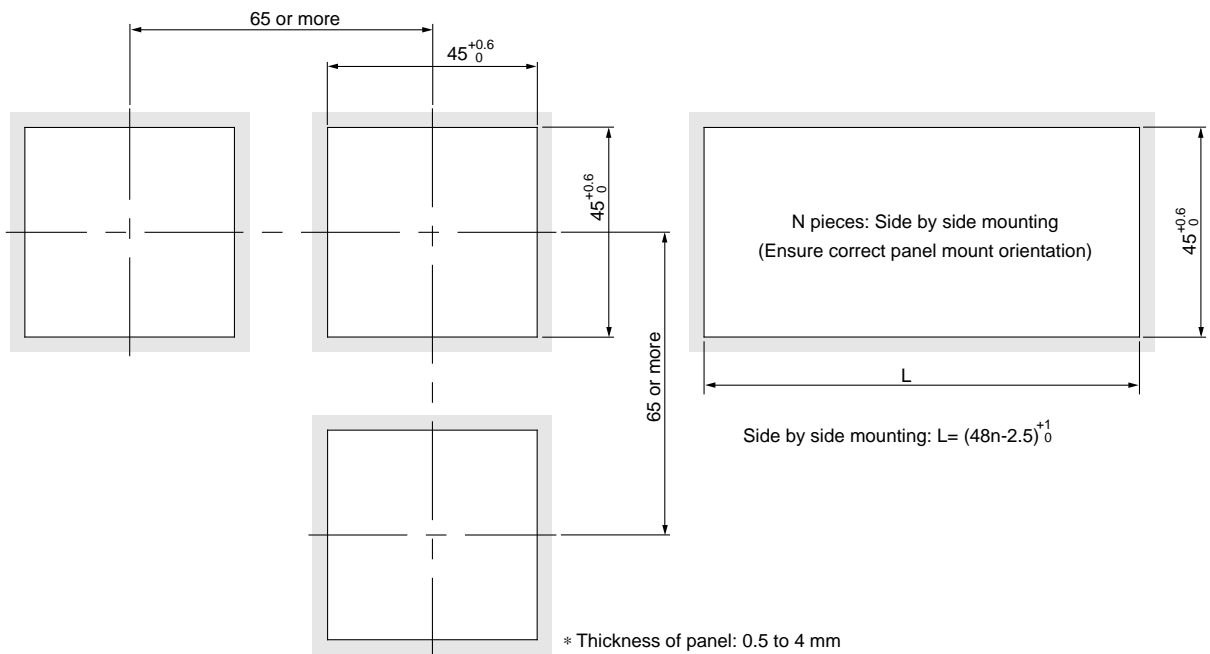

## B: Wall mount, DIN rail

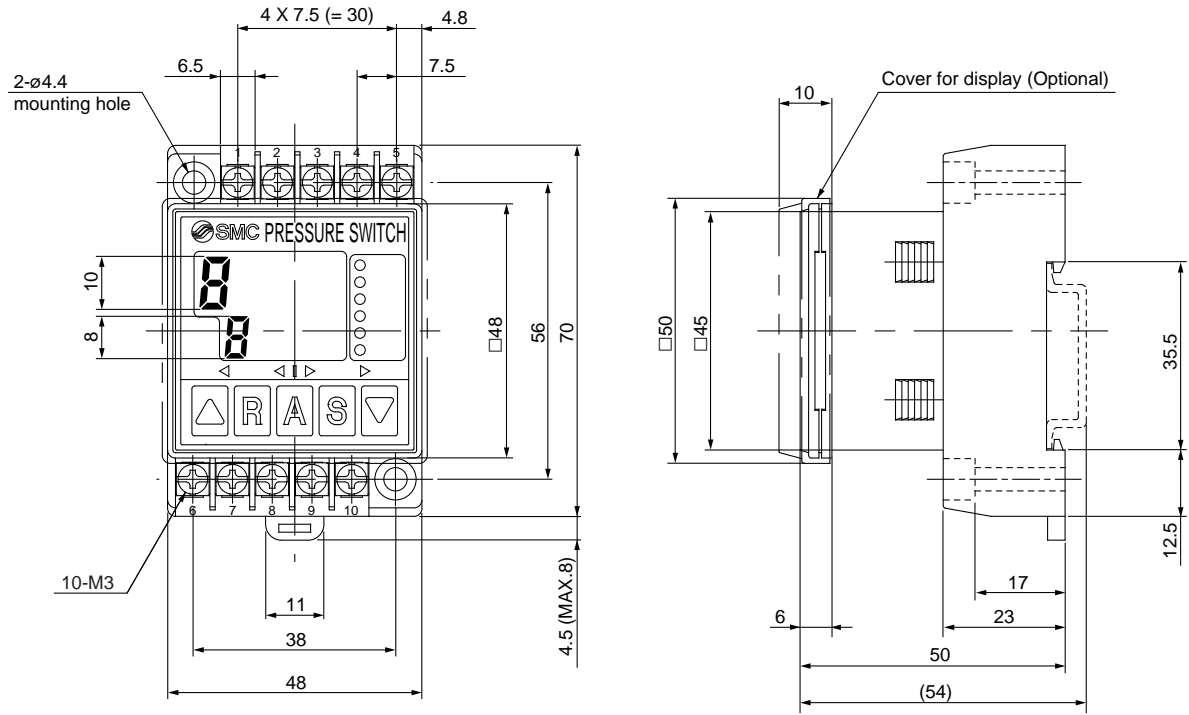

### DIN rail

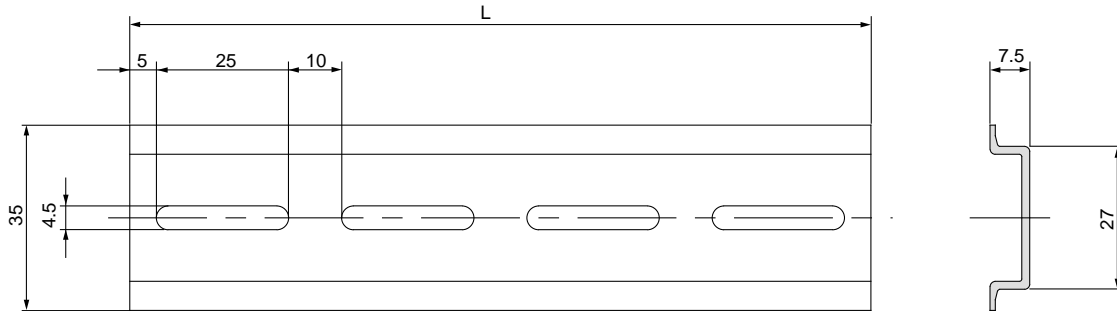

Material: Aluminum

### Part number of DIN rail

Part number	L
ISA-2-1	105
ISA-2-2	140
ISA-2-3	175
ISA-2-4	210
ISA-2-5	245
ISA-2-6	280
ISA-2-7	315

**PSE**

ZSE4  
ISE4

ZSE5  
ISE5

ZSE6  
ISE6

ZSE3  
ISE3

**GS**

**PS**

**ISA**

ZSE1  
ISE1

ZSE2  
ISE2

**ZSP**

**IS**

**ZSM**

**PF**

**IF**