

4 Port Solenoid Valve Common Specifications

Series SJ2000/3000



Manifold Specifications

Model	D-sub connector		Flat ribbon cable			Serial wiring		Individual wiring
	Type 60F	Type 60P	Type 60PG Type 60J Type 60G	Type 60PH	Type 60S□ (EX180)	Type 60S6B (EX510)	Type 60	
Manifold type	Plug-in, Connector type							Non-plug-in
1(P: SUP), 3/5(E: EXH)	Common SUP, EXH							
Valve stations	2 to 24 stations		2 to 18 stations (Type PG) 2 to 16 stations (Type J, Type G)	2 to 8 stations	2 to 32 stations	2 to 16 stations	2 to 20 stations	
Applicable connector	D-sub connector Conforming to MIL-C-24308 JIS-X-5101	Flat ribbon cable connector Socket: 26 pins MIL type with strain relief Conforming to MIL-C-83503	Flat ribbon cable connector Socket: 20 pins MIL type with strain relief Conforming to MIL-C-83503	Flat ribbon cable connector Socket: 10 pins MIL type with strain relief Conforming to MIL-C-83503	—	—	—	
Internal wiring	Non-polar, +COM							
4(A), 2(B) port piping spec.	Location	Valve						
	Direction	Horizontal, Upward, Downward (Using elbow fittings for upward or downward)						
Port size	1(P), 3/5(E) port		C6, C8, N7, N9 (Inch size elbow fitting is not available.)					
	4(A), 2(B) port	SJ2000	C2, C4, N1, N3, M3					
		SJ3000	C2, C4, C6, N1, N3, N7, M5					
Weight W (g) ^{Note 2)}	n: Number of SUP/EXH blocks m: Weight of DIN rail		$W = 51n + m + 133$					

Note 1) When many valves are operated simultaneously, use B type (SUP/EXH both sides), applying pressure to the 1(P) ports on both sides and exhaust from the 3/5(E) ports on both sides.

Note 2) The weight W is the value for the D-sub connector manifold only with internal pilot, SUP/EXH block straight fittings specifications. To obtain the weight with solenoid valves attached, add the solenoid valve weights given on page 3 for the appropriate number of stations. Refer to page 61 for the weight of DIN rail. (Please contact SMC for the weight of external pilot specifications, elbow fittings.)

Flow Characteristics

SJ2000

Port size		Flow characteristics					
1(P) 3/5(E)	4, 2 (A, B)	1→2/4 (P→A/B)			4/2→3/5 (A/B→E)		
		C [dm ³ /(s·bar)]	b	Cv	C [dm ³ /(s·bar)]	b	Cv
C8	C2	0.13	0.55	0.04	0.13	0.50	0.04
	C4	0.33	0.16	0.08	0.36	0.13	0.08
	M3	0.18	0.52	0.06	0.20	0.29	0.06

SJ3000

Port size		Flow characteristics					
1(P) 3/5(E)	4, 2 (A, B)	1→2/4 (P→A/B)			4/2→3/5 (A/B→E)		
		C [dm ³ /(s·bar)]	b	Cv	C [dm ³ /(s·bar)]	b	Cv
C8	C2	0.13	0.56	0.04	0.14	0.51	0.04
	C4	0.42	0.17	0.11	0.45	0.16	0.11
	C6	0.55	0.10	0.12	0.56	0.11	0.12
	M5	0.40	0.28	0.11	0.45	0.15	0.11

Note) The value is for manifold base with 5 stations and individually operated 2 position type.
Please contact SMC for 4 position dual 3 port valves.

Series SJ2000/3000

Solenoid Valve Specifications



D-sub connector



Flat ribbon cable

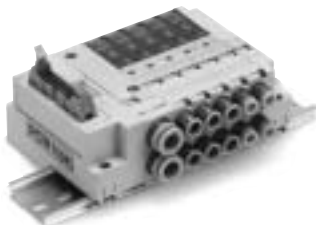

PC wiring



Serial wiring: EX180

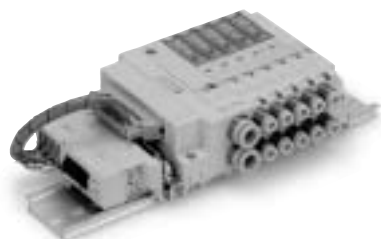

Gateway system
Serial transmission system: EX510



Individual wiring

Fluid		Air	
Internal pilot operating pressure range (MPa)	2 position single		0.15 to 0.7
	4 position dual 3 port valve		
	2 position double		0.1 to 0.7
	3 position		0.2 to 0.7
External pilot operating pressure range (MPa)	Operating pressure range		-100 kPa to 0.7
	Pilot pressure range	2 position single	0.25 to 0.7
		2 position double	
3 position			
Ambient and fluid temperature (°C)			-10 to 50 (No freezing)
Maximum operating frequency (Hz)	2 position single, double		10
	4 position dual 3 port valve		
	3 position		3
Manual override (Manual operation)			Non-locking push type Push-turn locking slotted type
Pilot exhaust method	Internal pilot		Main and pilot valve common exhaust
	External pilot		Pilot valve individual exhaust
Lubrication			Not required
Mounting orientation			Unrestricted
Shock/Vibration resistance (m/s ²)			150/30
Enclosure			Dustproof

Note) Impact resistance: No malfunction occurred when it is tested with a drop tester in the axial direction and at the right angles to the main valve and armature in both energized and de-energized states every once for each condition. (Value in the initial state)

Vibration resistance: No malfunction occurred in one sweep test between 45 and 2000Hz. Test was performed to axis and right angle directions of the main valve when pilot signal is ON and OFF. (Value in the initial state)

Solenoid Specifications

Coil rated voltage		24 VDC, 12 VDC	
Allowable voltage fluctuation		±10% of rated voltage*	
Power consumption (W)	Standard	SJ2000	0.55
		SJ3000	0.4
	With power saving circuit (Continuous duty type)	SJ2000	0.23
		SJ3000	0.15
Surge voltage suppressor		Diode	
Indicator light		LED	

* For the allowable voltage fluctuation for Z and T types (with power saving circuit), please observe the following range because they have voltage drop due to internal circuit.

Z type 24 VDC: -7% to +10%
12 VDC: -4% to +10%
T type 24 VDC: -5% to +10%
12 VDC: -6% to +10%

Response Time

Type of actuation	Response time ms (at 0.5 MPa)	
	SJ2000	SJ3000
2 position single	16 or less	16 or less
2 position double	10 or less	10 or less
3 position	34 or less	22 or less
4 position dual 3 port valve	30 or less	30 or less

Note) Based on dynamic performance test, JIS B 8375-1981. (Coil temperature: 20°C, at rated voltage)

Weight

Model/SJ2000

Valve model	Type of actuation	Port size 4(A), 2(B)	Weight (g)	
SJ2□60-C2	2 position	C2 (ø2 one-touch fitting)	Single	43
			Double	46
	3 position		Closed center	50
			Exhaust center	
			Pressure center	
4 position	Dual 3 port valve	46		
SJ2□60-C4	2 position	C4 (ø4 one-touch fitting)	Single	41
			Double	44
	3 position		Closed center	48
			Exhaust center	
			Pressure center	
4 position	Dual 3 port valve	44		
SJ2□60-M3	2 position	M3 x 0.5	Single	39
			Double	42
	3 position		Closed center	46
			Exhaust center	
			Pressure center	
4 position	Dual 3 port valve	42		

Note) Please contact SMC for the weight of elbow fittings.

Model/SJ3000

Valve model	Type of actuation	Port size 4(A), 2(B)	Weight (g)	
SJ3□60-C2	2 position	C2 (ø2 one-touch fitting)	Single	63
			Double	71
	3 position		Closed center	75
			Exhaust center	
			Pressure center	
4 position	Dual 3 port valve	71		
SJ3□60-C4	2 position	C4 (ø4 one-touch fitting)	Single	65
			Double	73
	3 position		Closed center	77
			Exhaust center	
			Pressure center	
4 position	Dual 3 port valve	73		
SJ3□60-C6	2 position	C6 (ø6 one-touch fitting)	Single	61
			Double	69
	3 position		Closed center	73
			Exhaust center	
			Pressure center	
4 position	Dual 3 port valve	69		
SJ3□60-M5	2 position	M5 x 0.8	Single	57
			Double	65
	3 position		Closed center	69
			Exhaust center	
			Pressure center	
4 position	Dual 3 port valve	65		

Note) Please contact SMC for the weight of elbow fittings.

Connector Wiring Diagram

For both serial and parallel wiring, additional valves are sequentially assigned pins on the connector. This makes it completely unnecessary to disassemble the connector unit.

Single solenoid and double solenoid

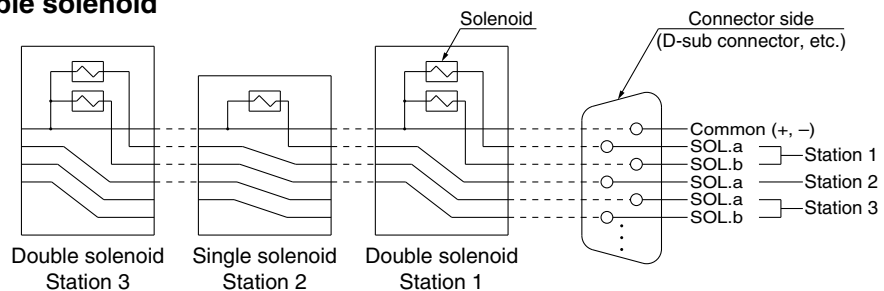

Single solenoid with double wiring spec.

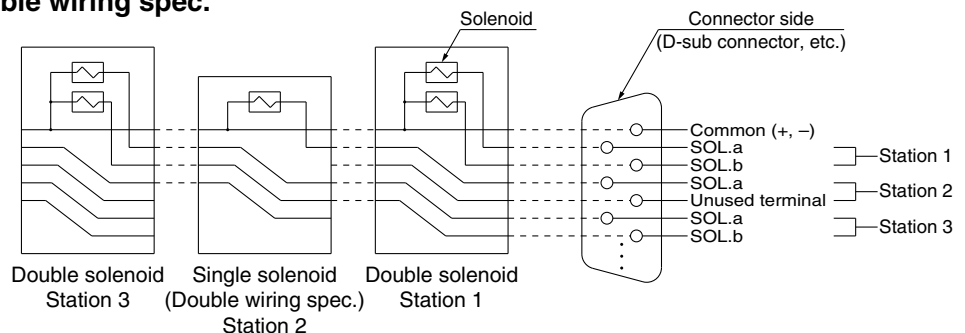

Mounting a valve with individual wiring

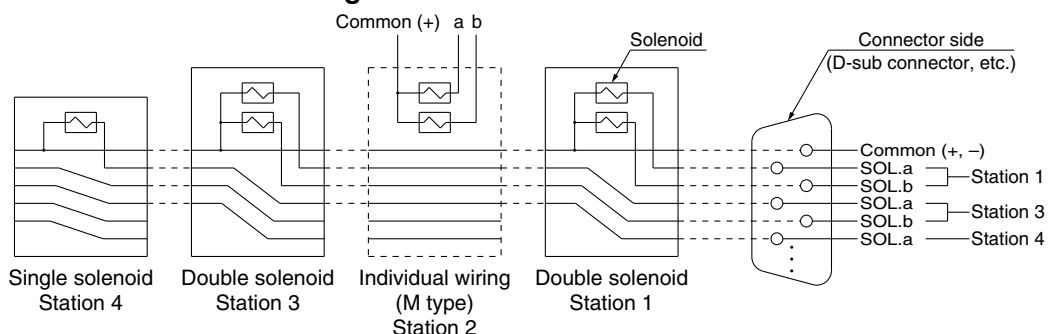

Series SJ2000/3000

Construction: SJ3000

JIS symbol

2 position single

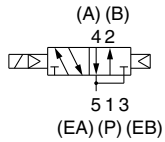

2 position single with back pressure check valve

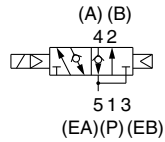

2 position double

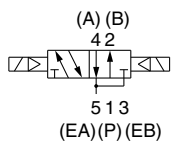

2 position double with back pressure check valve

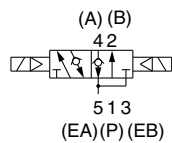

3 position closed center

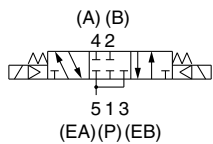

3 position exhaust center

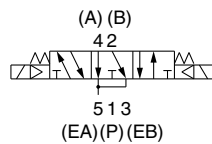

3 position pressure center

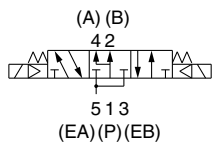

2 position single

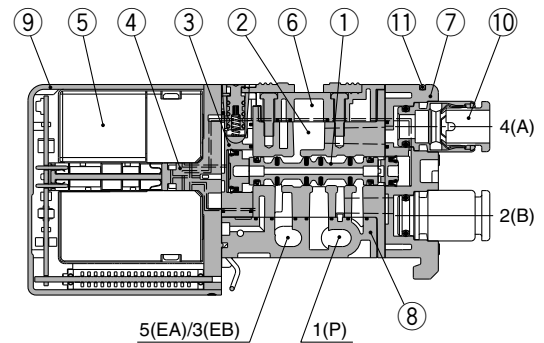

2 position double

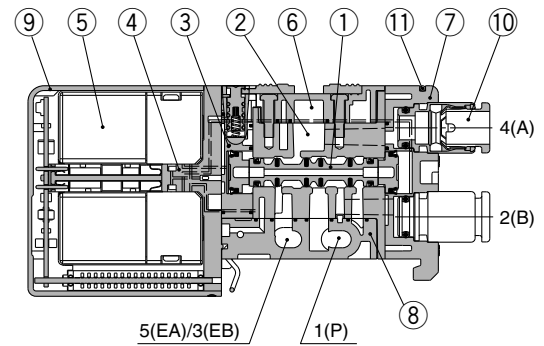

3 position closed center/exhaust center/pressure center

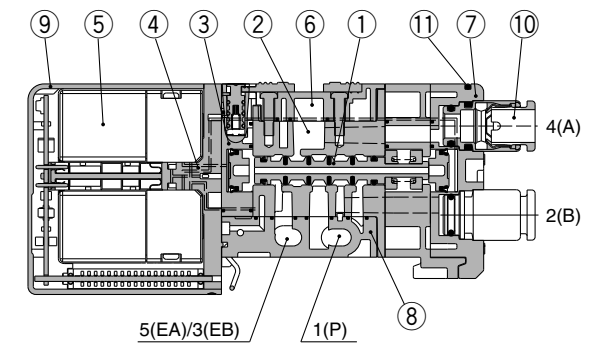

Component Parts

No.	Description	Material	Note
1	Spool valve assembly	Resin/H-NBR (3 position solenoid valve: Aluminum/H-NBR)	—
2	Body	Zinc die-cast	—
3	Adaptor plate	Resin	White
4	Pilot adaptor	Resin	White
5	Pilot valve assembly	—	—
6	Body cover	Resin	White
7	Port block	Resin	White
8	Bottom cover	Resin	White
9	Light cover	Resin	Light blue

Replacement Parts

No.	Description	Part no.
10	One-touch fitting	Refer to the one-touch fitting part no. on back page 6.
11	Clip	SJ3000-CL-1 (10 pcs.)

SJ3260K with back pressure check valve

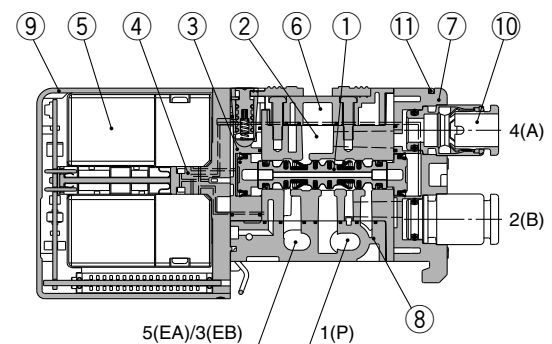

Construction: SJ3000

JIS symbol

4 position dual 3 port valve
SJ3A60 [N.C. valve x 2]

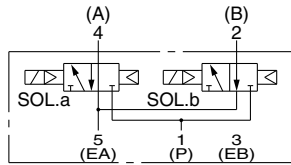

SJ3A60K with back pressure check valve

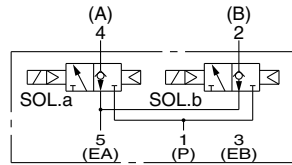

SJ3A60 [N.C. valve x 2]

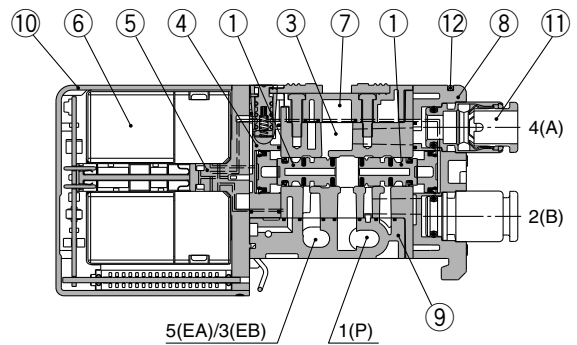

SJ3B60 [N.O. valve x 2]

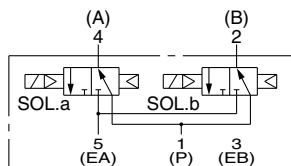

SJ3B60K with back pressure check valve

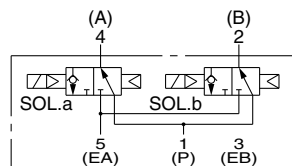

SJ3B60 [N.O. valve x 2]

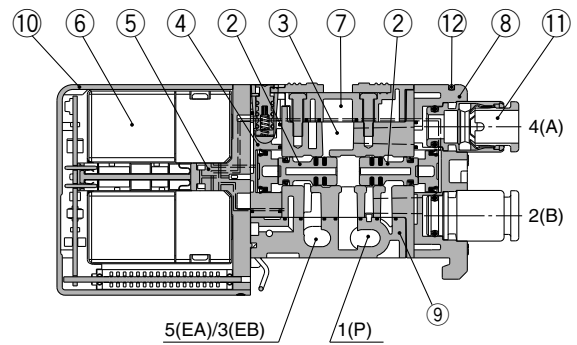

SJ3C60 [N.C., N.O. valve x 1 (each)]

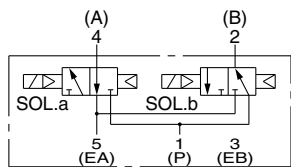

SJ3C60K with back pressure check valve

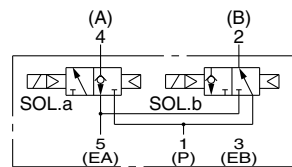

SJ3C60 [N.C. valve, N.O. valve x 1 (each)]

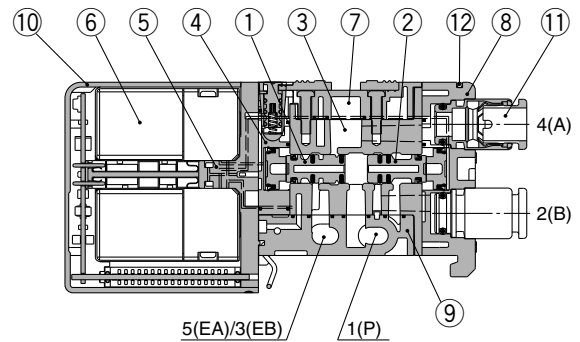

Component Parts

No.	Description	Material	Note
1	Spool valve assembly	Resin/H-NBR	N.C. (Normally closed)
2	Spool valve assembly	Resin/H-NBR	N.O. (Normally open)
3	Body	Zinc die-cast	—
4	Adaptor plate	Resin	White
5	Pilot adaptor	Resin	White
6	Pilot valve assembly	—	—
7	Body cover	Resin	White
8	Port block	Resin	White
9	Bottom cover	Resin	White
10	Light cover	Resin	Light blue

Replacement Parts

No.	Description	Part no.
11	One-touch fitting	Refer to the one-touch fitting part no. on back page 6.
12	Clip	SJ3000-CL-1 (10 pcs.)

SJ3A60K with back pressure check valve

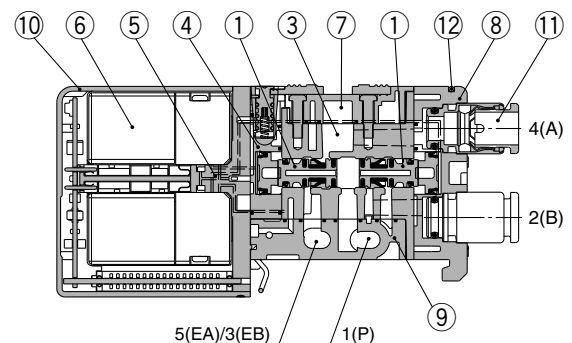

How to Order Solenoid Valves

Standard

With switch

Individual wiring
 [For plug-in mixed mounting] Note 1)

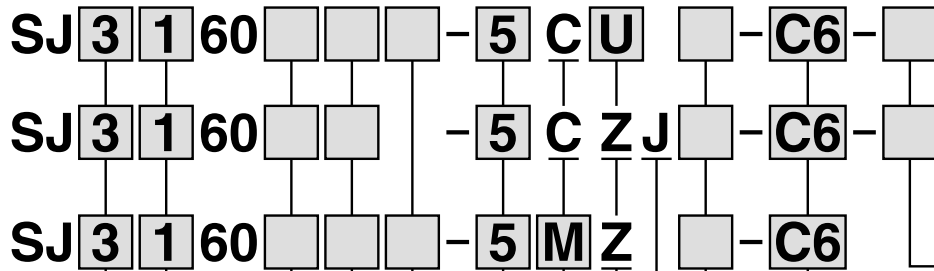

Note) Refer to pages 52 and 53 for the dedicated non-plug-in individual wiring.

Series

2	SJ2000
3	SJ3000

Back pressure check valve

Nil	None
K	Built-in

* Back pressure check valve is not applicable for 3 position valve.

Pilot spec.

Nil	Internal pilot
R	External pilot

* External pilot spec. is not applicable for 4 position dual 3 port valves.

Type of actuation

1	2 position single solenoid
2	2 position double solenoid
3	3 position closed center
4	3 position exhaust center
5	3 position pressure center
A	Dual 3 port valve: N.C./N.C.
B	Dual 3 port valve: N.O./N.O.
C	Dual 3 port valve: N.C./N.O.

* Refer to pages 4 through to 7 for the JIS symbol.

Coil spec.

Nil	Standard
T	With power saving circuit (Continuous duty type)

* Be sure to select "with power saving circuit" when the solenoid valve will be energized continuously for long period.

Rated voltage

5	24 VDC
6	12 VDC

Single solenoid wiring spec.

Nil	Single wiring
D	Double wiring

* There is no need to enter anything for 2 position double, 3 position and 4 position solenoid valves. Select this when the unused numbers to wiring are set. Refer to page 3 for details.

A, B port size

Straight (Metric size)
C2: ø2 one-touch fitting
C4: ø4 one-touch fitting
C6: ø6 one-touch fitting (SJ3000 only)

(Inch size)
N1: ø1/8" one-touch fitting
N3: ø5/32" one-touch fitting
N7: ø1/4" one-touch fitting (SJ3000 only)

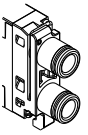

M3: M3 x 0.5 (SJ2000 only)
M5: M5 x 0.8 (SJ3000 only)

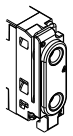

Elbow fitting assembly (Upward entry) (Metric size)
L2: ø2 elbow fitting assembly
L4: ø4 elbow fitting assembly
L6: ø6 elbow fitting assembly (SJ3000 only)

(Inch size)
LN1: ø1/8" elbow fitting assembly
LN3: ø5/32" elbow fitting assembly
LN7: ø1/4" elbow fitting assembly (SJ3000 only)

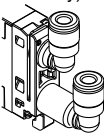

Elbow fitting assembly (Downward entry) (Metric size)
B2: ø2 elbow fitting assembly
B4: ø4 elbow fitting assembly
B6: ø6 elbow fitting assembly (SJ3000 only)

(Inch size)
BN1: ø1/8" elbow fitting assembly
BN3: ø5/32" elbow fitting assembly
BN7: ø1/4" elbow fitting assembly (SJ3000 only)

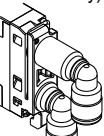

Note 2) The electrical connection to the manifold will be +COM. spec. when light/surge voltage suppressor is "Z" (Polar type).

Connector entry

C: Dedicated for centralized wiring

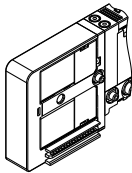

M: Individual wiring, With lead wire
 Length 300 mm

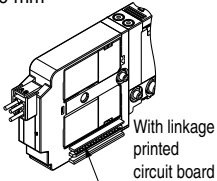

MN: Individual wiring, Without lead wire
 (With connector, socket)

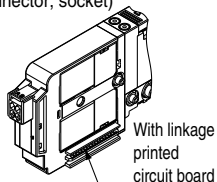

MO: Individual wiring, Without connector

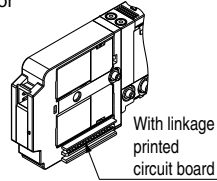

Light/surge voltage suppressor

U	With light/surge voltage suppressor (Non-polar type)
Z	With light/surge voltage suppressor (Polar type)

* When the types with power saving circuit, with switches, and individual wiring are used, the non-polar type cannot be selected.
 * "Z" is +COM. spec.

With switch

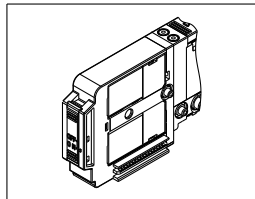

Manual override

Nil: Non-locking push type

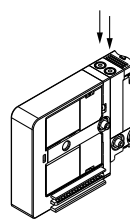

D: Push-turn locking slotted type

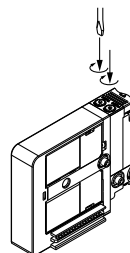

* Connector entries with the symbol "M□" can not use the switch signal from the common wiring on the manifold. For details, refer to "Connector Wiring Diagram" on page 3.
 * When ordering a connector assembly separately, refer to back page 8.

How to Order Solenoid Valves

Standard

With switch

Individual wiring
 [For plug-in mixed mounting] Note 1)

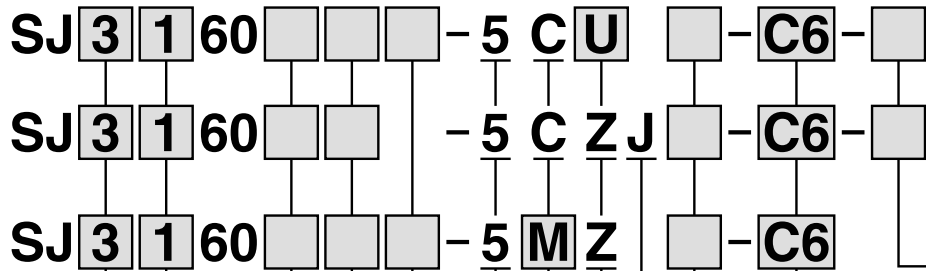

Note) Refer to pages 52 and 53 for the dedicated non-plug-in individual wiring.

Series

2	SJ2000
3	SJ3000

Back pressure check valve

Nil	None
K	Built-in

* Back pressure check valve is not applicable for 3 position valve.

Pilot spec.

Nil	Internal pilot
R	External pilot

* External pilot spec. is not applicable for 4 position dual 3 port valves.

Coil spec.

Nil	Standard
T	With power saving circuit (Continuous duty type)

* Be sure to select "with power saving circuit" when the solenoid valve will be energized continuously for long period.

Rated voltage

5	24 VDC
---	--------

Type of actuation

1	2 position single solenoid
2	2 position double solenoid
3	3 position closed center
4	3 position exhaust center
5	3 position pressure center
A	Dual 3 port valve: N.C./N.C.
B	Dual 3 port valve: N.O./N.O.
C	Dual 3 port valve: N.C./N.O.

* Refer to pages 4 through to 7 for the JIS symbol.

Single solenoid wiring spec.

Nil	Single wiring
D	Double wiring

* There is no need to enter anything for 2 position double, 3 position and 4 position solenoid valves. Select this when the unused numbers to wiring are set. Refer to page 3 for details.

Connector entry

C: Dedicated for centralized wiring

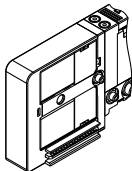

M: Individual wiring, With lead wire
Length 300 mm

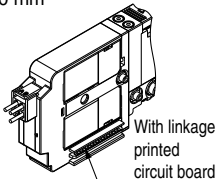

MN: Individual wiring, Without lead wire
(With connector, socket)

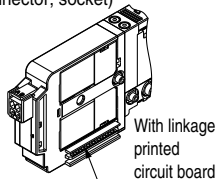

MO: Individual wiring, Without connector

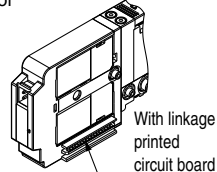

Light/surge voltage suppressor

U	With light/surge voltage suppressor (Non-polar type)
Z	With light/surge voltage suppressor (Polar type)

* When the types with power saving circuit, with switches, and/or individual wiring are used, the non-polar type cannot be selected.
 * "Z" is +COM. spec.

With switch

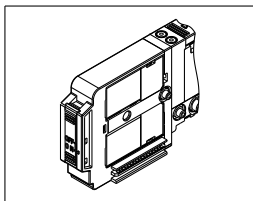

Manual override

Nil: Non-locking push type

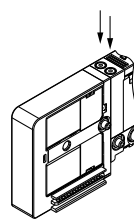

D: Push-turn locking slotted type

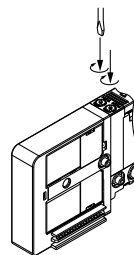

* Connector entries with the symbol "M□" can not use the switch signal from the common wiring on the manifold. For details, refer to "Connector Wiring Diagram" on page 3.
 * When ordering a connector assembly separately, refer to back page 8.

A, B port size

Straight (Metric size)

C2: ø2 one-touch fitting

C4: ø4 one-touch fitting

C6: ø6 one-touch fitting (SJ3000 only)

(Inch size)

N1: ø1/8" one-touch fitting

N3: ø5/32" one-touch fitting

N7: ø1/4" one-touch fitting (SJ3000 only)

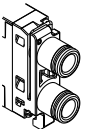

M3: M3 x 0.5 (SJ2000 only)

M5: M5 x 0.8 (SJ3000 only)

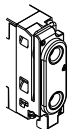

Elbow fitting assembly (Upward entry) (Metric size)

L2: ø2 elbow fitting assembly

L4: ø4 elbow fitting assembly

L6: ø6 elbow fitting assembly (SJ3000 only)

(Inch size)

LN1: ø1/8" elbow fitting assembly

LN3: ø5/32" elbow fitting assembly

LN7: ø1/4" elbow fitting assembly (SJ3000 only)

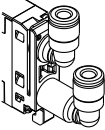

Elbow fitting assembly (Downward entry) (Metric size)

B2: ø2 elbow fitting assembly

B4: ø4 elbow fitting assembly

B6: ø6 elbow fitting assembly (SJ3000 only)

(Inch size)

BN1: ø1/8" elbow fitting assembly

BN3: ø5/32" elbow fitting assembly

BN7: ø1/4" elbow fitting assembly (SJ3000 only)

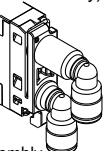

Note 2) The electrical connection to the manifold will be +COM. spec. when light/surge voltage suppressor is "Z" (Polar type).

How to Order Solenoid Valves

Standard

SJ 3 1 60 [] [] [] - 5 C U [] - C6 - []

With switch

SJ 3 1 60 [] [] [] - 5 C Z J [] - C6 - []

Individual wiring
[For plug-in mixed mounting] ^{Note 1)}

SJ 3 1 60 [] [] [] - 5 M Z [] - C6

Note) Refer to pages 52 and 53 for the dedicated non-plug-in individual wiring.

Series

2	SJ2000
3	SJ3000

Back pressure check valve

Nil	None
K	Built-in

Pilot spec.

Nil	Internal pilot
R	External pilot

* Back pressure check valve is not applicable for 3 position valve.

* External pilot spec. is not applicable for 4 position dual 3 port valves.

Type of actuation

1	2 position single solenoid
2	2 position double solenoid
3	3 position closed center
4	3 position exhaust center
5	3 position pressure center
A	Dual 3 port valve: N.C./N.C.
B	Dual 3 port valve: N.O./N.O.
C	Dual 3 port valve: N.C./N.O.

* Refer to pages 4 through to 7 for the JIS symbol.

Coil spec.

Nil	Standard
T	With power saving circuit (Continuous duty type)

* Be sure to select "with power saving circuit" when the solenoid valve will be energized continuously for long period.

Rated voltage

5	24 VDC
---	--------

Single solenoid wiring spec.

Nil	Single wiring
D	Double wiring

* There is no need to enter anything for 2 position double, 3 position and 4 position solenoid valves. Select this when the unused numbers to wiring are set. Refer to page 3 for details.

A, B port size

Straight (Metric size)

C2: ø2 one-touch fitting
C4: ø4 one-touch fitting
C6: ø6 one-touch fitting (SJ3000 only)

(Inch size)

N1: ø1/8" one-touch fitting
N3: ø5/32" one-touch fitting
N7: ø1/4" one-touch fitting (SJ3000 only)

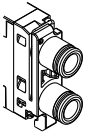

M3: M3 x 0.5 (SJ2000 only)
M5: M5 x 0.8 (SJ3000 only)

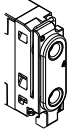

Elbow fitting assembly (Upward entry) (Metric size)

L2: ø2 elbow fitting assembly
L4: ø4 elbow fitting assembly
L6: ø6 elbow fitting assembly (SJ3000 only)

(Inch size)

LN1: ø1/8" elbow fitting assembly
LN3: ø5/32" elbow fitting assembly
LN7: ø1/4" elbow fitting assembly (SJ3000 only)

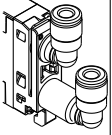

Elbow fitting assembly (Downward entry) (Metric size)

B2: ø2 elbow fitting assembly
B4: ø4 elbow fitting assembly
B6: ø6 elbow fitting assembly (SJ3000 only)

(Inch size)

BN1: ø1/8" elbow fitting assembly
BN3: ø5/32" elbow fitting assembly
BN7: ø1/4" elbow fitting assembly (SJ3000 only)

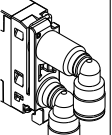

Note 2) The electrical connection to the manifold will be +COM. spec. when light/surge voltage suppressor is "Z" (Polar type).

Connector entry

C: Dedicated for centralized wiring

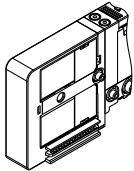

M: Individual wiring, With lead wire
Length 300 mm

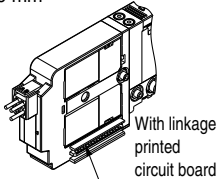

MN: Individual wiring, Without lead wire
(With connector, socket)

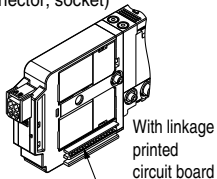

MO: Individual wiring, Without connector

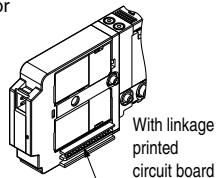

Light/surge voltage suppressor

U	With light/surge voltage suppressor (Non-polar type)
Z	With light/surge voltage suppressor (Polar type)

* When the types with power saving circuit, with switches, and/or individual wiring are used, the non-polar type cannot be selected.
* "Z" is +COM. spec.

With switch

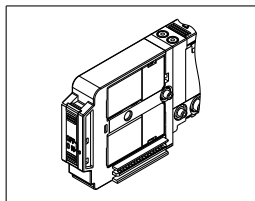

Manual override

Nil: Non-locking push type

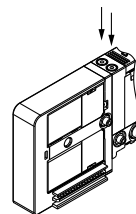

D: Push-turn locking slotted type

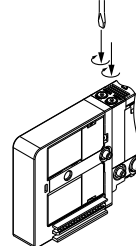

* Connector entries with the symbol "M□" can not use the switch signal from the common wiring on the manifold. For details, refer to "Connector Wiring Diagram" on page 3.
* When ordering a connector assembly separately, refer to back page 8.

How to Order Solenoid Valves

Standard

SJ 3 1 60 [] [] [] - 5 C U [] - C6 - []

With switch

SJ 3 1 60 [] [] [] - 5 C Z J [] - C6 - []

Individual wiring
 [For plug-in mixed mounting] ^{Note 1)}

SJ 3 1 60 [] [] [] - 5 M Z [] - C6

Note) Refer to pages 52 and 53 for the dedicated non-plug-in individual wiring.

Series

2	SJ2000
3	SJ3000

Back pressure check valve

Nil	None
K	Built-in

* Back pressure check valve is not applicable for 3 position valve.

Pilot spec.

Nil	Internal pilot
R	External pilot

* External pilot spec. is not applicable for 4 position dual 3 port valves.

Coil spec.

Nil	Standard
T	With power saving circuit (Continuous duty type)

* Be sure to select "with power saving circuit" when the solenoid valve will be energized continuously for long period.

Rated voltage

5	24 VDC
---	--------

Type of actuation

1	2 position single solenoid
2	2 position double solenoid
3	3 position closed center
4	3 position exhaust center
5	3 position pressure center
A	Dual 3 port valve: N.C./N.C.
B	Dual 3 port valve: N.O./N.O.
C	Dual 3 port valve: N.C./N.O.

* Refer to pages 4 through to 7 for the JIS symbol.

Single solenoid wiring spec.

Nil	Single wiring
D	Double wiring

* There is no need to enter anything for 2 position double, 3 position and 4 position solenoid valves. Select this when the unused numbers to wiring are set. Refer to page 3 for details.

A, B port size

Straight (Metric size)
C2: ø2 one-touch fitting
C4: ø4 one-touch fitting
C6: ø6 one-touch fitting (SJ3000 only)
 (Inch size)
N1: ø1/8" one-touch fitting
N3: ø5/32" one-touch fitting
N7: ø1/4" one-touch fitting (SJ3000 only)

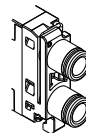

M3: M3 x 0.5 (SJ2000 only)
M5: M5 x 0.8 (SJ3000 only)

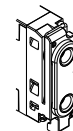

Elbow fitting assembly (Upward entry) (Metric size)

L2: ø2 elbow fitting assembly
L4: ø4 elbow fitting assembly
L6: ø6 elbow fitting assembly (SJ3000 only)
 (Inch size)
LN1: ø1/8" elbow fitting assembly
LN3: ø5/32" elbow fitting assembly
LN7: ø1/4" elbow fitting assembly (SJ3000 only)

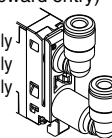

Elbow fitting assembly (Downward entry) (Metric size)

B2: ø2 elbow fitting assembly
B4: ø4 elbow fitting assembly
B6: ø6 elbow fitting assembly (SJ3000 only)
 (Inch size)
BN1: ø1/8" elbow fitting assembly
BN3: ø5/32" elbow fitting assembly
BN7: ø1/4" elbow fitting assembly (SJ3000 only)

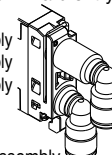

Note 2) The electrical connection to the manifold will be +COM. spec. when light/surge voltage suppressor is "Z" (Polar type).

Connector entry

C: Dedicated for centralized wiring

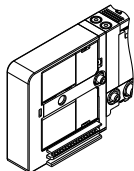

M: Individual wiring, With lead wire Length 300 mm

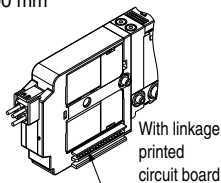

MN: Individual wiring, Without lead wire

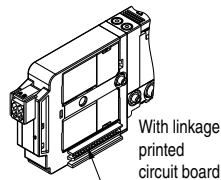

MO: Individual wiring, Without connector

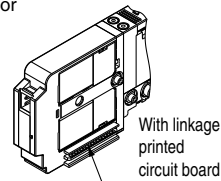

Light/surge voltage suppressor

U	With light/surge voltage suppressor (Non-polar type)
Z	With light/surge voltage suppressor (Polar type)

* When the types with power saving circuit, with switches, and individual wiring are used, the non-polar type cannot be selected.
 * "Z" is +COM. spec.
 * When -COM of SI unit common specifications is used, select the non-polar type.

With switch

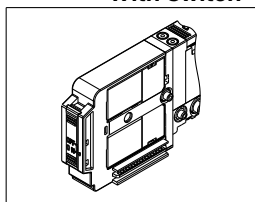

Manual override

Nil: Non-locking push type

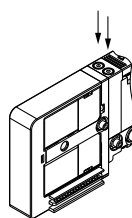

D: Push-turn locking slotted type

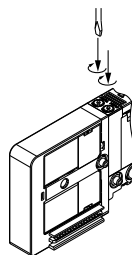

* Connector entries with the symbol "M□" can not use the switch signal from the common wiring on the manifold. For details, refer to "Connector Wiring Diagram" on page 3.
 * When ordering a connector assembly separately, refer to back page 8.

How to Order Solenoid Valves

SJ 3 1 60 [] [] [] N-5 M Z [] - C6

Series

2	SJ2000
3	SJ3000

Type of actuation

1	2 position single solenoid
2	2 position double solenoid
3	3 position closed center
4	3 position exhaust center
5	3 position pressure center
A	Dual 3 port valve: N.C./N.C.
B	Dual 3 port valve: N.O./N.O.
C	Dual 3 port valve: N.C./N.O.

* Refer to pages 4 through to 7 for the JIS symbol.

Pilot spec.

Nil	Internal pilot
R	External pilot

* External pilot spec. is not applicable for 4 position dual 3 port valves.

Back pressure check valve

Nil	None
K	Built-in

* Back pressure check valve is not applicable for 3 position valve.

Coil spec.

Nil	Standard
T	With power saving circuit (Continuous duty type)

* Be sure to select "with power saving circuit" when the solenoid valve will be energized continuously for long period.

Non-plug-in

Rated voltage

5	24 VDC
6	12 VDC

A, B port size

Straight
(Metric size)
C2: ø2 one-touch fitting
C4: ø4 one-touch fitting
C6: ø6 one-touch fitting (SJ3000 only)

(Inch size)
N1: ø1/8" one-touch fitting
N3: ø5/32" one-touch fitting
N7: ø1/4" one-touch fitting (SJ3000 only)

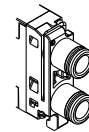

M3: M3 x 0.5 (SJ2000 only)
M5: M5 x 0.8 (SJ3000 only)

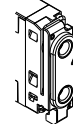

Elbow fitting assembly (Upward entry)
(Metric size)
L2: ø2 elbow fitting assembly
L4: ø4 elbow fitting assembly
L6: ø6 elbow fitting assembly (SJ3000 only)

(Inch size)
LN1: ø1/8" elbow fitting assembly
LN3: ø5/32" elbow fitting assembly
LN7: ø1/4" elbow fitting assembly (SJ3000 only)

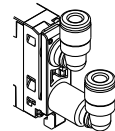

With light/surge voltage suppressor ^{Note)}

Manual override

Nil: Non-locking push type

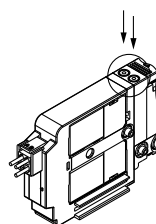

D: Push-turn locking slotted type

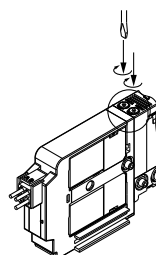

Elbow fitting assembly (Downward entry)
(Metric size)
B2: ø2 elbow fitting assembly
B4: ø4 elbow fitting assembly
B6: ø6 elbow fitting assembly (SJ3000 only)

(Inch size)
BN1: ø1/8" elbow fitting assembly
BN3: ø5/32" elbow fitting assembly
BN7: ø1/4" elbow fitting assembly (SJ3000 only)

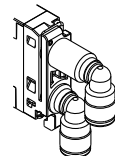

Connector entry

M: Individual wiring, With lead wire
Length 300 mm

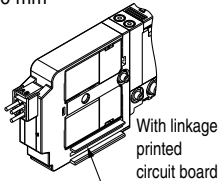

MN: Individual wiring, Without lead wire
(With connector, socket)

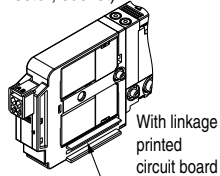

MO: Individual wiring, Without connector

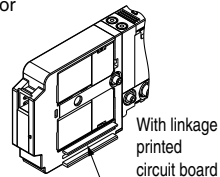

* When ordering a connector assembly separately, refer to back page 8.



Note) The electrical connection to the manifold will be +COM.