

Pneumatic Clean Series

● Directional Control Valves

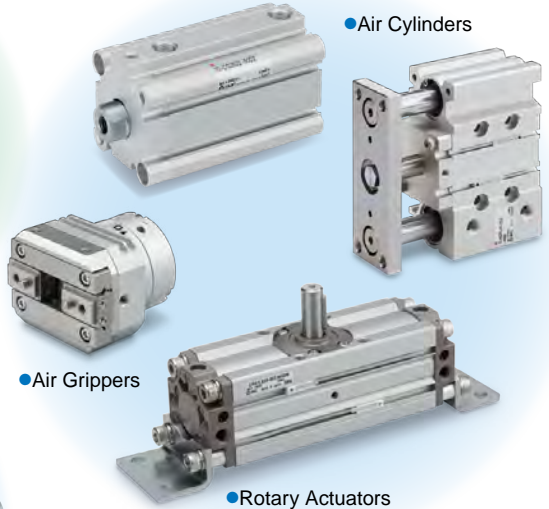

● Air Cylinders



● Air Grippers



● Air Preparation Equipment

● Fittings & Tubing



● Flow Control Equipment



● Pressure Control Equipment
● Modular F.R.

● Pressure Switches/
Pressure Sensors



CAT.E02-23B

SMC Pneumatic Clean Room Equipment

Clean Series **Series 10-/11-/12-/13-**

**Suitable for clean environment.
Prevents particle generation in clean room.**

Applicable equipment

Actuators (Cylinders, Rotary actuators, Air grippers), Directional control equipment, Flow control equipment, Filters, Pressure control equipment, Fittings/Tubing, Air preparation equipment, Pressure switches
Note) The 11-, 12-, and 13- series are only applicable to actuators.

Special Clean Series

**Adheres to an even higher standard of cleanliness than the Clean Series.
The development of this line of products, from structure and materials to assembly environment, are all determined for clean environment use.**

Applicable equipment

Clean rodless cylinders, Clean regulators, Clean One-touch fittings, Clean tubing, Clean gas filters, Clean air filters

Copper, Fluorine, Silicone-free, Low-particle Generation **Series 21-/22-**

Suitable for environments where the presence of copper, fluorine or silicone materials is restricted.

Structures are identical to the Clean Series. (Grease and packaging are different from the Clean Series.)

Applicable equipment

Actuators (Cylinders, Rotary actuators, Air grippers), Directional control valves, Flow control equipment, Pressure control equipment, Fittings

Note) The 22- series is only applicable to actuators.



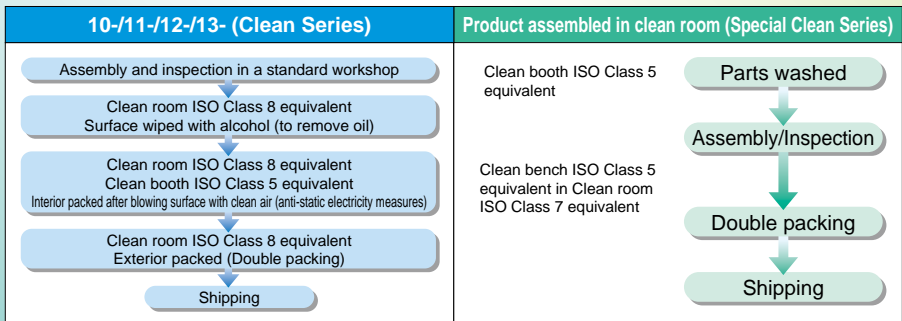

Dust is kept from the clean room.

- After inspection, the product is blown with high purity air (of ISO Class 5 equivalent clean bench) in a clean environment.
- Products are sealed and shipped in antistatic double bags.





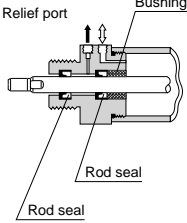
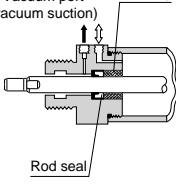

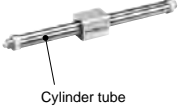
The 21- and 22- series are given standard packaging (assembly, inspection, packing, and shipping carried out in a standard workshop.) Please contact SMC for clean packaging.

Basic Specifications of Actuators



	Series 10-	Series 11-	Series 12-	
Construction	<ul style="list-style-type: none"> • Double seal type/ release to atmosphere 	<ul style="list-style-type: none"> • Single seal type/ vacuum suction 	<ul style="list-style-type: none"> • Compact guide cylinder P.839 • Dual rod cylinder From P.848 <p>Double seal type/release to atmosphere (10- series equivalent) and specially treated guide</p> 	<ul style="list-style-type: none"> • Rodless cylinder From P.767 <p>Specially treated cylinder tube exterior</p> 
Restricted material	None			
Grease	Fluorine grease			
Assembly environment	General environments (assembly and inspection in a workshop)			
Packaging	Clean packaging: Products are sealed in antistatic double bags after			

Basic Specifications of Other Equipment

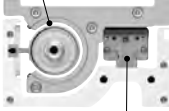
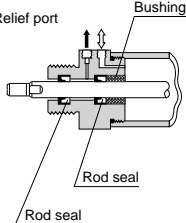
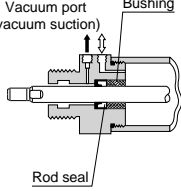
	Series 10-	Special		
Construction	<ul style="list-style-type: none"> • Directional control valve P.36  <p>Main valve and pilot valve common exhaust</p> <p>Fittings, speed controllers, pressure switches, etc. have the same structure as those of standard.</p>	<ul style="list-style-type: none"> • Compressed air cleaning filter series P.958 • Modular F.R. P.1068  <p>Drain guide With female thread</p> <p>Relief port With fitting in bleed port</p>	<ul style="list-style-type: none"> • Clean regulator P.1114 <p>All wetted parts are made of stainless steel, FPM and PTFE, and exterior metal parts are made of anodized aluminum, which provides high corrosion resistance.</p> 	<ul style="list-style-type: none"> • Clean One-touch fittings (for blowing) P.1221  <p>Wetted parts non-metal</p> <p>Polypropylene resin</p> <ul style="list-style-type: none"> • Clean tubing Polyolefin-based resin P.1235
Restricted material	None			
Grease	Fluorine grease	—	—	
Assembly environment	General environments (assembly and inspection in a workshop)			Parts are
Packaging	Clean packaging: Products are sealed in antistatic double bags			

Series 13-	Special Clean Series	Series 21-	Series 22-
<ul style="list-style-type: none"> • Compact guide cylinder P.839 • Air slide table From P.778 <p>Single seal type/ vacuum suction (11- series equivalent) and specially treated guide</p>  <p>Ball bushing guide Linear guide</p>	<ul style="list-style-type: none"> • Clean rodless cylinder P.773 <p>No contact between the cylinder tube exterior and the slider interior</p>  <p>Linear guide Special treatment</p>	<ul style="list-style-type: none"> • Double seal type/ release to atmosphere  <p>Relief port Bushing Rod seal Rod seal</p>	<ul style="list-style-type: none"> • Single seal type/ vacuum suction  <p>Vacuum port (vacuum suction) Bushing Rod seal</p>
	None	Copper, fluorine and silicone-free	
	Fluorine grease	Lithium soap based grease	
	Parts are washed and assembled in a clean room.	General environments (assembly and inspection in a workshop)	
blow to the surface with clean air.		Standard packaging ^(Note)	

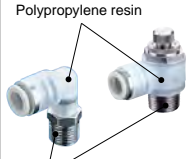
(Note) Please contact SMC for clean packaging.

Clean Series		Series 21-
<ul style="list-style-type: none"> • Clean One-touch fittings (for driving air piping) P.1225 • Clean speed controller P.1291 <p>Polypropylene resin</p>  <p>Metal parts Brass (Electroless nickel plated) or Stainless steel 304</p>	<ul style="list-style-type: none"> • Exhaust cleaner for clean room P.1055 • Clean gas filter From P.1011 • Clean air filter Polyolefin hollow fiber membrane element From P.1031 • Clean exhaust filter P.1060 • Clean air module P.1039 	<ul style="list-style-type: none"> • Directional control valve P.36 • Modular F.R. P.1068 <p>The same construction as the 10- series</p> <ul style="list-style-type: none"> • Clean One-touch fittings (for driving air piping) P.1225 • Clean speed controller P.1291 <p>No sealant on thread parts</p> <p>* UNI thread is also applicable. (Made to Order)</p>
None		Copper, fluorine and silicone-free
Fluorine grease	—	Lithium soap based grease
washed and assembled in a clean room.		General environments (assembly and inspection in a workshop) Parts are washed and assembled in a clean room.
after blow to the surface with clean air.		Standard packaging ^(Note)

(Note) Please contact SMC for clean packaging.

Clean Series INDEX

Directional Control Valves

4/5 Port Solenoid Valves

5 Port Solenoid Valve

P.38



Series	Flow rate characteristics C[dm ³ /(s·bar)]	Cylinder size (ø)
10-SY3000/5000 7000/9000	1.1 to 10	40 to 100

5 Port Solenoid Valve

P.179



Series	Flow rate characteristics C[dm ³ /(s·bar)]	Cylinder size (ø)
10-SV1000/2000 3000/4000	1.1 to 10	40 to 100

4/5 Port Solenoid Valve

P.279



Series	Flow rate characteristics C[dm ³ /(s·bar)]	Cylinder size (ø)
10-SYJ3000/5000 7000	0.46 to 2.9	25 to 50

5 Port Solenoid Valve

P.377



Series	Flow rate characteristics C[dm ³ /(s·bar)]	Cylinder size (ø)
10-SZ3000	0.77	32

5 Port Solenoid Valve

P.417



Series	Flow rate characteristics C[dm ³ /(s·bar)]	Cylinder size (ø)
10-S0700	0.34 to 0.39	25

5 Port Solenoid Valve

P.514



Series	Flow rate characteristics C[dm ³ /(s·bar)]	Cylinder size (ø)
10-VQ1000/2000	1.0 to 3.2	40 to 63

5 Port Solenoid Valve

P.578



Series	Flow rate characteristics C[dm ³ /(s·bar)]	Cylinder size (ø)
10-SQ1000/2000	0.83 to 2.9	32 to 63

4 Port Direct Operated Poppet Solenoid Valve

P.597



Series	Flow rate characteristics C[dm ³ /(s·bar)]	Cylinder size (ø)
10-VQD1000	0.19	25

3 Port Solenoid Valves

3 Port Solenoid Valve

P.602



Series	Flow rate characteristics
	C[dm ³ /(s·bar)]
10-SYJ3000/500/700	0.36 to 3.0

3 Port Solenoid Valve

P.648



Series	Flow rate characteristics
	C[dm ³ /(s·bar)]
10-SY100	0.14 to 0.22*

* Effective area

3 Port Solenoid Valve

P.658



Series	Flow rate characteristics C[dm ³ /(s·bar)]
10-S070	0.021 to 0.060

Air Cylinders

Air Cylinder

P.685



Type	Series	Bore size (mm)
Standard	¹⁰⁻¹¹⁻²¹⁻²² : CJ2	6
	¹⁰⁻¹¹⁻²¹⁻²² : CJ2-Z	
Direct mount	¹⁰⁻¹¹⁻²¹⁻²² : CJ2W-Z	10, 16
	¹⁰⁻¹¹⁻²¹⁻²² : CJ2RA-Z	

Air Cylinder

P.700



Type	Series	Bore size (mm)
Standard	¹⁰⁻¹¹⁻²¹⁻²² : CM2-Z	20, 25
	¹⁰⁻¹¹⁻²¹⁻²² : CM2W-Z	
Direct mount	¹⁰⁻¹¹⁻²¹⁻²² : CM2R-Z	32, 40
End lock	¹⁰⁻¹¹⁻²¹⁻²² : CBM2	

Air Cylinder

P.722



Type	Series	Bore size (mm)
Standard	¹⁰⁻¹¹⁻²¹⁻²² : CG1-Z	20, 25, 32, 40
	¹⁰⁻¹¹⁻²¹⁻²² : CG1W-Z	
Direct mount	¹⁰⁻¹¹⁻²¹⁻²² : CG1R-Z	20, 25, 32
	¹⁰⁻¹¹⁻²¹⁻²² : CG1R-Z	

Air Cylinder

P.736



Series	Bore size (mm)
¹⁰⁻¹¹⁻²¹⁻²² : CA2	40, 50, 63

Mini Free Mount Cylinder

P.740



Series	Bore size (mm)
¹⁰⁻¹¹⁻²¹⁻²² : CUJ	6, 8, 10

Free Mount Cylinder

P.746



Series	Bore size (mm)
¹⁰⁻¹¹⁻²¹⁻²² : CDU	6, 10, 16, 20, 25

Compact Cylinder: Compact Type

P.749



Series	Bore size (mm)
¹⁰⁻¹¹⁻²¹⁻²² : CQS	12, 16, 20, 25

Compact Cylinder

P.758



Series	Bore size (mm)
¹⁰⁻¹¹⁻²¹⁻²² : CQ2-Z	12, 16, 20, 25, 32, 40, 50, 63, 80, 100

Magnetically Coupled Rodless Cylinder: Basic Type

P.767



Series	Bore size (mm)
¹⁰⁻¹¹⁻²¹⁻²² : 12-CY3B	6, 10, 15, 20, 25, 32, 40, 50, 63

Magnetically Coupled Rodless Cylinder: Direct Mount Type

P.769



Series	Bore size (mm)
¹⁰⁻¹¹⁻²¹⁻²² : 12-CY3R	6, 10, 15, 20, 25, 32, 40, 50, 63

Clean Rodless Cylinder

P.773



Series	Bore size (mm)
¹⁰⁻¹¹⁻²¹⁻²² : CYP	15, 32

Air Slide Table

P.778



Series	Bore size (mm)
¹³⁻²² : MXS	6, 8, 12, 16, 20, 25

Clean Series INDEX

Air Cylinders

Air Slide Table

P.799



Series	Bore size (mm)
¹² / ₁₃ -MXQ	6, 8, 12, 16, 20, 25

Air Slide Table

P.825



Series	Bore size (mm)
11-MXJ	4, 6, 8

Air Slide Table

P.831



Series	Bore size (mm)
¹¹ / ₂₂ -MXP	6, 10, 12, 16
¹¹ / ₂₂ -MXPJ6	6

Compact Guide Cylinder

P.839



Series	Bore size (mm)
¹² / ₁₃ -MGPL-Z	12, 16, 20, 25, 32, 40, 50, 63

Guide Table Cylinder

P.844



Series	Bore size (mm)
10-MGF	40, 63, 100

Dual Rod Cylinder: Compact Type

P.848



Series	Bore size (mm)
¹¹ / ₁₁ - ¹² / ₂₂ -CXSJ	6, 10

Dual Rod Cylinder

P.852



Series	Bore size (mm)
¹⁰ / ₁₁ - ¹¹ / ₁₂ - ¹² / ₂₂ -CXS	6, 10, 15, 20, 25, 32

Sine Rodless Cylinder

P.861



Series	Bore size (mm)
12-REA	25, 32, 40, 50, 63

Sine Cylinder

P.864



Series	Bore size (mm)
¹⁰ / ₁₁ -REC	20, 25, 32, 40

Low Speed Cylinder

P.868



Series	Bore size (mm)
¹⁰ / ₁₁ -CM2X-Z	20, 25, 32, 40

Low Speed Cylinder

P.870



Series	Bore size (mm)
¹⁰ / ₁₁ -CQSX	12, 16, 20, 25

Low Speed Cylinder

P.872



Series	Bore size (mm)
¹⁰ / ₁₁ -CQ2X	32, 40, 50, 63

Rotary Actuators

Rotary Actuator

P.893



Type	Series	Bore size (mm)
Vane	$\frac{10}{21}$ -CRB1	10, 15, 20, 30

Rotary Actuator

P.905



Type	Series	Bore size (mm)
Rack & Pinion	11-CRA1-Z	30, 50

Rotary Table

P.909



Type	Series	Bore size (mm)
Rack & Pinion	$\frac{11}{22}$ -MSQ	1, 2, 3, 7, 10, 20, 30, 50

Air Grippers

2 Finger Air Gripper

P.923



Series	Bore size (mm)
$\frac{11}{22}$ -MHZ2	10, 16, 20, 25

2 Finger Parallel Type Wide Opening Air Gripper

P.927



Series	Bore size (mm)
$\frac{11}{22}$ -MHL2	10, 16, 20, 25, 32, 40

Rotary Actuated Air Gripper

P.932



Type	Series	Bore size (mm)
2 finger	$\frac{11}{22}$ -MHR2	10, 15, 20, 30

Rotary Actuated Air Gripper

P.938



Type	Series	Bore size (mm)
3 finger	$\frac{11}{22}$ -MHR3	10, 15

Air Preparation Equipment

Air Dryer

Membrane Air Dryer

P.949



Series	Port size
10-IDG□A	1/4 to 1/2
10-IDG	1/8 to 1/2

Compressed Air Cleaning Filter Series

Main Line Filter

P.959



Series	Port size
10-AFF	1/8 to 2

Mist Separator

P.966



Series	Port size
10-AM	1/8 to 2

Clean Series INDEX

Air Preparation Equipment

Compressed Air Cleaning Filter Series

Micro Mist Separator

P.973



Series	Port size
10-AMD	1/8 to 2

Micro Mist Separator with Pre-filter

P.980



Series	Port size
10-AMH	1/8 to 2

Super Mist Separator

P.987



Series	Port size
10-AME	1/8 to 2

Odor Removal Filter

P.994



Series	Port size
10-AMF	1/8 to 2

Clean Gas Filters/Air Filters

Clean Gas Filter: Cartridge Type

P.1011



Series	Port size
SFA100/200/300	1/4

Clean Gas Filter: Cartridge Type

P.1014



Series	Port size
SFB100	M5, 1/4
SFB200	1/4

Clean Gas Filter: Disposable Type

P.1018



Series	Port size
SFB300	1/4

Clean Gas Filter: Disposable Type

P.1021



Series	Port size
SFC100	1/4, 3/8

Clean Air Filter

P.1031



Series	Type
SFD100	Disposable (Non-replaceable element)
SFD200	Cartridge (Replaceable element)

Clean Air Module

P.1039



Series	Fluid
LLB3	Clean air, N ₂ gas <small>Note)</small>
LLB4	Clean air, N ₂ gas <small>Note)</small>

Note) Inlet air conditions: Equivalent to ISO 8573-1 and Quality Class 1.4.1-1.6.1

Clean Exhaust Cleaner/Filter

Exhaust Cleaner for Clean Room

P.1055



Series	Port size
AMP220 to 420	1/4 to 3/4

Clean Exhaust Filter

P.1060



Series	Port size
SFE	M5 x 0.8 to ø10

Modular F.R.

Air Filter

P.1069



Series	Port size
¹⁰ / ₂₁ : AF	1/8 to 1

Mist Separator

P.1071



Series	Port size
¹⁰ / ₂₁ : AFM	1/8 to 3/4

Micro Mist Separator

P.1073



Series	Port size
¹⁰ / ₂₁ : AFD	1/8 to 3/4

Regulator

P.1075



Series	Port size
¹⁰ / ₂₁ : AR/AR□K	1/8 to 1

Filter Regulator

P.1079



Series	Port size
¹⁰ / ₂₁ : AW/AW□K	1/8 to 1

Mist Separator Regulator

P.1083



Series	Port size
¹⁰ / ₂₁ : AWM	1/8 to 1/2

Micro Mist Separator Regulator

P.1083



Series	Port size
¹⁰ / ₂₁ : AWD	1/8 to 1/2

Pressure Control Equipment

Direct Operated Precision Regulator

P.1093



Series	Port size
¹⁰ / ₂₁ : ARP20(K) to 40(K)	1/8 to 1/2

Precision Regulator

P.1101



Series	Port size
10-IR1000/2000/3000	1/8 to 1/2

Vacuum Regulator

P.1106



Series	Port size		
	Metric	ø6, ø8	
10-IRV10	Inch	ø1/4", ø5/16"	
	Metric	ø6 to ø10	
10-IRV20	Inch	ø1/4" to ø3/8"	

Clean Regulator

P.1114



Series	Port size
SRH	1/8 to 1/2

Precision Clean Regulator

P.1118



Series	Port size
SRP	M5, 1/8

Clean Series INDEX

Fittings & Tubing

One-touch Fittings

P.1124



Series	Applicable tubing O.D.	Connection thread
10-KQ2	Metric ø2 to ø16	M, R, Rc Uni 1/8 to 1/2
	Inch ø1/8" to ø1/2"	UNF, NPT, M, R, Rc Uni 1/8 to 1/2

Insert Fittings

P.1190



Series	Applicable tubing O.D.	Connection thread
10-KF	ø4 to ø12	1/8 to 1/2

Miniature Fittings

P.1196

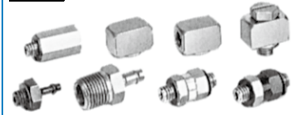

Series	Applicable tubing O.D.	Connection thread
10-M	ø3.2 to ø6	M3, M5, 1/8

Rectangular Multi-connector

P.1202



Series	Applicable tubing O.D.
10-KDM	ø3.2 to ø8

Stainless Steel One-touch Fittings

P.1206



Series	Applicable tubing O.D.	Connection thread
10-KG	ø4 to ø16	M5 to 1/2

Stainless Steel Miniature Fittings

P.1217



Series	Applicable tubing O.D.	Connection thread
10-MS	ø3.2 to ø6	M5

Clean One-touch Fittings

P.1221



Application	Series	Applicable tubing O.D.	Connection thread
For blowing	KP	ø4 to ø12	1/8 to 1/2

Clean One-touch Fittings

P.1225



Application	Series	Applicable tubing O.D.	Connection thread
For driving air piping	KPQ KPG	ø4 to ø12	M5 to 1/2

Polyurethane Tubing

P.1232



Series	Applicable tubing O.D.
10-TU	ø2 to ø12

Polyurethane Coil Tubing

P.1233



Series	Applicable tubing O.D.
10-TCU	ø4 to ø8

Polyurethane Flat Tubing

P.1234



Series	Applicable tubing O.D.
10-TFU	ø4 to ø8

Clean Tubing

P.1235



Type	Series	Applicable tubing O.D.
Polyolefin	TPH	ø4 to ø12

Clean Tubing

P.1236



Type	Series	Applicable tubing O.D.
Soft polyolefin	TPS	ø4 to ø12

Flow Control Equipment

Push-lock: Elbow Type/Universal Type

P.1243



Series	Port size	Applicable tubing O.D.
10-AS-F	M5 to 1/2	Metric
		$\varnothing 2$ to $\varnothing 16$
		Inch

$\varnothing 1/8''$ to $\varnothing 1/2''$

With Indicator: Elbow Type

P.1249



Series	Port size	Applicable tubing O.D.
10-AS-FS	M5 to 1/2	Metric
		$\varnothing 2$ to $\varnothing 16$
		Inch

$\varnothing 1/8''$ to $\varnothing 1/2''$

Speed Controller: Elbow Type/Universal Type

P.1253



Series	Port size	Applicable tubing O.D.
10-AS-F	M3 to 1/2	$\varnothing 3.2$ to $\varnothing 12$

Speed Controller: In-line Type

P.1257



Series	Applicable tubing O.D.
10-AS	$\varnothing 2$ to $\varnothing 12$

Dual Speed Controller

P.1261



Series	Port size	Applicable tubing O.D.
10-ASD	M5 to 1/2	$\varnothing 4$ to $\varnothing 12$

Push-lock (Stainless steel): Elbow Type/Universal Type

P.1265



Series	Port size	Applicable tubing O.D.
10-AS-FG	M5 to 1/2	Metric
		$\varnothing 2$ to $\varnothing 16$
		Inch

$\varnothing 1/8''$ to $\varnothing 1/2''$

With Indicator (Stainless steel): Elbow Type

P.1271



Series	Port size	Applicable tubing O.D.
10-AS-FSG	M5 to 1/2	Metric
		$\varnothing 2$ to $\varnothing 16$
		Inch

$\varnothing 1/8''$ to $\varnothing 1/2''$

Stainless Steel Speed Controller: Elbow Type/Universal Type

P.1275



Series	Port size	Applicable tubing O.D.
10-AS-FG	M5 to 1/2	$\varnothing 3.2$ to $\varnothing 12$

Stainless Steel Speed Controller: In-line Type

P.1279



Series	Applicable tubing O.D.
10-AS-FG	$\varnothing 3.2$ to $\varnothing 12$

Stainless Steel Dual Speed Controller

P.1282



Series	Port size	Applicable tubing O.D.
10-ASD-FG	M5 to 1/2	$\varnothing 4$ to $\varnothing 12$

Speed Controller: Metal Elbow Type

P.1286



Series	Port size
10-AS1200 to 4200	M3 to 1/2

Speed Controller: In-line Type

P.1288



Series	Port size
10-AS1000 to 5000	M3 to 1/2

Clean Series INDEX

Flow Control Equipment

Clean Speed Controller: Elbow Type

P.1291



Series	Port size	Applicable tubing O.D.
(21-)AS-FPQ AS-FPG	M5 to 1/2	ø4 to ø12

Speed Controller for Low Speed Operation: Elbow Type/Universal Type

P.1294



Series	Port size	Applicable tubing O.D.
10-AS-FM	M5 to 1/4	ø3.2 to ø10

Speed Controller for Low Speed Operation: In-line Type

P.1298



Series	Applicable tubing O.D.
10-AS-FM	ø3.2 to ø8

Dual Speed Controller for Low Speed Operation

P.1301



Series	Port size	Applicable tubing O.D.
10-ASD-FM	M5 to 1/4	ø4 to ø10

Pressure Switches/Pressure Sensors

2-Color Display High-Precision Digital Pressure Switch

P.1312



Series	Type
10-ZSE30A(F)/ISE30A	Vacuum pressure, compound pressure, positive pressure

2-Color Display High-Precision Digital Pressure Switch

P.1323



Series	Type
10-ZSE40A(F)/ISE40A	Vacuum pressure, compound pressure, positive pressure

2-Color Display Digital Pressure Switch for General Fluids

P.1340



Series	Type
10-ZSE80/ISE80	Vacuum pressure, compound pressure, positive pressure

Remote Type Pressure Sensor

P.1353



Application	Series	Type
For compact pneumatics	10-PSE530	Vacuum pressure, compound pressure, low pressure, high pressure

Remote Type Pressure Sensor

P.1355



Application	Series	Type
For compact pneumatics	10-PSE540	Compound pressure, positive pressure, negative pressure

Remote Type Pressure Sensor

P.1357



Application	Series	Type
For low differential pressure	10-PSE550	Low differential pressure

Remote Type Pressure Sensor

P.1359



Application	Series	Type
For general fluids	10-PSE560	Vacuum pressure, compound pressure, positive pressure

Remote Type Digital Pressure Sensor Controller/Multi-Channel

P.1361



Series
10-PSE200

Remote Type 2-Color Display Digital Pressure Sensor Controller

P.1366



Series
10-PSE300

Related Equipment

Fluoropolymer Products (Clean Wet Series)

P.1377



Valves,
fittings, tubing,
process pumps,
flow switches

Electric Actuators (Clean Room Specification)

P.1381



Slider type
High rigidity slider type

● System Circuit	P.15
● How to Use Clean Series	P.17
● Cleanliness Class	P.18
● Particle Generation Measuring Method	P.30
● Comparison of Cleanliness Standards (Reference)	P.34
● Safety Instructions	P.1382
● Clean Series Precautions	P.1383

System Circuit in Clean Room

The following are the actuator driving system and circuit configuration of the blow system employed to reduce particle generation when using pneumatic equipment in a clean room.

● Actuator Driving System

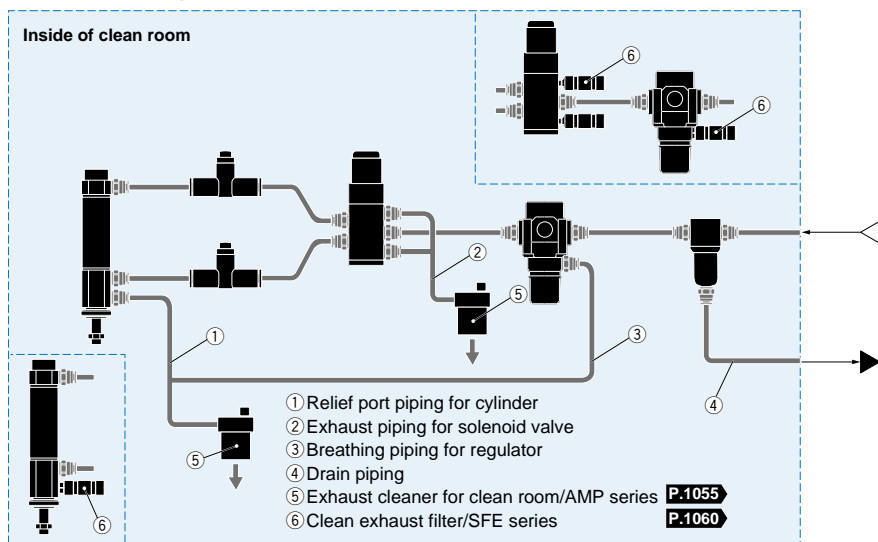

● Cylinder Relief Port Piping

Series 10-/12-/21- (Atmospheric release type)

Connect the relief port piping with the dedicated duct piping installed outside the clean room or with the exhaust cleaner for clean room/AMP series, or connect the clean exhaust filter SFE series to relief port piping.

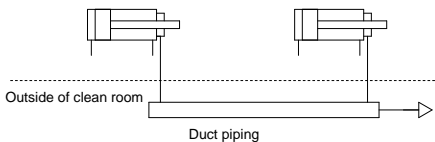

Series 11-/13-/22- (Vacuum suction type)

With a vacuum pump

When several air cylinders are used together or a model with high vacuum suction flow is used.

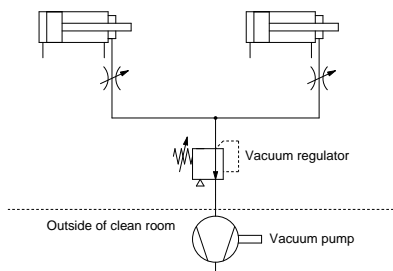

With an ejector

When a few air cylinders are used locally.

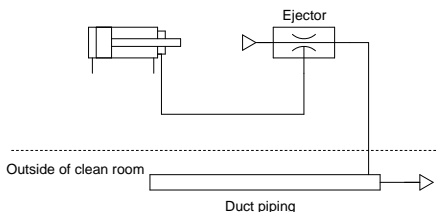

* The symbol for the cylinder is an original SMC symbol.

System Circuit in Clean Room

● Clean Blow System

Example of equipment to suit each clean blow grade

Line A: For clean blow

Line B: For clean blow (with clean gas filter or with clean air filter)

Line C: For N₂ blow

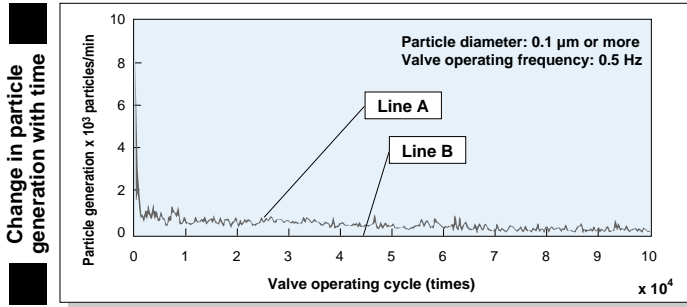

● Example of Air Line Equipment

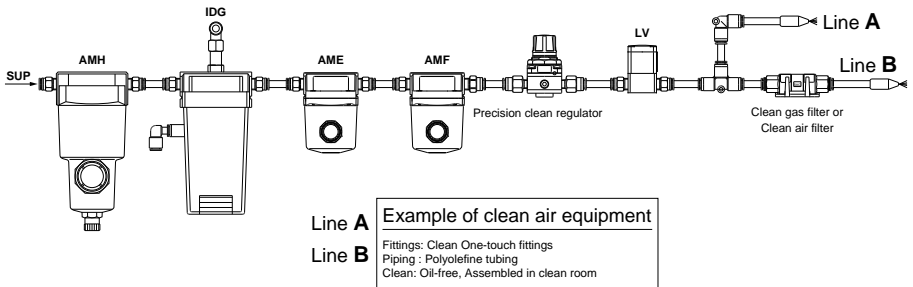

● Example of N₂ Equipment

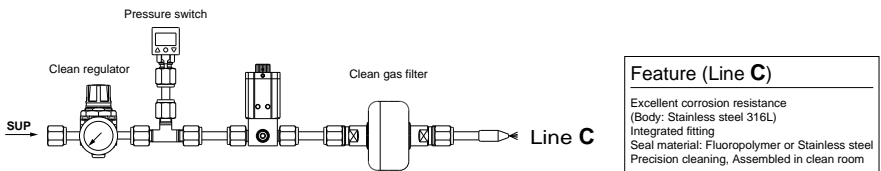

How to Use Clean Series

The position of the pneumatic equipment to the workpiece is determined by the degree of particle generation.

$$\text{Particle generation grade no. of pneumatic equipment} \leq \text{Particle concentration grade no. around workpiece}$$

Particle Generation Classification

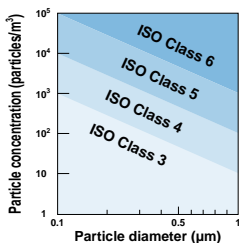

Cleanliness Class (Reference)

ISO 14644-1	JIS B 9920	Fed.Std.209E ^[Note]
		SI unit
ISO Class 3	JIS Class 3	M1.5
ISO Class 4	JIS Class 4	M2.5
ISO Class 5	JIS Class 5	M3.5
ISO Class 6	JIS Class 6	M4.5
ISO Class 7	JIS Class 7	M5.5
ISO Class 8	JIS Class 8	M6.5

Note) Fed.Std.209E was abolished in Nov. 2001, so these figures are for reference only.

Selection Procedure

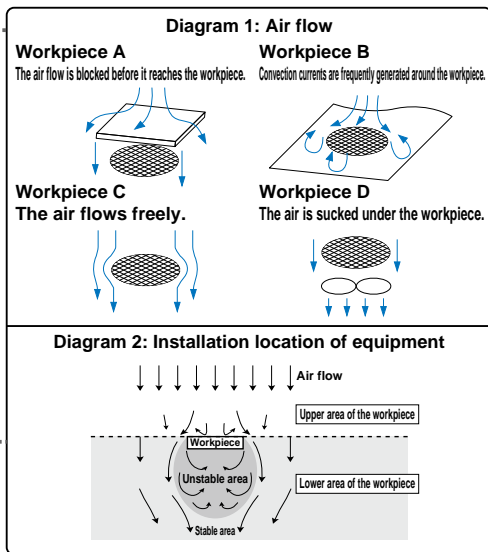
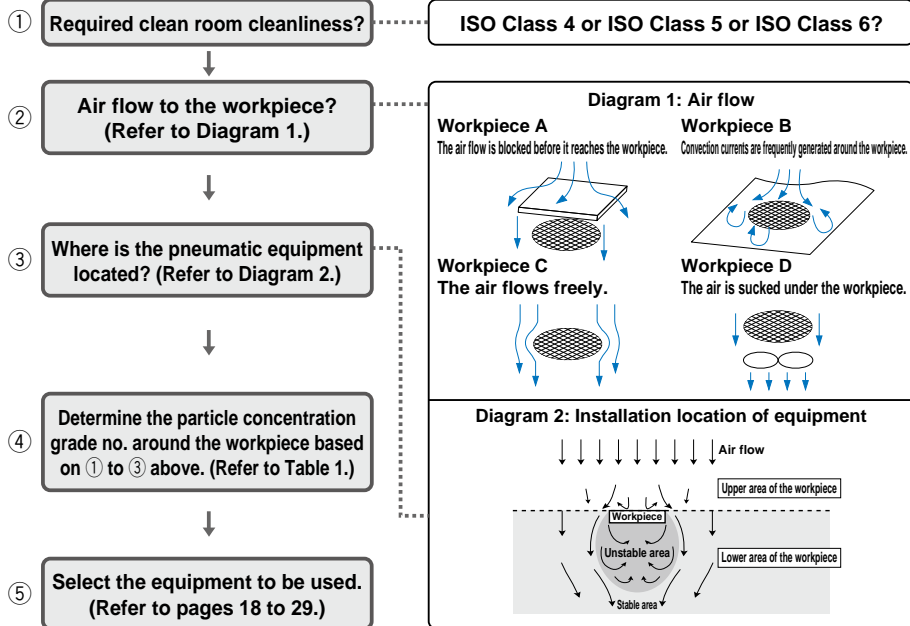







Table 1: Particle Concentration Grade around the Workpiece (Guide)

② Air flow	A: Air flow is blocked/B: Convection currents are frequently generated			C: Air flows freely			D: Air is sucked under the workpiece					
	Upper area of the workpiece	Lower area of the workpiece		Upper area of the workpiece	Lower area of the workpiece		Upper area of the workpiece	Lower area of the workpiece				
③ Installation location of equipment		Unstable area	Stable area	Upper area of the workpiece	Unstable area	Stable area	Upper area of the workpiece	Unstable area	Stable area			
① Cleanliness required on the workpiece	Class 3				Series 11- (Series 13-, 22-)		Series 10- (Series 12-, 21-)	Series 11- (Series 13-, 22-)		Series 10- (Series 12-, 21-)		
	Class 4				Series 10- (Series 12-, 21-)		Series 10- (Series 12-, 21-)		Standard product		Standard product	
	Class 5				Standard product		Standard product		Standard product		Standard product	
	Class 6				Standard product		Standard product		Standard product		Standard product	

: ISO Class 4 and 5 levels of cleanliness cannot be achieved in the area due to accumulated or airborne dust











Directional Control Valves

Description	Series	Cleanliness class (ISO class) ^{Note)}			Page
		Standard	10-	21-	
	^{Note 2)} ^{Note 2)} 10-SY3000/5000/7000/9000	5	3		P.38
	10-SV1000/2000/3000/4000	5	3		P.179
	10-SYJ3000/5000/7000	5	3		P.279
	10-SZ3000	5	3		P.377
4/5 Port Solenoid Valve		5	3	3	P.417
		5	3	3	P.514
		5	3	3	P.578
		5	3		P.597
		10-SYJ300/500/700	5	3	
3 Port Solenoid Valve		5	3		P.648
		5	3	3	P.658

Note 1) ISO classes apply to threaded port connection type.
 Different classes apply to the One-touch fittings. For details, refer to page 1385.
 Note 2) Please consult with SMC separately for SY connector type.





Values in show ISO classes.
 No class applies to blanks.

Air Cylinders

Description			Series	Cleanliness class (ISO class)							Page
				Standard	10-	11-	12-	13-	21-	22-	
	Air Cylinder	Standard	10-/11- 21-/22- CJ2	5	4	3			4	3	From P.685
			10-/11- 21-/22- CJ2-Z								
		Direct mount type	10-/11- 21-/22- CJ2W-Z								
		Direct mount type	10-/11- 21-/22- CJ2RA-Z								
	Air Cylinder	Standard	10-/11- 21-/22- CM2-Z	5	4	3			5	3	From P.700
			10-/11- 21-/22- CM2W-Z								
		Direct mount type	10-/11- 21-/22- CM2R-Z								
		End lock (Except rod side)	10-/11- 21-/22- CBM2								
	Air Cylinder	Standard	10-/11- 21-/22- CG1-Z	5	4	3			5	3	From P.722
			10- 11- CG1W-Z								
		Direct mount type	10- 11- CG1R-Z								
	Air Cylinder: Standard		10-/11- 21-/22- CA2	5	4	3			5	3	P.736
	Mini Free Mount Cylinder		10- 11- CUJ	5	4	3					P.740
	Free Mount Cylinder		10-/11- 21-/22- CDU	5	4	3			5	3	P.746
	Compact Cylinder: Standard		10-/11- 21-/22- CQS	5	4	3			4	3	P.749
			10-/11- 21-/22- CQ2-Z	5	4	3			4	3	P.758
	Magnetically Coupled Rodless Cylinder: Basic Type		12-CY3B	6			5				P.767
	Magnetically Coupled Rodless Cylinder: Direct Mount Type		12-CY3R	6			5				P.769
	Clean Rodless Cylinder		CYP	4							P.773

Values in show ISO classes.
 No class applies to blanks.

Air Cylinders

Description		Series	Cleanliness class (ISO class)						Page
			Standard	10-	11-	12-	13-	21-	
	Air Slide Table	13- 22- MXS (Without adjuster)	6				5	5	P.778
		13- 22- MXS (Rubber stopper)	6				5	5	
	Air Slide Table	13- 22- MXQ (Without adjuster)	6				5	5	P.799
		13- 22- MXQ (Rubber stopper)	6				5	5	
		13- 22- MXQ (Metal stopper)					6	6	
	Air Slide Table	11- MXJ (Without adjuster)	6		5			5	P.825
		11- MXJ (Metal stopper)			6			6	
	Air Slide Table	11- 22- MXP (Without adjuster)	5		3			3	P.831
		11- 22- MXP (Rubber stopper)	5		4			4	
		11- 22- MXP (Metal stopper)			6			6	
		11- 22- MXPJ6	5		3			3	

Values in show ISO classes.
 No class applies to blanks.

MXQ

Option	13-	22-
Without adjuster	5	
Rubber stopper	5	
Metal stopper	6	

MXJ





Option	11-	22-
Without adjuster	5	
Metal stopper	6	

MXP

Option	13-	22-
Without adjuster	3	
Rubber stopper	4	
Metal stopper	6	

MXP6 without adjuster is not available.
 Clean room specifications are not available for MXP8.

Air Cylinders

Description		Series	Cleanliness class (ISO class)							Page	
			Standard	10-	11-	12-	13-	21-	22-		
	Compact Guide Cylinder	¹² / ₁₃ :MGPL-Z	6			5	4	6	5	P.839	
	Guide Table Cylinder	10-MGF	6	4						P.844	
	Dual Rod Cylinder	Ball bushing bearing	¹¹ / ₂₁ - ¹² / ₂₂ : CXSJL	5		3	4		5	3	P.848
		Slide bearing	¹¹ / ₂₁ - ¹² / ₂₂ : CXSJM	6		3					
	Dual Rod Cylinder	Ball bushing bearing	¹⁰ / ₂₁ - ¹¹ / ₂₁ - ¹² / ₂₂ : CXSL	5	4	3	4		5	3	P.852
		Slide bearing	¹⁰ / ₂₁ - ¹¹ / ₂₁ - ¹² / ₂₂ : CXSM	6	4	3					





Values in show ISO classes.
 No class applies to blanks.

CXSJ

Option	11-	22-
Ball bushing bearing	5	
Slide bearing	6	



CXS

Option	11-	22-
Ball bushing bearing	5	
Slide bearing	6	





Description		Series	Cleanliness class (ISO class)							Page
			Standard	10-	11-	12-	13-	21-	22-	
	Sine Rodless Cylinder	12-REA	6			5				P.861
	Sine Cylinder	¹⁰ / ₁₁ :REC	5	4	3					P.864
	Low Speed Cylinder	¹⁰ / ₁₁ : CM2X-Z	5	4	3					P.868
		¹⁰ / ₁₁ : CQSX	5	4	3					P.870
		¹⁰ / ₁₁ : CQ2X	5	4	3					P.872

Values in show ISO classes.
 No class applies to blanks.

Rotary Actuators

Description			Series	Cleanliness class (ISO class)							Page	
				Standard	10-	11-	12-	13-	21-	22-		
	Rotary Actuator	Vane	10- 21-CRB1	6	4					4	3	P.893
		Rack & Pinion	11-CRA1-Z	5		4						
	Rotary Table		11- 22-MSQ	5		3					3	P.909

Air Grippers

Description			Series	Cleanliness class (ISO class)							Page	
				Standard	10-	11-	12-	13-	21-	22-		
	2 Finger Air Gripper		11- 22-MHZ2	6		4					4	P.923
	2 Finger Parallel Type Wide Opening Air Gripper		11- 22-MHL2	6		4					4	P.927
	Rotary Actuated Air Gripper	2 finger	11- 22-MHR2	6		3					3	P.932
		3 finger	11- 22-MHR3	6		3					3	P.938







Values in show ISO classes.
 No class applies to blanks.

Air Preparation Equipment

Description		Series	Cleanliness class (ISO class)		Page
			Standard	10-	
	Membrane Air Dryer	10-IDG□A	5	3	P.949
		10-IDG	5	3	P.950
	Main Line Filter	10-AFF2C to 22C 10-AFF37B, 75B	5	3	P.959
	Mist Separator	10-AM150C to 550C 10-AM650, 850	5	3	P.966
	Micro Mist Separator	10-AMD150C to 550C 10-AMD650, 850	5	3	P.973
	Micro Mist Separator with Pre-filter	10-AMH150C to 550C 10-AMH650, 850	5	3	P.980
	Super Mist Separator	10-AME150C to 550C 10-AME650, 850	5	3	P.987
	Odor Removal Filter	10-AMF150C to 550C 10-AMF650, 850	5	3	P.994
	Clean Gas Filter: Cartridge Type	SFA100/200/300	3		P.1011
	Clean Gas Filter: Cartridge Type	SFB100	3		P.1014
	Clean Gas Strainer: Cartridge Type	SFB200	3		P.1015
	Clean Gas Filter: Disposable Type	SFB300	3		P.1018
	Clean Gas Filter: Disposable Type	SFC100	3		P.1021









Values in show ISO classes.
 No class applies to blanks.

Air Preparation Equipment

Description		Series	Cleanliness class (ISO class)	Page
			Standard	
	Clean Air Filter: Disposable Type	SFD100	3	P.1031
	Clean Air Filter: Cartridge Type	SFD101/102	3	P.1031
	Clean Air Filter: Cartridge Type	SFD200	3	P.1031
	Clean Air Module	LLB	3	P.1039
	Exhaust Cleaner for Clean Room	AMP220 to 420	3 Exhaust air: 5	P.1055
	Clean Exhaust Filter	Male thread type	3 Exhaust air: 4	P.1060
		Plug-in type		





Values in show ISO classes.

Modular F.R.

Description		Series	Cleanliness class (ISO class)			Page
			Standard	10-	21-	
	Air Filter	¹⁰ / ₂₁ : AF20 to 60	5	3	3	P.1069
	Mist Separator	¹⁰ / ₂₁ : AFM20 to 40	5	3	3	P.1071
	Micro Mist Separator	¹⁰ / ₂₁ : AFD20 to 40	5	3	3	P.1073
	Regulator	¹⁰ / ₂₁ : AR20 to 60	5	3	3	P.1075
	Regulator with Backflow Function	¹⁰ / ₂₁ : AR20K to 60K	5	3	3	P.1075
	Filter Regulator	¹⁰ / ₂₁ : AW20 to 60	5	3	3	P.1079
	Filter Regulator with Backflow Function	¹⁰ / ₂₁ : AW20K to 60K	5	3	3	P.1079
	Mist Separator Regulator	¹⁰ / ₂₁ : AWM20 to 40	5	3	3	P.1083
	Micro Mist Separator Regulator	¹⁰ / ₂₁ : AWD20 to 40	5	3	3	P.1083











Values in show ISO classes.

Pressure Control Equipment

Description		Series	Cleanliness class (ISO class)			Page
			Standard	10-	21-	
	Direct Operated Precision Regulator	10- 21- ARP20 to 40	5	3	3	P.1093
	Direct Operated Precision Regulator with Backflow Function	10- 21- ARP20K to 40K	5	3	3	P.1093
	Precision Regulator	10-IR1000 to 3000		3		P.1101
	Vacuum Regulator	10-IRV10/20		3		P.1106
	Clean Regulator	SRH3000/4000	3			P.1114
	Precision Clean Regulator	SRP	5			P.1118















Values in show ISO classes.
 No class applies to blanks.

Fittings & Tubing

Description		Series	Cleanliness class (ISO class)			Page
			Standard	10-	21-	
	One-touch Fittings	10-KQ2	6	5		P.1124
	Insert Fittings	10-KF	5	3		P.1190
	Miniature Fittings	10-M	5	3		P.1196
	Rectangular Multi-connector	10-KDM	6	5		P.1202
	Stainless Steel One-touch Fittings	10-KG	6	5		P.1206
	Stainless Steel Miniature Fittings	10-MS	5	3		P.1217
	Clean One-touch Fittings	For blowing	KP	3		P.1221
		For driving air piping	KPQ	3	3	P.1225
			KPG	3	3	P.1225
	Polyurethane Tubing	10-TU	5	3		P.1232
	Polyurethane Coil Tubing	10-TCU	5	3		P.1233
	Polyurethane Flat Tubing	10-TFU	5	3		P.1234
	Clean Tubing	Polyolefin	TPH	3		P.1235
		Soft polyolefin	TPS	3		P.1236



Values in show ISO classes.
 No class applies to blanks.

Flow Control Equipment









Description		Series	Cleanliness class (ISO class)			Page
			Standard	10-	21-	
	Push-lock: Elbow Type/Universal Type	10-AS-F	6	5		P.1243
	With Indicator: Elbow Type	10-AS-FS	6	5		P.1249
	Speed Controller: Elbow Type/Universal Type	10-AS-F	6	5		P.1253
	Speed Controller: In-line Type	10-AS	6	5		P.1257
	Dual Speed Controller	10-ASD	6	5		P.1261
	Push-lock (Stainless steel): Elbow Type/Universal Type	10-AS-FG	6	5		P.1265
	With Indicator (Stainless steel): Elbow Type	10-AS-FSG	6	5		P.1271
	Stainless Steel Speed Controller: Elbow Type/Universal Type	10-AS-FG	6	5		P.1275
	Stainless Steel Speed Controller: In-line Type	10-AS-FG	6	5		P.1279
	Stainless Steel Dual Speed Controller	10-ASD-FG	6	5		P.1282
	Speed Controller: Metal Elbow Type	10-AS1200 to 4200	5	3		P.1286
	Speed Controller: In-line Type	10-AS1000 to 5000	5	3		P.1288
	Clean Speed Controller	(21-)AS-FPQ	3		3	P.1291
		(21-)AS-FPG	3		3	P.1291
	Speed Controller for Low Speed Operation: Elbow Type/Universal Type	10-AS-FM	6	5		P.1294

Values in show ISO classes.
 No class applies to blanks.

Flow Control Equipment

Description		Series	Cleanliness class (ISO class)			Page
			Standard	10-	21-	
	Speed Controller for Low Speed Operation: In-line Type	10-AS-FM	6	5		P.1298
	Dual Speed Controller for Low Speed Operation	10-ASD-FM	6	5		P.1301

Pressure Switches/Pressure Sensors

Description		Series	Cleanliness class (ISO class)		Page	
			Standard	10-		
	2-Color Display High-Precision Digital Pressure Switch	10-ZSE30A(F)/ISE30A	5	4	P.1312	
	2-Color Display High-Precision Digital Pressure Switch	10-ZSE40A(F)/ISE40A	5	4	P.1323	
	2-Color Display Digital Pressure Switch for General Fluids	10-ZSE80/ISE80	5	4	P.1340	
	Remote Type Pressure Sensor	For compact pneumatics	10-PSE530	5	4	P.1353
		For compact pneumatics	10-PSE540	5	4	P.1355
		For low differential pressure	10-PSE550	5	4	P.1357
		For general fluids	10-PSE560	5	4	P.1359
	Remote Type Digital Pressure Sensor Controller/Multi-Channel	10-PSE200	3	3	P.1361	
	Remote Type 2-Color Display Digital Pressure Sensor Controller	10-PSE300	3	3	P.1366	

Values in show ISO classes.
 No class applies to blanks.

Particle Generation Measuring Method

The particle generation data for SMC Clean Series is measured with the following test method.

Test Method (Example)

Place the test sample in the acrylic resin chamber and operate it while supplying the same flow rate of clean air as the suction flow rate of the measuring instrument ($28.3 \times 10^{-3} \text{ m}^3/\text{min}$). Measure the changes in the particle concentration over time until the number of cycles reaches the specified point. The chamber is placed in an ISO Class 5 equivalent clean bench.

Measuring Conditions

Chamber	Internal volume	$28.3 \times 10^{-3} \text{ m}^3$
	Supply air quality	Same quality as the supply air
Measuring instrument	Description	Automatic particle counter using light-scattering method
	Minimum measurable particle diameter	$0.1 \mu\text{m}$
	Suction flow rate	$28.3 \times 10^{-3} \text{ m}^3/\text{min}$
Setting conditions	Sampling time	30 min
	Interval time	30 min
	Sampling air flow	$850 \times 10^{-3} \text{ m}^3$

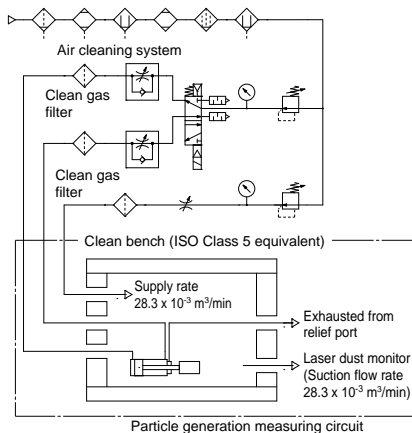

* The symbol for the cylinder is an original SMC symbol.

Evaluation Method

To obtain the measured values of particle concentration, the accumulated value ^{Note 1)} of particles captured every 30 minutes by the laser dust monitor, is converted into the particle concentration every 1 m^3 .

When determining particle generation classes, the 95% upper confidence limit of the average particle concentration (average value) when each test sample is operated at a specified number of cycles ^{Note 2)} is considered.

The plots in the graphs indicate the 95% upper confidence limit of the average particle concentration of particles with a diameter within the horizontal axis range.

Note 1) Sampling air flow rate: Number of particles contained in $850 \times 10^{-3} \text{ m}^3$ of air

Note 2) Actuator: 1 million cycles

Solenoid valve: 10 million cycles

Particle Generation Characteristics (The particle generation data is representative and not guaranteed.)

Series CQ2-Z

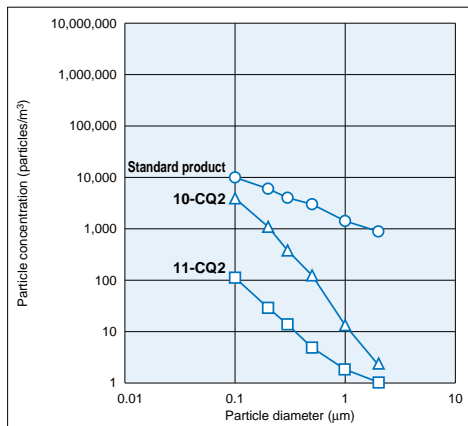

Series CM2-Z

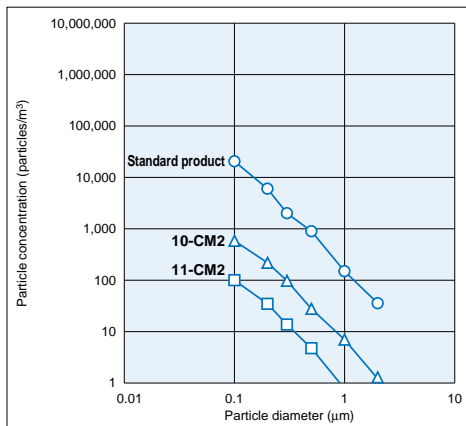

Particle Generation Measuring Method

■ Particle Generation Characteristics (The particle generation data is representative and not guaranteed.)

Series CXSL

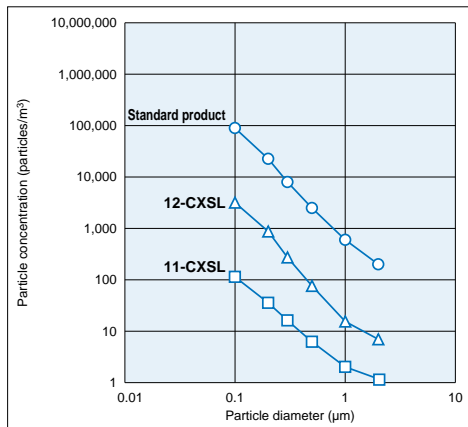

Series MGPL-Z

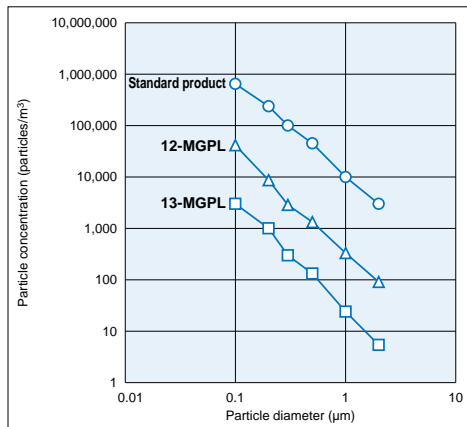

Series MHZ2

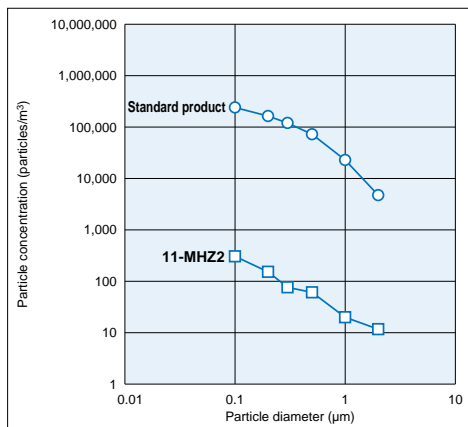

Series MHL2

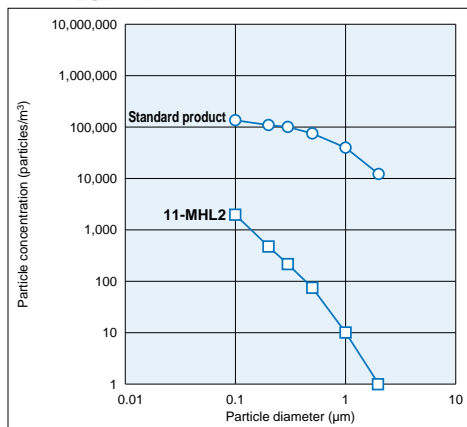

Particle Generation Measuring Method

■ Particle Generation Characteristics (The particle generation data is representative and not guaranteed.)

Series MHR2

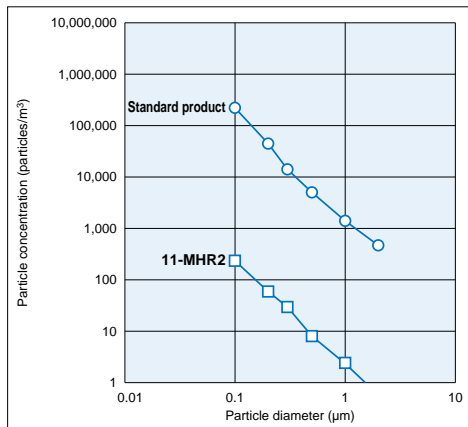

Series MHR3

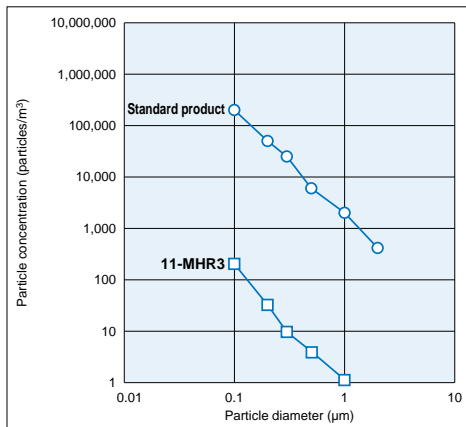

Series CRB1

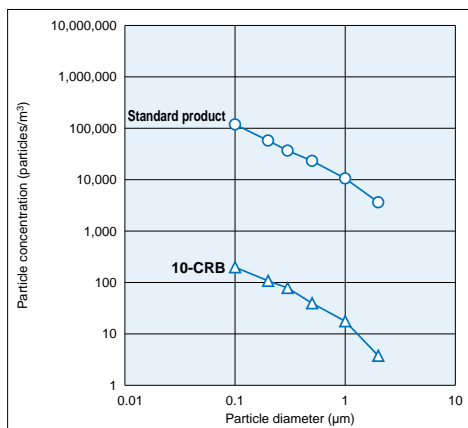

Series MSQ

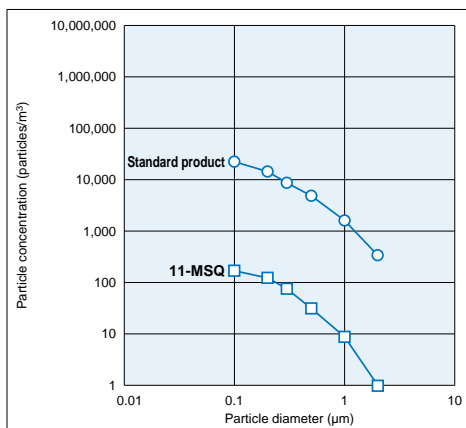

Particle Generation Measuring Method

■ Particle Generation Characteristics (The particle generation data is representative and not guaranteed.)

Series MXQ

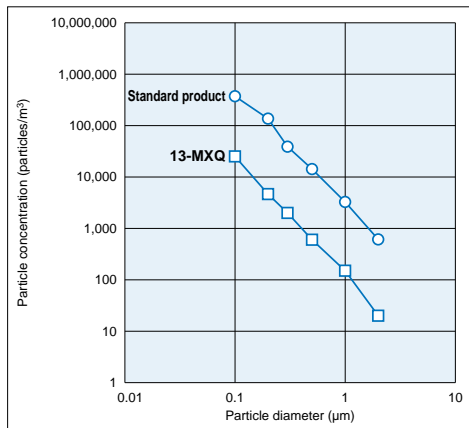

Series MXS

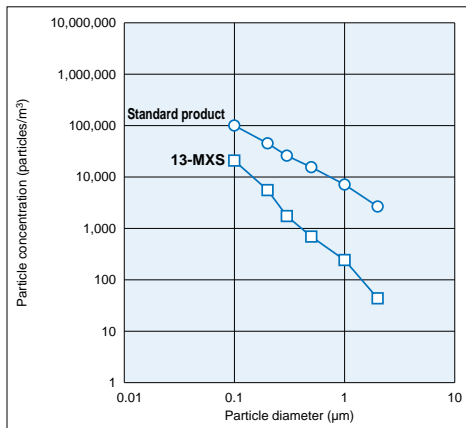

Series SY

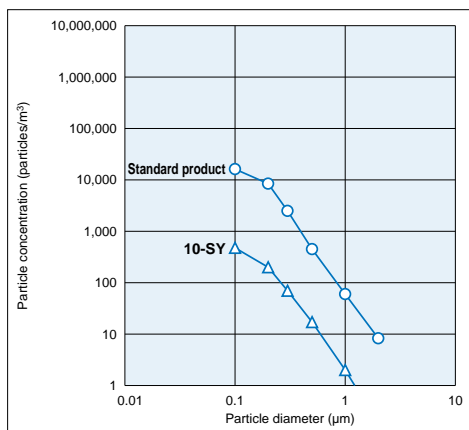

Comparison of Cleanliness Standards (Reference)

Standard	ISO 14644-1	JIS B 9920	Fed.Std.209E <small>Note)</small>		
Cleanliness class	ISO Class 1 to 9 Intermediate class available U descriptor: Particle diameter less than 0.1 μm M descriptor: Particle diameter exceeding 5.0 μm		British unit: Class 1 to 100.000 SI unit: Class M1 to M7 U descriptor: Particle diameter less than 0.1 μm		
	Corresponding class			(British unit)	(SI unit)
		ISO Class 1	JIS Class 1		
		ISO Class 2	JIS Class 2		
		ISO Class 3	JIS Class 3	1	M1.5
		ISO Class 4	JIS Class 4	10	M2.5
		ISO Class 5	JIS Class 5	100	M3.5
		ISO Class 6	JIS Class 6	1000	M4.5
		ISO Class 7	JIS Class 7	10000	M5.5
		ISO Class 8	JIS Class 8	100000	M6.5
ISO Class 9	JIS Class 9				
Cleanliness class definition	The number of particles diameter 0.1 μm or larger in an air volume of 1 m ³ is expressed as 10 ^N . ISO Class N: Occupancy state: Sampling particle diameter		The number of particles diameter 0.5 μm or larger in an air volume of 1 m ³ is expressed as 10 M or coefficient Nc. Cleanliness class: Nc or M		
Calculation of max permitted concentration of particulates for cleanliness classes	$C_n = 10^N \times (0.1/D)^{2.08}$		British unit: Number of particles/ft ³ = Nc x (0.5/D) ^{2.2} SI unit: Number of particles/m ³ = 10 M x (0.5/D) ^{2.2}		
Evaluation method using simple sampling	① Number of sampling locations: 2 to 9 95% UCL of the mean and the mean of the averages ② Number of sampling locations: 1, or 10 or more The mean		① Number of sampling locations: 2 to 9 95% UCL of the mean and the mean of the averages ② Number of sampling locations: 10 or more The mean		
Number of sampling locations	Derive from the area of the clean room or clean air controlled space. Number of sampling locations N _L = (A) ^{0.5} At least one location		① Non-unidirectional air flow: at least two locations N _L = A x 64/(10 M) ^{0.5} ② Unidirectional air flow: at least two locations Smaller value between N _L = A/2.32, N _L = A x 64/(10 M) ^{0.5}		
Min. sampling air flow volume	2 liters or a sufficient volume of air that a minimum of 20 particles can be counted if the particle concentration were at the class limit. Min. sampling time: 1 minute		2 liters or a sufficient volume of air that a minimum of 20 particles can be counted if the particle concentration were at the class limit.		
Number of samplings	Where only one sampling location is required, take a minimum of three single sample volumes at that location.		Total number of samplings in each clean zone: 5 times or more		
Sampling method	Suction in the same direction as the air flow If the direction of the air flow is not predictable, the inlet of the sampling probe shall be directed vertically upward.		5.0 μm or larger: Constant velocity and suction in the same direction of the air flow 0.5 to 5 μm: Correction possible when it is sucked at a nonconstant velocity		

Note) Fed.Std.209E was abolished in Nov. 2001, so these figures are for reference only.

Comparison of Cleanliness Standards (Reference)

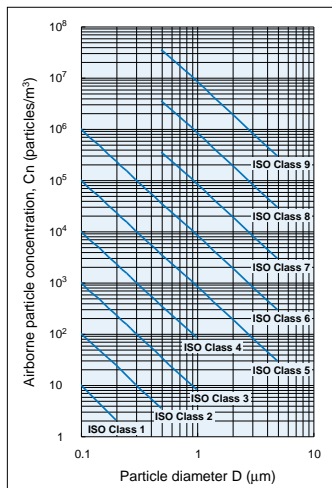

$$C_n = 10^N \times (0.1/D)^{2.08}$$

C_n: The maximum permitted concentration of airborne particles that are equal to or larger than the sampling particle diameter (D). C_n is rounded down to the nearest whole number, using no more than three significant figures.

N: Class No. (1 to 9), Intermediate class (1.1 to 8.9)

D: Sampling particle diameter (μm)

0.1: Constant number (μm)

Note) Concentration data with no more than three significant figures used in determining the classification level.

ISO Standard (ISO 14644-1)/JIS Standard (JIS B 9920)

Cleanliness class	Maximum concentration limit (particles/m ³)						Fed.Std.209E equivalent	
	Sampling particle diameter (μm)						(British unit)	(SI unit)
	0.1 μm	0.2 μm	0.3 μm	0.5 μm	1 μm	5 μm		
Class 1	10	2	—	—	—	—		
Class 2	100	24	10	4	—	—		
Class 3	1,000	237	102	35	8	—	Class 1	Class M1.5
Class 4	10,000	2,370	1,020	352	83	—	Class 10	Class M2.5
Class 5	100,000	23,700	10,200	3,520	832	29	Class 100	Class M3.5
Class 6	1,000,000	237,000	102,000	35,200	8,320	293	Class 1,000	Class M4.5
Class 7	—	—	—	352,000	83,200	2,930	Class 10,000	Class M5.5
Class 8	—	—	—	3,520,000	832,000	29,300	Class 100,000	Class M6.5
Class 9	—	—	—	35,200,000	8,320,000	293,000		

□ : Number of particles 0.1 μm or larger contained in 1 m³ (particles/m³)

U.S. Federal Standard (Fed.Std.209E: British unit)

Cleanliness class	Maximum concentration limit (particles/ft ³)				
	Sampling particle diameter (μm)				
	0.1 μm	0.2 μm	0.3 μm	0.5 μm	5 μm
Class 1	35	8	3	1	—
Class 10	350	75	30	10	—
Class 100	3,500	750	300	100	—
Class 1,000	35,000	7,500	3,000	1,000	7
Class 10,000	—	—	—	10,000	70
Class 100,000	—	—	—	100,000	700

□ : Number of particles 0.5 μm or larger contained in 1 ft³ (particles/ft³)

U.S. Federal Standard (Fed.Std.209E: SI unit)

Cleanliness class	Maximum concentration limit (particles/m ³)				
	Sampling particle diameter (μm)				
	0.1 μm	0.2 μm	0.3 μm	0.5 μm	5 μm
Class M1	350	76	31	10	—
Class M1.5	1,240	265	106	35	—
Class M2	3,500	757	309	100	—
Class M2.5	12,400	2,650	1,060	353	—
Class M3	35,000	7,570	3,090	1,000	—
Class M3.5	—	26,500	10,600	3,530	—
Class M4	—	75,700	30,900	10,000	—
Class M4.5	—	—	—	35,300	247
Class M5	—	—	—	100,000	618
Class M5.5	—	—	—	353,000	2,470
Class M6	—	—	—	1,000,000	6,180
Class M6.5	—	—	—	3,530,000	24,700

□ : Number of particles 0.5 μm or larger contained in 1 m³ (particles/m³)

For Clean Room

Directional Control Valves

Contents	Series	Page
■ 4/5 Port Solenoid Valves		
5 Port Solenoid Valve	10-SY3000/5000/7000/9000	P.38
5 Port Solenoid Valve	10-SV1000/2000/3000/4000	P.179
4/5 Port Solenoid Valve	10-SYJ3000/5000/7000	P.279
5 Port Solenoid Valve	10-SZ3000	P.377
5 Port Solenoid Valve	10-S0700	P.417
5 Port Solenoid Valve	10-¹⁰⁻²¹⁻VQ1000/2000	P.514
5 Port Solenoid Valve	10-SQ1000/2000	P.578
4 Port Direct Operated Poppet Solenoid Valve	10-VQD1000	P.597
■ 3 Port Solenoid Valves		
3 Port Solenoid Valve	10-SYJ300/500/700	P.602
3 Port Solenoid Valve	10-SY100	P.648
Compact Direct Operated 3 Port Solenoid Valve	10-S070	P.658
Precautions		P.677

Directional Control Valves

Air Cylinders

Rotary Actuators

Air Grippers

Air Preparation Equipment

Modular F. R.

Pressure Control Equipment

Fittings & Tubing

Flow Control Equipment

Pressure Switches/ Pressure Sensors

Series 10-SY3000/5000/7000/9000 5 Port Solenoid Valve

Valve Variations

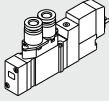
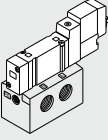



Series		Sonic conductance C [dm ³ /(s·bar)] { 4/2→5/3 {(A/B→EA/EB)}	Actuation					Voltage		Electrical entry					Light/surge voltage suppressor
			2 position		3 position			DC 24 V 12 V 6 V 5 V 3 V	AC 100 V 110 V 200 V 220 V 50/60 Hz	Grommet	L plug connector	M plug connector	DIN terminal	M8 connector	
			Single	Double	Closed center	Exhaust center	Pressure center								
Body ported		10-SY3□20	0.65	●	●	●	●	●	●	●	●	●	●	●	
		10-SY5□20	2.4	●	●	●	●	●	●	●	●	●	●	●	
		10-SY7□20	3.3	●	●	●	●	●	●	●	●	●	●	●	
		10-SY9□20	8.6	●	●	●	●	●	●	●	●	●	●	●	
Base mounted		10-SY3□40	1.1	●	●	●	●	●	●	●	●	●	●		
		10-SY5□40	2.8	●	●	●	●	●	●	●	●	●	●		
		10-SY7□40	4.5	●	●	●	●	●	●	●	●	●	●		
		10-SY9□40	10	●	●	●	●	●	●	●	●	●	●		

Series	Manual override			Bracket	P, EA, EB port size					A, B port size										Valve option						
	Non-locking push type	Push-turn locking slotted type	Push-turn locking lever type		M5	1/8	1/4	3/8	1/2	M5	1/8	1/4	3/8	1/2	One-touch fitting							Exhaust throttle	Vacuum specifications	Low pressure specifications	Dual pressure	Enclosure IP65
															C4	C6	C8	C10	C12	N3	N7					
Body ported	10-SY3□20	●	●	●	●	—	—	—	—	●	●	—	—	—	●	●	—	—	—	—	●	▲	—	—	—	—
	10-SY5□20	●	●	●	●	—	—	—	—	●	—	—	—	—	●	●	—	—	—	—	—	—	—	—	—	—
	10-SY7□20	●	●	●	●	●	—	—	—	—	—	—	—	—	●	●	—	—	—	—	—	—	—	—	—	—
	10-SY9□20	●	●	—	—	—	●	—	—	—	●	●	—	—	—	—	—	—	—	—	—	—	—	—	—	—
Base mounted	10-SY3□40	●	●	●	—	●	—	—	—	—	●	—	—	—	—	—	—	—	—	—	—	—	—	—	—	—
	10-SY5□40	●	●	●	—	—	●	—	—	—	—	●	—	—	—	—	—	—	—	—	—	—	—	—	—	—
	10-SY7□40	●	●	—	—	—	●	●	—	—	—	—	●	—	—	—	—	—	—	—	—	—	—	—	—	—
	10-SY9□40	●	●	—	—	—	—	●	—	—	—	—	●	—	—	—	—	—	—	—	—	—	—	—	—	—

● Standard ● Option ▲ Made to order (Refer to page "Made to Order")
 Note 1) All AC voltage models have built-in surge voltage suppressor.
 Note 2) Body ported external pilot type (made to order) is not available for DIN terminal.
 Note 3) Only available for DIN terminal and M8 connector.
 Note 4) 10-SY3000 does not have a DIN terminal which can be connected to a manifold.

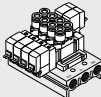
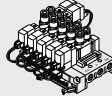

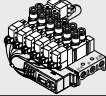

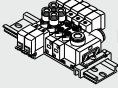



Directional Control Valves
 Air Cylinders
 Rotary Actuators
 Air Grippers
 Air Preparation Equipment
 Modular F. R.
 Pressure Control Equipment
 Fittings & Tubing
 Flow Control Equipment
 Pressure Switches/ Pressure Sensors

Manifold Variations

Manifold Variations		Valve Series	Wiring										
			Individual wiring	Connection						Common specifications			
				Flat ribbon cable (26 pins)	Flat ribbon cable (20 pins) connector box	Plug-in type D-sub connector (25 pins)	Plug-in type flat ribbon cable (26, 20, 10 pins)	Plug-in type terminal block (9, 18 pins)	PC wiring	Serial transmission unit	Positive common	Negative common	
Body ported	Bar stock type Individual wiring ■ Direct piping to the main unit of a valve. Combination of different fittings is possible.		Type 20 P. 73	10-SY3□20 10-SY5□20 10-SY7□20	●	—	—	—	—	—	—	—	—
	Bar stock type Flat ribbon cable ■ A 26 pin MIL connector permits one-touch wiring of external cables in a bundle.		Type 20P P. 83	10-SY3□20 10-SY5□20 10-SY7□20	—	●	—	—	—	—	—	● (Note)	In common
	Stacking type Individual wiring ■ Manifold stations can be increased or decreased.		Type 23 P. 79	10-SY9□20	●	—	—	—	—	—	—	—	—
	Stacking type Flat ribbon cable ■ Manifold stations can be increased or decreased.		Type 23P P. 89	10-SY9□20	—	●	—	—	—	—	—	● (Note)	In common
	Bar stock type EX510 gateway type ■ Can be used with a serial transmission system.		Type 20SA P. 92	10-SY3□20 10-SY5□20 10-SY7□20	—	—	—	—	—	—	●	—	—
	Stacking type EX510 gateway type ■ Can be used with a serial transmission system.		Type 23SA P. 97	10-SY9□20	—	—	—	—	—	—	●	—	—
	Cassette type Individual wiring ■ Size and weight reduced by eliminating the manifold base.		Type 60 P. 104	10-SY3□60 10-SY5□60 10-SY7□60	●	—	—	—	—	—	—	—	—

● Standard ○ Option ▲ Made to order (Refer to page "Made to Order".)
 (Note) When there are polarities, the positive common specifications are used.

Manifold Variations

Manifold Variations		Valve Series		Wiring								
				Connection						Common specifications		
				Individual wiring	Flat ribbon cable (26 pins)	Flat ribbon cable (20 pins) connector box	PC wiring	Serial transmission unit	Positive common	Negative common		
		5 port										
Base mounted	Compact bar stock type Individual wiring ■ The base mounting facilitates maintenance after valves are changed.		Type 41 P. 118	10-SY3□40	●	—	—	—	—	—	—	—
	Compact bar stock type Flat ribbon cable ■ A 26 pin MIL connector permits one-touch wiring of external cables in a bundle.		Type 41P P. 134	10-SY3□40 10-SY5□40	—	●	—	—	—	—	● (Note)	In common
	Bar stock type/Common external pilot Individual wiring ■ The base mounting facilitates maintenance after valves are changed. ■ Vacuum/low pressure combination system is possible.		Type 42 P. 118	10-SY3□40 10-SY5□40 10-SY7□40	●	—	—	—	—	—	—	—
	Bar stock type/Common external pilot Flat ribbon cable ■ A 26 pin MIL connector permits one-touch wiring of external cables in a bundle. ■ Vacuum/low pressure combination system is possible.		Type 42P P. 134	10-SY3□40 10-SY5□40 10-SY7□40	—	●	—	—	—	—	● (Note)	In common
	Stacking type Individual wiring ■ Manifold stations can be increased or decreased.		Type 43 P. 128	10-SY9□40	●	—	—	—	—	—	—	—
	Stacking type Flat ribbon cable ■ Manifold stations can be increased or decreased.		Type 43P P. 142	10-SY9□40	—	●	—	—	—	—	● (Note)	In common
	Stacking type/DIN rail mounted Individual wiring ■ Stations can be increased on the DIN rail. Integral mounting of other electric parts is possible, too.		Type 45 P. 150	10-SY3□40 10-SY5□40	●	—	—	—	—	—	—	—
	Stacking type/DIN rail mounted Connector box ■ Stations can be increased or decreased on the DIN rail. The provided connector box permits one-touch connection of electric cables.		Type 45^A_{NA} P. 157	10-SY3□40 10-SY5□40	—	—	●	●	—	●	●	●

● Standard ○ Option ▲ Made to order (Refer to page "Made to Order".)
 (Note) When there are polarities, the positive common specifications are used.

Series 10-SY3000/5000/7000/9000

5 Port Solenoid Valve Body Ported/Single Unit



[Option]
Note) AC-type models that are CE-compliant have DIN terminals only.

How to Order

10 - SY 5 1 20 - 5 L - 01 - - - -

Clean series

Series

3	10-SY3000
5	10-SY5000
7	10-SY7000
9	10-SY9000

Actuation type

1	2 position single (A)4 2(B) (EA)5 1 3(EB) (P)
2	2 position double (A)4 2(B) (EA)5 1 3(EB) (P)
3	3 position closed center (A)4 2(B) (EA)5 1 3(EB) (P)
4	3 position exhaust center (A)4 2(B) (EA)5 1 3(EB) (P)
5	3 position pressure center (A)4 2(B) (EA)5 1 3(EB) (P)

Coil type	
Nil	Standard
T	With power saving circuit (24, 12 VDC only)

* Power saving circuit is not available for D, DO, Y, YO or W□ types.

For DC

5	24 VDC
6	12 VDC
V	6 VDC
S	5 VDC
R	3 VDC

Rated voltage

For AC (% Hz)	
1	100 VAC
2	200 VAC
3	110 VAC [115 VAC]
4	220 VAC [230 VAC]

* DC specifications of type D, Y, DO and YO are only available with 12 and 24 VDC.
* For type W□, only DC voltage is available.
Note) AC-type models that are CE-compliant have DIN terminals only.

Note) For details about Symbol of the 3 position type 10-SY9000 series, refer to the SY series of the WEB catalog.

Electrical entry

	24, 12, 6, 5, 3 VDC/100, 110, 200, 220 VAC	24, 12 VDC/100, 110, 200, 220 VAC	
Grommet	L plug connector	M plug connector	DIN terminal
G: Lead wire length 300 mm 	L: With lead wire (Length 300 mm) 	M: With lead wire (Length 300 mm) 	D, Y: With connector
H: Lead wire length 600 mm 	LN: Without lead wire 	LO: Without connector 	DO, YO: Without connector
CE-compl. ant. AC	●	●	●

M8 connector

W□: Without connector cable

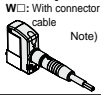

Note)

* LN, MN type: With 2 sockets.
* For DIN terminal of the 10-SY3000 series, refer to page 174.
* "Y" type is a DIN terminal conforming to EN-175301-803C (former DIN43650C). For details, refer to page 173.
* For connector cable of M8 connector, refer to page 176.
* M8 connector conforming to IEC60947-5-2 standard is also available. Refer to page 168 for details.
* Refer to page 173 for the lead wire length of L and M plug connectors.
* Refer to page 174 for the connector assembly with cover for L and M plug connectors.
Note) Enter the cable length symbols in □. Please be sure to fill in the blank referring to page 176.

CE-compl. ant. AC	●
-------------------	---

A, B port size

Thread piping

Symbol	Port size	Applicable series
M5	M5 x 0.8	10-SY3000
01	1/8	10-SY5000
02	1/4	10-SY7000
02	1/4	10-SY9000
03	3/8	10-SY9000

One-touch fitting (Metric size)

Symbol	Port size	Applicable series
C4	ø4 One-touch fitting	10-SY3000
C6	ø6 One-touch fitting	10-SY3000
C4	ø4 One-touch fitting	10-SY5000
C6	ø6 One-touch fitting	10-SY5000
C8	ø8 One-touch fitting	10-SY7000
C8	ø8 One-touch fitting	10-SY7000
C10	ø10 One-touch fitting	10-SY9000
C8	ø8 One-touch fitting	10-SY9000
C10	ø10 One-touch fitting	10-SY9000
C12	ø12 One-touch fitting	10-SY9000

One-touch fitting (Inch size)

Symbol	Port size	Applicable series
N3	ø 3/32 One-touch fitting	10-SY3000
N7	ø 1/4" One-touch fitting	10-SY3000
N3	ø 3/32 One-touch fitting	10-SY5000
N7	ø 1/4" One-touch fitting	10-SY5000
N9	ø 9/16" One-touch fitting	10-SY5000
N9	ø 9/16" One-touch fitting	10-SY7000
N11	ø 3/4" One-touch fitting	10-SY7000
N9	ø 9/16" One-touch fitting	10-SY9000
N11	ø 3/4" One-touch fitting	10-SY9000

Manual override

Nil: Non-locking push type 	D: Push-turn locking slotted type 	E: Push-turn locking lever type
--------------------------------	---------------------------------------	-------------------------------------

Bracket

Nil: Without bracket
F1: With foot bracket (2 position single only)

F2: With side bracket

* 10-SY9000 has no bracket.

Thread type

Nil	Rc
F	G
N	NPT
T	NPTF

* Except for M5

Made to Order

Nil	—
X90	Main valve fluorozinc (Refer to page 168).

CE-compliant

Nil	—
Q	CE-compliant

Note) AC-type models that are CE-compliant have DIN terminals only.

Light/Surge voltage suppressor

Electrical entry for G, H, L, M, W

Nil	Without light/surge voltage suppressor
S	With surge voltage suppressor
Z	With light/surge voltage suppressor
R	With surge voltage suppressor (Non-polar type)
U	With light/surge voltage suppressor (Non-polar type)

Electrical entry for D, Y

Nil	Without light/surge voltage suppressor
S	With surge voltage suppressor (Non-polar type)
Z	With light/surge voltage suppressor (Non-polar type)

* For AC voltage valves there is no "S" option. It is already built into the rectifier circuit.
* For "R" and "U", only DC voltage is available.
* Power saving circuit is only available for the "Z" type.
* DOZ and YOZ are not available.
* For AC voltage valves there is no "S" option. It is already built into the rectifier circuit.

Note) When placing an order for body ported solenoid valves as a single unit, the mounting screws for the manifold and gasket are not attached. Order them separately, if necessary. (For details, refer to page 100.)

Specifications



Series		10-SY3000	10-SY5000	10-SY7000	10-SY9000
Fluid		Air			
Internal pilot operating pressure range (MPa)	2 position single	0.15 to 0.7			
	2 position double	0.1 to 0.7			
	3 position	0.2 to 0.7			
Ambient and fluid temperature (°C)		-10 to 50 (No freezing)			
Max. operating frequency (Hz)	2 position single, double	10	5	5	5
	3 position	3	3	3	3
Manual override (Manual operation)		Non-locking push type, Push-turn locking slotted type, Push-turn locking lever type			
Pilot exhaust method		Main/Pilot valve common exhaust			
Lubrication		Not required			
Mounting orientation		Unrestricted			
Impact/Vibration resistance (m/s ²) ^{Note)}		150/30			
Enclosure		Dust proof (* DIN terminal and M8 connector: IP65)			

* Based on IEC60529

Note) Impact resistance: No malfunction occurred when it was tested in the axial direction and at right angles to the main valve and armature in both energized and de-energized states once for each condition. (Default settings)

Vibration resistance: No malfunction occurred in a one-sweep test between 45 and 2000 Hz. Test was performed in both energized and de-energized states in the axial direction and at right angles to the main valve and armature. (Default settings)



Made to Order
(For details, refer to pages 166 to 169.)

Solenoid Specifications

Electrical entry		Grommet (G), (H) L plug connector (L) M plug connector (M)		DIN terminal (D), (Y) M8 connector (W)	
		G, H, L, M, W		D, Y	
Coil rated voltage (V)	DC	24, 12, 6, 5, 3		24, 12	
	AC 50/60 Hz	100, 110, 200, 220			
Allowable voltage fluctuation		±10% of rated voltage *			
Power consumption (W)	DC	Standard	0.35 (With indicator light: 0.4, DIN terminal with indicator light: 0.45)		
		With power saving circuit	0.1 (With indicator light only) * [Starting 0.4, Holding 0.1]		
Apparent power (VA) *	AC	100 V	0.78 (With indicator light: 0.81)	0.78 (With indicator light: 0.87)	
		110 V [115 V]	0.86 (With indicator light: 0.89) [0.94 (With indicator light: 0.97)]	0.86 (With indicator light: 0.97) [0.94 (With indicator light: 1.07)]	
		200 V	1.18 (With indicator light: 1.22)	1.15 (With indicator light: 1.30)	
		220 V [230 V]	1.30 (With indicator light: 1.34) [1.42 (With indicator light: 1.46)]	1.27 (With indicator light: 1.46) [1.39 (With indicator light: 1.60)]	
Surge voltage suppressor		Diode (Varistor is for DIN terminal and non-polar type.)			
Indicator light		LED (AC of DIN connector is neon light.)			

- * Common between 110 VAC and 115 VAC, and between 220 VAC and 230 VAC.
- * For 115 VAC and 230 VAC, the allowable voltage is -15% to +5% of rated voltage.
- * DIN terminal and M8 connector with power saving circuit are not available.
- * For details, refer to page 171.

Response Time

Note) Based on dynamic performance test, JIS B 8375-1981. (Coil temperature: 20°C, at rated voltage)

10-SY3000

Actuation type	Response time (ms) (at the pressure of 0.5 MPa)			
	Without light/surge voltage suppressor	With light/surge voltage suppressor		
		Type S, Z	Type R, U	
2 position single	12 or less	15 or less	12 or less	
2 position double	10 or less	13 or less	10 or less	
3 position	15 or less	20 or less	16 or less	

10-SY5000

Actuation type	Response time (ms) (at the pressure of 0.5 MPa)			
	Without light/surge voltage suppressor	With light/surge voltage suppressor		
		Type S, Z	Type R, U	
2 position single	19 or less	26 or less	19 or less	
2 position double	18 or less	22 or less	18 or less	
3 position	32 or less	38 or less	32 or less	

10-SY7000

Actuation type	Response time (ms) (at the pressure of 0.5 MPa)			
	Without light/surge voltage suppressor	With light/surge voltage suppressor		
		Type S, Z	Type R, U	
2 position single	31 or less	38 or less	33 or less	
2 position double	27 or less	30 or less	28 or less	
3 position	50 or less	56 or less	50 or less	

10-SY9000

Actuation type	Response time (ms) (at the pressure of 0.5 MPa)			
	Without light/surge voltage suppressor	With light/surge voltage suppressor		
		Type S, Z	Type R, U	
2 position single	35 or less	41 or less	35 or less	
2 position double	35 or less	41 or less	35 or less	
3 position	62 or less	64 or less	62 or less	

Directional Control Valves

Air Cylinders

Rotary Actuators

Air Grippers

Air Preparation Equipment

Modular F. R.

Pressure Control Equipment

Fittings & Tubing

Flow Control Equipment

Pressure Switches/Pressure Sensors

Flow Rate Characteristics/Weight

10-SY3000

Valve model	Actuation type	Port size		Flow rate characteristics						Weight (g)		
		1, 5, 3 (P, EA, EB)	4, 2 (A, B)	1→4/2 (P→A/B) C (dm ³ /s(bar))	b	Cv	4/2→5/3 (AB→EA/EB) C (dm ³ /s(bar))	b	Cv	Gro- mmet	L/M plug connector	W M8 connector
10-SY3000 -C-M5	2 position	M5 x 0.8		0.61	0.44	0.16	0.64	0.45	0.18	51	53	57
	Double Closed center			0.48	0.46	0.13	0.47	0.43	0.13			
	3 position			0.47	0.42	0.13	0.47	0.41	0.13	71	76	84
	Exhaust center			0.50	0.48	0.15	0.47	0.43	0.13			
10-SY3000 -C-C4	2 position	M5 x 0.8	C4 ø4 (One-touch fitting)	0.72	0.29	0.18	0.64	0.34	0.17	60	63	67
	Double Closed center			0.59	0.28	0.15	0.59	0.30	0.15			
	3 position			0.63	0.35	0.16	0.42	0.34	0.11	81	86	94
	Exhaust center			0.76	0.42	0.21	0.41	0.37	0.11			
10-SY3000 -C-C6	2 position		C6 ø6 (One-touch fitting)	0.76	0.30	0.19	0.65	0.39	0.17	56	59	63
	Double Closed center			0.76	0.55	0.24	0.60	0.33	0.16	74	79	87
	3 position			0.65	0.32	0.16	0.62	0.31	0.17	77	82	90
	Exhaust center			0.77	0.34	0.21	0.61	0.34	0.16			

Note) []: denotes normal position.

10-SY7000

Valve model	Actuation type	Port size		Flow rate characteristics						Weight (g)		
		1, 5, 3 (P, EA, EB)	4, 2 (A, B)	1→4/2 (P→A/B) C (dm ³ /s(bar))	b	Cv	4/2→5/3 (AB→EA/EB) C (dm ³ /s(bar))	b	Cv	Gro- mmet	L/M plug connector	W M8 connector
10-SY7000 -C-02	2 position	1/4		4.1	0.23	0.93	3.3	0.33	0.81	101	104	125
	Double Closed center			2.9	0.31	0.70	2.4	0.38	0.63	120	125	167
	3 position			2.5	0.39	0.68	3.4	0.35	0.82	128	133	175
	Exhaust center			4.3	0.23	0.97	2.2	0.39	0.58			
10-SY7000 -C-C8	2 position	1/4	C8 ø8 (One-touch fitting)	3.2	0.26	0.77	3.2	0.37	0.82	107	110	131
	Double Closed center			2.6	0.24	0.63	2.4	0.31	0.62	126	132	174
	3 position			2.4	0.25	0.57	2.6	0.42	0.70	134	140	182
	Exhaust center			3.3	0.28	0.78	2.2	0.34	0.60			
10-SY7000 -C-C10	2 position	1/8	C10 ø10 (One-touch fitting)	3.8	0.26	0.86	3.2	0.34	0.82	103	105	126
	Double Closed center			2.8	0.27	0.67	2.4	0.21	0.59	122	127	169
	3 position			2.5	0.25	0.58	2.7	0.38	0.70	130	135	177
	Exhaust center			3.8	0.25	0.89	2.3	0.38	0.61			

Note) []: denotes normal position.

10-SY5000

Valve model	Actuation type	Port size		Flow rate characteristics						Weight (g)		
		1, 5, 3 (P, EA, EB)	4, 2 (A, B)	1→4/2 (P→A/B) C (dm ³ /s(bar))	b	Cv	4/2→5/3 (AB→EA/EB) C (dm ³ /s(bar))	b	Cv	Gro- mmet	L/M plug connector	W M8 connector
10-SY5000 -C-01	2 position	1/8		1.9	0.35	0.49	2.4	0.39	0.61	70	72	93
	Double Closed center			1.7	0.43	0.45	1.8	0.35	0.46	88	93	135
	3 position			1.5	0.44	0.41	2.5	0.32	0.59	93	98	140
	Exhaust center			2.2	0.46	0.61	1.8	0.38	0.46			
10-SY5000 -C-C4	2 position	1/8	C4 ø4 (One-touch fitting)	0.75	0.43	0.20	0.85	0.64	0.30	94	96	117
	Double Closed center			0.74	0.40	0.19	0.84	0.57	0.28	111	117	159
	3 position			0.75	0.36	0.19	0.84	0.64	0.30	117	122	164
	Exhaust center			0.78	0.44	0.21	0.84	0.57	0.27			
10-SY5000 -C-C6	2 position		C6 ø6 (One-touch fitting)	1.5	0.33	0.33	2.0	0.37	0.52	88	91	112
	Double Closed center			1.3	0.31	0.33	1.6	0.32	0.39	106	111	153
	3 position			1.3	0.33	0.33	1.8	0.35	0.44	111	116	158
	Exhaust center			1.7	0.31	0.42	1.7	0.33	0.44			
10-SY5000 -C-C8	2 position		C8 ø8 (One-touch fitting)	1.9	0.21	0.45	2.3	0.29	0.57	80	82	103
	Double Closed center			1.6	0.29	0.39	1.7	0.38	0.46	98	103	145
	3 position			1.4	0.38	0.39	2.0	0.37	0.52	103	108	150
	Exhaust center			2.2	0.32	0.56	1.8	0.41	0.50			

Note) []: denotes normal position.

10-SY9000

Valve model	Actuation type	Port size		Flow rate characteristics						Weight (g)		
		1, 5, 3 (P, EA, EB)	4, 2 (A, B)	1→4/2 (P→A/B) C (dm ³ /s(bar))	b	Cv	4/2→5/3 (AB→EA/EB) C (dm ³ /s(bar))	b	Cv	Gro- mmet	L/M plug connector	W M8 connector
10-SY9000 -C-02	2 position	1/4		7.0	0.33	1.7	7.6	0.35	2.0	241	244	265
	Double Closed center			6.7	0.37	1.7	6.4	0.34	1.6	260	266	308
	3 position			6.4	0.36	1.6	8.3	0.41	2.2	284	290	332
	Exhaust center			8.0	0.27	1.8	6.5	0.22	1.4			
10-SY9000 -C-03	2 position	3/8		8.0	0.29	1.9	8.0	0.33	2.0	236	239	260
	Double Closed center			7.9	0.33	1.9	6.6	0.27	1.6	255	261	303
	3 position			8.0	0.33	1.9	8.7	0.34	2.2	279	285	327
	Exhaust center			8.9	0.34	2.2	6.5	0.25	1.5			
10-SY9000 -C-C8	2 position	1/4	C8 ø8 (One-touch fitting)	4.3	0.28	0.96	7.1	0.32	1.7	293	296	317
	Double Closed center			4.3	0.31	0.99	6.1	0.28	1.4	312	318	360
	3 position			4.3	0.3	0.98	7.4	0.36	1.9	336	342	384
	Exhaust center			4.4	0.35	1.0	2.1	0.41	0.53			
10-SY9000 -C-C10	2 position	1/8	C10 ø10 (One-touch fitting)	6.1	0.28	1.4	7.9	0.33	1.9	279	282	303
	Double Closed center			5.9	0.30	1.4	6.5	0.26	1.5	298	304	346
	3 position			5.8	0.25	1.3	8.4	0.33	2.0	322	328	370
	Exhaust center			6.3	0.29	1.5	6.4	0.25	1.5			
10-SY9000 -C-C12	2 position		C12 ø12 (One-touch fitting)	7.0	0.25	1.6	8.6	0.41	2.2	265	268	289
	Double Closed center			6.9	0.24	1.6	7.0	0.33	1.7	284	290	332
	3 position			6.6	0.23	1.4	9.4	0.48	2.6	308	314	356
	Exhaust center			7.4	0.25	1.7	6.6	0.23	1.5			

Note) []: denotes normal position.

Dimensions: Series 10-SY3000

[] : AC

2 position single

Grommet (G), (H): 10-SY3120-□^G□□-C₄, N₃(-F2)

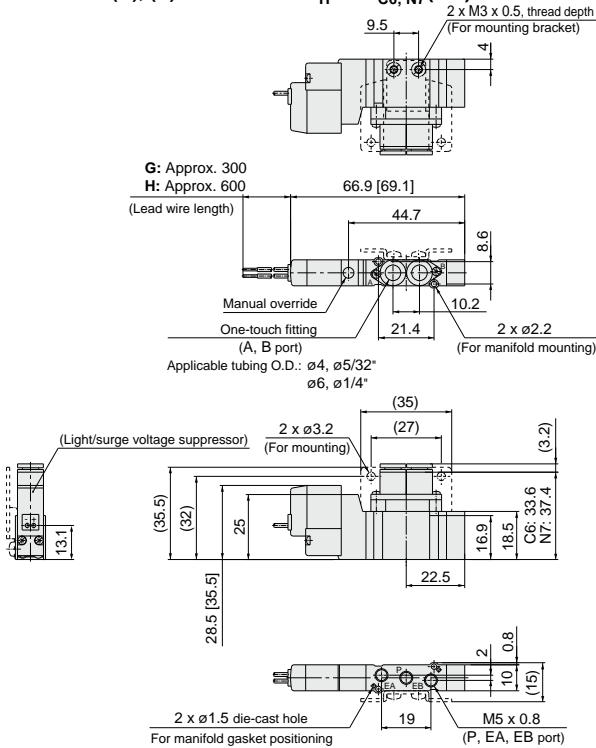

Foot bracket

10-SY3120-□^G□□-C₄, N₃-F1

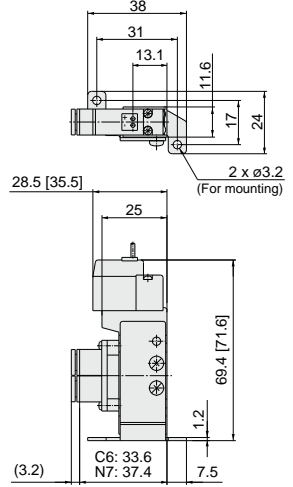

10-SY3120-□^G□□-M5(-F2)

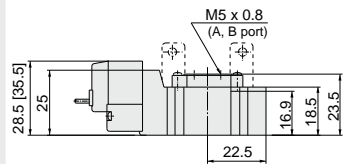

L plug connector (L):

10-SY3120-□□□□-C₄, N₃(-F2)

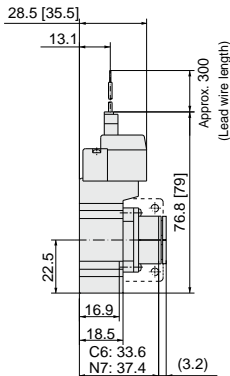

M plug connector (M):

10-SY3120-□□□□-C₄, N₃(-F2)

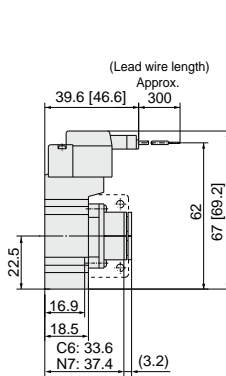

M8 connector (WO):

10-SY3120-□WO□□□□-C₄, N₃(-F2)

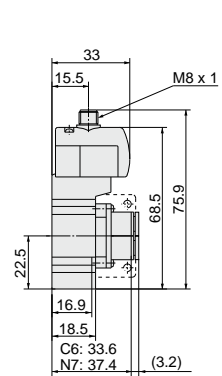

Note) Refer to page 176 for dimensions of connector types.

Directional Control Valves

Air Cylinders

Rotary Actuators

Air Grippers

Air Preparation Equipment

Modular F. R.

Pressure Control Equipment

Fittings & Tubing

Flow Control Equipment

Pressure Switches/ Pressure Sensors

Dimensions: Series 10-SY3000

[]: AC

2 position double

Grommet (G), (H): 10-SY3220-□G□□-C4, N3, C6, N7(-F2)

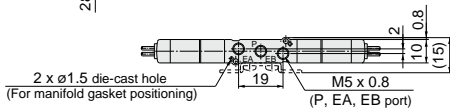
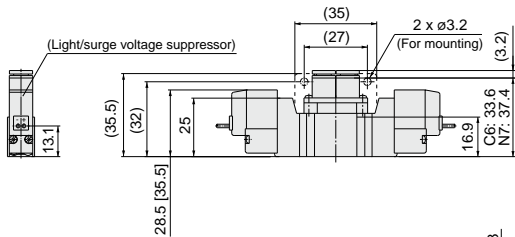
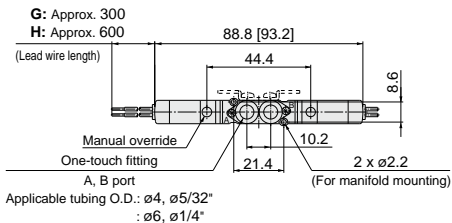
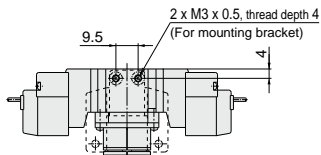

10-SY3220-□G□□-M5(-F2)

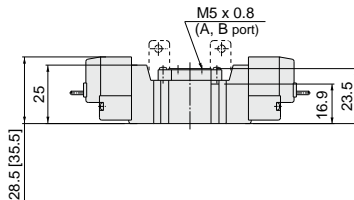

L plug connector (L):
10-SY3220-□L□□-C4, N3, C6, N7(-F2)

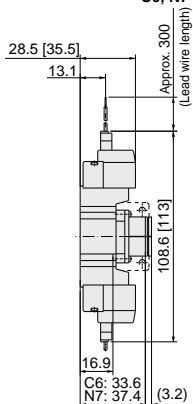

M plug connector (M):
10-SY3220-□M□□-C4, N3, C6, N7(-F2)

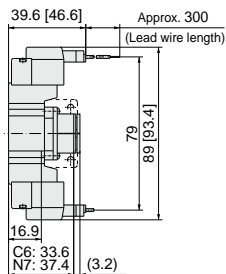

M8 connector (WO):
10-SY3220-WO□□-C4, N3, C6, N7(-F2)

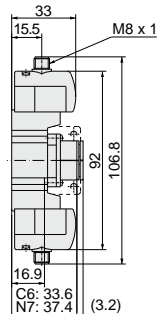

Note) Refer to page 176 for dimensions of connector types.

Dimensions: Series 10-SY3000

[]: AC

3 position closed center / exhaust center / pressure center

Grommet (G), (H): 10-SY3 $\frac{3}{8}$ 20-□G□□-C4, N3 (-F2)

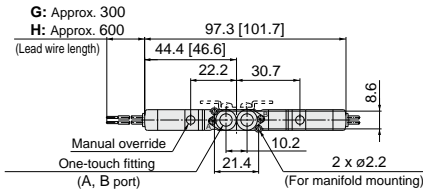
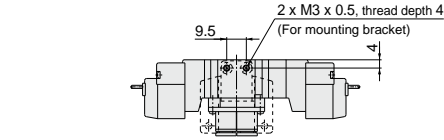

Applicable tubing O.D.: ø4, ø5/32"
: ø6, ø1/4"

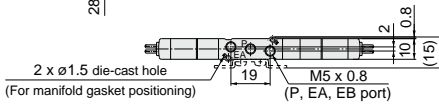
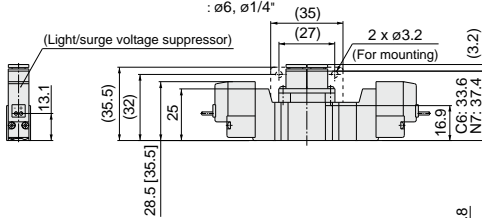

10-SY3 $\frac{3}{8}$ 20-□H□□-M5(-F2)

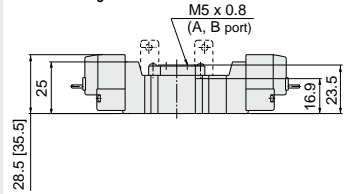

L plug connector (L):

10-SY3 $\frac{3}{8}$ 20-□L□□-C4, N3 (-F2)

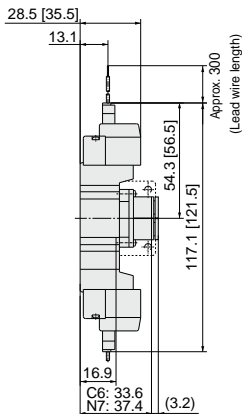

M plug connector (M):

10-SY3 $\frac{3}{8}$ 20-□M□□-C4, N3 (-F2)

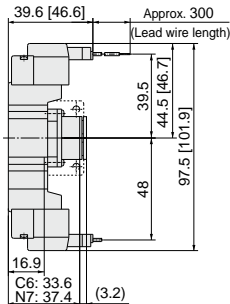

M8 connector (WO):

10-SY3 $\frac{3}{8}$ 20-□WO□□-C4, N3 (-F2)

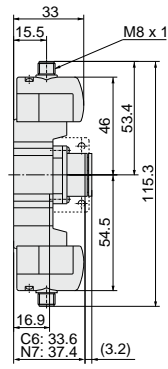

(Note) Refer to page 176 for dimensions of connector types.

Directional Control Valves

Air Cylinders

Rotary Actuators

Air Grippers

Air Preparation Equipment

Modular F. R.

Pressure Control Equipment

Fittings & Tubing

Flow Control Equipment

Pressure Switches/ Pressure Sensors

Dimensions: Series 10-SY5000

[] : AC

2 position single

Grommet (G), (H): 10-SY5120-□_G□_H□_{C4, N3}□_{C6, N7}□_{C8, N9}□(-F2)

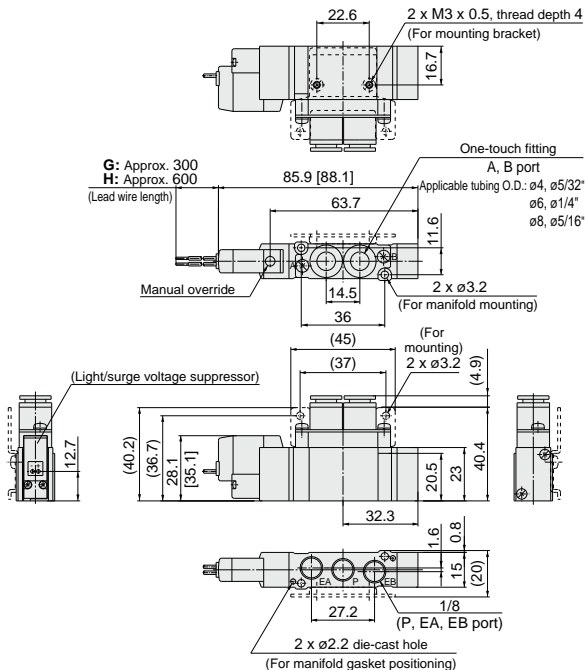

Foot bracket

10-SY5120-□_G□_H□_{C4, N3}□_{C6, N7}□_{C8, N9}□-F1

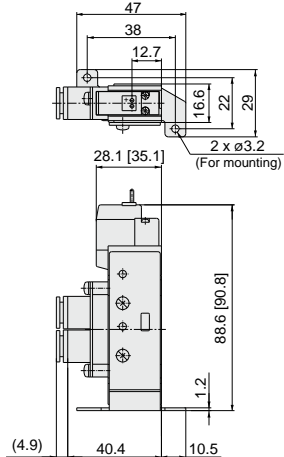

10-SY5120-□_G□_H□-01□(-F2)

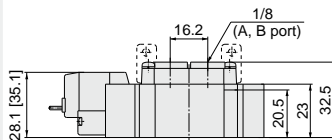

L plug connector (L):

10-SY5120-□□□_{C4, N3}□_{C6, N7}□(-F2)

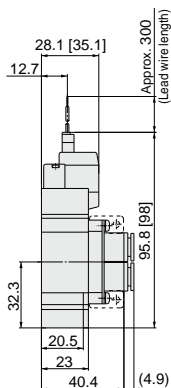

M plug connector (M):

10-SY5120-□□□_{C4, N3}□_{C6, N7}□(-F2)

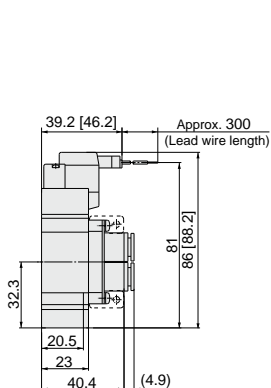

DIN terminal (D, Y):

10-SY5120-□□□_{C4, N3}□_{C6, N7}□(-F2)

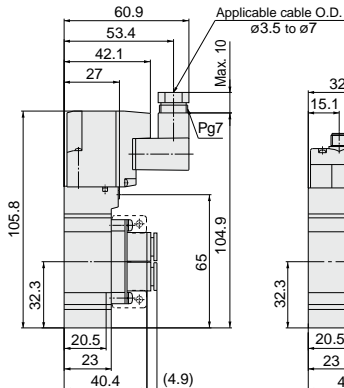

M8 connector (WO):

10-SY5120-□WO□□_{C4, N3}□_{C6, N7}□(-F2)

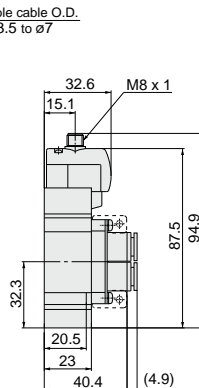

Note) Refer to page 176 for dimensions of connector types.

Dimensions: Series 10-SY7000

[] : AC

2 position single

Grommet (G), (H): 10-SY7120-□G□□-C8, N9 C10, N11 □(-F2)

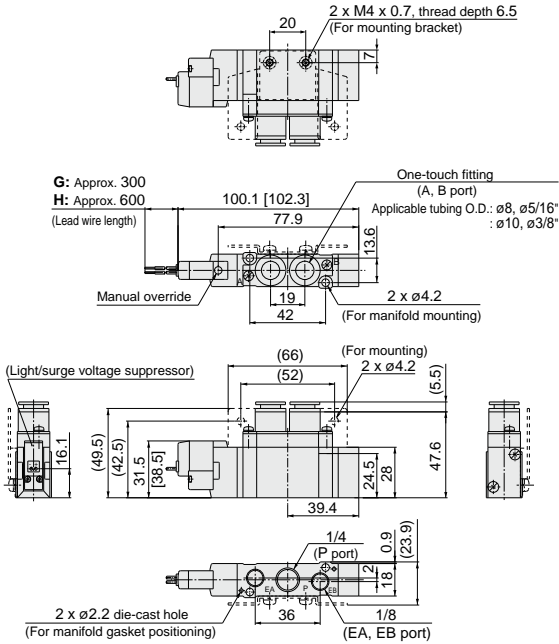

10-SY7120-□G□□-C8, N9 C10, N11 □(-F1)

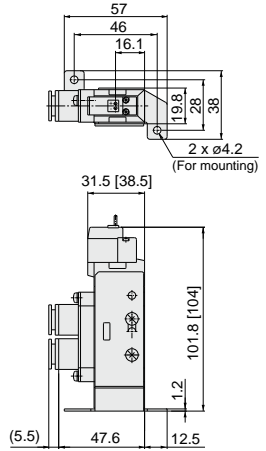

10-SY7120-□G□□-02□(-F2)

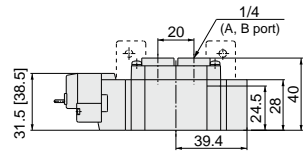

L plug connector (L):

10-SY7120-□□□□-C8, N9 C10, N11 □(-F2)

M plug connector (M):

10-SY7120-□□□□-C8, N9 C10, N11 □(-F2)

DIN terminal (D, Y):

10-SY7120-□□□□-C8, N9 C10, N11 □(-F2)

M8 connector (WO):

10-SY7120-□WO□□-C8, N9 C10, N11 □(-F2)

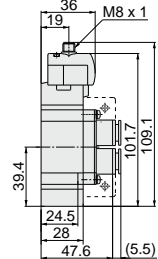
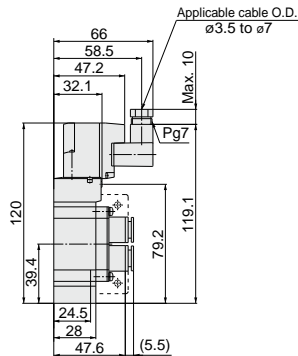
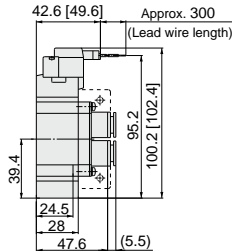
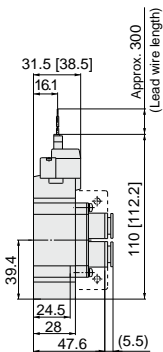

(Note) Refer to page 176 for dimensions of connector types.

Dimensions: Series 10-SY7000

[]: AC

2 position double

Grommet (G), (H): 10-SY7220-□G□□-C8, N9 C10, N11 □(-F2)

10-SY7220-□G□□-02□(-F2)

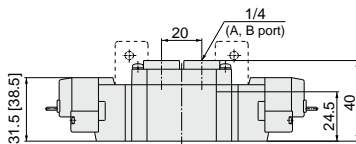
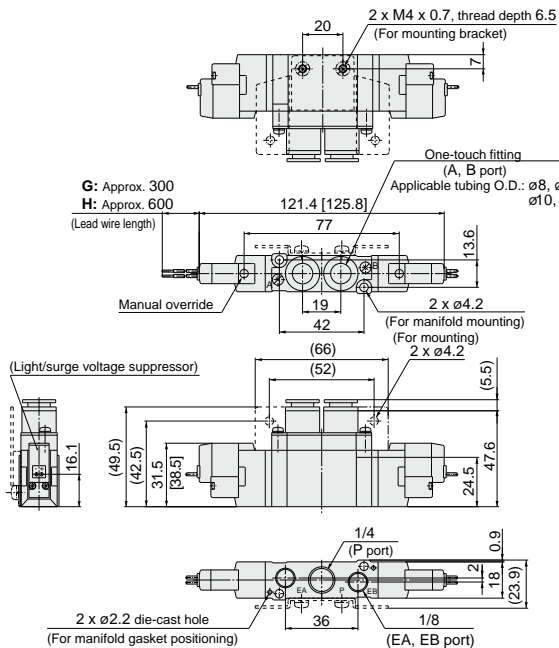

L plug connector (L):

10-SY7220-□L□□-C8, N9 C10, N11 □(-F2)

M plug connector (M):

10-SY7220-□M□□-C8, N9 C10, N11 □(-F2)

DIN terminal (D, Y):

10-SY7220-□D□□-C8, N9 C10, N11 □(-F2)

M8 connector (WO):

10-SY7220-□WO□□-C8, N9 C10, N11 □(-F2)

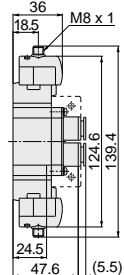
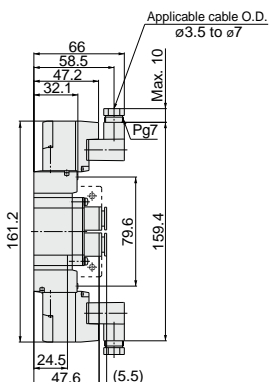
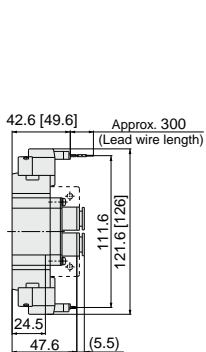
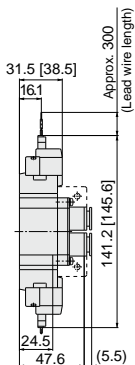

Note) Refer to page 176 for dimensions of connector types.

Dimensions: Series 10-SY7000

[] : AC

3 position closed center / exhaust center / pressure center
Grommet (G), (H): 10-SY7³/₅20-□G□□-C8, N9
C10, N11□(-F2)

10-SY7³/₅20-□H□□-02□(-F2)

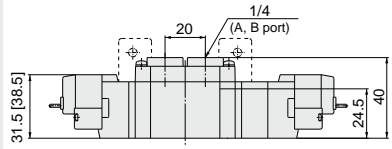
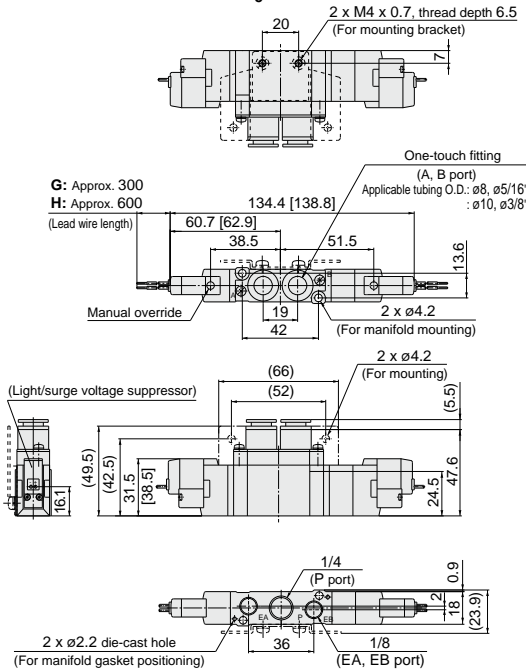

L plug connector (L):

M plug connector (M):

DIN terminal (D, Y):

M8 connector (WO):

10-SY7³/₅20-□L□□-C8, N9
C10, N11□(-F2)

10-SY7³/₅20-□M□□-C8, N9
C10, N11□(-F2)

10-SY7³/₅20-□D□□-C8, N9
C10, N11□(-F2)

10-SY7³/₅20-□WO□□-C8, N9
C10, N11□(-F2)

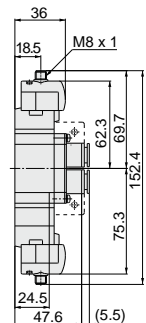
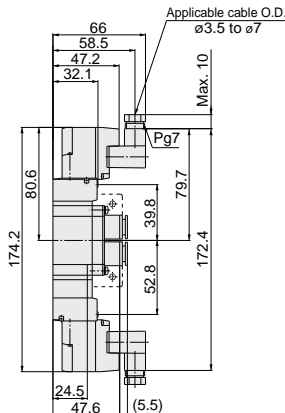
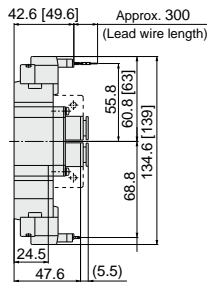
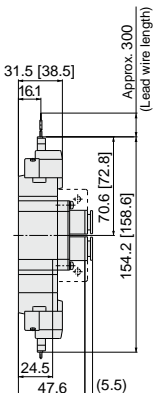

Note) Refer to page 176 for dimensions of connector types.

Directional Control Valves
Air Cylinders
Rotary Actuators
Air Grippers
Air Preparation Equipment
Modular F. R.
Pressure Control Equipment
Fittings & Tubing
Flow Control Equipment
Pressure Switches/ Pressure Sensors

Dimensions: Series 10-SY9000

[] : AC

2 position single

Grommet (G), (H): 10-SY9120-□G□□□□ C8, N9
C10, N11□ C12

10-SY9120-□G□□□□ 02□
03□

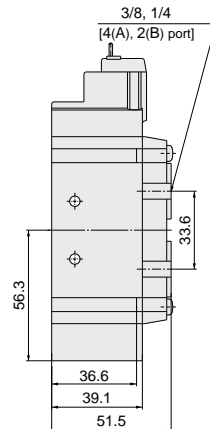
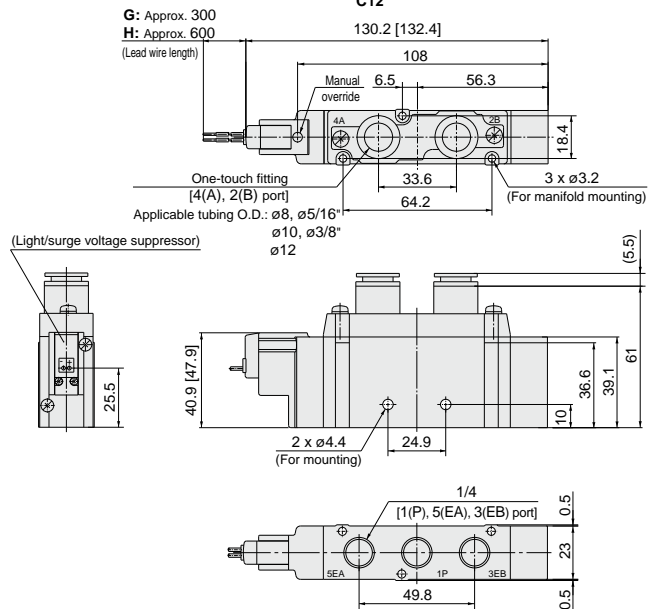

L plug connector (L):
10-SY9120-□L□□□□ C8, N9
C10, N11□ C12

M plug connector (M):
10-SY9120-□M□□□□ C8, N9
C10, N11□ C12

DIN terminal (D, Y):
10-SY9120-□D□□□□ C8, N9
C10, N11□ C12

M8 connector (WO):
10-SY9120-□WO□□□□ C8, N9
C10, N11□ C12

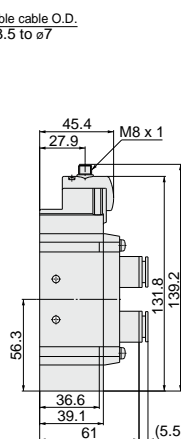
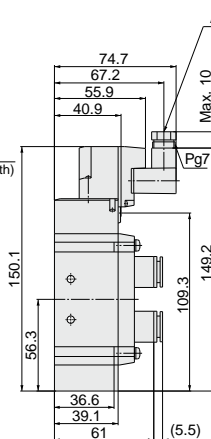
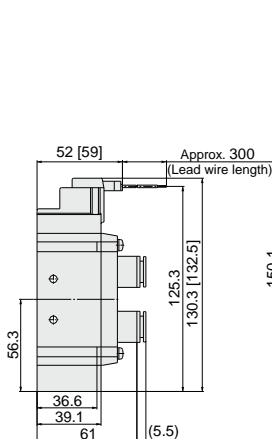
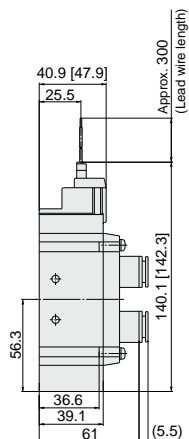

Note) Refer to page 176 for dimensions of connector types.

Dimensions: Series 10-SY9000

[] : AC

2 position double

Grommet (G), (H): 10-SY9220-□G□□□C8, N9□□C10, N11□□C12

G: Approx. 300
H: Approx. 600

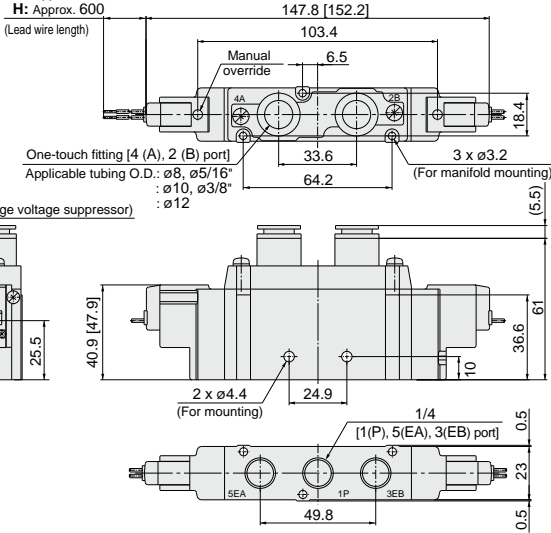

10-SY9220-□G□□□□□02□□03□□

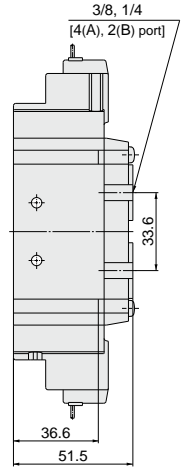

L plug connector (L):

10-SY9220-□L□□□□□C8, N9□□C10, N11□□C12

M plug connector (M):

10-SY9220-□M□□□□□C8, N9□□C10, N11□□C12

DIN terminal (D), Y):

10-SY9220-□D□□□□□C8, N9□□C10, N11□□C12

M8 connector (WO):

10-SY9220-□WO□□□□□C8, N9□□C10, N11□□C12

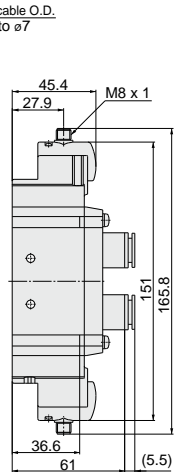
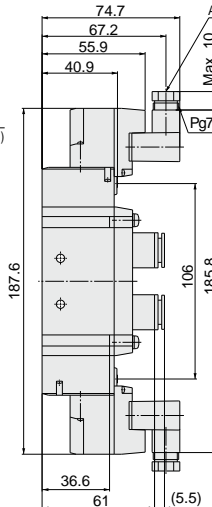
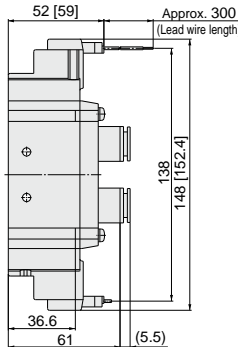
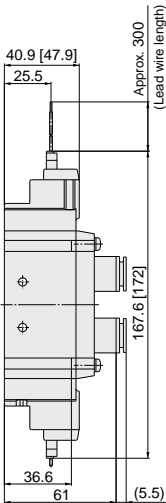

Note) Refer to page 176 for dimensions of connector types.

Directional Control Valves
Air Cylinders
Rotary Actuators
Air Grippers
Air Preparation Equipment
Modular F. R.
Pressure Control Equipment
Fittings & Tubing
Flow Control Equipment
Pressure Switches/ Pressure Sensors

Dimensions: Series 10-SY9000

[]: AC

3 position closed center / exhaust center / pressure center

Grommet (G), (H): 10-SY9³/₅20-□^G□□-^{C8, N9}□□□□-^{C10, N11}□□^{C12}

G: Approx. 300
H: Approx. 600
(Lead wire length)

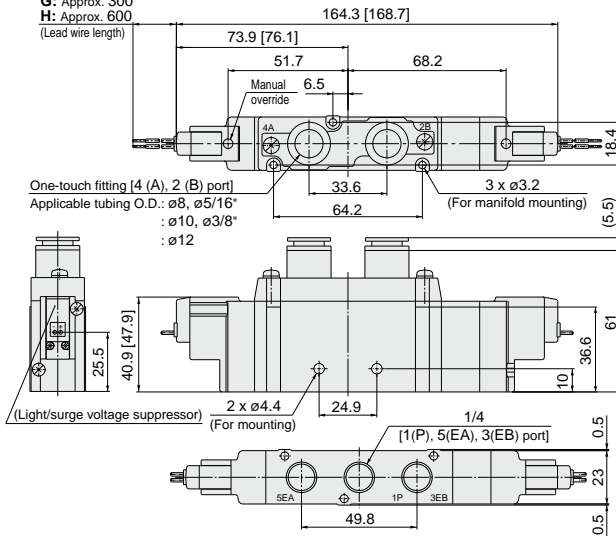

10-SY9³/₅20-□^G□□-^{C8, N9}□□□□-^{C10, N11}□□^{C12}

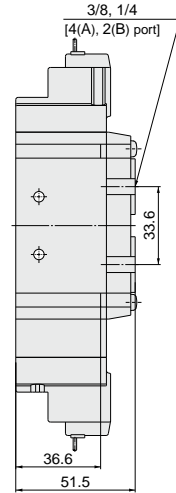

L plug connector (L):

10-SY9³/₅20-□□□□-^{C8, N9}□□□□-^{C10, N11}□□□□-^{C12}

M plug connector (M):

10-SY9³/₅20-□□□□-^{C8, N9}□□□□-^{C10, N11}□□□□-^{C12}

DIN terminal (D, Y):

10-SY9³/₅20-□□□□-^{C8, N9}□□□□-^{C10, N11}□□□□-^{C12}

M8 connector (WO):

10-SY9³/₅20-□□□□-^{C8, N9}□□□□-^{C10, N11}□□□□-^{C12}

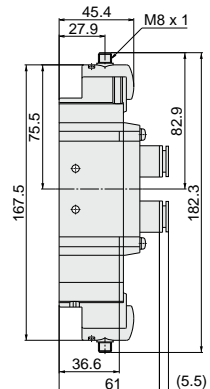
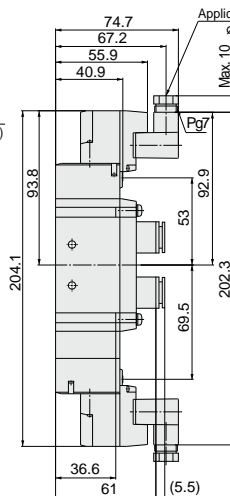
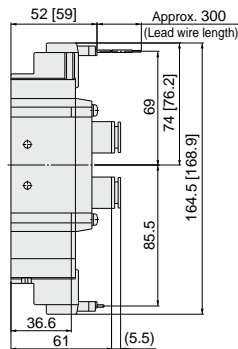
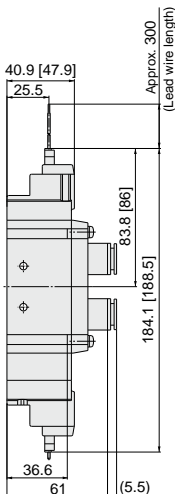

Note) Refer to page 176 for dimensions of connector types.

Series 10-SY3000/5000/7000/9000

5 Port Solenoid Valve
Base Mounted/Single Unit



[Option]
Note) AC-type models that are CE-compliant have DIN terminals only.

How to Order

10 - SY 5 2 40 [] - 5 L [] - [] - [] - []

• Clean series
Series

3	10-SY3000
5	10-SY5000
7	10-SY7000
9	10-SY9000

• Actuation type

1	2 position single (A)4 2(B) (EA)5 1 3(EB) (P)
2	2 position double (A)4 2(B) (EA)5 1 3(EB) (P)
3	3 position closed center (A)4 2(B) (EA)5 1 3(EB) (P)
4	3 position exhaust center (A)4 2(B) (EA)5 1 3(EB) (P)
5	3 position pressure center (A)4 2(B) (EA)5 1 3(EB) (P)

Note) For details about Symbol of the 3 position type 10-SY9000 series, refer to the SY series of the WEB catalog.

• Pilot type

Nil	Internal pilot
R	External pilot*

* External pilot specifications for 10-SY3000 DIN terminal are not available.

• Coil type

Nil	Standard
T	With power saving circuit (24, 12V DC only)

* Power saving circuit is not available for D, Y, DO, YO or W□ types.

• Rated voltage

For DC	
5	24 VDC
6	12 VDC
V	6 VDC
S	5 VDC
R	3 VDC

• For AC (50/60 Hz)

1	100 VAC
2	200 VAC
3	110 VAC [115 VAC]
4	220 VAC [230 VAC]

* DC specifications of type D, Y, DO and YO are only available with 12 and 24 VDC.
* For type W□, only DC voltage is available.

• Port size

Symbol	Port size	Applicable series
Nil	Without sub-plate	
01	1/8 With sub-plate	10-SY3000
02	1/4 With sub-plate	10-SY5000 10-SY7000
03	3/8 With sub-plate	10-SY7000 10-SY9000
04	1/2 With sub-plate	10-SY9000

• Thread type

Nil	Rc
F	G
N	NPT
T	NPTF

• Made to Order

Nil	—
X90	Main valve fluororubber (Refer to page 169.)

• Manual override

Nil: Non-locking push type

D: Push-turn locking slotted type

E: Push-turn locking lever type

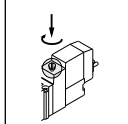
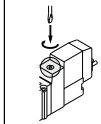
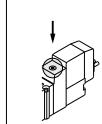

• CE-compliant

Nil	—
Q	CE-compliant

Note) AC-type models that are CE-compliant have DIN terminals only.

• Light/Surge voltage suppressor

Electrical entry for G, H, L, M, W

Nil	Without light/surge voltage suppressor
S	With surge voltage suppressor
Z	With light/surge voltage suppressor
R	With surge voltage suppressor (Non-polar type)
U	With light/surge voltage suppressor (Non-polar type)

* For AC voltage valves there is no "S" option. It is already built into the rectifier circuit.
* For "R" and "U", only DC voltage is available.
* Power saving circuit is only available for the "Z" type.

Electrical entry for D, Y

Nil	Without light/surge voltage suppressor
S	With surge voltage suppressor (Non-polar type)
Z	With light/surge voltage suppressor (Non-polar type)

* DOZ and YOZ are not available.
* For AC voltage valves there is no "S" option. It is already built into the rectifier circuit.

• Electrical entry

	24, 12, 6, 5, 3 VDC / 100, 110, 200, 220 VAC	24, 12 VDC / 100, 110, 200, 220 VAC	24, 12, 6, 5, 3 VDC
	Grommet	L plug connector	M plug connector
	D, Y: With connector	DIN terminal	M8 connector
	WO: Without connector cable		
	H: Lead wire length 300 mm	L: With lead wire (Length 300 mm)	M: With lead wire (Length 300 mm)
	LN: Without lead wire	LO: Without connector	MO: Without connector
		DO, YO: Without connector	W□: With connector cable (Noise)
CE-compliant	DC	AC	AC

* LN, MN type: With 2 sockets.

* The DIN terminal of the 10-SY3000 series cannot be mounted on the standard sub-plate. For details, refer to page 174.

* "Y" type is a DIN terminal conforming to EN-175301-803C (former DIN43650C). For details, refer to page 173.

* For connector cable of M8 connector, refer to page 176.

* M8 connector conforming to IEC60947-5-2 standard is also available. Refer to page 168 for details.

* Refer to page 173 for the lead wire length of L and M plug connectors.

* Refer to page 174 for the connector assembly with cover for L and M plug connectors.

Note) Enter the cable length symbols in □. Please be sure to fill in the blank referring to page 176.

Note) When ordering a single unit of the base mounted type solenoid valve, the mounting screws and gasket for the manifold are included.

Directional Control Valves

Air Cylinders

Rotary Actuators

Air Grippers

Air Preparation Equipment

Modular F. R.

Pressure Control Equipment

Fittings & Tubing

Flow Control Equipment

Pressure Switches/Pressure Sensors

Specifications



Made to Order
(For details, refer to pages 166 to 169.)

Series	10-SY3000	10-SY5000	10-SY7000	10-SY9000
Fluid	Air			
Internal pilot operating pressure range (MPa)	2 position single		0.15 to 0.7	
	2 position double		0.1 to 0.7	
	3 position		0.2 to 0.7	
External pilot operating pressure range (MPa)	Operating pressure range			
	Pilot pressure range	2 position single		
		2 position double		
	3 position			0.25 to 0.7
	2 position double			0.25 to 0.7
	3 position			0.25 to 0.7
Ambient and fluid temperature (°C)	-10 to 50 (No freezing.)			
Max. operating frequency (Hz)	2 position single, double		10	5
	3 position		3	3
Manual override (Manual operation)	Non-locking push type, Push-turn locking slotted type, Push-turn locking lever type			
Pilot exhaust method	Internal pilot		Main/Pilot valve common exhaust	
	External pilot		Pilot valve individual exhaust	
Lubrication	Not required			
Mounting orientation	Unrestricted			
Impact/Vibration resistance (m/s ²) ^{Note)}	150/30			
Enclosure	Dust proof (* DIN terminal and M8 connector: IP65)			

* Based on IEC60529

Note) Impact resistance: No malfunction occurred when it was tested in the axial direction and at right angles to the main valve and armature in both energized and de-energized states once for each condition. (Default settings)

Vibration resistance: No malfunction occurred in a one-sweep test between 45 and 2000 Hz. Test was performed in both energized and de-energized states in the axial direction and at right angles to the main valve and armature. (Default settings)

Response Time

Note) Based on dynamic performance test, JIS B 8375-1981. (Coil temperature: 20°C, at rated voltage)

10-SY3000

Actuation type	Response time (ms) (at the pressure of 0.5 MPa)		
	Without light/surge voltage suppressor	With light/surge voltage suppressor Type S, Z	Type R, U
2 position single	12 or less	15 or less	12 or less
2 position double	10 or less	13 or less	10 or less
3 position	15 or less	20 or less	16 or less

10-SY5000

Actuation type	Response time (ms) (at the pressure of 0.5 MPa)		
	Without light/surge voltage suppressor	With light/surge voltage suppressor Type S, Z	Type R, U
2 position single	19 or less	26 or less	19 or less
2 position double	18 or less	22 or less	18 or less
3 position	32 or less	38 or less	32 or less

10-SY7000

Actuation type	Response time (ms) (at the pressure of 0.5 MPa)		
	Without light/surge voltage suppressor	With light/surge voltage suppressor Type S, Z	Type R, U
2 position single	31 or less	38 or less	33 or less
2 position double	27 or less	30 or less	28 or less
3 position	50 or less	56 or less	50 or less

10-SY9000

Actuation type	Response time (ms) (at the pressure of 0.5 MPa)		
	Without light/surge voltage suppressor	With light/surge voltage suppressor Type S, Z	Type R, U
2 position single	35 or less	41 or less	35 or less
2 position double	35 or less	41 or less	35 or less
3 position	62 or less	64 or less	62 or less

Solenoid Specifications

Electrical entry	Grommet (G), (H) L plug connector (L) M plug connector (M)		DIN terminal (D), (Y) M8 connector (W)	
	G, H, L, M, W		D, Y	
Coil rated voltage (V)	DC	24, 12, 6, 5, 3		
	AC 50/60 Hz	100, 110, 200, 220		
Allowable voltage fluctuation	±10% of rated voltage *			
Power consumption (W)	DC	Standard	0.35 (With indicator light: 0.4, DIN terminal with indicator light: 0.45)	
		With power saving circuit	0.1 (With indicator light only) * [Starting 0.4, Holding 0.1]	
Apparent power (VA) *	AC	100 V	0.78 (With indicator light: 0.81)	0.78 (With indicator light: 0.87)
		110 V [115 V]	0.86 (With indicator light: 0.89)	0.86 (With indicator light: 0.97)
		200 V	1.18 (With indicator light: 1.22)	1.15 (With indicator light: 1.30)
		220 V [230 V]	1.30 (With indicator light: 1.34)	1.27 (With indicator light: 1.46)
		1.42 (With indicator light: 1.46)	1.39 (With indicator light: 1.60)	
Surge voltage suppressor	Diode (Varistor is for DIN terminal and non-polar type.)			
Indicator light	LED (AC of DIN connector is neon light.)			

* Common between 110 VAC and 115 VAC, and between 220 VAC and 230 VAC.

* For 115 VAC and 230 VAC, the allowable voltage is -15% to +5% of rated voltage.

* DIN terminal and M8 connector with power saving circuit are not available.

* For details, refer to page 171.

Flow Rate Characteristics/Weight

10-SY3000

Valve model	Actuation type		Port size	Flow rate characteristics <small>Note 1)</small>						Weight (g) <small>Note 2)</small>		
				1 → 4/2 (P → A/B)			4/2 → 5/3 (A/B → EA/EB)			Grommet	L plug connector, M plug connector	W M8 connector
				C (dm ³ /s·bar)	b	Cv	C (dm ³ /s·bar)	b	Cv			
10-SY3□40-□-01	2 position	Single	1/8	1.0	0.30	0.24	1.1	0.30	0.26	84 (50)	85 (53)	89 (57)
		Double		0.77	0.28	0.18	0.85	0.30	0.19	102 (68)	107 (73)	115 (81)
	Closed center	0.73		0.31	0.18	1.1	0.26	0.24	104 (69)	109 (74)	117 (82)	
	Exhaust center	1.2		0.24	0.29	[0.55]	[0.52]	[0.16]				
	Pressure center	[0.51]		[0.45]	[0.14]	0.89	0.47	0.24				

Note 1) []: denotes normal position. Note 2) (): denotes without sub-plate.

10-SY5000

Valve model	Actuation type		Port size	Flow rate characteristics <small>Note 1)</small>						Weight (g) <small>Note 2)</small>			
				1 → 4/2 (P → A/B)			4/2 → 5/3 (A/B → EA/EB)			Grommet	L plug connector, M plug connector	DIN terminal	W M8 connector
				C (dm ³ /s·bar)	b	Cv	C (dm ³ /s·bar)	b	Cv				
10-SY5□40-□-02	2 position	Single	1/4	2.4	0.41	0.64	2.8	0.29	0.66	121 (58)	123 (61)	154 (92)	127 (65)
		Double		1.8	0.47	0.50	1.8	0.40	0.47	139 (76)	144 (81)	186 (123)	152 (89)
	Closed center	1.4		0.55	0.44	3.0	0.33	0.72	144 (82)	150 (87)	192 (129)	158 (95)	
	Exhaust center	[1.2]		[0.48]	[0.37]								
	Pressure center	[0.84]		[0.60]	[0.28]	1.8	0.40	0.48					

Note 1) []: denotes normal position. Note 2) (): denotes without sub-plate.

10-SY7000

Valve model	Actuation type		Port size	Flow rate characteristics <small>Note 1)</small>						Weight (g) <small>Note 2)</small>			
				1 → 4/2 (P → A/B)			4/2 → 5/3 (A/B → EA/EB)			Grommet	L plug connector, M plug connector	DIN terminal	W M8 connector
				C (dm ³ /s·bar)	b	Cv	C (dm ³ /s·bar)	b	Cv				
10-SY7□40-□-02	2 position	Single	1/4	4.1	0.41	1.1	4.1	0.29	1.0	218 (89)	221 (92)	242 (113)	225 (96)
		Double		3.0	0.43	0.80	2.6	0.41	0.72	237 (108)	242 (113)	284 (155)	250 (121)
	Closed center	2.6		0.42	0.71	4.7	0.35	1.1	239 (110)	245 (116)	287 (158)	253 (124)	
	Exhaust center	[1.7]		[0.48]	[0.49]								
	Pressure center	[2.3]		[0.49]	[0.65]	2.2	0.49	0.63					
10-SY7□40-□-03	2 position	Single	3/8	4.9	0.29	1.2	4.5	0.27	1.1	218 (89)	221 (92)	242 (113)	225 (96)
		Double		3.0	0.40	0.80	2.6	0.45	0.73	237 (108)	242 (113)	284 (155)	250 (121)
	Closed center	2.6		0.42	0.71	4.8	0.35	1.3	239 (110)	245 (116)	287 (158)	253 (124)	
	Exhaust center	[1.7]		[0.48]	[0.49]								
	Pressure center	[2.3]		[0.51]	[0.64]	2.3	0.45	0.66					

Note 1) []: denotes normal position. Note 2) (): denotes without sub-plate.

10-SY9000

Valve model	Actuation type		Port size	Flow rate characteristics <small>Note 1)</small>						Weight (g) <small>Note 2)</small>			
				1 → 4/2 (P → A/B)			4/2 → 5/3 (A/B → EA/EB)			Grommet	L plug connector, M plug connector	DIN terminal	W M8 connector
				C (dm ³ /s·bar)	b	Cv	C (dm ³ /s·bar)	b	Cv				
10-SY9□40-□-03	2 position	Single	3/8	7.9	0.34	2.0	9.6	0.43	2.6	469 (172)	472 (175)	493 (196)	476 (179)
		Double		7.5	0.33	1.8	7.3	0.30	1.7	488 (191)	494 (197)	535 (239)	502 (205)
	Closed center	7.2		0.34	1.7	13	0.23	2.8	512 (215)	518 (221)	560 (263)	526 (229)	
	Exhaust center	[4.0]		[0.41]	[0.95]								
	Pressure center	[3.3]		[0.41]	[0.84]	6.7	0.40	1.9					
10-SY9□40-□-04	2 position	Single	1/2	8.0	0.48	2.2	10	0.29	2.5	448 (172)	453 (175)	472	457 (179)
		Double		7.6	0.32	1.8	7.3	0.32	1.8	467 (191)	473 (197)	515	481 (205)
	Closed center	7.3		0.42	2.0	13	0.32	3.6	491 (215)	497 (221)	539	505 (229)	
	Exhaust center	[4.7]		[0.54]	[1.5]								
	Pressure center	[3.2]		[0.51]	[0.94]	7.4	0.33	1.9					

Note 1) []: denotes normal position. Note 2) (): denotes without sub-plate.

Directional Control Valves
 Air Cylinders
 Rotary Actuators
 Air Grippers
 Air Preparation Equipment
 Modular F. R.
 Pressure Control Equipment
 Fittings & Tubing
 Flow Control Equipment
 Pressure Switches/ Pressure Sensors

Dimensions: Series 10-SY3000

[] : AC

2 position single

Grommet (G), (H): 10-SY3140(R)-□^G□□-01□

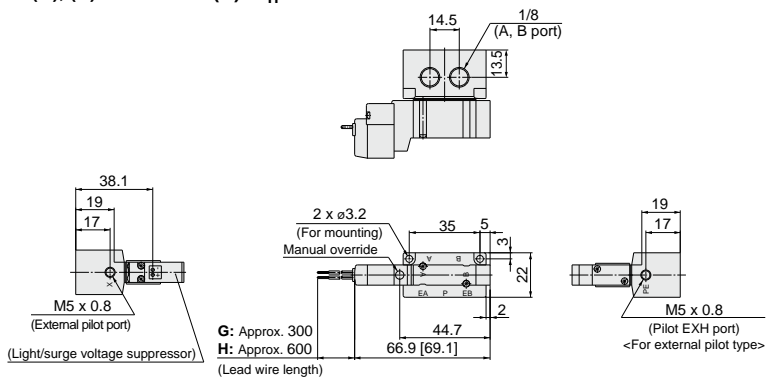

L plug connector (L):
 10-SY3140(R)-□L□□-01□

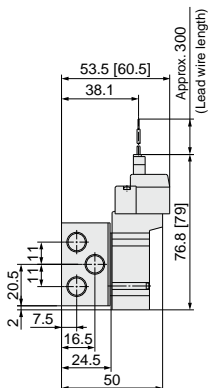

M plug connector (M):
 10-SY3140(R)-□M□□-01□

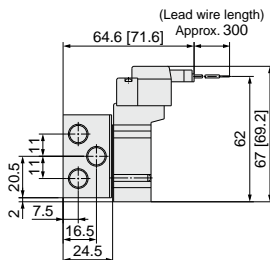

M8 connector (WO):
 10-SY3140(R)-□WO□□-01□

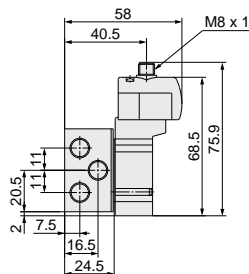

Note) Refer to page 176 for dimensions of connector types.

Dimensions: Series 10-SY3000

[] : AC

2 position double

Grommet (G), (H): 10-SY3240(R)-□^G□□-01□

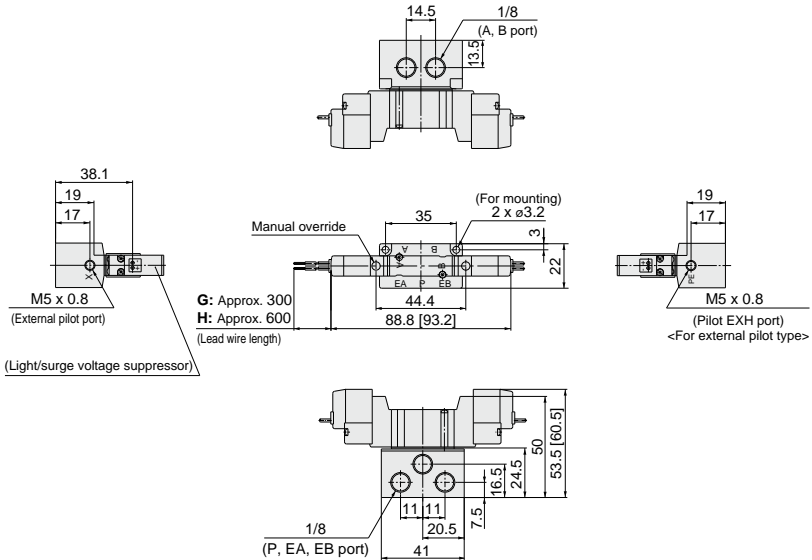

L plug connector (L):
10-SY3240(R)-□L□□-01□

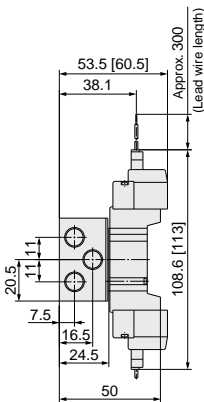

M plug connector (M):
10-SY3240(R)-□M□□-01□

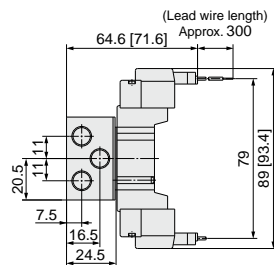

M8 connector (WO):
10-SY3240(R)-□WO□□-01□

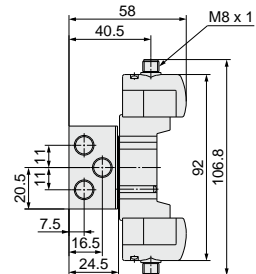

Note) Refer to page 176 for dimensions of connector types.

Dimensions: Series 10-SY3000

[]: AC

3 position closed center / exhaust center / pressure center

Grommet (G), (H): 10-SY3 $\frac{3}{4}$ 40(R)-□^G□□□-01□

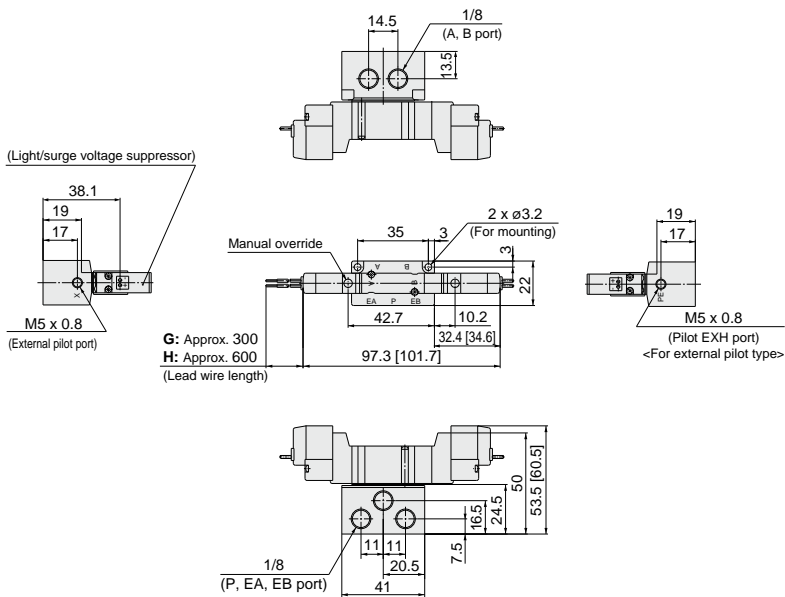

L plug connector (L):
10-SY3 $\frac{3}{4}$ 40(R)-□L□□□-01□

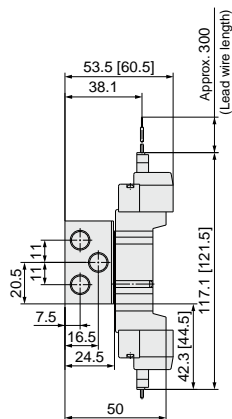

M plug connector (M):
10-SY3 $\frac{3}{4}$ 40(R)-□M□□□-01□

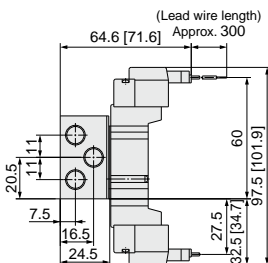

M8 connector (WO):
10-SY3 $\frac{3}{4}$ 40(R)-□WO□□□-01□

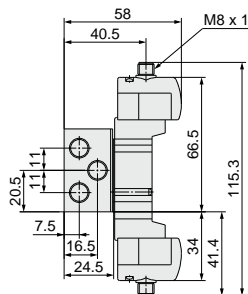

Note) Refer to page 176 for dimensions of connector types.

Dimensions: Series 10-SY5000

[] : AC

2 position single

Grommet (G), (H): 10-SY5140(R)-□_G□□-02□

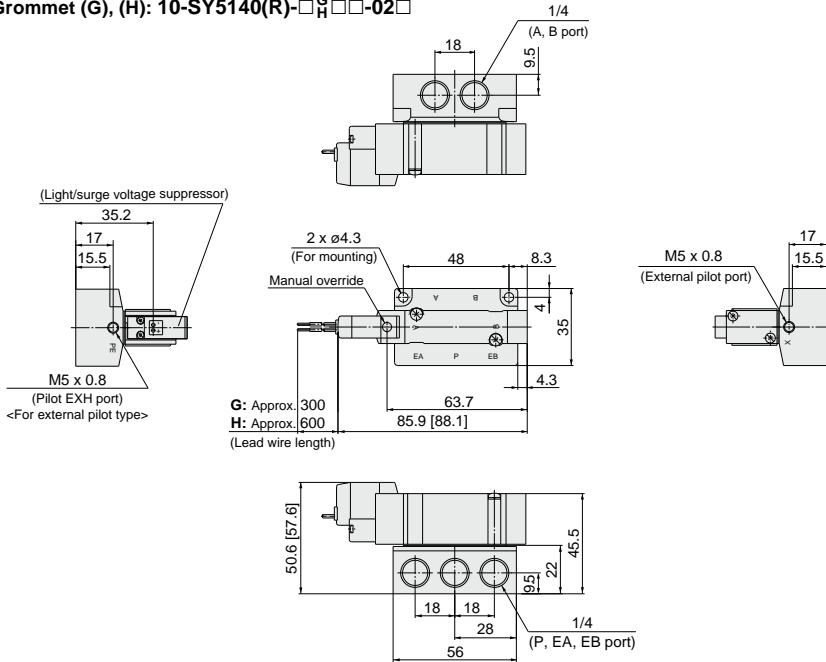

L plug connector (L):
10-SY5140(R)-□L□□-02□

M plug connector (M):
10-SY5140(R)-□M□□-02□

DIN terminal (D, Y):
10-SY5140(R)-□_D□□-02□

M8 connector (WO):
10-SY5140(R)-□WO□□-02□

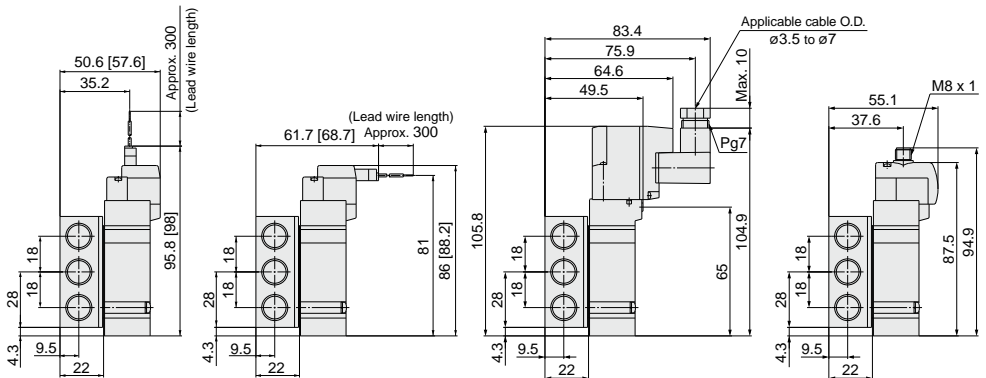

Note) Refer to page 176 for dimensions of connector types.

Dimensions: Series 10-SY5000

[]: AC

2 position double

Grommet (G), (H): 10-SY5240(R)-□^G□□-02□

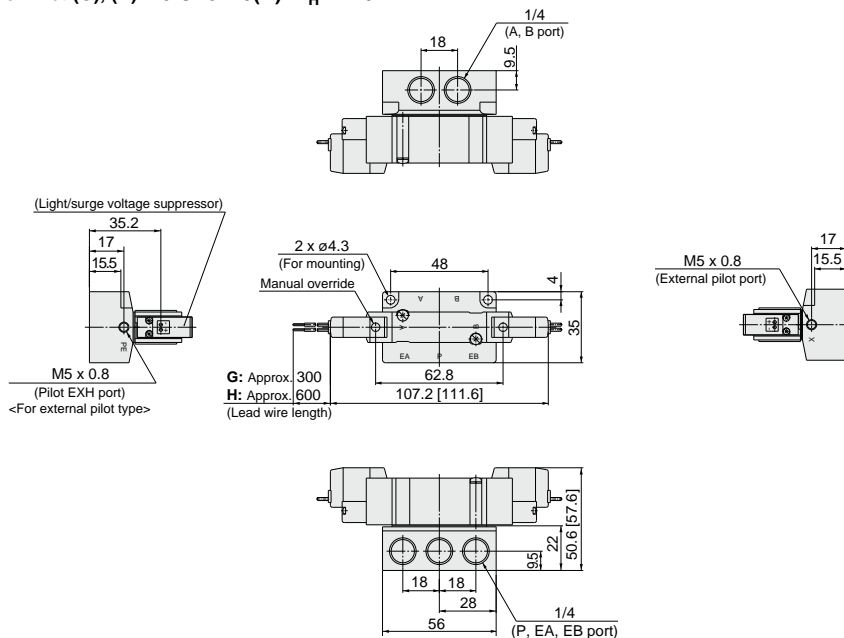

L plug connector (L):
10-SY5240(R)-□L□□-02□

M plug connector (M):
10-SY5240(R)-□M□□-02□

DIN terminal (D, Y):
10-SY5240(R)-□^D□□-02□

M8 connector (WO):
10-SY5240(R)-□WO□□-02□

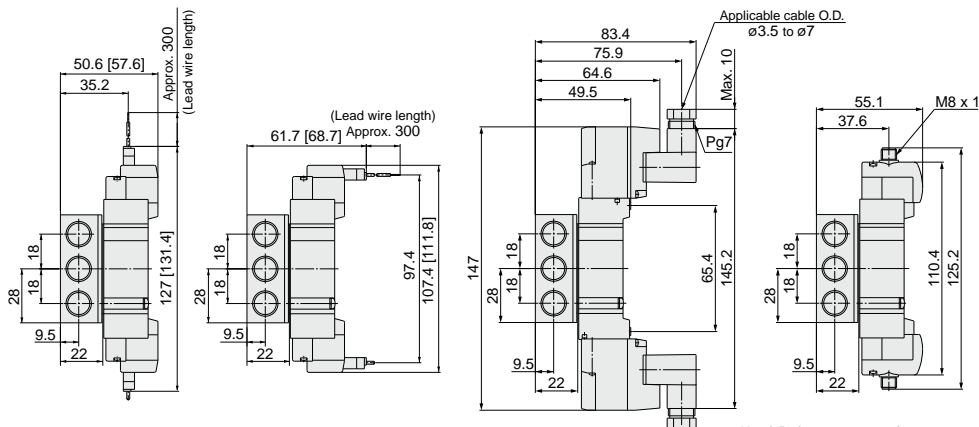

Note) Refer to page 176 for dimensions of connector types.

Dimensions: Series 10-SY7000

[]: AC

2 position single

Grommet (G), (H): 10-SY7140(R)-□_G□□-02□_H□□-03□

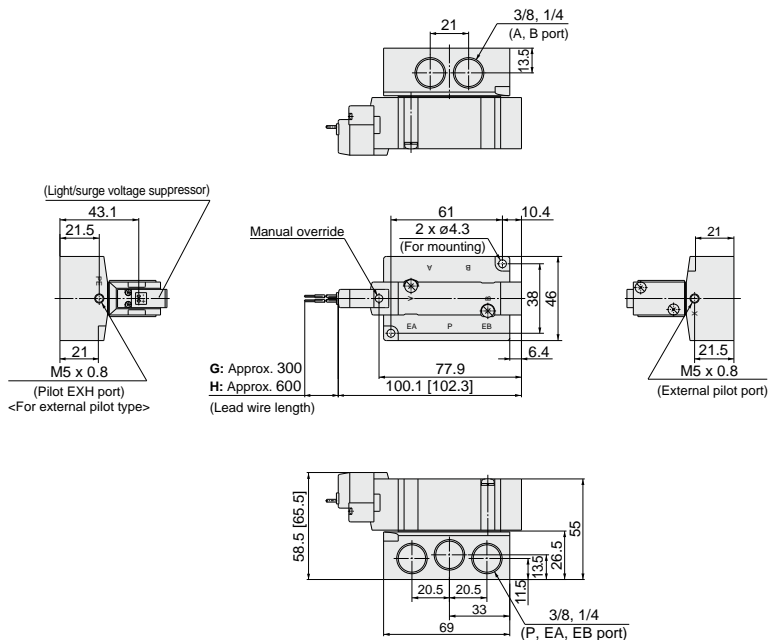

L plug connector (L):
10-SY7140(R)-□L□□-02□_L□□-03□

M plug connector (M):
10-SY7140(R)-□M□□-02□_M□□-03□

DIN terminal (D, Y):
10-SY7140(R)-□D□□-02□_D□□-03□

M8 connector (WO):
10-SY7140(R)-□WO□□-02□_{WO}□□-03□

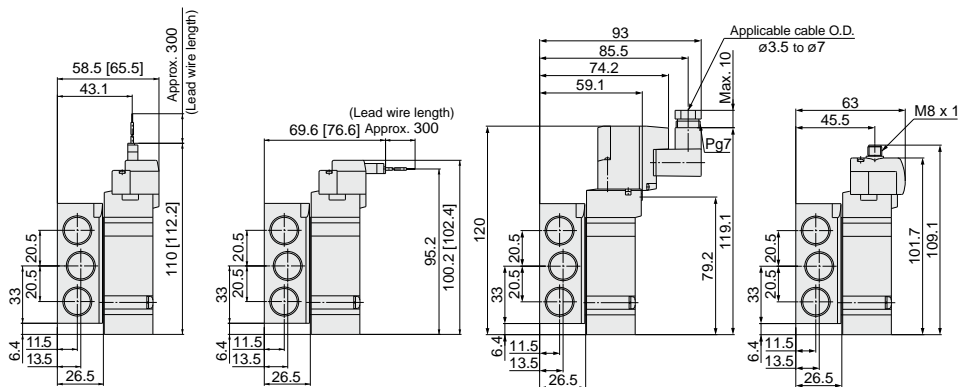

Note) Refer to page 176 for dimensions of connector types.

Dimensions: Series 10-SY7000

[]: AC

2 position double

Grommet (G), (H): 10-SY7240(R)-□G□□□□.02□□
□H□□□□.03□□

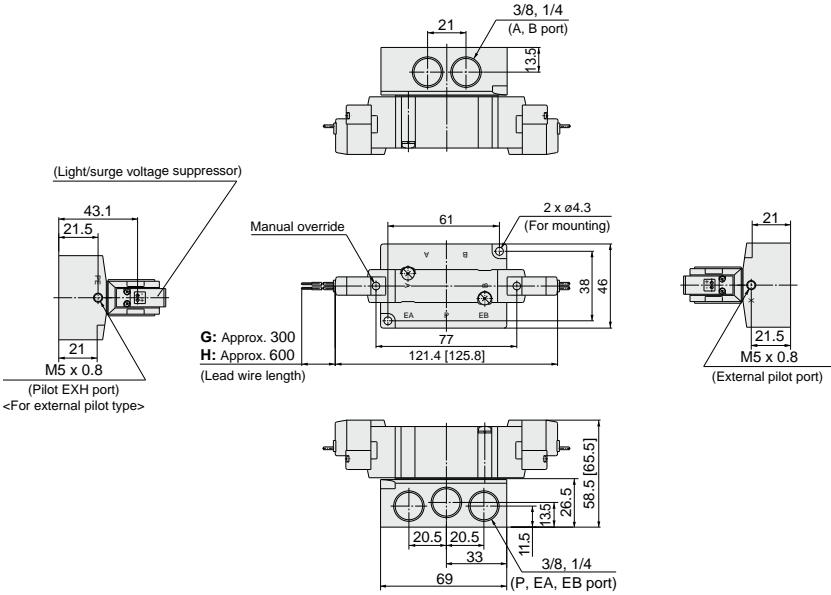

L plug connector (L):
10-SY7240(R)-□L□□□□.02□□

M plug connector (M):
10-SY7240(R)-□M□□□□.02□□

DIN terminal (D, Y):
10-SY7240(R)-□D□□□□.02□□

M8 connector (WO):
10-SY7240(R)-□WO□□□□.02□□

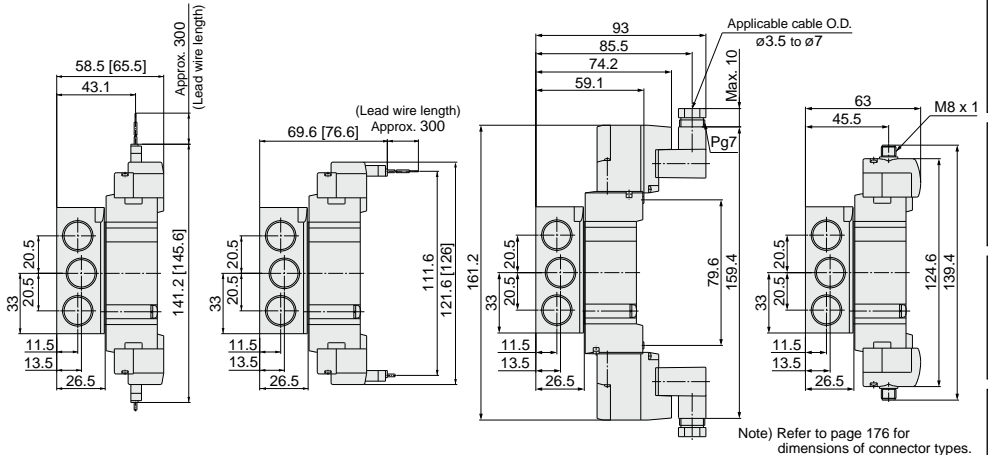

Directional Control Valves
Air Cylinders
Rotary Actuators
Air Grippers
Air Preparation Equipment
Modular F. R.
Pressure Control Equipment
Fittings & Tubing
Flow Control Equipment
Pressure Switches/ Pressure Sensors

Dimensions: Series 10-SY9000

[] : AC

2 position single

Grommet (G), (H): 10-SY9140(R)-□ \square \square \square -03 \square \square \square \square

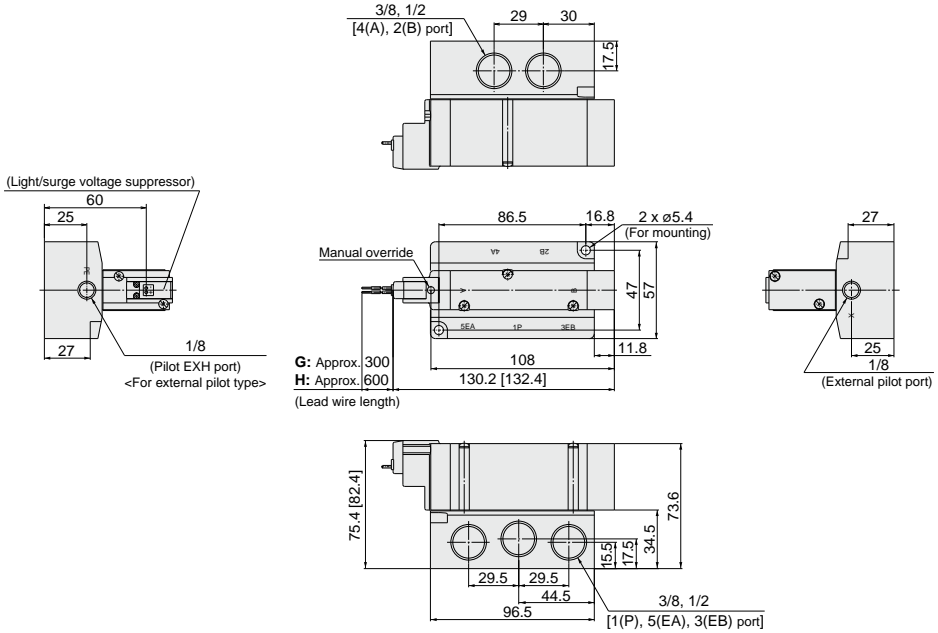

L plug connector (L):
10-SY9140(R)-□L□□-03 \square \square \square

M plug connector (M):
10-SY9140(R)-□M□□-03 \square \square \square

DIN terminal (D, Y):
10-SY9140(R)-□ \square \square \square -03 \square \square \square

M8 connector (WO):
10-SY9140(R)-□WO□□-03 \square \square \square

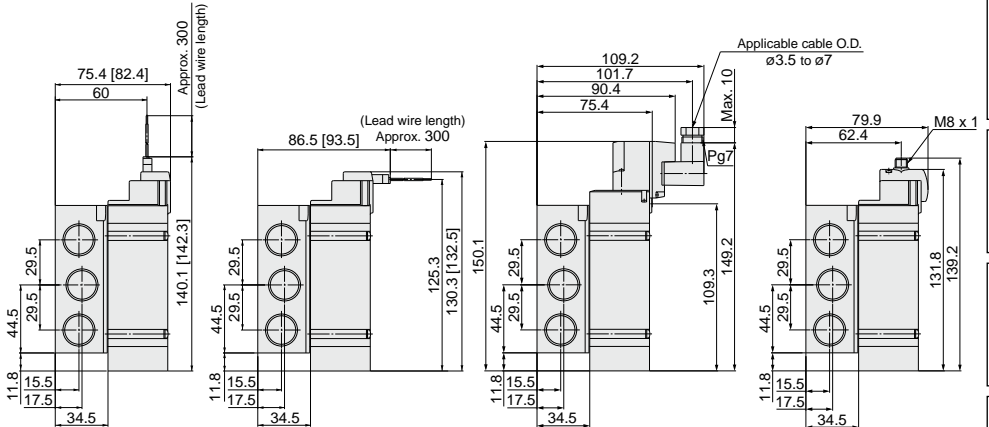

Note) Refer to page 176 for dimensions of connector types.

Dimensions: Series 10-SY9000

[]: AC

2 position double

Grommet (G), (H): 10-SY9240(R)-□□□□-03□□

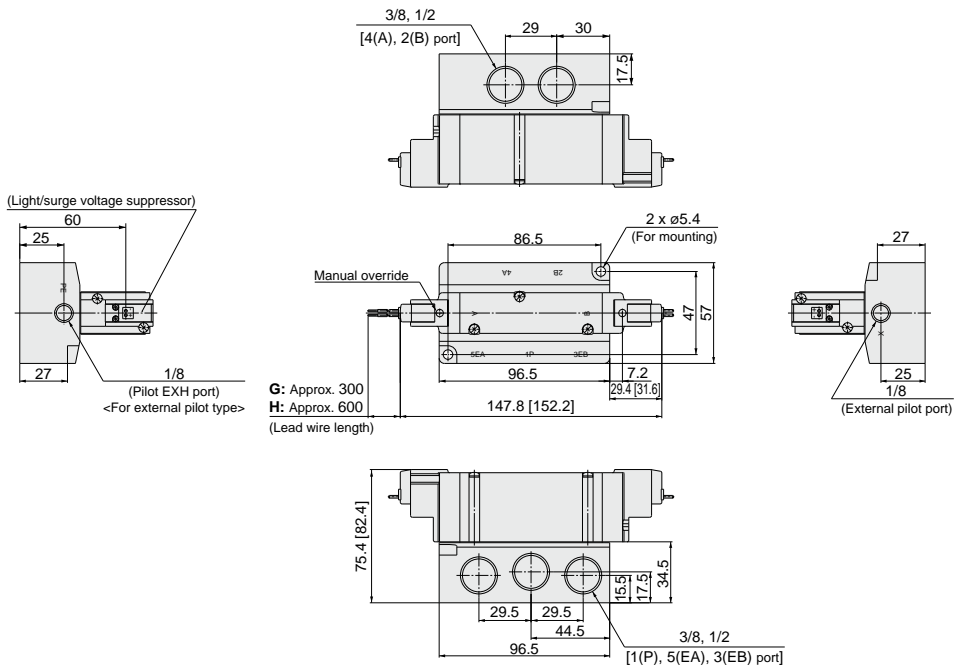

L plug connector (L):
 10-SY9240(R)-□□□□-03□□

M plug connector (M):
 10-SY9240(R)-□□□□-03□□

DIN terminal (D, Y):
 10-SY9240(R)-□□□□-03□□

M8 connector (WO):
 10-SY9240(R)-□□□□-03□□

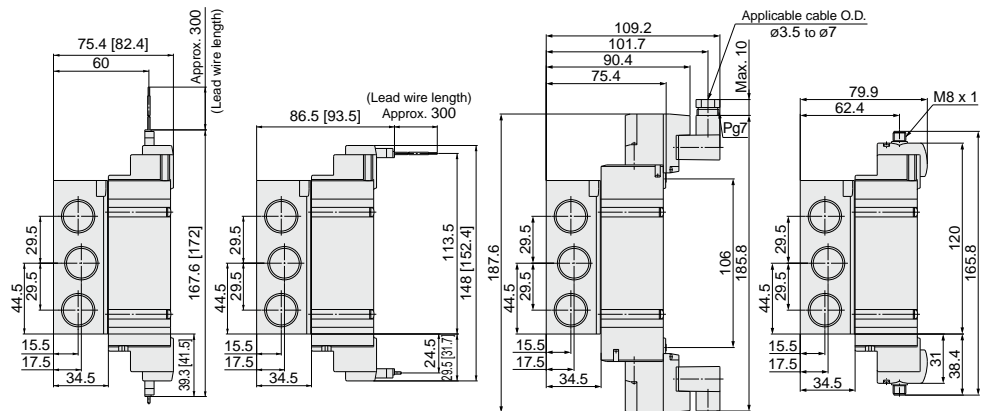

Note) Refer to page 176 for dimensions of connector types.

Dimensions: Series 10-SY9000

[]: AC

3 position closed center / exhaust center / pressure center

Grommet (G), (H): 10-SY9³/₅40(R)-□□□□-0³/₀₄□

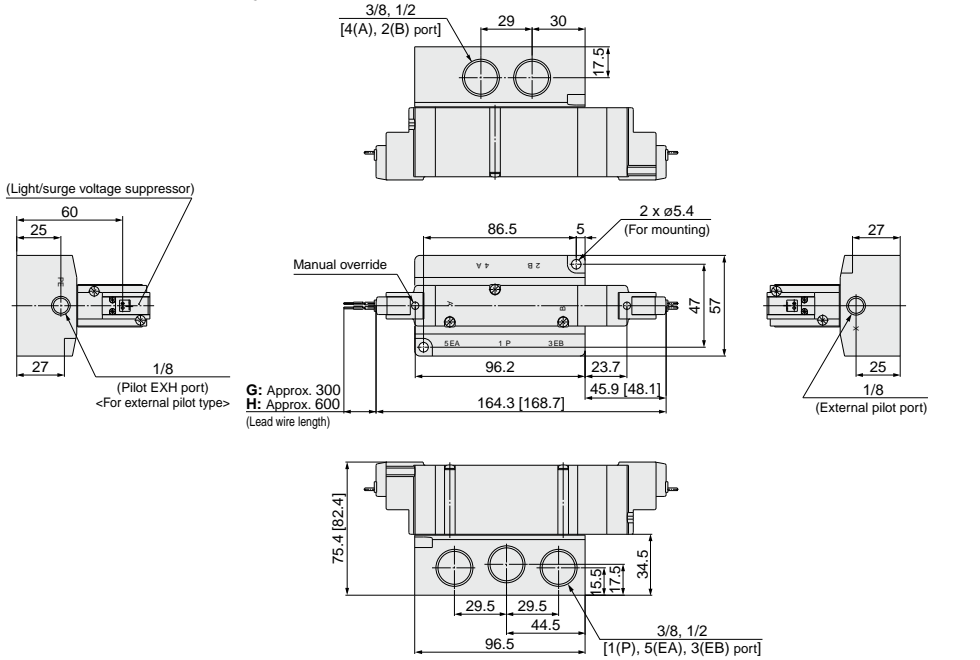

L plug connector (L):
10-SY9³/₅40(R)-□□□□-0³/₀₄□

M plug connector (M):
10-SY9³/₅40(R)-□□□□-0³/₀₄□

DIN terminal (D, Y):
10-SY9³/₅40(R)-□□□□-0³/₀₄□

M8 connector (WO):
10-SY9³/₅40(R)-□□□□-0³/₀₄□

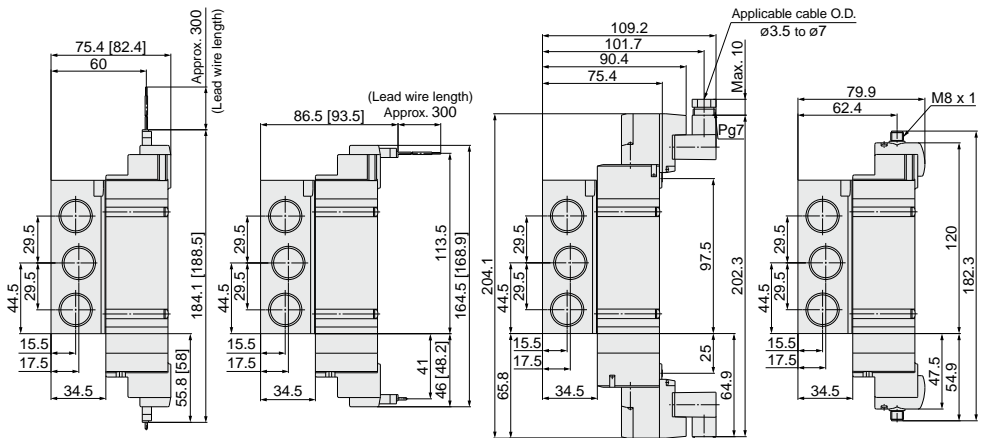

Note) Refer to page 176 for dimensions of connector types.

Directional Control Valves
Air Cylinders
Rotary Actuators
Air Grippers
Air Preparation Equipment
Modular F. R.
Pressure Control Equipment
Fittings & Tubing
Flow Control Equipment
Pressure Switches/ Pressure Sensors

Type 20 Series 10-SY3000/5000/7000

5 Port Solenoid Valve
Body Ported Manifold
Bar Stock Type/Individual Wiring



How to Order Manifold

10 - SS5Y 5 - 20 - 05 - [] - []

• Clean series

Manifold series

3	10-SY3000
5	10-SY5000
7	10-SY7000

Stations

02	2 stations
:	:
20	20 stations

* Includes the number of blanking plate assemblies.

Thread type

Nil	Rc
00F	G
00N	NPT
00T	NPTF

CE-compliant

Nil	—
Q	CE-compliant

Note) AC-type models that are CE-compliant have DIN terminals only.

How to Order Manifold Assembly (Example)

Example

Cylinder port size

C6: With ø6 One-touch fitting

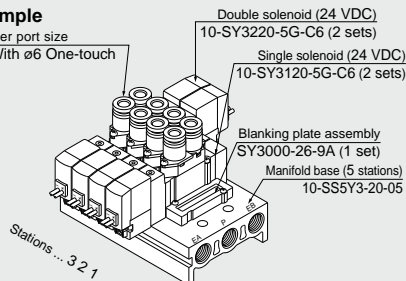

- 10-SS5Y3-20-05 1 set (Type 20, 5-station manifold base part no.)
- * SY3000-26-9A 1 set (Blanking plate assembly part no.)
- * 10-SY3120-5G-C6 ... 2 sets (Single solenoid part no.)
- * 10-SY3220-5G-C6 ... 2 sets (Double solenoid part no.)

The asterisk denotes the symbol for assembly. Prefix it to the part no. of the solenoid valve, etc.

Add the valve and option part number under the manifold base part number. For complex arrangements, specify them on the manifold specification sheet.



How to Order Valve

Note) AC-type models that are CE-compliant have DIN terminals only.

[Option]



• Clean series

Series

3	10-SY3000
5	10-SY5000
7	10-SY7000

Actuation type

1	2 position single
2	2 position double
3	3 position closed center
4	3 position exhaust center
5	3 position pressure center

Coil type

Nil	Standard
T	With power saving circuit (24 VDC, 12 VDC only)

* Power saving circuit is not available for D, Y, DO, YO or W□ types.

Rated voltage

For DC

For AC (50/60 Hz)

5	24 VDC	1	100 VAC
6	12 VDC	2	200 VAC
V	6 VDC	3	110 VAC [115 VAC]
S	5 VDC	4	220 VAC [230 VAC]
R	3 VDC		

* DC specifications of type D, Y, DO and YO are only available with 12 and 24 VDC.

* For type W□, only DC voltage is available.

Note) AC-type models that are CE-compliant have DIN terminals only.

• Made to Order

Nil	—
X90	Main valve fluororubber (Refer to page 169.)

• Thread type

Nil	Rc
F	G
N	NPT
T	NPTF

* Except for M5

• CE-compliant

Nil	—
Q	CE-compliant

Note) AC-type models that are CE-compliant have DIN terminals only.

• A, B port size Thread piping

Symbol	Port size	Applicable series
M5	M5 x 0.8	10-SY3000
01	1/8	10-SY5000
02	1/4	10-SY7000

• Manual override

Nil	Non-locking push type
D	Push-turn locking slotted type
E	Push-turn locking lever type

• Light/Surge voltage suppressor

Electrical entry for G, H, L, M, W

Nil	Without light/surge voltage suppressor
S	With surge voltage suppressor
Z	With light/surge voltage suppressor
R	With surge voltage suppressor (Non-polar type)
U	With light/surge voltage suppressor (Non-polar type)

* For AC voltage valves there is no "S" option. It is already built into the rectifier circuit.
 * For "R" and "U", only DC voltage is available.
 * Power saving circuit is only available for the "Z" type.

Electrical entry for D, Y

Nil	Without light/surge voltage suppressor
S	With surge voltage suppressor (Non-polar type)
Z	With light/surge voltage suppressor (Non-polar type)

* DOZ and YOZ are not available.
 * For AC voltage valves there is no "S" option. It is already built into the rectifier circuit.

One-touch fitting (Metric size)

Symbol	Port size	Applicable series
C4	ø4 One-touch fitting	10-SY3000
C6	ø6 One-touch fitting	10-SY5000
C8	ø8 One-touch fitting	10-SY7000
C10	ø10 One-touch fitting	10-SY7000

One-touch fitting (Inch size)

Symbol	Port size	Applicable series
N3	ø3/8 One-touch fitting	10-SY3000
N7	ø1/4 One-touch fitting	10-SY5000
N3	ø3/8 One-touch fitting	10-SY5000
N7	ø1/4 One-touch fitting	10-SY5000
N9	ø5/16 One-touch fitting	10-SY7000
N9	ø5/16 One-touch fitting	10-SY7000
N11	ø3/8 One-touch fitting	10-SY7000

Electrical entry

Note) When placing an order for body ported solenoid valves as a single unit, the mounting screws for the manifold and gasket are not attached. Order them separately, if necessary.

■ Gasket assembly part no.

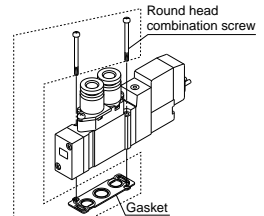

Series	Gasket assembly part no.
10-SY3000	SY3000-GS-1
10-SY5000	SY5000-GS-1
10-SY7000	SY7000-GS-1

Note) The gasket assembly consists of 10 sets of mounting screws and a gasket.

		24, 12, 6, 5, 3 VDC/ 100, 110, 200, 220 VAC			24, 12 VDC/ 100, 110, 200, 220 VAC	24, 12, 6, 5, 3 VDC
		Grommet	L plug connector	M plug connector	DIN terminal	M8 connector
Manifold mounting	10-SY3000	●	●	●	— Note 1)	●
	10-SY5000	●	●	●	●	●
	10-SY7000	●	●	●	●	●
CE-compliant	DC	●	●	●	●	●
	AC	—	—	—	●	—

Note 1) The DIN terminal of the 10-SY3000 series cannot be mounted on a standard manifold. For details, refer to page 174.

Note 2) Enter the cable length symbols in □. Please be sure to fill in the blank referring to page 176.

* LN, MN type: With 2 sockets.

* "Y" type is a DIN terminal conforming to EN-175301-803C (former DIN43850C).

For details, refer to page 173.

* For connector cable of M8 connector, refer to page 176.

* M8 connector conforming to IEC60947-5-2 standard is also available. Refer to page 168 for details.

* Refer to page 173 for the lead wire length of L and M plug connectors.

* Refer to page 174 for the connector assembly with cover for L and M plug connectors.

Directional Control Valves

Air Cylinders

Rotary Actuators

Air Grippers

Air Preparation Equipment

Modular F. R.

Pressure Control Equipment

Fittings & Tubing

Flow Control Equipment

Pressure Switches/ Pressure Sensors



Manifold Specifications

Model	10-SS5Y3-20(-Q)	10-SS5Y5-20(-Q)	10-SS5Y7-20(-Q)	
Applicable valve	10-SY3□20	10-SY5□20	10-SY7□20	
Manifold type	Single base/B mount			
P (SUP)/R (EXH)	Common SUP, Common EXH			
Valve stations	2 to 20 stations ^{Note 1)}			
A, B port location	Valve			
	P, EA, EB port	1/8	1/4	1/4
Port size	A, B port	M5 x 0.8	1/8	1/4
		C4 (ø4 One-touch fitting) C6 (ø6 One-touch fitting)	C4 (ø4 One-touch fitting) C6 (ø6 One-touch fitting) C8 (ø8 One-touch fitting)	C8 (ø8 One-touch fitting) C10 (ø10 One-touch fitting)
Manifold base weight W (g)	W = 13n + 24	W = 36n + 64	W = 43n + 35	
n: Stations				

Note 1) For more than 10 stations (more than 5 stations in case of 10-SS5Y7), supply pressure to P port on both sides and exhaust from EA/EB port on both sides.

Note 2) Refer to "Manifold Option" on page 100.

Flow Rate Characteristics

Model	Port size		Flow rate characteristics					
	1, 5, 3 (P, EA, EB)	4, 2 (A, B)	1 → 4/2 (P → A/B)			4/2 → 5/3 (A/B → EA/EB)		
			C (dm ³ /(s·bar))	b	Cv	C (dm ³ /(s·bar))	b	Cv
10-SS5Y3-20(-Q)	1/8	C6	0.72	0.29	0.18	0.80	0.36	0.21
10-SS5Y5-20(-Q)	1/4	C8	1.9	0.28	0.48	2.2	0.20	0.53
10-SS5Y7-20(-Q)	1/4	C10	3.6	0.31	0.93	3.6	0.27	0.88

Note) The values are for individually operated 2 position type manifold bases with 5 stations.

10-SY3000: 10-SS5Y3-20-Stations -

[] : AC

Grommet (G)

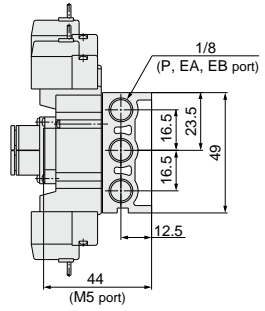
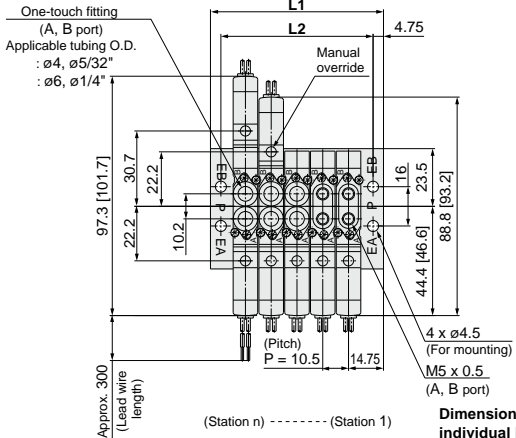

Approx. 300 (Lead wire length)
(Station n) ----- (Station 1)

Dimensions when mounting individual EXH spacer

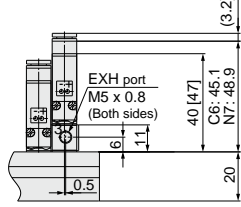

Dimensions when mounting individual SUP spacer

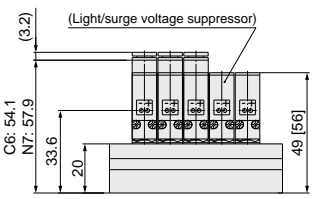
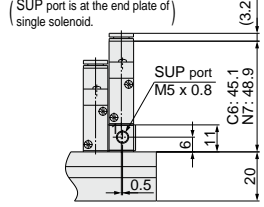

L plug connector (L)

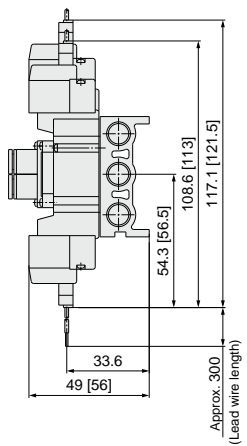

M plug connector (M)

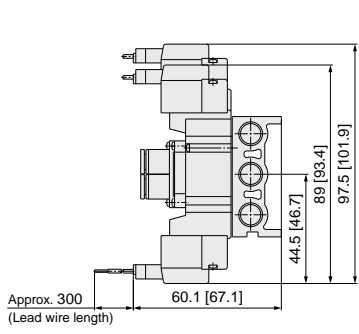

M8 connector (WO)

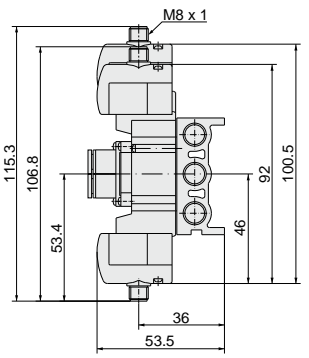

Note) Refer to page 176 for dimensions of connector types.

Stations	2 stations	3	4	5	6	7	8	9	10	11	12	13	14	15	16	17	18	19	20 stations
L1	40	50.5	61	71.5	82	92.5	103	113.5	124	134.5	145	155.5	166	176.5	187	197.5	208	218.5	229
L2	30.5	41	51.5	62	72.5	83	93.5	104	114.5	125	135.5	146	156.5	167	177.5	188	198.5	209	219.5

- Directional Control Valves
- Air Cylinders
- Rotary Actuators
- Air Grippers
- Air Preparation Equipment
- Modular F. R.
- Pressure Control Equipment
- Fittings & Tubing
- Flow Control Equipment
- Pressure Switches/ Pressure Sensors

10-SY5000: 10-SS5Y5-20-Stations -

[]: AC

Grommet (G)

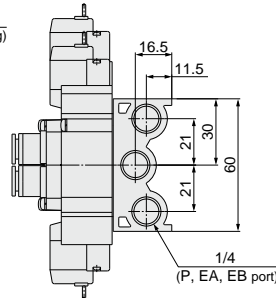
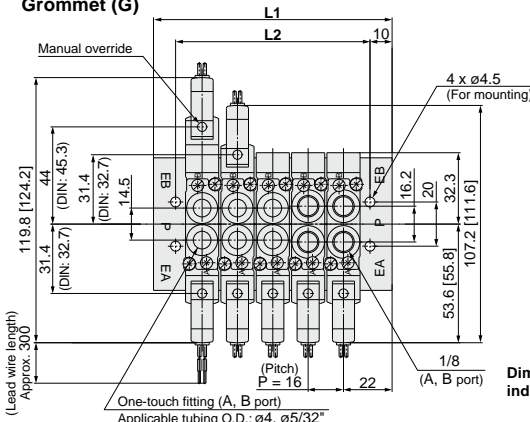

Dimensions when mounting individual EXH spacer

Dimensions when mounting individual SUP spacer

(SUP port is at the end plate of single solenoid.)

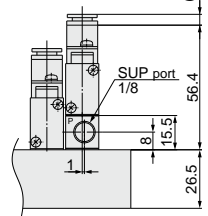
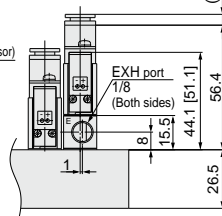
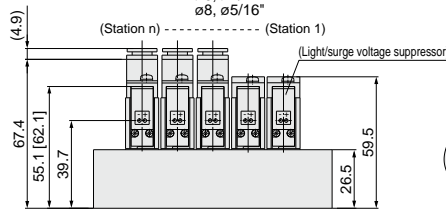

L plug connector (L)

M plug connector (M)

DIN terminal (D, Y)

M8 connector (WO)

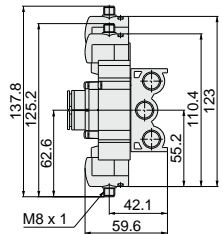
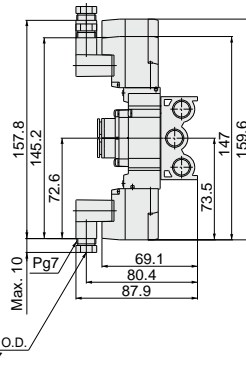
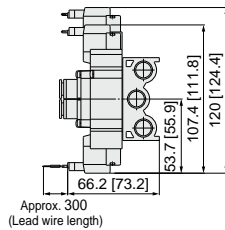
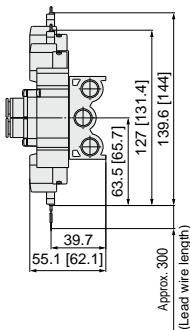

Note) Refer to page 176 for dimensions of connector types.

Stations	2 stations	3	4	5	6	7	8	9	10	11	12	13	14	15	16	17	18	19	20 stations
L1	60	76	92	108	124	140	156	172	188	204	220	236	252	268	284	300	316	332	348
L2	40	56	72	88	104	120	136	152	168	184	200	216	232	248	264	280	296	312	328

10-SY7000: 10-SS5Y7-20 Stations -

[] : AC

Grommet (G)

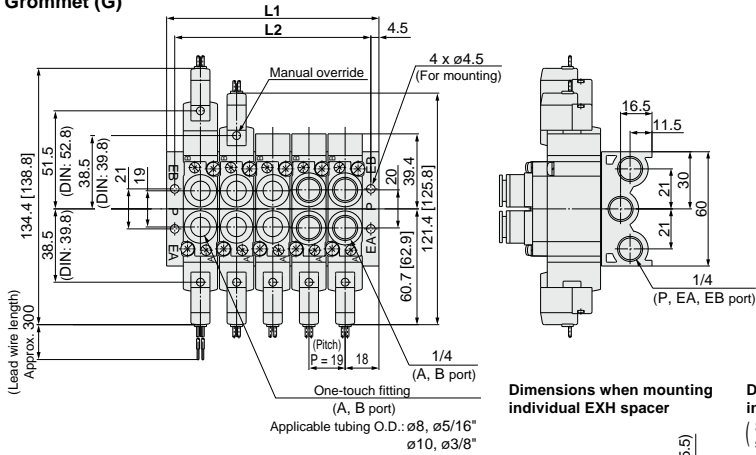

Dimensions when mounting individual EXH spacer

Dimensions when mounting individual SUP spacer
(SUP port is at the end plate of single solenoid.)

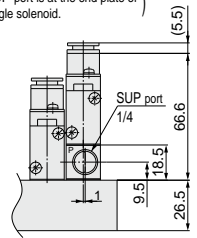
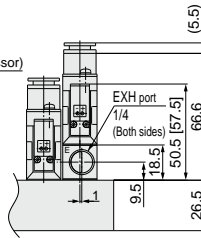
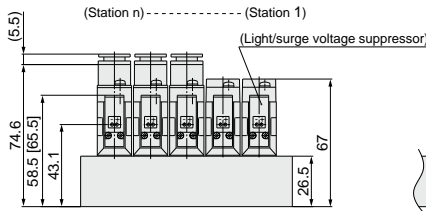

L plug connector (L)

M plug connector (M)

DIN terminal (D, Y)

M8 connector (WO)

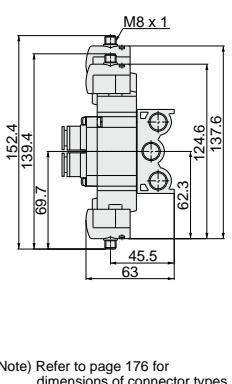
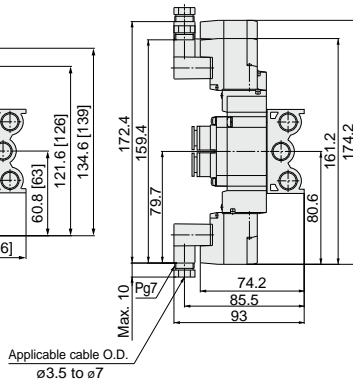
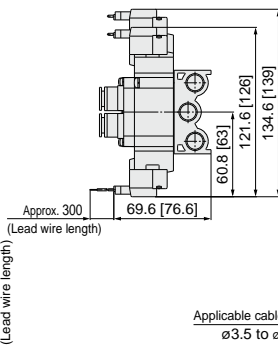
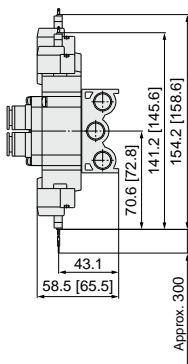

Note) Refer to page 176 for dimensions of connector types.

Stations	2 stations	3	4	5	6	7	8	8	10	11	12	13	14	15	16	17	18	18	19	20 stations
L1	55	74	93	112	131	150	169	188	207	226	245	264	283	302	321	340	359	378	397	
L2	46	65	84	103	122	141	160	179	198	217	236	255	274	293	312	331	350	369	388	

Directional Control Valves

Air Cylinders

Rotary Actuators

Air Grippers

Air Preparation Equipment

Modular F. R.

Pressure Control Equipment

Fittings & Tubing

Flow Control Equipment

Pressure Switches/
Pressure Sensors

Type 23 Series 10-SY9000

5 Port Solenoid Valve
Body Ported Manifold
Stacking Type/Individual Wiring



How to Order Manifold

Type 23/Common external pilot

10-SS5Y9-23-05-□-□-□

• Clean series

Manifold series
9 10-SY9000

• Valve stations

Symbol	Stations
02	2 stations
⋮	⋮
20	20 stations

* Includes the number of blanking plate assemblies.

• Thread type

Nil	Rc
00F	G
00N	NPT
00T	NPTF

• Option

Symbol	Mounting
Nil	Direct mounting
D	DIN rail mounting (with DIN rail)
DO	DIN rail mounting (without DIN rail)
D*	When a longer DIN rail is desired than the specified stations, specify the station number to be required in place of the * mark.

• CE-compliant

Nil	—
Q	CE-compliant

Note) AC-type models that are CE-compliant have DIN terminals only.

How to Order Manifold Assembly (Example)

Example

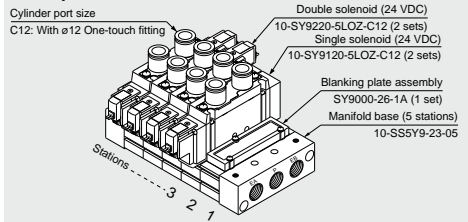

10-SS5Y9-23-05 1 set (Type 23, 5-station manifold base part no.)
 * SY9000-26-1A 1 set (Blanking plate assembly part no.)
 * 10-SY9120-5LOZ-C12 ... 2 sets (Single solenoid part no.)
 * 10-SY9220-5LOZ-C12 ... 2 sets (Double solenoid part no.)

The asterisk denotes the symbol for assembly. Prefix it to the part no. of the solenoid valve, etc.

Add the valve and option part number under the manifold base part number. For complex arrangements, specify them on the manifold specification sheet.



How to Order Valve

Note) AC-type models that are CE-compliant have DIN terminals only.

[Option]

10 - SY 9 1 20 - 5 L - 02

• Clean series

Series
9 10-SY9000

• Actuation type

1	2 position single
2	2 position double
3	3 position closed center
4	3 position exhaust center
5	3 position pressure center

• Pilot type

Nil	Internal pilot
R	External pilot

* For external pilot specifications, it cannot be used as a single unit.

• Coil type

Nil	Standard
T	With power saving circuit (24 VDC, 12 VDC only)

* Power saving circuit is not available for D, Y, DO, YO or WC types.

• Rated voltage

For DC

5	24 VDC
6	12 VDC
V	6 VDC
S	5 VDC
R	3 VDC

* DC specifications of type D, Y, DO and YO are only available with 12 and 24 VDC.

* For type WC, only DC voltage is available.

Note) AC-type models that are CE-compliant have DIN terminals only.

For AC (%/Hz)

1	100 VAC
2	200 VAC
3	110 VAC [115 VAC]
4	220 VAC [230 VAC]

• Made to Order

Nil	—
X90	Main valve fluororubber (Refer to page 169.)

• Thread type

Nil	Rc
F	G
N	NPT
T	NPTF

• CE-compliant

Nil	—
Q	CE-compliant

Note) AC-type models that are CE-compliant have DIN terminals only.

• Manual override

Nil	Non-locking push type
D	Push-turn locking slotted type
E	Push-turn locking lever type

• Light/Surge voltage suppressor

Electrical entry for G, H, L, M, W

Nil	Without light/surge voltage suppressor
S	With surge voltage suppressor
Z	With light/surge voltage suppressor
R	With surge voltage suppressor (Non-polar type)
U	With light/surge voltage suppressor (Non-polar type)

* For AC voltage valves there is no "S" option. It is already built into the rectifier circuit.
* For "R" and "U", only DC voltage is available.
* Power saving circuit is only available for the "Z" type.

Electrical entry for D, Y

Nil	Without light/surge voltage suppressor
S	With surge voltage suppressor
Z	With light/surge voltage suppressor

* DOZ and YOZ are not available.
* For AC voltage valves there is no "S" option. It is already built into the rectifier circuit.

• A, B port size Thread piping

Symbol	Port size
02	1/4
03	3/8

One-touch fitting (Metric size)

Symbol	Port size
C8	ø8 One-touch fitting
C10	ø10 One-touch fitting
C12	ø12 One-touch fitting

One-touch fitting (Inch size)

Symbol	Port size
N9	ø5/16" One-touch fitting
N11	ø3/8" One-touch fitting

• Electrical entry

Note) When placing an order for body ported solenoid valves as a single unit, the mounting screws for the manifold and gasket are not attached. Order them separately, if necessary.

■ Gasket assembly part no.

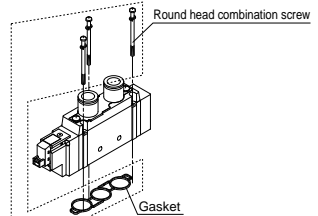

Series	Gasket assembly part no.
10-SY9000	SY9000-GS-1

Note) The gasket assembly consists of 10 sets of mounting screws and a gasket.

24, 12, 6, 5, 3 VDC / 100, 110, 200, 220 VAC			24, 12 VDC / 100, 110, 200, 220 VAC	24, 12, 6, 5, 3 VDC
Grommet	L plug connector	M plug connector	DIN terminal	M8 connector
G: Lead wire length 300 mm H: Lead wire length 600 mm	L: With lead wire (Length 300 mm) LN: Without lead wire LO: Without connector	M: With lead wire (Length 300 mm) MN: Without lead wire MO: Without connector	D: With connector DC: Without connector Y: With connector YO: Without connector	WC: Without connector cable WC: With connector cable (Note)
CE-compliant	DC	●	●	●
AC	—	—	●	—

* LN, MN type: With 2 sockets.

* "Y" type is a DIN terminal conforming to EN-175301-803C (former DIN43650C). For details, refer to page 173.

* For connector cable of M8 connector, refer to page 176.

* M8 connector conforming to IEC60947-5-2 standard is also available. Refer to page 168 for details.

* Refer to page 173 for the lead wire length of L and M plug connectors.

* Refer to page 174 for the connector assembly with cover for L and M plug connectors.

Note) Enter the cable length symbols in □. Please be sure to fill in the blank referring to page 176.

Directional Control Valves

Air Cylinders

Rotary Actuators

Air Grippers

Air Preparation Equipment

Modular F. R.

Pressure Control Equipment

Fittings & Tubing

Flow Control Equipment

Pressure Switches/Pressure Sensors



Manifold Specifications

Model	10-SS5Y9-23(-Q)	
Applicable valve	10-SY9□20	
Manifold type	Stacking type	
P (SUP)/R (EXH)	Common SUP, Common EXH	
Valve stations	2 to 20 stations ^{Note 1)}	
A, B port location	Valve	
Port size	P, EA, EB port	3/8
	A, B port	1/4
		3/8
		C8 (ø8 One-touch fitting) C10 (ø10 One-touch fitting) C12 (ø12 One-touch fitting)
Manifold base weight W (g) n: Stations	W = 66n + 246	

Note 1) For more than 10 stations, supply pressure to P port on both sides and exhaust from EA/EB port on both sides.

Note 2) Refer to "Manifold Option" on page 100.

Flow Rate Characteristics

Model	Port size		Flow rate characteristics					
	1, 5, 3 (P, EA, EB)	4, 2 (A, B)	1 → 4/2 (P → A/B)			4/2 → 5/3 (A/B → EA/EB)		
			C (dm ³ /s·bar)	b	Cv	C (dm ³ /s·bar)	b	Cv
10-SS5Y9-23(-Q)	3/8	C12	6.3	0.20	1.5	8.2	0.28	1.9

Note) The values are for individually operated 2 position type manifold bases with 5 stations.

10-SY9000: 10-SS5Y9-23-Stations-(D)

[] : AC

Grommet (G)

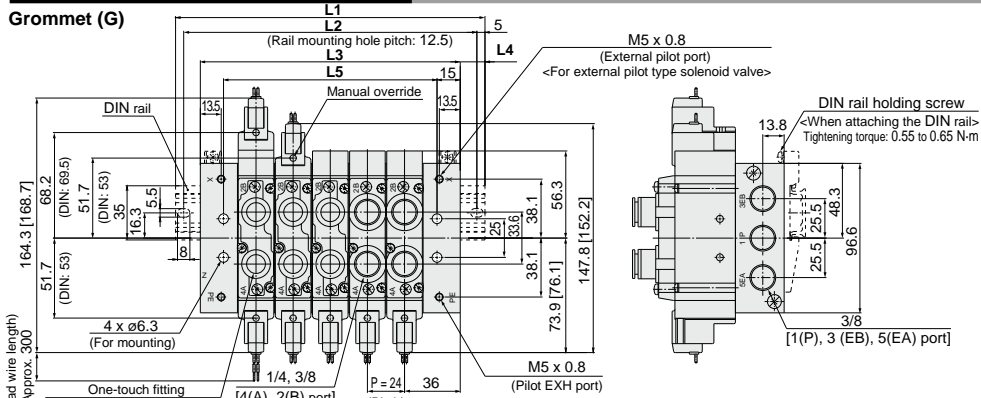

Dimensions when mounting individual EXH spacer

Dimensions when mounting individual SUP spacer

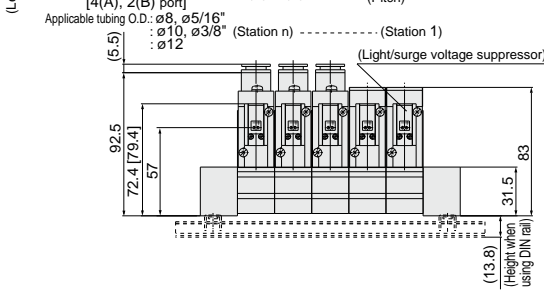

L plug connector (L)

M plug connector (M)

DIN terminal (D, Y)

M8 connector (WO)

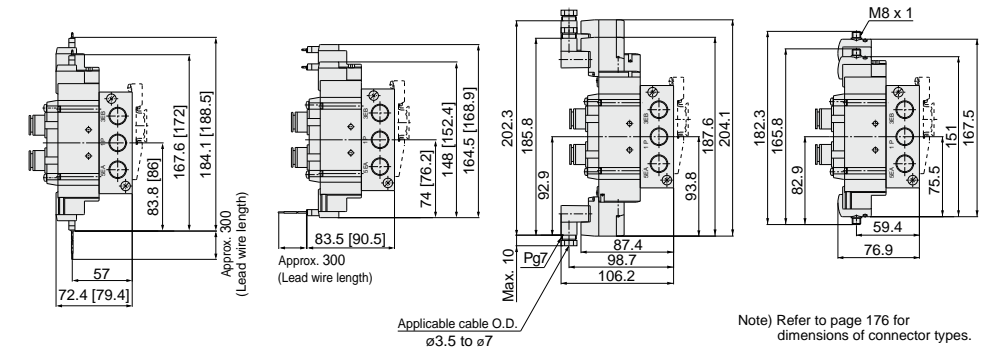

Stations	2 stations	3	4	5	6	7	8	9	10	11	12	13	14	15	16	17	18	19	20 stations
L1	123	148	173	198	223	248	273	298	323	335.5	360.5	385.5	410.5	435.5	460.5	485.5	510.5	535.5	560.5
L2	112.5	137.5	162.5	187.5	212.5	237.5	262.5	287.5	312.5	325	350	375	400	425	450	475	500	525	550
L3	96	120	144	168	192	216	240	264	288	312	336	360	384	408	432	456	480	504	528
L4	13.5	14	14.5	15	15.5	16	16.5	17	17.5	12	12.5	13	13.5	14	14.5	15	15.5	16	16.5
L5	66	90	114	138	162	186	210	234	258	282	306	330	354	378	402	426	450	474	498

Note) For direct mounting without DIN rail, total width of manifold is L3.

Directional Control Valves

Air Cylinders

Rotary Actuators

Air Grippers

Air Preparation Equipment

Modular F. R.

Pressure Control Equipment

Fittings & Tubing

Flow Control Equipment

Pressure Switches/Pressure Sensors

Type 20P Series 10-SY3000/5000/7000

5 Port Solenoid Valve
Body Ported Manifold
Bar Stock Type/Flat Ribbon Cable

Note) CE-compliant:
For DC only.



How to Order Manifold

10 - SS5Y 5 - 20P - 05 - [] - []

Clean series

Manifold series

3	10-SY3000
5	10-SY5000
7	10-SY7000

Stations

03	3 stations
:	?
12	12 stations

Note) SS5Y3 has 4 to 12 stations.

Thread type

Nil	Rc
00F	G
00N	NPT
00T	NPTF

CE-compliant

Nil	—
Q	CE-compliant

Note) CE-compliant: For DC only.

How to Order Manifold Assembly (Example)

Example

Cylinder port size
C6: With ø6 One-touch fitting
(Single solenoid) Connector assembly
10-SY3000-37-3A
(Double solenoid) Connector assembly
10-SY3000-37-4A

Double solenoid (24 VDC)
10-SY3220-5LOU-C6 (2 sets)

Single solenoid (24 VDC)
10-SY3120-5LOU-C6 (3 sets)

Blanking plate assembly
SY3000-26-10A (1 set)

Manifold base (6 stations)
10-SS5Y3-20P-06

Stations 3 2 1

10-SS5Y3-20P-061 set (Type 20P, 6-station manifold part no.)
 * SY3000-26-10A1 set (Blanking plate assembly part no.)
 * 10-SY3120-5LOU-C6 ...3 sets (Single solenoid part no.)
 * 10-SY3220-5LOU-C6 ...2 sets (Double solenoid part no.)
 * SY3000-37-3A3 sets (Connector assembly part no.)
 * SY3000-37-4A2 sets (Connector assembly part no.)

The asterisk denotes the symbol for assembly.
Prefix it to the part no. of the solenoid valve, etc.

Add the valve and option part number under the manifold base part number.
For complex arrangements, specify them on the manifold specification sheet.

Note) Please indicate the connector assembly part no. below that connects the valve and the manifold.

Connector Assembly

For 12, 24 VDC

Specifications	For 10-SY3000	For 10-SY5000/7000
For single solenoid	SY3000-37-3A	SY5000-37-3A
Double solenoid, 3 position type	SY3000-37-4A	SY5000-37-4A
Single with spacer assembly	SY5000-37-3A	SY5000-37-5A
Double, 3 position with spacer assembly	SY3000-37-6A	SY5000-37-6A

Note) Spacer assembly indicates individual SUP/EXH.

For 100 VAC

Specifications	For 10-SY3000	For 10-SY5000/7000
For single solenoid	SY3000-37-32A	SY5000-37-15A
Double solenoid, 3 position type	SY3000-37-33A	SY5000-37-16A
Single with spacer assembly	SY5000-37-15A	SY5000-37-17A
Double, 3 position with spacer assembly	SY3000-37-34A	SY5000-37-18A

For 110 VAC (115 VAC)

Specifications	For 10-SY3000	For 10-SY5000/7000
For single solenoid	SY3000-37-35A	SY5000-37-19A
Double solenoid, 3 position type	SY3000-37-36A	SY5000-37-20A
Single with spacer assembly	SY5000-37-19A	SY5000-37-21A
Double, 3 position with spacer assembly	SY3000-37-37A	SY5000-37-22A

⚠ Caution

- For non-polar "U" valves, the electrical DC connections can be used with either positive and negative COM. For type "Z", only use with positive COM as the valve does not operate correctly when used with negative COM.



How to Order Valve

Note) CE-compliant: For DC only. [Option]

Coil type

Nil	Standard
T	With power saving circuit

Rated voltage CE-compliant

5	24 VDC	●
6	12 VDC	●

Light/surge voltage suppressor

Z	With light/surge voltage suppressor
U	With light/surge voltage suppressor (Non-polar type)

Note) Z: Positive common specifications only.
 * Power saving circuit is only available for the "Z" type.

Note) For flat ribbon cables, "U" and "Z" types are for DC specifications and "Z" type is for AC specifications. "Z" for DC is positive common specifications only. For other combinations, please contact SMC.

CE-compliant

Nil	—
Q	CE-compliant

Note) CE-compliant: For DC only.

Thread type

Nil	Rc
F	G
N	NPT
T	NPTF

* Except for M5

A, B port size
Thread piping

Symbol	Port size	Applicable series
M5	M5 x 0.8	10-SY3000
01	1/8	10-SY5000
02	1/4	10-SY7000

One-touch fitting (Metric size)

Symbol	Port size	Applicable series
C4	ø4 One-touch fitting	10-SY3000
C6	ø6 One-touch fitting	10-SY5000
C8	ø8 One-touch fitting	10-SY7000
C10	ø10 One-touch fitting	10-SY7000

One-touch fitting (Inch size)

Symbol	Port size	Applicable series
N3	ø3/8 One-touch fitting	10-SY3000
N7	ø1/4 One-touch fitting	10-SY5000
N3	ø3/8 One-touch fitting	10-SY7000
N7	ø1/4 One-touch fitting	10-SY5000
N9	ø3/8 One-touch fitting	10-SY7000
N9	ø3/8 One-touch fitting	10-SY7000
N11	ø3/8 One-touch fitting	10-SY7000

Note) When placing an order for body ported solenoid valves as a single unit, the mounting screws for the manifold and gasket are not attached. Order them separately, if necessary.
 Note) Since the electrical entry is "LO", select a connector assembly part no. from those stated on page 83.

Rated voltage CE-compliant

1	100 VAC	—
3	110 VAC (115 VAC)	—

Note) CE-compliant: For DC only.

Manual override

Nil	Non-locking push type
D	Push-turn locking slotted type
E	Push-turn locking lever type

Actuation type

1	2 position single
2	2 position double
3	3 position closed center
4	3 position exhaust center
5	3 position pressure center

Series

3	10-SY3000
5	10-SY5000
7	10-SY7000

Clean series
 For DC: 10-SY 5 1 20 - 5 LO Z - 01 -
 For AC: 10-SY 5 1 20 - 1 LO Z - 01 -

Directional Control Valves

Air Cylinders

Rotary Actuators

Air Grippers

Air Preparation Equipment

Modular F. R.

Pressure Control Equipment

Fittings & Tubing

Flow Control Equipment

Pressure Switches/ Pressure Sensors

■ Gasket assembly part no.

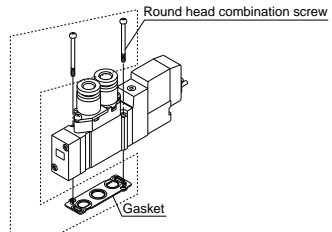

Series	Gasket assembly part no.
10-SY3000	SY3000-GS-1
10-SY5000	SY5000-GS-1
10-SY7000	SY7000-GS-1

Note) The gasket assembly consists of 10 sets of mounting screws and a gasket.

- Multiple valve wiring is simplified through the use of the flat ribbon cable connector
- Clean appearance

For flat ribbon cables, each valve is wired on the print board of the manifold base to allow the external wiring to be piped all together with the 26 pin MIL connector.

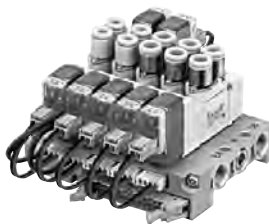

Manifold Specifications

Model	10-SSY3-20P(-Q)	10-SSY5-20P(-Q)	10-SSY7-20P(-Q)	
Applicable valve	10-SY3□20	10-SY5□20	10-SY7□20	
Manifold type	Single base/B mount			
P (SUP/R (EXH))	Common SUP, Common EXH			
Valve stations	4 to 12 stations <small>Note 1)</small>	3 to 12 stations <small>Note 1)</small>		
A, B port location	Valve			
Port size	P, EA, EB port	1/8	1/4	1/4
	A, B port	M5 x 0.8	1/8	1/4
		C4 (ø4 One-touch fitting) C6 (ø6 One-touch fitting) C8 (ø8 One-touch fitting)	C4 (ø4 One-touch fitting) C6 (ø6 One-touch fitting) C8 (ø8 One-touch fitting)	C8 (ø8 One-touch fitting) C10 (ø10 One-touch fitting)
Manifold base weight W (g) n: Stations	W = 19n + 45	W = 43n + 77	W = 51n + 81	
Applicable flat ribbon cable connector	Flat ribbon cable connector, Socket: 26 pin MIL type with strain relief, Conforming to MIL-C-83503			
Internal wiring	Common between +COM and -COM (Z type: +COM only).			
Rated voltage <small>Note 4)</small>	12, 24 VDC 100, 110 VAC			

Note 1) For more than 10 stations (more than 5 stations in case of 10-SSY7), supply pressure to P port on both sides and exhaust from EA/EB port on both sides.

Note 2) The withstand voltage specification for the wiring unit section is JIS C 0704, Grade 1 or its equivalent.

Note 3) Refer to "Manifold Option" on page 100.

Note 4) CE-compliant: For DC only.

Flow Rate Characteristics

Model	Port size		Flow rate characteristics					
	1, 5, 3 (P, EA, EB)	4, 2 (A, B)	1 → 4/2 (P → A/B)			4/2 → 5/3 (A/B → EA/EB)		
			C [dm ³ /(s·bar)]	b	Cv	C [dm ³ /(s·bar)]	b	Cv
10-SSY3-20P	1/8	C6	0.72	0.29	0.18	0.80	0.36	0.21
10-SSY5-20P	1/4	C8	1.9	0.28	0.48	2.2	0.20	0.53
10-SSY7-20P	1/4	C10	3.6	0.31	0.93	3.6	0.27	0.88

Note) The values are for individually operated 2 position type manifold bases with 5 stations.

Internal Wiring of Manifold

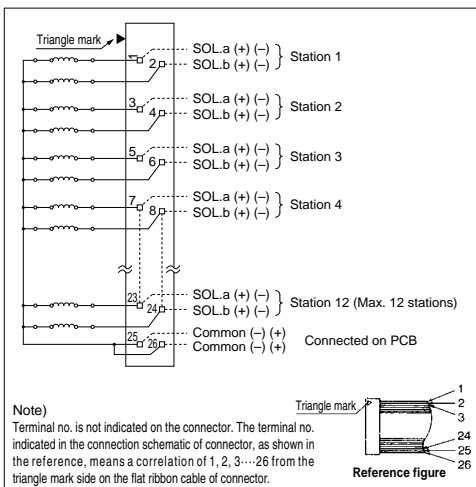

Caution

- For non-polar "U" valves, the electrical DC connections can be used with either positive and negative COM. For type "Z", only use with positive COM as the valve does not operate correctly when used with negative COM.

- For more than 10 stations, both poles of the common should be wired.
- For single solenoid, connect to the solenoid A side.
- The maximum number of stations that can be accommodated is 12. For more stations, please contact SMC.

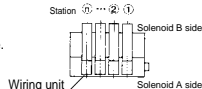

10-SY3000: 10-SS5Y3-20P- Stations

[] : AC

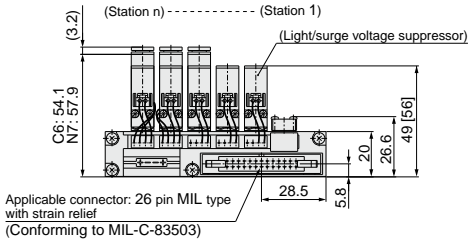
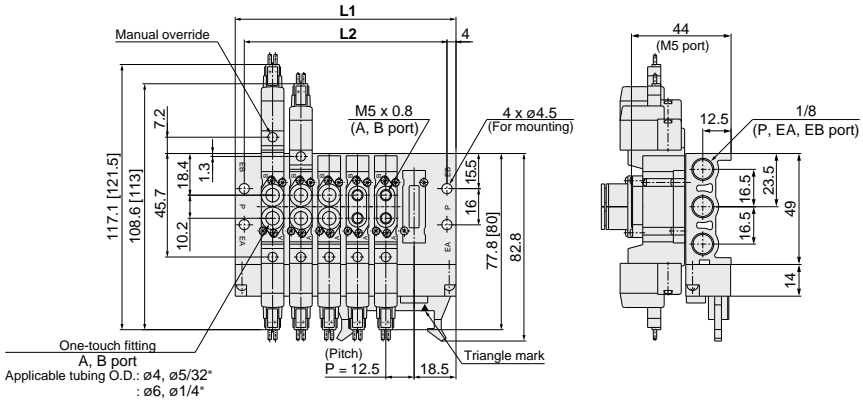

Stations	4	5	6	7	8	9	10	11	12
L1	72.5	85	97.5	110	122.5	135	147.5	160	172.5
L2	64.5	77	89.5	102	114.5	127	139.5	152	164.5

Directional Control Valves

Air Cylinders

Rotary Actuators

Air Grippers

Air Preparation Equipment

Modular F. R.

Pressure Control Equipment

Fittings & Tubing

Flow Control Equipment

Pressure Switches/ Pressure Sensors

10-SY5000: 10-SS5Y5-20P- Stations

[]: AC

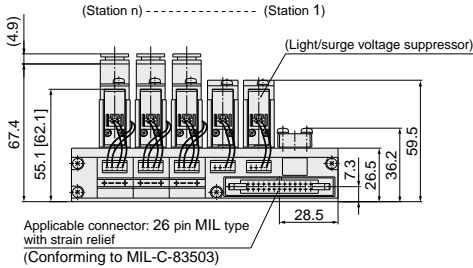
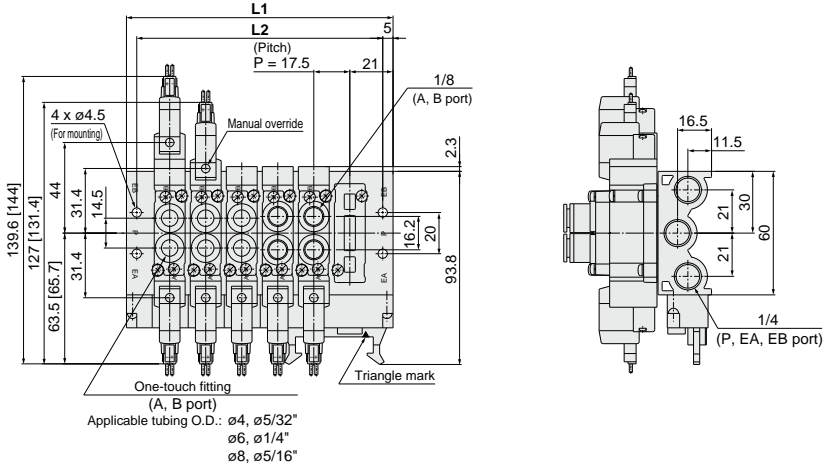

Stations	3	4	5	6	7	8	9	10	11	12
L1	77	94.5	112	129.5	147	164.5	182	199.5	217	234.5
L2	67	84.5	102	119.5	137	154.5	172	189.5	207	224.5

10-SY7000: 10-SS5Y7-20P- Stations

[] : AC

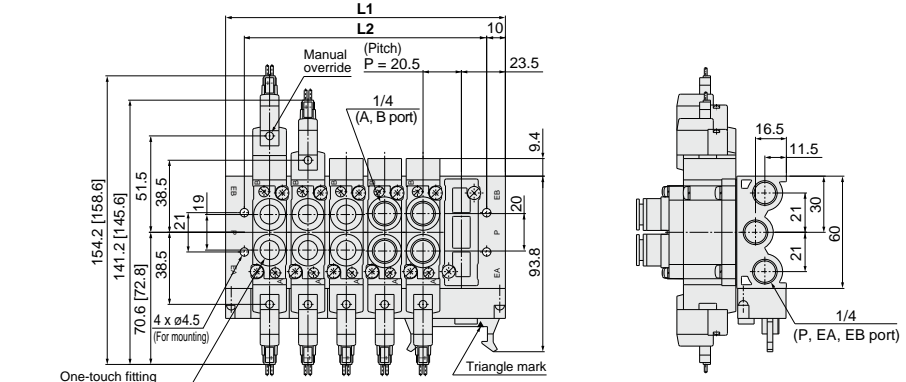

One-touch fitting (A, B port)
 Applicable tubing O.D.: ø8, ø5/16"
 ø10, ø3/8" (Station n) ----- (Station 1)

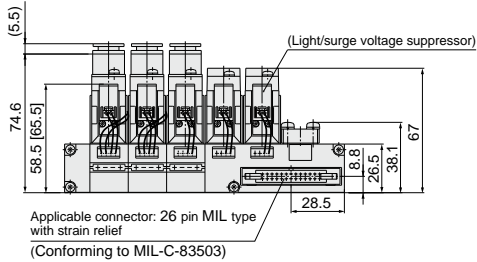

Applicable connector: 26 pin MIL type with strain relief
 (Conforming to MIL-C-83503)

Stations	3	4	5	6	7	8	9	10	11	12
L1	88	108.5	129	149.5	170	190.5	211	231.5	252	272.5
L2	68	88.5	109	129.5	150	170.5	191	211.5	232	252.5

Directional Control Valves

Air Cylinders

Rotary Actuators

Air Grippers

Air Preparation Equipment

Modular F. R.

Pressure Control Equipment

Fittings & Tubing

Flow Control Equipment

Pressure Switches/ Pressure Sensors

Type 23P Series 10-SY9000

5 Port Solenoid Valve
Body Ported Manifold
Stacking Type/Flat Ribbon Cable



Note) CE-compliant:
For DC only. [Option]

How to Order Manifold

Type 23P/Common external pilot

10-SS5Y9-23P-05-□-□-□-□

● Clean series
● Manifold series
9 | 10-SY9000

Valve stations

Symbol	Stations
04	4 stations
:	:
12	12 stations

* Includes the number of blanking plate assemblies.

Thread type

Nil	Rc
00F	G
00N	NPT
00T	NPTF

Option

Symbol	Mounting
Nil	Direct mounting
D	DIN rail mounting (with DIN rail)
DO	DIN rail mounting (without DIN rail)
D*	When a longer DIN rail is desired than the specified stations, specify the station number to be required in place of the * mark.

CE-compliant

Nil	—
Q	CE-compliant

Note) CE-compliant: For DC only.

* Type 23P manifold of the 10-SY9000 series is concurrently used for the internal and external pilot.

How to Order Manifold Assembly (Example)

Example

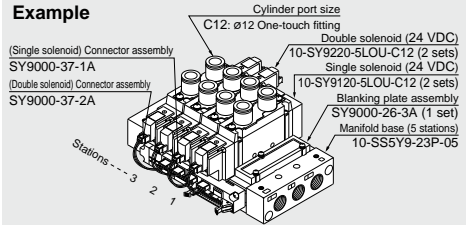

- 10-SS5Y9-23P-05 1 set (Type 23, 5-station manifold base part no.)
 * SY9000-26-3A 1 set (Blanking plate assembly part no.)
 * 10-SY9120-5LOU-C12... 2 sets (Single solenoid part no.)
 * 10-SY9220-5LOU-C12... 2 sets (Double solenoid part no.)
 * SY9000-37-1A 2 sets (Connector assembly part no.)
 * SY9000-37-2A 2 sets (Connector assembly part no.)

The asterisk denotes the symbol for assembly. Prefix it to the part no. of the solenoid valve, etc.

Add the valve and option part number under the manifold base part number. For complex arrangements, specify them on the manifold specification sheet.

Note) Please indicate the connector assembly part no. (page 90) that connects the valve and the manifold.

How to Order Valve

Coil type

Nil	Standard
T	With power saving circuit

Rated voltage

	Rated voltage	CE-compliant
5	24 VDC	●
6	12 VDC	●

Light/Surge voltage suppressor

Z	With light/surge voltage suppressor
U	With light/surge voltage suppressor (Non-polar type)

CE-compliant

Nil	—
Q	CE-compliant

Note) CE-compliant: For DC only.

● Clean series

For DC: 10-SY 9 1 20 □ □ - 5 LO Z □ □ - 02 □ □ - □ □

For AC: 10-SY 9 1 20 □ □ - 1 LO Z □ □ - 02 □ □ - □ □

● Series

9 | 10-SY9000

Actuation type

1	2 position single
2	2 position double
3	3 position closed center
4	3 position exhaust center
5	3 position pressure center

Pilot type

Nil	Internal pilot
R	External pilot

* Type 23P manifolds can be used for both internal and external pilots.

Rated voltage

	Rated voltage	CE-compliant
1	100 VAC	—
3	110 VAC (115 VAC)	—

Note) CE-compliant: For DC only.

Manual override

Nil	Non-locking push type
D	Push-turn locking slotted type
E	Push-turn locking lever type

A, B port size

Thread piping

Symbol	Port size
02	1/4
03	3/8

One-touch fitting (Metric size)

Symbol	Port size
C8	ø8 One-touch fitting
C10	ø10 One-touch fitting
C12	ø12 One-touch fitting

One-touch fitting (Inch size)

Symbol	Port size
N9	ø 5/16" One-touch fitting
N11	ø 3/8" One-touch fitting

Thread type

Nil	Rc
F	G
N	NPT
T	NPTF

Light/Surge voltage suppressor

Note) Z: Positive common specifications only.
 * Power saving circuit is only available for the "Z" type.

CE-compliant

Note) CE-compliant: For DC only.

Thread type

Nil	Rc
F	G
N	NPT
T	NPTF

Light/Surge voltage suppressor

Note) Z: Positive common specifications only.
 * Power saving circuit is only available for the "Z" type.

CE-compliant

Note) CE-compliant: For DC only.

Thread type

Nil	Rc
F	G
N	NPT
T	NPTF

Light/Surge voltage suppressor

Note) Z: Positive common specifications only.
 * Power saving circuit is only available for the "Z" type.

CE-compliant

Note) CE-compliant: For DC only.

Thread type

Nil	Rc
F	G
N	NPT
T	NPTF

Light/Surge voltage suppressor

Note) Z: Positive common specifications only.
 * Power saving circuit is only available for the "Z" type.

CE-compliant

Note) CE-compliant: For DC only.

Thread type

Nil	Rc
F	G
N	NPT
T	NPTF

Light/Surge voltage suppressor

Note) Z: Positive common specifications only.
 * Power saving circuit is only available for the "Z" type.

CE-compliant

Note) CE-compliant: For DC only.

Thread type

Nil	Rc
F	G
N	NPT
T	NPTF

Light/Surge voltage suppressor

Note) Z: Positive common specifications only.
 * Power saving circuit is only available for the "Z" type.

CE-compliant

Note) CE-compliant: For DC only.

Thread type

Nil	Rc
F	G
N	NPT
T	NPTF

Light/Surge voltage suppressor

Note) Z: Positive common specifications only.
 * Power saving circuit is only available for the "Z" type.

CE-compliant

Note) CE-compliant: For DC only.

Thread type

Nil	Rc
F	G
N	NPT
T	NPTF

Light/Surge voltage suppressor

Note) Z: Positive common specifications only.
 * Power saving circuit is only available for the "Z" type.

CE-compliant

Note) CE-compliant: For DC only.

Thread type

Nil	Rc
F	G
N	NPT
T	NPTF

Light/Surge voltage suppressor

Note) Z: Positive common specifications only.
 * Power saving circuit is only available for the "Z" type.

CE-compliant

Note) CE-compliant: For DC only.

Thread type

Nil	Rc
F	G
N	NPT
T	NPTF

Light/Surge voltage suppressor

Note) Z: Positive common specifications only.
 * Power saving circuit is only available for the "Z" type.

CE-compliant

Note) CE-compliant: For DC only.

Thread type

Nil	Rc
F	G
N	NPT
T	NPTF

Light/Surge voltage suppressor

Note) Z: Positive common specifications only.
 * Power saving circuit is only available for the "Z" type.

CE-compliant

Note) CE-compliant: For DC only.

Thread type

Nil	Rc
F	G
N	NPT
T	NPTF

Light/Surge voltage suppressor

Note) Z: Positive common specifications only.
 * Power saving circuit is only available for the "Z" type.

CE-compliant

Note) CE-compliant: For DC only.

Thread type

Nil	Rc
F	G
N	NPT
T	NPTF

Light/Surge voltage suppressor

Note) Z: Positive common specifications only.
 * Power saving circuit is only available for the "Z" type.

CE-compliant

Note) CE-compliant: For DC only.

Thread type

Nil	Rc
F	G
N	NPT
T	NPTF

Light/Surge voltage suppressor

Note) Z: Positive common specifications only.
 * Power saving circuit is only available for the "Z" type.

CE-compliant

Note) CE-compliant: For DC only.

Thread type

Nil	Rc
F	G
N	NPT
T	NPTF

Light/Surge voltage suppressor

Note) Z: Positive common specifications only.
 * Power saving circuit is only available for the "Z" type.

CE-compliant

Note) CE-compliant: For DC only.

Thread type

Nil	Rc
F	G
N	NPT
T	NPTF

Light/Surge voltage suppressor

Note) Z: Positive common specifications only.
 * Power saving circuit is only available for the "Z" type.

CE-compliant

Note) CE-compliant: For DC only.

Thread type

Nil	Rc
F	G
N	NPT
T	NPTF

Light/Surge voltage suppressor

Note) Z: Positive common specifications only.
 * Power saving circuit is only available for the "Z" type.

CE-compliant

Note) CE-compliant: For DC only.

Thread type

Nil	Rc
F	G
N	NPT
T	NPTF

Light/Surge voltage suppressor

Note) Z: Positive common specifications only.
 * Power saving circuit is only available for the "Z" type.

CE-compliant

Note) CE-compliant: For DC only.

Thread type

Nil	Rc
F	G
N	NPT
T	NPTF

Light/Surge voltage suppressor

Note) Z: Positive common specifications only.
 * Power saving circuit is only available for the "Z" type.

CE-compliant

Note) CE-compliant: For DC only.

Thread type

Nil	Rc
F	G
N	NPT
T	NPTF

Light/Surge voltage suppressor

Note) Z: Positive common specifications only.
 * Power saving circuit is only available for the "Z" type.

CE-compliant

Note) CE-compliant: For DC only.

Thread type

Nil	Rc
F	G
N	NPT
T	NPTF

Light/Surge voltage suppressor

Note) Z: Positive common specifications only.
 * Power saving circuit is only available for the "Z" type.

CE-compliant

Note) CE-compliant: For DC only.

Thread type

Nil	Rc
F	G
N	NPT
T	NPTF

Light/Surge voltage suppressor

Note) Z: Positive common specifications only.
 * Power saving circuit is only available for the "Z" type.

CE-compliant

Note) CE-compliant: For DC only.

Thread type

Nil	Rc
F	G
N	NPT
T	NPTF

Light/Surge voltage suppressor

Note) Z: Positive common specifications only.
 * Power saving circuit is only available for the "Z" type.

CE-compliant

Note) CE-compliant: For DC only.

Thread type

Nil	Rc
F	G
N	NPT
T	NPTF

Light/Surge voltage suppressor

Note) Z: Positive common specifications only.
 * Power saving circuit is only available for the "Z" type.

CE-compliant

Note) CE-compliant: For DC only.

Thread type

Nil	Rc
F	G
N	NPT
T	NPTF

Light/Surge voltage suppressor

Note) Z: Positive common specifications only.
 * Power saving circuit is only available for the "Z" type.

CE-compliant

Note) CE-compliant: For DC only.

Thread type

Nil	Rc
F	G
N	NPT
T	NPTF

Light/Surge voltage suppressor

Note) Z: Positive common specifications only.
 * Power saving circuit is only available for the "Z" type.

CE-compliant

Note) CE-compliant: For DC only.

Thread type

Nil	Rc
F	G
N	NPT
T	NPTF

Light/Surge voltage suppressor

Note) Z: Positive common specifications only.
 * Power saving circuit is only available for the "Z" type.

CE-compliant

Note) CE-compliant: For DC only.

Thread type

Nil	Rc
F	G
N	NPT
T	NPTF

Light/Surge voltage suppressor

Note) Z: Positive common specifications only.
 * Power saving circuit is only available for the "Z" type.

CE-compliant

Note) CE-compliant: For DC only.

Thread type

Nil	Rc
F	G
N	NPT
T	NPTF

Light/Surge voltage suppressor

Note) Z: Positive common specifications only.
 * Power saving circuit is only available for the "Z" type.

CE-compliant

Note) CE-compliant: For DC only.

Thread type

Nil	Rc
F	G
N	NPT
T	NPTF

Light/Surge voltage suppressor

Note) Z: Positive common specifications only.
 * Power saving circuit is only available for the "Z" type.

CE-compliant

Note) CE-compliant: For DC only.

Thread type

Nil	Rc
F	G
N	NPT
T	NPTF

Light/Surge voltage suppressor

Note) Z: Positive common specifications only.
 * Power saving circuit is only available for the "Z" type.

CE-compliant

Note) CE-compliant: For DC only.

Thread type

Nil	Rc
F	G
N	NPT
T	NPTF

Light/Surge voltage suppressor

Note) Z: Positive common specifications only.
 * Power saving circuit is only available for the "Z" type.

CE-compliant

Note) CE-compliant: For DC only.

Thread type

Nil	Rc
F	G
N	NPT
T	NPTF

Light/Surge voltage suppressor

Note) Z: Positive common specifications only.
 * Power saving circuit is only available for the "Z" type.

CE-compliant

Note) CE-compliant: For DC only.

Thread type

Nil	Rc
F	G
N	NPT
T	NPTF

Light/Surge voltage suppressor

Note) Z: Positive common specifications only.
 * Power saving circuit is only available for the "Z" type.

CE-compliant

Note) CE-compliant: For DC only.

Thread type

Nil	Rc
F	G
N	NPT
T	NPTF

Light/Surge voltage suppressor

Note) Z: Positive common specifications only.
 * Power saving circuit is only available for the "Z" type.

CE-compliant

Note) CE-compliant: For DC only.

Thread type

Nil	Rc
F	G
N	NPT
T	NPTF

Light/Surge voltage suppressor

Note) Z: Positive common specifications only.
 * Power saving circuit is only available for the "Z" type.

CE-compliant

Note) CE-compliant: For DC only.

Thread type

Nil	Rc
F	G
N	NPT
T	NPTF

Light/Surge voltage suppressor

Note) Z: Positive common specifications only.
 * Power saving circuit is only available for the "Z" type.

CE-compliant

Note) CE-compliant: For DC only.

Thread type

Nil	Rc
F	G
N	NPT
T	NPTF

Light/Surge voltage suppressor

Note) Z: Positive common specifications only.
 * Power saving circuit is only available for the "Z" type.

CE-compliant

Note) CE-compliant: For DC only.

Thread type

Nil	Rc
F	G
N	NPT
T	NPTF

Manifold Specifications

- Multiple valve wiring is simplified through the use of the flat ribbon cable connector.
- Clean appearance

For flat ribbon cables, each valve is wired on the print board of the manifold base to allow the external wiring to be piped all together with the 26 pin MIL connector.



Model	10-SS5Y9-23P(-Q)	
Applicable valve	10-SY9□20	
Manifold type	Stacking type	
P (SUP)/R (EXH)	Common SUP, Common EXH	
Valve stations	4 to 12 stations ^{Note 1)}	
A, B port location	Valve	
Port size	P, EA, EB port	3/8
	A, B port	1/4
		3/8
		C8 (ø8 One-touch fitting) C10 (ø10 One-touch fitting) C12 (ø12 One-touch fitting)
Manifold base weight W (g)	W = 73n + 259	
Applicable flat ribbon cable connector	Flat ribbon cable connector, Socket: 26 pin MIL with strain relief, Conforming to MIL-C-83503	
Internal wiring	Common between +COM and -COM (Z type: +COM only)	
Rated voltage ^{Note 4)}	12, 24 VDC, 100, 110 VAC	

Note 1) For more than 10 stations, supply pressure to P port on both sides and exhaust from EA/EB port on both sides.
 Note 2) The withstand voltage specification for the wiring unit section is JIS C 0704, Grade 1 or its equivalent.
 Note 3) Refer to "Manifold Option" on page 100.
 Note 4) CE-compliant: For DC only.

Connector Assembly

For 12, 24 VDC

Specifications	For 10-SY9000
For single solenoid	SY9000-37-1A
Double solenoid 3 position	SY9000-37-2A
Single with spacer assembly	SY9000-37-3A
Double, 3 position with spacer assembly	SY9000-37-4A

For 100 VAC

Specifications	For 10-SY9000
For single solenoid	SY9000-37-1B
Double solenoid 3 position	SY9000-37-2B
Single with spacer assembly	SY9000-37-3B
Double, 3 position with spacer assembly	SY9000-37-4B

For 110 VAC (115 VAC)

Specifications	For 10-SY9000
For single solenoid	SY9000-37-1C
Double solenoid 3 position	SY9000-37-2C
Single with spacer assembly	SY9000-37-3C
Double, 3 position with spacer assembly	SY9000-37-4C

Note) Spacer assembly indicates individual SUP/EXH.

Flow Rate Characteristics

Model	Port size		Flow rate characteristics					
	1, 5, 3 (P, EA, EB)	4, 2 (A, B)	1 → 4/2 (P → A/B)		4/2 → 5/3 (A/B → EA/EB)			
			C (dm ³ /s/bar)	b	Cv	C (dm ³ /s/bar)	b	Cv
10-SS5Y9-23P(-Q)	3/8	C12	6.3	0.20	1.5	8.2	0.28	1.9

Note) The values are for individually operated 2 position type manifold bases with 5 stations.

Internal Wiring of Manifold

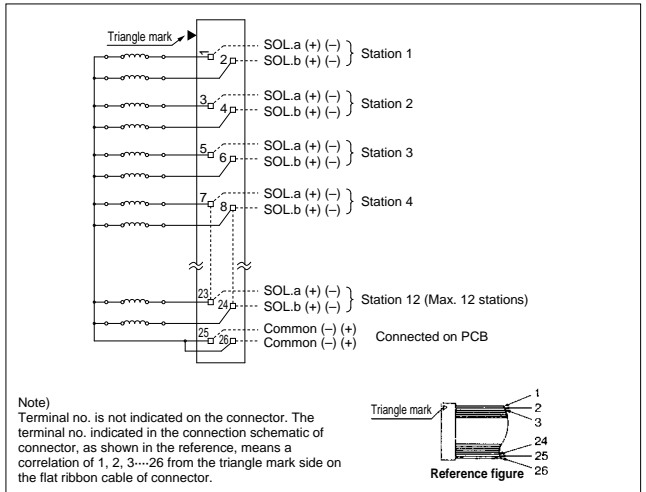

Note)
 Terminal no. is not indicated on the connector. The terminal no. indicated in the connection schematic of connector, as shown in the reference, means a correlation of 1, 2, 3...26 from the triangle mark side on the flat ribbon cable of connector.

- For more than 10 stations, both poles of the common should be wired.
- For single solenoid, connect to the solenoid A side.
- The maximum number of stations that can be accommodated is 12. For more stations, please contact SMC.

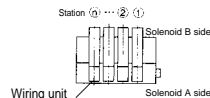

Caution

- For non-polar "U" valves, the electrical DC connections can be used with either positive and negative COM. For type "Z", only use with positive COM as the valve does not operate correctly when used with negative COM.

Directional Control Valves
 Air Cylinders
 Rotary Actuators
 Air Grippers
 Air Preparation Equipment
 Modular F. R.
 Pressure Control Equipment
 Fittings & Tubing
 Flow Control Equipment
 Pressure Switches/ Pressure Sensors

10-SY9000: 10-SS5Y9-23P- Stations -(D)

[] : AC

Grommet (G)

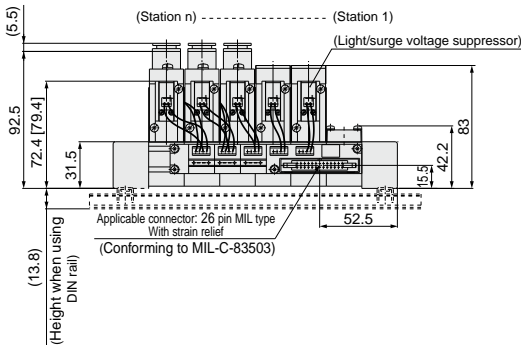
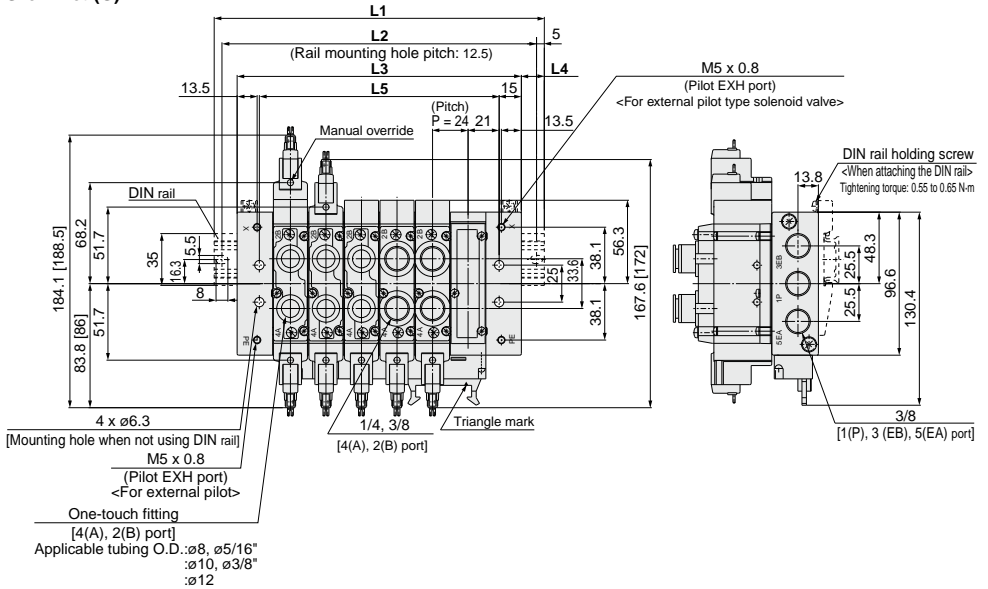

Stations	4 stations	5	6	7	8	9	10	11	12 stations
L1	173	198	223	248	273	298	323	335.5	360.5
L2	162.5	187.5	212.5	237.5	262.5	287.5	312.5	325	350
L3	144	168	192	216	240	264	288	312	336
L4	14.5	15	15.5	16	16.5	17	17.5	12	12.5
L5	114	138	162	186	210	234	258	282	306

Note) For direct mounting without DIN rail, total width of manifold is L3.

Type 20SA Series 10-SY3000/5000/7000

EX510 Gateway-type
Serial Transmission System
Body Ported Manifold/Integrated Base



Directional
Control Valves

Air Cylinders

Rotary Actuators

Air Grippers

Air Preparation
Equipment

Modular F. R.

Pressure Control
Equipment

Fittings & Tubing

Flow Control
Equipment

Pressure Switches/
Pressure Sensors

How to Order Manifold

10 - SS5Y 3 - 20SA [] - 04 - [] - []

• Clean series

Manifold series

3	10-SY3000
5	10-SY5000
7	10-SY7000

SI unit

Nil	NPN output (+COM.)
N	PNP output (-COM.)

SI unit part no.

Symbol	SI unit specifications	SI unit part no.
Nil	NPN output (+COM.)	EX510-S001
N	PNP output (-COM.)	EX510-S101

Refer to the **WEB catalog** and the Operation Manual for the details of the EX510 Gateway-type Serial Transmission System. Please download the Operation Manual via our website, <http://www.smcworld.com>

• CE-compliant

Nil	—
Q	CE-compliant

• P, R port thread type

Nil	Rc
00F	G
00N	NPT
00T	NPTF

• Valve stations

Symbol	Stations	Note
03	3 stations	Double wiring ^{Note 1)}
:	:	
08	8 stations	Specified layout ^{Note 2)} (Compatible with 16 solenoid valves)
03	3 stations	
:	:	
16	16 stations	

- 10-SS5Y3 can be set from 4 stations.
- The number of the blanking plate assembly is also included.
- Note 1) Double wiring: Use of a single solenoid will result in an unused control signal. If this is not desired, order with a specified layout.
- Note 2) Specified layout: Indicate wiring specifications on the manifold specification sheet. (Note that double and 3 position valves cannot be used where single solenoid wiring has been specified.)

How to Order Manifold Assembly (Example)

Example

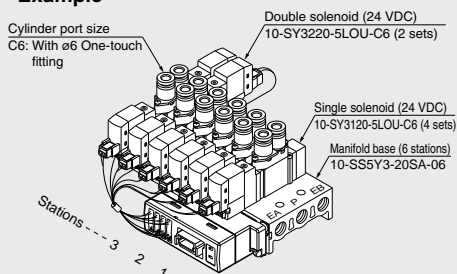

10-SS5Y3-20SA-06 1 set (20SA type 6-station manifold part no.)
 * 10-SY3120-5LOU-C6 ... 4 sets (Single solenoid part no.)
 * 10-SY3220-5LOU-C6 ... 2 sets (Double solenoid part no.)

↳ The asterisk denotes the symbol for assembly. Prefix to the part no. of the solenoid valve, etc.

Add the valve and option part number under the manifold base part number.
 When entry of part numbers becomes complicated, indicate by the manifold specification sheet. For a EX510 manifold, the length of the lead wire for a connector assembly depends on the number of stations. Therefore, the manifold assembly is shipped with the valves (including blanking plates) and connector assembly mounted on it, as the standard specification. Be sure to specify the part no. of the solenoid valves to be mounted.

How to Order Valve

10-SY 3 1 20 [] - **5 LO Z** [] - **M5** [] - []

• **Clean series**

• **Series**

3	10-SY3000
5	10-SY5000
7	10-SY7000

• **Actuation type**

1	2 position single
2	2 position double
3	3 position closed center
4	3 position exhaust center
5	3 position pressure center

• **Coil type**

Nil	Standard
T	With power saving circuit

Rated voltage: 24 VDC

• **Light/Surge voltage suppressor**

Z	With light/surge voltage suppressor
U	With light/surge voltage suppressor (Non-polar type)

Note 1) Power saving circuit is only available for the "Z" type.

Note 2) When the SI unit is the PNP output (-COM.), only the "U" type is available.

• **Manual override**

Nil	Non-locking push type
D	Push-turn locking slotted type
E	Push-turn locking lever type

• **CE-compliant**

Nil	—
Q	CE-compliant

• **Thread type**

Nil	Rc
F	G
N	NPT
T	NPTF

• **A, B port size**

Thread piping

M5	M5 x 0.8	10-SY3000
01	1/8	10-SY5000
02	1/4	10-SY7000

• **One-touch fitting (Metric size)**

C4	ø4 One-touch fitting	10-SY3000
C6	ø6 One-touch fitting	
C4	ø4 One-touch fitting	10-SY5000
C6	ø6 One-touch fitting	
C8	ø8 One-touch fitting	10-SY7000
C8	ø8 One-touch fitting	
C10	ø10 One-touch fitting	

• **One-touch fitting (Inch size)**

N3	ø5/32" One-touch fitting	10-SY3000
N7	ø1/4" One-touch fitting	
N3	ø5/32" One-touch fitting	10-SY5000
N7	ø1/4" One-touch fitting	
N9	ø5/16" One-touch fitting	10-SY7000
N9	ø5/16" One-touch fitting	
N11	ø3/8" One-touch fitting	

Note) When placing an order for body ported solenoid valves as a single unit, the mounting screws for the manifold and gasket are not attached. Order them separately, if necessary.

■ **Gasket assembly part no.**

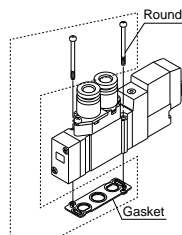

Series	Gasket assembly part no.
10-SY3000	SY3000-GS-1
10-SY5000	SY5000-GS-1
10-SY7000	SY7000-GS-1

Note) The gasket assembly consists of 10 sets of mounting screws and a gasket.

10-SY5000: 10-SS5Y5-20SA - Stations -

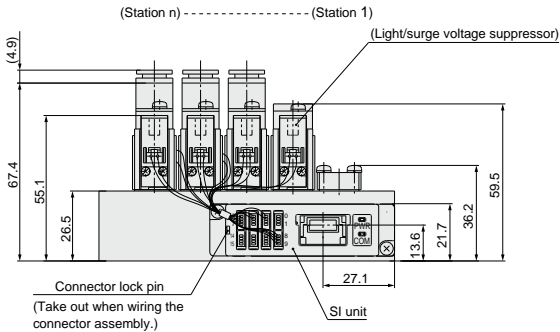
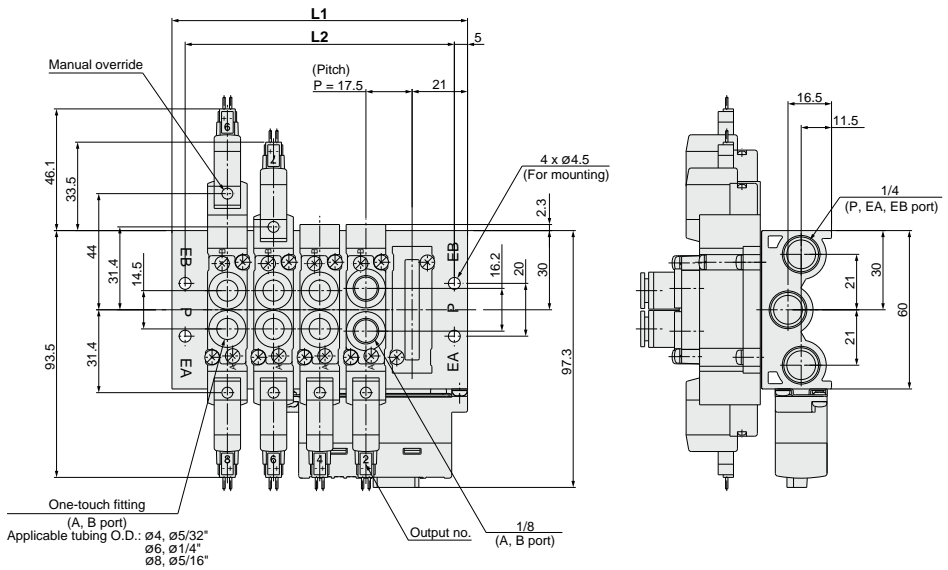

Stations	3 stations	4	5	6	7	8	9	10	11	12	13	14	15	16 stations
L1	77	94.5	112	129.5	147	164.5	182	199.5	217	234.5	252	269.5	287	304.5
L2	67	84.5	102	119.5	137	154.5	172	189.5	207	224.5	242	259.5	277	294.5

10-SY7000: 10-SS5Y7-20SA - Stations -

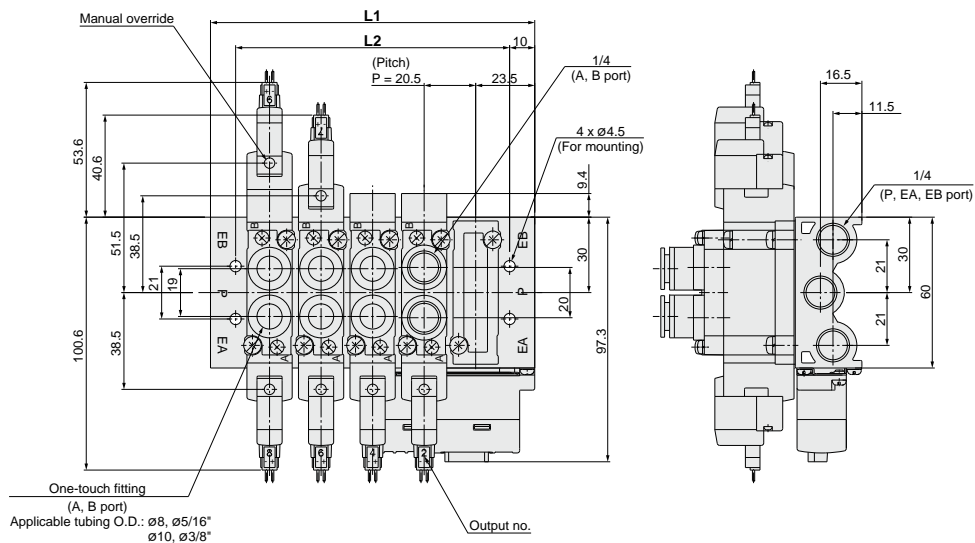

(Station n) ----- (Station 1)

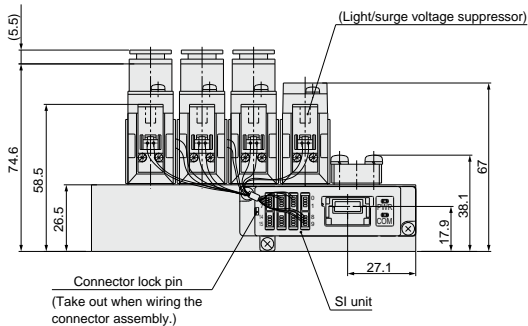

Stations	3 stations	4	5	6	7	8	9	10	11	12	13	14	15	16 stations
L1	88	108.5	129	149.5	170	190.5	211	231.5	252	272.5	293	313.5	334	354.5
L2	68	88.5	109	129.5	150	170.5	191	211.5	232	252.5	273	293.5	314	334.5

Directional Control Valves

Air Cylinders

Rotary Actuators

Air Grippers

Air Preparation Equipment

Modular F. R.

Pressure Control Equipment

Fittings & Tubing

Flow Control Equipment

Pressure Switches/ Pressure Sensors



How to Order Manifold

10-SS5Y9-23SA [] - 03 - [] - [] - []

• Clean series

SI unit*

NII	NPN output (+COM.)
N	PNP output (-COM.)

• CE-compliant

NII	—
Q	CE-compliant

Valve stations •

Symbol	Stations	Note
03	3 stations	Double wiring ^{Note 1)}
⋮	⋮	
08	8 stations	
03	3 stations	Specified layout ^{Note 2)} (Compatible with 16 solenoid valves)
⋮	⋮	
16	16 stations	

- The number of the blanking plate assembly is also included.
- Note 1) Double wiring: Use of a single solenoid will result in an unused control signal. If this is not desired, order with a specified layout.
- Note 2) Specified layout: Indicate wiring specifications on the manifold specification sheet. (Note that double and 3 position valves cannot be used where single solenoid wiring has been specified.)

• Option

NII	Direct mounting
D	DIN rail mounting (With DIN rail)
DO	DIN rail mounting (Without DIN rail)
D*	When a longer DIN rail is desired than the specified stations, specify the station number to be required in place of the * mark.

• P, R port thread type

NII	Rc
00F	G
00N	NPT
00T	NPTF

SI unit part no.

Symbol	SI unit specifications	SI unit part no.
NII	NPN output (+COM.)	EX510-S001
N	PNP output (-COM.)	EX510-S101

Refer to the **WEB catalog** and the Operation Manual for the details of the EX510 Gateway-type Serial Transmission System. Please download the Operation Manual via our website, <http://www.smworld.com>

How to Order Manifold Assembly (Example)

Example

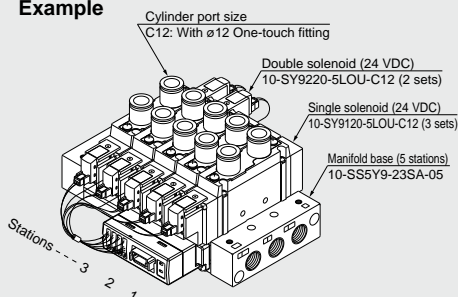

10-SS5Y9-23SA-05 1 set (23SA type 5-station manifold part no.)
 * 10-SY9120-5LOU-C12 ... 3 sets (Single solenoid part no.)
 * 10-SY9220-5LOU-C12 ... 2 sets (Double solenoid part no.)

— The asterisk denotes the symbol for assembly. Prefix to the part no. of the solenoid valve, etc.

Add the valve and option part number under the manifold base part number.
 When entry of part numbers becomes complicated, indicate by the manifold specification sheet. For a EX510 manifold, the length of the lead wire for a connector assembly depends on the number of stations. Therefore, the manifold assembly is shipped with the valves (including blanking plates) and connector assembly mounted on it, as the standard specification. Be sure to specify the part no. of the solenoid valves to be mounted.

How to Order Valve

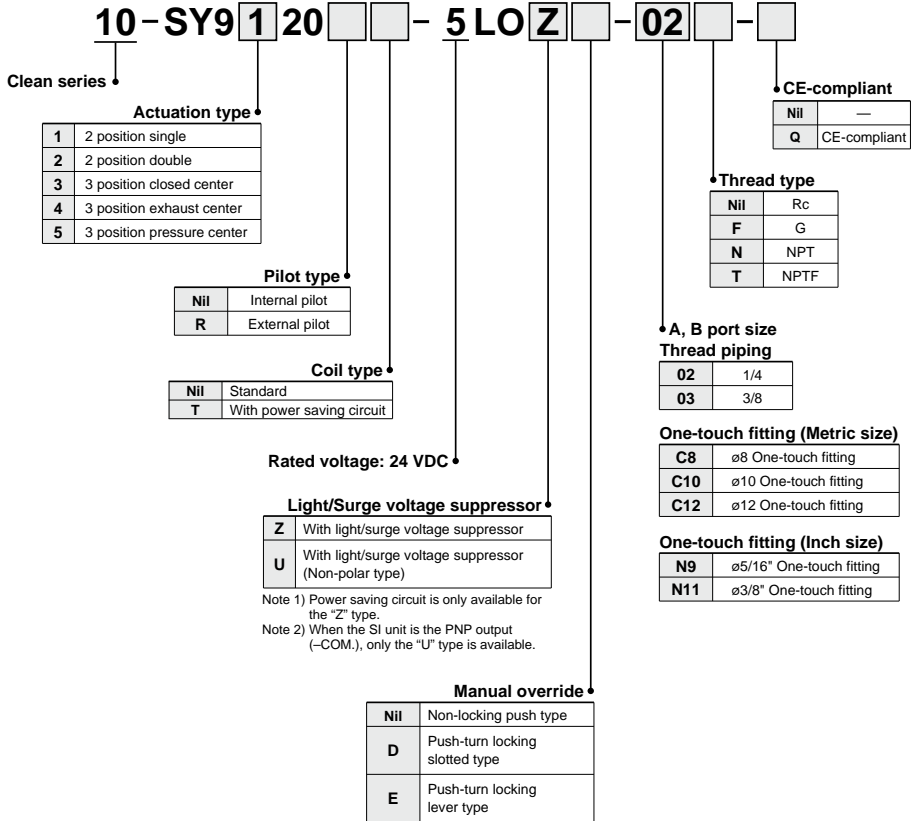

Directional Control Valves

Air Cylinders

Rotary Actuators

Air Grippers

Air Preparation Equipment

Modular F. R.

Pressure Control Equipment

Fittings & Tubing

Flow Control Equipment

Pressure Switches/ Pressure Sensors

Note) When placing an order for body ported solenoid valves as a single unit, the mounting screws for the manifold and gasket are not attached. Order them separately, if necessary.

Gasket assembly part no.

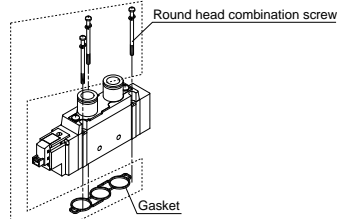

Series	Gasket assembly part no.
10-SY9000	SY9000-GS-1

Note) The gasket assembly consists of 10 sets of mounting screws and a gasket.

10-SY9000: 10-SS5Y9-23SA - Stations - (-D)

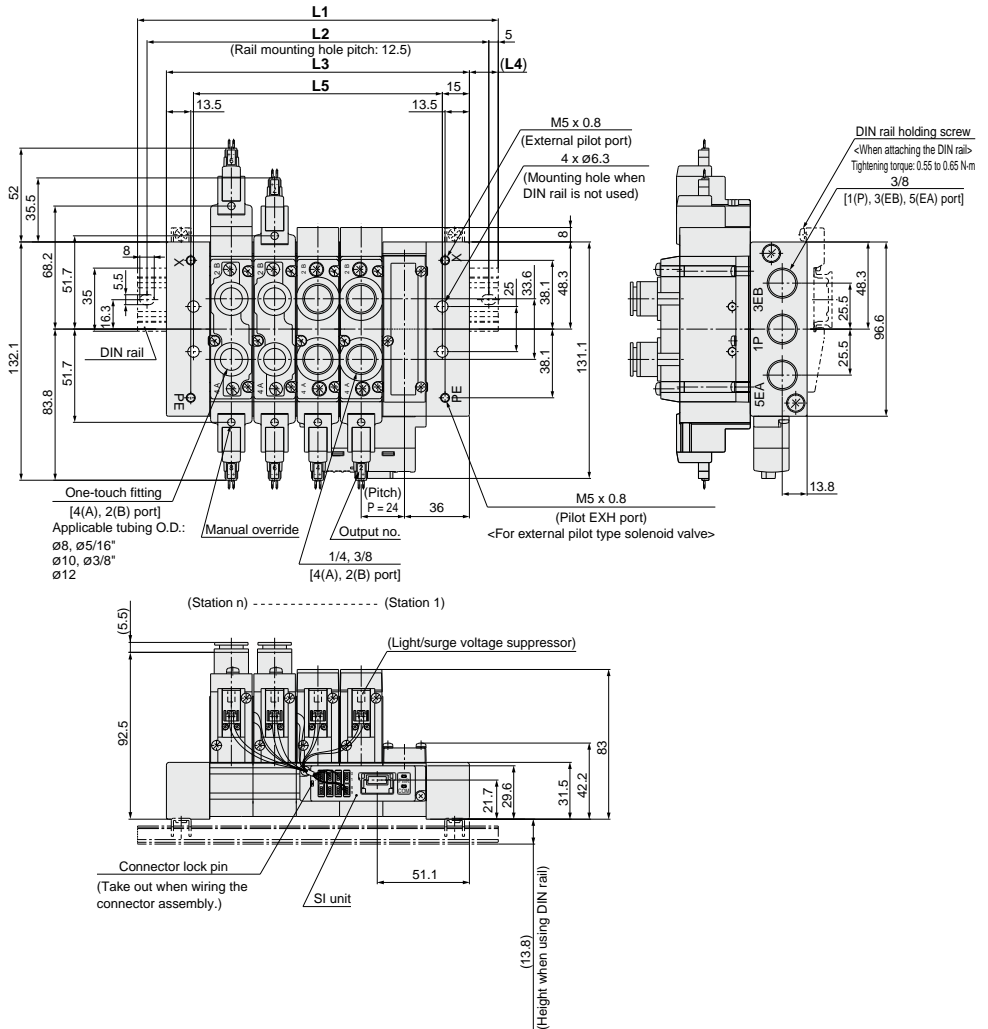

Stations	3 stations	4	5	6	7	8	9	10	11	12	13	14	15	16 stations
L1	148	173	198	223	248	273	298	323	335.5	360.5	385.5	410.5	435.5	460.5
L2	137.5	162.5	187.5	212.5	237.5	262.5	287.5	312.5	325	350	375	400	425	450
L3	120	144	168	192	216	240	264	288	312	336	360	384	408	432
L4	14	14.5	15	15.5	16	16.5	17	17.5	12	12.5	13	13.5	14	14.5
L5	90	114	138	162	186	210	234	258	282	306	330	354	378	402

Note) For direct mounting without DIN rail, total width of manifold is L3.

Manifold Option

■ Type 20, 23, 20SA, 23SA Blanking plate assembly



<Standard>

Series	Assembly part no.
10-SY3000	SY3000-26-9A
10-SY5000	SY5000-26-20A
10-SY7000	SY7000-26-22A
10-SY9000	SY9000-26-1A

<CE-compliant>

Series	Assembly part no.
10-SY3000	SY3000-26-19A-Q
10-SY5000	SY5000-26-1A-Q
10-SY7000	SY7000-26-1A-Q
10-SY9000	SY9000-26-1A

■ Type 20P, 23P Blanking plate assembly



<Standard>

Series	Assembly part no.
10-SY3000	SY3000-26-10A
10-SY5000	SY5000-26-21A
10-SY7000	SY7000-26-23A
10-SY9000	SY9000-26-3A

<CE-compliant>

Series	Assembly part no.
10-SY3000	SY3000-26-20A-Q
10-SY5000	SY5000-26-3A-Q
10-SY7000	SY7000-26-3A-Q
10-SY9000	SY9000-26-3A

■ Gasket assembly part no.

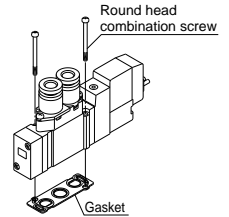

Series	Gasket assembly part no.
10-SY3000	SY3000-GS-1
10-SY5000	SY5000-GS-1
10-SY7000	SY7000-GS-1
10-SY9000	SY9000-GS-1

Note) The gasket assembly consists of 10 sets of mounting screws and a gasket.

■ Individual SUP spacer assembly

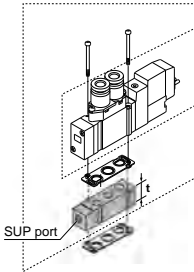

Series	Assembly part no.	Port size	t
10-SY3000	SY3000-38-20A(-Q)	M5 x 0.8	10.5
10-SY5000	SY5000-38-1+A(-Q)	1/8	15
10-SY7000	SY7000-38-1+A(-Q)	1/4	18
10-SY9000	SY9000-38-1+A	1/4	20

Note) • The SUP port of 10-SY3000/5000/7000 may be either on the lead wire side or on the end plate side. (An assembly is shipped under the conditions shown in the figure.)
• The end plate side is only available for 10-SY9000.

■ Individual EXH spacer assembly

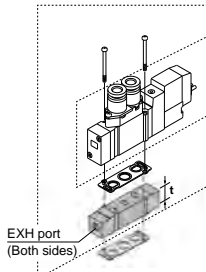

Series	Assembly part no.	Port size	t
10-SY3000	SY3000-39-20A(-Q)	M5 x 0.8	10.5
10-SY5000	SY5000-39-1+A(-Q)	1/8	15
10-SY7000	SY7000-39-1+A(-Q)	1/4	18
10-SY9000	SY9000-39-1+A	1/4	20

Note) In case of 20P and 23P, for protection of the wiring unit section from drainage, piping at the EA port should be arranged so that it will not be directly exposed to exhaust from the valve.

■ Individual SUP spacer assembly + Individual EXH spacer assembly (Double spacer)

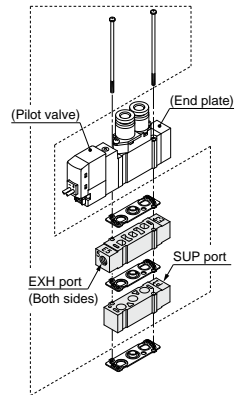

●: Available ×: Not available

Series	Individual SUP + Individual EXH Assembly part no.	Port size	Applicable manifold types	
			20	20P
10-SY3000	SY3000-120-1A(-Q)	M5 x 0.8	●	×
10-SY5000	SY5000-75-2+A(-Q)	1/8	●	×
10-SY7000	SY7000-73-3+A(-Q)	1/4	●	×

Note) The SUP spacer's port does not have an orientation. As for the EXH ports, adjust the symbol "S" to the pilot valve side. Also, please make sure to connect the individual ports to protect the wiring section of the pilot valve from drainage, etc.
The individual SUP spacer and EXH spacer can be mounted either on the upper side or lower side. (The above illustration shows the condition when the product is shipped out from a factory.)

⚠ Caution

Mounting screw tightening torques

- M2: 0.16 N·m
- M3: 0.8 N·m
- M4: 1.4 N·m

* Thread type

Nil	Rc
F	G
N	NPT
T	NPTF

⚠ Warning

When mounting a valve or spacer on the manifold base or sub-plate, etc., those mounting directions are determined. If mounted in the wrong direction, the equipment to be connected may cause malfunction. Refer to external dimensions, and then mount it.

Manifold Option

■ Connector assembly

For single solenoid (SY3000-37-81A-□-N)

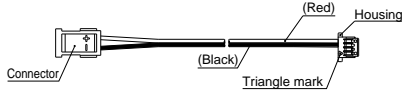

For double solenoid (SY3000-37-81A-□-□)

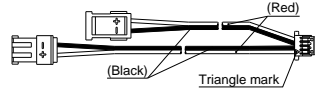

Connector assembly order no. (Can be used for the manifold without a specified layout (8 stations or less))
Integrated type

Model	Part no.	Connector mounting position
10-SS5Y3-20SA	SY3000-37-81A-3-N	Single : For 1 to 4 stations
	SY3000-37-81A-3-6	Double/3 position: For 1 to 4 stations
	SY3000-37-81A-2-N	Single : For 5 to 8 stations
	SY3000-37-81A-2-4	Double/3 position: For 5 to 8 stations
10-SS5Y5-20SA	SY3000-37-81A-3-N	Single : For 1 to 8 stations
	SY3000-37-81A-3-6	Double/3 position: For 1 to 8 stations
10-SS5Y7-20SA	SY3000-37-81A-3-N	Single : For 1 to 4 stations
	SY3000-37-81A-3-6	Double/3 position: For 1 to 4 stations
	SY3000-37-81A-4-N	Single : For 5 to 8 stations
	SY3000-37-81A-4-7	Double/3 position: For 5 to 8 stations

Note) The above is for station addition or maintenance. When ordering a connector assembly separately, the number is not printed on the connector.

■ Connector assembly

SY3000-37-80A-□

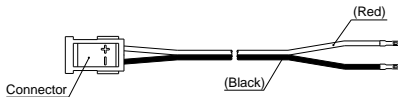

■ Housing (8 pcs/set)

SY3000-44-3A

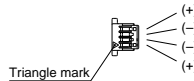

Connector assembly order no. (Can be used for the manifold with a specified layout)

Model	Part no.	Connector mounting position
10-SS5Y3-20SA	SY3000-37-80A-3	For A side
	SY3000-37-80A-6	For B side
	SY3000-37-80A-4	For A side
	SY3000-37-80A-7	For B side
10-SS5Y5-20SA	SY3000-37-80A-3	For A side
	SY3000-37-80A-6	For B side
	SY3000-37-80A-7	For A side
	SY3000-37-80A-9	For B side
10-SS5Y7-20SA	SY3000-37-80A-4	For A side
	SY3000-37-80A-7	For B side
	SY3000-37-80A-8	For A side
	SY3000-37-80A-11	For B side
10-SS5Y9-23SA	SY3000-37-80A-6	For A side
	SY3000-37-80A-11	For B side
	SY3000-37-80A-9	For A side
	SY3000-37-80A-14	For B side
	SY3000-37-80A-13	For A side
	SY3000-37-80A-18	For B side

Note 1) The above is for station addition or maintenance. When ordering a connector assembly separately, the number is not printed on the connector.

Note 2) After inserting the connector assembly into the housing, be sure to confirm that the lead wire will not come off by lightly pulling the wire. Furthermore, do not reuse the lead wire after it has been inserted and removed.

Note 3) Wiring is set longer than the actual wiring distance.

Manifold Option

■ SUP block disk (For 10-SY9000)

By installing a SUP block disk in the pressure supply passage of a manifold valve, it is possible to supply two or more different high and low pressures to one manifold.



Series	Part no.
10-SY9000	SY9000-61-2A

■ EXH block disk (For 10-SY9000)

By installing an EXH block disk in the exhaust passage of a manifold valve, it is possible to divide the valve's exhaust so that it does not affect another valve. (Two block disks are needed to divide both exhausts.)



Series	Part no.
10-SY9000	SY9000-61-2A

■ Label for block disk (For 10-SY9000)

The labels shown below are used on manifold stations containing SUP/EXH block disk(s) to show their location. (3 pcs. each)

VZ3000-123-1A

Label for SUP block disk



Label for EXH block disk

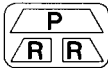

Label for SUP/EXH block disk



* When a block disk is concurrently ordered by specifying it on the manifold specification sheet, etc., a label will be attached to the position where the block disk is mounted.

■ DIN Rail Dimensions/Weight for 10-SY9000

VZ1000-11-4-□

Refer to L dimensions

* Fill in □ with an appropriate no. listed on the table of DIN rail dimensions shown below.

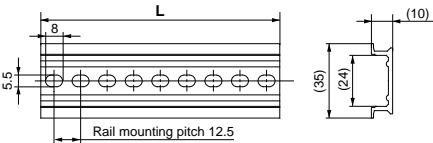

No.	0	1	2	3	4	5	6	7	8	9
L Dimension	98	110.5	123	135.5	148	160.5	173	185.5	198	210.5
Weight (g)	24.8	28	31.1	34.3	37.4	40.6	43.8	46.9	50.1	53.3
No.	10	11	12	13	14	15	16	17	18	19
L Dimension	223	235.5	248	260.5	273	285.5	298	310.5	323	335.5
Weight (g)	56.4	59.6	62.7	65.9	69.1	72.2	75.4	78.6	81.7	84.9
No.	20	21	22	23	24	25	26	27	28	29
L Dimension	348	360.5	373	385.5	398	410.5	423	435.5	448	460.5
Weight (g)	88	91.2	94.4	97.5	100.7	103.9	107	110.2	113.3	116.5

Note) For DIN rail, refer to page 175.

- Refer to L1 dimension on pages 82, 91 and 99 for lengths that correspond to the number of manifold stations.

■ Cable assembly (For 20P, 23P)

AXT100-FC26-1

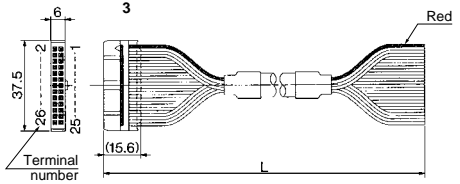

Connector Assembly for Flat Ribbon Cables

Cable length (L)	Assembly part no.	Note
1.5 m	AXT100-FC26-1	Cable 26 core x 28 AWG
3 m	AXT100-FC26-2	
5 m	AXT100-FC26-3	

* For other commercial connectors, use a 26 pin connector with strain relief conforming to MIL-C-83503.

Example of connector manufacturers

- HIROSE ELECTRIC CO., LTD.
- Japan Aviation Electronics Industry, Limited
- 3M Japan Limited
- J.S.T. Mfg. Co., Ltd.
- Fujitsu Limited

■ Plug (white)

These are inserted in unused cylinder ports and SUP, EXH ports. Purchase orders are available in units of 10 pieces.

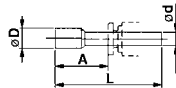

Dimensions

Applicable fittings size ød	Model	A	L	D
4	10-KQ2P-04	16	32	6
6	10-KQ2P-06	18	35	8
8	10-KQ2P-08	20.5	39	10
10	10-KQ2P-10	22	43	12
12	10-KQ2P-12	24	44.5	14
1/8"	10-KQ2P-01	16	31.5	5
5/32"	10-KQ2P-03	16	32	6
1/4"	10-KQ2P-07	18	35	8.5
5/16"	10-KQ2P-09	20.5	39	10
3/8"	10-KQ2P-11	22	43	11.5

Directional Control Valves
 Air Cylinders
 Rotary Actuators
 Air Grippers
 Air Preparation Equipment
 Modular F. R.
 Pressure Control Equipment
 Fittings & Tubing
 Flow Control Equipment
 Pressure Switches/ Pressure Sensors

How to Increase Manifold Bases (10-SY9000 series only) Manifold base can be added at any location.

When a type 23 manifold base is added, tension bolts as well as a manifold block assembly is required. Order the tension bolt for the stations after the stations are increased (decreased), since the length of a tension bolt depends on the number of stations. (When changing the number of stations for a type 23P manifold, a wiring unit for the stations and lead assembly will be required.)

- 1 Loosen the tension bolts ⑤ connecting the manifold base, and pull out both of the tension bolts.
(When equipped with a DIN rail, loosen one DIN rail holding screw on either U side or D side.)
- 2 Separate the blocks at the location where station expansion is desired.
- 3 Mount additional manifold block assembly.
- 4 Press block-to-block so that there is no gap. After connection, insert the tension bolts for the desired stations and then tighten them.

Caution (Tightening torque: 2.9 N·m)

(When equipped with a DIN rail, be sure to tighten the DIN rail holding screws after tightening the tension bolts. Tightening torque: 1.4 N·m)

Caution

1. Be sure to shut off the power and air supplies before disassembly. Furthermore, since air may remain inside the actuator, piping and manifold, confirm that the air is completely exhausted before performing any work.
2. When disassembly and assembly are performed, air leakage may result if connections between blocks and tightening of the end block's holding screw is inadequate.
3. By adding a wiring unit assembly to the type 23 manifold, it can be changed to the type 23P manifold.

Body Ported Manifold Exploded View, 23/23P Common

For the body ported manifold, disassembly and increases in the manifold are only possible with the 10-SY9000 series.

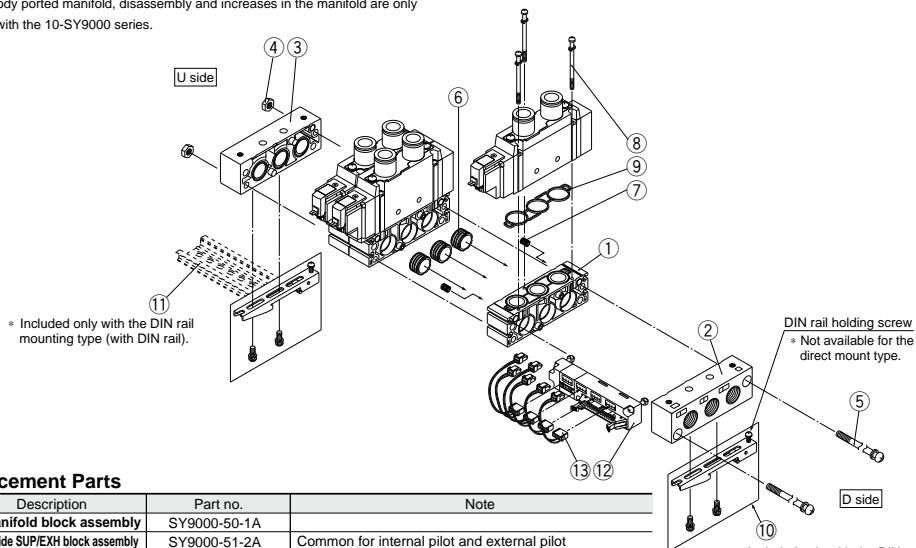

Replacement Parts

No.	Description	Part no.	Note
1	Manifold block assembly	SY9000-50-1A	
2	D side SUP/EXH block assembly	SY9000-51-2A	Common for internal pilot and external pilot
3	U side SUP/EXH block	SY9000-51-4	Common for internal pilot and external pilot
4	Hexagon nut	SY9000-25-1	M5 x 0.8
5	Tension bolt	SY9000-23-□	Since □ at the end of the part number corresponds with the number of stations, fill in the same number as the number of stations.
6	Bushing assembly	SY9000-61-1A	Included in the manifold block assembly and the D side SUP/EXH block assembly.
7	Bushing assembly	SY9000-61-3A	Included in the manifold block assembly and the D side SUP/EXH block assembly.
8	Round head combination screw	SY9000-18-2	Included in the manifold block assembly.
9	Manifold gasket	SY9000-11-1	Included in the manifold block assembly.
10	Clamp sub assembly	SY9000-29-1A	
11	DIN rail	VZ1000-11-4-□	Refer to page 102.
12	Wiring unit assembly	SY9000-36-□A	Since □ in the part number corresponds with the number of stations, fill in the number of stations (4 to 12).
13	Connector assembly	SY9000-37-□□	Refer to page 90.

Type 60 Series 10-SY3000/5000/7000

5 Port Solenoid Valve Body Ported Manifold Cassette Type



Note) AC-type models that are CE-compliant have DIN terminals only.

[Option]

An order cannot be placed with only the manifold part no. Be sure to order solenoid valves for mounting at the same time while referring to the ordering example.

How to Order

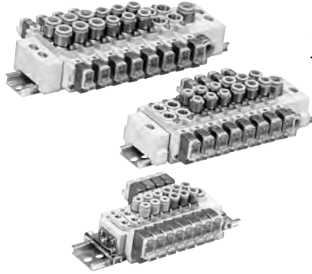

10-SS5Y 3-60-05 D - [] - []

• Clean series

Series

3	10-SY3000
5	10-SY5000
7	10-SY7000

Valve stations

02	2 stations
:	:
20	20 stations

• CE-compliant

Nil	—
Q	CE-compliant

Note) AC-type models that are CE-compliant have DIN terminals only.

• Option

When a longer DIN rail is desired than the specified stations, specify the station number to be required. (20 stations at maximum)

• SUP/EXH block assembly mounting position

Symbol	Mounting position	Applicable stations
U	U side	2 to 10 stations
D	D side	2 to 10 stations
B	Both sides	2 to 20 stations
M	Special specifications	

* For special specifications, indicate separately with the manifold specification sheet.

How to Order Manifold Assembly (Example)

Example

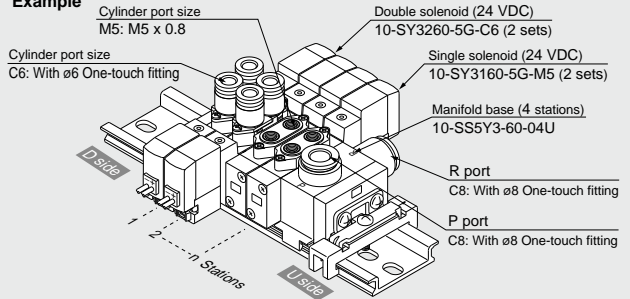

- 10-SS5Y3-60-04U 1 set (Type 60, 4-station manifold base part no.)
- * 10-SY3260-5G-C6 2 sets (Double solenoid part no.)
- * 10-SY3160-5G-M5 2 sets (Single solenoid part no.)

↳ The asterisk denotes the symbol for assembly. Prefix it to the part no. of the solenoid valve, etc.

Add the valve and option part number under the manifold base part number. For complex arrangements, specify them on the manifold specification sheet.

Directional Control Valves

Air Cylinders

Rotary Actuators

Air Grippers

Air Preparation Equipment

Modular F. R.

Pressure Control Equipment

Fittings & Tubing

Flow Control Equipment

Pressure Switches/ Pressure Sensors

Manifold Specifications

Model	10-SS5Y3-60(-Q)	10-SS5Y5-60(-Q)	10-SS5Y7-60(-Q)	
Applicable valve	10-SY3□60	10-SY5□60	10-SY7□60	
Manifold type	Stacking type/DIN rail mounted			
P (SUP)/R (EXH)	Common SUP/Common EXH			
Valve stations	2 to 20 stations ^{Note 1)}			
A, B port location	Valve			
Port size	P, R port	C8 (ø8 One-touch fitting) M5 x 0.8	C10 (ø10 One-touch fitting) 1/8	C12 (ø12 One-touch fitting) 1/4
	A, B port	C4 (ø4 One-touch fitting) C6 (ø6 One-touch fitting)	C4 (ø4 One-touch fitting) C6 (ø6 One-touch fitting) C8 (ø8 One-touch fitting)	C8 (ø8 One-touch fitting) C10 (ø10 One-touch fitting)
Manifold base weight W (g) (n: Number of SUP/EXH blocks, m: Weight of DIN rail) ^{Note 2)}	W = 13n + m + 36	W = 41.2n + m + 77.6	W = 65.4n + m + 128.2	

Note 1) In cases such as those where many valves are operated simultaneously, use "-[Station]B (SUP/EXH block on both sides)", applying pressure to the P ports on both sides and exhausting from the R ports on both sides.

Note 2) For DIN rail weight, refer to page 110.

Flow Rate Characteristics

Model	Port size		Flow rate characteristics					
	1, 5/3 (P, R)	4, 2 (A, B)	1 → 4/2 (P → A/B)			4/2 → 5/3 (A/B → R)		
			C (dm ³ /(s·bar))	b	Cv	C (dm ³ /(s·bar))	b	Cv
10-SS5Y3-60(-Q)	C8	M5	0.55	0.29	0.14	0.72	0.24	0.18
		C4	0.57	0.24	0.14	0.71	0.20	0.17
		C6	0.68	0.28	0.17	0.77	0.24	0.19
10-SS5Y5-60(-Q)	C10	1/8	1.8	0.24	0.44	2.1	0.17	0.47
		C6	1.5	0.30	0.37	2.0	0.16	0.46
		C8	1.8	0.20	0.45	2.2	0.17	0.50
10-SS5Y7-60(-Q)	C12	1/4	3.7	0.25	0.96	3.8	0.19	0.94
		C8	3.2	0.26	0.81	4.0	0.18	0.96
		C10	3.7	0.28	0.98	4.1	0.19	1.0

Note) The values are for individually operated 2 position type manifold bases with 5 stations.



How to Order Valve

Note) AC-type models that are CE-compliant have DIN terminals only.

[Option]

10-SY 3 1 60 - 5 L - C6

• Clean series

Series

3	10-SY3000
5	10-SY5000
7	10-SY7000

Actuation type

1	2 position single (A)4 2(B) (EA)5 1 3(EB) (P)
2	2 position double (A)4 2(B) (EA)5 1 3(EB) (P)
3	3 position closed center (A)4 2(B) (EA)5 1 3(EB) (P)
4	3 position exhaust center (A)4 2(B) (EA)5 1 3(EB) (P)
5	3 position pressure center (A)4 2(B) (EA)5 1 3(EB) (P)

Coil type

Nil	Standard
T	With power saving circuit (24 VDC, 12 VDC only)

* Power saving circuit is not available for D, Y, DO, YO or W□ types.

Rated voltage

5	24 VDC
6	12 VDC
V	6 VDC
S	5 VDC
R	3 VDC

For AC (50/60 Hz)

1	100 VAC
2	200 VAC
3	110 VAC [115 VAC]
4	220 VAC [230 VAC]

* DC specifications of type D, Y, DO and YO are only available with 12 and 24 VDC.
* Only D, Y, DO and YO are available for 10-SY5000, SY7000.

* For type W□, only DC voltage is available.
Note) AC-type models that are CE-compliant have DIN terminals only.

Manifold mounting	10-SY3000	●	●	●	●
	10-SY5000	●	●	●	●
	10-SY7000	●	●	●	●
CE-compliant	DC	●	●	●	●
	AC	—	—	—	—

A, B port size

Thread piping

Symbol	Port size	Applicable series
M5	M5 x 0.8	10-SY3000
O1	1/8	10-SY5000
O2	1/4	10-SY7000

Thread type

Nil	Rc
F	G
N	NPT
T	NPTF

* Except for M5

One-touch fitting (Metric size)

Symbol	Port size	Applicable series
C4	ø4 One-touch fitting	10-SY3000
C6	ø6 One-touch fitting	10-SY3000
C4	ø4 One-touch fitting	10-SY5000
C6	ø6 One-touch fitting	10-SY5000
C8	ø8 One-touch fitting	10-SY5000
C8	ø8 One-touch fitting	10-SY7000
C10	ø10 One-touch fitting	10-SY7000

One-touch fitting (Inch size)

Symbol	Port size	Applicable series
N3	ø5/32" One-touch fitting	10-SY3000
N7	ø1/4" One-touch fitting	10-SY3000
N3	ø5/32" One-touch fitting	10-SY5000
N7	ø1/4" One-touch fitting	10-SY5000
N9	ø5/16" One-touch fitting	10-SY5000
N9	ø5/16" One-touch fitting	10-SY7000
N11	ø3/8" One-touch fitting	10-SY7000

Manual override

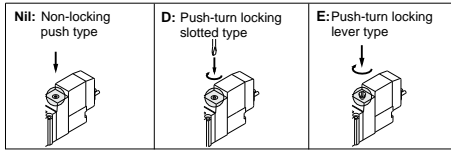

CE-compliant

Nil	—
Q	CE-compliant

Note) AC-type models that are CE-compliant have DIN terminals only.

Light/Surge voltage suppressor

Electrical entry for G, H, L, M, W

Nil	Without light/surge voltage suppressor
S	With light/surge voltage suppressor
Z	With light/surge voltage suppressor
R	With surge voltage suppressor (Non-polar type)
U	With light/surge voltage suppressor (Non-polar type)

* For AC voltage valves there is no "S" option. It is already built into the rectifier circuit.
* Power saving circuit is only available for the "Z" type.

Electrical entry for D, Y (10-SY500/7000 only)

Nil	Without light/surge voltage suppressor
S	With surge voltage suppressor (Non-polar type)
Z	With light/surge voltage suppressor (Non-polar type)

* DOZ and YOZ are not available.
* For AC voltage valves there is no "S" option. It is already built into the rectifier circuit.

Electrical entry

	24, 12, 6, 5, 3 VDC/100, 110, 200, 220 VAC				24, 12 VDC/100, 110, 200, 220 VAC	24, 12, 6, 5, 3 VDC
	Grommet	L plug connector	M plug connector		DIN terminal (10-SY5000/7000 only)	M8 connector
G: Lead wire length 300 mm		L: With lead wire (Length 300 mm)	M: With lead wire (Length 300 mm)	MN: Without lead wire	D, Y: With connector	WO: Without connector cable
H: Lead wire length 600 mm		LN: Without lead wire	LO: Without connector	MO: Without connector	DO, YO: Without connector	W□: With connector cable (Note 2)
Manifold mounting	●	●	●	●	— (Note 1)	●
CE-compliant	●	●	●	●	●	●

Note 1) The DIN terminal of the 10-SY3000 series cannot be mounted on a standard manifold. For details, refer to page 174.
Note 2) Enter the cable length symbols in □. Please be sure to fill in the blank referring to page 176.
Note 3) When ordering a single unit of the cassette type solenoid valve, the bushing assembly is included.
* LN, MN type: With 2 sockets.
* "Y" type is a DIN terminal conforming to EN-175301-803C (former DIN43650C). For details, refer to page 173.
* For connector cable of M8 connector, refer to page 176.
* M8 connector conforming to IEC60947-5-2 standard is also available. Refer to page 168 for details.
* Refer to page 173 for the lead wire length of L and M plug connectors.
* Refer to page 174 for the connector assembly with cover for L and M plug connectors.

Directional Control Valves

Air Cylinders

Rotary Actuators

Air Grippers

Air Preparation Equipment

Modular F. R.

Pressure Control Equipment

Fittings & Tubing

Flow Control Equipment

Pressure Switches/Pressure Sensors

Specifications

Series	10-SY3000	10-SY5000	10-SY7000	
Fluid	Air			
Internal pilot operating pressure range (MPa)	2 position single	0.15 to 0.7		
	2 position double	0.1 to 0.7		
	3 position	0.2 to 0.7		
Ambient and fluid temperature (°C)	Max. 50			
Max. operating frequency (Hz)	2 position double	10	5	5
	3 position	3	3	3
Manual override (Manual operation)	Non-locking push type, Push-turn locking slotted type, Push-turn locking lever type			
Pilot exhaust method	Main/Pilot valve common exhaust			
Lubrication	Not required			
Mounting position	Unrestricted			
Impact/Vibration resistance ^(Note)	150/30			
Enclosure	Dust proof (+ DIN terminal, M8 connector: IP65)			

Note) Impact resistance: No malfunction occurred when it was tested in the axial direction and at right angles to the main valve and armature in both energized and de-energized states once for each condition.

Vibration resistance: No malfunction occurred in a one-sweep test between 45 and 2000 Hz. Test was performed in both energized and de-energized states in the axial direction and at right angles to the main valve and armature. (Default settings)

* Based on IEC60529

Solenoid Specifications

Electrical entry		Grommet (G), (H) L plug connector (L) M plug connector (M) DIN terminal (D), (Y) M8 connector (W)	
		G, H, L, M, W	D, Y
Coil rated voltage (V)	DC	24, 12, 6, 5, 3	
	AC 50/60 Hz	100, 110, 200, 220	
Allowable voltage fluctuation		±10% of rated voltage *	
Power consumption (W)	DC	0.35 [With indicator light: 0.4 (DIN terminal with indicator light: 0.45)]	
	With power saving circuit	0.1 (With indicator light only) * [Starting 0.4, Holding 0.1]	
Apparent power (VA) *	AC	100 V	0.78 (With indicator light: 0.81) 0.78 (With indicator light: 0.87)
		110 V [115 V]	0.86 (With indicator light: 0.89) [0.94 (With indicator light: 0.97)] 0.86 (With indicator light: 0.97) [0.94 (With indicator light: 1.07)]
		200 V	1.18 (With indicator light: 1.22) 1.15 (With indicator light: 1.30)
		220 V [230 V]	1.30 (With indicator light: 1.34) [1.42 (With indicator light: 1.46)] 1.27 (With indicator light: 1.46) [1.39 (With indicator light: 1.60)]
Surge voltage suppressor		Diode (Varistor is for DIN terminal and non-polar)	
Indicator light		LED (AC of DIN connector is neon light.)	

* Common between 110 VAC and 115 VAC, and between 220 VAC and 230 VAC.

* For 115 VAC and 230 VAC, the allowable voltage is -15% to +5% of rated voltage.

* For details, refer to page 171.

Response Time

Note) Based on dynamic performance test, JIS B 8375-1981. (Coil temperature: 20°C, at rated voltage)

10-SY3000

Actuation type	Response time (ms) (at the pressure of 0.5 MPa)		
	Without surge voltage suppressor	With surge voltage suppressor	
		S, Z type	R, U type
2 position single	12 or less	15 or less	12 or less
2 position double	10 or less	13 or less	10 or less
3 position	15 or less	20 or less	16 or less

10-SY5000

Actuation type	Response time (ms) (at the pressure of 0.5 MPa)		
	Without surge voltage suppressor	With surge voltage suppressor	
		S, Z type	R, U type
2 position single	19 or less	26 or less	19 or less
2 position double	18 or less	22 or less	18 or less
3 position	32 or less	38 or less	32 or less

10-SY7000

Actuation type	Response time (ms) (at the pressure of 0.5 MPa)		
	Without light/surge voltage suppressor	With light/surge voltage suppressor	
		S, Z type	R, U type
2 position single	31 or less	38 or less	33 or less
2 position double	27 or less	30 or less	28 or less
3 position	50 or less	56 or less	50 or less

Weight

10-SY3000

Valve model	Actuation type		Port size	Weight (g)		
			A, B	Gro-mmet	L/M plug connector	M8 Connector
10-SY3□60-□-M5	2 position	Single	M5 x 0.8	49	51	55
		Double		70	73	81
	3 position	Closed center		73	76	84
		Exhaust center Pressure center				
10-SY3□60-□-C4	2 position	Single	C4 (ø4 One-touch fitting)	62	61	65
		Double		80	83	91
	3 position	Closed center		82	86	94
		Exhaust center Pressure center				
10-SY3□60-□-C6	2 position	Single	C6 (ø6 One-touch fitting)	55	57	61
		Double		76	79	87
	3 position	Closed center		78	82	90
		Exhaust center Pressure center				

10-SY7000

Valve model	Actuation type		Port size	Weight (g)			
			A, B	Gro-mmet	L/M plug connector	DIN terminal	M8 Connector
10-SY7□60-□-02	2 position	Single	1/4	103	105	126	109
		Double		125	128	170	136
	3 position	Closed center		133	136	178	144
		Exhaust center Pressure center					
10-SY7□60-□-C8	2 position	Single	C8 (ø8 One-touch fitting)	138	139	160	143
		Double		160	163	205	171
	3 position	Closed center		168	171	213	179
		Exhaust center Pressure center					
10-SY7□60-□-C10	2 position	Single	C10 (ø10 One-touch fitting)	123	125	146	129
		Double		145	149	191	157
	3 position	Closed center		153	157	199	165
		Exhaust center Pressure center					

10-SY5000

Valve model	Actuation type		Port size	Weight (g)			
			A, B	Gro-mmet	L/M plug connector	DIN terminal	M8 Connector
10-SY5□60-□-01	2 position	Single	1/8	67	69	90	71
		Double		91	94	136	102
	3 position	Closed center		97	100	142	108
		Exhaust center Pressure center					
10-SY5□60-□-C4	2 position	Single	C4 (ø4 One-touch fitting)	91	93	114	97
		Double		113	116	158	124
	3 position	Closed center		119	122	164	130
		Exhaust center Pressure center					
10-SY5□60-□-C6	2 position	Single	C6 (ø6 One-touch fitting)	86	88	109	92
		Double		108	111	153	119
	3 position	Closed center		114	117	159	125
		Exhaust center Pressure center					
10-SY5□60-□-C8	2 position	Single	C8 (ø8 One-touch fitting)	78	80	101	84
		Double		100	103	145	111
	3 position	Closed center		106	109	151	117
		Exhaust center Pressure center					

Directional Control Valves

Air Cylinders

Rotary Actuators

Air Grippers

Air Preparation Equipment

Modular F. R.

Pressure Control Equipment

Fittings & Tubing

Flow Control Equipment

Pressure Switches/ Pressure Sensors

Manifold Option

■ Individual SUP block assembly

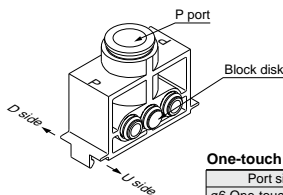

One-touch fitting (Metric size)

Port size	Assembly part no.	Applicable series
ø6 One-touch fitting	SY3000-54-2C(-Q)	10-SY3000
ø8 One-touch fitting	SY3000-54-1C(-Q)	10-SY3000
ø10 One-touch fitting	SY5000-54-1C(-Q)	10-SY5000
ø12 One-touch fitting	SY7000-54-1C(-Q)	10-SY7000

One-touch fitting (Inch size)

Port size	Assembly part no.	Applicable series
ø5/16" One-touch fitting	SY3000-54-3C(-Q)	10-SY3000
ø3/8" One-touch fitting	SY5000-54-2C(-Q)	10-SY5000
ø3/8" One-touch fitting	SY7000-54-3C(-Q)	10-SY7000

■ Individual EXH block assembly

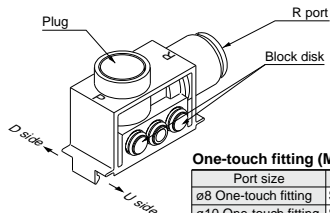

One-touch fitting (Metric size)

Port size	Assembly part no.	Applicable series
ø8 One-touch fitting	SY3000-55-1B(-Q)	10-SY3000
ø10 One-touch fitting	SY5000-55-1B(-Q)	10-SY5000
ø12 One-touch fitting	SY7000-55-1B(-Q)	10-SY7000

One-touch fitting (Inch size)

Port size	Assembly part no.	Applicable series
ø5/16" One-touch fitting	SY3000-55-2B(-Q)	10-SY3000
ø3/8" One-touch fitting	SY5000-55-2B(-Q)	10-SY5000
ø3/8" One-touch fitting	SY7000-55-3B(-Q)	10-SY7000

[When supplying the manifold with 2 different supply pressures.]

Specify arrangement of individual SUP block assembly on the manifold specification sheet. (When using 10-SS5Y□-60-□□D, block disk is assembled on D side.)

<Manifold model no.: 10-SS5Y $\frac{3}{8}$ -60-□□D>

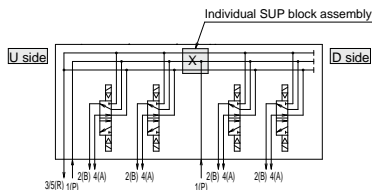

[When 2 different EXH passages are required.]

Specify arrangement of individual EXH block assembly on the manifold specification sheet. (When using 10-SS5Y□-60-□□D, block disk is assembled on D side.)

<Manifold model no.: 10-SS5Y $\frac{3}{8}$ -60-□□D>

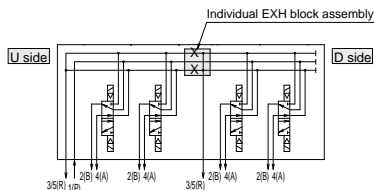

[When a different supply pressure is required for only a middle valve.]

Specify arrangement of individual SUP block assembly and SUP block disk on the manifold specification sheet.

(Applicable manifold model no.: 10-SS5Y□-60-□□B)

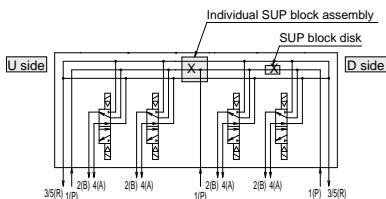

[When a separate exhaust passage is needed on only a middle valve.]

Specify arrangement of individual EXH block assembly and EXH block disk on the manifold specification sheet.

(Applicable manifold model no.: 10-SS5Y□-60-□□B)

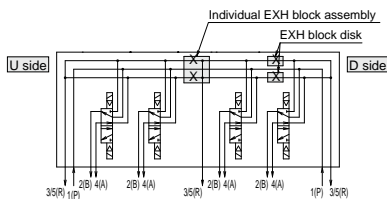

Manifold Option

■ SUP block disk

By installing a SUP block disk in the pressure supply passage of a manifold valve, it is possible to supply two or more different high and low pressures to one manifold. (This is the same block disk used with the individual SUP block assembly.)



Series	Part no.
10-SY3000	SY3000-52-6A
10-SY5000	SY5000-52-4A
10-SY7000	SY7000-70-2A

■ EXH block disk

By installing an EXH block disk in the exhaust passage of a manifold valve, it is possible to divide the valve's exhaust so that it does not affect another valve. (Two block disks are needed to separate both EXH passages. It is the same block disk that is used in the individual EXH block assembly.)



Series	Part no.
10-SY3000	SY3000-52-6A
10-SY5000	SY5000-52-4A
10-SY7000	SY7000-70-2A

■ Label for block disk

The labels shown below are used on manifold stations containing SUP/EXH block disk(s) to show their location. (3 pcs. each)

VZ3000-123-1A

Label for SUP block disk Label for EXH block disk Label for SUP/EXH block disk



* When a block disk is concurrently ordered by specifying it on the manifold specification sheet, etc., a label will be attached to the position where the block disk is mounted.

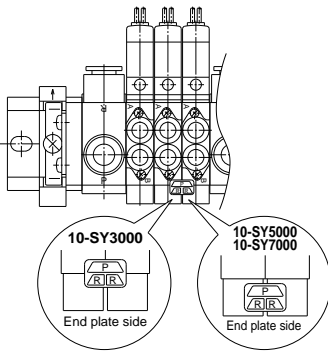

■ Plug (white)

These are inserted in unused cylinder ports and SUP, EXH ports. Purchase orders are available in units of 10 pieces.

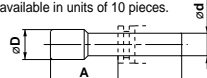

Dimensions

Applicable fittings size ød	Model	A	L	D
4	10-KQ2P-04	16	32	6
6	10-KQ2P-06	18	35	8
8	10-KQ2P-08	20.5	39	10
10	10-KQ2P-10	22	43	12
12	10-KQ2P-12	24	45.5	14
5/32"	10-KQ2P-03	16	32	6
1/4"	10-KQ2P-07	18	35	8.5
5/16"	10-KQ2P-09	20.5	39	10
3/8"	10-KQ2P-11	22	43	11.5

■ DIN Rail Dimensions/Weight for 10-SY3000/5000

VZ1000-11-1-□

Refer to the L dimension tables

* Enter a number from the DIN rail dimension table below.

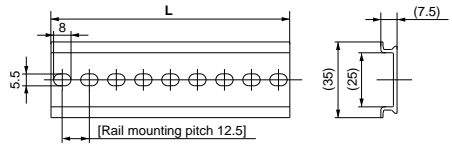

No.	0	1	2	3	4	5	6	7	8	9
L dimension	98	110.5	123	135.5	148	160.5	173	185.5	198	210.5
Weight (g)	17.6	19.9	22.1	24.4	26.6	28.9	31.1	33.4	35.6	37.9

No.	10	11	12	13	14	15	16	17	18	19
L dimension	223	235.5	248	260.5	273	285.5	298	310.5	323	335.5
Weight (g)	40.1	42.4	44.6	46.9	49.1	51.4	53.6	55.9	58.1	60.4

No.	20	21	22	23	24	25	26	27	28	29
L dimension	348	360.5	373	385.5	398	410.5	423	435.5	448	460.5
Weight (g)	62.6	64.9	67.1	69.4	71.6	73.9	76.1	78.4	80.6	82.9

■ DIN Rail Dimensions/Weight for 10-SY7000

VZ1000-11-4-□

Refer to the L dimension tables

* Enter a number from the DIN rail dimension table below.

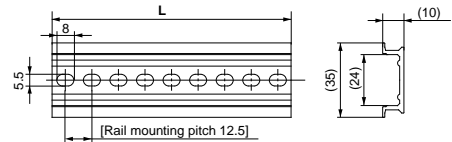

No.	0	1	2	3	4	5	6	7	8	9
L dimension	98	110.5	123	135.5	148	160.5	173	185.5	198	210.5
Weight (g)	24.8	28	31.1	34.3	37.4	40.6	43.8	46.9	50.1	53.3

No.	10	11	12	13	14	15	16	17	18	19
L dimension	223	235.5	248	260.5	273	285.5	298	310.5	323	335.5
Weight (g)	56.4	59.6	62.7	65.9	69.1	72.2	75.4	78.6	81.7	84.9

No.	20	21	22	23	24	25	26	27	28	29
L dimension	348	360.5	373	385.5	398	410.5	423	435.5	448	460.5
Weight (g)	88	91.2	94.4	97.5	100.7	103.9	107	110.2	113.3	116.5

(Note) For DIN rail mounting, refer to page 175.

Construction

Series 10-SY

Symbol

2 position single

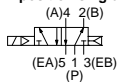

2 position single

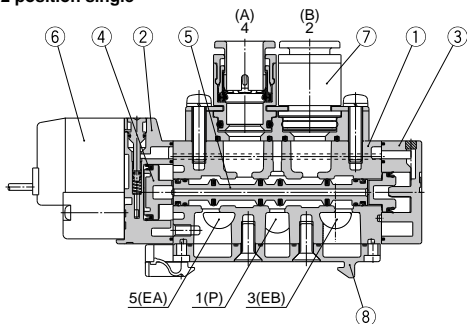

Symbol

2 position double

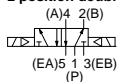

2 position double

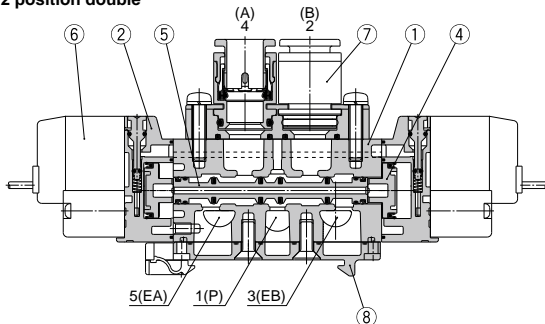

Symbol

3 position closed center

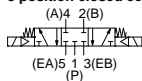

3 position closed center / exhaust center / pressure center

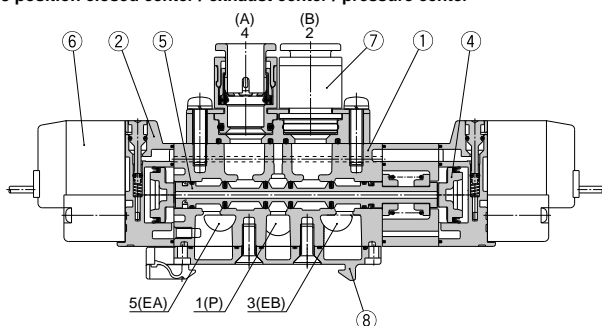

3 position exhaust center

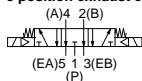

3 position pressure center

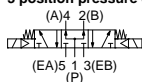

(This figure shows a closed center type.)

Component Parts

No.	Description	Material	Note
1	Body	Aluminum die-casted (10-SY3000: Zinc die-casted)	White
2	Adapter plate	Resin	White
3	End plate	Resin	White
4	Piston	Resin	—
5	Spool valve assembly	Aluminum/H-NBR	—

Replacement Parts

No.	Description	No.
6	Pilot valve assembly	Refer to "How to Order Pilot Valve Assembly" on the WEB catalog (SY series).
7	Port block assembly	Refer to "How to Order Port Block Assembly" on the WEB catalog (SY series).
8	Bottom cover assembly ^(Note)	SY3000-41-2A (with screw, gasket) SY5000-41-2A (with screw, gasket)

Note) There is no bottom cover assembly available for 10-SY7000.

Dimensions

[] : AC

10-SS5Y3-60- Stations U

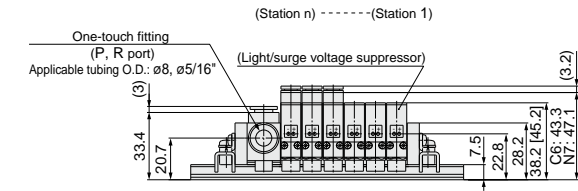
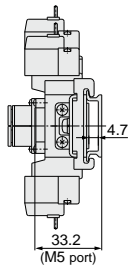
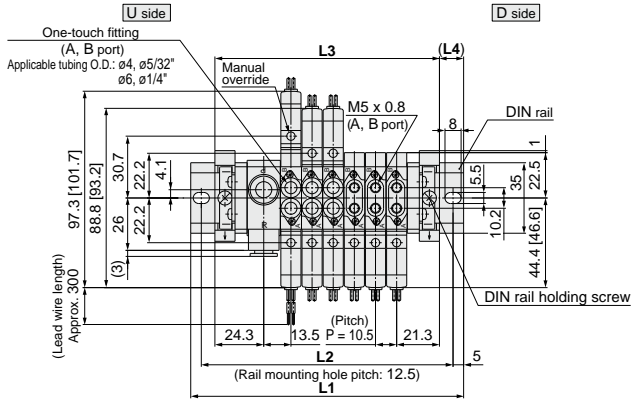

Stations	2 stations	3	4	5	6	7	8	9	10 stations
L1	98	110.5	123	135.5	135.5	148	160.5	173	185.5
L2	87.5	100	112.5	125	125	137.5	150	162.5	175
L3	69.5	80	90.5	101	111.5	122	132.5	143	153.5
L4	14	15	16	17	12	13	14	15	16

10-SS5Y3-60- Stations D

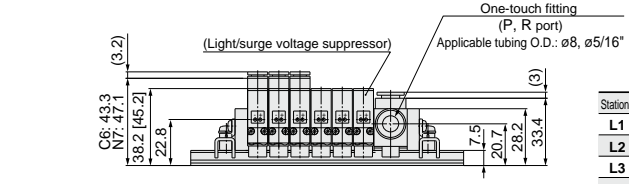
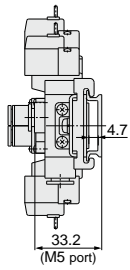
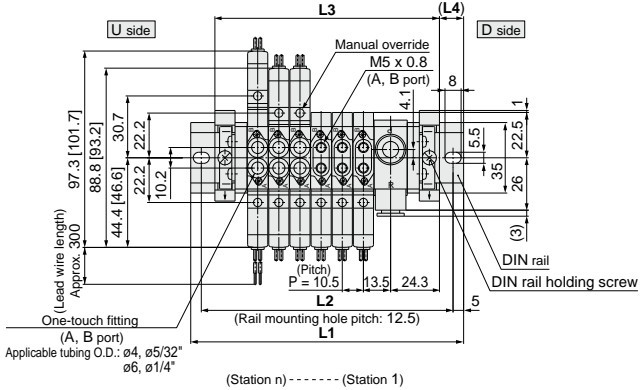

Stations	2 stations	3	4	5	6	7	8	9	10 stations
L1	98	110.5	123	135.5	135.5	148	160.5	173	185.5
L2	87.5	100	112.5	125	125	137.5	150	162.5	175
L3	69.5	80	90.5	101	111.5	122	132.5	143	153.5
L4	14	15	16	17	12	13	14	15	16

Directional Control Valves

Air Cylinders

Rotary Actuators

Air Grippers

Air Preparation Equipment

Modular F. R.

Pressure Control Equipment

Fittings & Tubing

Flow Control Equipment

Pressure Switches/ Pressure Sensors

Dimensions

10-SS5Y3-60- Stations B

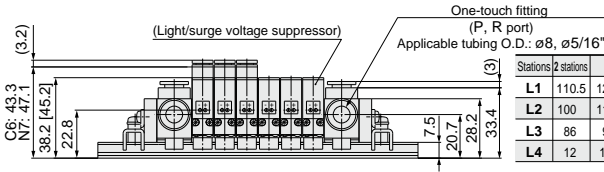
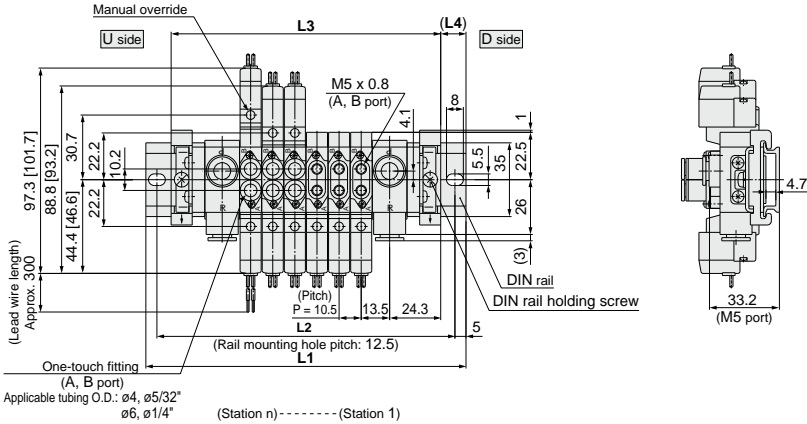

Stations	2 stations	3	4	5	6	7	8	9	10 stations
L1	110.5	123	135.5	148	160.5	173	173	185.5	198
L2	100	112.5	125	137.5	150	162.5	162.5	175	187.5
L3	86	96.5	107	117.5	128	138.5	149	159.5	170
L4	12	13	14	15	16	17	12	13	14

Stations	11 stations	12	13	14	15	16	17	18	19	20 stations
L1	210.5	223	235.5	235.5	248	260.5	273	285.5	298	310.5
L2	200	212.5	225	225	237.5	250	262.5	275	287.5	300
L3	180.5	191	201.5	212	222.5	233	243.5	254	264.5	275
L4	15	16	17	11.5	12.5	13.5	14.5	15.5	16.5	17.5

L plug connector (L)

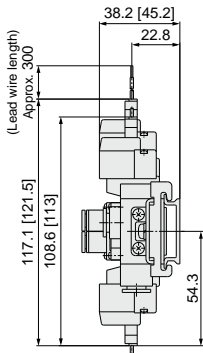

M plug connector (M)

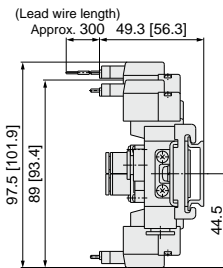

M8 connector (WO)

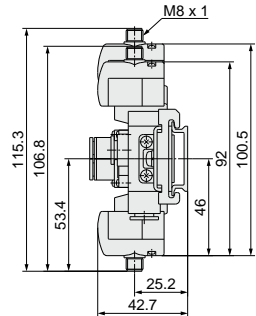

Note) Refer to page 176 for dimensions of connector types.

10-SS5Y5-60-Stations U

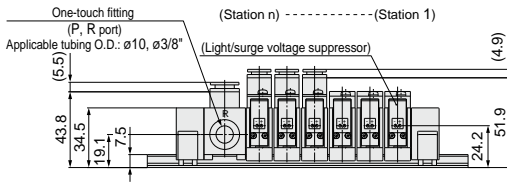
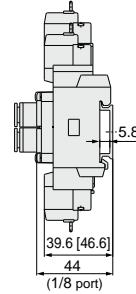
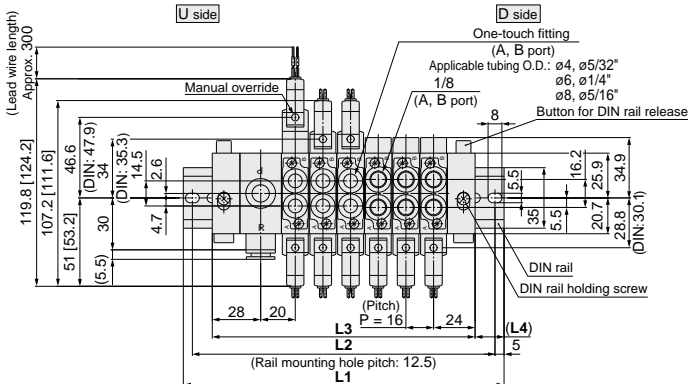

Stations	2 stations	3	4	5	6	7	8	9	10 stations
L1	123	135.5	148	160.5	185.5	198	210.5	235.5	248
L2	112.5	125	137.5	150	175	187.5	200	225	237.5
L3	88	104	120	136	152	168	184	200	216
L4	17.5	15.5	14	12	16.5	15	13	17.5	16

10-SS5Y5-60-Stations D

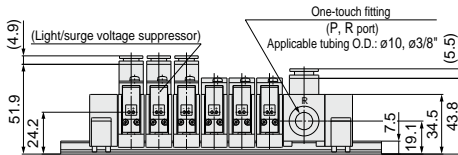
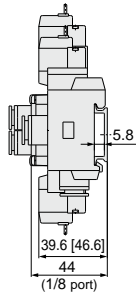
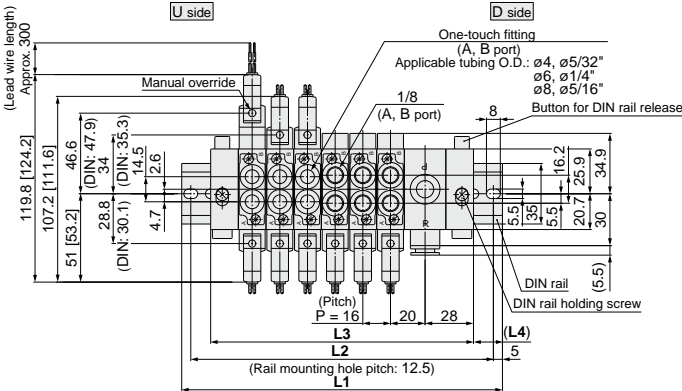

Stations	2 stations	3	4	5	6	7	8	9	10 stations
L1	123	135.5	148	160.5	185.5	198	210.5	235.5	248
L2	112.5	125	137.5	150	175	187.5	200	225	237.5
L3	88	104	120	136	152	168	184	200	216
L4	17.5	15.5	14	12	16.5	15	13	17.5	16

Directional Control Valves

Air Cylinders

Rotary Actuators

Air Grippers

Air Preparation Equipment

Modular F. R.

Pressure Control Equipment

Fittings & Tubing

Flow Control Equipment

Pressure Switches/Pressure Sensors

Dimensions

[] : AC

10-SS5Y5-60- Stations B

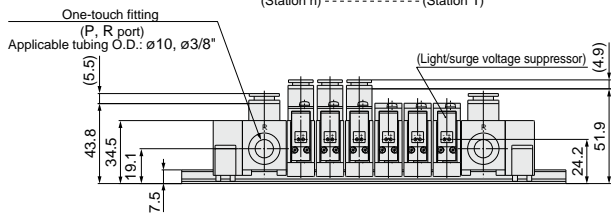
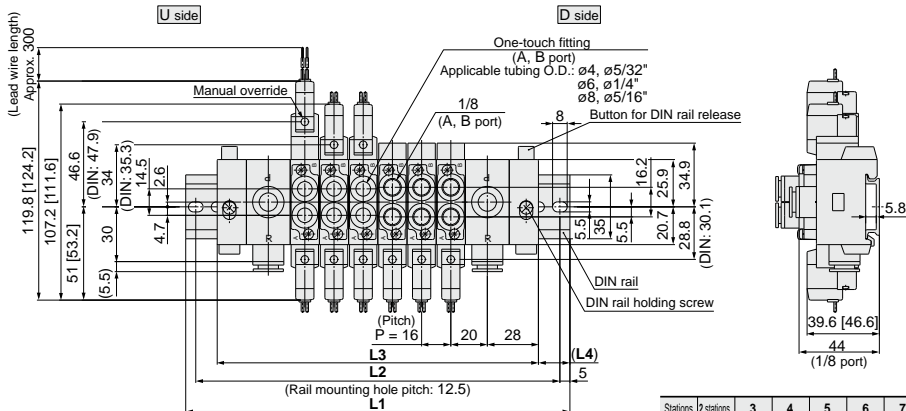

Stations	2 stations	3	4	5	6	7	8 stations
L1	135.5	160.5	173	185.5	210.5	223	235.5
L2	125	150	162.5	175	200	212.5	225
L3	112	128	144	160	176	192	208
L4	11.5	16	14.5	12.5	17.5	15.5	13.5

Stations	9 stations	10	11	12	13	14	15 stations
L1	248	273	285.5	298	323	335.5	348
L2	237.5	262.5	275	287.5	312.5	325	337.5
L3	224	240	256	272	288	304	320
L4	12	16.5	14.5	13	17.5	15.5	14

Stations	16 stations	17	18	19	20 stations
L1	360.5	385.5	398	410.5	435.5
L2	350	375	387.5	400	425
L3	336	352	368	384	400
L4	12	16.5	15	13	17.5

L plug connector (L)

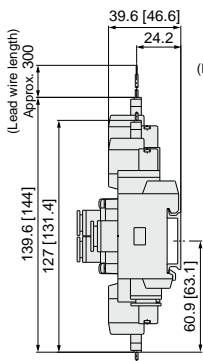

M plug connector (M)

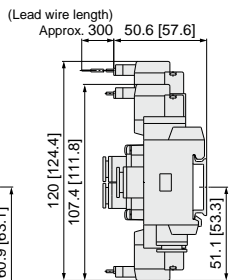

DIN terminal (D, Y)

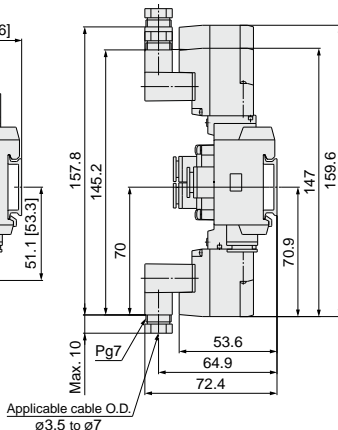

M8 connector (WO)

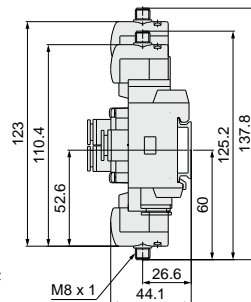

Note) Refer to page 176 for dimensions of connector types.

10-SS5Y7-60- Stations U

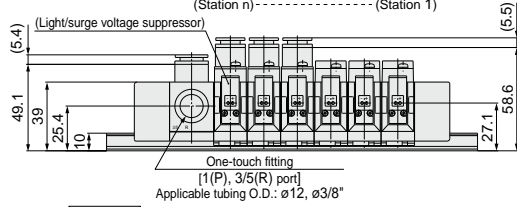
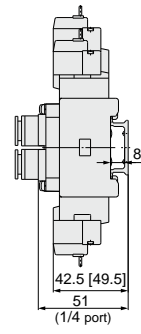
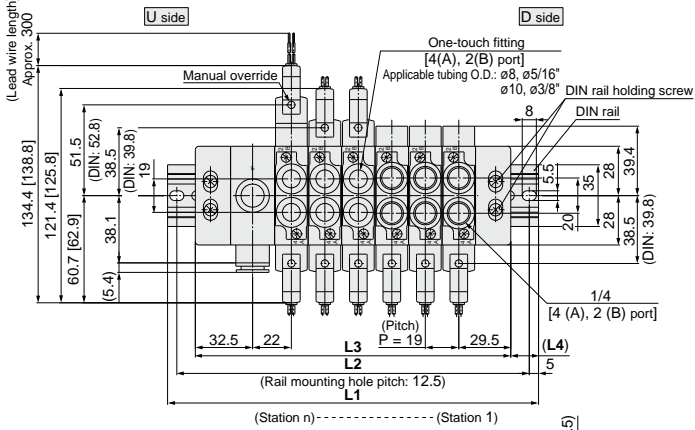

Stations	2 stations	3	4	5	6	7	8	9	10 stations
L1	135.5	148	173	185.5	210.5	223	248	260.5	285.5
L2	125	137.5	162.5	175	200	212.5	237.5	250	275
L3	103	122	141	160	179	198	217	236	255
L4	16	13	16	12.5	15.5	12.5	15.5	12	15

10-SS5Y7-60- Stations D

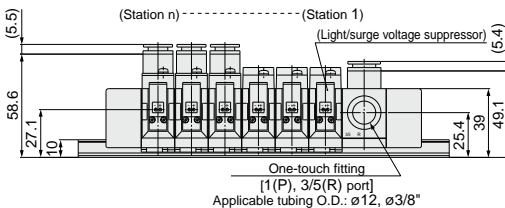
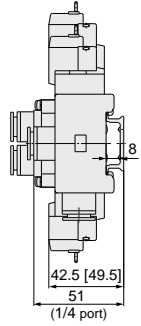
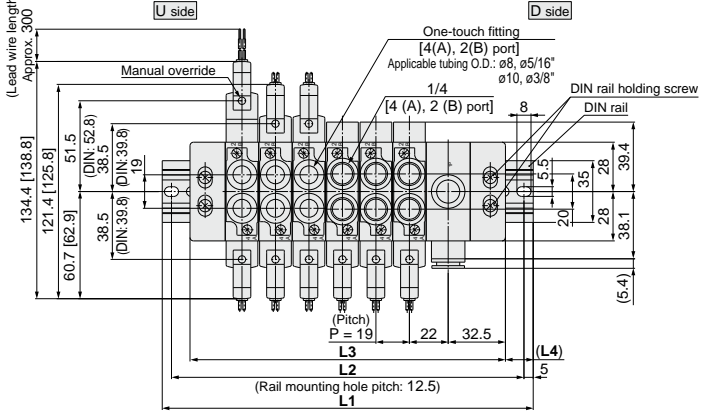

Stations	2 stations	3	4	5	6	7	8	9	10 stations
L1	135.5	148	173	185.5	210.5	223	248	260.5	285.5
L2	125	137.5	162.5	175	200	212.5	237.5	250	275
L3	103	122	141	160	179	198	217	236	255
L4	16	13	16	12.5	15.5	12.5	15.5	12	15

- Directional Control Valves
- Air Cylinders
- Rotary Actuators
- Air Grippers
- Air Preparation Equipment
- Modular F. R.
- Pressure Control Equipment
- Fittings & Tubing
- Flow Control Equipment
- Pressure Switches/ Pressure Sensors

Dimensions

[]: AC

10-SS5Y7-60- Stations B

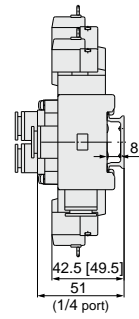
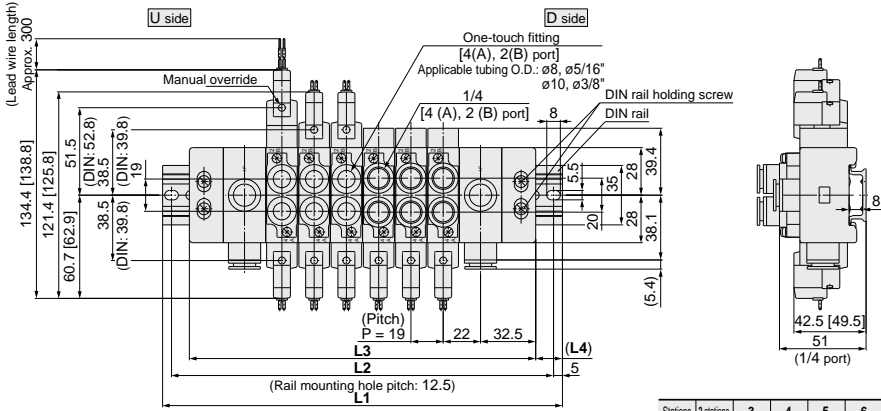

(Station n) ----- (Station 1)

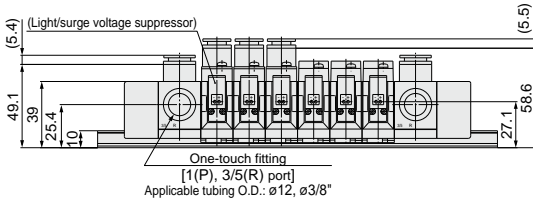

Stations	2 stations	3	4	5	6	7	8 stations
L1	160.5	173	198	210.5	235.5	248	273
L2	150	162.5	187.5	200	225	237.5	262.5
L3	128	147	166	185	204	223	242
L4	16	13	16	12.5	15.5	12.5	15.5

Stations	9 stations	10	11	12	13	14	15 stations
L1	285.5	310.5	323	348	360.5	385.5	410.5
L2	275	300	312.5	337.5	350	375	400
L3	261	280	299	318	337	356	375
L4	12	15	12	15	11.5	14.5	17.5

Stations	16 stations	17	18	19	20 stations
L1	423	448	460.5	485.5	498
L2	412.5	437.5	450	475	487.5
L3	394	413	432	451	470
L4	14.5	17.5	14	17	14

L plug connector (L)

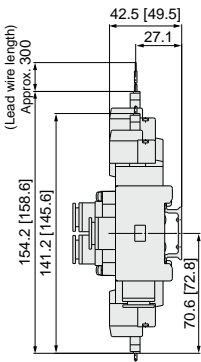

M plug connector (M)

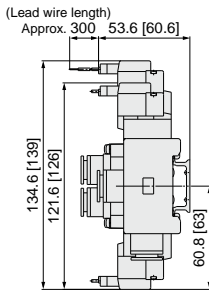

DIN terminal (D, Y)

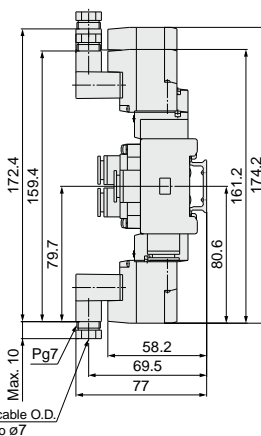

M8 connector (WO)

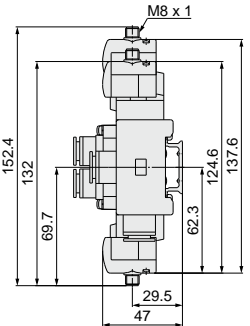

Note) Refer to page 176 for dimensions of connector types.

Type 41
Type 42

Series 10-SY3000/5000/7000

5 Port Solenoid Valve
Base Mounted Manifold
Bar Stock Type/Individual Wiring

Note) AC-type models that are CE-compliant have DIN terminals only.



How to Order Manifold

Type 41/Compact type

10-SS5Y 5-41-05-C8

• Clean series

Manifold series	Stations
3 10-SY3000	02 2 stations
5 10-SY5000	20 20 stations

* Includes the number of blanking plate assemblies.

Thread type	Symbol
Rc	Nil
G	F
NPT	N
NPTF	T

* Except for M5

CE-compliant	Symbol
—	Nil
CE-compliant	Q

Note) AC-type models that are CE-compliant have DIN terminals only.

• A, B port size
Thread piping

Symbol	Port size	Applicable series
M5	M5 x 0.8	10-SY3000
01	1/8	10-SY5000

One-touch fitting (Metric size)	Symbol	Port size	Applicable series
C4	ø4 One-touch fitting	10-SY3000	
C6	ø6 One-touch fitting	10-SY3000	
C6	ø6 One-touch fitting	10-SY5000	
C8	ø8 One-touch fitting	10-SY5000	

One-touch fitting (Inch size)	Symbol	Port size	Applicable series
N3	ø5/32" One-touch fitting	10-SY3000	
N7	ø1/4" One-touch fitting	10-SY3000	
N7	ø1/4" One-touch fitting	10-SY5000	
N9	ø5/16" One-touch fitting	10-SY5000	

Type 42/Common external pilot

10-SS5Y 5-42-05-C8

• Clean series

Manifold series	Stations
3 10-SY3000	02 2 stations
5 10-SY5000	20 20 stations
7 10-SY7000	20 20 stations

* Includes the number of blanking plate assemblies.

Thread type	Symbol
Rc	Nil
G	F
NPT	N
NPTF	T

* Except for M5

CE-compliant	Symbol
—	Nil
CE-compliant	Q

Note) AC-type models that are CE-compliant have DIN terminals only.

• A, B port size
Thread piping

Symbol	Port size	Applicable series
01	1/8	10-SY3000
02	1/4	10-SY5000
02	1/4	10-SY7000

One-touch fitting (Metric size)	Symbol	Port size	Applicable series
C4	ø4 One-touch fitting	10-SY3000	
C6	ø6 One-touch fitting	10-SY3000	
C6	ø6 One-touch fitting	10-SY5000	
C8	ø8 One-touch fitting	10-SY5000	
C10	ø10 One-touch fitting	10-SY7000	

One-touch fitting (Inch size)	Symbol	Port size	Applicable series
N3	ø5/32" One-touch fitting	10-SY3000	
N7	ø1/4" One-touch fitting	10-SY3000	
N7	ø1/4" One-touch fitting	10-SY5000	
N9	ø5/16" One-touch fitting	10-SY5000	
N11	ø3/8" One-touch fitting	10-SY7000	

How to Order Manifold Assembly (Example)

Example

Single solenoid (24 VDC)
10-SY3140-5G (2 sets)

Double solenoid (24 VDC)
10-SY3240-5G (2 sets)

Blanking plate assembly
SY3000-26-9A (1 set)

Manifold base (5 stations)
10-SSY3-41-05-C6

Cylinder port size
C6: With ø6 One-touch fitting

10-SSY3-41-05-C6... 1 set (Type 41, 5-station manifold base part no.)
 * 10-SY3240-5G 2 sets (Double solenoid part no.)
 * 10-SY3140-5G 2 sets (Single solenoid part no.)
 * SY3000-26-9A 1 set (Blanking plate assembly part no.)

The asterisk denotes the symbol for assembly.
Prefix it to the part no. of the solenoid valve, etc.

Add the valve and option part number under the manifold base part number.
For complex arrangements, specify them on the manifold specification sheet.

Directional Control Valves

Air Cylinders

Rotary Actuators

Air Grippers

Air Preparation Equipment

Modular F. R.

Pressure Control Equipment

Fittings & Tubing

Flow Control Equipment

Pressure Switches/ Pressure Sensors



How to Order Valve

Note) AC-type models that are CE-compliant have DIN terminals only.

10-SY **5** **2** **40** - **5** **L** - -

• Clean series

Series •

3	10-SY3000
5	10-SY5000
7	10-SY7000

Actuation type •

1	2 position single
2	2 position double
3	3 position closed center
4	3 position exhaust center
5	3 position pressure center

Pilot type •

Nil	Internal pilot
R	External pilot

Coil type •

Nil	Standard
T	With power saving circuit (24 VDC, 12 VDC only)

* Power saving circuit is not available for D, Y, DO, YO or W□ types.

Rated voltage •

For DC

5	24 VDC
6	12 VDC
V	6 VDC
S	5 VDC
R	3 VDC

For AC (50/60 Hz)

1	100 VAC
2	200 VAC
3	110 VAC [115 VAC]
4	220 VAC [230 VAC]

* DC specifications of Type D, Y, DO and YO are only available with 12 and 24 VDC.
* For type W□, only DC voltage is available.
Note) AC-type models that are CE-compliant have DIN terminals only.

• CE-compliant

Nil	—
Q	CE-compliant

Note) AC-type models that are CE-compliant have DIN terminals only.

• Made to Order

Nil	—
X90	Main valve fluororubber (Refer to page 169.)

• Manual override

Nil	Non-locking push type
D	Push-turn locking slotted type
E	Push-turn locking lever type

• Light/Surge voltage suppressor

Electrical entry for G, H, L, M, W

Nil	Without light/surge voltage suppressor
S	With surge voltage suppressor
Z	With light/surge voltage suppressor
R	With surge voltage suppressor (Non-polar type)
U	With light/surge voltage suppressor (Non-polar type)

* For AC voltage valves there is no "S" option. It is already built into the rectifier circuit.
* For "R" and "U", only DC voltage is available.
* Power saving circuit is only available for the "Z" type.

Electrical entry for D, Y

Nil	Without light/surge voltage suppressor
S	With surge voltage suppressor (Non-polar type)
Z	With light/surge voltage suppressor (Non-polar type)

* DOZ and YOZ are not available.
* For AC voltage valves there is no "S" option. It is already built into the rectifier circuit.

Note) When ordering a single unit of the base mounted type solenoid valve, the mounting screws and gasket for the manifold are included.

• Electrical entry

		24, 12, 6, 5, 3 VDC/100, 110, 200, 220 VAC			24, 12 VDC/ 100, 110, 200, 220 VAC	24, 12, 6, 5, 3 VDC
		Grommet	L plug connector	M plug connector	DIN terminal	M8 connector
		G: Lead wire length 300 mm lead	L: With lead wire (Length 300 mm)	M: With lead wire (Length 300 mm)	(10-SY5000/7000 only) D: With connector DO: Without connector Y: With connector YO: Without connector	WO: Without connector cable W□: With connector cable ^{Note 2)}
		H: Lead wire length 600 mm	LN: Without lead wire LO: Without connector	MN: Without lead wire MO: Without connector	— ^{Note 1)}	
Manifold mounting	10-SY3000	●	●	●	●	●
	10-SY5000	●	●	●	●	●
	10-SY7000	●	●	●	●	●
CE-compliant	DC	●	●	●	●	●
	AC	—	—	—	●	—

Note 1) The DIN terminal of the 10-SY3000 series cannot be mounted on a standard manifold. For details, refer to page 174.

Note 2) Enter the cable length symbols in □. Please be sure to fill in the blank referring to page 176.

* LN, MN type: With 2 sockets.

* "Y" type is a DIN terminal conforming to EN-175301-803C (former DIN43650C). For details, refer to page 173.

* For connector cable of M8 connector, refer to page 176.

* M8 connector conforming to IEC60947-5-2 standard is also available. Refer to page 168 for details.

* Refer to page 173 for the lead wire length of L and M plug connectors.

* Refer to page 174 for the connector assembly with cover for L and M plug connectors.

Manifold Specifications



Model	10-SS5Y3-41(-Q)	10-SS5Y3-42(-Q)	10-SS5Y5-41(-Q)	10-SS5Y5-42(-Q)	10-SS5Y7-42(-Q)
Applicable valve	10-SY3□40		10-SY5□40		
Manifold type	Single base/B mount				
P (SUP)/R (EXH)	Common SUP, Common EXH				
Valve stations	2 to 20 stations ^{Note 1)}				
A, B port	Base				
Porting specifications	Side				
Port size	P, EA, EB port	1/8		1/4	
	A, B port	M5 x 0.8, C4 (ø4 One-touch fitting) C6 (ø6 One-touch fitting)	1/8 C4 (ø4 One-touch fitting) C6 (ø6 One-touch fitting)	1/8 C6 (ø6 One-touch fitting) C8 (ø8 One-touch fitting)	1/4 C6 (ø6 One-touch fitting) C8 (ø8 One-touch fitting)
Manifold base weight W (g) n: Stations	W = 30n + 50	W = 37n + 63	W = 61n + 101	W = 79n + 127	W = 100n + 151

Note 1) For more than 10 stations (more than 5 stations in case of 10-SS5Y7), supply pressure to P port on both sides and exhaust from EA/EB port on both sides.

Note 2) Refer to "Manifold Option" on page 148.

Flow Rate Characteristics

Model	Port size		Flow rate characteristics					
	1, 5, 3 (P, EA, EB)	4, 2 (A, B)	1 → 4/2 (P → A/B)			4/2 → 5/3 (A/B → EA/EB)		
			C (dm ³ /(sbar))	b	Cv	C (dm ³ /(sbar))	b	Cv
10-SS5Y3-41(-Q)	1/8	C6	0.75	0.19	0.18	0.81	0.23	0.20
10-SS5Y3-42(-Q)	1/8	C6	0.75	0.20	0.18	0.82	0.20	0.20
10-SS5Y5-41(-Q)	1/4	C8	1.8	0.23	0.44	1.9	0.16	0.45
10-SS5Y5-42(-Q)	1/4	C8	1.9	0.20	0.46	1.9	0.12	0.43
10-SS5Y7-42(-Q)	1/4	C10	3.0	0.25	0.75	3.0	0.12	0.66

Note) The values are for individually operated 2 position type manifold bases with 5 stations.

Directional Control Valves

Air Cylinders

Rotary Actuators

Air Grippers

Air Preparation Equipment

Modular F. R.

Pressure Control Equipment

Fittings & Tubing

Flow Control Equipment

Pressure Switches/ Pressure Sensors

10-SY3000: 10-SS5Y3-41-Stations-M5, C4, N3
C6, N7

[]: AC

Grommet (G)

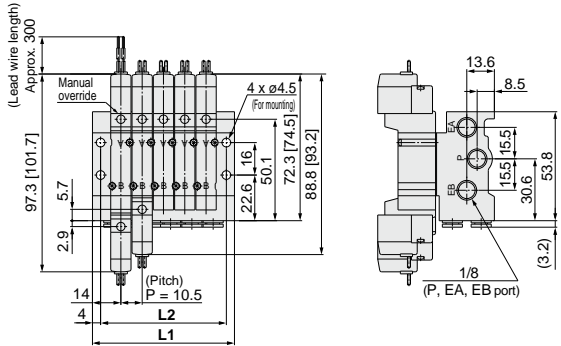

(Station 1) ----- (Station n)

For M5

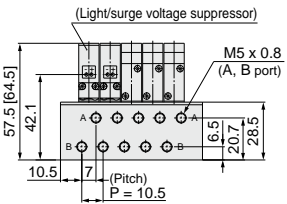
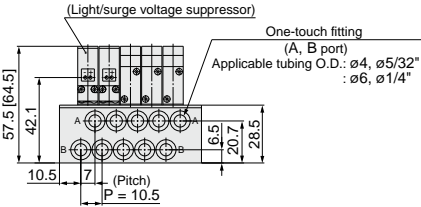

L plug connector (L)

M plug connector (M)

M8 connector (W0)

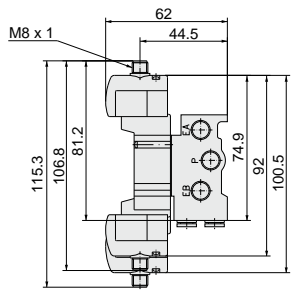
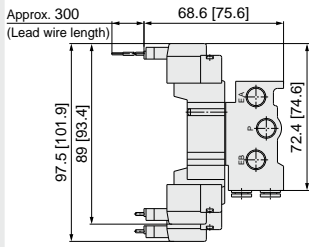
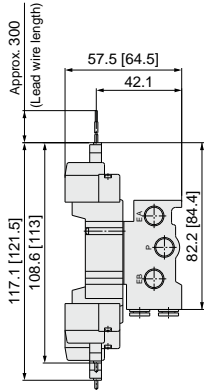

Note) Refer to page 176 for dimensions of connector types.

Stations	2 stations	3	4	5	6	7	8	9	10	11	12	13	14	15	16	17	18	19	20 stations
L1	38.5	49	59.5	70	80.5	91	101.5	112	122.5	133	143.5	154	164.5	175	185.5	196	206.5	217	227.5
L2	30.5	41	51.5	62	72.5	83	93.5	104	114.5	125	135.5	146	156.5	167	177.5	188	198.5	209	219.5

10-SY5000: 10-SS5Y5-41- Stations-01, C6, N7, C8, N9

[] : AC

Grommet (G)

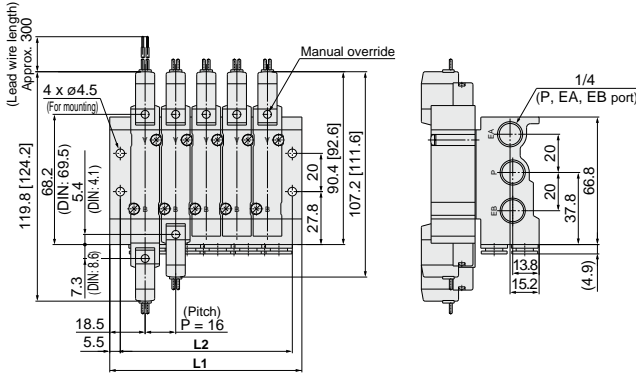

(Station 1) ----- (Station n)

For 1/8

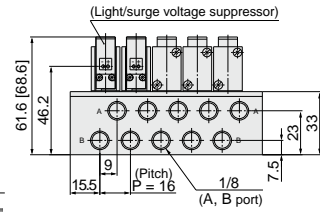
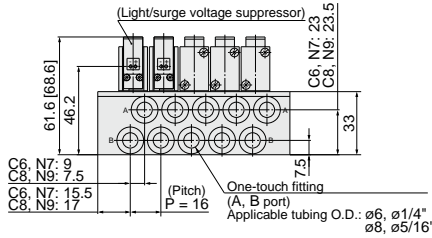

L plug connector (L)

M plug connector (M)

DIN terminal (D, Y)

M8 connector (WO)

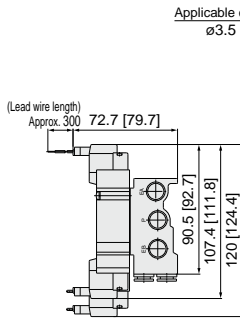
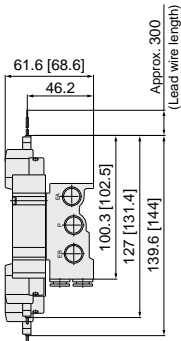

Applicable cable O.D.
ø3.5 to ø7

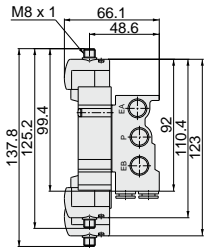
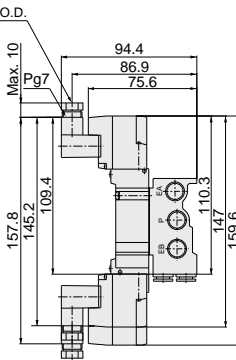

Note) Refer to page 176 for dimensions of connector types.

Stations	2 stations	3	4	5	6	7	8	9	10	11	12	13	14	15	16	17	18	19	20 stations
L1	52.5	68.5	84.5	100.5	116.5	132.5	148.5	164.5	180.5	196.5	212.5	228.5	244.5	260.5	276.5	292.5	308.5	324.5	340.5
L2	42	58	74	90	106	122	138	154	170	186	202	218	234	250	266	282	298	314	330

Directional Control Valves

Air Cylinders

Rotary Actuators

Air Grippers

Air Preparation Equipment

Modular F. R.

Pressure Control Equipment

Fittings & Tubing

Flow Control Equipment

Pressure Switches/ Pressure Sensors

10-SY3000: 10-SS5Y3-42- Stations - C4, N3
C6, N7

[]: AC

Grommet (G)

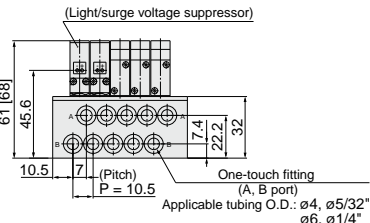
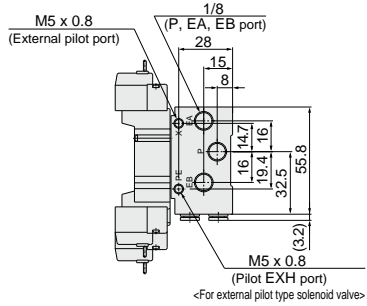
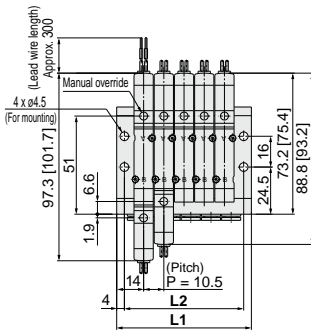

L plug connector (L)

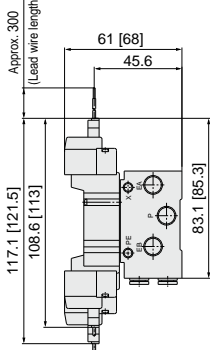

M plug connector (M)

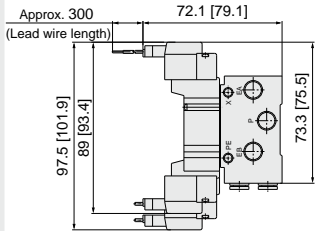

M8 connector (WO)

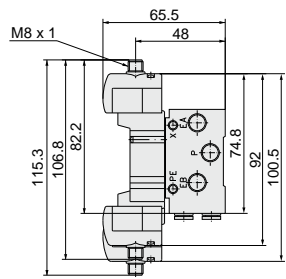

Note) Refer to page 176 for dimensions of connector types.

Stations	2 stations	3	4	5	6	7	8	9	10	11	12	13	14	15	16	17	18	19	20 stations
L1	38.5	49	59.5	70	80.5	91	101.5	112	122.5	133	143.5	154	164.5	175	185.5	196	206.5	217	227.5
L2	30.5	41	51.5	62	72.5	83	93.5	104	114.5	125	135.5	146	156.5	167	177.5	188	198.5	209	219.5

10-SY3000: 10-SS5Y3-42-Stations-01

[] : AC

Grommet (G)

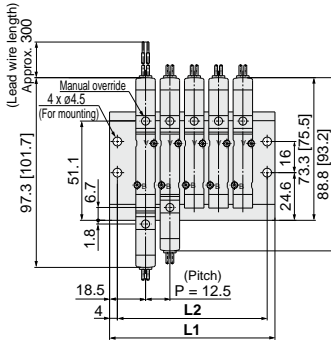

(Station 1) ----- (Station n)

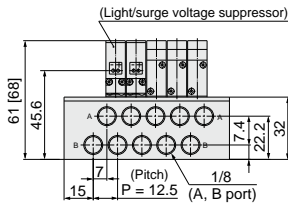
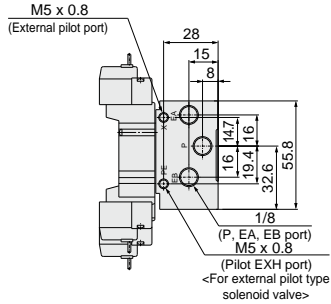

L plug connector (L)

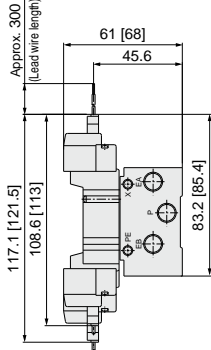

M plug connector (M)

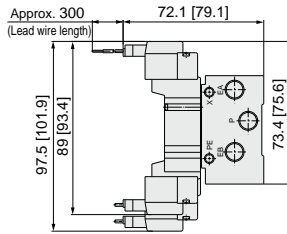

M8 connector (WO)

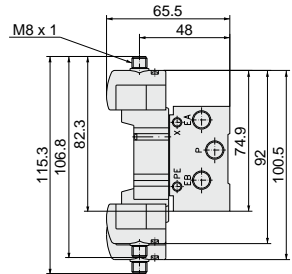

Note) Refer to page 176 for dimensions of connector types.

Stations	2 stations	3	4	5	6	7	8	9	10	11	12	13	14	15	16	17	18	19	20 stations
L1	47.5	60	72.5	85	97.5	110	122.5	135	147.5	160	172.5	185	197.5	210	222.5	235	247.5	260	272.5
L2	39.5	52	64.5	77	89.5	102	114.5	127	139.5	152	164.5	177	189.5	202	214.5	227	239.5	252	264.5

Directional Control Valves
Air Cylinders
Rotary Actuators
Air Grippers
Air Preparation Equipment
Modular F. R.
Pressure Control Equipment
Fittings & Tubing
Flow Control Equipment
Pressure Switches/
Pressure Sensors

10-SY5000: 10-SS5Y5-42- Stations - C6, N7
C8, N9

[] : AC

Grommet (G)

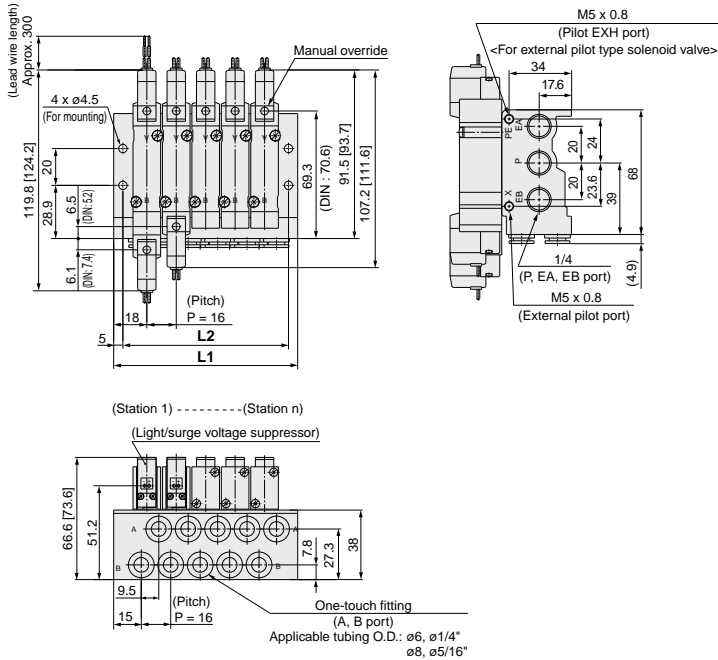

L plug connector (L)

M plug connector (M)

DIN terminal (D, Y)

M8 connector (WO)

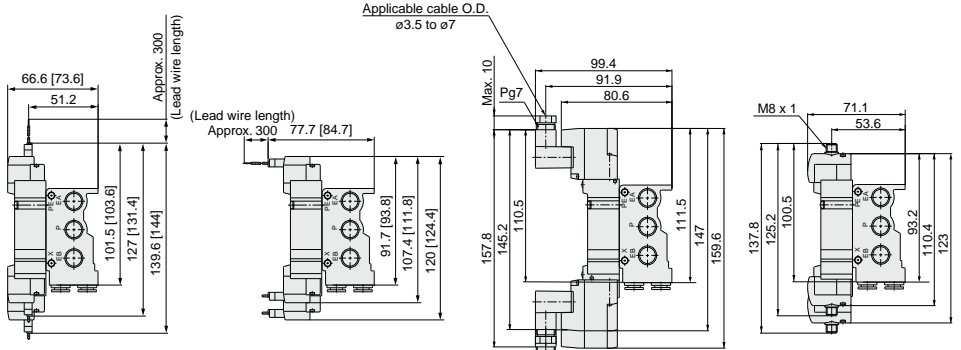

Note) Refer to page 176 for dimensions of connector types.

Stations	2 stations	3	4	5	6	7	8	9	10	11	12	13	14	15	16	17	18	19	20 stations
L1	52	68	84	100	116	132	148	164	180	196	212	228	244	260	276	292	308	324	340
L2	42	58	74	90	106	122	138	154	170	186	202	218	234	250	266	282	298	314	330

10-SY5000: 10-SS5Y5-42- Stations -02

[] : AC

Grommet (G)

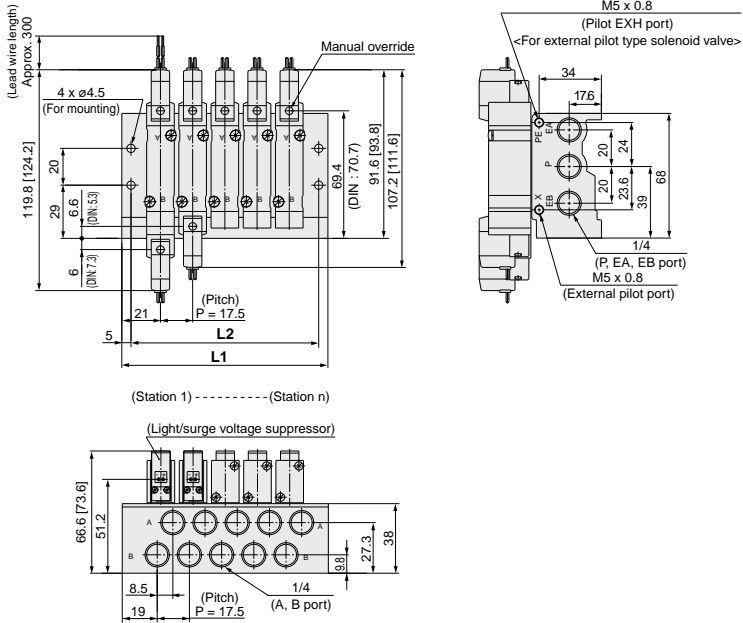

(Station 1) ----- (Station n)

L plug connector (L)

M plug connector (M)

DIN terminal (D, Y)

M8 connector (WO)

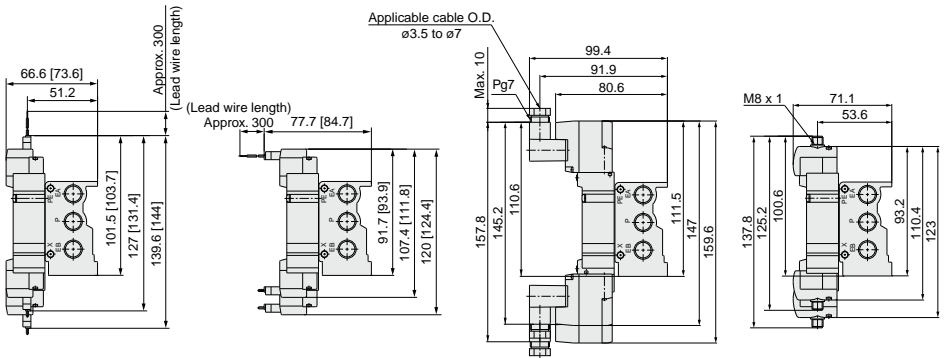

Note) Refer to page 176 for dimensions of connector types.

Stations	2 stations	3	4	5	6	7	8	9	10	11	12	13	14	15	16	17	18	19	20 stations
L1	59.5	77	94.5	112	129.5	147	164.5	182	199.5	217	234.5	252	269.5	287	304.5	322	339.5	357	374.5
L2	49.5	67	84.5	102	119.5	137	154.5	172	189.5	207	224.5	242	259.5	277	294.5	312	329.5	347	364.5

Directional Control Valves
 Air Cylinders
 Rotary Actuators
 Air Grippers
 Air Preparation Equipment
 Modular F. R.
 Pressure Control Equipment
 Fittings & Tubing
 Flow Control Equipment
 Pressure Switches/ Pressure Sensors

10-SY7000: 10-SS5Y7-42- Stations -02, C10, N11

[] : AC

Grommet (G)

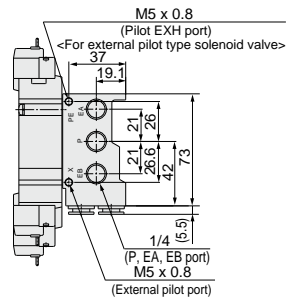
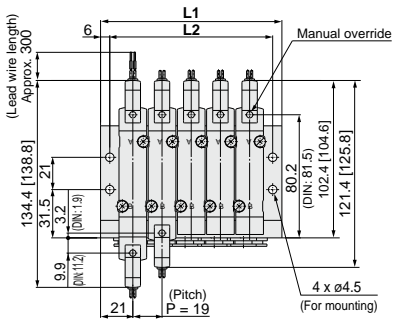

(Station 1) ----- (Station n)

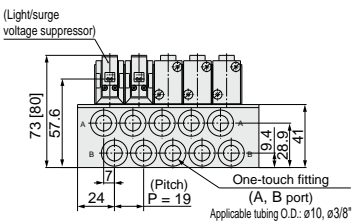

For 1/4

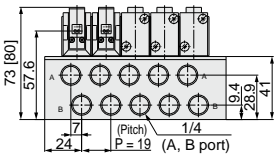

L plug connector (L)

M plug connector (M)

DIN terminal (D, Y)

M8 connector (WO)

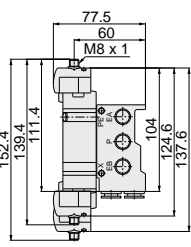
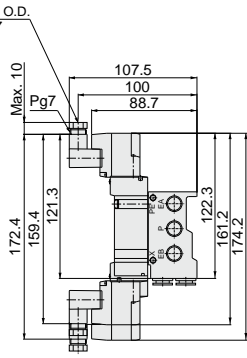
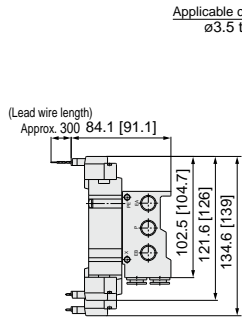
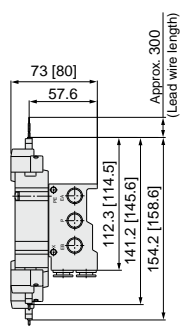

Note) Refer to page 176 for dimensions of connector types.

Stations	2 stations	3	4	5	6	7	8	9	10	11	12	13	14	15	16	17	18	19	20 stations
L1	61	80	99	118	137	156	175	194	213	232	251	270	289	308	327	346	365	384	403
L2	49	68	87	106	125	144	163	182	201	220	239	258	277	296	315	334	353	372	391

Type 43 Series 10-SY9000

5 Port Solenoid Valve Base Mounted Manifold Stacking Type/Individual Wiring

Note) AC-type models that are CE-compliant have DIN terminals only. **[Option]**



Directional Control Valves

How to Order Manifold



Clean series

Manifold series
9 10-SY9000

Valve stations

Symbol	Stations
02	2 stations
:	:
20	20 stations

* Includes the number of blanking plate assemblies.

P, R port outlets

Symbol	Port outlet	Applicable stations
U	U side	2 to 10 stations
D	D side	
B	Both sides	2 to 20 stations

SUP/EXH block assembly

Symbol	Specifications
Nil	Standard/Internal pilot
R	External pilot

Thread type

	Rc
Nil	
F	G
N	NPT
T	NPTF

* When One-touch fittings are selected for "A, B port size", the symbol is nil.

Option

Symbol	Mounting
Nil	Direct mounting
D	DIN rail mounting (with DIN rail)
DO	DIN rail mounting (without DIN rail)
D*	When a longer DIN rail is desired than the specified stations, specify the station number to be required in place of the * mark.

A, B port size

Thread piping

Symbol	Port size
02	1/4
03	3/8

One-touch fitting (Metric size)

Symbol	Port size
C8	ø8 One-touch fitting
C10	ø10 One-touch fitting
C12	ø12 One-touch fitting
M	Mixed

One-touch fitting (Inch size)

Symbol	Port size
N9	ø5/16" One-touch fitting
N11	ø3/8" One-touch fitting
M	Mixed

* For mixed specifications (M), indicate separately on the manifold specification sheet.

CE-compliant

Nil	—
Q	CE-compliant

Note) AC-type models that are CE-compliant have DIN terminals only.

How to Order Manifold Assembly (Example)

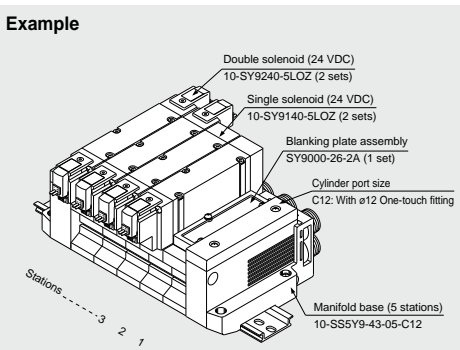

10-SS5Y9-43-05B-C12 ... 1 set (Type 43, 5-station manifold base part no.)
 * **SY9000-26-2A** 1 set (Blanking plate assembly part no.)
 * **10-SY9140-5LOZ** 2 sets (Single solenoid part no.)
 * **10-SY9240-5LOZ** 2 sets (Double solenoid part no.)

The asterisk denotes the symbol for assembly. Prefix it to the part no. of the solenoid valve, etc.

Add the valve and option part number under the manifold base part number. For complex arrangements, specify them on the manifold specification sheet.

Air Cylinders

Rotary Actuators

Air Grippers

Air Preparation Equipment

Modular F. R.

Pressure Control Equipment

Fittings & Tubing

Flow Control Equipment

Pressure Switches/Pressure Sensors

How to Order Valve

Note) AC-type models that are CE-compliant have DIN terminals only.

10-SY9 **2** **40** **5** **L**

• Clean series

• Series

9 10-SY9000

• Actuation type

1	2 position single
2	2 position double
3	3 position closed center
4	3 position exhaust center
5	3 position pressure center

• Pilot type

Nil	Internal pilot
R	External pilot

• Coil type

Nil	Standard
T	With power saving circuit (24, 12 VDC only)

* Power saving circuit is not available for D, Y, DO, YO or W□ types.

• Rated voltage

For DC

5	24 VDC
6	12 VDC
V	6 VDC
S	5 VDC
R	3 VDC

For AC (%₆₀ Hz)

1	100 VAC
2	200 VAC
3	110 VAC [115 VAC]
4	220 VAC [230 VAC]

* DC specifications of type D, Y, DO and YO are only available with 12 and 24 VDC.
* For type W□, only DC voltage is available.

Note) AC-type models that are CE-compliant have DIN terminals only.

• CE-compliant

Nil	—
Q	CE-compliant

Note) AC-type models that are CE-compliant have DIN terminals only.

• Made to Order

Nil	—
X90	Main valve fluororubber (Refer to page 169.)

• Manual override

Nil	Non-locking push type
D	Push-turn locking slotted type
E	Push-turn locking lever type

• Light/Surge voltage suppressor

Electrical entry for G, H, L, M, W

Nil	Without light/surge voltage suppressor
S	With surge voltage suppressor
Z	With indicator light and surge voltage suppressor
R	With surge voltage suppressor (Non-polar type)
U	With light/surge voltage suppressor (Non-polar type)

* For AC voltage valves there is no "S" option. It is already built into the rectifier circuit.
* For "R" and "U", only DC voltage is available.
* Power saving circuit is only available for the "Z" type.

Electrical entry for D, Y

Nil	Without light/surge voltage suppressor
S	With surge voltage suppressor (Non-polar type)
Z	With light/surge voltage suppressor (Non-polar type)

* DOZ and YOZ are not available.
* For AC voltage valves there is no "S" option. It is already built into the rectifier circuit.

• Electrical entry

		24, 12, 6, 5, 3 VDC/ 100, 110, 200, 220 VAC			24, 12 VDC/ 100, 110, 200, 220 VAC	24, 12, 6, 5, 3 VDC	
		Grommet	L plug connector	M plug connector	DIN terminal	M8 connector	
G:	Lead wire length 300 mm	L:	With lead wire (Length 300 mm)	M:	With lead wire (Length 300 mm)	D:	With connector
H:	Lead wire length 600 mm	LN:	Without lead wire	MN:	Without lead wire	DO:	Without connector
		LO:	Without connector	MO:	Without connector	Y:	With connector
						YO:	Without connector
						W□:	Without connector cable
						W□:	With connector cable ^{Note)}
CE-compliant	DC	●	●	●	●	●	●
	AC	—	—	—	●	—	—

- * LN, MN type: With 2 sockets.
 - * DIN terminal type "Y" which conforms to EN-175301-803C (former DIN43650C) is also available. For details, refer to page 173.
 - * For connector cable of M8 connector, refer to page 176.
 - * M8 connector conforming to IEC60947-5-2 standard is also available. Refer to page 168 for details.
 - * Refer to page 173 for the lead wire length of L and M plug connectors.
 - * Refer to page 174 for the connector assembly with cover for L and M plug connectors.
- Note) Enter the cable length symbols in □. Please be sure to fill in the blank referring to page 176.

Note) When ordering a single unit of the base mounted type solenoid valve, the mounting screws and gasket for the manifold are included.

Manifold Specifications



Model		10-SS5Y9-43(-Q)	
Applicable valve		10-SY9□40	
Manifold type		Stacking type	
P (SUP)/R (EXH)		Common SUP, Common EXH	
Valve stations		2 to 20 stations ^{Note 1)}	
A, B port	Location	Base	
Porting specifications	Direction	Side	
	P, EA, EB port	C12 (ø12 One-touch fitting)	
Port size	A, B port	1/4	
		3/8	
		C8 (ø8 One-touch fitting)	
		C10 (ø10 One-touch fitting)	
C12 (ø12 One-touch fitting)			
Manifold base weight		W = 107n + 330	
W (g), n: Stations			

Note 1) For more than 10 stations, supply pressure to P port on both sides and exhaust from EA/EB port on both sides.

Note 2) Refer to "Manifold Option" on page 148.

Flow Rate Characteristics

Model	Port size		Flow rate characteristics					
	1, 5, 3 (P, EA, EB)	4, 2 (A, B)	1→4/2 (P→A/B)			4/2→5/3 (A/B→EA/EB)		
	C (dm ³ /s(bar))	b	Cv	b	Cv	C (dm ³ /s(bar))	b	Cv
10-SS5Y9-43(-Q)	C12	C12	6.4	0.29	1.6	7.3	0.29	1.8

Note) The values are for individually operated 2 position type manifold bases with 5 stations.

Directional Control Valves

Air Cylinders

Rotary Actuators

Air Grippers

Air Preparation Equipment

Modular F. R.

Pressure Control Equipment

Fittings & Tubing

Flow Control Equipment

Pressure Switches/ Pressure Sensors

10-SY9000: 10-SS5Y9-43- Stations _{02, C8, N9} _{03, C10, N11} **(-D)**

[] : AC

Grommet (G)

* When P, R port outlets are indicated on the D side, the P, R ports on the opposite side are plugged.

With External Pilot Specifications

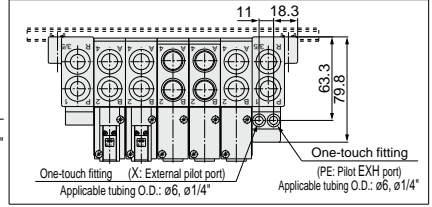
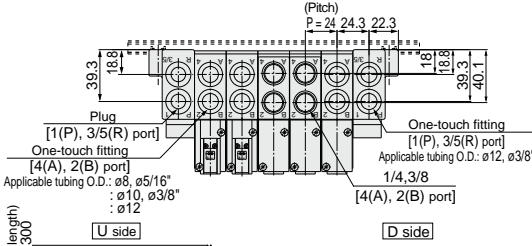

* The air discharge port for built-in silencers and the external pilot's entry position are on the D side.

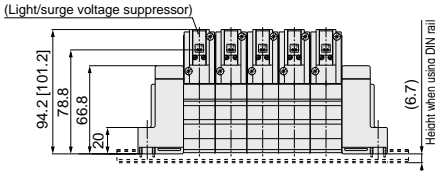
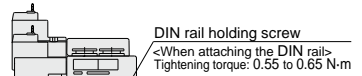
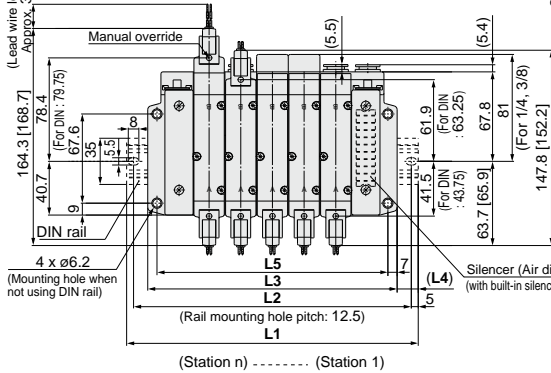

Stations	2 stations	3	4	5	6	7	8	9	10 stations
L1	148	173	198	223	248	260.5	285.5	310.5	335.5
L2	137.5	162.5	187.5	212.5	237.5	250	275	300	325
L3	117	141	165	189	213	237	261	285	309
L4	15.5	16	16.5	17	17.5	12	12.5	13	13.5
L5	103	127	151	175	199	223	247	271	295

L plug connector (L)

M plug connector (M)

DIN terminal (D, Y)

M8 connector (WO)

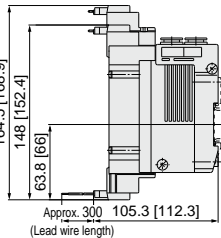
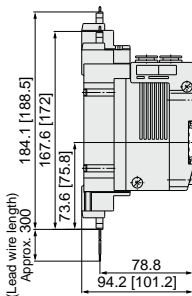

Applicable cable O.D.
ø3.5 to ø7

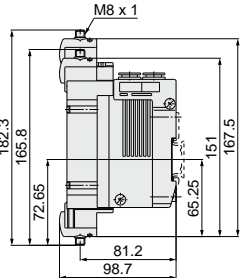
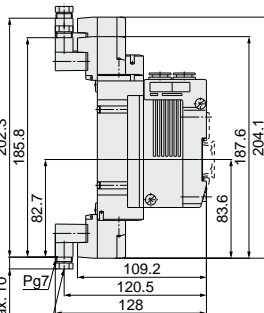

Note) Refer to page 176 for dimensions of connector types.

10-SY9000: 10-SS5Y9-43- Stations U ⁰²₀₃ ^{C9, N9}_{C10, N11} **(-D)**

[] : AC

Grommet (G)

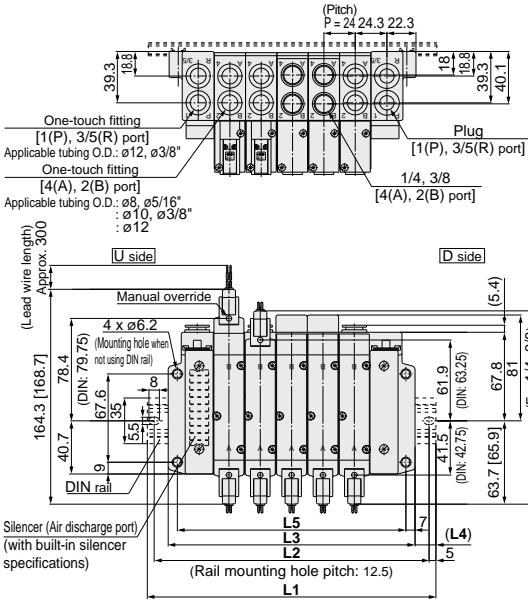

* When P, R port outlets are indicated on the U side, the P, R ports on the opposite side are plugged.

With External Pilot Specifications

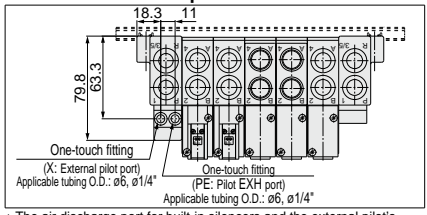

* The air discharge port for built-in silencers and the external pilot's entry position are on the D side.

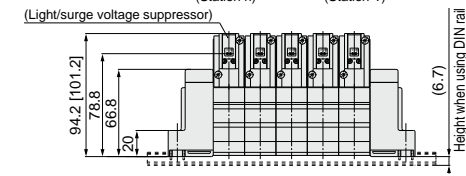
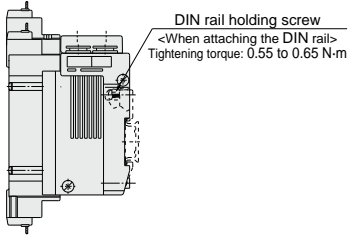

Stations	2 stations	3	4	5	6	7	8	9	10 stations
L1	148	173	198	223	248	260.5	285.5	310.5	335.5
L2	137.5	162.5	187.5	212.5	237.5	250	275	300	325
L3	117	141	165	189	213	237	261	285	309
L4	15.5	16	16.5	17	17.5	12	12.5	13	13.5
L5	103	127	151	175	199	223	247	271	295

L plug connector (L)

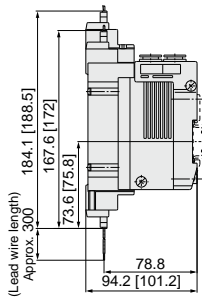

M plug connector (M)

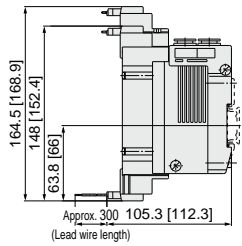

DIN terminal (D, Y)

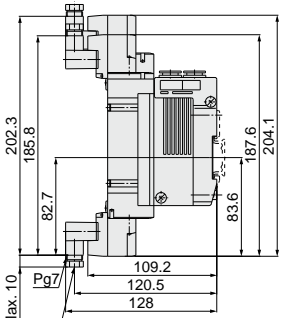

M8 connector (WO)

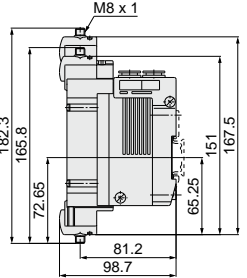

Note) Refer to page 176 for dimensions of connector types.

Directional Control Valves

Air Cylinders

Rotary Actuators

Air Grippers

Air Preparation Equipment

Modular F. R.

Pressure Control Equipment

Fittings & Tubing

Flow Control Equipment

Flow Control Equipment

Pressure Switches/Pressure Sensors

10-SY9000: 10-SS5Y9-43- Stations ⁰² ₀₃ ^{C8, N9} _{C10, N11} **(-D)**

[]: AC

Grommet (G)

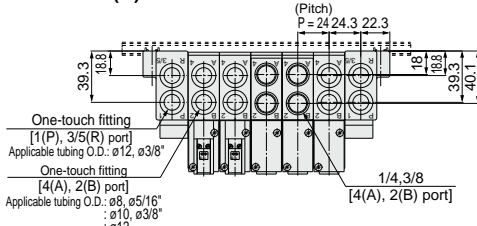

When P, R port outlets are indicated on the B side, the P, R ports on the both sides are in the open state.

With External Pilot Specifications

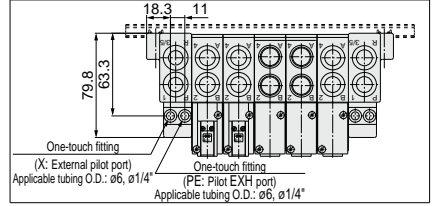

The Air discharge port for built-in silencers and the external pilot's entry position are on the B side (both sides).

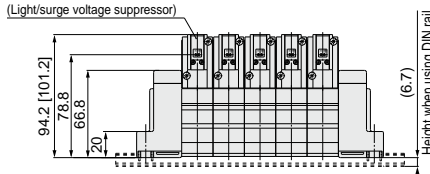
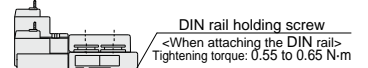
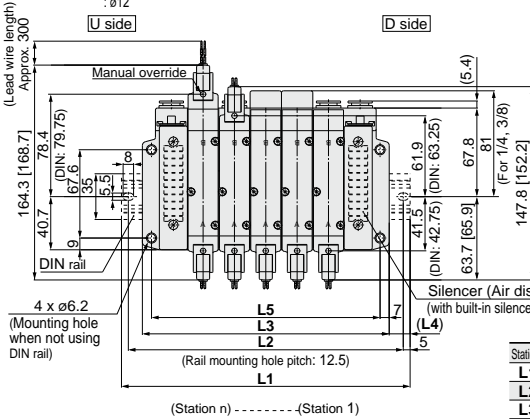

Stations	2 stations	3	4	5	6	7	8	9	10 stations
L1	148	173	198	223	248	260.5	285.5	310.5	335.5
L2	137.5	162.5	187.5	212.5	237.5	250	275	300	325
L3	117	141	165	189	213	237	261	285	309
L4	15.5	16	16.5	17	17.5	12	12.5	13	13.5
L5	103	127	151	175	199	223	247	271	295

Stations	11 stations	12	13	14	15	16	17	18	19	20 stations
L1	360.5	385.5	410.5	435.5	460.5	485.5	510.5	535.5	560.5	573
L2	350	375	400	425	450	475	500	525	550	562.5
L3	333	357	381	405	429	453	477	501	525	549
L4	14	14.5	15	15.5	16	16.5	17	17.5	18	12
L5	319	343	367	391	415	439	463	487	511	535

L plug connector (L)

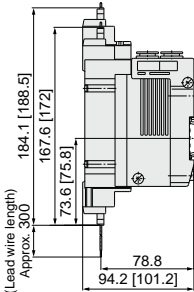

M plug connector (M)

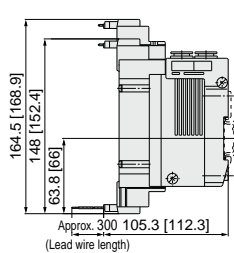

DIN terminal (D, Y)

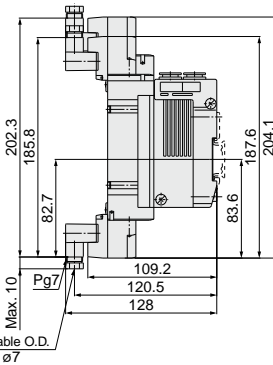

M8 connector (WO)

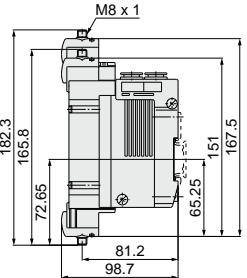

Note) Refer to page 176 for dimensions of connector types.



Note) CE-compliant:
For DC only. [Option]

How to Order Manifold

Type 41P/Compact type

10 - SS5Y 5 - 41P - 05 - C8 - [] - []

Clean series

Manifold series

3	10-SY3000
5	10-SY5000

Stations

03	3 stations
:	:
12	12 stations

* 10-SS5Y3 has 4 to 12 stations.
* Includes the number of blanking plate assemblies.

A, B port size
Thread piping

Symbol	Port size	Applicable series
M5	M5 x 0.8	10-SY3000
01	1/8	10-SY5000

Thread type

Symbol	Thread type	CE-compliant
Nil	Rc	Nil
F	G	Q
N	NPT	Q
T	NPTF	Q

Note) CE-compliant:
For DC only.

One-touch fitting (Metric size)

Symbol	Port size	Applicable series
C4	ø4 One-touch fitting	10-SY3000
C6	ø6 One-touch fitting	10-SY5000
C6	ø6 One-touch fitting	10-SY5000
C8	ø8 One-touch fitting	10-SY5000

One-touch fitting (Inch size)

Symbol	Port size	Applicable series
N3	ø5/32 One-touch fitting	10-SY3000
N7	ø1/4" One-touch fitting	10-SY5000
N7	ø1/4" One-touch fitting	10-SY5000
N9	ø3/16 One-touch fitting	10-SY5000

Type 42P/Common external pilot

10 - SS5Y 5 - 42P - 05 - C8 - [] - []

Clean series

Manifold series

3	10-SY3000
5	10-SY5000
7	10-SY7000

Stations

03	3 stations
:	:
12	12 stations

* 10-SS5Y3 has 4 to 12 stations.
* Includes the number of blanking plate assemblies.

A, B port size
Thread piping

Symbol	Port size	Applicable series
01	1/8	10-SY3000
02	1/4	10-SY5000
02	1/4	10-SY7000

Thread type

Symbol	Thread type	CE-compliant
Nil	Rc	Nil
F	G	Q
N	NPT	Q
T	NPTF	Q

Note) CE-compliant:
For DC only.

One-touch fitting (Metric size)

Symbol	Port size	Applicable series
C4	ø4 One-touch fitting	10-SY3000
C6	ø6 One-touch fitting	10-SY5000
C6	ø6 One-touch fitting	10-SY5000
C8	ø8 One-touch fitting	10-SY5000
C10	ø10 One-touch fitting	10-SY7000

One-touch fitting (Inch size)

Symbol	Port size	Applicable series
N3	ø5/32 One-touch fitting	10-SY3000
N7	ø1/4" One-touch fitting	10-SY5000
N7	ø1/4" One-touch fitting	10-SY5000
N9	ø3/16 One-touch fitting	10-SY5000
N11	ø3/8" One-touch fitting	10-SY7000

How to Order Manifold Assembly (Example)

Example

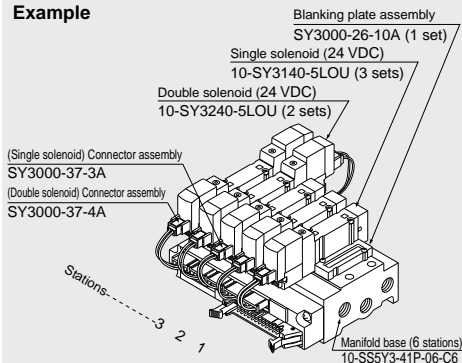

- 10-SS5Y3-41P-06-C6 ... 1 set (Type 41P, 6-station manifold base part no.)
 * SY3000-26-10A 1 set (Blanking plate assembly part no.)
 * 10-SY3140-5LOU 3 sets (Single solenoid part no.)
 * 10-SY3240-5LOU 2 sets (Double solenoid part no.)
 * SY3000-37-3A 3 sets (Connector assembly part no.)
 * SY3000-37-4A 2 sets (Connector assembly part no.)

The asterisk denotes the symbol for assembly.
Prefix it to the part no. of the solenoid valve, etc.

Add the valve and option part number under the manifold base part number. For complex arrangements, specify them on the manifold specification sheet.

Note) Please indicate the connector assembly part no. (page 135) that connects the valve and the manifold.

Directional Control Valves

Air Cylinders

Rotary Actuators

Air Grippers

Air Preparation Equipment

Modular F. R.

Pressure Control Equipment

Fittings & Tubing

Flow Control Equipment

Pressure Switches/Pressure Sensors

How to Order Valve

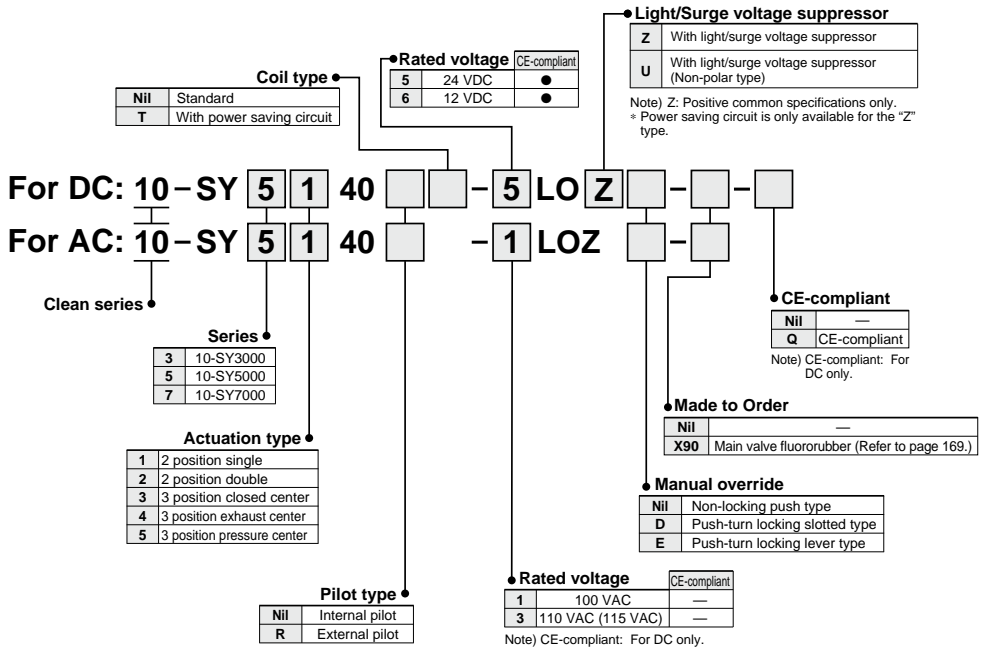

Note) When ordering single a unit of the base mounted type solenoid valve, the mounting screws and gasket for the manifold are included.

Note) For flat ribbon cables, "U" and "Z" types are for DC specifications and "Z" type is for AC specifications. "Z" type for DC is positive common specification only. For other combinations, please contact SMC.

Note) Since the electrical entry is "LO", select an appropriate connector assembly part no.

Connector Assembly

For 12, 24 VDC

Specifications	For 10-SY3000	For 10-SY5000/7000
For single solenoid	SY3000-37-3A	SY5000-37-3A
Double solenoid, 3 position type	SY3000-37-4A	SY5000-37-4A
Single with spacer assembly	SY5000-37-3A	SY5000-37-5A
Double, 3 position with spacer assembly	SY3000-37-6A	SY5000-37-6A

For 100 VAC

Specifications	For 10-SY3000	For 10-SY5000/7000
For single solenoid	SY3000-37-32A	SY5000-37-15A
Double solenoid, 3 position type	SY3000-37-33A	SY5000-37-16A
Single with spacer assembly	SY5000-37-15A	SY5000-37-17A
Double, 3 position with spacer assembly	SY3000-37-34A	SY5000-37-18A

For 110 VAC (115 VAC)

Specifications	For 10-SY3000	For 10-SY5000/7000
For single solenoid	SY3000-37-35A	SY5000-37-19A
Double solenoid, 3 position type	SY3000-37-36A	SY5000-37-20A
Single with spacer assembly	SY5000-37-19A	SY5000-37-21A
Double, 3 position with spacer assembly	SY3000-37-37A	SY5000-37-22A

Note) Spacer assembly indicates individual SUP/EXH spacer.

Flat Ribbon Cable Manifold Specifications

- Multiple valve wiring is simplified through the use of the flat ribbon cable connector.
- Clean appearance

For flat ribbon cables, each valve is wired on the print board of the manifold base to allow the external wiring to be piped all together with the 26 pin MIL connector.



Model	10-SS5Y3-41P(-Q)		10-SS5Y3-42P(-Q)		10-SS5Y5-41P(-Q)		10-SS5Y5-42P(-Q)		10-SS5Y7-42P(-Q)		
Applicable valve	10-SY3□40		10-SY5□40		10-SY5□40		10-SY7□40				
Manifold type	Single base/B mount										
P (SUP/R (EXH))	Common SUP, Common EXH										
Valve stations	4 to 12 stations (Note 1)					3 to 12 stations (Note 1)					
A, B port	Base										
Porting specifications	Side										
Port size	P, EA, EB port	1/8		1/8		1/4		1/4		1/4	
	A, B port	C4 (ø4 One-touch fitting) C6 (ø6 One-touch fitting)		C4 (ø4 One-touch fitting) C6 (ø6 One-touch fitting)		C6 (ø6 One-touch fitting) C8 (ø8 One-touch fitting)		C6 (ø6 One-touch fitting) C8 (ø8 One-touch fitting)		C10 (ø10 One-touch fitting)	
Manifold base weight W (g), n: Stations	W = 39n + 83		W = 48n + 99		W = 67n + 118		W = 88n + 151		W = 109n + 174		
Applicable flat ribbon cable connector	Flat ribbon cable connector, Socket: 26 pin MIL type with strain relief, Conforming to MIL-C-83503										
Internal wiring	Common between +COM and -COM (Z type: +COM only).										
Rated voltage (Note 4)	12, 24 VDC, 100, 110 VAC										

Note 1) For more than 10 stations (more than 5 stations in case of 10-SS5Y7), supply pressure to P port on both sides and exhaust from EA/EB port on both sides.

Note 2) The withstand voltage specification for the wiring unit section is JIS C 0704, Grade 1 or its equivalent.

Note 3) Refer to "Manifold Option" on page 148.

Note 4) CE-compliant: For DC only.

Flow Rate Characteristics

Model	Port size		Flow rate characteristics					
	1, 5, 3 (P, EA, EB)	4, 2 (A, B)	1 → 4/2 (P → A/B)			4/2 → 5/3 (A/B → EA/EB)		
			C (dm³/(s·bar))	b	Cv	C (dm³/(s·bar))	b	Cv
10-SS5Y3-41P	1/8	C6	0.75	0.19	0.18	0.81	0.23	0.20
10-SS5Y3-42P	1/8	C6	0.75	0.20	0.18	0.82	0.20	0.20
10-SS5Y5-41P	1/4	C8	1.8	0.23	0.44	1.9	0.16	0.45
10-SS5Y5-42P	1/4	C8	1.9	0.20	0.46	1.9	0.12	0.43
10-SS5Y7-42P	1/4	C10	3.0	0.25	0.75	3.0	0.12	0.66

Note) The values are for individually operated 2 position type manifold bases with 5 stations.

Internal Wiring of Manifold

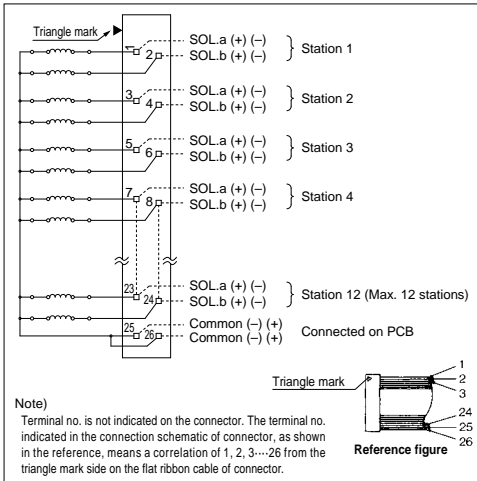

- For more than 10 stations, both poles of the common should be wired.
- For single solenoid, connect to the solenoid A side.
- The maximum number of stations that can be accommodated is 12. For more stations, please contact SMC.

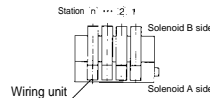

Caution

- For non-polar "U" valves, the electrical DC connections can be used with either positive and negative COM. For type "Z", only use with positive COM as the valve does not operate correctly when used with negative COM.

Directional Control Valves
 Air Cylinders
 Rotary Actuators
 Air Grippers
 Air Preparation Equipment
 Modular F. R.
 Pressure Control Equipment
 Fittings & Tubing
 Flow Control Equipment
 Pressure Switches/ Pressure Sensors

10-SY3000: 10-SS5Y3-41P- Stations -M5, C4, N3, C6, N7

[] : AC

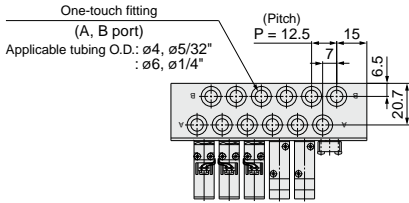

For M5 x 0.8

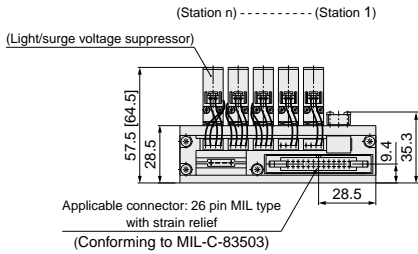
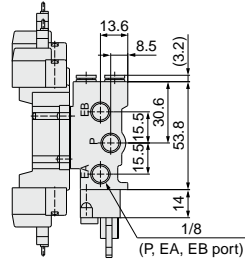
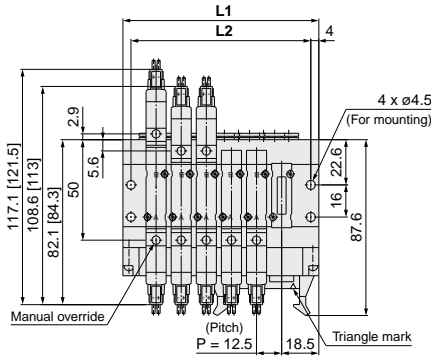
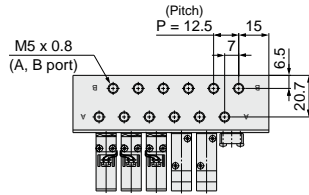

Stations	4	5	6	7	8	9	10	11	12
L1	72.5	85	97.5	110	122.5	135	147.5	160	172.5
L2	64.5	77	89.5	102	114.5	127	139.5	152	164.5

10-SY5000: 10-SS5Y5-41P- Stations -01, C6, N7
C8, N9

[] : AC

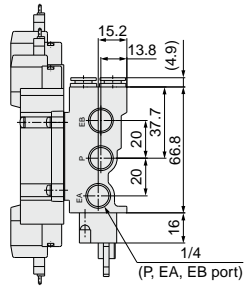
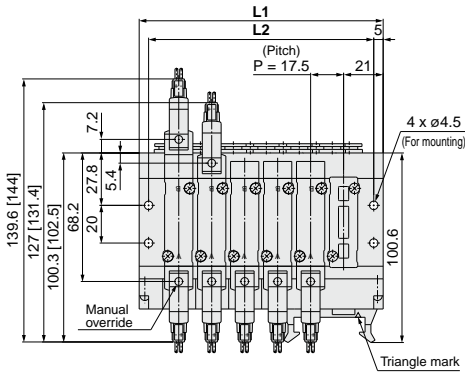
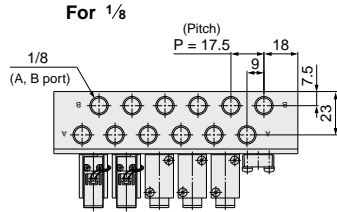
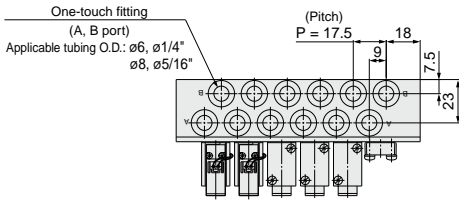

(Station n) ----- (Station 1)

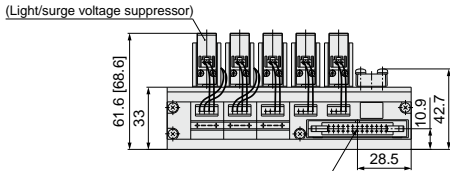

Applicable connector: 26 pin MIL type
with strain relief
(Conforming to MIL-C-83503)

Stations	3	4	5	6	7	8	9	10	11	12
L1	77	94.5	112	129.5	147	164.5	182	199.5	217	234.5
L2	67	84.5	102	119.5	137	154.5	172	189.5	207	224.5

Directional Control Valves
Air Cylinders
Rotary Actuators
Air Grippers
Air Preparation Equipment
Modular F. R.
Pressure Control Equipment
Fittings & Tubing
Flow Control Equipment
Pressure Switches/
Pressure Sensors

10-SY5000: 10-SS5Y5-42P- Stations -02, C6, N7
C8, N9

[] : AC

Grommet (G)

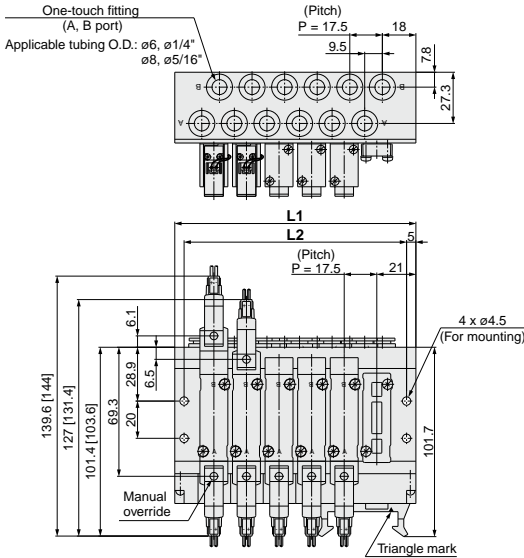

For 1/4

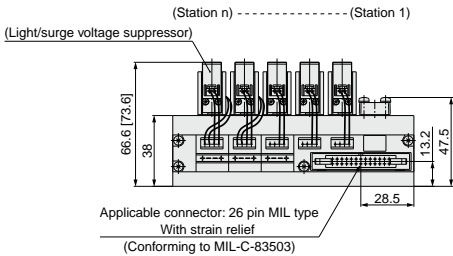
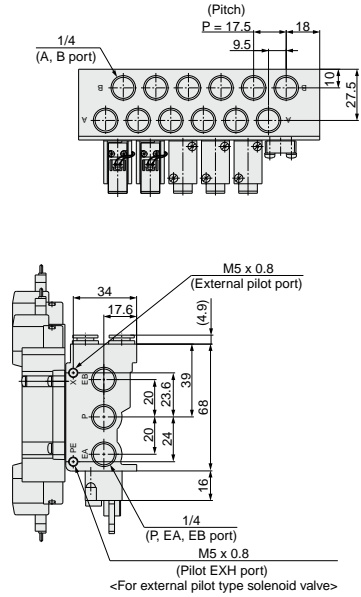

Stations	3	4	5	6	7	8	9	10	11	12
L1	77	94.5	112	129.5	147	164.5	182	199.5	217	234.5
L2	67	84.5	102	119.5	137	154.5	172	189.5	207	224.5

Directional Control Valves

Air Cylinders

Rotary Actuators

Air Grippers

Air Preparation Equipment

Modular F. R.

Pressure Control Equipment

Fittings & Tubing

Flow Control Equipment

Pressure Switches/ Pressure Sensors

10-SY7000: 10-SS5Y7-42P- Stations -02, C10, N11

[]: AC

Grommet (G)

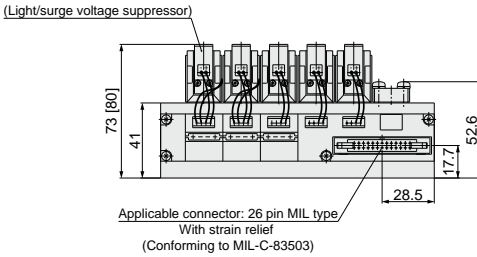
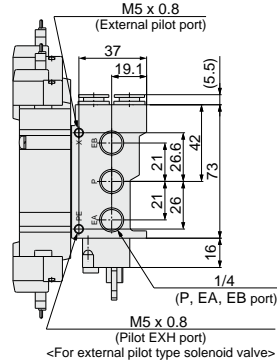
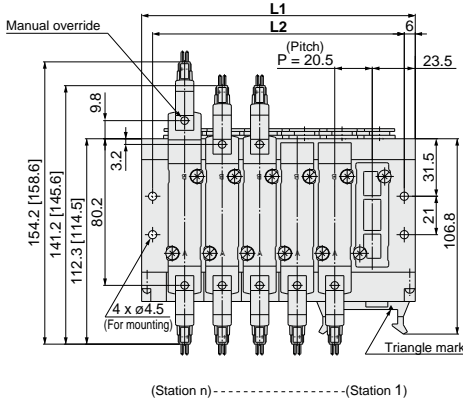
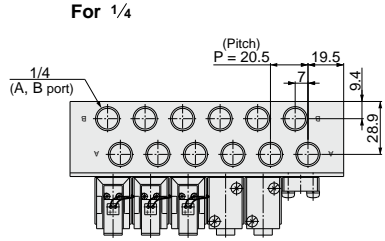
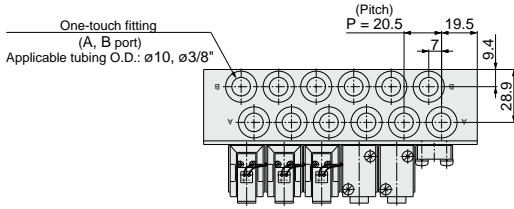

Stations	3	4	5	6	7	8	9	10	11	12
L1	88	108.5	129	149.5	170	190.5	211	231.5	252	272.5
L2	76	96.5	117	137.5	158	178.5	199	219.5	240	260.5

Type 43P Series 10-SY9000

5 Port Solenoid Valve Base Mounted Manifold Stacking Type/Flat Ribbon Cable

Note) CE-compliant:
For DC only. [Option]



Directional Control Valves

How to Order Manifold

10-SS5Y9-43P-05 U - C8 - - -

• Clean series

• Manifold series
9 10-SY9000

• Valve stations

Symbol	Stations
04	4 stations
:	:
12	12 stations

* Includes the number of blanking plate assemblies.

• P, R port outlets

Symbol	Port outlet	Applicable stations
U	U side	4 to 10 stations
D	D side	4 to 10 stations
B	Both sides	4 to 12 stations

• SUP/EXH block assembly specifications

Symbol	Specifications
NII	Standard/Internal pilot specification
R	External pilot specification

• Thread type

Nil	Rc
F	G
N	NPT
T	NPTF

• Option

Symbol	Mounting
NII	Direct mounting
D	DIN rail mounting (with DIN rail)
D0	DIN rail mounting (without DIN rail)
D*	When a longer DIN rail is desired than the specified stations, specify the station number to be required into * mark.

• A, B port size

Thread piping	Port size
02	1/4
03	3/8

• One-touch fitting (Metric size)

Symbol	Port size
C8	ø8 One-touch fitting
C10	ø10 One-touch fitting
C12	ø12 One-touch fitting
M	Mixed

• One-touch fitting (Inch size)

Symbol	Port size
N9	ø5/16" One-touch fitting
N11	ø3/8" One-touch fitting
M	Mixed

* For mixed specifications (M), indicate separately on the manifold specification sheet.

• CE-compliant

Nil	-
Q	CE-compliant

Note) CE-compliant: For DC only.

How to Order Manifold Assembly (Example)

Example

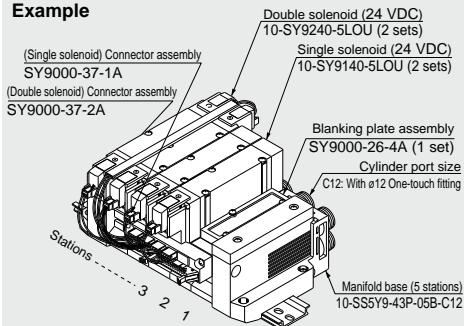

10-SS5Y9-43P-05B-C12... 1 set (Type 43P, 5-station manifold base part no.)
 * SY9000-26-4A 1 set (Blanking plate assembly part no.)
 * 10-SY9140-5LOU 2 sets (Single solenoid part no.)
 * 10-SY9240-5LOU 2 sets (Double solenoid part no.)
 * SY9000-37-1A 2 sets (Connector assembly part no.)
 * SY9000-37-2A 2 sets (Connector assembly part no.)

The asterisk denotes the symbol for assembly. Prefix it to the part no. of the solenoid valve, etc.

Add the valve and option part number under the manifold base part number. For complex arrangements, specify them on the manifold specification sheet.

Note) Please indicate the connector assembly part no. (page 143) that connects the valve and the manifold.

Air Cylinders

Rotary Actuators

Air Grippers

Air Preparation Equipment

Modular F. R.

Pressure Control Equipment

Fittings & Tubing

Flow Control Equipment

Pressure Switches/ Pressure Sensors

How to Order Valve

Note) CE-compliant:
For DC only.

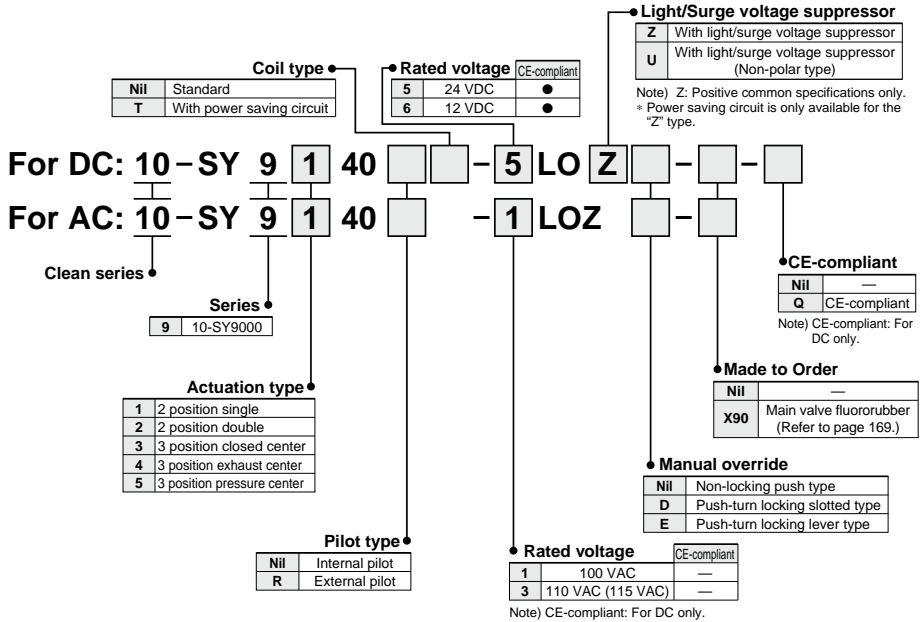

Note) When ordering a single unit of the base mounted type solenoid valve, the mounting screws and gasket for the manifold are included.

Note) For flat ribbon cables, "U" and "Z" types are for DC specifications and "Z" type is for AC specifications. "Z" type for DC is positive common specification only.
For other combinations, please contact SMC.

Note) Since the electrical entry is "LO", select an appropriate connector assembly part no.

Connector Assembly

For 12, 24 VDC

Specifications	For 10-SY9000
For single solenoid	SY9000-37-1A
Double solenoid, 3 position type	SY9000-37-2A
Single with spacer assembly	SY9000-37-3A
Double, 3 position with spacer assembly	SY9000-37-4A

Note) Spacer indicates individual SUP/EXH spacer.

For 100 VAC

Specifications	For 10-SY9000
For single solenoid	SY9000-37-1B
Double solenoid, 3 position type	SY9000-37-2B
Single with spacer assembly	SY9000-37-3B
Double, 3 position with spacer assembly	SY9000-37-4B

For 110 VAC (115 VAC)

Specifications	For 10-SY9000
For single solenoid	SY9000-37-1C
Double solenoid, 3 position type	SY9000-37-2C
Single with spacer assembly	SY9000-37-3C
Double, 3 position with spacer assembly	SY9000-37-4C

Flat Ribbon Cable Manifold Specifications

- **Multiple valve wiring is simplified through the use of the flat ribbon cable connector.**
- **Clean appearance**

For flat ribbon cables, each valve is wired on the print board of the manifold base to allow the external wiring to be piped all together with the 26 pin MIL connector.



Model		10-SS5Y9-43P	
Applicable valve		10-SY9□40	
Manifold type		Stacking type	
P (SUP)/R (EXH)		Common SUP, Common EXH	
Valve stations		4 to 12 stations ^{Note 1)}	
A, B port	Location	Base	
	Direction	Side	
Porting specifications	P, EA, EB port	C12 (ø12 One-touch fitting)	
	A, B port	1/4 3/8 C8 (ø8 One-touch fitting) C10 (ø10 One-touch fitting) C12 (ø12 One-touch fitting)	
Manifold base weight W (g) n: Stations		W = 114n + 343	
Applicable flat ribbon cable connector		Flat ribbon cable connector, Socket: 26 pin MIL type with strain relief, Conforming to MIL-C-83503	
Internal wiring		Common between +COM and -COM (Z type: +COM only)	
Rated voltage ^{Note 4)}		12, 24 VDC, 100, 110 VAC	

- Note 1) For more than 10 stations, supply pressure to P port on both sides and exhaust from EA/EB port on both sides.
 Note 2) The withstand voltage specification for the wiring unit section is JIS C 0704, Grade 1 or its equivalent.
 Note 3) Refer to "Manifold Option" on page 148.
 Note 4) CE-compliant: For DC only.

Flow Rate Characteristics

Model	Port size		Flow rate characteristics					
	1, 5, 3 (P, EA, EB)	4, 2 (A, B)	1 → 4/2 (P → A/B)			4/2 → 5/3 (A/B → EA/EB)		
			C (dm ³ /(s·bar))	b	Cv	C (dm ³ /(s·bar))	b	Cv
10-SS5Y9-43P	C12	C12	6.4	0.29	1.6	7.3	0.29	1.8

Note) The values are for individually operated 2 position type manifold bases with 5 stations.

Internal Wiring of Manifold (Non-polar type)

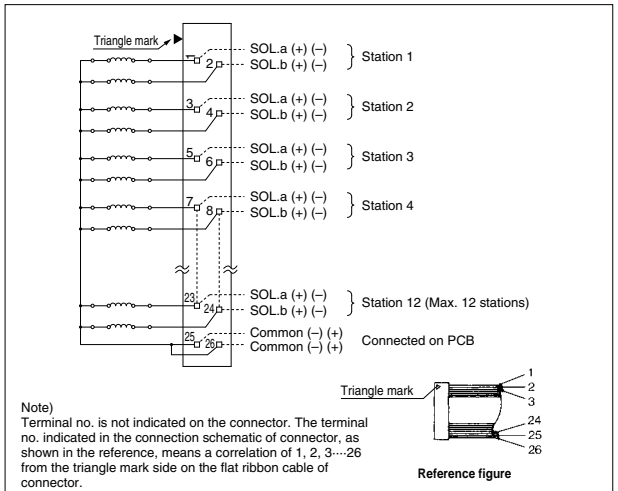

⚠ Caution

- For non-polar "U" valves, the electrical DC connections can be used with either positive and negative COM. For type "Z", only use with positive COM as the valve does not operate correctly when used with negative COM.

- For more than 10 stations, both poles of the common should be wired.
- For single solenoid, connect to the solenoid A side.
- The maximum number of stations that can be accommodated is 12. For more stations, please contact SMC.

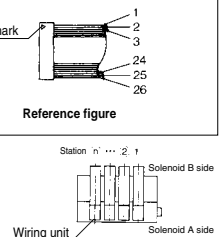

10-SY9000: 10-SS5Y9-43P- Stations U -02, C8, N9
-03, C10, N11 (-D) C12

[] : AC

* When P, R port outlets are indicated on the U side, the P, R ports on the opposite side are plugged.

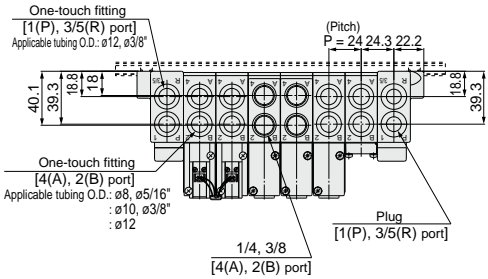

With External Pilot Specifications

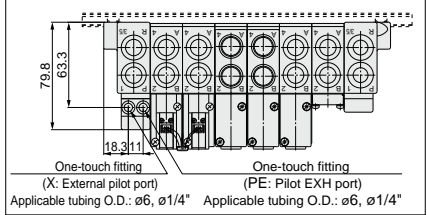

* The air discharge port for built-in silencers and the external pilot's entry position are on the U side.

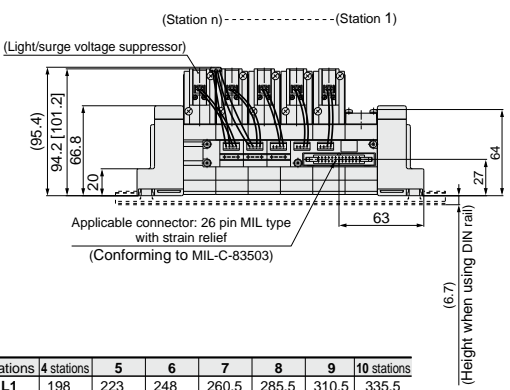
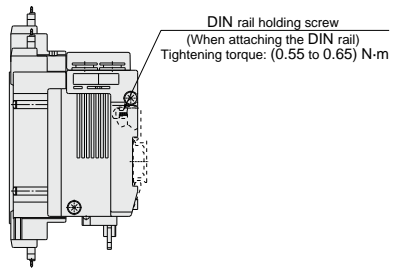
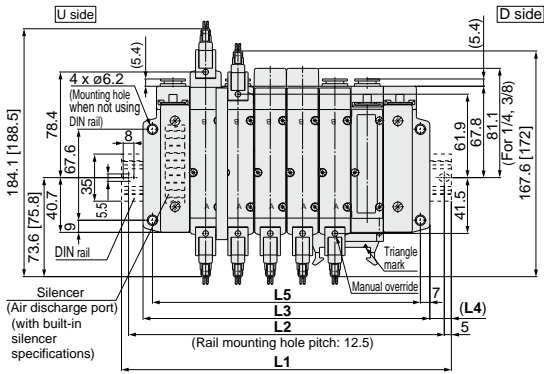

Stations	4 stations	5	6	7	8	9	10 stations
L1	198	223	248	260.5	285.5	310.5	335.5
L2	187.5	212.5	237.5	250	275	300	325
L3	165	189	213	237	261	285	309
L4	16.5	17	17.5	12	12.5	13	13.5
L5	151	175	199	223	247	271	295

Directional Control Valves

Air Cylinders

Rotary Actuators

Air Grippers

Air Preparation Equipment

Modular F. R.

Pressure Control Equipment

Fittings & Tubing

Flow Control Equipment

Pressure Switches/ Pressure Sensors

10-SY9000: 10-SS5Y9-43P- Stations B 02, C8, N9
C10, N11
C12 **(-D)**

[] : AC

* When P, R port outlets are indicated on the B side, the P, R ports on the both sides are in the open state.

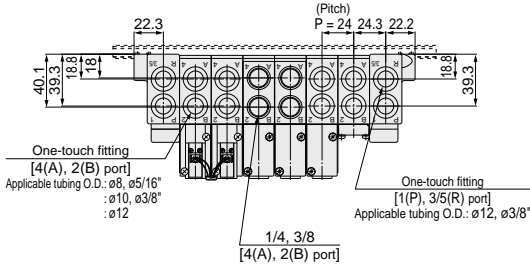

With External Pilot Specifications

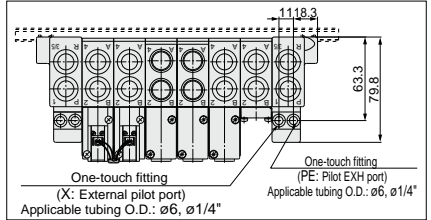

* The air discharge port for built-in silencers and the external pilot's entry position are on the B side (both sides).

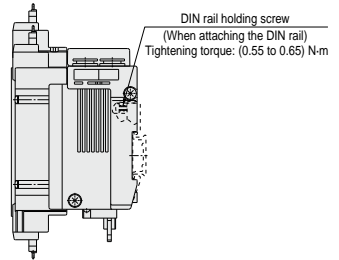
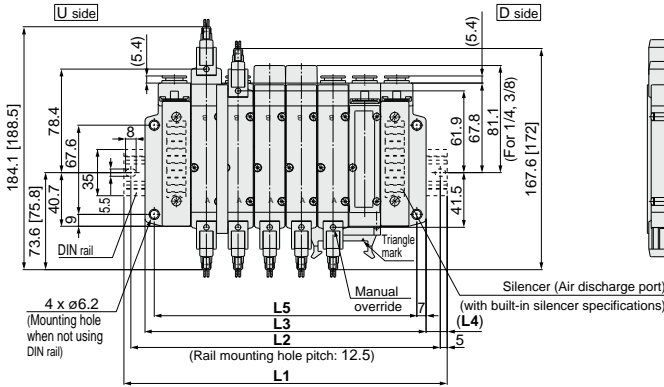

(Station n)------(Station 1)

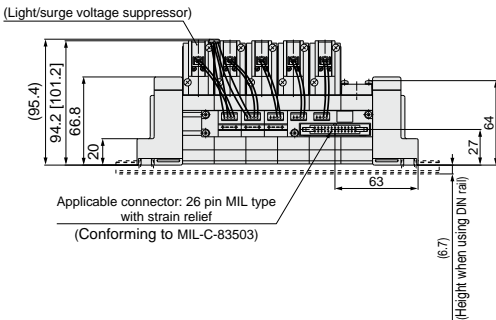

Stations	4 stations	5	6	7	8	9	10	11	12 stations
L1	198	223	248	260.5	285.5	310.5	335.5	360.5	385.5
L2	187.5	212.5	237.5	250	275	300	325	350	375
L3	165	189	213	237	261	285	309	333	357
L4	16.5	17	17.5	12	12.5	13	13.5	14	14.5
L5	151	175	199	223	247	271	295	319	343

Manifold Option

■ Type 41, 42, 43, 42SA, 43SA Blanking plate assembly



Series	Assembly part no.
10-SY3000	SY3000-26-9A(-Q)
10-SY5000	SY5000-26-20A(-Q)
10-SY7000	SY7000-26-22A(-Q)
10-SY9000	SY9000-26-2A(-Q)

■ Type 41P, 42P, 43P Blanking plate assembly



Series	Assembly part no.
10-SY3000	SY3000-26-10A(-Q)
10-SY5000	SY5000-26-21A(-Q)
10-SY7000	SY7000-26-23A(-Q)
10-SY9000	SY9000-26-4A(-Q)

■ Gasket assembly part no.

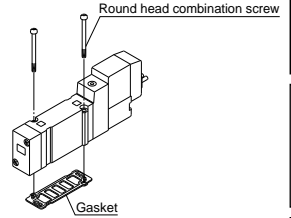

Series	Gasket assembly part no.
10-SY3000	SY3000-GS-2
10-SY5000	SY5000-GS-2(-Q)
10-SY7000	SY7000-GS-2(-Q)
10-SY9000	SY9000-GS-2

Note) The gasket assembly consists of 10 sets of mounting screws and a gasket.

■ Individual SUP spacer assembly

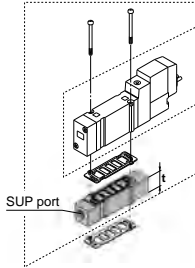

Series	Assembly part no.	Port size	t
10-SY3000	SY3000-38-2A(-Q)	M5 x 0.8	11
10-SY5000	SY5000-38-16*A(-Q)	1/8	15
10-SY7000	SY7000-38-16*A(-Q)	1/4	18
10-SY9000	SY9000-38-2*A	1/4	20

Note) • The SUP port of 10-SY3000, 5000 and 7000 may be either on the lead wire side or on the end plate side. (An assembly is shipped under the condition shown in the figure.)
• The end plate side is only available for 10-SY9000.

■ Individual EXH spacer assembly

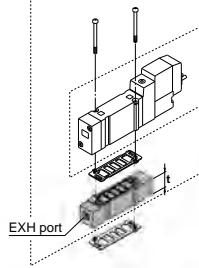

Series	Assembly part no.	Port size	t
10-SY3000	SY3000-39-2A(-Q)	M5 x 0.8	11
10-SY5000	SY5000-39-16*A(-Q)	1/8	15
10-SY7000	SY7000-39-16*A(-Q)	1/4	18
10-SY9000	SY9000-39-2*A	1/4	20

Note) In case of 41P, 42P and 43P, for protection of the wiring unit section from drainage, piping at the EA port should be arranged so that it will not be directly exposed to exhaust from the valve.

■ Individual SUP spacer assembly + Individual EXH spacer assembly (Double spacer)

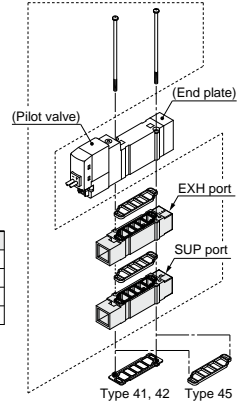

⚠ Caution

Mounting screw tightening torques
M2: 0.16 N·m
M3: 0.8 N·m
M4: 1.4 N·m

* Thread type

NII	Rc
F	G
N	NPT
T	NPTF

⚠ Warning

When mounting a valve or spacer on the manifold base or sub-plate, etc., those mounting directions are determined. If mounted in the wrong direction, the equipment to be connected may cause malfunction. Refer to external dimensions, and then mount it.

●: Available X: Not available —: Not applicable manifold]

Series	Individual SUP + Individual EXP Assembly part no.	Port size	Applicable manifold types						
			41	41P	42	42P	45	45-A 45-NA	45*
10-SY3000	SY3000-120-2A(-Q)	M5 x 0.8	●	X	●	X	●	X	X
10-SY5000	SY5000-75-1*A(-Q)	1/8	●	X	●	X	●	X	X
10-SY7000	SY7000-73-1*A(-Q)	1/4	●	X	●	X	—	—	—

Note) The port on a spacer can be directed to the pilot valve side or end plate side. For mounting the port to the pilot valve side, please make sure to connect the ports to protect the pilot valve wiring section from drainage.
The individual SUP spacer and EXH spacer can be mounted either on the upper side or lower side. (The above illustration shows the condition when the product is shipped out from a factory.)

Manifold Option

■ SUP block disk (For 10-SY9000)

By installing a SUP block disk in the pressure supply passage of a manifold base, it is possible to supply two or more different high and low pressures to one manifold.



Series	No.
10-SY9000	SY9000-57-1A

■ EXH block disk (For 10-SY9000)

By installing an EXH block disk in the exhaust passage of a manifold base, it is possible to divide the valve's exhaust so that it does not affect another valve. (Two block disks are needed to divide both exhausts.)



Series	No.
10-SY9000	SY9000-57-1A

■ Label for block disk (For 10-SY9000)

The labels shown below are used on manifold stations containing SUP/EXH block disk(s) to show their location. (3 pcs. each)

VZ3000-123-1A

Label for SUP block disk Label for EXH block disk Label for SUP/EXH block disk



Note) When a block disk is concurrently ordered by specifying it on the manifold specification sheet, etc., a label will be attached to the position where the block disk is mounted.

■ DIN Rail Dimensions/Weight for 10-SY9000

VZ1000-11-4-□

■ Refer to L dimensions

* Enter a number from the DIN rail dimension table below.

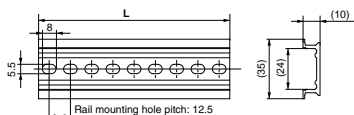

No.	0	1	2	3	4	5	6	7	8	9
L Dimension	98	110.5	123	135.5	148	160.5	173	185.5	198	210.5
Weight (g)	24.8	28	31.1	34.3	37.4	40.6	43.8	46.9	50.1	53.3
No.	10	11	12	13	14	15	16	17	18	19
L Dimension	223	235.5	248	260.5	273	285.5	298	310.5	323	335.5
Weight (g)	56.4	59.6	62.7	65.9	69.1	72.2	75.4	78.6	81.7	84.9
No.	20	21	22	23	24	25	26	27	28	29
L Dimension	348	360.5	373	385.5	398	410.5	423	435.5	448	460.5
Weight (g)	88	91.2	94.4	97.5	100.7	103.9	107	110.2	113.3	116.5

Note) • Refer to page 175 for DIN rail.
• Refer to L1 dimension on pages 131 to 133 and 145 to 147 for lengths that correspond to the number of manifold stations.

■ Cable assembly (For 41P, 42P, 43P)

AXT100-FC26- $\frac{1}{3}$

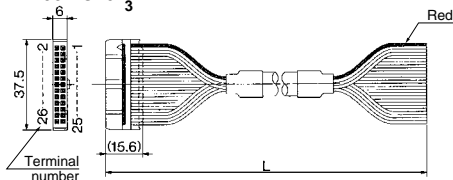

Connector Assembly for Flat Ribbon Cables

Cable length (L)	Assembly part no.	Note
1.5 m	AXT100-FC26-1	Cable 26 core x 28 AWG
3 m	AXT100-FC26-2	
5 m	AXT100-FC26-3	

* For other commercial connectors, use a 26 pin connector with strain relief conforming to MIL-C-83503.

Example of connector manufacturers

- HIROSE ELECTRIC CO., LTD.
- Japan Aviation Electronics Industry, Limited
- 3M Japan Limited
- J.S.T. Mfg. Co., Ltd.
- Fujitsu Limited

■ Plug (white)

These are inserted in unused cylinder ports and SUP, EXH ports. Purchase orders are available in units of 10 pieces.

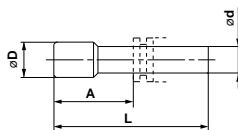

Dimensions

Applicable fittings size ød	Model	A	L	D
4	10-KQ2P-04	16	32	6
6	10-KQ2P-06	18	35	8
8	10-KQ2P-08	20.5	39	10
10	10-KQ2P-10	22	43	12
12	10-KQ2P-12	24	44.5	14
1/8"	10-KQ2P-01	16	31.5	5
5/32"	10-KQ2P-03	16	32	6
1/4"	10-KQ2P-07	18	35	8.5
5/16"	10-KQ2P-09	20.5	39	10
3/8"	10-KQ2P-11	22	43	11.5

Type 45 Series 10-SY3000/5000

5 Port Solenoid Valve
Base Mounted Manifold
Stacking Type/DIN Rail Mounted/Individual Wiring

Note) AC-type models that are CE-compliant have DIN terminals only. [Option]



Directional Control Valves

How to Order Manifold

10-SS5Y 3 -45-05 U -C6 - - -

• Clean series

• Series

3	10-SY3000
5	10-SY5000

• Valve stations

02	2 stations
⋮	⋮
20	20 stations

• SUP/EXH block assembly mounting position

Symbol	Mounting position	Applicable no. of stations
U	U side	2 to 10 stations
D	D side	2 to 10 stations
B	Both sides	2 to 20 stations
M*	Special specifications	

* For special specifications, indicate separately with the manifold specification sheet.

• Option

When a longer DIN rail is desired than the specified stations, specify the station number to be required. (20 stations at maximum)

• CE-compliant

Nil	—
Q	CE-compliant

Note) AC-type models that are CE-compliant have DIN terminals only.

• A, B port size

One-touch fitting (Metric size)

Symbol	Port size	Applicable series
C4	ø4 One-touch fitting	10-SY3000
C6	ø6 One-touch fitting	
M	Mixed	
C4	ø4 One-touch fitting	10-SY5000
C6	ø6 One-touch fitting	
C8	ø8 One-touch fitting	
M	Mixed	

One-touch fitting (Inch size)

Symbol	Port size	Applicable series
N3	ø $\frac{5}{32}$ One-touch fitting	10-SY3000
N7	ø $\frac{1}{4}$ One-touch fitting	
M	Mixed	
N3	ø $\frac{5}{32}$ One-touch fitting	10-SY5000
N7	ø $\frac{1}{4}$ One-touch fitting	
N9	ø $\frac{3}{16}$ One-touch fitting	
M	Mixed	

* For mixed specifications (M), indicate separately on the manifold specification sheet.

* Refer to pages 166 and 167 for external pilot specifications and built-in silencer.

How to Order Manifold Assembly (Example)

Example

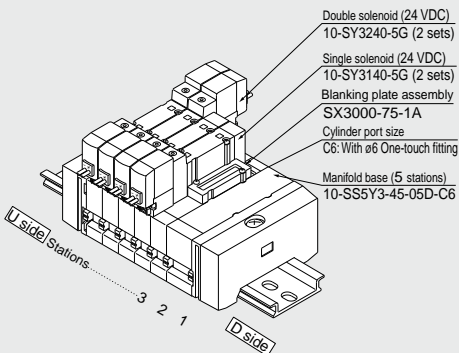

10-SSY3-45-05D-C6... 1 set (Type 45, 5-station manifold base part no.)
 * SX3000-75-1A 1 set (Blanking plate assembly part no.)
 * 10-SY3140-5G 2 sets (Single solenoid part no.)
 * 10-SY3240-5G 2 sets (Double solenoid part no.)

The asterisk denotes the symbol for assembly. Prefix it to the part no. of the solenoid valve, etc.

The valve sequence is numbered as the 1st. station from the D side regardless of the mounting position of SUP/EXH block assembly. When ordering, specify the part no. in the order from the 1st. station on D side. Also, when the sequence is complicated, fill out the manifold specification sheet to instruct us.

Air Cylinders

Rotary Actuators

Air Grippers

Air Preparation Equipment

Modular F. R.

Pressure Control Equipment

Fittings & Tubing

Flow Control Equipment

Pressure Switches/ Pressure Sensors

How to Order Valve

Note) AC-type models that are CE-compliant have DIN terminals only.

10-SY 5 2 **40** - 5 **L** - -

● **Clean series**

● **Series**

3	10-SY3000
5	10-SY5000

● **Actuation type**

1	2 position single
2	2 position double
3	3 position closed center
4	3 position exhaust center
5	3 position pressure center

● **Coil type**

Nil	Standard
T	With power saving circuit (24, 12 VDC only)

* Power saving circuit is not available for D, Y, DO, YO or W□ types.

● **Rated voltage**

For DC

5	24 VDC
6	12 VDC
V	6 VDC
S	5 VDC
R	3 VDC

AC (50/60 Hz)

1	100 VAC
2	200 VAC
3	110 VAC [115 VAC]
4	220 VAC [230 VAC]

* DC specifications of type D, Y, DO and YO are only available with 12 and 24 VDC.
 * For type W□, only DC voltage is available.
 * Only D and DO are available for 10-SY5000.
 Note) AC-type models that are CE-compliant have DIN terminals only.

● **CE-compliant**

Nil	—
Q	CE-compliant

Note) AC-type models that are CE-compliant have DIN terminals only.

● **Made to Order**

Nil	—
X90	Main valve fluororubber (Refer to page 169.)

● **Manual override**

Nil	Non-locking push type
D	Push-turn locking slotted type
E	Push-turn locking lever type

● **Light/Surge voltage suppressor**

Electrical entry for G, H, L, M, W

Nil	Without light/surge voltage suppressor
S	With surge voltage suppressor
Z	With indicator light and surge voltage suppressor
R	With surge voltage suppressor (Non-polar type)
U	With light/surge voltage suppressor (Non-polar type)

* For AC voltage valves there is no "S" option. It is already built into the rectifier circuit.
 * For "R" and "U", only DC voltage is available.
 * Power saving circuit is only available for the "Z" type.

Electrical entry for D, Y

Nil	Without light/surge voltage suppressor
S	With surge voltage suppressor (Non-polar type)
Z	With light/surge voltage suppressor (Non-polar type)

* DOZ and YOZ are not available.
 * For AC voltage valves there is no "S" option. It is already built into the rectifier circuit.

● **Electrical entry**

24, 12, 6, 5, 3 VDC/100, 110, 200, 220 VAC				24, 12 VDC 100, 110, 200, 220 VAC	24, 12 VDC 6, 5, 3 VDC
Grommet	L plug connector	M plug connector	DIN terminal	M8 connector	
G: Lead wire length 300 mm	L: With lead wire (Length 300 mm)	M: With lead wire (Length 300 mm)	(10-SY5000 only) D: With connector	WO: Without connector cable	
H: Lead wire length 600 mm	LN: Without lead wire	MN: Without lead wire	DO: Without connector	W□: With connector cable ^{Note 2)}	
	LO: Without connector	MO: Without connector	Y: With connector		
			YO: Without connector		
			— Note 1)		
Manifold mounting	10-SY3000	●	●	●	
	10-SY5000	●	●	●	
CE-compliant	DC	●	●	●	
	AC	—	●	—	

Note 1) The DIN terminal of the 10-SY3000 series cannot be mounted on a standard manifold. For details, refer to page 174.

Note 2) Enter the cable length symbols in □. Please be sure to fill in the blank referring to page 176.

* LN, MN type: With 2 sockets.

* "Y" type is a DIN terminal conforming to EN-175301-803C (former DIN43650C).

Refer to page 173 for details.

* Refer to page 176 for connector cable of M8 connector.

* M8 connector conforming to IEC60947-5-2 standard is also available. Refer to page 168 for details.

* Refer to page 173 for the lead wire length of L and M plug connectors.

* Refer to page 174 for the connector assembly with cover for L and M plug connectors.

* When ordering a single unit of the base mounted type solenoid valve, the mounting screws and gasket for the integrated manifold are supplied with the solenoid valve, but the stacking type gasket is not included. When the stacking type gasket is required, order it separately.



Manifold Specifications

Model	10-SS5Y3-45(-Q)		10-SS5Y5-45(-Q)	
Applicable valve	10-SY3□40		10-SY5□40	
Manifold type	Stacking type/DIN rail mounted			
P (SUP)/R (EXH)	Common SUP, Common EXH			
Valve stations	2 to 20 stations <small>Note 1)</small>			
A, B port Porting specifications	Location	Base		
	Direction	Side		
Port size	P, R port	C8 (ø8 One-touch fitting)	C10 (ø10 One-touch fitting)	
	A, B port	C4 (ø4 One-touch fitting)	C4 (ø4 One-touch fitting)	
		C6 (ø6 One-touch fitting)	C6 (ø6 One-touch fitting) C8 (ø8 One-touch fitting)	
Manifold base weight W (g), n: Stations	2 to 10 stations: W = 22n + 118 11 to 20 stations: W = 22n + 140		2 to 10 stations: W = 47n + 156 11 to 20 stations: W = 47n + 190	

Note 1) For more than 11 stations, supply pressure to P port on both sides and exhaust from R port on both sides.

Flow Rate Characteristics

Model	Port size		Flow rate characteristics					
	1, 5, 3 (P, EA, EB)	4, 2 (A, B)	1 → 4/2 (P → A/B)			4/2 → 5/3 (A/B → EA/EB)		
			C (dm ³ /sbar)	b	Cv	C (dm ³ /sbar)	b	Cv
10-SS5Y3-45	C8	C6	0.88	0.21	0.22	0.95	0.18	0.22
10-SS5Y5-45	C10	C8	2.2	0.24	0.53	2.5	0.18	0.58

Note) The values are for individually operated 2 position type manifold bases with 5 stations.

Directional Control Valves

Air Cylinders

Rotary Actuators

Air Grippers

Air Preparation Equipment

Modular F. R.

Pressure Control Equipment

Fittings & Tubing

Flow Control Equipment

Pressure Switches/ Pressure Sensors

Dimensions: Series 10-SY3000

[]: AC

**10-SS5Y3-45- Stations D-C4, N3
C6, N7**

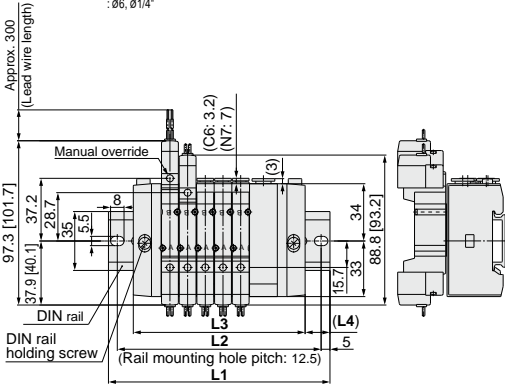
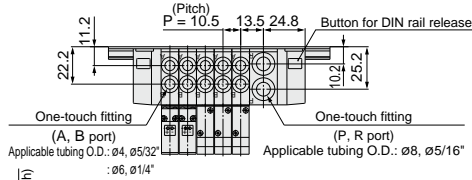

(Station n) - (Station 1)

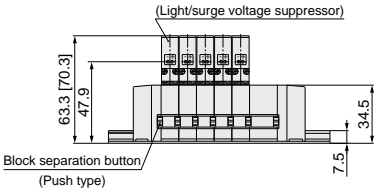

**10-SS5Y3-45- Stations U-C4, N3
C6, N7**

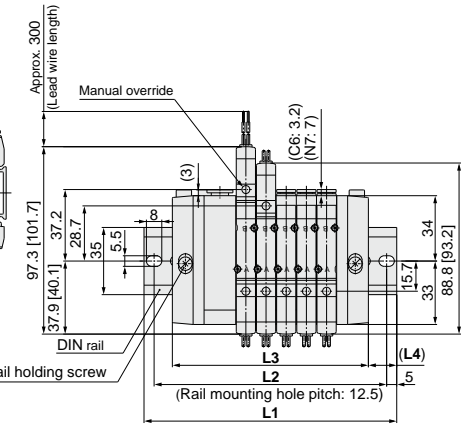
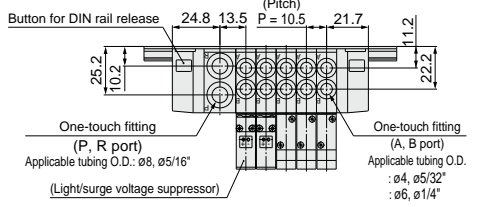

Stations	2 stations	3	4	5	6	7	8	9	10 stations
L1	98	110.5	123	135.5	148	148	160.5	173	185.5
L2	87.5	100	112.5	125	137.5	137.5	150	162.5	175
L3	70.5	81	91.5	102	112.5	123	133.5	144	154.5
L4	13.5	14.5	15.5	16.5	17.5	12.5	13.5	14.5	15.5

Dimensions: Series 10-SY3000

[] : AC

**10-SS5Y3-45- Stations B-C4, N3
C6, N7**

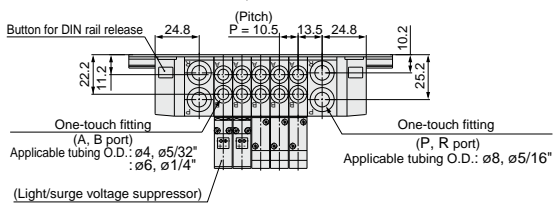

L plug connector

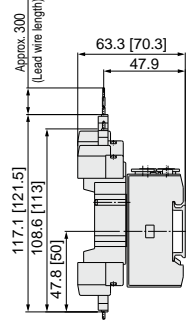

M plug connector

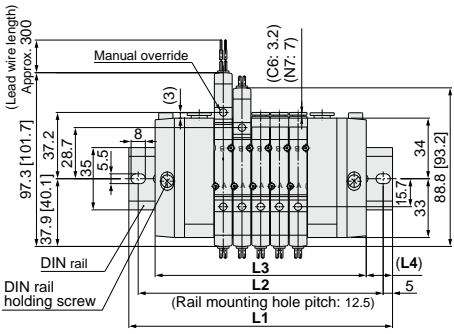
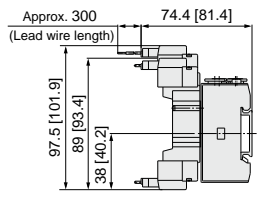

Stations	2 stations	3	4	5	6	7	8	9	10 stations
L1	110.5	123	135.5	148	160.5	173	185.5	185.5	198
L2	100	112.5	125	137.5	150	162.5	175	175	187.5
L3	87	97.5	108	118.5	129	139.5	150	160.5	171
L4	11.5	12.5	13.5	14.5	15.5	16.5	17.5	12.5	13.5

Stations	11 stations	12	13	14	15	16	17	18	19	20 stations
L1	210.5	223	235.5	248	248	260.5	273	285.5	298	310.5
L2	200	212.5	225	237.5	237.5	250	262.5	275	287.5	300
L3	181.5	192	202.5	213	223.5	234	244.5	255	265.5	276
L4	14.5	15.5	16.5	17.5	12	13	14	15	16	17

M8 connector (WO)

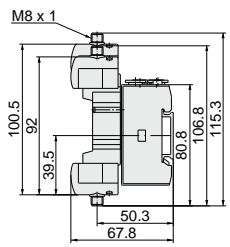

Note) Refer to page 176 for dimensions of connector types.

- Directional Control Valves
- Air Cylinders
- Rotary Actuators
- Air Grippers
- Air Preparation Equipment
- Modular F. R.
- Pressure Control Equipment
- Fittings & Tubing
- Flow Control Equipment
- Pressure Switches/ Pressure Sensors

Dimensions: Series 10-SY5000

[]: AC

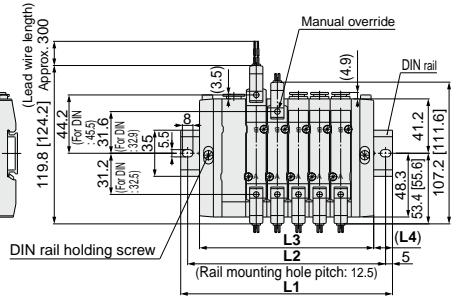
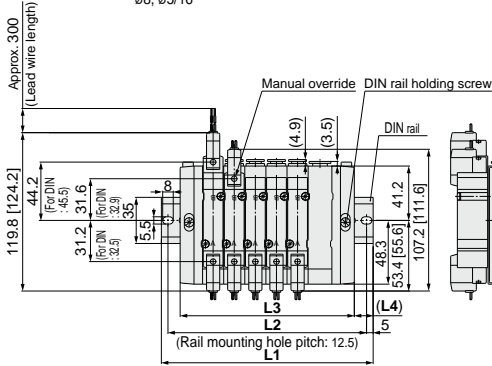
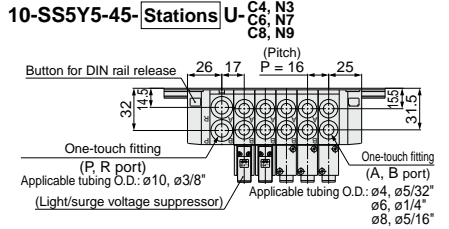
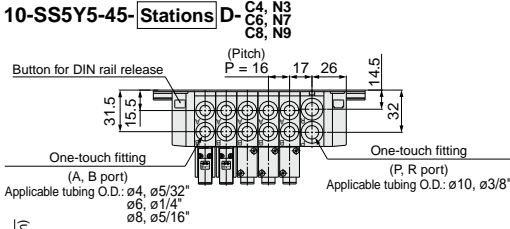

(Station n) -- (Station 1)

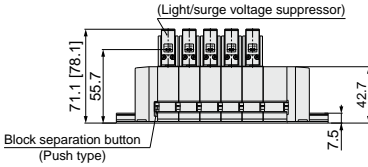

Stations	2 stations	3	4	5	6	7	8	9	10 stations
L1	110.5	135.5	148	160.5	173	198	210.5	223	235.5
L2	100	125	137.5	150	162.5	187.5	200	212.5	225
L3	84	100	116	132	148	164	180	196	212
L4	13	17.5	16	14	12.5	17	15	13.5	11.5

Dimensions: Series 10-SY5000

[]: AC

**10-SS5Y5-45- Stations B-C4, N3
C6, N7
C8, N9**

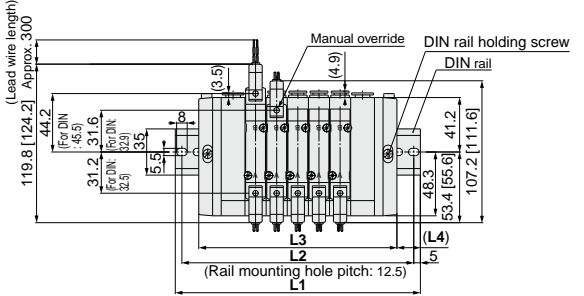
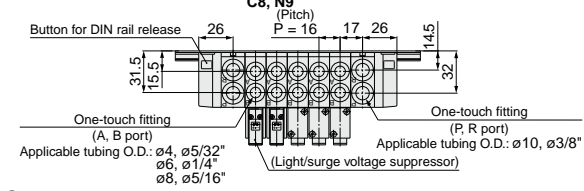

Stations	2 stations	3	4	5	6	7	8	9	10 stations
L1	135.5	148	160.5	185.5	198	210.5	223	248	260.5
L2	125	137.5	150	175	187.5	200	212.5	237.5	250
L3	102	118	134	150	166	182	198	214	230
L4	16.5	15	13	17.5	16	14	12.5	17	15

Stations	11 stations	12	13	14	15	16	17	18	19	20 stations
L1	273	285.5	310.5	323	335.5	360.5	373	385.5	398	423
L2	262.5	275	300	312.5	325	350	362.5	375	387.5	412.5
L3	246	262	278	294	310	326	342	358	374	390
L4	13.5	11.5	16	14.5	12.5	17	15.5	13.5	12	16.5

M8 connector (WO)

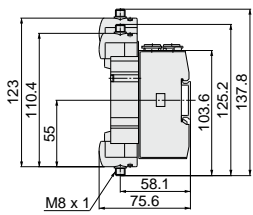

Note) Refer to page 176 for dimensions of connector types.

L plug connector

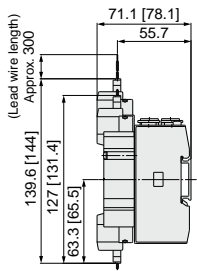

M plug connector

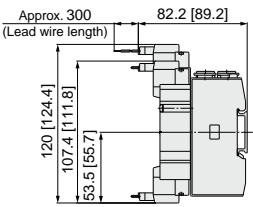

DIN terminal (D, Y)

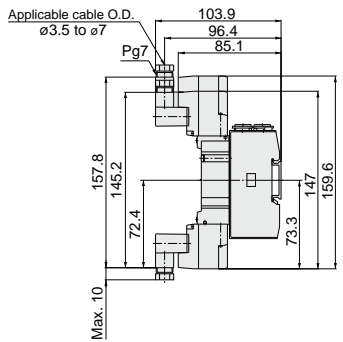

Directional Control Valves

Air Cylinders

Rotary Actuators

Air Grippers

Air Preparation Equipment

Modular F. R.

Pressure Control Equipment

Fittings & Tubing

Flow Control Equipment

Pressure Switches/ Pressure Sensors



How to Order Manifold

10-SS5Y **3** -45- **A** **U** -05 **D** - **C6** - -

• Clean series

Series

3	10-SY3000
5	10-SY5000

Specifications

Symbol	Specifications
A	With connector box (+COM spec.)
NA	With connector box (-COM spec.)

* The style of attached lead wire assembly is different.

Connector box mounting position

Symbol	Mounting position
U	U side
D	D side

Valve stations

Symbol	Stations	Note
02	2 stations	Applicable up to 16 solenoid valves.
⋮	⋮	
16	16 stations	

SUP/EXH block assembly mounting position

Symbol	Mounting position	Applicable stations
U	U side	2 to 10 stations
D	D side	
B	Both sides	2 to 16 stations
M*	Special specifications	

* For special specifications, indicate separately with the manifold specification sheet.

Option

When a longer DIN rail is desired than the specified stations, specify the station number to be required. (Max. 20 stations)

A/B port size

One-touch fitting (Metric size)

Symbol	Port size	Applicable series
C4	ø4 One-touch fitting	
C6	ø6 One-touch fitting	10-SY3000
M	Mixed	
C4	ø4 One-touch fitting	
C6	ø6 One-touch fitting	10-SY5000
C8	ø8 One-touch fitting	
M	Mixed	

One-touch fitting (Inch size)

Symbol	Port size	Applicable series
N3	ø ⁹ / ₃₂ " One-touch fitting	
N7	ø ¹ / ₄ " One-touch fitting	10-SY3000
M	Mixed	
N3	ø ⁹ / ₃₂ " One-touch fitting	
N7	ø ¹ / ₄ " One-touch fitting	10-SY5000
N9	ø ⁹ / ₁₆ " One-touch fitting	
M	Mixed	

* For mixed specifications, indicate separately on the manifold specification sheet.

CE-compliant

NII	—
Q	CE-compliant

* Refer to pages 166 to 167 for external pilot specifications and built-in silencer.

How to Order Manifold Assembly (Example)

Example (10-SY3000, +COM, U side)

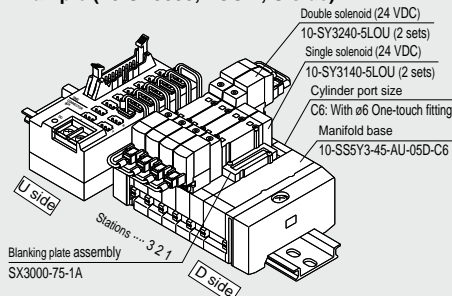

- 10-SS5Y3-45-AU-05D-C6... 1 set (Type 45, 5-station manifold base part no.)
 - *SX3000-75-1A 1 set (Blanking plate assembly part no.)
 - *10-SY3140-5LOU 2 sets (Single solenoid part no.)
 - *10-SY3240-5LOU 2 sets (Double solenoid part no.)
- The asterisk denotes the symbol for assembly. Prefix it to the part no. of the solenoid valve, etc.

The valve sequence is numbered as the 1st station from the D side regardless of the mounting position of connector box. When ordering, specify the part no. in the order from the 1st station on D side. Also, when the sequence is complicated, fill out the manifold specification sheet to instruct us.

10-SS5Y3-45-AU-□□□□□□ is assembled with solenoid valve and lead wire assembly when shipping. When ordering manifold only (without valves/wires/options), refer to how to order on page 150 and list the connector box (VZ3000-106-1A) and the rail stopper (TXE1-SMC) below the manifold to allow for connector box mounting at the U side. (Be sure to order a DIN rail 3 station longer than the number of the manifold stations.) In this case, please note that dimensions, L1 and L2 on pages 160 and 161 may vary slightly.) For other components, refer to the SY series of the WEB catalog.

How to Order Valve

10-SY **5** **2** 40-5 LOU - - -

• Clean series

• Rated voltage
5 24 VDC

Series

3	10-SY3000
5	10-SY5000

• Actuation type

1	2 position single
2	2 position double
3	3 position closed center
4	3 position exhaust center
5	3 position pressure center

Manual override

NII	Non-locking push type
D	Push-turn locking slotted type
E	Push-turn locking lever type

Made to Order

NII	—
X90	Main valve fluororubber (Refer to page 169.)

CE-compliant

NII	—
Q	CE-compliant

* When ordering a single unit of the base mounted type solenoid valve, the mounting screws and gasket for the integrated manifold are supplied with the solenoid valve, but the stacking type gasket is not included. When the stacking type gasket is required, order it separately.



Manifold Specifications

Model	10-SS5Y3-45-NA-(Q)		10-SS5Y5-45-NA-(Q)	
Applicable valve	10-SY3□40		10-SY5□40	
Manifold type	Stacking type/DIN rail mounted			
P (SUP)/R (EXH)	Common SUP, Common EXH			
Valve stations	2 to 16 stations ^{Note 1, 2)}			
A, B port Porting specifications	Base			
	Side			
Port size	P, R port	C8 (ø8 One-touch fitting)	C10 (ø10 One-touch fitting)	
	A, B port	C4 (ø4 One-touch fitting) C6 (ø6 One-touch fitting)	C4 (ø4 One-touch fitting) C6 (ø6 One-touch fitting) C8 (ø8 One-touch fitting)	
Manifold base weight W (g) n: Stations	2 to 10 stations: W = 26n + 207 11 to 20 stations: W = 26n + 229		2 to 10 stations: W = 52n + 245 11 to 16 stations: W = 52n + 279	
Applicable flat ribbon cable connector	Flat ribbon cable connector, Socket: 20 pin MIL type with strain relief conforming to MIL-C-83503			
Wiring specifications	+COM specifications (Type 45-A), -COM specifications (Type 45-NA)			

Note 1) For more than 11 stations, supply pressure to P port on both sides and exhaust from R port on both sides.

Note 2) There is a limit depending on the number of solenoids. Refer to "How to Order".

Flow Rate Characteristics

Model	Port size		Flow rate characteristics					
	1, 5, 3 (P, EA, EB)	4, 2 (A, B)	1 → 4/2 (P → A/B)			4/2 → 5/3 (A/B → EA/EB)		
			C (dm³/sbar)	b	Cv	C (dm³/sbar)	b	Cv
10-SS5Y3-45-□	C8	C6	0.88	0.21	0.22	0.95	0.18	0.22
10-SS5Y5-45-□	C10	C8	2.2	0.24	0.53	2.5	0.18	0.58

Note) The values are for individually operated 2 position type manifold bases with 5 stations.

Manifold Wiring Diagram (Circuit diagram for the reference layout)

+COM electric circuit diagram

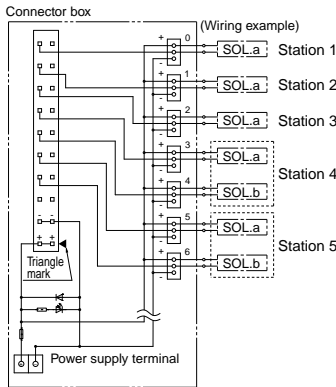

-COM electric circuit diagram

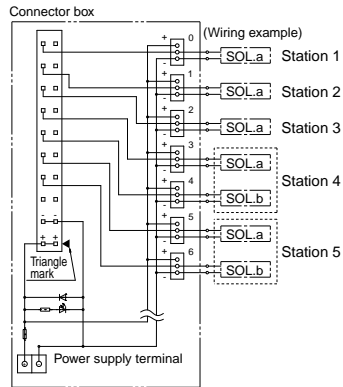

Reference layout

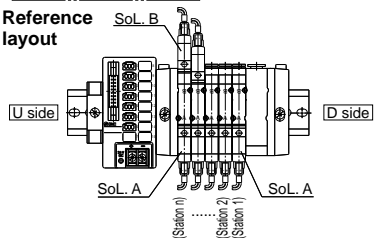

- The connector box for +COM allows transmission to G71-OD16, manufactured by OMRON Corp., to be connected directly for serial transmission. Additionally, it can also be used for the PC wiring system.
- When an external power source must be supplied to the manifold, correct polarity must be observed, otherwise damage to the PLC is possible.
- The wiring of solenoid valves, corresponds with the labeled connector box 0 to 15 from the D side.
- If valves other than the non-polar type are used, this may cause malfunction.

Directional Control Valves
 Air Cylinders
 Rotary Actuators
 Air Grippers
 Air Preparation Equipment
 Modular F. R.
 Pressure Control Equipment
 Fittings & Tubing
 Flow Control Equipment
 Pressure Switches/ Pressure Sensors

Dimensions: Series 10-SY3000

10-SS5Y3-45-AU-Stations D-C₄, N₃
C₆, N₇

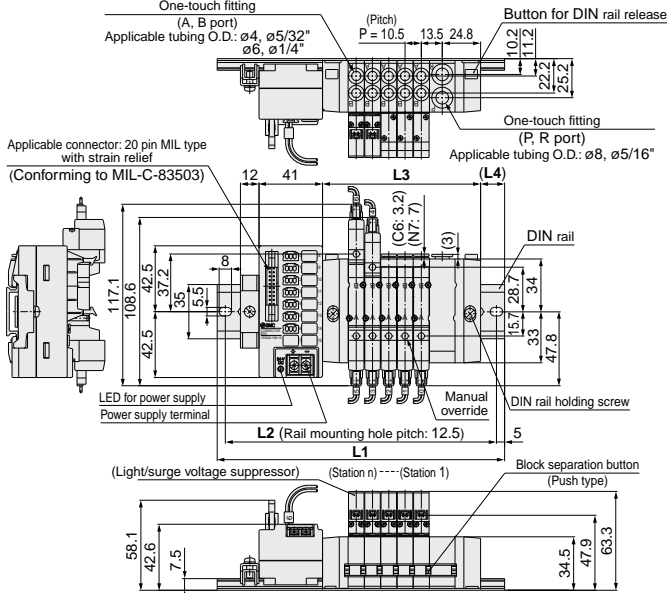

10-SS5Y3-45-AD-Stations U-C₄, N₃
C₆, N₇

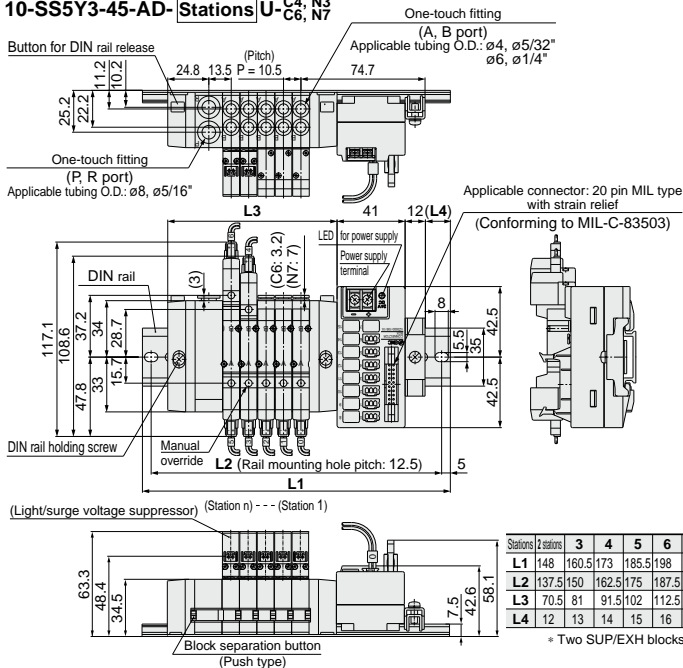

Stations	2 stations	3	4	5	6	7	8	9	10	11	12	13	14	15	16 stations
L1	148	160.5	173	185.5	198	210.5	210.5	223	235.5	260.5	273	285.5	298	310.5	310.5
L2	137.5	150	162.5	175	187.5	200	200	212.5	225	250	262.5	275	287.5	300	300
L3	70.5	81	91.5	102	112.5	123	133.5	144	154.5	181.5	192	202.5	213	223.5	234
L4	12	13	14	15	16	17	12	13	14	13	14	15	16	17	11.5

* Two SUP/EXH blocks are provided for models with 11 stations or more.

Directional Control Valves
Air Cylinders
Rotary Actuators
Air Grippers
Air Preparation Equipment
Modular F. R.
Pressure Control Equipment
Fittings & Tubing
Flow Control Equipment
Pressure Switches
Pressure Sensors

Dimensions: Series 10-SY5000

**10-SS5Y5-45-AU- Stations D- C4, N3
C6, N7
C8, N9**

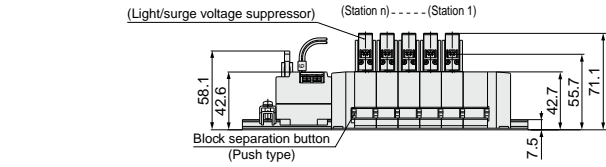
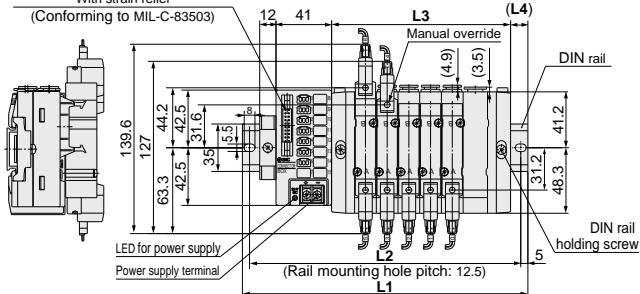
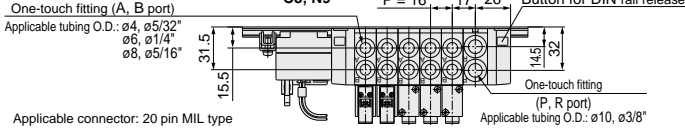

**10-SS5Y5-45-AD- Stations U- C4, N3
C6, N7
C8, N9**

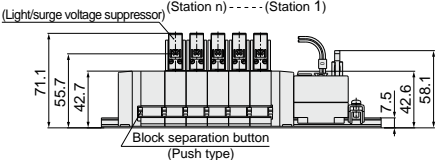
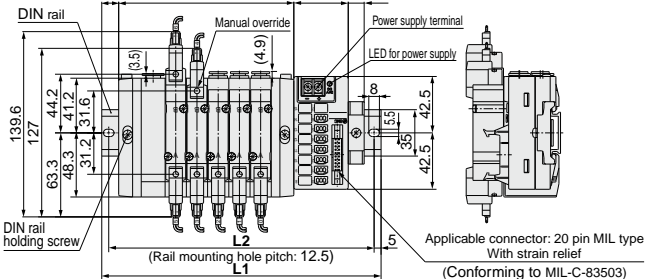
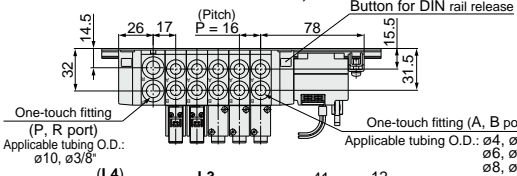

Stations (2 stations)	3	4	5	6	7	8	9	10	11	12	13	14	15	16 stations	
L1	160.5	185.5	198	210.5	235.5	248	260.5	273	298	323	348	360.5	373	398	410.5
L2	150	175	187.5	200	225	237.5	250	262.5	287.5	312.5	337.5	350	362.5	387.5	400
L3	84	100	116	132	148	164	180	196	212	246	262	278	294	310	326
L4	11.5	16	14.5	12.5	17	15.5	13.5	12	16.5	12	16.5	14.5	13	17.5	15.5

* Two SUP/EXH blocks are provided for models with 11 stations or more.

Series 10-SY300/500 3 Port Valve

Mixed Mounting Type on 5 Port Valve Manifold



3 port valve can be mounted on manifold for 5 port valve.

Single Unit

Brackets and sub-plates are the same as the 10-SY3000/5000 series.

Applications

Mounting on all kinds of manifolds for the 10-SY3000/5000 series. Refer to "How to Order Manifold" for details.

How to Order Manifold Assembly (Example)

Example

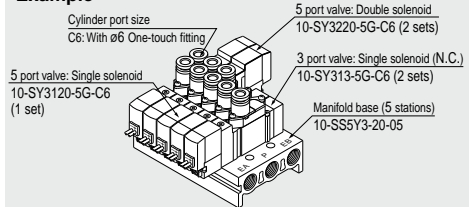

- 10-SS5Y3-20-05 1 set (Type 20, 5-station manifold base part no.)
- * 10-SY313-5G-C6 2 sets (3 port valve, type NC part no.)
- * 10-SY3120-5G-C6 ... 1 set (5 port valve, single solenoid part no.)
- * 10-SY3220-5G-C6 ... 2 sets (5 port valve, double solenoid part no.)

The asterisk denotes the symbol for assembly. Prefix it to the part no. of the solenoid valve, etc.

Add the valve and option part number under the manifold base part number. For complex arrangements, specify them on the manifold specification sheet.

Specifications

Dimensions, specifications, solenoid specifications, response time and effective area are the same as the 5 port valve.

Directional Control Valves

Air Cylinders

Rotary Actuators

Air Grippers

Air Preparation Equipment

Modular F. R.

Pressure Control Equipment

Fittings & Tubing

Flow Control Equipment

Pressure Switches/ Pressure Sensors



Body Ported/How to Order Valve

(Note) AC-type models that are CE-compliant have DIN terminals only. [Option]

For single and individual wiring: For 10-SS5Y₃-20

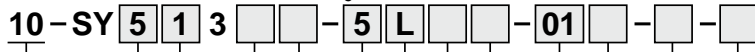

Clean series

Series

3	10-SY300
5	10-SY500

Actuation type

1	Normally closed (N.C.)
2	Normally open (N.O.)

Solenoid type

Nil	Single solenoid
D	Double solenoid

Coil type

Nil	Standard
T	With power saving circuit (24 VDC, 12 VDC only)

* Power saving circuit is not available for D, Y, DO, YO or W□ types.

Rated voltage

For DC		For AC	
5	24 VDC	1	100 VAC
6	12 VDC	2	200 VAC
V	6 VDC	3	110 VAC [115 VAC]
S	5 VDC	4	220 VAC [230 VAC]
R	3 VDC		

* DC specifications of Type D, Y, DO and YO are only available with 12 and 24 VDC.
 * For type W□, only DC voltage is available.
 (Note) AC-type models that are CE-compliant have DIN terminals only.

Electrical entry

24, 12, 6, 5, 3 VDC 100, 110, 200, 220 VAC			24, 12 VDC 100, 110, 200, 220 VAC	24, 12 VDC 6, 5, 3 VDC
Grommet	L plug connector	M plug connector	DIN terminal	M8 connector
G: Lead wire length 300 mm	L: With lead wire (Length 300 mm)	M: With lead wire (Length 300 mm)	(10-SY500 only) D: With connector	WO: Without connector cable
H: Lead wire length 600 mm	LN: Without lead wire	MN: Without lead wire	DO: Without connector	W□: With connector cable (Note)
	LO: Without connector	MO: Without connector	Y: With connector	
			YO: Without connector	
CE-compliant	DC	AC		

- * LN, MN type: With 2 sockets.
 - * Refer to page 174 for DIN terminal type of the 10-SY3000 series.
 - * "Y" type is a DIN terminal conforming to EN-175301-803C (former DIN43650C). For details, refer to page 173.
 - * For connector cable of M8 connector, refer to page 176.
 - * M8 connector conforming to IEC60947-5-2 standard is also available. Refer to page 168 for details.
 - * Refer to page 173 for the lead wire length of L and M plug connectors.
 - * Refer to page 174 for the connector assembly with cover for L and M plug connectors.
- (Note) Enter the cable length symbols in □. Please be sure to fill in the blank referring to page 176.

CE-compliant

Nil	—
Q	CE-compliant

(Note) AC-type models that are CE-compliant have DIN terminals only.

Thread type

Nil	Rc
F	G
N	NPT
T	NPTF

* Except for M5

Bracket (For single unit)

Nil	Without bracket
F1	With foot bracket (Single solenoid type only)
F2	With side bracket

* Brackets are the same as the 10-SY3000/5000 series.
 * For bracket pin number, refer to the SY series of the WEB catalog.

A port size

Thread piping

Symbol	Port size	Applicable series
M5	M5 x 0.8	10-SY300
01	1/8"	10-SY500

One-touch fitting (Metric size)

Symbol	Port size	Applicable series
C4	ø4 One-touch fitting	10-SY300
C6	ø6 One-touch fitting	10-SY300
C4	ø4 One-touch fitting	10-SY500
C6	ø6 One-touch fitting	10-SY500
C8	ø8 One-touch fitting	10-SY500

One-touch fitting (Inch size)

Symbol	Port size	Applicable series
N3	ø3/8" One-touch fitting	10-SY300
N7	ø7/16" One-touch fitting	10-SY300
N3	ø3/8" One-touch fitting	10-SY500
N7	ø7/16" One-touch fitting	10-SY500
N9	ø9/16" One-touch fitting	10-SY500

Manual override

Nil	Non-locking push type
D	Push-turn locking slotted type
E	Push-turn locking lever type

Light/Surge voltage suppressor

Electrical entry for G, H, L, M, W		Electrical entry for D, Y (10-SY500 only)	
Nil	Without light/surge voltage suppressor	Nil	Without light/surge voltage suppressor
S	With surge voltage suppressor	S	With surge voltage suppressor
Z	With light/surge voltage suppressor	Z	With light/surge voltage suppressor
R	With surge voltage suppressor (Non-polar type)		
U	With light/surge voltage suppressor (Non-polar type)		

* For AC voltage valves there is no "S" option. It is already built into the rectifier circuit.
 * For "R" and "U", only DC voltage is available.
 * Power saving circuit is only available for the "Z" type.

(Note) When placing an order for body ported solenoid valves as a single unit, the mounting screws for the manifold and gasket are not attached. Order them separately, if necessary.

Gasket assembly part no.

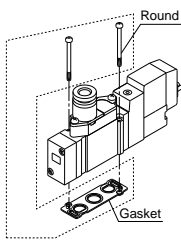

Series	Gasket assembly part no.
10-SY300	SY3000-GS-1
10-SY500	SY5000-GS-1

(Note) The gasket assembly consists of 10 sets of mounting screws and a gasket.





Base Mounted/How to Order Valve

Note) CE-compliant:
For DC only.

[Option]

Flat ribbon cable:
Connector box type: For 10-SS5Y³-41P/42P/45-A

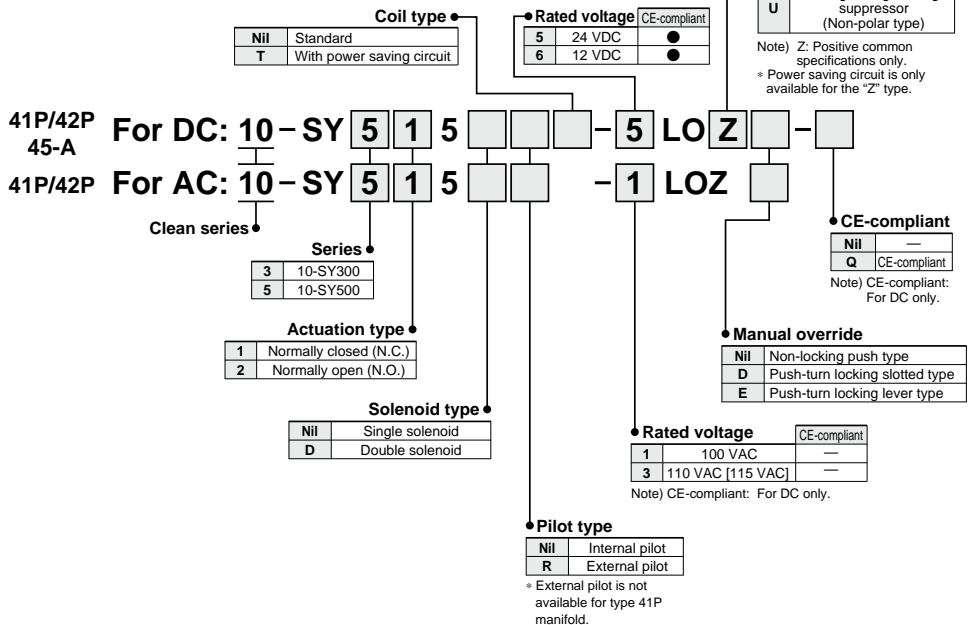

Plug-in: For 10-SS5Y³-45□

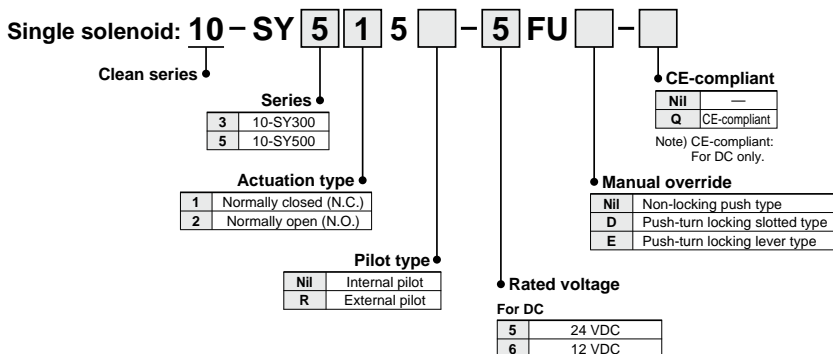

10-SY3000/5000

Made to Order

External Pilot/Built-in Silencer

External pilot manifold bases for low-pressure/vacuum use are added to split style/
DIN rail manifolds.



[Option]
Note) AC-type models that are CE-compliant have DIN terminals only.

Type 45

Individual Wiring/Connector Box Type

How to Order Manifold

Type 45

10-SS5Y3-45-(A)-05UR-C6

Clean series

Series

3	10-SY3000
5	10-SY5000

Valve stations

Symbol	Stations
02	2 stations
⋮	⋮
20	20 stations

* Includes the number of blanking plate assemblies.

SUP/EXH block assembly mounting position

Symbol	Mounting position	Stations
U	U side	2 to 10 stations
D	D side	
B	Both sides	2 to 20 stations
M	Special specifications	

* For special specifications, indicate separately with the manifold specification sheet.

SUP/EXH block assembly

Symbol	Specifications
R	External pilot

A, B port size

One-touch fitting (Metric size)

Symbol	Port size	Applicable series
C4	ø4 One-touch fitting	10-SY3000
C6	ø6 One-touch fitting	
M	Mixed	
C4	ø4 One-touch fitting	10-SY5000
C6	ø6 One-touch fitting	
C8	ø8 One-touch fitting	
M	Mixed	

One-touch fitting (Inch size)

Symbol	Port size	Applicable series
N3	ø5/16" One-touch fitting	10-SY3000
N7	ø1/4" One-touch fitting	
M	Mixed	
N3	ø5/16" One-touch fitting	10-SY5000
N7	ø1/4" One-touch fitting	
N9	ø3/16" One-touch fitting	
M	Mixed	

* For mixed specifications, indicate separately on the manifold specification sheet.

Option

When a longer DIN rail is desired than the specified stations, specify the station number to be required. (Max. 20 stations)

CE-compliant

NH	—
Q	CE-compliant

Note) AC-type models that are CE-compliant have DIN terminals only.

How to Order Manifold Assembly (Example)

Example

Single solenoid (external pilot specifications)
10-SY3140R-5G (5 sets)

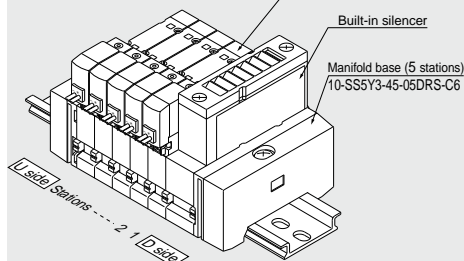

10-SS5Y3-45-05DRS-C6 ... 1 set (External pilot specification with built-in silencer part no.)
* 10-SY3140R-5G 5 sets (Single solenoid part no.)

* The asterisk denotes the symbol for assembly. Prefix it to the part no. of the solenoid valve, etc.

The valve sequence is numbered as the 1st. station from the D side regardless of the mounting position of SUP/EXH block assembly. When ordering, specify the part no. in the order from the 1st. station on D side. Also, when the sequence is complicated, fill out the manifold specification sheet to instruct us.

For manifolds with SUP/EXH block assembly at each end of the manifold, external pilot ports and silencers will be also located at each end of the manifold. For special specifications, the SUP/EXH block assembly (SX3/5000-51-1A) shown in the WEB catalog of the SY series (Type 45 DIN Rail Manifold Exploded View) can also be mounted. Please specify the mounting position, by correctly filling in the blank space on the manifold specification sheet.

Directional Control Valves

Air Cylinders

Rotary Actuators

Air Grippers

Air Preparation Equipment

Modular F. R.

Pressure Control Equipment

Fittings & Tubing

Flow Control Equipment

Pressure Switches/Pressure Sensors

How to Order Valve

Note) AC-type models that are CE-compliant have DIN terminals only.

10-SY 5 2 40 - **5 L** - -

• **Clean series**

• **Series**

3	10-SY3000
5	10-SY5000

• **Actuation type**

1	2 position single
2	2 position double
3	3 position closed center
4	3 position exhaust center
5	3 position pressure center

• **Pilot type**

Nil	Internal pilot
R	External pilot

• **Coil type**

Nil	Standard
T	With power saving circuit (24 VDC, 12 VDC only)

* Power saving circuit is not available for D, Y, DO, YO or W□ types.

• **Rated voltage**

For DC

5	24 VDC
6	12 VDC
V	6 VDC
S	5 VDC
R	3 VDC

For AC (% Hz)

1	100 VAC
2	200 VAC
3	110 VAC [115 VAC]
4	220 VAC [230 VAC]

* DC specifications of type D, Y, DO and YO are only available with 12 and 24 VDC.
 * For type W□, only DC voltage is available.
 * Only D, Y, DO and YO are available for 10-SY5000.
 Note) AC-type models that are CE-compliant have DIN terminals only.

• **CE-compliant**

Nil	—
Q	CE-compliant

Note) AC-type models that are CE-compliant have DIN terminals only.

• **Made to Order**

Nil	—
X90	Main valve fluororubber (Refer to page 169.)

• **Manual override**

Nil	Non-locking push type
D	Push-turn locking slotted type
E	Push-turn locking lever type

• **Light/Surge voltage suppressor**

Electrical entry for G, H, L, M, W

Nil	Without light/surge voltage suppressor
S	With surge voltage suppressor
Z	With light/surge voltage suppressor
R	With surge voltage suppressor (Non-polar type)
U	With light/surge voltage suppressor (Non-polar type)

* For AC voltage valves there is no "S" option. It is already built into the rectifier circuit.
 * For "R" and "U", only DC voltage is available.
 * Power saving circuit is only available for the "Z" type.

Electrical entry for D, Y (10-SY5000 only)

Nil	Without light/surge voltage suppressor
S	With surge voltage suppressor (Non-polar type)
Z	With light/surge voltage suppressor (Non-polar type)

* DOZ and YOZ are not available.
 * For AC voltage valves there is no "S" option. It is already built into the rectifier circuit.

• **Electrical entry**

		24, 12, 6, 5, 3 VDC 100, 110, 200, 220 VAC			24, 12 VDC 100, 110, 200, 220 VAC	24, 12 VDC 6, 5, 3 VDC
		Grommet	L plug connector	M plug connector	DIN terminal (10-SY5000 only)	M8 connector
CE-compliant	DC	●	●	●	●	●
	AC	—	—	—	●	—
		G: Lead wire length 300 mm	L: With lead wire (Length 300 mm) LN: Without lead wire LO: Without connector	M: With lead wire (Length 300 mm) MN: Without lead wire MO: Without connector	D: With connector DO: Without connector Y: With connector YO: Without connector	WO: Without connector cable W□: With connector cable ^{Note6)}

* LN, MN type: With 2 sockets.
 * Only D, Y, DO and YO are available for 10-SY5000.
 * "Y" type is a DIN terminal conforming to EN-175301-803C (former DIN43650C). Refer to page 173 for details.
 * Setting "SLOU" is available only for connector box type.
 * Refer to page 176 for connector cable of M8 connector.
 * M8 connector conforming to IEC60947-5-2 standard is also available. Refer to page 168 for details.
 * Refer to page 173 for the lead wire length of L and M plug connectors.
 * Refer to page 174 for the connector assembly with cover for L and M plug connectors.
 Note) Enter the cable length symbols in □. Please be sure to fill in the blank referring to page 176.

* When ordering a single unit of the base mounted type solenoid valve, the mounting screws and gasket for the integrated manifold are supplied with the solenoid valve, but the stacking type gasket is not included. When the stacking type gasket is required, order it separately.

[Series 10-SY3000/5000/7000/9000/10-SY300/500] Made to Order M8 Connector Conforming to IEC60947-5-2



How to Order Valve

* For details on specifications, refer to page 172.

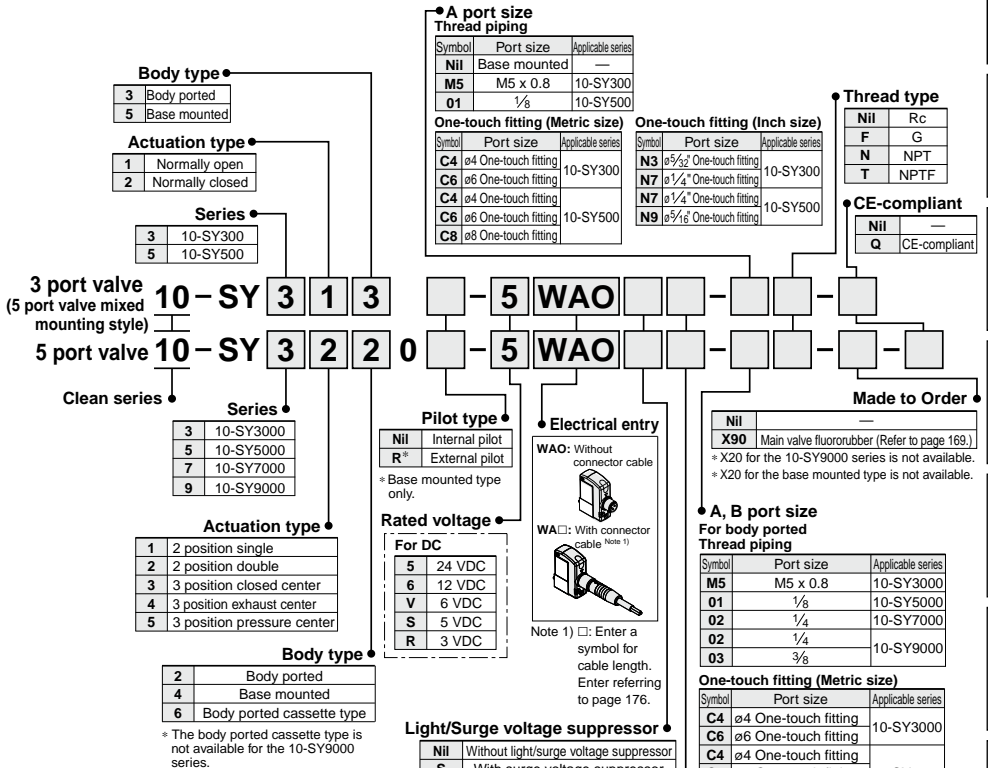

Note) When placing an order for body ported solenoid valves as a single unit, the mounting screws for the manifold and gasket are not attached. Order them separately, if necessary.

How to Order Pilot Valve

V111- 5 WAO □

Rated voltage

For DC

5	24 VDC
6	12 VDC
V	6 VDC
S	5 VDC
R	3 VDC

Light/Surge voltage suppressor

Nil	Without light/surge voltage suppressor
S	With surge voltage suppressor
Z	With indicator light and surge voltage suppressor
R	With surge voltage suppressor (Non-polar type)
U	With light/surge voltage suppressor (Non-polar type)

Electrical entry

WAO	M8	Without connector cable
WA□	connector	With connector cable (Note 1)

Note 1) □: Enter a symbol for cable length. Enter referring to page 176.

* Since V111 is CE-compliant as standard, the suffix "-Q" is not necessary.



Directional Control Valves
Air Cylinders
Rotary Actuators
Air Grippers
Air Preparation Equipment
Modular F. R.
Pressure Control Equipment
Fittings & Tubing
Flow Control Equipment
Pressure Switches/Pressure Sensors

Series 10-SY3000/5000/7000/9000

Made to Order



Body Ported External Pilot/Fluororubber for Main Valve

Main Valve Fluororubber Specifications

Fluororubber is used for rubber parts of the main valve to allow use in applications such as the following.

- When using a lubricant other than the recommended turbine oil, and there is a possibility of malfunction due to swelling of the spool valve seals.

Applicable solenoid valves: Series 10-SY3□₄₀², 10-SY5□₄₀², 10-SY7□₄₀², 10-SY9□₄₀²

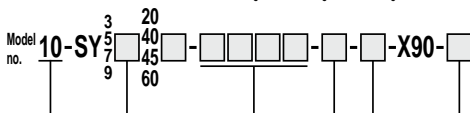

• Entry is the same as standard products.
Specifications and performance are the same as standard products.

• Clean series

• CE-compliant •

NII	—
Q	CE-compliant

Note) AC-type models that are CE-compliant have DIN terminals only.



Series 10-SY Specific Product Precautions 1

Be sure to read this before handling.
Refer to page 1382 for Safety Instructions and pages 677 to 683 for 3/4/5 Port Solenoid Valve Precautions.

Manual Override Operation

Warning

■ Non-locking push type [Standard]

Press in the direction of the arrow.

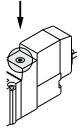

■ Push-turn locking slotted type [Type D]

While pressing the lock down, turn it in the direction of the arrow.

If it does not turn, it can be operated the same way as the non-locking type.

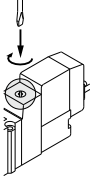

Locked position



Caution

When operating the locking type D with a screw driver, turn it gently using a watchmakers screw driver.

[Torque: Less than 0.1 N·m]

■ Push-turn locking lever type [Type E]

While pressing the lever down, turn it in the direction of the arrow.

If it does not turn, it can be operated the same way as the non-locking type.

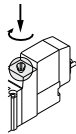

Locked position

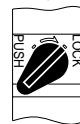

Caution

When locking the manual override on the push-turn locking types (D, E), be sure to push the lock down before turning it.

Turning without first pushing it down can cause damage to the manual override and trouble such as air leakage, etc.

Solenoid Valve for 200, 220 VAC Specifications

Warning

Solenoid valves with grommet and L/M type plug connector AC specifications have a built-in rectifier circuit in the pilot section to operate the DC coil.

With 200 V, 220 VAC specification pilot valves, this built-in rectifier generates heat when energized. The surface may become hot depending on the energization state; therefore, do not touch the solenoid valves.

Exhaust Throttle

Caution

With the 10-SY series, the pilot valve and main valve share a common exhaust inside the valve. Therefore, do not block the exhaust port when installing the piping.

10-SY3000/5000/7000/9000 Series Used as a 3-Port Valve

Caution

When using a 5-port valve as a 3-port valve

The 10-SY3000/5000/7000/9000 series can be used as normally closed (N.C.) or normally open (N.O.) 3-port valves by closing one of the cylinder ports (A or B) with a plug. However, they should be used with the exhaust ports kept open. (Refer to pages 162 to 165 for dedicated 3-port solenoid valves.)

Plug position		B port	A port
Actuation type		N.C.	N.O.
Number of solenoids	Single	(A)4 2(B) (EA)5 1 3(EB) (P)	(A)4 2(B) (EA)5 1 3(EB) (P)
	Double	(A)4 2(B) (EA)5 1 3(EB) (P)	(A)4 2(B) (EA)5 1 3(EB) (P)

Directional Control Valves

Air Cylinders

Rotary Actuators

Air Grippers

Air Preparation Equipment

Modular F. R.

Pressure Control Equipment

Fittings & Tubing

Flow Control Equipment

Pressure Switches/ Pressure Sensors



Series 10-SY

Specific Product Precautions 2

Be sure to read this before handling.

Refer to page 1382 for Safety Instructions and pages 677 to 683 for 3/4/5 Port Solenoid Valve Precautions.

How to Use Plug Connector

⚠ Caution

1. Attaching and detaching connectors

- To attach a connector, hold the lever and connector unit between your fingers and insert straight onto the pins of the solenoid valve so that the lever's pawl is pushed into the groove and locks.
- To detach a connector, remove the pawl from the groove by pushing the lever downward with your thumb, and pull the connector straight out.

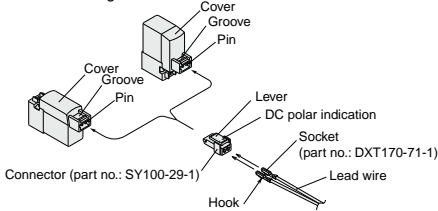

2. Crimping connection of lead wire and socket

Strip 3.2 to 3.7 mm at the end of lead wires, insert the end of the core wires evenly into the sockets, and then crimp it with a crimping tool. When this is done, take care that the coverings of the lead wires do not enter the core wire crimping area. (Please contact SMC for the dedicated crimping tools.)

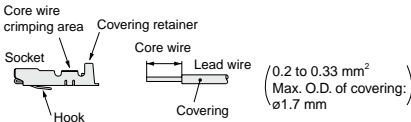

3. Attaching and detaching lead wires with sockets

• Attaching

Insert the sockets into the square holes of the connector (+, - indication), and continue to push the sockets all the way in until they lock by hooking into the seats in the connector. (When they are pushed in, the hooks open and they are locked automatically.) Then confirm that they are locked by pulling lightly on the lead wires.

• Detaching

To detach a socket from a connector, pull out the lead wire while pressing the socket's hook with a thin tipped stick (approx. 1 mm). If the socket is to be used again, first spread the hook outward.

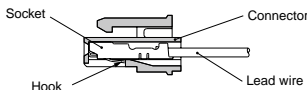

Surge Voltage Suppressor

⚠ Caution

<For DC>

Grommet, L/M Plug Connector

■ Polar type (Standard)

With surge voltage suppressor (□S)

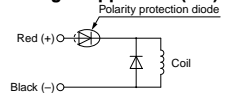

With light/surge voltage suppressor (□Z)

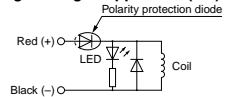

■ Non-polar type

With surge voltage suppressor (□R)

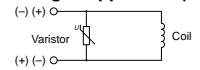

With light/surge voltage suppressor (□U)

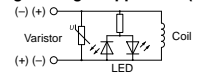

- Connect the polar type in accordance with the +, - polarity indication. (The non-polar type can be used with the connections made either way.)
- Since voltage specifications other than polar type 24 V and 12 VDC do not have diodes for polarity protection, be careful not to make errors in the polarity.
- When wiring is done at the factory, positive (+) is red and negative (-) is black.

■ With power saving circuit

Power consumption is decreased by 1/4 by reducing the wattage required to hold the valve in an energized state. (Effective energizing time is over 62 ms at 24 VDC.)

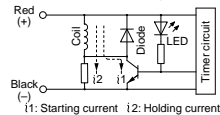

Operating Principle

With the above circuit, the current consumption when holding is reduced to save energy. Please refer to the electric wave data below.

- Please be careful not to reverse the polarity, since a diode to prevent the reversed current is not provided for the power saving circuit.

(The electric wave form of the energy saving 10-SY $\frac{3}{4}$ is 0T)

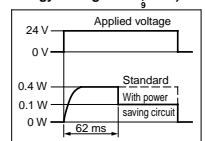



Series 10-SY Specific Product Precautions 3

Be sure to read this before handling.
Refer to page 1382 for Safety Instructions and pages 677 to 683 for 3/4/5 Port Solenoid Valve Precautions.

Surge Voltage Suppressor

DIN Terminal

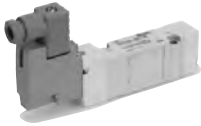

With surge voltage suppressor (DS)

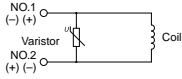

With light/surge voltage suppressor (DZ)

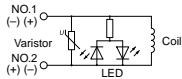

DIN terminal has no polarity.

M8 Connector

■ Polar type (Standard)

With surge voltage suppressor (□S)

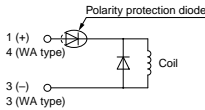

With light/surge voltage suppressor (□Z)

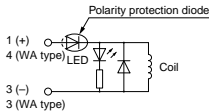

■ Non-polar type

With surge voltage suppressor (□R)

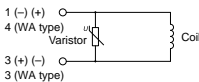

With light/surge voltage suppressor (□U)

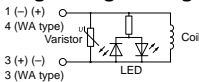

Solenoid valve side pin wiring diagram

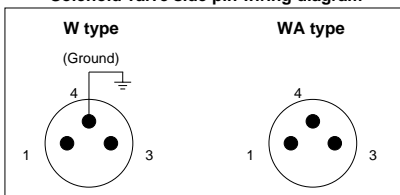

Note) The WA-type valve cannot be grounded.

M8 Connector

- For wiring of the polar type, connect + to 1 and - to 3 for type W, and + to 4 and - to 3 for type WA.
- Since voltage specifications other than polar type 24 V and 12 VDC do not have diodes for polarity protection, be careful not to make errors in the polarity.

Plug-in

Circuit for non-polar (FU)

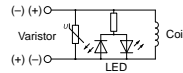

Plug-in valves have no polarity, so it's possible to use for both manifold bases for positive (10-SS5Y²-45□) and negative, it's common (10-SS5Y²-45N□) types.

<For AC>

(There is no "S" option, because the generation of surge voltage is prevented by a rectifier.)

Grommet, L/M Plug Connector

With light

GZ
LZ, LOZ, MZ, MOZ

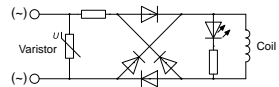

DIN Terminal

With light (DZ)

(YZ)

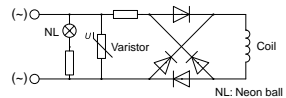

Note) The surge voltage suppressor of the varistor has residual voltage corresponding to the protective element and rated voltage. Therefore, protect the controller side from the surge voltage. The residual voltage of the diode is approximately 1 V.

Directional Control Valves

Air Cylinders

Rotary Actuators

Air Grippers

Air Preparation Equipment

Modular F. R.

Pressure Control Equipment

Fittings & Tubing

Flow Control Equipment

Pressure Switches/Pressure Sensors



Series 10-SY Specific Product Precautions 4

Be sure to read this before handling.
Refer to page 1382 for Safety Instructions and pages 677 to 683 for 3/4/5 Port Solenoid Valve Precautions.

Plug Connector Lead Wire Length

Caution

Standard length is 300 mm, but the following lengths are also available.

How to Order Connector Assembly

	Lead wire color
For DC: SY100-30-4A	Red, Black
For 100 VAC: SY100-30-1A	Blue
For 200 VAC: SY100-30-2A	Red
For other voltages of AC: SY100-30-3A	Gray
Without lead wire: SY100-30-A	
(with connector and 2 of sockets only)	

• How to Order

Specify the part numbers of the solenoid valve without connector and the connector assembly with protective cover separately.

<Example> Lead wire length 2000 mm

For DC	For AC
10-SY3120-5LO-M5	10-SY3120-1LO-M5
SY100-30-4A-20	SY100-30-1A-20

Lead wire length	
Nil	300 mm
6	600 mm
10	1000 mm
15	1500 mm
20	2000 mm
25	2500 mm
30	3000 mm
50	5000 mm

How to Use DIN Terminal

Caution

Connection

- Loosen the holding screw and pull the connector out of the solenoid valve terminal block.
- After removing the holding screw, insert a flat head screwdriver or similar object into the notch on the bottom of the terminal block and pry it open, separating the terminal block and the housing.
- Loosen the terminal screws (slotted screws) on the terminal block, insert the cores of the lead wires into the terminals according to the connection method, and fasten them securely with the terminal screws.
- Secure the cord by fastening the ground nut.

Caution

When making connections, take note that using other than the supported size ($\phi 3.5$ to $\phi 7$) heavy duty cord will not satisfy IP65 (enclosure) standards. Also, be sure to tighten the ground nut and holding screw within their specified torque ranges.

Changing the entry direction

After separating the terminal block and housing, the cord entry can be changed by attaching the housing in the desired direction (4 directions at 90° intervals).

* If equipped with a light, be careful not to damage the light with the cord's lead wires.

Precautions

Plug in and pull out the connector vertically without tilting to one side.

Compatible cables

Cord O.D.: $\phi 3.5$ to $\phi 7$

(Reference) 0.5 mm², 2-core or 3-core, equivalent to JIS C 3306

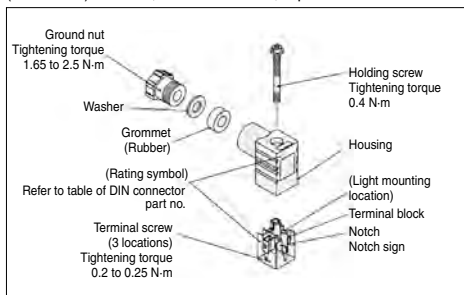

Type "Y"

DIN connector type Y is a DIN connector that conforms to the DIN pitch 8-mm standard.

- D type DIN connector with 9.4 mm pitch between terminals is not interchangeable.
- To distinguish from the D type DIN connector, "N" is listed at the end of the voltage symbol. (For connector parts without lights, "N" is not indicated. Please refer to the name plate to distinguish models.)
- Dimensions are completely the same as the D type DIN connector.
- When exchanging the pilot valve assembly only, "V115-□D" is interchangeable with "V115-□Y". Do not replace V111 (G, L, M) with V115-□D/□Y (DIN terminal), and vice versa.



Series 10-SY Specific Product Precautions 5

Be sure to read this before handling.
Refer to page 1382 for Safety Instructions and pages 677 to 683 for 3/4/5 Port Solenoid Valve Precautions.

10-SY300, 10-SY3000 Series How to Use DIN Terminal Connector

⚠ Caution

- SMC can provide a DIN terminal connector (body ported type, sub-plate type) for the 10-SY300 and 10-SY3000 series. This cannot be assembled to a standard manifold and sub-plate since the DIN connector width (15.8 mm) exceeds that of the valve body (10 mm). Contact SMC if you wish to use it with a manifold and sub-plate. Please also note that bracket F1 cannot be mounted.
- DIN terminal connectors cannot be used with single manifolds, and do not have a body ported external pilot option.

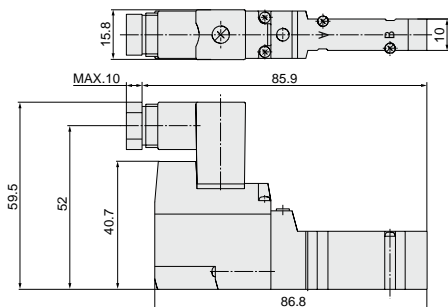

DIN Connector Part No.

⚠ Caution

<Type D>

Without light	SY100-61-1
---------------	------------

With light

Rated voltage	Voltage symbol	Part no.
24 VDC	24 V	SY100-61-3-05
12 VDC	12 V	SY100-61-3-06
100 VAC	100 V	SY100-61-2-01
200 VAC	200 V	SY100-61-2-02
110 VAC	110 V	SY100-61-2-03
220 VAC	220 V	SY100-61-2-04

<Type Y>

Without light	SY100-82-1
---------------	------------

With light

Rated voltage	Voltage symbol	Part no.
24 VDC	24 V	SY100-82-3-05
12 VDC	12 V	SY100-82-3-06
100 VAC	100 V	SY100-82-2-01
200 VAC	200 V	SY100-82-2-02
110 VAC (115 VAC)	110 V	SY100-82-2-03
220 VAC (230 VAC)	220 V	SY100-82-2-04

Circuit Diagram with Light

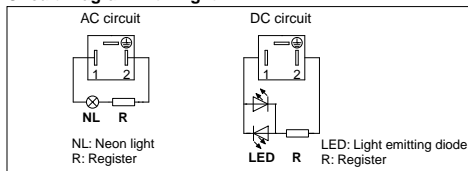

Connector Assembly with Cover

⚠ Caution

Connector assembly with dust proof protective cover.

- Effective for prevention of short circuit failure due to the entry of foreign matter into the connector.
- Chloroprene rubber for electrical use, which provides outstanding weather resistance and electrical insulation, is used for the cover material. However, do not allow contact with cutting oil, etc.
- Simple and unencumbered appearance by adopting round-shaped cord.

How to Order

SY100-68-A - []

• Lead wire length (L)

Nil	300 mm
6	600 mm
10	1000 mm
15	1500 mm
20	2000 mm
25	2500 mm
30	3000 mm
50	5000 mm

Connector Assembly with Cover: Dimensions

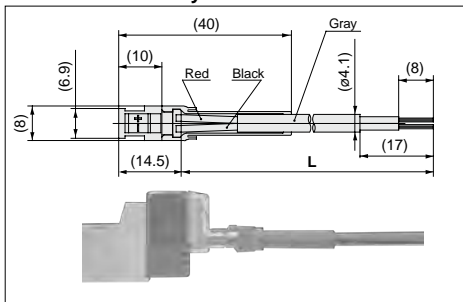

How to Order

Enter the part number for a plug connector solenoid valve without connector together with the part number for a connector assembly with cover.

<Example 1> Lead wire length of 2000 mm

10-SY3120-5LOZ-M5

SY100-68-A-20

<Example 2> Lead wire length of 300 mm (standard)

10-SY3120-5LPZ-M5

[] Symbol for connector assembly with cover

* In this case, the part number for the connector assembly with cover is not required.



Series 10-SY Specific Product Precautions 6

Be sure to read this before handling.

Refer to page 1382 for Safety Instructions and pages 677 to 683 for 3/4/5 Port Solenoid Valve Precautions.

DIN Rail for 10-SY7000/9000 Series

⚠ Caution

The DIN rail used with the 10-SY7000 and SY9000 series is stronger than that used with the 10-SY3000 and SY5000 series. Use this exclusive DIN rail with the 10-SY7000 and SY9000 series. Furthermore, if using a DIN rail other than that supplied by SMC, refer to the manifold mounting section below, and mount using the same method as prescribed for side facing and rear facing, regardless of the mounting orientation.

Manifold Mounting

⚠ Caution

For type 23, 43, 45, 45□ and 60 DIN rail mounting, when attaching a manifold to a mounting surface, etc., with bolts, if the entire bottom surface of the DIN rail contacts the mounting surface in a horizontal mounting, it can be used by simply securing both ends of the DIN rail. However, for any other mounting method or for side facing and rear facing, etc., secure the DIN rail with bolts at uniform intervals using the following as a guide: 2 to 5 stations at 2 locations, 6 to 10 stations at 3 locations, 11 to 15 stations at 4 locations, and 16 to 20 stations at 5 locations. In addition, even in the case of a horizontal mounting, if the mounting surface is subject to vibration, etc., take the same measures indicated above. If secured at fewer than the specified number of locations, warping or twisting may occur in the DIN rail and manifold, causing trouble such as air leakage.

Also, when using mounting screws for the DIN rail on the bottom side (L3 dimension in the dimension table) of the manifold valve body, the height of the screw head has to be as follows.

Type 23, 43 (10-SY9000): 8 mm or less

Type 45 (10-SY3000, 5000): 5.8 mm or less

For type 60:

10-SY3000: 4.7 mm or less

10-SY5000: 5.8 mm or less

10-SY7000: 8 mm or less

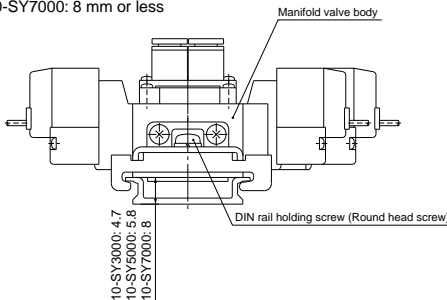

[For type 60]

One-touch Fittings

⚠ Caution

The pitch determined for each of the 10-SY series piping ports (P, A, B, etc.) is based on the assumption that the 10-KQ2 series One-touch fittings will be used. For this reason, other pipe fittings may interfere with each other depending on their type and size. Dimensions should be confirmed in a pipe fitting catalog before they are used.

• Tubing attachment/detachment for One-touch fittings

1) Attaching tubing

1. Take a tubing with no flaws on its periphery and cut it off at a right angle. When cutting the tubing, use tube cutters TK-1, 2 or 3. Do not use pinchers, nippers or scissors, etc. If cutting is done with tools other than tube cutters, the tubing may be cut diagonally or become flattened, making a secure installation impossible, and causing problems such as the tubing coming out after installation or air leakage. Allow some extra length in the tubing.
2. Grasp the tubing, slowly push it straight (0 to 5°) into the One-touch fitting until it comes to a stop.
3. After inserting the tubing, pull on it lightly to confirm that it will not come out. If it is not installed securely all the way into the fitting, this can cause problems such as air leakage or the tubing coming out.

2) Detaching tubing

1. Push in the release button sufficiently, pushing its collar equally around the circumference.
2. Pull out the tubing while holding down the release button so that it does not come out. If the release button is not pressed down sufficiently, there will be increased bite on the tubing and it will become more difficult to pull it out.
3. When the removed tubing is to be used again, cut off the portion which had been secured before reusing it. If the same portion of the tubing is reused, this can cause trouble such as air leakage or difficulty in removing the tubing.



Series 10-SY Specific Product Precautions 7

Be sure to read this before handling.
Refer to page 1382 for Safety Instructions and pages 677 to 683 for 3/4/5 Port Solenoid Valve Precautions.

Other Tubing Brands

⚠ Caution

1. When using tubing other than SMC brand tubing, confirm that the following specifications are satisfied with respect to the outside diameter tolerance of the tubing.

- | | |
|------------------------|---|
| 1) Nylon tubing | within ± 0.1 mm |
| 2) Soft nylon tubing | within ± 0.1 mm |
| 3) Polyurethane tubing | within $+0.15$ mm,
within -0.2 mm. |

Do not use tubing which do not meet these outside diameter tolerances. It may not be possible to connect them, or they may cause other trouble, such as air leakage or the tubing coming out after connection.

M8 Connector

⚠ Caution

1. M8 connectors have an IP65 (enclosure) rating, offering protection from dust and water. However please note that these products are not intended for use in water.

Select a SMC connector cable (V100-49-1-□) or a FA sensor type connector, with M8 threaded 3 pin specifications conforming to Nippon Electric Control Equipment Industries Association Standard, NECA4202 (IEC60947-5-2). Make sure the connector O.D. is 10.5 mm or less when used with the 10-SY3000 series manifold. If more than 10.5 mm, it cannot be mounted due to the size.

2. Do not use a tool to mount the connector, as this may cause damage. Only tighten by hand. (0.4 to 0.6 N·m)
3. Excessive stress on the cable connector will cause a loss of the IP65 rating. Please use caution and do not apply a stress of 30 N or greater.

⚠ Caution

Failure to meet IP65 performance may result if using alternative connectors than those shown above, or when insufficiently tightened.

Connector cable mounting

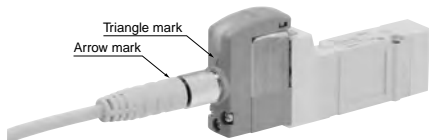

Note) Connector cable should be mounted in the correct direction. Make sure that the arrow symbol on the connector is facing the triangle symbol on the valve when using a SMC connector cable (V100-49-1-□).

Be careful not to squeeze it in the wrong direction, as problems such as pin damage may occur.

M8 Connector

⚠ Caution

■ Connector cable

- Connector cable for M8 can be ordered as follows:

How to Order

1. To order a solenoid valve and connector cable at the same time. (Connector cable will be included in the shipment of the solenoid valve.)

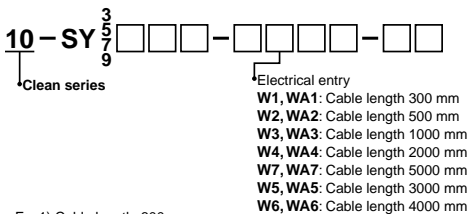

Ex. 1) Cable length: 300 mm

10-SY312-5W1ZE-C4

→ Symbol for electrical entry

2. To order connector cable only

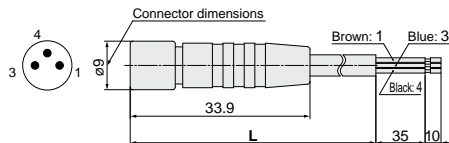

Cable length (L)	Part no.
300 mm	V100-49-1-1
500 mm	V100-49-1-2
1000 mm	V100-49-1-3
2000 mm	V100-49-1-4
5000 mm	V100-49-1-7
3000 mm	V100-49-1-5
4000 mm	V100-49-1-6

[Dimensions when installed]

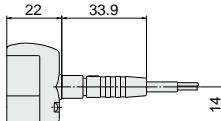

Solenoid Valve Mounting

⚠ Caution

Mount so that there is no slippage or deformation in gaskets, and tighten with the tightening torque as shown below.

Model	Thread size	Tightening torque
10-SY3000	M2	0.16 N·m
10-SY5000	M3	0.8 N·m
10-SY7000	M4	1.4 N·m
10-SY9000	M3	0.8 N·m



Series 10-SY

Specific Product Precautions 8

Be sure to read this before handling.

Refer to page 1382 for Safety Instructions and pages 677 to 683 for 3/4/5 Port Solenoid Valve Precautions.

Replacement of Pilot Valve

Caution

Pilot valves in this series are improved to provide excellent energy saving results. However following this improvement, these new valves are no longer compatible with the existing pilot valve used at the interface. Consult with SMC if you need to exchange these pilot valves, for manual override (marked in orange) of the adapter plate.

New valve

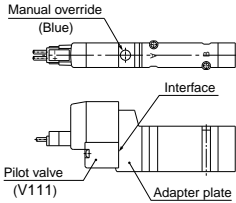

Existing valve

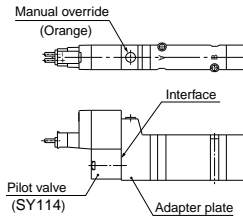

Series 10-SV1000/2000/3000/4000 5 Port Solenoid Valve

Serial wiring



Decentralized serial wiring

P.182

IP67 compliant

Applicable series	Cassette base manifold
	10-SV1000/10-SV2000
Applicable series	Tie-rod base manifold
	10-SV1000/10-SV2000/10-SV3000/10-SV4000
<ul style="list-style-type: none"> · Number of outputs: 16 · EX500 gateway communication specifications · DeviceNet™, PROFIBUS-DP, EtherNet/IP™ 	



Serial wiring with input/output unit

P.192

IP67 compliant

Applicable series	Tie-rod base manifold
	10-SV1000/10-SV2000/10-SV3000
<ul style="list-style-type: none"> · Number of inputs/outputs: 32 each 	



IP67 compliant

Applicable series	Tie-rod base manifold
	10-SV1000/10-SV2000/10-SV3000
<ul style="list-style-type: none"> · Digital inputs/outputs: Max. 144/144 · Analog input: Max. 18 channels · Number of valve outputs: 32 	



Dedicated output serial wiring

P.208

Applicable series	Cassette base manifold
	10-SV1000/10-SV2000
Applicable series	Tie-rod base manifold
	10-SV1000/10-SV2000/10-SV3000/10-SV4000
<ul style="list-style-type: none"> · Number of outputs: 16 	

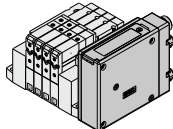

IP67 compliant
(Some products are IP40)

Applicable series	Tie-rod base manifold
	10-SV1000/10-SV2000/10-SV3000
<ul style="list-style-type: none"> · Number of outputs: 32/16 	

Parallel wiring



For circular connector

P.230

IP67 compliant

Applicable series	Cassette base manifold
	10-SV1000/10-SV2000
Applicable series	Tie-rod base manifold
	10-SV1000/10-SV2000/10-SV3000/10-SV4000
<ul style="list-style-type: none"> · Number of connectors: 26 pins 	



D-sub connector

P.240

Applicable series	Cassette base manifold
	10-SV1000/10-SV2000
Applicable series	Tie-rod base manifold
	10-SV1000/10-SV2000/10-SV3000/10-SV4000
<ul style="list-style-type: none"> · Number of connectors: 25 pins · MIL-C-24308 · Conforming to JIS-X-5101 	



Flat ribbon cable connector

P.250

Applicable series	Cassette base manifold
	10-SV1000/10-SV2000
Applicable series	Tie-rod base manifold
	10-SV1000/10-SV2000/10-SV3000/10-SV4000
<ul style="list-style-type: none"> · Number of connectors: 26, 20, 10 pins · With strain relief · Conforming to MIL-C-83503 	



Valve manifold specifications

P.260

Manifold option

Single unit/Sub-plate [IP67 compliant]

P.265

IP67 compliant	Applicable series	10-SV1000/10-SV2000/10-SV3000/10-SV4000
		<ul style="list-style-type: none"> · With waterproof M12 connector

Valve Manifold Common Specifications

Cassette base manifold



Manifold Specifications

Applicable series		10-SV1000	10-SV2000
Manifold type		Stacking type cassette base manifold	
1 (P: SUP), 3/5 (E: EXH) type		Common SUP, EXH	
Valve stations (maximum)		18 stations	20 stations
Max. number of solenoids		18 points	26 points
Port size	1(P), 3/5(E) port	C8, N9	C10, N11
	4(A), 2(B) port	C3, C4, C6 N1, N3, N7	C4, C6, C8 N3, N7, N9

Flow Rate Characteristics

Model	Port size		Flow rate characteristics					
	1, 5, 3 (P, EA, EB)	4, 2 (A, B)	1→4/2 (P→A/B)			4/2→3/5 (A/B→E)		
			C [dm ³ /(s·bar)]	b	Cv	C [dm ³ /(s·bar)]	b	Cv
10-SS5V1-16	C8	C6	0.89	0.22	0.22	0.98	0.21	0.23
10-SS5V2-16	C10	C8	2.3	0.28	0.50	2.7	0.18	0.56

Note) The values are for individually operated 2 position type manifold bases with 5 stations.

Tie-rod base manifold



Manifold Specifications

Applicable series		10-SV1000	10-SV2000	10-SV3000	10-SV4000
Manifold type		Tie-rod base manifold			
1 (P: SUP), 3/5 (E: EXH) type		Common SUP, EXH			
Valve stations (maximum)		20 stations			
Max. number of solenoids		32 points			
Port size	1(P), 3/5(E) port	C8, N9	C10, N11	C12, N11	C12, N11, 03
	4(A), 2(B) port	C3, C4, C6 N1, N3, N7	C4, C6, C8 N3, N7, N9	C6, C8, C10 N7, N9, N11	C8, C10, C12 N9, N11, 02, 03

Flow Rate Characteristics

Model	Port size		Flow rate characteristics					
	1, 5, 3 (P, EA, EB)	4, 2 (A, B)	1→4/2 (P→A/B)			4/2→3/5 (A/B→E)		
			C [dm ³ /(s·bar)]	b	Cv	C [dm ³ /(s·bar)]	b	Cv
10-SS5V1-10	C8	C6	0.98	0.26	0.24	1.1	0.35	0.28
10-SS5V2-10	C10	C8	2.1	0.20	0.46	2.4	0.18	0.48
10-SS5V3-10	C12	C10	4.2	0.22	0.91	4.3	0.21	0.93
10-SS5V4-10	C12	C12	6.2	0.19	1.3	7.0	0.18	1.6

Note) The values are for individually operated 2 position type manifold bases with 5 stations.

Enclosure of Manifold Variations (Common for cassette base and tie-rod base)

Series	Enclosure (Based on IEC529)
EX500 Decentralized serial wiring	IP67 *1
EX250 Serial wiring with input/output unit	IP67
EX600 Serial wiring with input/output unit	IP67 (Manifold assembly)
EX120 Dedicated output serial wiring	Dusttight (IP40)
EX260 Dedicated output serial wiring	IP67 *2
For circular connector	IP67
D-sub connector	Dusttight (IP40)
Flat ribbon cable	Dusttight (IP40)

*1 Enclosure of a gateway unit and input manifold is IP65.

*2 Enclosure is IP40 when the communication connector is D-sub.

Directional Control Valves
 Air Cylinders
 Rotary Actuators
 Air Grippers
 Air Preparation Equipment
 Modular F. R.
 Pressure Control Equipment
 Fittings & Tubing
 Flow Control Equipment
 Pressure Switches/ Pressure Sensors

Series 10-SV Solenoid Valve Specifications



Made to Order
(For details, refer to page 272.)

Symbol

Series 10-SV1000/2000/3000/4000

2 position single

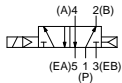

2 position double

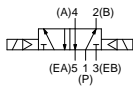

Series 10-SV1000/2000/3000

3 position closed center

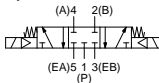

3 position exhaust center



3 position pressure center

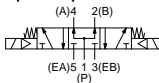

Series 10-SV4000

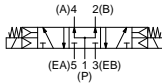
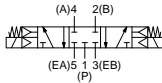

Series 10-SV1000

4 position dual 3 port valve

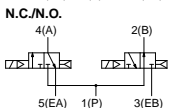
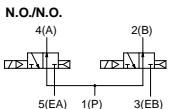
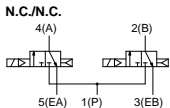

Series 10-SV2000

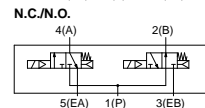
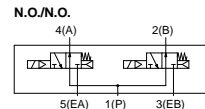
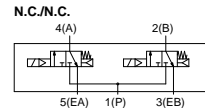

* SV3000 and 4000 are not available with 4 position dual 3 port valve.

Fluid		Air
Internal pilot operating pressure range (MPa)	2 position single	0.15 to 0.7
	4 position dual 3 port valve	
	2 position double	
External pilot operating pressure range (MPa)	3 position	-100 kPa to 0.7
	Operating pressure range	
	2 position single, double	
Ambient and fluid temperature (°C)	3 position	-10 to 50 (No freezing. Refer to page 680.)
	Max. operating frequency (Hz)	
Manual override	2 position single, double	5
	4 position dual 3 port valve	
	3 position	
Pilot exhaust method	Non-locking push type	
	Internal pilot	Push-turn locking slotted type
	External pilot	Main/Pilot valve common exhaust
Lubrication	Not required	
Mounting orientation	Unrestricted	
Impact/Vibration resistance (m/s ²)	150/30	
Enclosure	IP67 (Based on IEC60529)	
Coil rated voltage	24 VDC, 12 VDC	
Allowable voltage fluctuation	±10% of rated voltage	
Power consumption	0.6 (With indicator light: 0.65)	
Surge voltage suppressor	Zener diode	
Indicator light	LED	

Note) Impact resistance: No malfunction occurred when it was tested in the axial direction and at right angles to the main valve and armature in both energized and de-energized states once for each condition. (Default settings)

Vibration resistance: No malfunction occurred in a one-sweep test between 45 and 2000 Hz. Test was performed in both energized and de-energized states in the axial direction and at right angles to the main valve and armature. (Default settings)

Response Time

Actuation type	Response time (ms) (at the pressure of 0.5 MPa)			
	10-SV1000	10-SV2000	10-SV3000	10-SV4000
2 position single	11 or less	25 or less	28 or less	40 or less
2 position double	10 or less	17 or less	26 or less	40 or less
3 position	18 or less	29 or less	32 or less	82 or less
4 position dual 3 port valve	15 or less	33 or less	—	—

Note) Based on dynamic performance test, JIS B 8375-1981 (Coil temperature: 20°C, at rated voltage)

Weight

Series	Actuation type	Weight (g)
10-SV1000	Single solenoid	66
	Double solenoid	71
	3 position	73
	4 position dual 3 port	71
10-SV2000	Single solenoid	74
	Double solenoid	78
	3 position	83
	4 position dual 3 port	78
10-SV3000	Single solenoid	99
	Double solenoid	102
	3 position	110
10-SV4000	Single solenoid	186
	Double solenoid	190
	3 position	211

Note) Weight of solenoid valve only.

Decentralized Serial Wiring

Series *EX500*

IP67 compliant

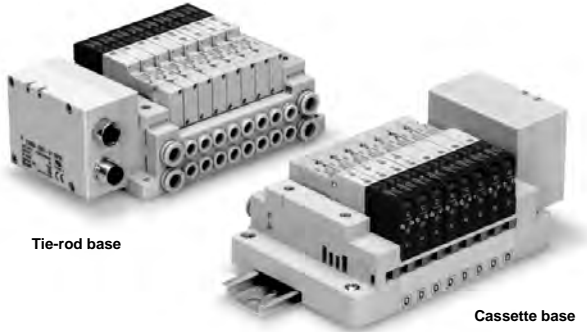

Tie-rod base

Cassette base

Applicable series	Cassette base manifold 10-SV1000/10-SV2000
	Tie-rod base manifold 10-SV1000/10-SV2000/10-SV3000/10-SV4000
<ul style="list-style-type: none"> · Number of outputs: 16 · EX500 gateway unit communication specifications DeviceNet™, PROFIBUS-DP, EtherNet/IP™ 	

Directional Control Valves

Air Cylinders

Rotary Actuators

Air Grippers

Air Preparation Equipment

Modular F. R.

Pressure Control Equipment

Fittings & Tubing

Flow Control Equipment

Pressure Switches/ Pressure Sensors

Series 10-SV

EX500 Decentralized Serial Wiring



How to Order

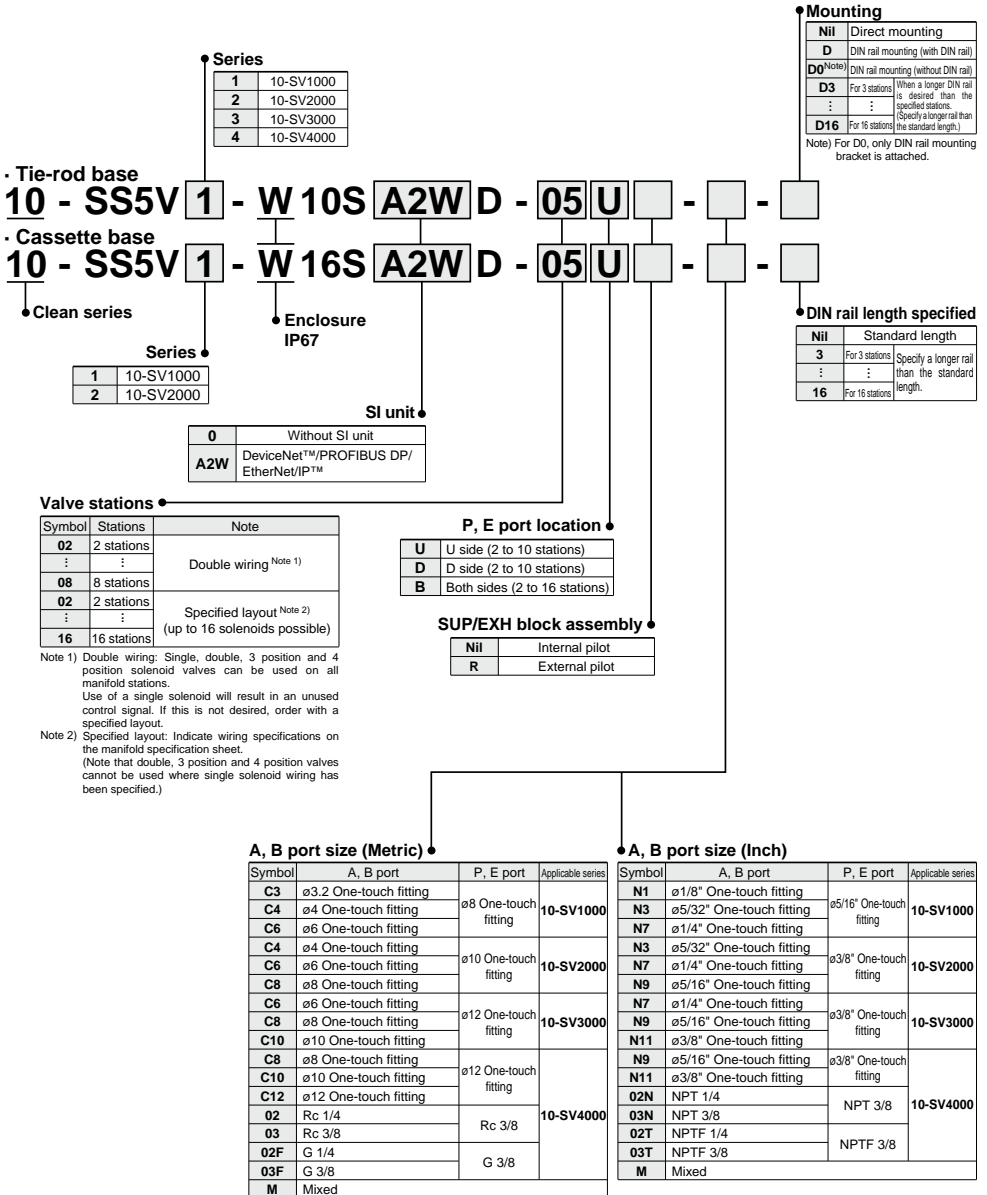

* For mixed specifications (M), indicate separately on the manifold specification sheet.
 * External pilot type (R) X, PE port sizes are ø4 (metric), ø5/32" (inch) for the 10-SV1000/2000 series and ø6 (metric), ø1/4" (inch) for the 10-SV3000/4000 series.

How to Order Valve Manifold Assembly

Ordering example (10-SV1000)

Manifold

10-SS5V1-W16SA2WD-06B-C6 (1 set)

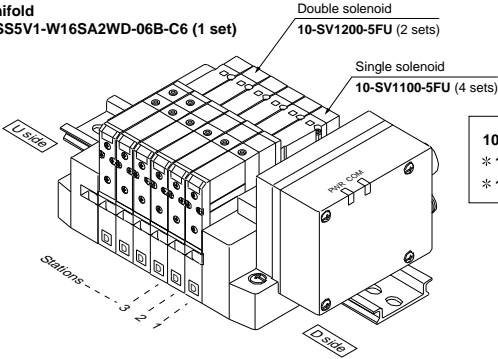

10-SS5V1-W16SA2WD-06B-C6.....1 set (Manifold part no.)
 * 10-SV1100-5FU.....4 sets (Single solenoid part no.)
 * 10-SV1200-5FU.....2 sets (Double solenoid part no.)

How to Order Solenoid Valve

10 - SV 1 1 00 - 5 F -

Clean series

Series

1	10-SV1000
2	10-SV2000
3	10-SV3000
4	10-SV4000

Actuation type

1	2 position single solenoid
2	2 position double solenoid
3	3 position closed center
4	3 position exhaust center
5	3 position pressure center
A	4 position dual 3 port valve: N.C./N.C.
B	4 position dual 3 port valve: N.O./N.O.
C	4 position dual 3 port valve: N.C./N.O.

* 4 position dual 3 port valves are applicable to the 10-SV1000 and 10-SV2000 series only.

Pilot type

Nil	Internal pilot
R	External pilot

* External pilot specifications are not available for 4 position dual 3 port valves.

Back pressure check valve

Nil	None
K	Built-in

* The built-in back pressure check valve type is applicable to the 10-SV1000 series only.
 * The product with back pressure check valve is not available for 3 position solenoid valves.

Rated voltage

5	24 VDC
---	--------

Made to Order

Nil	—
X90	Main valve fluororubber (Refer to page 272.)

Manual override

Nil: Non-locking push type D: Push-turn locking slotted type

Light/surge voltage suppressor

U	With light/surge voltage suppressor
R	With surge voltage suppressor

Note) Refer to the Specific Product Precautions 2 on page 274.

Directional Control Valves
 Air Cylinders
 Rotary Actuators
 Air Grippers
 Air Preparation Equipment
 Modular F. R.
 Pressure Control Equipment
 Fittings & Tubing
 Flow Control Equipment
 Pressure Switches/ Pressure Sensors

Dimensions: Series 10-SV1000 for EX500 Decentralized Serial Wiring

• **Cassette base manifold: 10-SS5V1-W16SA2WD-**

U	D
D	R
B	(R)

C3, N1
C4, N3
C6, N7

- When P, E port outlets are indicated on the U side or D side, the P, E ports on the opposite side are plugged.
- External pilot port positions are the same as P, E port outlet positions.

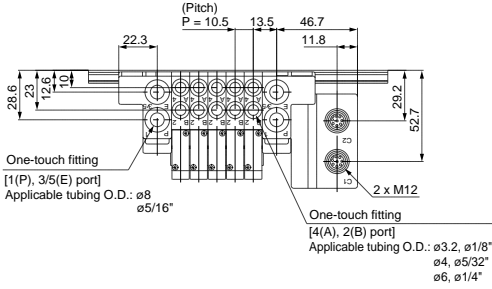

With external pilot specifications

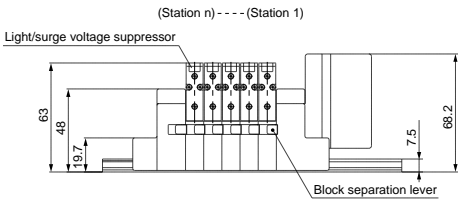
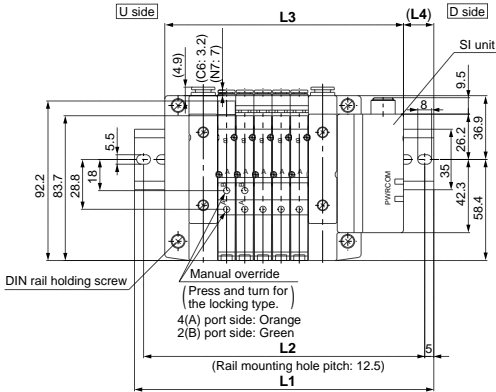
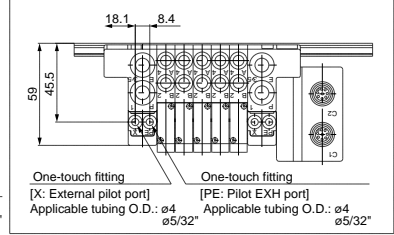

With option

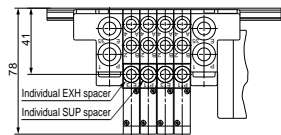

L Dimension

n	2	3	4	5	6	7	8	9	10	11	12	13	14	15	16	n: Stations
L1	135.5	148	160.5	173	173	185.5	198	210.5	223	235.5	235.5	248	260.5	273	285.5	
L2	125	137.5	150	162.5	162.5	175	187.5	200	212.5	225	225	237.5	250	262.5	275	
L3	106.5	117	127.5	138	148.5	159	169.5	180	190.5	201	211.5	222	232.5	243	253.5	
L4	14.5	15.5	16.5	17.5	12.5	13.5	14.5	15.5	16.5	17.5	12	13	14	15	16	

Dimensions: Series 10-SV2000 for EX500 Decentralized Serial Wiring

• **Cassette base manifold: 10-SS5V2-W16SA2WD-** Stations U
D
B (R)- C4, N3
C6, N7
C8, N9

- When P, E port outlets are indicated on the U side or D side, the P, E ports on the opposite side are plugged.
- External pilot port positions are the same as P, E port outlet positions.

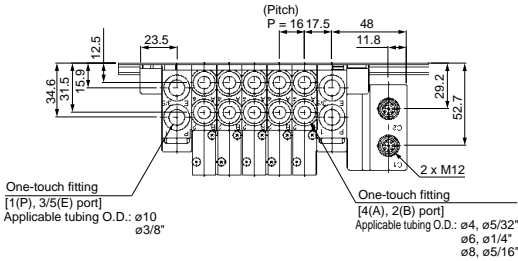

With external pilot specifications

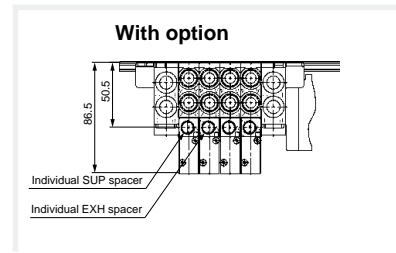
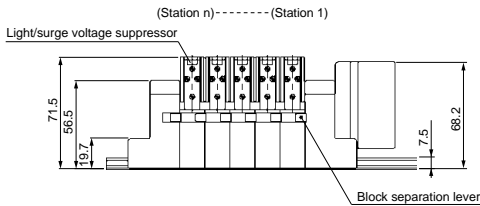
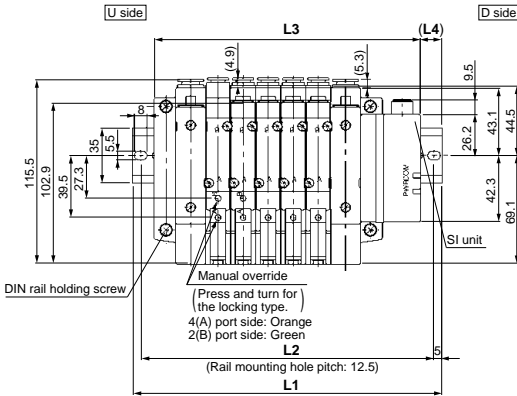
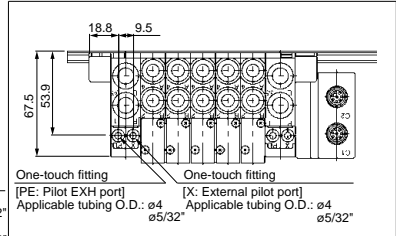

L Dimension

n	2	3	4	5	6	7	8	9	10	11	12	13	14	15	16	n: Stations
L1	148	173	185.5	198	210.5	235.5	248	260.5	285.5	298	310.5	323	348	360.5	373	
L2	137.5	162.5	175	187.5	200	225	237.5	250	275	287.5	300	312.5	337.5	350	362.5	
L3	122.5	138.5	154.5	170.5	186.5	202.5	218.5	234.5	250.5	266.5	282.5	298.5	314.5	330.5	346.5	
L4	13	17.5	15.5	14	12	16.5	15	13	17.5	16	14	12.5	17	15	13.5	

Directional Control Valves
 Air Cylinders
 Rotary Actuators
 Air Grippers
 Air Preparation Equipment
 Modular F. R.
 Pressure Control Equipment
 Fittings & Tubing
 Flow Control Equipment
 Pressure Switches/ Pressure Sensors

Dimensions: Series 10-SV2000 for EX500 Decentralized Serial Wiring

• Tie-rod base manifold: 10-SS5V2-W10SA2WD-Stations U D (R)-C4, N3 C6, N7 (-D) C8, N9

- When P, E port outlets are indicated on the U side or D side, the P, E ports on the opposite side are plugged.
- External pilot port positions are the same as P, E port outlet positions.

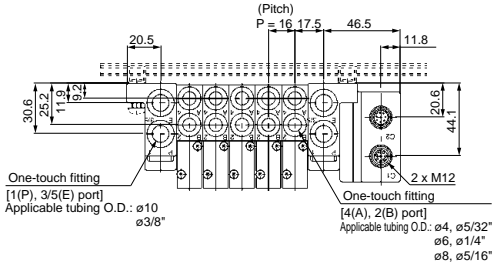

With external pilot specifications

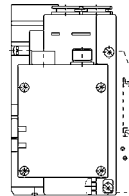
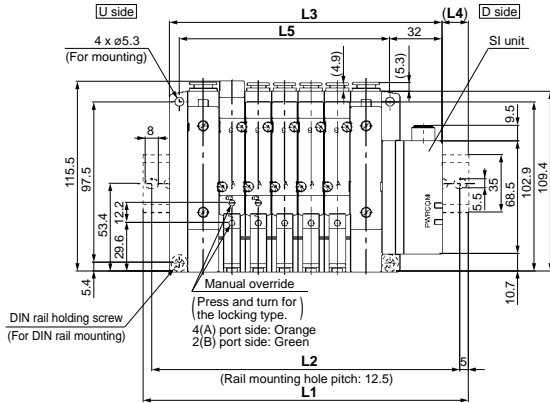
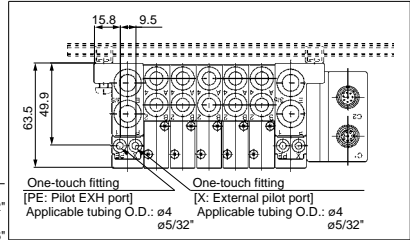

With option

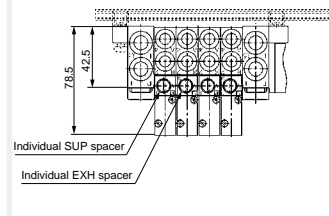
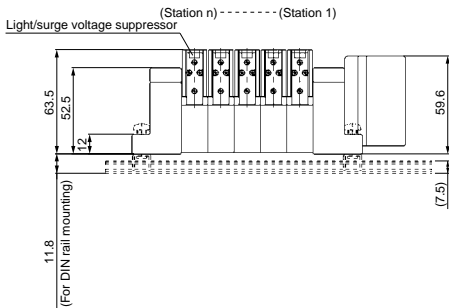

L Dimension

n: Stations

n	2	3	4	5	6	7	8	9	10	11	12	13	14	15	16
L1	148	160.5	185.5	198	210.5	223	248	260.5	273	285.5	310.5	323	335.5	360.5	373
L2	137.5	150	175	187.5	200	212.5	237.5	250	262.5	275	300	312.5	325	350	362.5
L3	118	134	150	166	182	198	214	230	246	262	278	294	310	326	342
L4	15	13.5	18	16	14.5	12.5	17	15.5	13.5	12	16.5	14.5	13	17.5	15.5
L5	80	96	112	128	144	160	176	192	208	224	240	256	272	288	304

Directional Control Valves
 Air Cylinders
 Rotary Actuators
 Air Grippers
 Air Preparation Equipment
 Modular F. R.
 Pressure Control Equipment
 Fittings & Tubing
 Flow Control Equipment
 Pressure Switches/ Pressure Sensors

Serial Wiring with Input/Output Unit

Series EX250

IP67 compliant

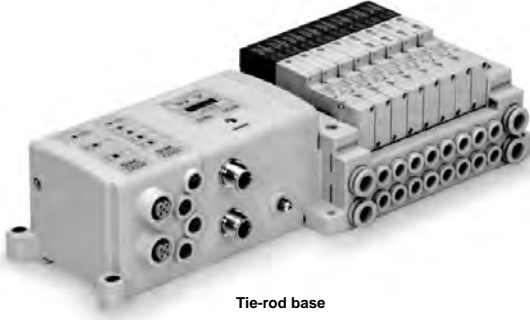

Tie-rod base

Applicable series	Tie-rod base manifold 10-SV1000/10-SV2000/10-SV3000
	· Number of inputs/outputs: 32 each

Directional
Control Valves

Air Cylinders

Rotary Actuators

Air Grippers

Air Preparation
Equipment

Modular F. R.

Pressure Control
Equipment

Fittings & Tubing

Flow Control
Equipment

Pressure Switches/
Pressure Sensors

Series 10-SV

EX250 Serial Wiring with Input/Output Unit



How to Order

• Tie-rod base

10 - SS5V 1 - W10S1 QW [] [] [] D - 05 U [] - [] - []

• Clean series

Series

1	SV1000
2	SV2000
3	SV3000

Enclosure
IP67

Input block stations

Nil	None
1	1 station
:	:
8	8 stations

Note) The symbol is nil for no SI unit.

Input block type

Nil	Without input block	
1	M12, 2 inputs	EX250-IE1
2	M12, 4 inputs	EX250-IE2
3	M8, 4 inputs	EX250-IE3

Note) The symbol is nil for no SI unit.

Input block specifications

Nil	PNP input (+COM) or without input block
N	NPN input (-COM)

Valve stations

Symbol	Stations	Note
02	2 stations	Double wiring Note 1)
:	:	
16	16 stations	Specified layout Note 2) (Up to 32 solenoids possible)
02	2 stations	
:	:	
20	20 stations	

• When the SI unit is for AS-i, the maximum numbers of solenoids are as follows.

TAW, TCW: Maximum 8 solenoids

TBW, TDW: Maximum 4 solenoids

Note 1) Double wiring: Single, double, 3 position and 4 position solenoid valves can be used on all manifold stations. Use of a single solenoid will result in an unused control signal. If this is not desired, order with a specified layout.

Note 2) Specified layout: Indicate wiring specifications on the manifold specification sheet. (Note that double, 3 position and 4 position valves cannot be used where single solenoid wiring has been specified.)

• SI unit

Symbol	Protocol type
W10S10	Without SI unit
W10S1QW	DeviceNet™
W10S1NW	PROFIBUS DP
W10S1VW	CC-Link
W10S1TAW	AS-Interface (8 in/8 out, 31 slave modes, 2 power supply systems)
W10S1TBW	AS-Interface (4 in/4 out, 31 slave modes, 2 power supply systems)
W10S1TCW (Note)	AS-Interface (8 in/8 out, 31 slave modes, 1 power supply system)
W10S1TDW (Note)	AS-Interface (4 in/4 out, 31 slave modes, 1 power supply system)
W10S1YW	CANopen
W10S1ZEN	EtherNet/IP™

• Input blocks cannot be mounted without SI unit.

• When the DIN rail is included without an SI unit, the DIN rail length will accommodate an SI unit and one input block.

Note) There is a limit to the supply current to the input block and valve from SI units that have AS-Interface-compliant 1 power supply system. For details, refer to the [WEB catalog](#).

P, E port location

U	U side (2 to 10 stations)
D	D side (2 to 10 stations)
B	Both sides (2 to 20 stations)

SUP/EXH block assembly

Nil	Internal pilot
R	External pilot

A, B port size (Metric)

Symbol	A, B port	P, E port	Applicable series
C3	ø3.2 One-touch fitting	ø8 One-touch fitting	10-SV1000
C4	ø4 One-touch fitting		
C6	ø6 One-touch fitting		
C4	ø4 One-touch fitting	ø10 One-touch fitting	10-SV2000
C6	ø6 One-touch fitting		
C8	ø8 One-touch fitting		
C6	ø6 One-touch fitting	ø12 One-touch fitting	10-SV3000
C8	ø8 One-touch fitting		
C10	ø10 One-touch fitting		
M	Mixed		

A, B port size (Inch)

Symbol	A, B port	P, E port	Applicable series
N3	ø1/8" One-touch fitting	ø5/16" One-touch fitting	10-SV1000
N3	ø5/32" One-touch fitting		
N7	ø1/4" One-touch fitting		
N3	ø5/32" One-touch fitting	ø3/8" One-touch fitting	10-SV2000
N7	ø1/4" One-touch fitting		
N9	ø5/16" One-touch fitting		
N7	ø1/4" One-touch fitting	ø3/8" One-touch fitting	10-SV3000
N9	ø5/16" One-touch fitting		
N11	ø3/8" One-touch fitting		
M	Mixed		

Mounting

Nil	Direct mounting
D	DIN rail mounting (With DIN rail)
D0™	DIN rail mounting (Without DIN rail)
D3	For 3 stations When a longer DIN rail is desired than the specified stations
:	:
D20	For 20 stations (Specify a longer rail than the standard length.)

Note) For D0, only DIN rail mounting bracket is attached.

* For mixed specifications (M), indicate separately on the manifold specification sheet.

* External pilot type (R) X, PE port sizes are ø4 (metric), ø5/32" (inch) for the 10-SV1000/2000 series and ø6 (metric), ø1/4" (inch) for the 10-SV3000 series.

How to Order Valve Manifold Assembly

Ordering example (10-SV1000)

Manifold

10-SS5V1-W10S1QW11ND-05B-C6 (1 set)

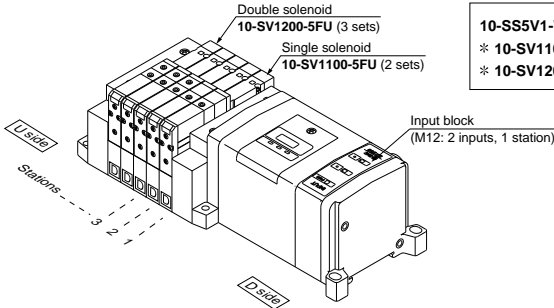

10-SS5V1-W10S1QW11ND-05B-C6.....1 set (Manifold part no.)
 * **10-SV1100-5FU**.....2 sets (Single solenoid part no.)
 * **10-SV1200-5FU**.....3 sets (Double solenoid part no.)

How to Order Solenoid Valve

10 - SV 1 1 00 [] [] - **5 F** [] [] - [] (Note)

Clean series

Series

1	10-SV1000
2	10-SV2000
3	10-SV3000

Actuation type

1	2 position single solenoid
2	2 position double solenoid
3	3 position closed center
4	3 position exhaust center
5	3 position pressure center
A	4 position dual 3 port valve: N.C./N.C.
B	4 position dual 3 port valve: N.O./N.O.
C	4 position dual 3 port valve: N.C./N.O.

* 4 position dual 3 port valves are applicable to the 10-SV1000/10-SV2000 series only.

Pilot type

Nil	Internal pilot
R	External pilot

* External pilot specifications are not available for 4 position dual 3 port valves.

Back pressure check valve

Nil	None
K	Built-in

* The built-in back pressure check valve type is applicable to the 10-SV1000 series only.
 * The product with back pressure check valve is not available for 3 position valves.

Note) Available with manifold block for station additions. Refer to the **WEB catalog**.

Made to Order

Nil	—
X90	Main valve fluororubber (Refer to page 272.)

Manual override

Nil: Non-locking push type	D: Push-turn locking slotted type
----------------------------	-----------------------------------

Light/surge voltage suppressor

U	With light/surge voltage suppressor
R	With surge voltage suppressor

Rated voltage

5	24 VDC
---	--------

Note) Refer to the Specific Product Precautions 2 on page 274.

Directional Control Valves
 Air Cylinders
 Rotary Actuators
 Air Grippers
 Air Preparation Equipment
 Modular F. R.
 Pressure Control Equipment
 Fittings & Tubing
 Flow Control Equipment
 Pressure Switches/ Pressure Sensors

Dimensions: Series 10-SV1000 for EX250 Serial Wiring with Input/Output Unit

• Tie-rod base manifold: 10-SS5V1-W10S1□□□□D-**Stations** $\begin{matrix} U \\ D \\ B \end{matrix}$ (R)- C3, N1 C4, N3 C6, N7 (-D)

- When P, E port outlets are indicated on the U side or D side, the P, E ports on the opposite side are plugged.
 - External pilot port positions are the same as P, E port outlet positions.

(With 2 input blocks)

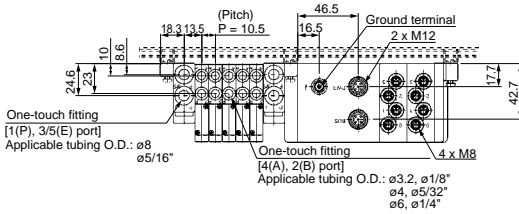

With external pilot specifications

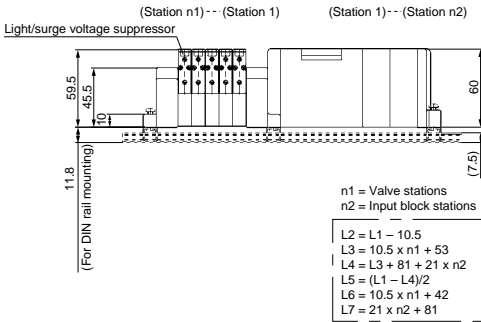
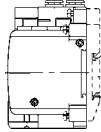
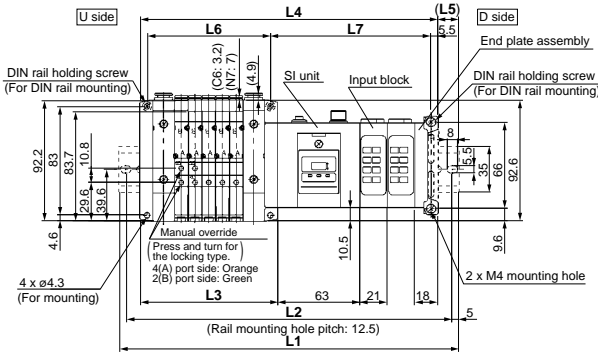
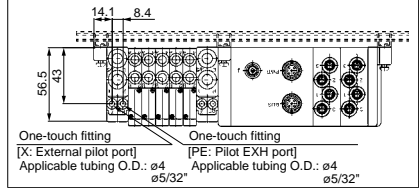

With option

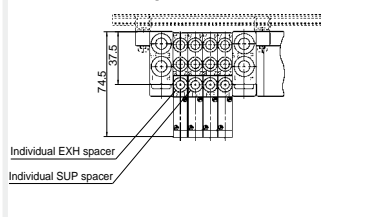

L1: DIN rail overall length

Valve stations (n1) Input block stations (n2)	2	3	4	5	6	7	8	9	10	11	12	13	14	15	16	17	18	19	20
0	185.5	198	210.5	210.5	223	235.5	248	260.5	273	273	285.5	298	310.5	323	335.5	348	348	360.5	373
1	210.5	210.5	223	235.5	248	260.5	273	273	285.5	298	310.5	323	335.5	348	348	360.5	373	385.5	398
2	223	235.5	248	260.5	273	273	285.5	298	310.5	323	335.5	348	348	360.5	373	385.5	398	410.5	410.5
3	248	260.5	273	273	285.5	298	310.5	323	335.5	348	348	360.5	373	385.5	398	410.5	410.5	423	435.5
4	273	273	285.5	298	310.5	323	335.5	348	348	360.5	373	385.5	398	410.5	410.5	423	435.5	448	460.5
5	285.5	298	310.5	323	335.5	348	348	360.5	373	385.5	398	410.5	410.5	423	435.5	448	460.5	473	473
6	310.5	323	335.5	348	348	360.5	373	385.5	398	410.5	410.5	423	435.5	448	460.5	473	473	485.5	498
7	335.5	348	348	360.5	373	385.5	398	410.5	410.5	423	435.5	448	460.5	473	473	485.5	498	510.5	523
8	348	360.5	373	385.5	398	410.5	410.5	423	435.5	448	460.5	473	473	485.5	498	510.5	523	535.5	535.5

Dimensions: Series 10-SV2000 for EX250 Serial Wiring with Input/Output Unit

• Tie-rod base manifold: 10-SS5V2-W10S1□□□□D-**Stations** $\begin{matrix} U \\ D \end{matrix}$ $\begin{matrix} R \\ B \end{matrix}$ (R)-C4, N3
C6, N7
C8, N9 (-D)

(With 2 input blocks)

• When P, E port outlets are indicated on the U side or D side, the P, E ports on the opposite side are plugged.
• External pilot port positions are the same as P, E port outlet positions.

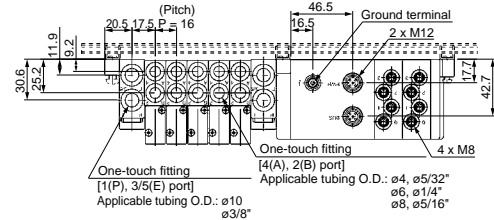

With external pilot specifications

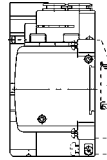
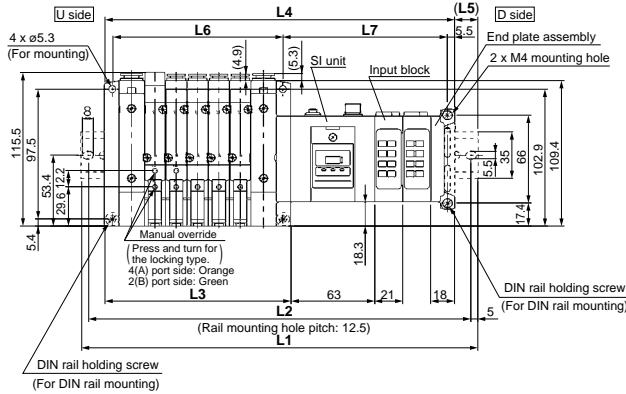
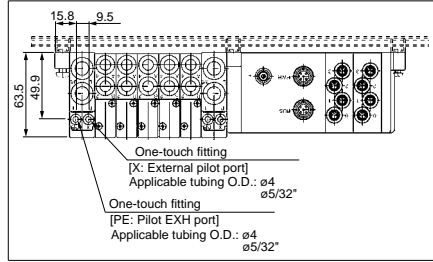

With option

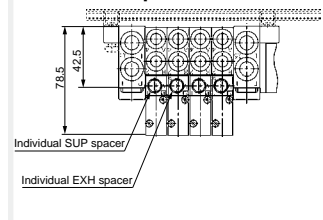

n1 = Valve stations
n2 = Input block stations

L2 = L1 - 10.5
L3 = 16 x n1 + 60
L4 = L3 + 81 + 21 x n2
L5 = (L1 - L4)/2
L6 = 16 x n1 + 48
L7 = 21 x n2 + 81.5

L1: DIN rail overall length

Input block stations (n2)	2	3	4	5	6	7	8	9	10	11	12	13	14	15	16	17	18	19	20
0	198	223	235.5	248	260.5	285.5	298	310.5	335.5	348	360.5	373	398	410.5	423	448	460.5	473	485.5
1	223	235.5	260.5	273	285.5	298	323	335.5	348	373	385.5	398	410.5	435.5	448	460.5	485.5	498	510.5
2	248	260.5	273	298	310.5	323	335.5	360.5	373	385.5	410.5	423	435.5	460.5	473	485.5	498	510.5	535.5
3	260.5	285.5	298	310.5	335.5	348	360.5	373	398	410.5	423	435.5	460.5	473	485.5	510.5	523	535.5	548
4	285.5	298	323	335.5	348	360.5	385.5	398	410.5	435.5	448	460.5	473	498	510.5	523	548	560.5	573
5	310.5	323	335.5	360.5	373	385.5	398	423	435.5	448	473	485.5	498	510.5	535.5	548	560.5	585.5	598
6	323	348	360.5	373	398	410.5	423	435.5	460.5	473	485.5	510.5	523	535.5	548	573	585.5	598	610.5
7	348	360.5	385.5	398	410.5	435.5	448	460.5	473	498	510.5	523	535.5	560.5	573	585.5	610.5	623	635.5
8	373	385.5	398	423	435.5	448	460.5	485.5	498	510.5	535.5	548	560.5	573	598	610.5	623	648	660.5

Directional Control Valves
Air Cylinders
Rotary Actuators
Air Grippers
Air Preparation Equipment
Modular F. R.
Pressure Control Equipment
Fittings & Tubing
Flow Control Equipment
Pressure Switches/Pressure Sensors

Dimensions: Series 10-SV3000 for EX250 Serial Wiring with Input/Output Unit

• Tie-rod base manifold: 10-SS5V3-W10S1□□□□D-^U_D B (R)- C6, N7 C8, N9 C10, N11 (-)D

(With 2 input blocks)

- When P, E port outlets are indicated on the U side or D side, the P, E ports on the opposite side are plugged.
- External pilot port positions are the same as P, E port outlet positions.

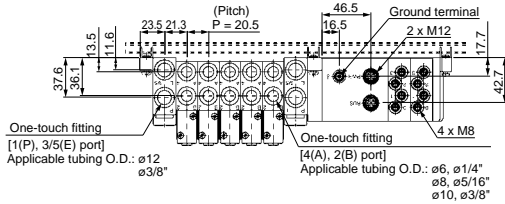

With external pilot specifications

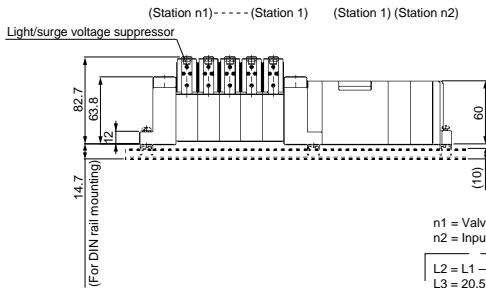
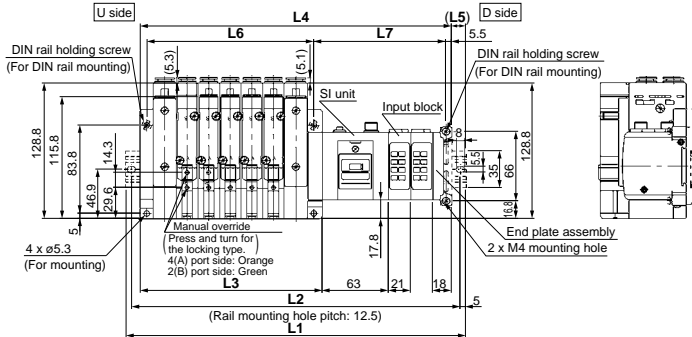
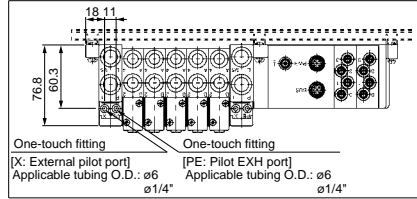

n1 = Valve stations
n2 = Input block stations

$$L2 = L1 - 10.5$$

$$L3 = 20.5 \times n1 + 70.5$$

$$L4 = L3 + 81 + 21 \times n2$$

$$L5 = (L1 - L4) / 2$$

$$L6 = 20.5 \times n1 + 56$$

$$L7 = 21 \times n2 + 83.5$$

With option

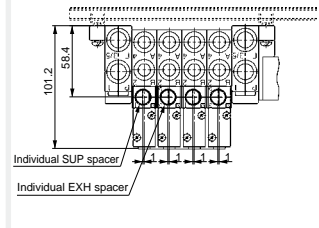

L1: DIN rail overall length

Valve stations (n1) Input block stations (n2)	2	3	4	5	6	7	8	9	10	11	12	13	14	15	16	17	18	19	20
0	223	248	260.5	285.5	298	323	348	360.5	385.5	410.5	423	448	473	485.5	510.5	535.5	548	573	585.5
1	248	260.5	285.5	310.5	323	348	360.5	385.5	410.5	423	448	473	485.5	510.5	535.5	548	573	585.5	610.5
2	260.5	285.5	310.5	323	348	360.5	385.5	410.5	423	448	473	485.5	510.5	535.5	548	573	598	610.5	635.5
3	285.5	310.5	323	348	373	385.5	410.5	423	448	473	485.5	510.5	535.5	548	573	598	610.5	635.5	648
4	310.5	323	348	373	385.5	410.5	423	448	473	485.5	510.5	535.5	548	573	598	610.5	635.5	660.5	673
5	323	348	373	385.5	410.5	435.5	448	473	485.5	510.5	535.5	548	573	598	610.5	635.5	660.5	673	698
6	348	373	385.5	410.5	435.5	448	473	485.5	510.5	535.5	548	573	598	610.5	635.5	660.5	673	698	723
7	373	385.5	410.5	435.5	448	473	498	510.5	535.5	548	573	598	610.5	635.5	660.5	673	698	723	735.5
8	385.5	410.5	435.5	448	473	498	510.5	535.5	548	573	598	610.5	635.5	660.5	673	698	723	735.5	760.5

Integrated Type (For Input/Output) Serial Transmission System

Series **EX600**

IP67 compliant

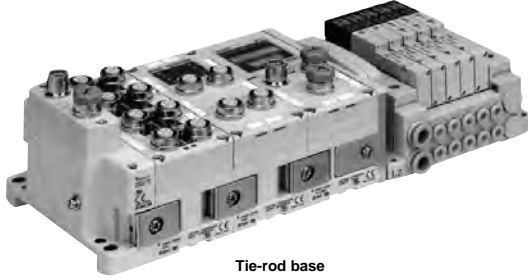

Tie-rod base

Applicable series	Tie-rod base manifold 10-SV1000/10-SV2000/10-SV3000
	<ul style="list-style-type: none">· Digital inputs/outputs: Max. 144/144· Analog input: Max. 18 channels· Number of valve outputs: 32

Directional
Control Valves

Air Cylinders

Rotary Actuators

Air Grippers

Air Preparation
Equipment

Modular F. R.

Pressure Control
Equipment

Fittings & Tubing

Flow Control
Equipment

Pressure Switches/
Pressure Sensors

Series 10-SV

EX600 Integrated-type (For Input/Output) Serial Transmission System



When I/O Unit EX600-D□□E or EX600-D□□F are selected, enclosure is IP40.
For details, refer to the **WEB catalog**.

How to Order Manifold

● Tie-rod base

10-SS5V **1** - **10S6** **Q** **□** **□** **□** **□** **D-05** **U** **□** - **C6** - **□**

Series

1	10-SV1000
2	10-SV2000
3	10-SV3000

Enclosure

Nil	IP40
W	IP67

SI Unit

0	Without SI Unit
Q	DeviceNet™
N	PROFIBUS DP
V	CC-Link
ZE	EtherNet/IP™
D	EtherCAT

- When "Without SI Unit" is specified, I/O Unit cannot be mounted.
- When "Without SI Unit" is specified, a valve plate which connects the valve manifold and SI Unit, is not mounted. Refer to the **WEB catalog** for mounting method.

End plate type

Nil	No end plate
2	Power supply with M12 connector (Max. supplied current 2 A)
3	Power supply with 7/8 inch connector (Max. supplied current 8 A)

Note) The symbol is nil for no SI Unit.

SI Unit common

Nil	Positive common
N	Negative common

Note) The symbol is nil for no SI Unit.

I/O Unit stations

Nil	None
1	1 station
⋮	⋮
9	9 stations

- Note 1) The symbol is nil for no SI Unit.
 Note 2) SI Unit is not included in I/O Unit stations.
 Note 3) When I/O Unit is selected, it is shipped separately and assembled by users. Refer to the attached operation manual for mounting method.

Valve stations

Symbol	Stations	Note
02	2 stations	Double wiring ^{Note 1)}
⋮	⋮	
16	16 stations	
02	2 stations	Specified layout ^{Note 2)} (Available up to 32 solenoids)
⋮	⋮	
20	20 stations	

- Note 1) Double wiring: Single, double, 3-position and 4-position valves can be used on all manifold stations.
 Use of a single solenoid will result in an unused control signal. If this is not desired, order with a specified layout.
 Note 2) Specified layout: Indicate the wiring specifications on the manifold specification sheet. (Note that double, 3-position and 4-position valves cannot be used where single wiring has been specified.)

A, B port size (Metric)

Symbol	A, B port	P, E port	Applicable series
C3	ø3.2 One-touch fitting	ø8 One-touch fitting	10-SV1000
C4	ø4 One-touch fitting		
C6	ø6 One-touch fitting		
C4	ø4 One-touch fitting	ø10 One-touch fitting	10-SV2000
C6	ø6 One-touch fitting		
C8	ø8 One-touch fitting		
C6	ø6 One-touch fitting		
C8	ø8 One-touch fitting		
C10	ø10 One-touch fitting		
M	Mixed	ø12 One-touch fitting	10-SV3000

A, B port size (Inch)

Symbol	A, B port	P, E port	Applicable series
N1	ø1/8" One-touch fitting	ø5/16" One-touch fitting	10-SV1000
N3	ø5/32" One-touch fitting		
N7	ø1/4" One-touch fitting		
N3	ø5/32" One-touch fitting	ø3/8" One-touch fitting	10-SV2000
N7	ø1/4" One-touch fitting		
N9	ø5/16" One-touch fitting		
N7	ø1/4" One-touch fitting		
N9	ø5/16" One-touch fitting		
N11	ø3/8" One-touch fitting		
M	Mixed	ø3/8" One-touch fitting	10-SV3000

* For mixed specifications (M), indicate separately on the manifold specification sheet.

* External pilot type (R) X, PE port sizes are ø4 (mm) or ø5/32" (inch) for the 10-SV1000/2000 series, and ø6 (mm) or ø1/4" (inch) for the 10-SV3000 series.

Dimensions: Series 10-SV1000

Power supply with M12 connector

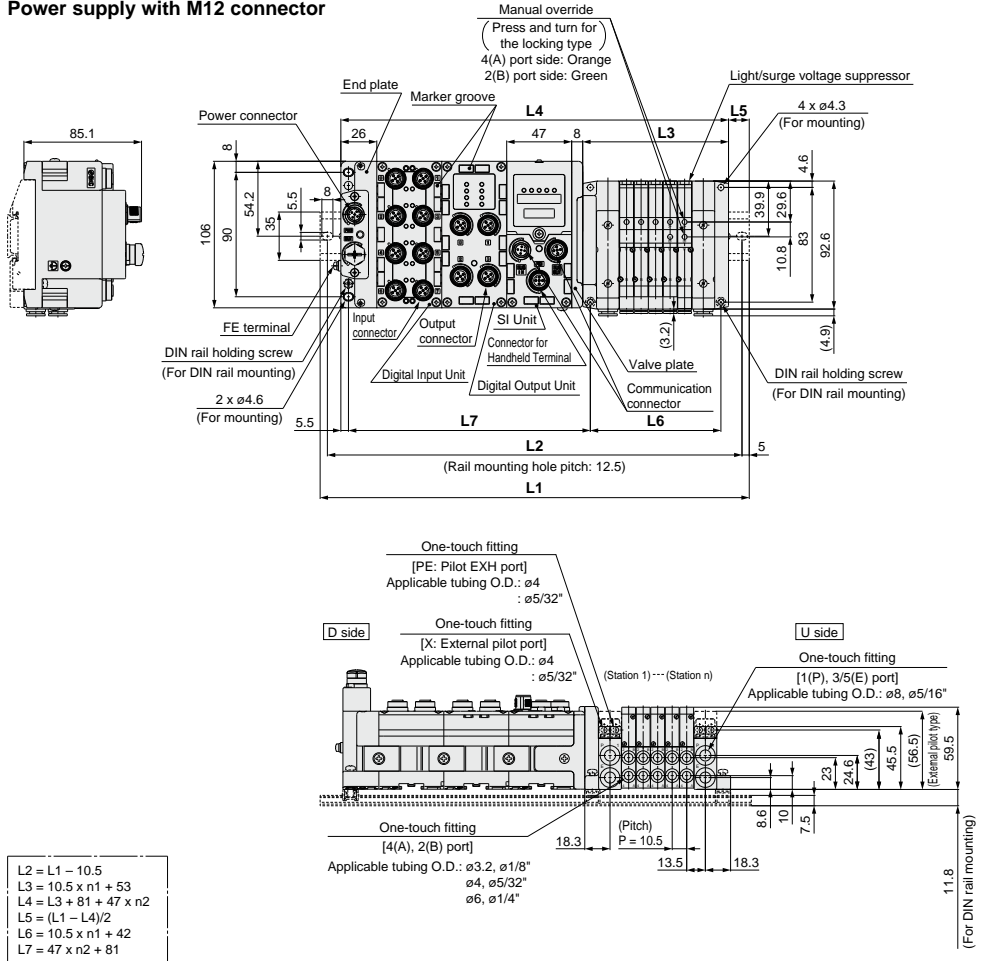

L1: DIN Rail Overall Length

I/O Unit stations (n2) \ Valve stations (n1)	2	3	4	5	6	7	8	9	10	11	12	13	14	15	16	17	18	19	20
0	185.5	198	210.5	210.5	223	235.5	248	260.5	273	273	285.5	298	310.5	323	335.5	348	348	360.5	373
1	235.5	248	248	260.5	273	285.5	298	310.5	310.5	323	335.5	348	360.5	373	373	385.5	398	410.5	423
2	273	285.5	298	310.5	323	335.5	335.5	348	360.5	373	385.5	398	410.5	410.5	423	435.5	448	460.5	473
3	323	335.5	348	360.5	373	373	385.5	398	410.5	423	435.5	435.5	448	460.5	473	485.5	498	498	510.5
4	373	385.5	398	398	410.5	423	435.5	448	460.5	473	473	485.5	498	510.5	523	535.5	548	548	560.5
5	423	435.5	435.5	448	460.5	473	485.5	498	498	510.5	523	535.5	548	560.5	560.5	573	585.5	598	610.5
6	460.5	473	485.5	498	510.5	523	535.5	535.5	548	560.5	573	585.5	598	598	610.5	623	635.5	648	660.5
7	510.5	523	535.5	548	560.5	560.5	573	585.5	598	610.5	623	623	635.5	648	660.5	673	685.5	698	698
8	560.5	573	585.5	598	598	610.5	623	635.5	648	660.5	660.5	673	685.5	698	710.5	723	723	735.5	748
9	610.5	623	623	635.5	648	660.5	673	685.5	685.5	698	710.5	723	735.5	748	760.5	760.5	773	785.5	798

Dimensions: Series 10-SV1000

Power supply with 7/8 inch connector

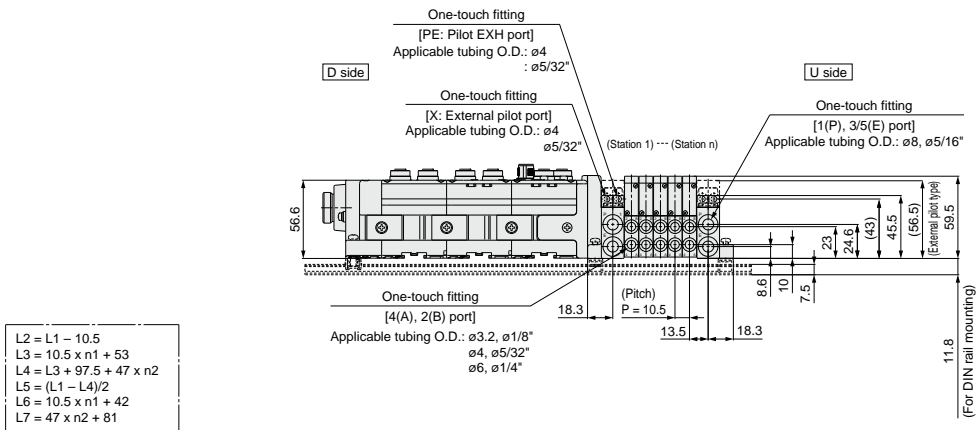
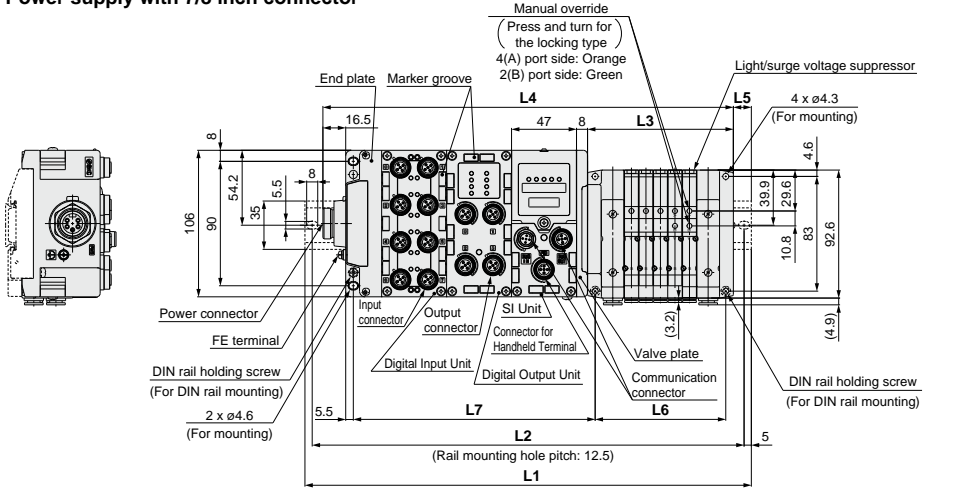

- L2 = L1 - 10.5
- L3 = 10.5 x n1 + 53
- L4 = L3 + 97.5 + 47 x n2
- L5 = (L1 - L4) / 2
- L6 = 10.5 x n1 + 42
- L7 = 47 x n2 + 81

L1: DIN Rail Overall Length

I/O Unit stations (n2)	Valve stations (n1)	2	3	4	5	6	7	8	9	10	11	12	13	14	15	16	17	18	19	20
0		198	210.5	223	235.5	248	248	260.5	273	285.5	298	310.5	323	335.5	348	360.5	373	385.5	385.5	385.5
1		248	260.5	273	285.5	285.5	298	310.5	323	335.5	348	360.5	373	385.5	398	410.5	410.5	423	435.5	435.5
2		298	310.5	310.5	323	335.5	348	360.5	373	373	385.5	398	410.5	423	435.5	448	448	460.5	473	485.5
3		348	348	360.5	373	385.5	398	410.5	410.5	423	435.5	448	460.5	473	473	485.5	498	510.5	523	535.5
4		385.5	398	410.5	423	435.5	448	460.5	473	485.5	498	510.5	510.5	523	535.5	548	560.5	573	573	573
5		435.5	448	460.5	473	473	485.5	498	510.5	523	535.5	535.5	548	560.5	573	585.5	598	598	610.5	623
6		485.5	498	498	510.5	523	535.5	548	560.5	573	573	585.5	598	610.5	623	635.5	635.5	648	660.5	673
7		535.5	535.5	548	560.5	573	585.5	598	598	610.5	623	635.5	648	660.5	660.5	673	685.5	698	710.5	723
8		573	585.5	598	610.5	623	635.5	635.5	648	660.5	673	685.5	698	698	710.5	723	735.5	748	760.5	760.5
9		623	635.5	648	660.5	660.5	673	685.5	698	710.5	723	723	735.5	748	760.5	773	785.5	798	798	810.5

Directional Control Valves
Air Cylinders
Rotary Actuators
Air Grippers
Air Preparation Equipment
Modular F. R.
Pressure Control Equipment
Fittings & Tubing
Flow Control Equipment
Pressure Switches/ Pressure Sensors

Dimensions: Series 10-SV2000

Power supply with M12 connector

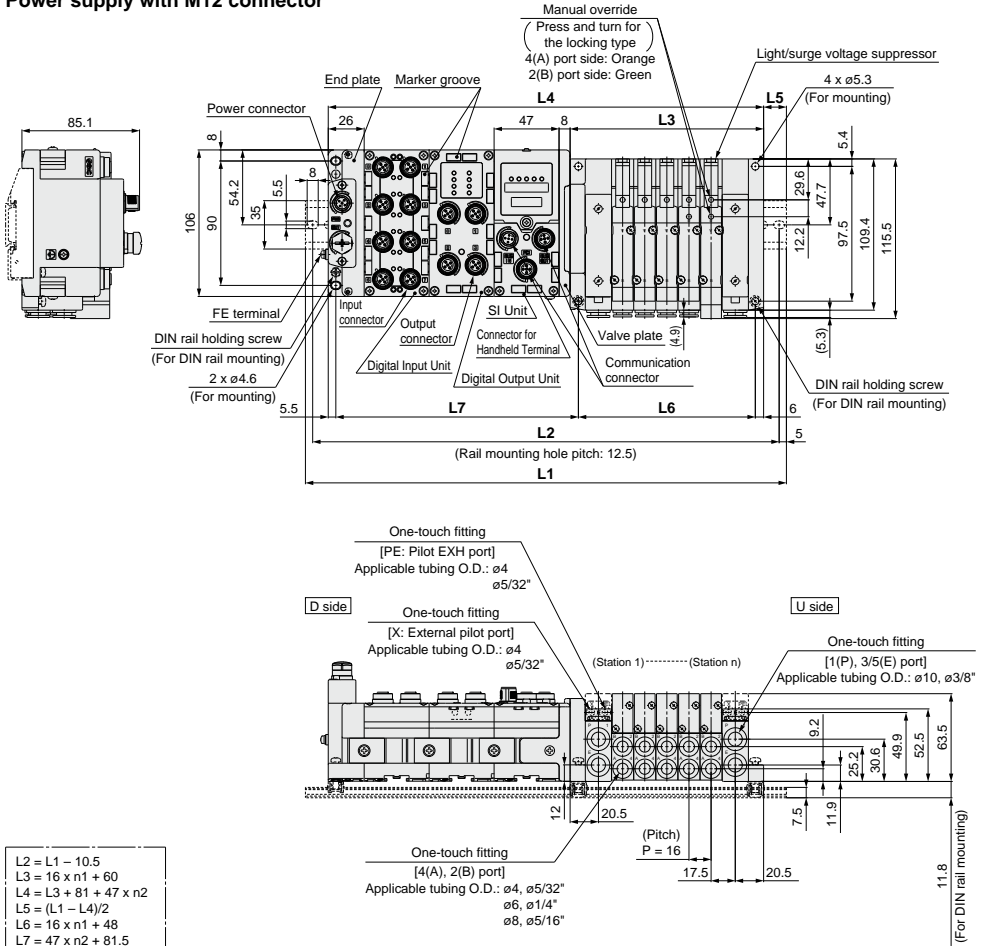

L1: DIN Rail Overall Length

I/O Unit stations (n2) \ Valve stations (n1)	2	3	4	5	6	7	8	9	10	11	12	13	14	15	16	17	18	19	20
0	198	223	235.5	248	260.5	285.5	298	310.5	335.5	348	360.5	373	398	410.5	423	448	460.5	473	485.5
1	248	260.5	285.5	298	310.5	335.5	348	360.5	373	398	410.5	423	435.5	460.5	473	485.5	510.5	523	535.5
2	298	310.5	323	348	360.5	373	398	410.5	423	435.5	460.5	473	485.5	510.5	523	535.5	548	573	585.5
3	348	360.5	373	385.5	410.5	423	435.5	460.5	473	485.5	498	523	535.5	548	573	585.5	598	610.5	635.5
4	385.5	410.5	423	435.5	460.5	473	485.5	498	523	535.5	548	560.5	585.5	598	610.5	635.5	648	660.5	673
5	435.5	448	473	485.5	498	523	535.5	548	560.5	585.5	598	610.5	635.5	648	660.5	673	698	710.5	723
6	485.5	498	510.5	535.5	548	560.5	585.5	598	610.5	623	648	660.5	673	698	710.5	723	735.5	760.5	773
7	535.5	548	560.5	585.5	598	610.5	623	648	660.5	673	685.5	710.5	723	735.5	760.5	773	785.5	798	823
8	573	598	610.5	623	648	660.5	673	685.5	710.5	723	735.5	760.5	773	785.5	798	823	835.5	848	860.5
9	623	635.5	660.5	673	685.5	710.5	723	735.5	748	773	785.5	798	823	835.5	848	860.5	885.5	898	910.5

Dimensions: Series 10-SV2000

Power supply with 7/8 inch connector

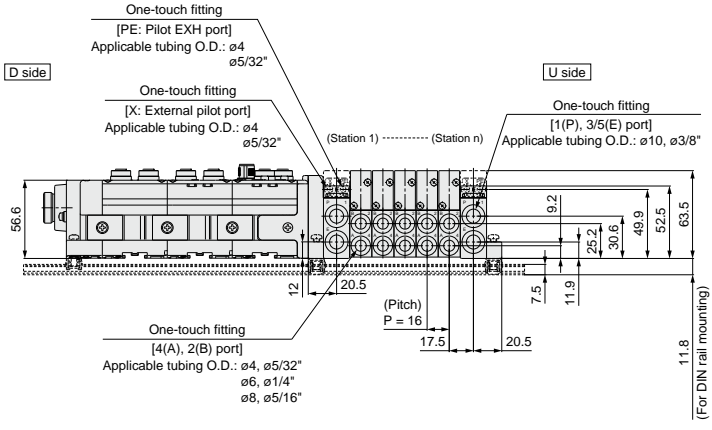
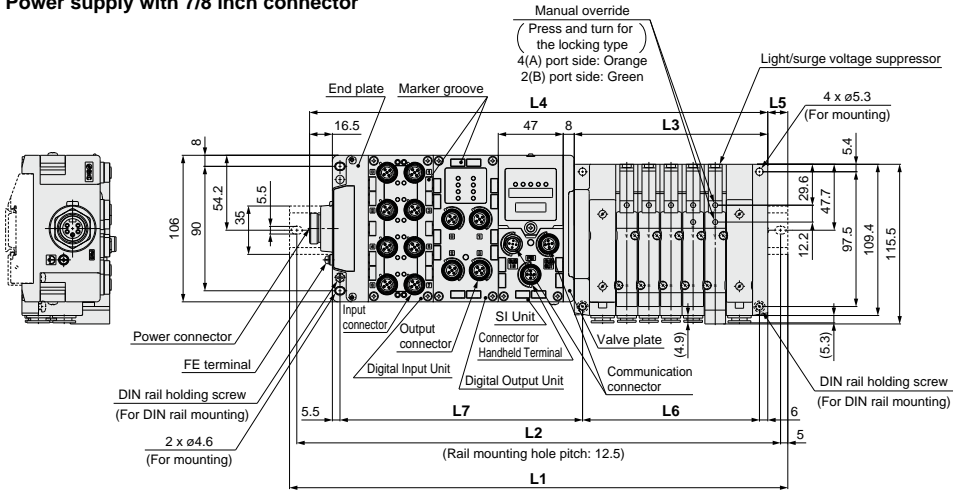

- L2 = L1 - 10.5
- L3 = 16 x n1 + 60
- L4 = L3 + 97.5 + 47 x n2
- L5 = (L1 - L4)/2
- L6 = 16 x n1 + 48
- L7 = 47 x n2 + 81.5

L1: DIN Rail Overall Length

I/O Unit stations (n2) \ Valve stations (n1)	2	3	4	5	6	7	8	9	10	11	12	13	14	15	16	17	18	19	20
0	223	235.5	248	273	285.5	298	310.5	335.5	348	360.5	373	398	410.5	423	448	460.5	473	485.5	510.5
1	260.5	285.5	298	310.5	335.5	348	360.5	373	398	410.5	423	448	460.5	473	485.5	510.5	523	535.5	548
2	310.5	323	348	360.5	373	398	410.5	423	435.5	460.5	473	485.5	510.5	523	535.5	548	573	585.5	598
3	360.5	373	398	410.5	423	435.5	460.5	473	485.5	498	523	535.5	548	573	585.5	598	610.5	635.5	648
4	410.5	423	435.5	460.5	473	485.5	498	523	535.5	548	573	585.5	598	610.5	635.5	648	660.5	673	698
5	448	473	485.5	498	523	535.5	548	560.5	585.5	598	610.5	635.5	648	660.5	673	698	710.5	723	748
6	498	523	535.5	548	560.5	585.5	598	610.5	623	648	660.5	673	698	710.5	723	735.5	760.5	773	785.5
7	548	560.5	585.5	598	610.5	623	648	660.5	673	698	710.5	723	735.5	760.5	773	785.5	798	823	835.5
8	598	610.5	623	648	660.5	673	685.5	710.5	723	735.5	760.5	773	785.5	798	823	835.5	848	873	885.5
9	648	660.5	673	685.5	710.5	723	735.5	748	773	785.5	798	823	835.5	848	860.5	885.5	898	910.5	935.5

Directional Control Valves
Air Cylinders
Rotary Actuators
Air Grippers
Air Preparation Equipment
Modular F. R.
Pressure Control Equipment
Fittings & Tubing
Flow Control Equipment
Pressure Switches/ Pressure Sensors

Dimensions: Series 10-SV3000

Power supply with M12 connector

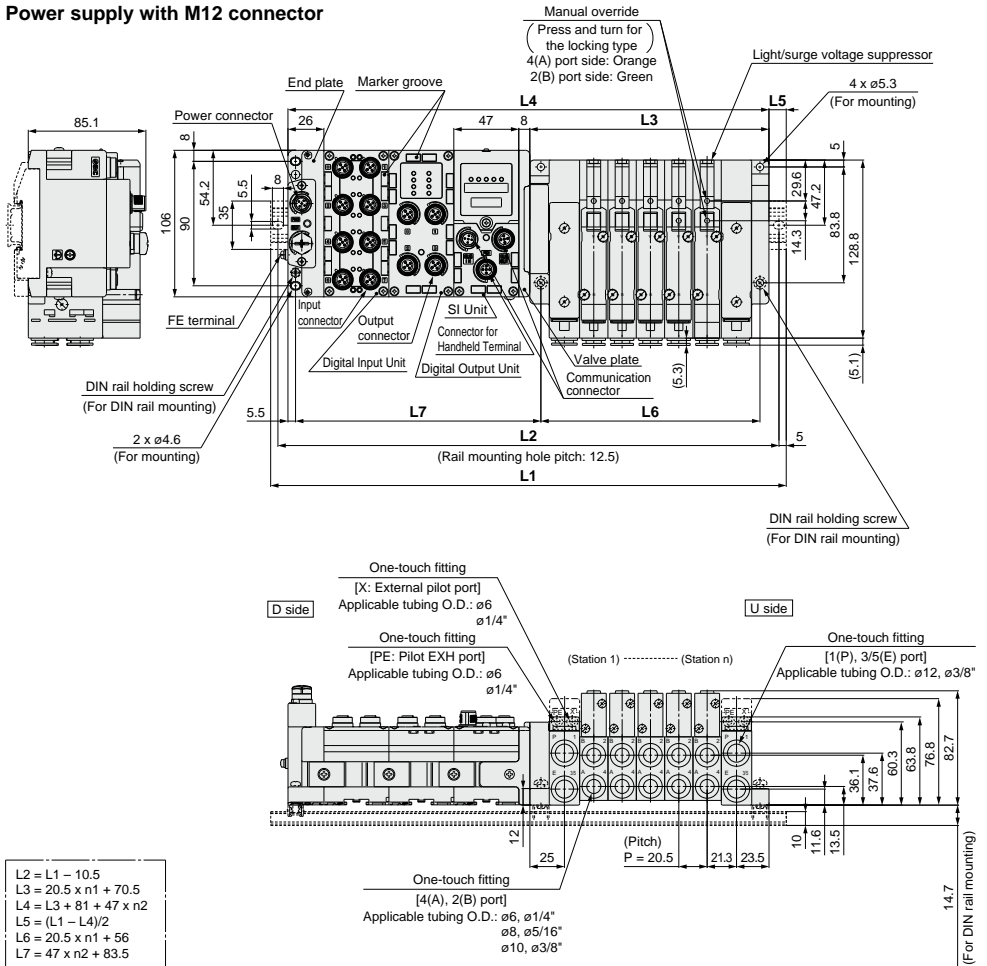

L1: DIN Rail Overall Length

I/O Unit stations (n2) \ Valve stations (n1)	2	3	4	5	6	7	8	9	10	11	12	13	14	15	16	17	18	19	20
0	223	248	260.5	285.5	298	323	348	360.5	385.5	410.5	423	448	473	485.5	510.5	535.5	548	573	585.5
1	273	285.5	310.5	335.5	348	373	398	410.5	435.5	448	473	498	510.5	535.5	560.5	573	598	623	635.5
2	310.5	335.5	360.5	373	398	423	448	460.5	485.5	510.5	523	548	573	585.5	610.5	635.5	648	673	685.5
3	360.5	385.5	398	423	448	460.5	485.5	510.5	523	548	573	585.5	610.5	635.5	648	673	685.5	710.5	735.5
4	410.5	435.5	448	473	498	510.5	535.5	548	573	598	610.5	635.5	660.5	673	698	723	735.5	760.5	773
5	460.5	473	498	523	535.5	560.5	585.5	598	623	635.5	660.5	685.5	698	723	748	760.5	785.5	810.5	823
6	498	523	548	560.5	585.5	610.5	623	648	673	685.5	710.5	735.5	748	773	785.5	810.5	835.5	848	873
7	548	573	598	610.5	635.5	648	673	698	710.5	735.5	760.5	773	798	823	835.5	860.5	873	898	923
8	598	623	635.5	660.5	685.5	698	723	735.5	760.5	785.5	798	823	848	860.5	885.5	910.5	923	948	973
9	648	660.5	685.5	710.5	723	748	773	785.5	810.5	835.5	848	873	885.5	910.5	935.5	948	973	—	—

Dimensions: Series 10-SV3000

Power supply with 7/8 inch connector

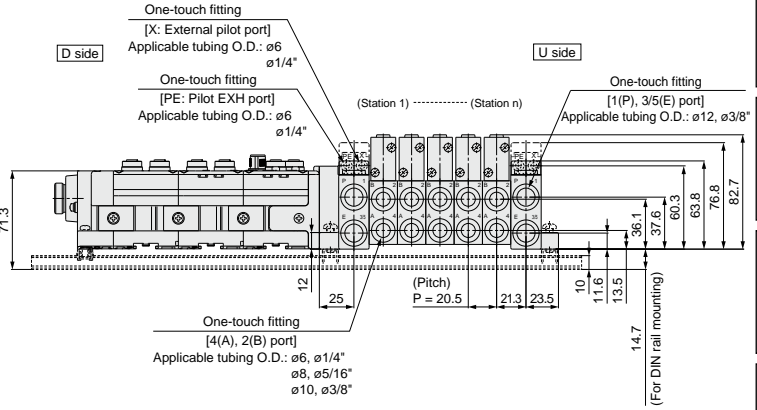
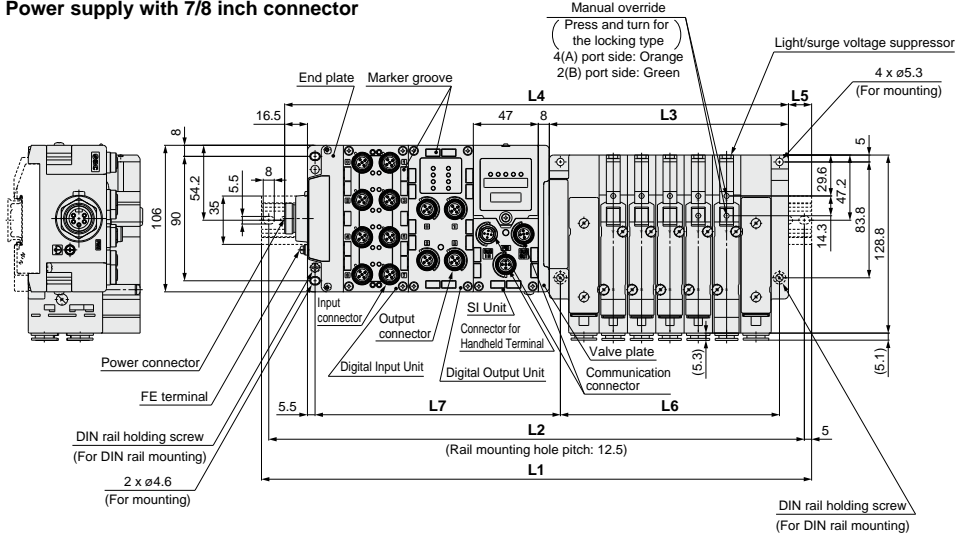

- L2 = L1 - 10.5
- L3 = 20.5 x n1 + 70.5
- L4 = L3 + 97.5 + 47 x n2
- L5 = (L1 - L4)/2
- L6 = 20.5 x n1 + 56
- L7 = 47 x n2 + 83.5

L1: DIN Rail Overall Length

I/O Unit stations (n2) \ Valve stations (n1)	2	3	4	5	6	7	8	9	10	11	12	13	14	15	16	17	18	19	20
0	235.5	260.5	285.5	298	323	335.5	360.5	385.5	398	423	448	460.5	485.5	510.5	523	548	560.5	585.5	610.5
1	285.5	310.5	323	348	373	385.5	410.5	423	448	473	485.5	510.5	535.5	548	573	598	610.5	635.5	660.5
2	335.5	348	373	398	410.5	435.5	460.5	473	498	523	535.5	560.5	573	598	623	635.5	660.5	685.5	698
3	385.5	398	423	435.5	460.5	485.5	498	523	548	560.5	585.5	610.5	623	648	660.5	685.5	710.5	723	748
4	423	448	473	485.5	510.5	523	548	573	585.5	610.5	635.5	648	673	698	710.5	735.5	760.5	773	798
5	473	498	510.5	535.5	560.5	573	598	623	635.5	660.5	673	698	723	735.5	760.5	785.5	798	823	848
6	523	535.5	560.5	585.5	598	623	648	660.5	685.5	710.5	723	748	760.5	785.5	810.5	823	848	873	885.5
7	573	585.5	610.5	623	648	673	685.5	710.5	735.5	748	773	798	810.5	835.5	860.5	873	898	910.5	935.5
8	610.5	635.5	660.5	673	698	723	735.5	760.5	773	798	823	835.5	860.5	885.5	898	923	948	960.5	985.5
9	660.5	685.5	698	723	748	760.5	785.5	810.5	823	848	860.5	885.5	910.5	923	948	973	985.5	—	—

Directional Control Valves
 Air Cylinders
 Rotary Actuators
 Air Grippers
 Air Preparation Equipment
 Modular F. R.
 Pressure Control Equipment
 Fittings & Tubing
 Flow Control Equipment
 Pressure Switches/ Pressure Sensors

Dedicated Output Serial Wiring

Series *EX120*



Applicable series	Cassette base manifold 10-SV1000/10-SV2000
	Tie-rod base manifold 10-SV1000/10-SV2000/10-SV3000/10-SV4000
· Number of outputs: 16	

Directional Control Valves

Air Cylinders

Rotary Actuators

Air Grippers

Air Preparation Equipment

Modular F. R.

Pressure Control Equipment

Fittings & Tubing

Flow Control Equipment

Pressure Switches/ Pressure Sensors

Series 10-SV

EX120 Dedicated Output Serial Wiring

How to Order

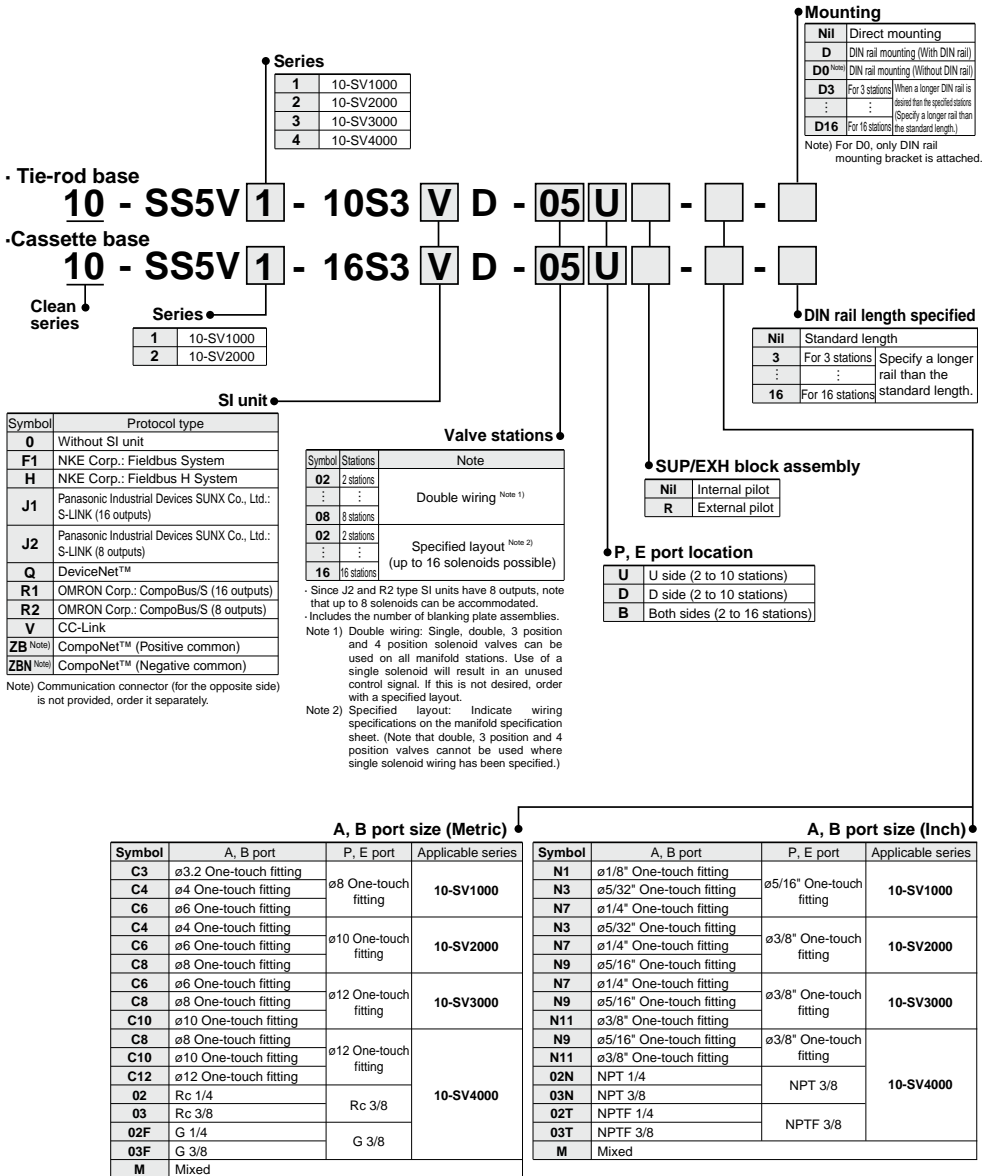

How to Order Valve Manifold Assembly

Ordering example (10-SV1000)

Manifold

10-SS5V1-16S3VD-06B-C6 (1 set)

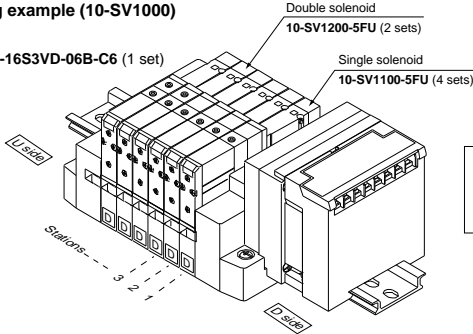

10-SS5V1-16S3VD-06B-C6.....1 set (Manifold part no.)
 * 10-SV1100-5FU.....4 sets (Single solenoid part no.)
 * 10-SV1200-5FU.....2 sets (Double solenoid part no.)

How to Order Solenoid Valve

10 - SV 1 1 0 0 - 5 F - - - - (Note)

Clean series

Series

1	10-SV1000
2	10-SV2000
3	10-SV3000
4	10-SV4000

Actuation type

1	2 position single solenoid
2	2 position double solenoid
3	3 position closed center
4	3 position exhaust center
5	3 position pressure center
A	4 position dual 3 port valve: N.C./N.C.
B	4 position dual 3 port valve: N.O./N.O.
C	4 position dual 3 port valve: N.C./N.O.

* 4 position dual 3 port valves are applicable to the 10-SV1000 and 10-SV2000 series only.

Pilot type

Nil	Internal pilot
R	External pilot

* External pilot specifications are not available for 4 position dual 3 port valves.

Back pressure check valve

Nil	None
K	Built-in

* The built-in back pressure check valve type is applicable to the 10-SV1000 series only.
 * The product with back pressure check valve is not available for 3 position solenoid valves.

Rated voltage

5	24 VDC
---	--------

Manual override

Nil: Non-locking push type	D: Push-turn locking slotted type
----------------------------	-----------------------------------

Light/surge voltage suppressor

U	With light/surge voltage suppressor
R	With surge voltage suppressor

Made to Order

Nil	-
X90	Main valve fluororubber (Refer to page 272.)

Note) Available with manifold block for station additions. Refer to the **WEB catalog**.

Note) Refer to the Specific Product Precautions 2 on page 274.

Directional Control Valves
 Air Cylinders
 Rotary Actuators
 Air Grippers
 Air Preparation Equipment
 Modular F. R.
 Pressure Control Equipment
 Fittings & Tubing
 Flow Control Equipment
 Pressure Switches/ Pressure Sensors

Dimensions: Series 10-SV1000 for EX120 Dedicated Output Serial Wiring

- **Cassette base manifold: 10-SS5V1-16S3** □ **D- Stations** U
D (R)
B C3, N1
C4, N3
C6, N7

• When P, E port outlets are indicated on the U side or D side, the P, E ports on the opposite side are plugged.
 • External pilot port positions are the same as P, E port outlet positions.

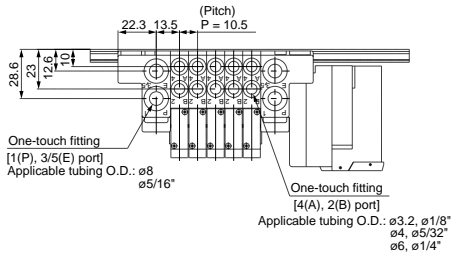

With external pilot specifications

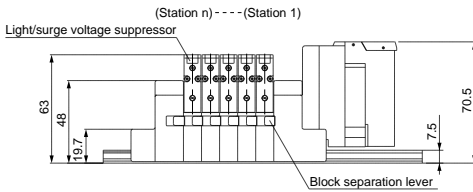
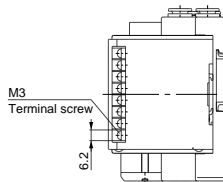
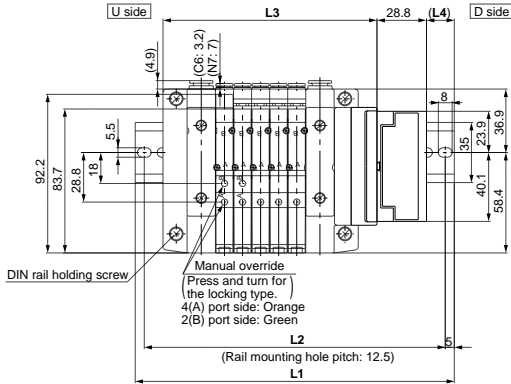
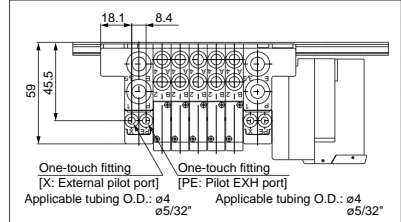

With option

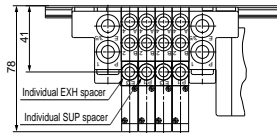

L Dimension

L	n: Stations															
	2	3	4	5	6	7	8	9	10	11	12	13	14	15	16	
L1	148	160.5	173	185.5	198	198	210.5	223	235.5	248	260.5	260.5	273	285.5	298	
L2	137.5	150	162.5	175	187.5	187.5	200	212.5	225	237.5	250	250	262.5	275	287.5	
L3	92.9	103.4	113.9	124.4	134.9	145.4	155.9	166.4	176.9	187.4	197.9	208.4	218.9	229.4	239.9	
L4	13	14	15	16	17	12	13	14	15	16	17	11.5	12.5	13.5	14.5	

Dimensions: Series 10-SV2000 for EX120 Dedicated Output Serial Wiring

- **Cassette base manifold: 10-SS5V2-16S3□D-(Stations) U D (R)**
 - C4, N3
 - C6, N7
 - C8, N9

•When P, E port outlets are indicated on the U side or D side, the P, E ports on the opposite side are plugged.
 •External pilot port positions are the same as P, E port outlet positions.

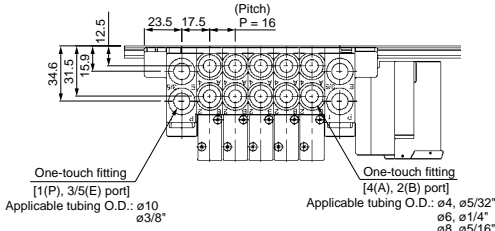

With external pilot specifications

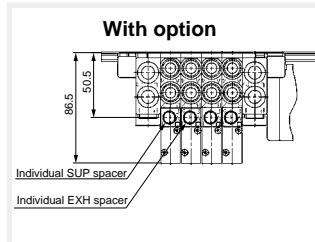
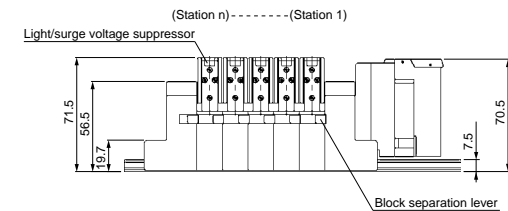
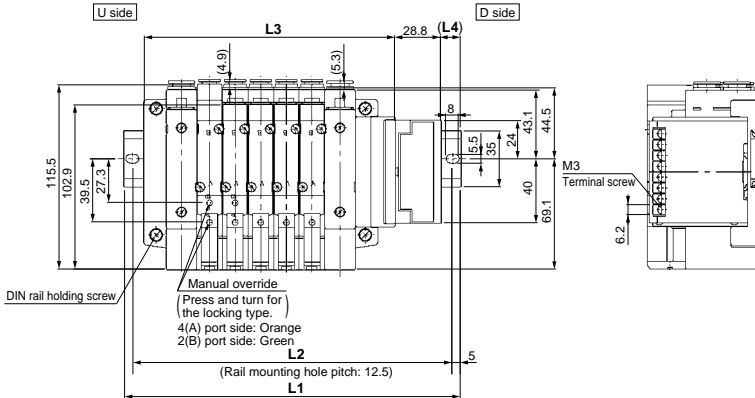
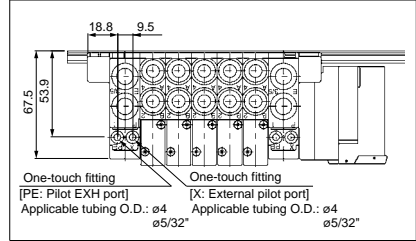

L Dimension

L Dimension	2	3	4	5	6	7	8	9	10	11	12	13	14	15	16
L1	173	185.5	198	210.5	235.5	248	260.5	273	298	310.5	323	348	360.5	373	385.5
L2	162.5	175	187.5	200	225	237.5	250	262.5	287.5	300	312.5	337.5	350	362.5	375
L3	108.9	124.9	140.9	156.9	172.9	188.9	204.9	220.9	236.9	252.9	268.9	284.9	300.9	316.9	332.9
L4	17.5	16	14	12.5	17	15	13.5	11.5	16	14.5	12.5	17	15.5	13.5	12

n: Stations

Dimensions: Series 10-SV1000 for EX120 Dedicated Output Serial Wiring

- Tie-rod base manifold: 10-SS5V1-10S3□D-(Stations) $\frac{U}{B}$ (R) - $\begin{matrix} C3, N1 \\ C4, N3 \\ C6, N7 \end{matrix}$ (-D)

•When P, E port outlets are indicated on the U side or D side, the P, E ports on the opposite side are plugged.
 •External pilot port positions are the same as P, E port outlet positions.

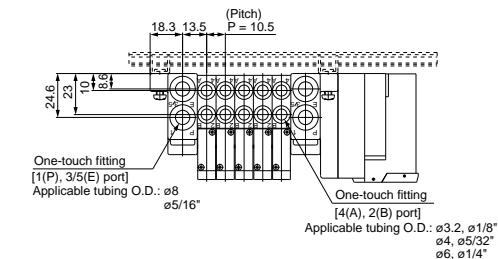

With external pilot specifications

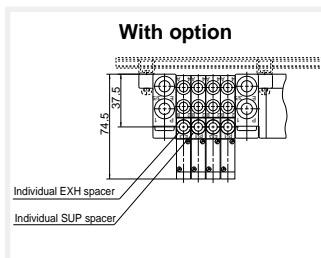
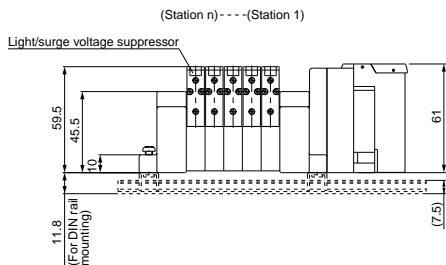
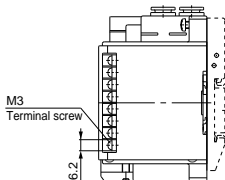
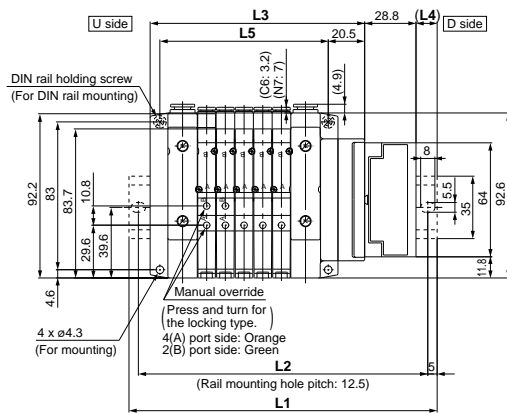
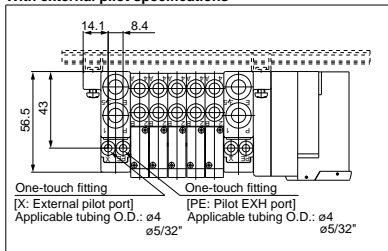

L Dimension

L _n	2	3	4	5	6	7	8	9	10	11	12	13	14	15	16
L1	148	160.5	173	173	185.5	198	210.5	223	235.5	235.5	248	260.5	273	285.5	298
L2	137.5	150	162.5	162.5	175	187.5	200	212.5	225	225	237.5	250	262.5	275	287.5
L3	89	99.5	110	120.5	131	141.5	152	162.5	173	183.5	194	204.5	215	225.5	236
L4	15	16	17	12	13	14	15	16	17	11.5	12.5	13.5	14.5	15.5	16.5
L5	63	73.5	84	94.5	105	115.5	126	136.5	147	157.5	168	178.5	189	199.5	210

n: Stations

Dimensions: Series 10-SV2000 for EX120 Dedicated Output Serial Wiring

• Tie-rod base manifold: 10-SS5V2-10S3□D-**Stations** $\begin{matrix} U \\ D \end{matrix}$ (R) $\begin{matrix} C4, N3 \\ C6, N7 \\ C8, N9 \end{matrix}$ (-D)

- When P, E port outlets are indicated on the U side or D side, the P, E ports on the opposite side are plugged.
- External pilot port positions are the same as P, E port outlet positions.

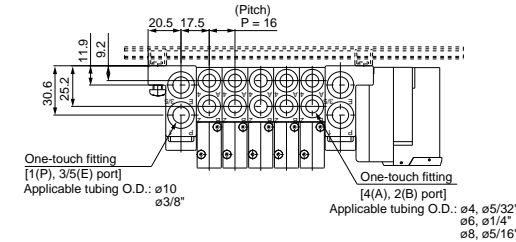

With external pilot specifications

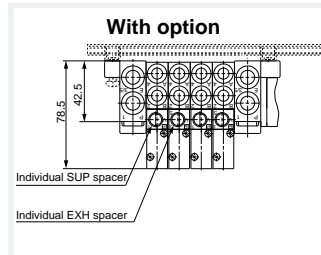
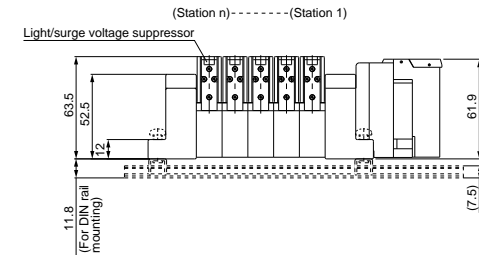
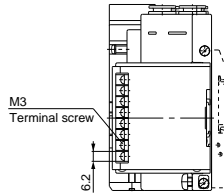
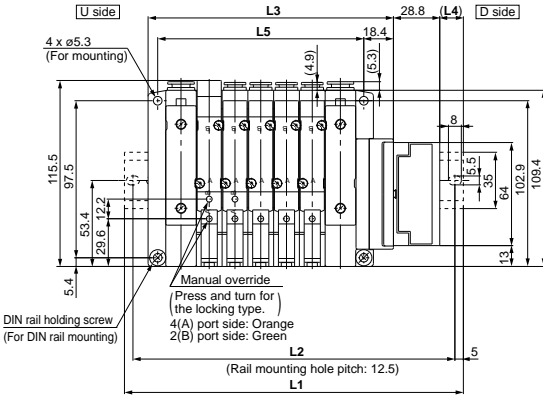
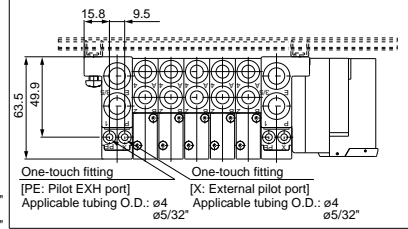

L Dimension

L	n	2	3	4	5	6	7	8	9	10	11	12	13	14	15	16
L1	160.5	173	198	210.5	223	248	260.5	273	285.5	310.5	323	335.5	360.5	373	385.5	
L2	150	162.5	187.5	200	212.5	237.5	250	262.5	275	300	312.5	325	350	362.5	375	
L3	104.4	120.4	136.4	152.4	168.4	184.4	200.4	216.4	232.4	248.4	264.4	280.4	296.4	312.4	328.4	
L4	13.5	12	16.5	14.5	13	17.5	15.5	14	12	16.5	15	13	17.5	16	14	
L5	80	96	112	128	144	160	176	192	208	224	240	256	272	288	304	

n: Stations

Directional Control Valves

Air Cylinders

Rotary Actuators

Air Grippers

Air Preparation Equipment

Modular F. R.

Pressure Control Equipment

Fittings & Tubing

Flow Control Equipment

Pressure Switches/ Pressure Sensors

Dimensions: Series 10-SV3000 for EX120 Dedicated Output Serial Wiring

- Tie-rod base manifold: 10-SS5V3-10S3□D-**Stations** $\begin{matrix} \text{U} \\ \text{D} \end{matrix}$ (R) $\begin{matrix} \text{C6, N7} \\ \text{C8, N9} \\ \text{C10, N11} \end{matrix}$ (-D)

*When P, E port outlets are indicated on the U side or D side, the P, E ports on the opposite side are plugged.
 *External pilot port positions are the same as P, E port outlet positions.

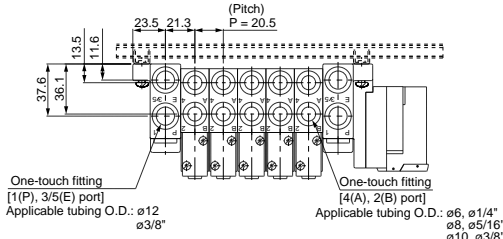

With external pilot specifications

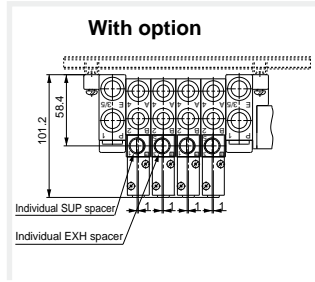
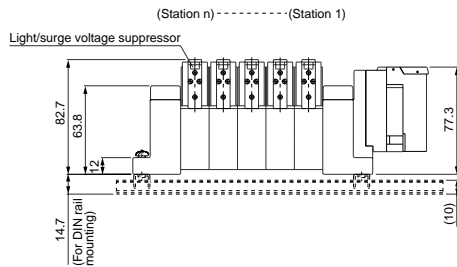
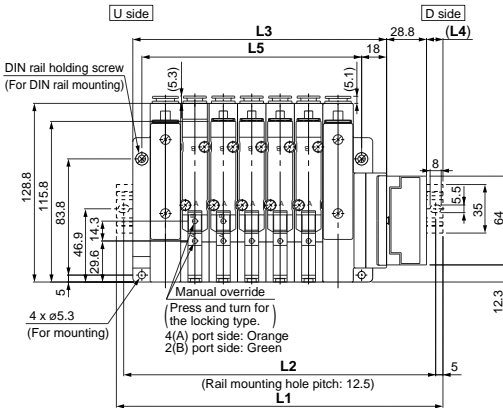
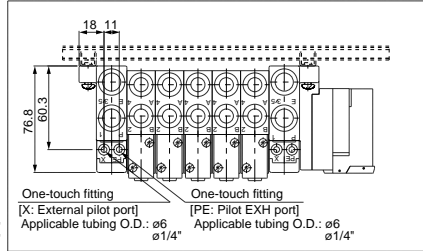

L Dimension

n	2	3	4	5	6	7	8	9	10	11	12	13	14	15	16	n: Stations
L1	185.5	198	223	235.5	260.5	285.5	298	323	348	360.5	385.5	410.5	423	448	460.5	
L2	175	187.5	212.5	225	250	275	287.5	312.5	337.5	350	375	400	412.5	437.5	450	
L3	121.5	142	162.5	183	203.5	224	244.5	265	285.5	306	326.5	347	367.5	388	408.5	
L4	17.5	13.5	16	12	14	16.5	12.5	14.5	17	13	15	17.5	13.5	15.5	11.5	
L5	97	117.5	138	158.5	179	199.5	220	240.5	261	281.5	302	322.5	343	363.5	384	

Dimensions: Series 10-SV4000 for EX120 Dedicated Output Serial Wiring

- Tie-rod base manifold: 10-SS5V4-10S3□D-**Stations** $\begin{matrix} U \\ D \end{matrix}$ (R) - $\begin{matrix} C8, N9 \\ C10, N11 \end{matrix}$ (-D)

•When P, E port outlets are indicated on the U side or D side, the P, E ports on the opposite side are plugged.
 •External pilot port positions are the same as P, E port outlet positions.

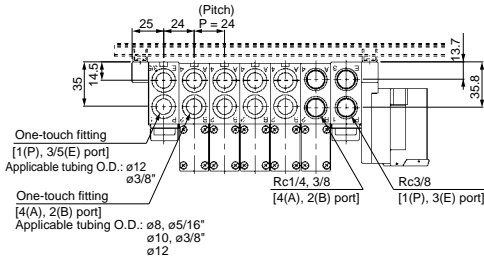

With external pilot specifications

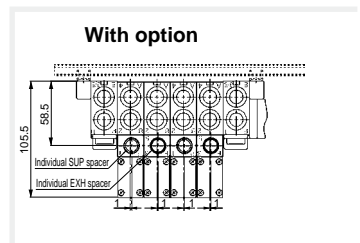
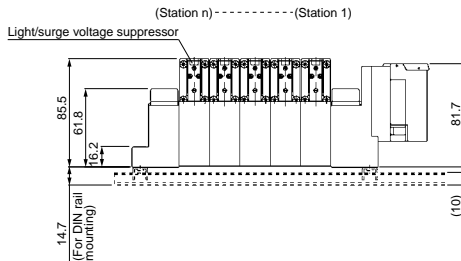
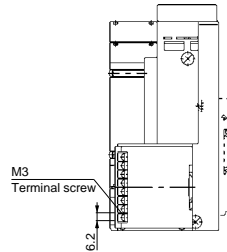
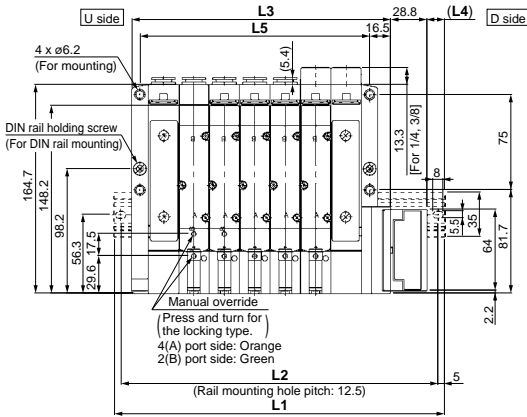
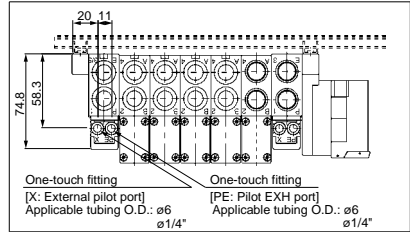

L Dimension

n	2	3	4	5	6	7	8	9	10	11	12	13	14	15	16
L1	185.5	210.5	235.5	260.5	285.5	310.5	335.5	360.5	385.5	410.5	435.5	448	473	498	523
L2	175	200	225	250	275	300	325	350	375	400	425	437.5	462.5	487.5	512.5
L3	132	156	180	204	228	252	276	300	324	348	372	396	420	444	468
L4	12.5	13	13.5	14	14.5	15	15.5	16	16.5	17	17.5	11.5	12	12.5	13
L5	109	133	157	181	205	229	253	277	301	325	349	373	397	421	445

n: Stations

Directional Control Valves
 Air Cylinders
 Rotary Actuators
 Air Grippers
 Air Preparation Equipment
 Modular F. R.
 Pressure Control Equipment
 Fittings & Tubing
 Flow Control Equipment
 Pressure Switches/ Pressure Sensors

Integrated Type (For Output) Serial Transmission System

Series **EX260** IP67 compliant (Some products are IP40)

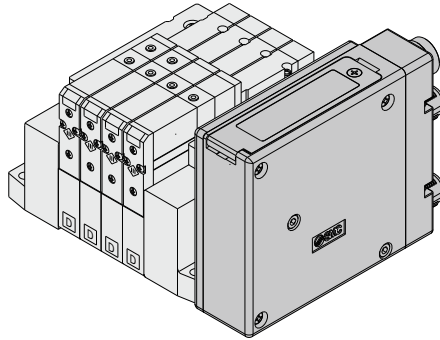

Tie-rod base

Applicable series	Tie-rod base manifold 10-SV1000/10-SV2000/10-SV3000
	· Number of outputs: 16, 32

Directional
Control Valves

Air Cylinders

Rotary Actuators

Air Grippers

Air Preparation
Equipment

Modular F. R.

Pressure Control
Equipment

Fittings & Tubing

Flow Control
Equipment

Pressure Switches/
Pressure Sensors

Series 10-SV

EX260 Integrated-type (For Output) Serial Transmission System



How to Order Manifold

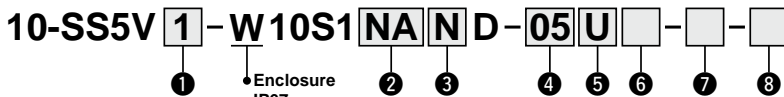

Enclosure
IP67

* Refer to Note 1) of the ② SI unit specifications.

① Series

1	10-SV1000
2	10-SV2000
3	10-SV3000

② SI unit specifications

Symbol	Protocol	Number of outputs	Communication connector
0		Without SI unit	
QA	DeviceNet™	32	M12
QB		16	
NA		32	
NB		16	
NC	PROFIBUS DP	32	D-sub Note 1)
ND		16	
VA		32	
VB	CC-Link	32	M12
DA		16	
DB	EtherCAT	32	M12
FA		16	
FB	PROFINET	32	M12
EA		16	
EB	EtherNet/IP™	32	M12
		16	

• DIN rail cannot be selected for the product without SI unit.

Note 1) IP40 for the D-sub applicable communication connector specifications. (The manifold part number is "10-SS5V □-10S1NC/ND□D".)

Note 2) For SI unit part number, refer to the Best Pneumatics No. 1.

③ SI unit output polarity

Nii	Positive common
N	Negative common

Note) The symbol is nil for no SI unit.

⑦ A, B port size (Metric)

Symbol	A, B port	P, E port	Applicable series
C3	ø3.2 One-touch fitting	ø8 One-touch fitting	10-SV1000
C4	ø4 One-touch fitting		
C6	ø6 One-touch fitting		
C4	ø4 One-touch fitting		
C6	ø6 One-touch fitting	ø10 One-touch fitting	10-SV2000
C8	ø8 One-touch fitting		
C6	ø6 One-touch fitting		
C8	ø8 One-touch fitting		
C10	ø10 One-touch fitting	ø12 One-touch fitting	10-SV3000
M	Mixed		

A, B port size (Inch)

Symbol	A, B port	P, E port	Applicable series
N1	ø1/8" One-touch fitting	ø5/16" One-touch fitting	10-SV1000
N3	ø5/32" One-touch fitting		
N7	ø1/4" One-touch fitting		
N3	ø5/32" One-touch fitting	ø3/8" One-touch fitting	10-SV2000
N7	ø1/4" One-touch fitting		
N9	ø5/16" One-touch fitting		
N7	ø1/4" One-touch fitting		
N9	ø5/16" One-touch fitting	ø3/8" One-touch fitting	10-SV3000
N11	ø3/8" One-touch fitting		
M	Mixed		

* For mixed specifications (M), indicate separately on the manifold specification sheet.

* External pilot type (R) X, PE port sizes are ø4 (mm) or ø5/32" (inch) for the 10-SV1000/2000 series, and ø6 (mm) or ø1/4" (inch) for the 10-SV3000 series.

④ Valve stations

For 32-output SI unit

Symbol	Stations	Note
02	2 stations	Double wiring Note 1)
⋮	⋮	
16	16 stations	
02	2 stations	Specified layout Note 2) (Available up to 32 solenoids)
⋮	⋮	
20	20 stations	

For 16-output SI unit

Symbol	Stations	Note
02	2 stations	Double wiring Note 1)
⋮	⋮	
08	8 stations	
02	2 stations	Specified layout Note 2) (Available up to 16 solenoids)
⋮	⋮	
16	16 stations	

Note 1) Double wiring: Single, double, 3-position and 4-position solenoid valves can be used on all manifold stations. Use of a single solenoid will result in an unused control signal. If this is not desired, order with a specified layout.

Note 2) Specified layout. Indicate the wiring specifications on the manifold specification sheet.

(Note that double, 3-position and 4-position valves cannot be used where single solenoid wiring has been specified.)

Note 3) Includes the number of blanking plate assemblies.

⑤ P, E port location

U	U side (2 to 10 stations)
D	D side (2 to 10 stations)
B	Both sides (2 to 20 stations)

⑥ SUP/EXH block assembly

Nii	Internal pilot
R	External pilot

⑧ Mounting

Nii	Direct mounting	
D	DIN rail mounting (With DIN rail)	
D0	DIN rail mounting (Without DIN rail)	
D3	For 3 stations	When a longer DIN rail is desired than the specified stations. (Specify a longer rail than the standard length.)
⋮	⋮	
D20	For 20 stations	

How to Order Manifold Assembly

Example (10-SV1000)

Manifold

10-SS5V1-W10S1NAND-04B-C6 (1 set)

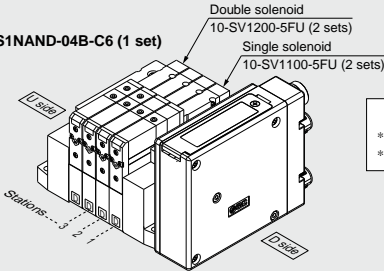

10-SS5V1-W10S1NAND-04B-C6.....1 set (Manifold part no.)
 *10-SV1100-5FU.....2 sets (Single solenoid part no.)
 *10-SV1200-5FU.....2 sets (Double solenoid part no.)

How to Order Valve

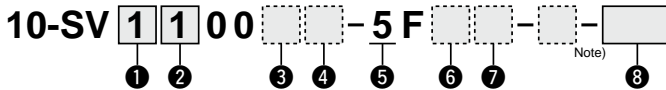

1 Series

1	10-SV1000
2	10-SV2000
3	10-SV3000

2 Actuation type

1	2-position single
2	2-position double
3	3-position closed center
4	3-position exhaust center
5	3-position pressure center
A	4-position dual 3-port valve: N.C./N.C.
B	4-position dual 3-port valve: N.O./N.O.
C	4-position dual 3-port valve: N.C./N.O.

* 4-position dual 3-port valves are applicable to the 10-SV1000/2000 series only.

3 Pilot type

NII	Internal pilot
R	External pilot

* External pilot specifications are not available for 4-position dual 3-port valves.

4 Back pressure check valve

NII	None
K	Built-in

* The built-in back pressure check valve type is applicable to the 10-SV1000 series only.
 * The product with back pressure check valve is not available for 3-position valves.

Note) Refer to the Specific Product Precautions 2 in the Best Pneumatics No. 1.

5 Rated voltage

5	24 VDC
---	--------

6 Light/surge voltage suppressor

U	With light/surge voltage suppressor
R	With surge voltage suppressor

7 Manual override

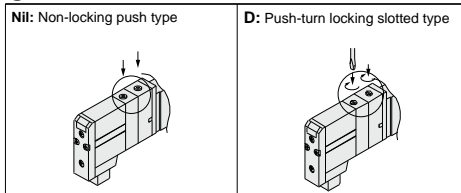

Note) Available with manifold block for station additions. Refer to the **WEB catalog**.

8 Made to Order

NII	—
X90	Main valve fluororubber (Refer to page 272.)

Refer to the SMC website or the SV series in the Best Pneumatics No. 1 for details on solenoid valve specifications, Common Precautions and Specific Product Precautions.

Directional Control Valves
 Air Cylinders
 Rotary Actuators
 Air Grippers
 Air Preparation Equipment
 Modular F. R.
 Pressure Control Equipment
 Fittings & Tubing
 Flow Control Equipment
 Pressure Switches/Pressure Sensors

Dimensions: Series 10-SV1000 for EX260 Integrated-type (For Output) Serial Transmission System

● Tie-rod base manifold: 10-SS5V1-W10S1 □□D- Stations $\frac{U}{D}$ (R)- C3, N1
C4, N3 C6, N7 (-D)

- When P, E port outlets are indicated on the U side or D side, the P, E ports on the opposite side are plugged.
- External pilot port positions are the same as P, E port outlet positions.

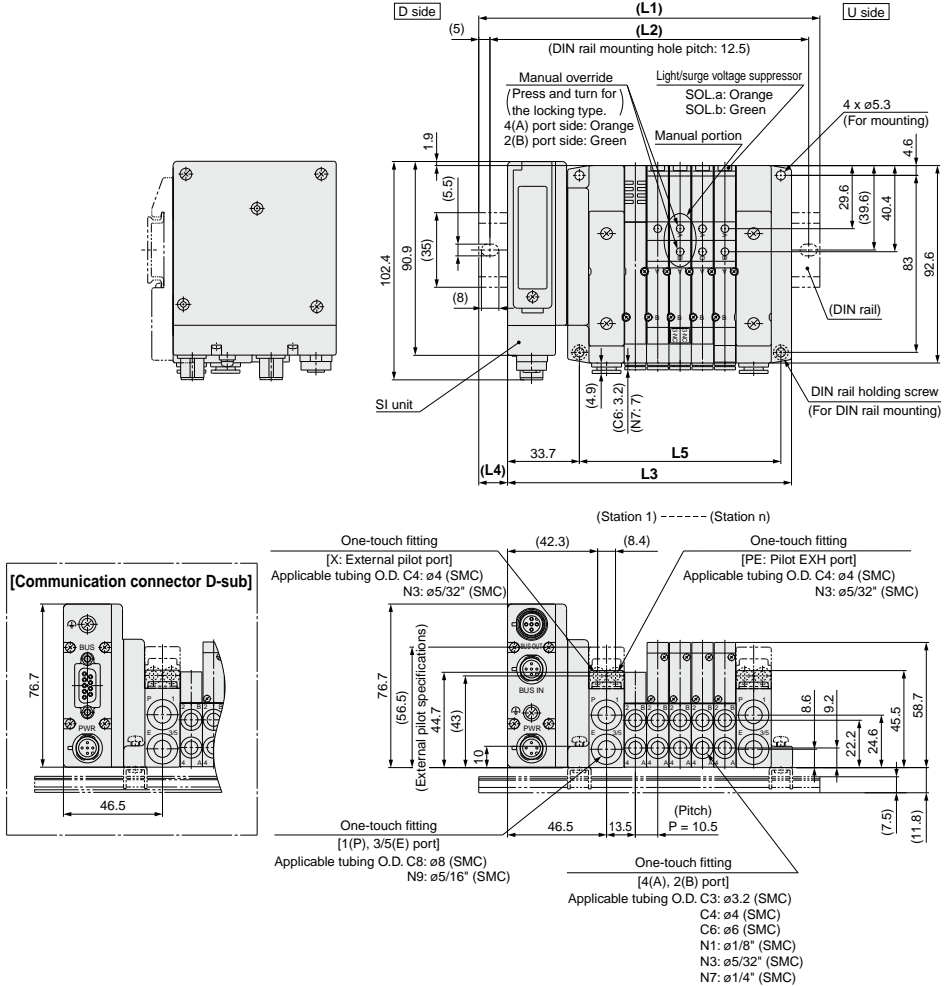

Dimensions: Series 10-SV2000 for EX260 Integrated-type (For Output) Serial Transmission System

● Tie-rod base manifold: 10-SS5V2-W10S1 □ □ D - Stations $\begin{matrix} U \\ D \end{matrix}$ (R)- C4, N3, C6, N7, C8, N9 (-D)

- When P, E port outlets are indicated on the U side or D side, the P, E ports on the opposite side are plugged.
- External pilot port positions are the same as P, E port outlet positions.

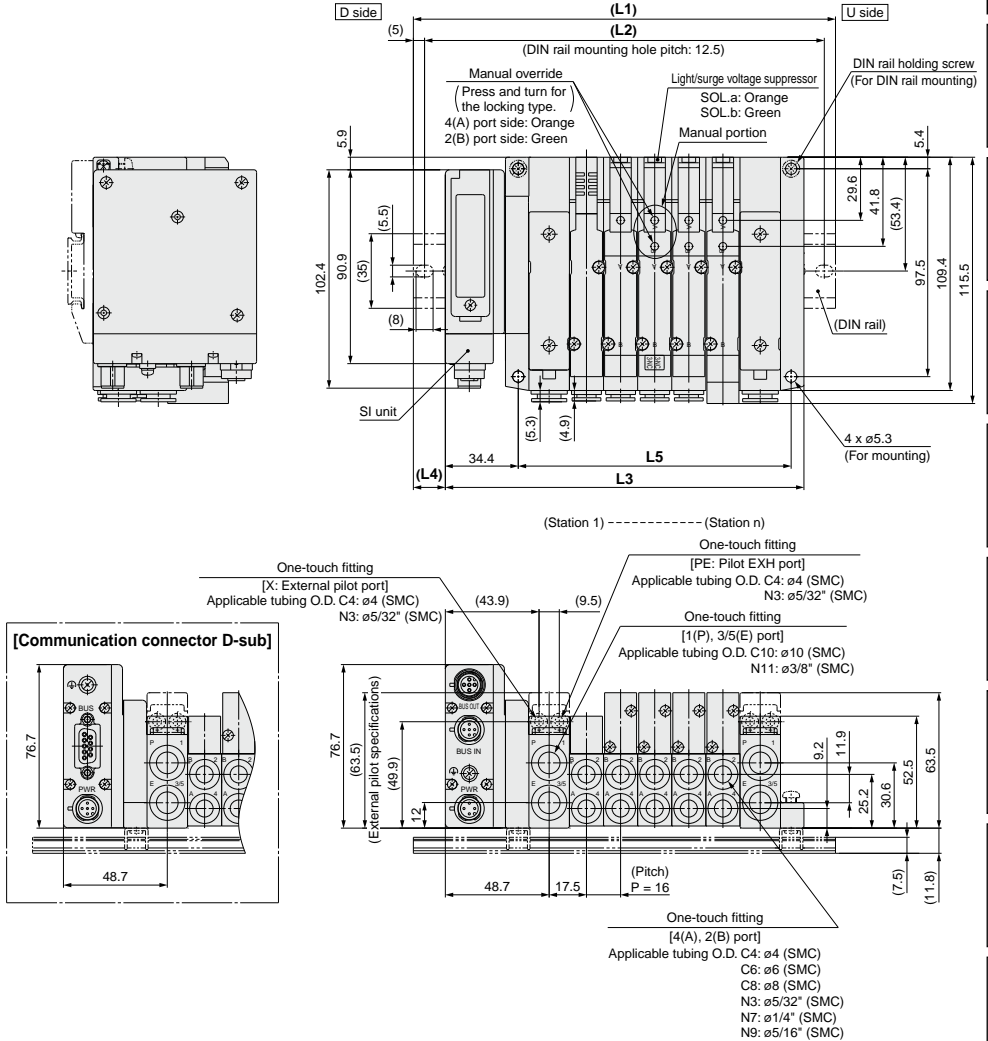

L: DIN Rail Overall Length

L	n	2	3	4	5	6	7	8	9	10	11	12	13	14	15	16	17	18	19	20
L1	n	148	160.5	185.5	198	210.5	235.5	248	260.5	273	298	310.5	323	335.5	360.5	373	385.5	410.5	423	435.5
L2	n	137.5	150	175	187.5	200	225	237.5	250	262.5	287.5	300	312.5	325	350	362.5	375	400	412.5	425
L3	n	120.2	136.2	152.2	168.2	184.2	200.2	216.2	232.2	248.2	264.2	280.2	296.2	312.2	328.2	344.2	360.2	376.2	392.2	408.2
L4	n	14	12	16.5	15	13	17.5	16	14	12.5	17	15	13.5	11.5	16	14.5	12.5	17	15.5	13.5
L5	n	80	96	112	128	144	160	176	192	208	224	240	256	272	288	304	320	336	352	368

Directional Control Valves
 Air Cylinders
 Rotary Actuators
 Air Grippers
 Air Preparation Equipment
 Modular F. R.
 Pressure Control Equipment
 Fittings & Tubing
 Flow Control Equipment
 Pressure Switches/ Pressure Sensors

Dimensions: Series 10-SV3000 for EX260 Integrated-type (For Output) Serial Transmission System

● Tie-rod base manifold: 10-SS5V3-W10S1□□D- $\frac{U}{R}$ (R)- $\frac{C6, N7}{C8, N9}$ (-D)
C10, N11

- When P, E port outlets are indicated on the U side or D side, the P, E ports on the opposite side are plugged.
- External pilot port positions are the same as P, E port outlet positions.

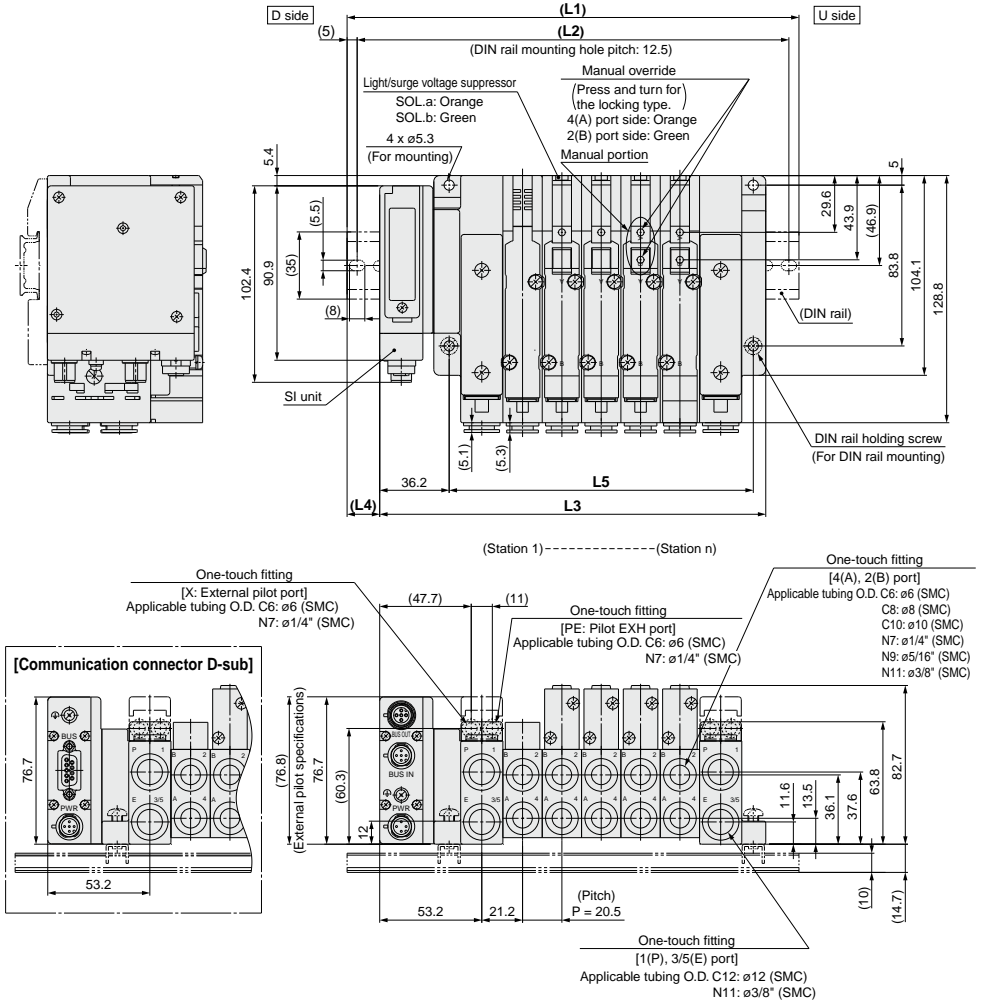

L: DIN Rail Overall Length

L	n: Stations																			
	2	3	4	5	6	7	8	9	10	11	12	13	14	15	16	17	18	19	20	
L1	173	185.5	210.5	235.5	248	273	298	310.5	335.5	348	373	398	410.5	435.5	460.5	473	498	523	535.5	
L2	162.5	175	200	225	237.5	262.5	287.5	300	325	337.5	362.5	387.5	400	425	450	462.5	487.5	512.5	525	
L3	139.7	160.2	180.7	201.2	221.7	242.2	262.7	283.2	303.7	324.2	344.7	365.2	385.7	406.2	426.7	447.2	467.7	488.2	508.7	
L4	16.5	12.5	15	17	13	15.5	17.5	13.5	16	12	14	16.5	12.5	14.5	17	13	15	17.5	13.5	
L5	97	117.5	138	158.5	179	199.5	220	240.5	261	281.5	302	322.5	343	363.5	384	404.5	425	445.5	466	

Integrated Type (For Output) Serial Transmission System

Series **EX126**

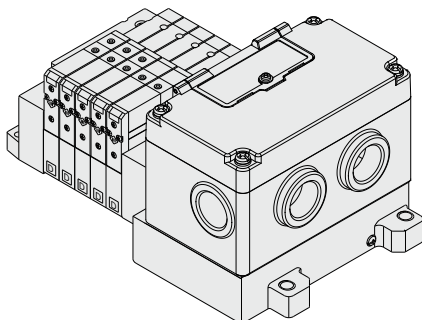

IP67 compliant

Applicable series	Tie-rod base manifold SV1000/SV2000/SV3000
	· Number of outputs: 16

Directional
Control Valves

Air Cylinders

Rotary Actuators

Air Grippers

Air Preparation
Equipment

Modular F. R.

Pressure Control
Equipment

Fittings & Tubing

Flow Control
Equipment

Pressure Switches/
Pressure Sensors

Series 10-SV

EX126 Dedicated Output Serial Wiring



How to Order

● Tie-rod base

10-SS5V **1** - W 10S4 D-05 **U** - -

Series	
1	10-SV1000
2	10-SV2000
3	10-SV3000

● Enclosure
IP67

● SI unit

0	Without SI unit and end plate
VW	CC-Link

- When the SI unit is not included, only the terminal block plate is included.

● Valve stations

Symbol	Stations	Note
02	2 stations	Double wiring ^{Note 1)}
⋮	⋮	
08	8 stations	
02	2 stations	Specified layout ^{Note 2)} (up to 16 solenoids possible.)
⋮	⋮	
16	16 stations	

Note 1) Double wiring: Single, double, 3 position and 4 position solenoid valves can be used on all manifold stations. Use of a single solenoid will result in an unused control signal. If this is not desired, order with a specified layout.

Note 2) Specified layout: Indicate wiring specifications on the manifold specification sheet. (Note that double, 3 and 4 position valves cannot be used where single solenoid wiring has been specified.)

● Mounting

Nil	Direct mounting
D	DIN rail mounting (With DIN rail)
D0 ^{Note)}	DIN rail mounting (Without DIN rail)
D3	For 3 stations
⋮	⋮
D16	For 16 stations

Note) For D0, only DIN rail mounting bracket is attached.

● SUP/EXH block assembly

Nil	Internal pilot
R	External pilot

SI Unit Part No.

Symbol	Protocol type	SI unit part no.
VW	CC-Link	EX126D-SMJ1

Refer to the **WEB catalog** and the Operation Manual for the details of the EX126 Integrated-type (For Output) Serial Transmission System. Please download the Operation Manual via our website, <http://www.smcworld.com>.

● P, E port location

U	U side (2 to 10 stations)
D	D side (2 to 10 stations)
B	Both sides (2 to 16 stations)

● A, B port size (Metric)

Symbol	A, B port	P, E port	Applicable series
C3	ø3.2 One-touch fitting	ø8 One-touch fitting	10-SV1000
C4	ø4 One-touch fitting		
C6	ø6 One-touch fitting		
C4	ø4 One-touch fitting	ø10 One-touch fitting	10-SV2000
C6	ø6 One-touch fitting		
C8	ø8 One-touch fitting		
C6	ø6 One-touch fitting	ø12 One-touch fitting	10-SV3000
C8	ø8 One-touch fitting		
C10	ø10 One-touch fitting		
M	Mixed		

● A, B port size (Inch)

Symbol	A, B port	P, E port	Applicable series
N1	ø1/8" One-touch fitting	ø5/16" One-touch fitting	10-SV1000
N3	ø5/32" One-touch fitting		
N7	ø1/4" One-touch fitting		
N3	ø5/32" One-touch fitting	ø3/8" One-touch fitting	10-SV2000
N7	ø1/4" One-touch fitting		
N9	ø5/16" One-touch fitting		
N7	ø1/4" One-touch fitting	ø3/8" One-touch fitting	10-SV3000
N9	ø5/16" One-touch fitting		
N11	ø3/8" One-touch fitting		
M	Mixed		

* For mixed specifications (M), indicate separately on the manifold specification sheet.

* External pilot type (R) X, PE port sizes are ø4 (metric), ø5/32" (inch) for the 10-SV1000/2000 series and ø6 (metric), ø1/4" (inch) for the 10-SV3000 series.

How to Order Manifold Assembly

Ordering example (10-SV1000)

Manifold
10-SS5V1-W10S4VWD-05B-C6 (1 set)

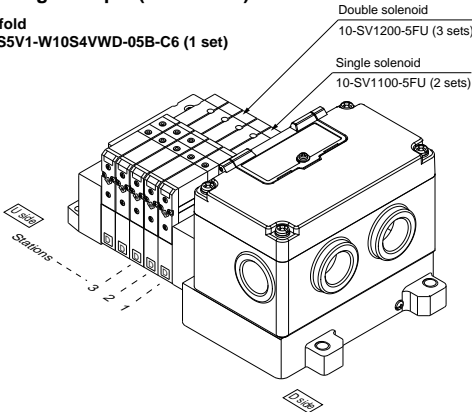

10-SS5V1-W10S4VWD-05B-C6 1 set (manifold part no.)
 * 10-SV1100-5FU 2 sets (manifold part no.)
 * 10-SV1200-5FU 3 sets (manifold part no.)

How to Order Valve

10-SV 1 1 00 [] [] - 5 F [] [] - [] []

Series

1	10-SV1000
2	10-SV2000
3	10-SV3000

Actuation type

1	2 position single
2	2 position double
3	3 position closed center
4	3 position exhaust center
5	3 position pressure center
A	4 position dual 3 port valve: N.C./N.C.
B	4 position dual 3 port valve: N.O./N.O.
C	4 position dual 3 port valve: N.C./N.O.

* 4 position dual 3 port valves are applicable to the 10-SV1000 and 10-SV2000 series only.

Pilot type

Nil	Internal pilot
R	External pilot

* External pilot specifications are not available for 4 position dual 3 port valves.

Back pressure check valve

Nil	None
K	Built-in

* The built-in back pressure check valve type is applicable to the 10-SV1000 series only.
 * The product with back pressure check valve is not available for 3 position valves.

Rated voltage

5	24 VDC
---	--------

Note) Available with manifold block for station additions. Refer to the WEB catalog.

Made to Order

Nil	—
X90	Main valve fluororubber (Refer to page 272.)

Manual override

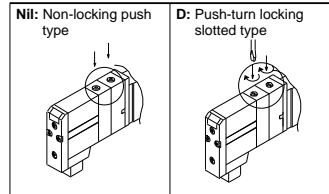

Light/Surge voltage suppressor

U	With light/surge voltage suppressor
R	With surge voltage suppressor

Note) Refer to the Specific Product Precautions 2 on page 274.

Directional Control Valves
 Air Cylinders
 Rotary Actuators
 Air Grippers
 Air Preparation Equipment
 Modular F. R.
 Pressure Control Equipment
 Fittings & Tubing
 Flow Control Equipment
 Pressure Switches/ Pressure Sensors

Dimensions: Series 10-SV1000 for EX126 Integrated-type (For Output) Serial Transmission System

● Tie-rod base manifold: 10-SS5V1-W10S4 □ D- Stations $\frac{U}{B}$ (R) $\frac{C3, N1}{C6, N7}$ (D)

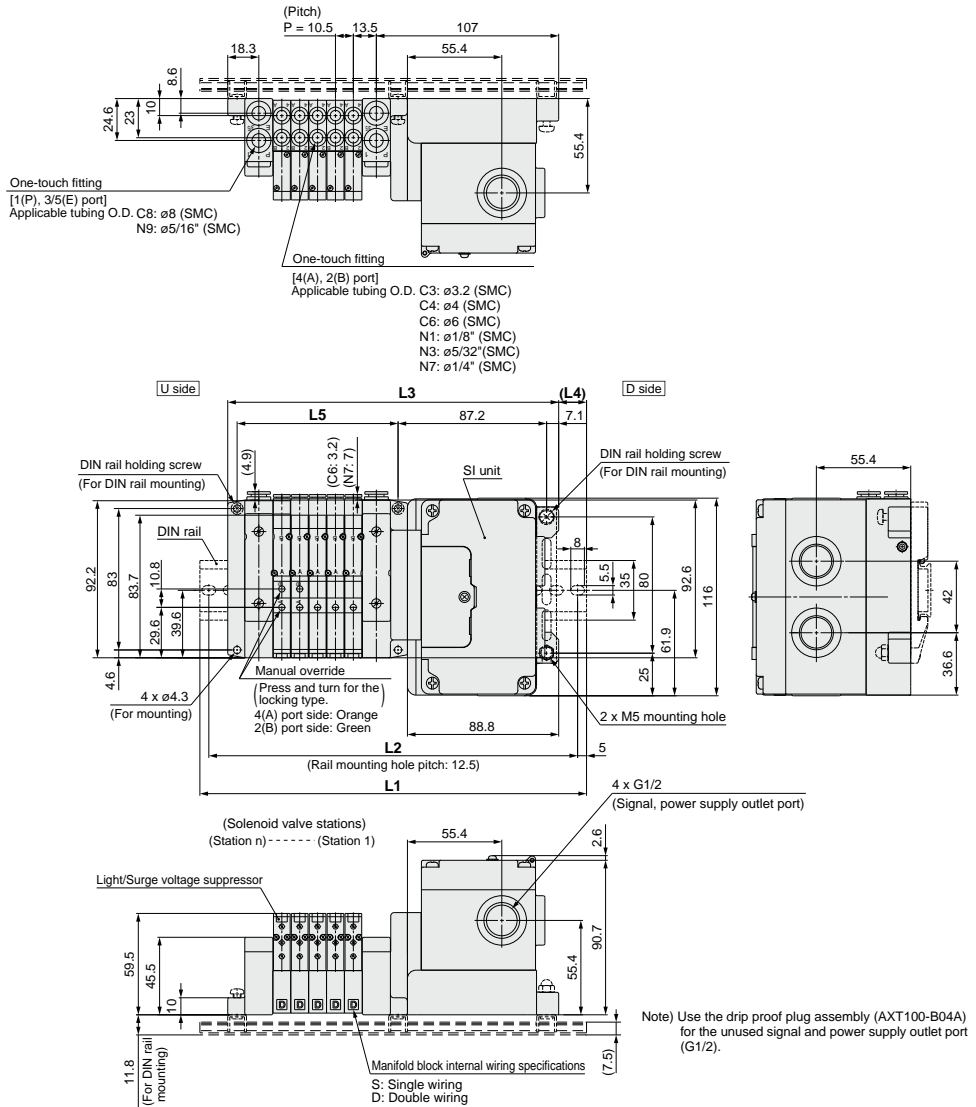

L Dimension

n	2	3	4	5	6	7	8	9	10	11	12	13	14	15	16
L1	198	198	210.5	223	235.5	248	260.5	260.5	273	285.5	298	310.5	323	323	335.5
L2	187.5	187.5	200	212.5	225	237.5	250	250	262.5	275	287.5	300	312.5	312.5	325
L3	162.8	173.3	183.8	194.3	204.8	215.3	225.8	236.3	246.8	257.3	267.8	278.3	288.8	299.3	309.8
L4	17.5	12.5	13.5	14.5	15.5	16.5	17.5	12	13	14	15	16	17	12	13
L5	63	73.5	84	94.5	105	115.5	126	136.5	147	157.5	168	178.5	189	199.5	210

Dimensions: Series 10-SV2000 for EX126 Integrated-type (For Output) Serial Transmission System

● Tie-rod base manifold: 10-SS5V2-W10S4 □ D-^UStations_B(R) ^{CA, NB} ^{CS, NS} ^{CS, NS} (-D)

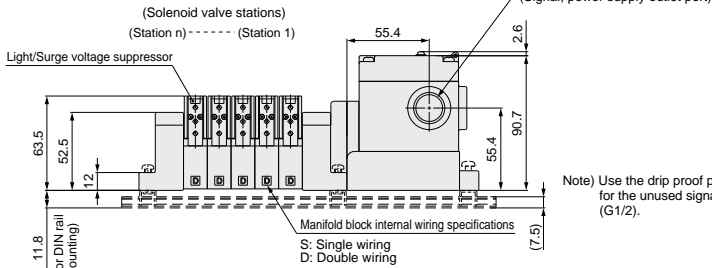
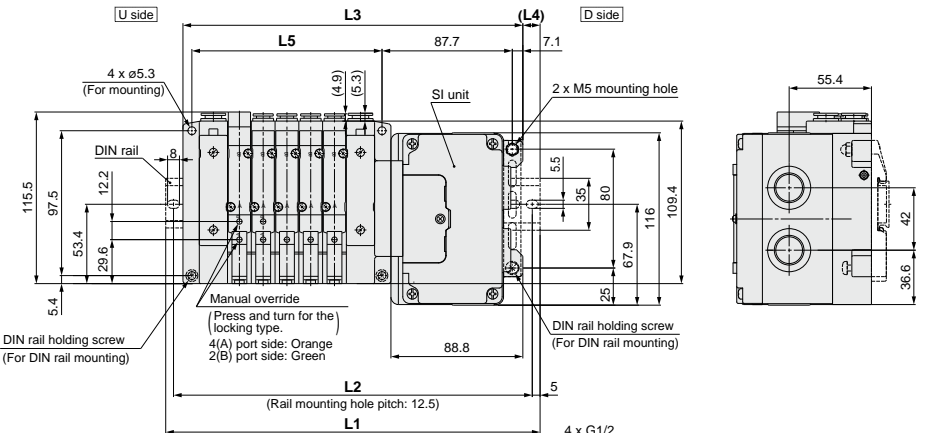
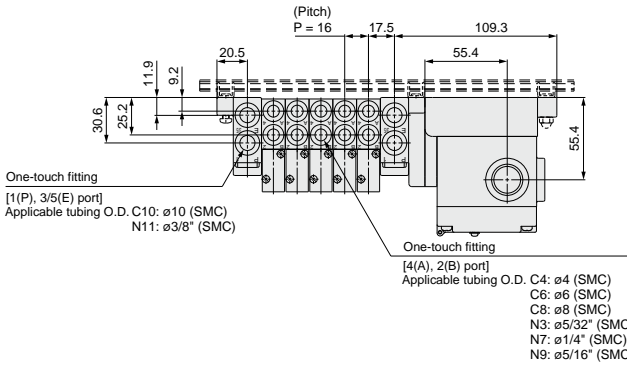

Note) Use the drip proof plug assembly (AXT100-B04A) for the unused signal and power supply outlet port (G1/2).

L Dimension

n	2	3	4	5	6	7	8	9	10	11	12	13	14	15	16
L1	210.5	223	248	260.5	273	285.5	310.5	323	335.5	348	373	385.5	398	423	435.5
L2	200	212.5	237.5	250	262.5	275	300	312.5	325	337.5	362.5	375	387.5	412.5	425
L3	180.8	196.8	212.8	228.8	244.8	260.8	276.8	292.8	308.8	324.8	340.8	356.8	372.8	388.8	404.8
L4	15	13	17.5	16	14	12.5	17	15	13.5	11.5	16	14.5	12.5	17	15.5
L5	80	96	112	128	144	160	176	192	208	224	240	256	272	288	304

n: Stations

Directional Control Valves
Air Cylinders
Rotary Actuators
Air Grippers
Air Preparation Equipment
Modular F. R.
Pressure Control Equipment
Fittings & Tubing
Flow Control Equipment
Pressure Switches/Pressure Sensors

Circular Connector

IP67 compliant

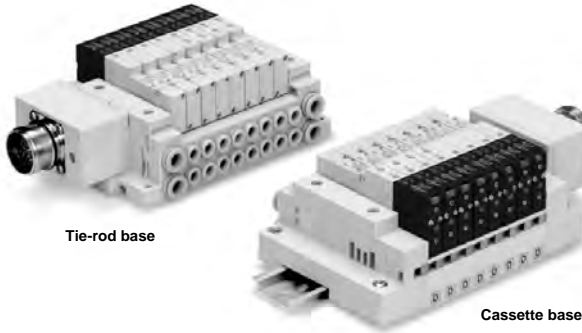

Tie-rod base

Cassette base

Applicable series	Cassette base manifold 10-SV1000/10-SV2000
	Tie-rod base manifold 10-SV1000/10-SV2000/10-SV3000/10-SV4000
· Number of connectors: 26 pins	

Directional Control Valves

Air Cylinders

Rotary Actuators

Air Grippers

Air Preparation Equipment

Modular F. R.

Pressure Control Equipment

Fittings & Tubing

Flow Control Equipment

Pressure Switches/ Pressure Sensors

Series 10-SV

Circular Connector



How to Order

Series

1	10-SV1000
2	10-SV2000
3	10-SV3000
4	10-SV4000

Valve stations

Symbol	Stations	Note
02	2 stations	Double wiring (Note 1)
:	:	
12	12 stations	Specified layout (Note 2) (Up to 24 solenoids possible)
02	2 stations	
:	:	
20	20 stations	

Tie-rod base
10 - SS5V 1 - W 10CD - 05 U

Cassette base
10 - SS5V 1 - W 16CD - 05 U

Clean series

1	10-SV1000
2	10-SV2000

Enclosure IP67

Stations

Type 16: Series 10-SV1000

Symbol	Stations	Note
02	2 stations	Double wiring (Note 1)
:	:	
09	9 stations	Specified layout (Note 2) (Up to 18 solenoids possible)
02	2 stations	
:	:	
18	18 stations	

Type 16: Series 10-SV2000

Symbol	Stations	Note
02	2 stations	Double wiring (Note 1)
:	:	
12	12 stations	Specified layout (Note 2) (Up to 24 solenoids possible)
02	2 stations	
:	:	
20	20 stations	

Mounting

Nil	Direct mounting	
D	DIN rail mounting (With DIN rail)	
D0 (Note)	DIN rail mounting (Without DIN rail)	
D3	For 3 stations	When a longer DIN rail is desired than the specified stations. (Specify a longer rail than the standard length.)
:	:	
D20	For 20 stations	

DIN rail length specified

Nil	Standard length	
3	For 3 stations	Specify a longer rail than the standard length.
:	:	
20 (Note)	For 20 stations	

A, B port size (Metric)

Symbol	Specifications	P, E port	Applicable series
C3	ø3.2 One-touch fitting	ø8 One-touch fitting	10-SV1000
C4	ø4 One-touch fitting		
C6	ø6 One-touch fitting		
C4	ø4 One-touch fitting	ø10 One-touch fitting	10-SV2000
C6	ø6 One-touch fitting		
C8	ø8 One-touch fitting		
C6	ø6 One-touch fitting	ø12 One-touch fitting	10-SV3000
C8	ø8 One-touch fitting		
C10	ø10 One-touch fitting		
C8	ø8 One-touch fitting	ø12 One-touch fitting	10-SV4000
C10	ø10 One-touch fitting		
C12	ø12 One-touch fitting		
02	Rc 1/4	Rc 3/8	10-SV4000
03	Rc 3/8		
02F	G 1/4		
03F	G 3/8	G 3/8	
M	Mixed		

A, B port size (Inch)

Symbol	Specifications	P, E port	Applicable series
N1	ø1/8" One-touch fitting	ø5/16" One-touch fitting	10-SV1000
N3	ø5/32" One-touch fitting		
N7	ø1/4" One-touch fitting		
N3	ø5/32" One-touch fitting	ø3/8" One-touch fitting	10-SV2000
N7	ø1/4" One-touch fitting		
N9	ø5/16" One-touch fitting		
N7	ø1/4" One-touch fitting	ø3/8" One-touch fitting	10-SV3000
N9	ø5/16" One-touch fitting		
N11	ø3/8" One-touch fitting		
N9	ø5/16" One-touch fitting	ø3/8" One-touch fitting	10-SV4000
N11	ø3/8" One-touch fitting		
N11	ø3/8" One-touch fitting		
02N	NPT 1/4	NPT 3/8	10-SV4000
03N	NPT 3/8		
02T	NPTF 1/4		
03T	NPTF 3/8		
M	Mixed		

P, E port location

U	U side (2 to 10 stations)
D	D side (2 to 10 stations)
B	Both sides (2 to 20 stations)

SUP/EXH block assembly

Nil	Internal pilot
R	External pilot

Note 1 Double wiring: Single, double, 3 position and 4 position solenoid valves can be used at all of the manifold stations. Use of a single solenoid will result in an unused control signal. If this is not desired, order with a specified layout.

Note 2 Specified layout: Indicate wiring specifications on the manifold specification sheet. (Note that double, 3 and 4 position valves cannot be used where single solenoid wiring has been specified.)

Note For D0, only DIN rail mounting bracket is attached.

Note Able to specify the length for 3 stations up to 18 stations for 10-SV1000, which is available with 18 stations at the maximum.

How to Order Manifold Assembly

Ordering example (10-SV1000)

Manifold

10-SS5V1-W16CD-06B-C6 (1 set)

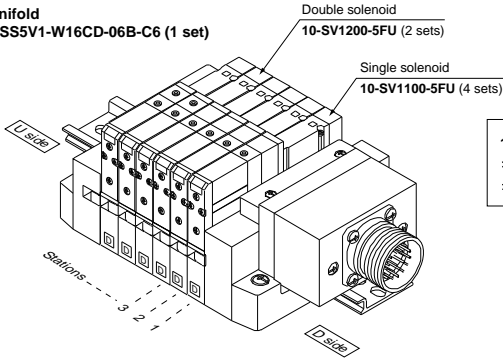

10-SS5V1-W16CD-06B-C6.....1 set (Manifold part no.)
 * 10-SV1100-5FU.....4 sets (Single solenoid part no.)
 * 10-SV1200-5FU.....2 sets (Double solenoid part no.)

How to Order Solenoid Valve

10-SV 1 1 00 **5 F** (Note)

Clean series

Series

1	10-SV1000
2	10-SV2000
3	10-SV3000
4	10-SV4000

Actuation type

1	2 position single solenoid
2	2 position double solenoid
3	3 position closed center
4	3 position exhaust center
5	3 position pressure center
A	4 position dual 3 port valve: N.C./N.C.
B	4 position dual 3 port valve: N.O./N.O.
C	4 position dual 3 port valve: N.C./N.O.

* 4 position dual 3 port valves are applicable to the 10-SV1000 and 10-SV2000 series only.

Pilot type

Nil	Internal pilot
R	External pilot

* External pilot specifications are not available for 4 position dual 3 port valves.

Back pressure check valve

Nil	None
K	Built-in

* The built-in back pressure check valve type is applicable to the 10-SV1000 series only.
 * The product with back pressure check valve is not available for 3 position solenoid valves.

Rated voltage

5	24 VDC
6	12 VDC

Note) Available with manifold block for station additions. Refer to the **WEB catalog**.

Made to Order

Nil	—
X90	Main valve fluororubber (Refer to page 272.)

Manual override

Nil: Non-locking push type	D: Push-turn locking slotted type
----------------------------	-----------------------------------

Light/surge voltage suppressor

U	With light/surge voltage suppressor
R	With surge voltage suppressor

Note) Refer to the Specific Product Precautions 2 on page 274.

Directional Control Valves
 Air Cylinders
 Rotary Actuators
 Air Grippers
 Air Preparation Equipment
 Modular F. R.
 Pressure Control Equipment
 Fittings & Tubing
 Flow Control Equipment
 Pressure Switches/ Pressure Sensors

Manifold Electrical Wiring

10C/16C Circular Connector Type (26 pins)

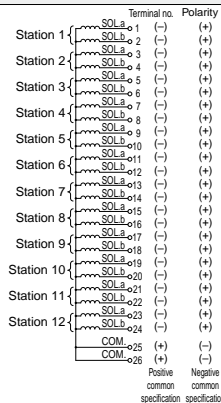

- This circuit is for the double wiring specification with up to 12 stations. Since the usable number of solenoids differs depending on the manifold type, refer to the table below. For single solenoids, connect to SOL.A. Furthermore, when wiring is specified on the manifold specification sheet, connections are made without skipping any connectors, and signals A for single and A, B for double are in order 1 → 2 → 3 → 4, etc.
- Stations are counted from the D side (connector side) as the 1st one.
- Since solenoid valves do not have polarity, either the +COM or -COM can be used.

Usable No. of Solenoids

Model	Max. no. of solenoids
Type 10, Tie-rod base	24
Type 16, Cassette base	18
	24

Dimensions: Series 10-SV1000 for Circular Connector

• Cassette base manifold: 10-SS5V1-W16CD-**Stations** $\frac{U}{D}$ (R) - C3, N1
C4, N3
C6, N7

• When P, E port outlets are indicated on the U side or D side, the P, E ports on the opposite side are plugged.
• External pilot port positions are the same as P, E port outlet positions.

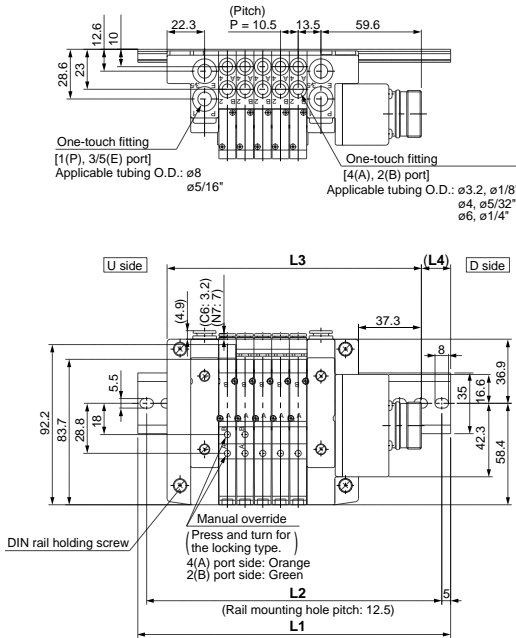

With external pilot specifications

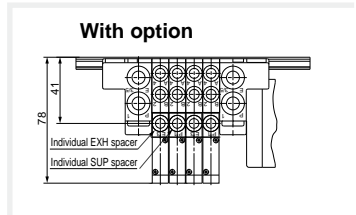
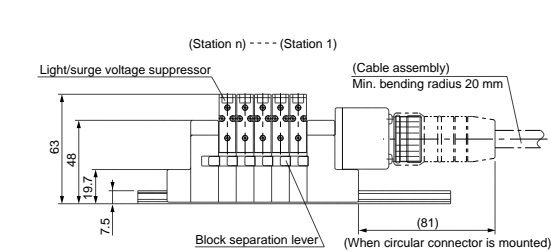
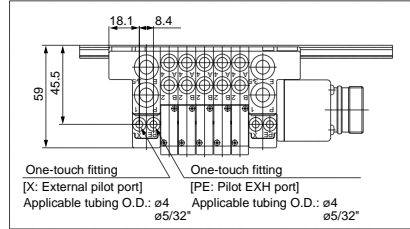

L Dimension

	n: Stations																	
$\frac{L}{n}$	2	3	4	5	6	7	8	9	10	11	12	13	14	15	16	17	18	
L1	148	160.5	173	185.5	185.5	198	210.5	223	235.5	248	248	260.5	273	285.5	298	310.5	310.5	
L2	137.5	150	162.5	175	175	187.5	200	212.5	225	237.5	237.5	250	262.5	275	287.5	300	300	
L3	119.3	129.8	140.3	150.8	161.3	171.8	182.3	192.8	203.3	213.8	224.3	234.8	245.3	255.8	266.3	276.8	287.3	
L4	14.5	15.5	16.5	17.5	12	13	14	15	16	17	12	13	14	15	16	17	11.5	

Directional Control Valves
Air Cylinders
Rotary Actuators
Air Grippers
Air Preparation Equipment
Modular F. R.
Pressure Control Equipment
Fittings & Tubing
Flow Control Equipment
Pressure Switches/ Pressure Sensors

Dimensions: Series 10-SV2000 for Circular Connector

• **Cassette base manifold: 10-SS5V2-W16CD-**

U	D
D	R

 - C4, N3
C6, N7
C8, N9

• When P, E port outlets are indicated on the U side or D side, the P, E ports on the opposite side are plugged.
• External pilot port positions are the same as P, E port outlet positions.

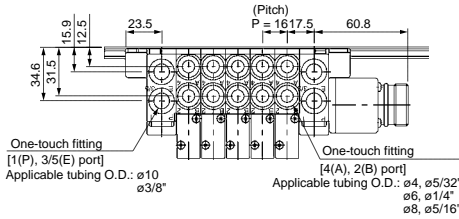

With external pilot specifications

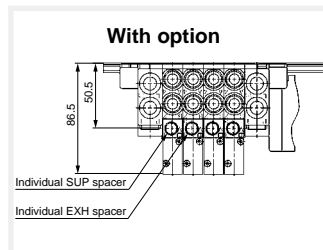
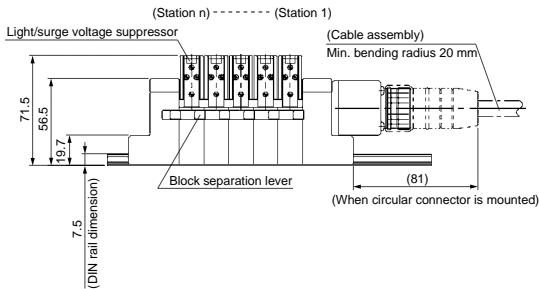
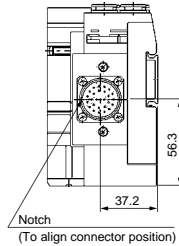
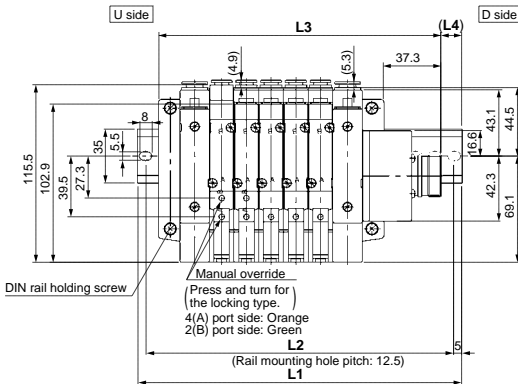
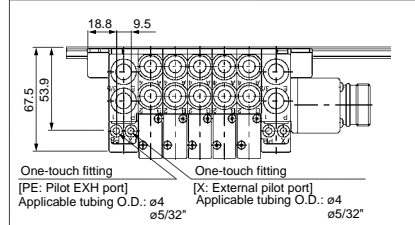

L Dimension

n: Stations

n	2	3	4	5	6	7	8	9	10	11	12	13	14	15	16	17	18	19	20
L1	160.5	185.5	198	210.5	223	248	260.5	273	298	310.5	323	335.5	360.5	373	385.5	410.5	423	435.5	448
L2	150	175	187.5	200	212.5	237.5	250	262.5	287.5	300	312.5	325	350	362.5	375	400	412.5	425	437.5
L3	135.3	151.3	167.3	183.3	199.3	215.3	231.3	247.3	263.3	279.3	295.3	311.3	327.3	343.3	359.3	375.3	391.3	407.3	423.3
L4	12.5	17	15.5	13.5	12	16.5	14.5	13	17.5	15.5	14	12	16.5	15	13	17.5	16	14	12.5

Dimensions: Series 10-SV2000 for Circular Connector

• Tie-rod base manifold: 10-SS5V2-W10CD-**Stations** $\begin{matrix} U \\ D \end{matrix}$ (R) - C4, N3
C6, N7 (-D) C8, N9

• When P, E port outlets are indicated on the U side or D side, the P, E ports on the opposite side are plugged.
• External pilot port positions are the same as P, E port outlet positions.

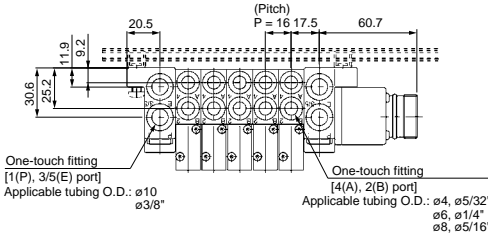

With external pilot specifications

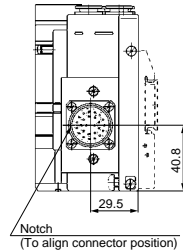
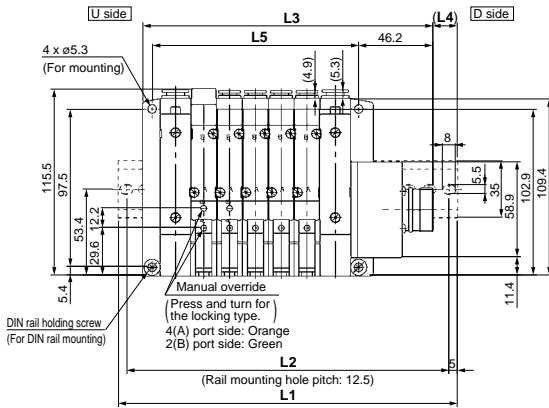
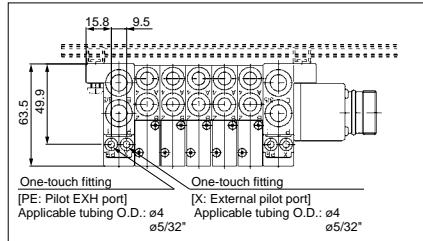

(Station n) - - - - - (Station 1)

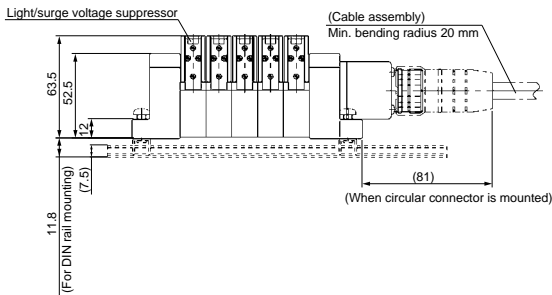

With option

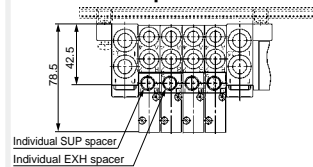

L Dimension

n: Stations

n	2	3	4	5	6	7	8	9	10	11	12	13	14	15	16	17	18	19	20
L1	160.5	173	198	210.5	223	235.5	260.5	273	285.5	310.5	323	335.5	348	373	385.5	398	423	435.5	448
L2	150	162.5	187.5	200	212.5	225	250	262.5	275	300	312.5	325	337.5	362.5	375	387.5	412.5	425	437.5
L3	132.2	148.2	164.2	180.2	196.2	212.2	228.2	244.2	260.2	276.2	292.2	308.2	324.2	340.2	356.2	372.2	388.2	404.2	420.2
L4	14	12.5	17	15	13.5	11.5	16	14.5	12.5	17	15.5	13.5	12	16.5	14.5	13	17.5	15.5	14
L5	80	96	112	128	144	160	176	192	208	224	240	256	272	288	304	320	336	352	368

Dimensions: Series 10-SV3000 for Circular Connector

• Tie-rod base manifold: 10-SS5V3-W10CD- Stations $\frac{U}{D}$ (R) - C6, N7, C8, N9, C10, N11 (-D)

- When P, E port outlets are indicated on the U side or D side, the P, E ports on the opposite side are plugged.
- External pilot port positions are the same as P, E port outlet positions.

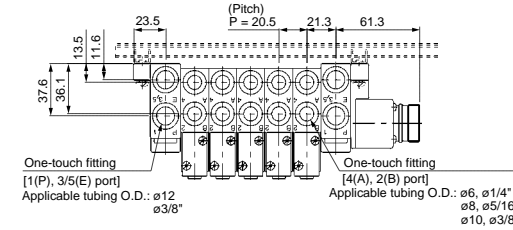

With external pilot specifications

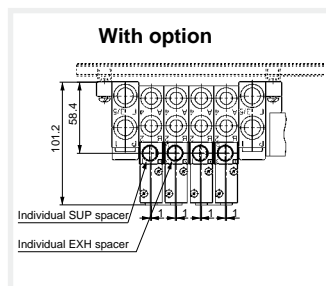
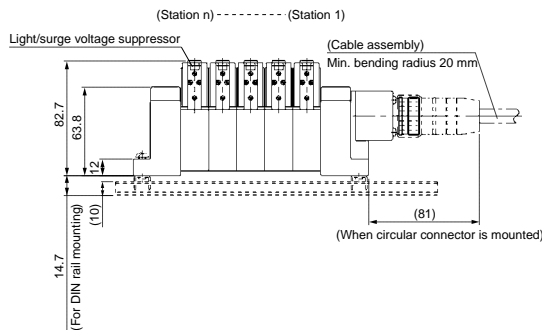
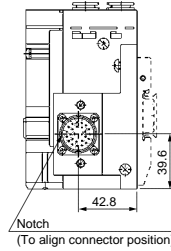
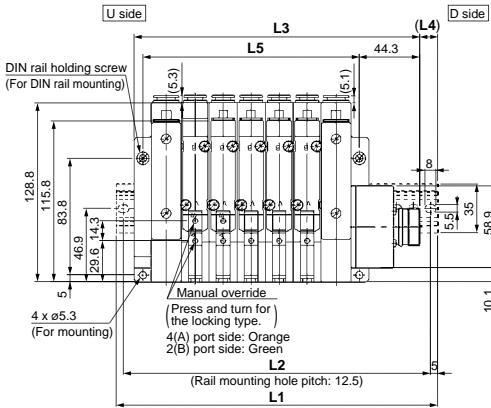
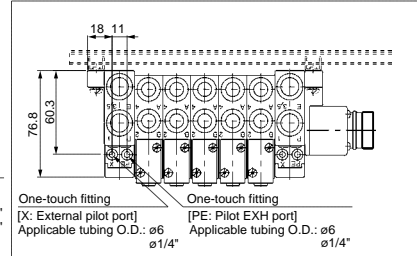

L Dimension

n: Stations

n	2	3	4	5	6	7	8	9	10	11	12	13	14	15	16	17	18	19	20
L1	173	198	223	235.5	260.5	285.5	298	323	335.5	360.5	385.5	398	423	448	460.5	485.5	510.5	523	548
L2	162.5	187.5	212.5	225	250	275	287.5	312.5	325	350	375	387.5	412.5	437.5	450	475	500	512.5	537.5
L3	147.8	168.3	188.8	209.3	229.8	250.3	270.8	291.3	311.8	332.3	352.8	373.3	393.8	414.3	434.8	455.3	475.8	496.3	516.8
L4	12.5	15	17	13	15.5	17.5	13.5	16	12	14	16.5	12.5	14.5	17	13	15	17.5	13.5	15.5
L5	97	117.5	138	158.5	179	199.5	220	240.5	261	281.5	302	322.5	343	363.5	384	404.5	425	445.5	466

Dimensions: Series 10-SV4000 for Circular Connector

• Tie-rod base manifold: **10-SS5V4-W10CD-** Stations $\begin{matrix} U \\ D \end{matrix}$ (R) - $\begin{matrix} 02 \\ 03 \end{matrix}$ $\begin{matrix} C8, N9 \\ C10, N11 \end{matrix}$ (-D)

• When P, E port outlets are indicated on the U side or D side, the P, E ports on the opposite side are plugged.
 • External pilot port positions are the same as P, E port outlet positions.

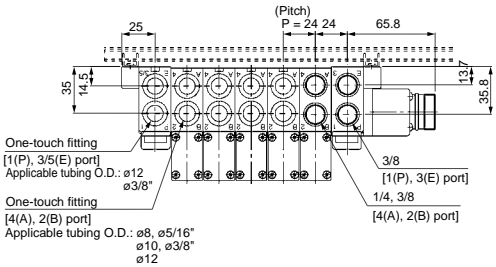

With external pilot specifications

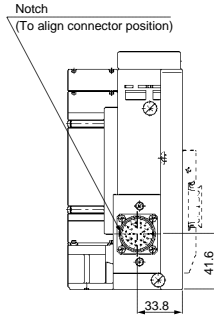
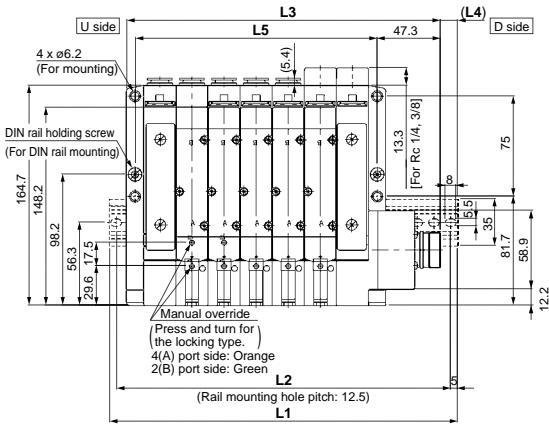
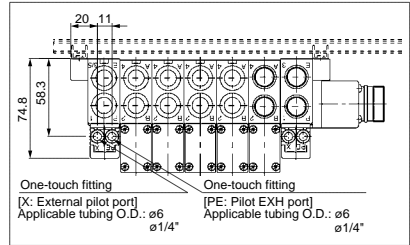

(Station n) ----- (Station 1)

Light/surge voltage suppressor

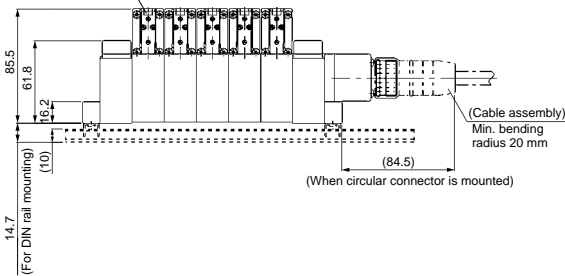

With option

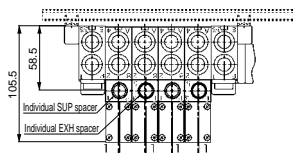

L Dimension

n: Stations

n	2	3	4	5	6	7	8	9	10	11	12	13	14	15	16	17	18	19	20
L1	198	210.5	235.5	260.5	285.5	310.5	335.5	360.5	385.5	410.5	435.5	460.5	485.5	498	523	548	573	598	623
L2	187.5	200	225	250	275	300	325	350	375	400	425	450	475	487.5	512.5	537.5	562.5	587.5	612.5
L3	162.8	186.8	210.8	234.8	258.8	282.8	306.8	330.8	354.8	378.8	402.8	426.8	450.8	474.8	498.8	522.8	546.8	570.8	594.8
L4	17.5	12	12.5	13	13.5	14	14.5	15	15.5	16	16.5	17	17.5	11.5	12	12.5	13	13.5	14
L5	109	133	157	181	205	229	253	277	301	325	349	373	397	421	445	469	493	517	541

D-sub Connector



Tie-rod base

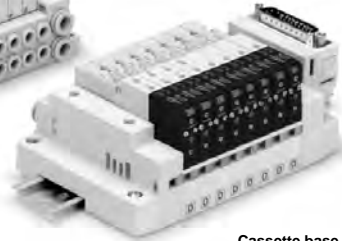

Cassette base

Applicable series	Cassette base manifold 10-SV1000/10-SV2000
	Tie-rod base manifold 10-SV1000/10-SV2000/10-SV3000/10-SV4000
<ul style="list-style-type: none"> · Number of connectors: 25 pins · MIL-C-24308 · Conforming to JIS-X-5101 	

Directional Control Valves

Air Cylinders

Rotary Actuators

Air Grippers

Air Preparation Equipment

Modular F. R.

Pressure Control Equipment

Fittings & Tubing

Flow Control Equipment

Pressure Switches/ Pressure Sensors

Series 10-SV D-sub Connector



How to Order

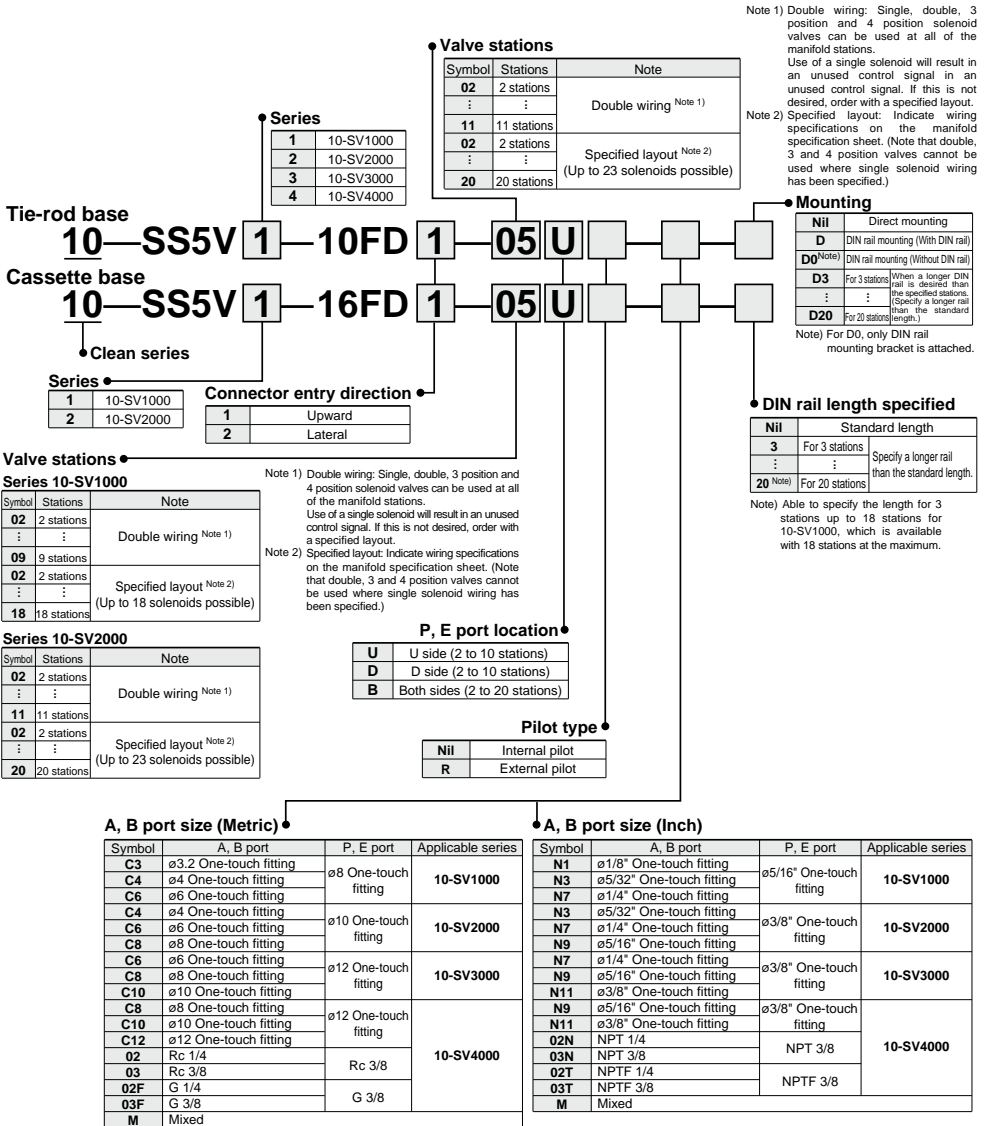

* For mixed specifications (M), indicate separately on the manifold specification sheet.

* External pilot type (R) X, PE port sizes are ø4 (metric), ø5/32" (inch) for the 10-SV1000/2000 series and ø6 (metric), ø1/4" (inch) for the 10-SV3000/4000 series.

Manifold Electrical Wiring

10F/16F D-sub connector type (25 pins)

· This circuit is for the double wiring specification with up to 11 stations. Since the usable number of solenoids differs depending on the manifold type, refer to the table below.
 For single solenoids, connect to SOL.A. Furthermore, when wiring is specified on the manifold specification sheet, connections are made without skipping any connectors, and signals A for single and A, B for double are in order 1→14→2→15, etc.
 · Stations are counted from the D side (connector side) as the 1st one.
 · Since solenoid valves do not have polarity, either the +COM or -COM can be use.

Usable No. of Solenoids

Model		Max. no. of solenoids
Type 10, Tie-rod base	10-SV1000	23
	to 10-SV4000	
Type 16, Cassette base	10-SV1000	18
	10-SV2000	23

Dimensions: Series 10-SV2000 for D-sub Connector

• Cassette base manifold: 10-SS5V2-16FD₂ - [Stations] $\frac{U}{D}$ (R) $\begin{matrix} C4, N3 \\ C6, N7 \\ C8, N9 \end{matrix}$

• When P, E port outlets are indicated on the U side or D side, the P, E ports on the opposite side are plugged.
 • External pilot port positions are the same as P, E port outlet positions.

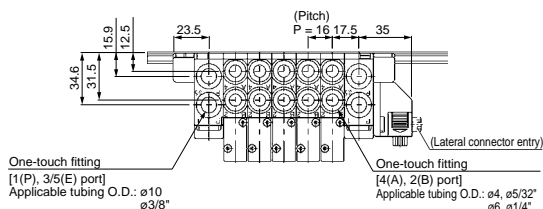

With external pilot specifications

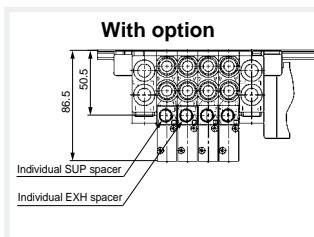
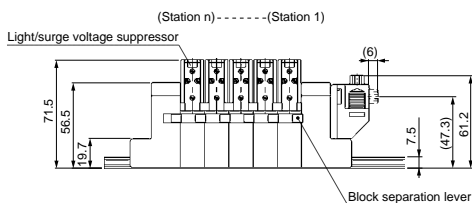
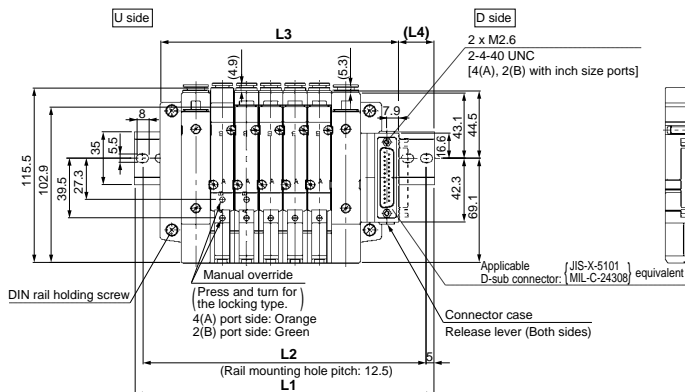
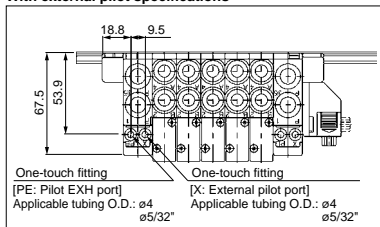

L Dimension

n	2	3	4	5	6	7	8	9	10	11	12	13	14	15	16	17	18	19	20
L1	148	160.5	173	198	210.5	223	235.5	260.5	273	285.5	310.5	323	335.5	348	373	385.5	398	423	435.5
L2	137.5	150	162.5	187.5	200	212.5	225	250	262.5	275	300	312.5	325	337.5	362.5	375	387.5	412.5	425
L3	109.5	125.5	141.5	157.5	173.5	189.5	205.5	221.5	237.5	253.5	269.5	285.5	301.5	317.5	333.5	349.5	365.5	381.5	397.5
L4	22.5	20.5	19	23.5	21.5	20	18	22.5	21	19	23.5	22	20	18.5	23	21	19.5	24	22

n: Stations

Dimensions: Series 10-SV1000 for D-sub Connector

• Tie-rod base manifold: 10-SS5V1-10FD₂ - [Stations] ^U_B (R)- C3, N1 C4, N3 C6, N7 -(D)

- When P, E port outlets are indicated on the U side or D side, the P, E ports on the opposite side are plugged.
- External pilot port positions are the same as P, E port outlet positions.

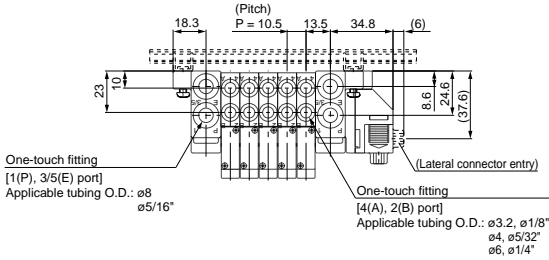

With external pilot specifications

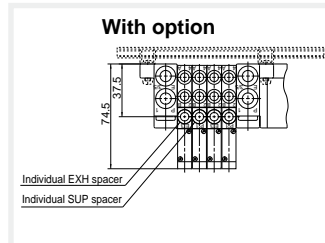
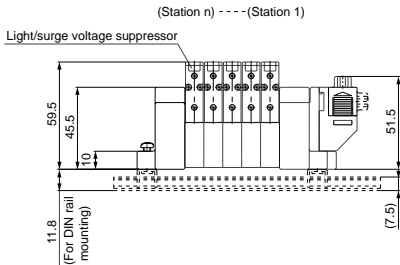
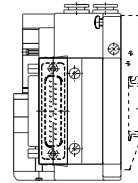
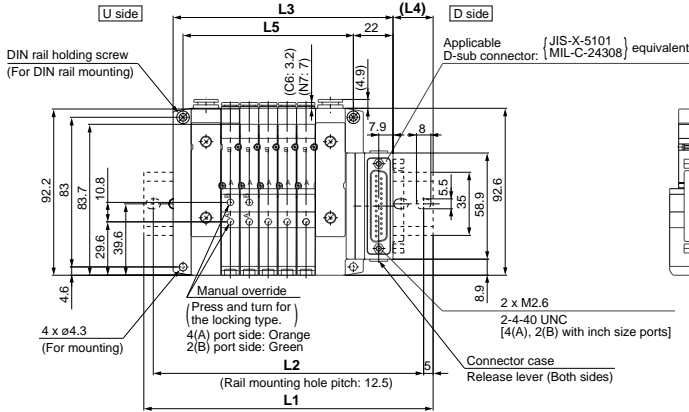
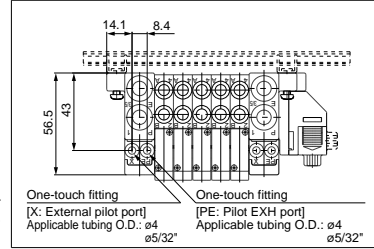

L Dimension

L	n	2	3	4	5	6	7	8	9	10	11	12	13	14	15	16	17	18	19	20
L1	123	135.5	148	160.5	173	173	185.5	198	210.5	223	235.5	235.5	248	260.5	273	285.5	298	310.5	310.5	
L2	112.5	125	137.5	150	162.5	162.5	175	187.5	200	212.5	225	225	237.5	250	262.5	275	287.5	300	300	
L3	90.5	101	111.5	122	132.5	143	153.5	164	174.5	185	195.5	206	216.5	227	237.5	248	258.5	269	279.5	
L4	19.5	20.5	21.5	22.5	23.5	18	19	20	21	22	23	18	19	20	21	22	23	24	18.5	
L5	63	73.5	84	94.5	105	115.5	126	136.5	147	157.5	168	178.9	189	199.5	210	220.5	231	241.5	252	

n: Stations

Directional Control Valves

Air Cylinders

Rotary Actuators

Air Grippers

Air Preparation Equipment

Modular F. R.

Pressure Control Equipment

Fittings & Tubing

Flow Control Equipment

Pressure Switches/ Pressure Sensors

Dimensions: Series 10-SV3000 for D-sub Connector

• Tie-rod base manifold: 10-SS5V3-10FD $\frac{1}{2}$ - [Stations] $\frac{U}{B}$ (R)- C6, N7
C8, N9 (-D) C10, N11

• When P, E port outlets are indicated on the U side or D side, the P, E ports on the opposite side are plugged.
• External pilot port positions are the same as P, E port outlet positions.

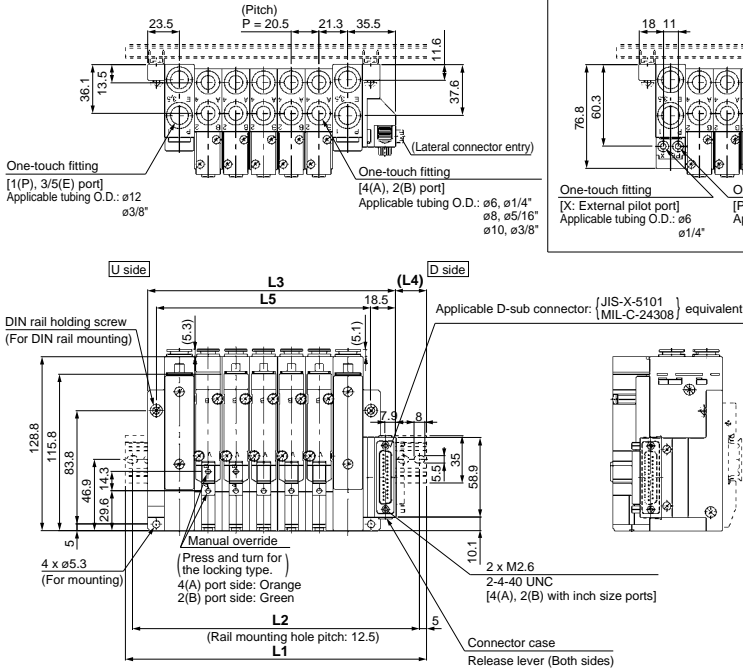

With external pilot specifications

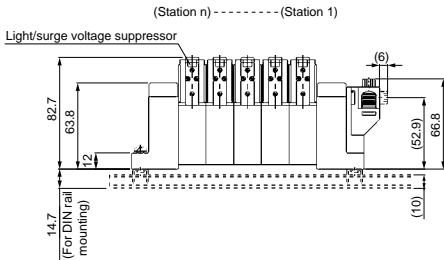
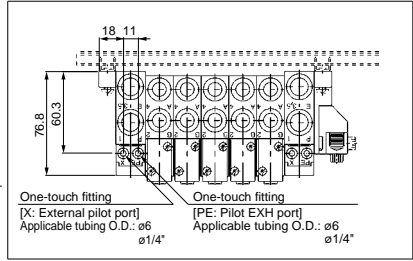

With option

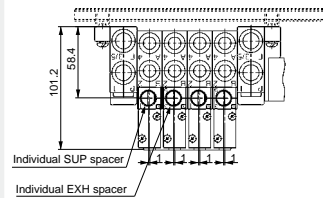

L Dimension

n	2	3	4	5	6	7	8	9	10	11	12	13	14	15	16	17	18	19	20
L1	160.5	173	198	223	235.5	260.5	285.5	298	323	348	360.5	385.5	398	423	448	460.5	485.5	510.5	523
L2	150	162.5	187.5	212.5	225	250	275	287.5	312.5	337.5	350	375	387.5	412.5	437.5	450	475	500	512.5
L3	122	142.5	163	183.5	204	224.5	245	265.5	286	306.5	327	347.5	368	388.5	409	429.5	450	470.5	491
L4	22.5	18.5	20.5	23	19	21	23.5	19.5	21.5	24	20	22	18	20.5	22.5	18.5	21	23	19
L5	97	117.5	138	158.5	179	199.5	220	240.5	261	281.5	302	322.5	343	363.5	384	404.5	425	445.5	466

Directional Control Valves

Air Cylinders

Rotary Actuators

Air Grippers

Air Preparation Equipment

Modular F. R.

Pressure Control Equipment

Fittings & Tubing

Flow Control Equipment

Pressure Switches/ Pressure Sensors

Flat Ribbon Cable Connector

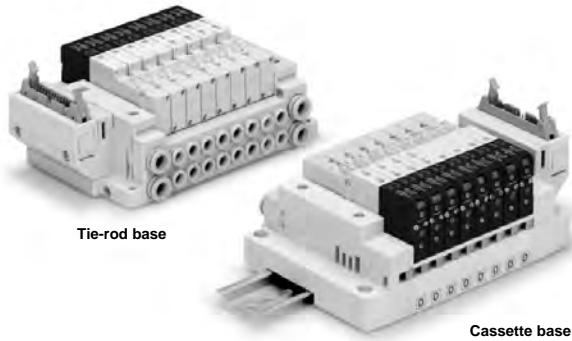

Applicable series	Cassette base manifold 10-SV1000/10-SV2000
	Tie-rod base manifold 10-SV1000/10-SV2000/10-SV3000/10-SV4000
<ul style="list-style-type: none"> · Number of connectors: 26, 20, 10 pins · With strain relief · Conforming to MIL-C-83503 	

Directional
Control Valves

Air Cylinders

Rotary Actuators

Air Grippers

Air Preparation
Equipment

Modular F. R.

Pressure Control
Equipment

Fittings & Tubing

Flow Control
Equipment

Pressure Switches/
Pressure Sensors

Series 10-SV

Flat Ribbon Cable Connector



How to Order

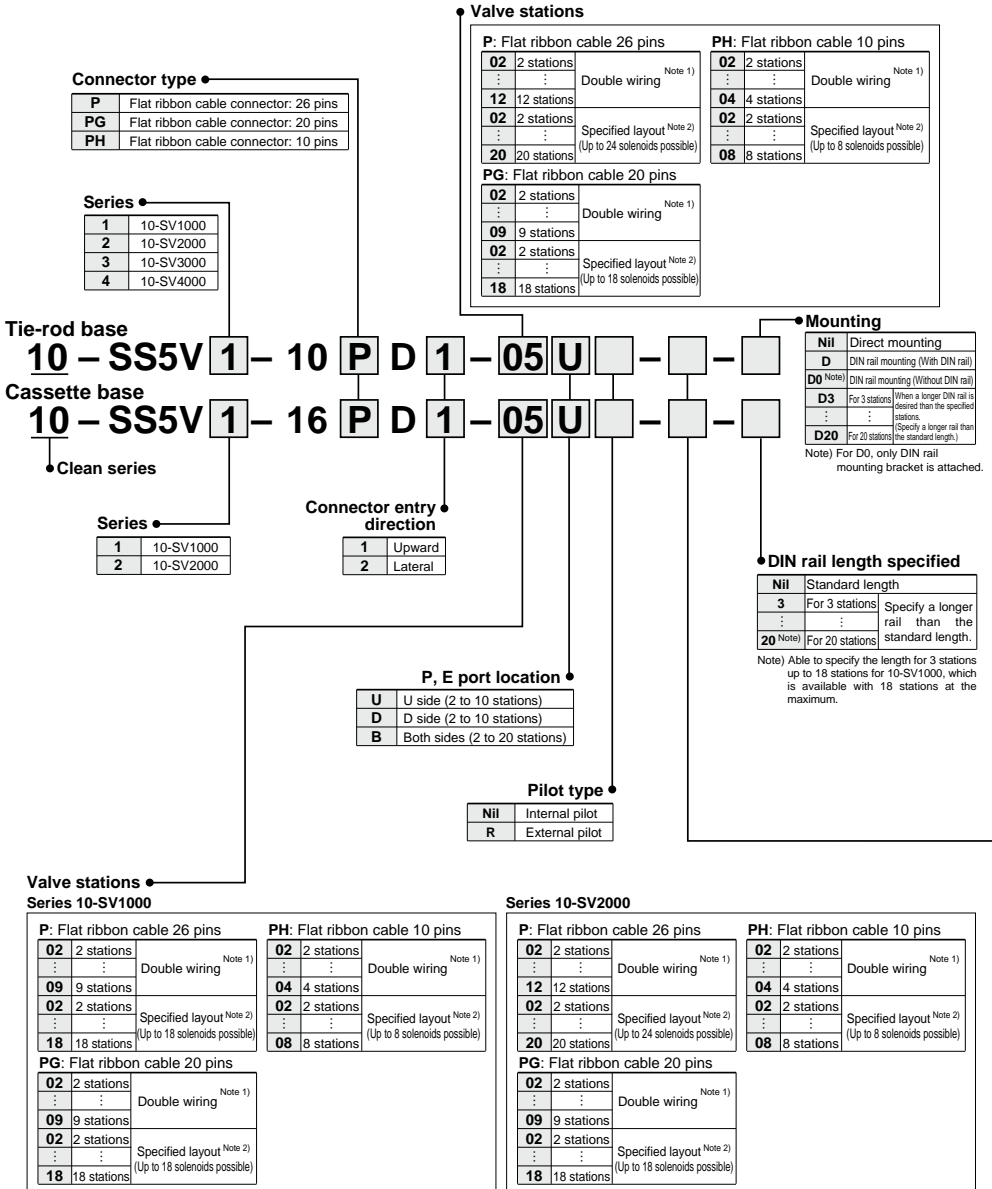

Note 1) Double wiring: Single, double, 3 position and 4 position solenoid valves can be used on all manifold stations. Use of a single solenoid will result in an unused control signal. If this is not desired, order with a specified layout.

Note 2) Specified layout: Indicate wiring specifications on the manifold specification sheet. (Note that double, 3 and 4 position valves cannot be used where single solenoid wiring has been specified.)

How to Order Valve Manifold Assembly

Ordering example (10-SV1000)

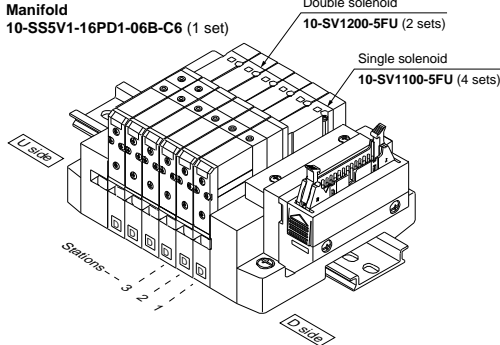

10-SS5V1-16PD1-06B-C6.....1 set (Manifold part no.)
 * **10-SV1100-5FU**.....4 sets (Single solenoid part no.)
 * **10-SV1200-5FU**.....2 sets (Double solenoid part no.)

How to Order Solenoid Valve

10 - SV 1 1 0 0 [] [] [] [] - **5 F** [] [] [] [] - [] [] [] [] (Note)

Clean series

Series

1	10-SV1000
2	10-SV2000
3	10-SV3000
4	10-SV4000

Actuation type

1	2 position single solenoid
2	2 position double solenoid
3	3 position closed center
4	3 position exhaust center
5	3 position pressure center
A	4 position dual 3 port valve: N.C./N.C.
B	4 position dual 3 port valve: N.O./N.O.
C	4 position dual 3 port valve: N.C./N.O.

* 4 position dual 3 port valves are applicable to the 10-SV1000 and 10-SV2000 series only.

Pilot type

Nil	Internal pilot
R	External pilot

* External pilot specifications are not available for 4 position dual 3 port valves.

Rated voltage

5	24 VDC
6	12 VDC

Back pressure check valve

Nil	None
K	Built-in

* The built-in back pressure check valve type is applicable to the 10-SV1000 series only.
 * The product with back pressure check valve is not available for 3 position solenoid valves.
 (Note) Refer to the Specific Product Precautions 2 on page 274.

(Note) Available with manifold block for station additions. Refer to the **WEB catalog**.

Made to Order

Nil	—
X90	Main valve fluororubber (Refer to page 272.)

Manual override

Nil: Non-locking push type

D: Push-turn locking slotted type

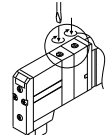
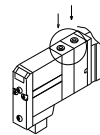

Light/surge voltage suppressor

U	With light/surge voltage suppressor
R	With surge voltage suppressor

A, B port size (Metric)

Symbol	A, B port	P, E port	Applicable series
C3	ø3.2 One-touch fitting	ø8 One-touch fitting	10-SV1000
C4	ø4 One-touch fitting		
C6	ø6 One-touch fitting		
C4	ø4 One-touch fitting	ø10 One-touch fitting	10-SV2000
C6	ø6 One-touch fitting		
C8	ø8 One-touch fitting		
C6	ø6 One-touch fitting	ø12 One-touch fitting	10-SV3000
C8	ø8 One-touch fitting		
C10	ø10 One-touch fitting		
C8	ø8 One-touch fitting	ø12 One-touch fitting	10-SV4000
C10	ø10 One-touch fitting		
C12	ø12 One-touch fitting		
02	Rc 1/4	Rc 3/8	10-SV4000
03	Rc 3/8		
02F	G 1/4		
03F	G 3/8		
M	Mixed		

A, B port size (Inch)

Symbol	A, B port	P, E port	Applicable series
N1	ø1/8" One-touch fitting	ø5/16" One-touch fitting	10-SV1000
N3	ø5/32" One-touch fitting		
N7	ø1/4" One-touch fitting		
N3	ø5/32" One-touch fitting	ø3/8" One-touch fitting	10-SV2000
N7	ø1/4" One-touch fitting		
N9	ø5/16" One-touch fitting		
N7	ø1/4" One-touch fitting	ø3/8" One-touch fitting	10-SV3000
N9	ø5/16" One-touch fitting		
N11	ø3/8" One-touch fitting		
N9	ø5/16" One-touch fitting	ø3/8" One-touch fitting	10-SV4000
N11	ø3/8" One-touch fitting		
02N	NPT 1/4		
03N	NPT 3/8		
02T	NPTF 1/4	NPTF 3/8	
03T	NPTF 3/8		
M	Mixed		

* For mixed specifications (M), indicate separately on the manifold specification sheet.

* External pilot type (R) X, PE port sizes are ø4 (metric), ø5/32" (inch) for the 10-SV1000/2000 series and ø6 (metric), ø1/4" (inch) for the 10-SV3000/4000 series.

Manifold Electrical Wiring

10P/16P flat ribbon cable type (26 pins)

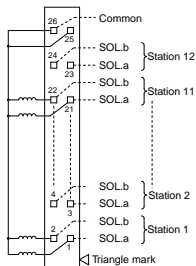

-This circuit is for the double wiring specification with up to 12 stations. Since the usable number of solenoids differs depending on the manifold type, refer to the table below. For single solenoids, connect to SOL.A. Furthermore, when wiring is specified on the manifold specification sheet, connections are made without skipping any connectors, and signals A for single and A, B for double are in order 1 → 2 → 3 → 4, etc.

-Stations are counted from the D side (connector side) as the 1st one.
 -Since terminal numbers are not indicated on the flat ribbon cable, use the triangle mark as a reference for wiring.
 -Since solenoid valves do not have polarity, either the +COM or -COM can be used.

Usable no. of solenoids

Model	Max. no. of solenoids
Type 10, Tie-rod base	24
10-SV1000 to 10-SV4000	
Type 16, Cassette base	18
10-SV1000 to 10-SV2000	24

10PG/16PG flat ribbon cable type (20 pins)

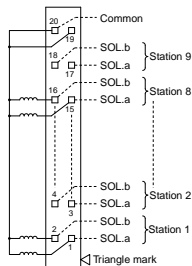

-This circuit is for the double wiring specification with up to 9 stations. Since the usable number of solenoids differs depending on the manifold type, refer to the table below. For single solenoids, connect to SOL.A. Furthermore, when wiring is specified on the manifold specification sheet, connections are made without skipping any connectors, and signals A for single and A, B for double are in order 1 → 2 → 3 → 4, etc.

-Stations are counted from the D side (connector side) as the 1st one.
 -Since terminal numbers are not indicated on the flat ribbon cable, use the triangle mark as a reference for wiring.
 -Since solenoid valves do not have polarity, either the +COM or -COM can be used.

Usable no. of solenoids

Model	Max. no. of solenoids
Type 10, Tie-rod base	18
10-SV1000 to 10-SV4000	
Type 16, Cassette base	18
10-SV1000 to 10-SV2000	

10PH/16PH flat ribbon cable type (10 pins)

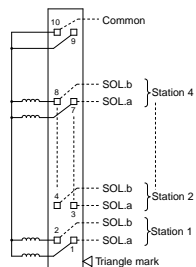

-This circuit is for the double wiring specification with up to 4 stations. Since the usable number of solenoids differs depending on the manifold type, refer to the table below. For single solenoids, connect to SOL.A. Furthermore, when wiring is specified on the manifold specification sheet, connections are made without skipping any connectors, and signals A for single and A, B for double are in order 1 → 2 → 3 → 4, etc.

-Stations are counted from the D side (connector side) as the 1st one.
 -Since terminal numbers are not indicated on the flat ribbon cable, use the triangle mark as a reference for wiring.
 -Since solenoid valves do not have polarity, either the +COM or -COM can be used.

Usable no. of solenoids

Model	Max. no. of solenoids
Type 10, Tie-rod base	8
10-SV1000 to 10-SV4000	
Type 16, Cassette base	8
10-SV1000 to 10-SV2000	

Dimensions: Series 10-SV1000 for Flat Ribbon Cable

• **Cassette base manifold: 10-SS5V1-16^P_{PG} D₁ - [Stations] U_D (R) - C3, N1
C4, N3
C6, N7**

• When P, E port outlets are indicated on the U side or D side, the P, E ports on the opposite side are plugged.
• External pilot port positions are the same as P, E port outlet positions.

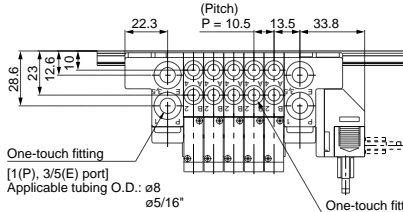

With external pilot specifications

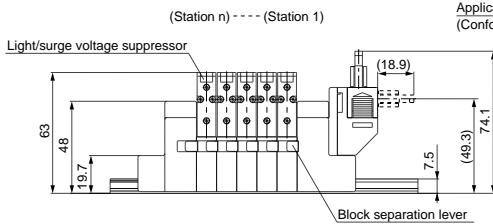
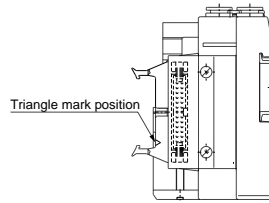
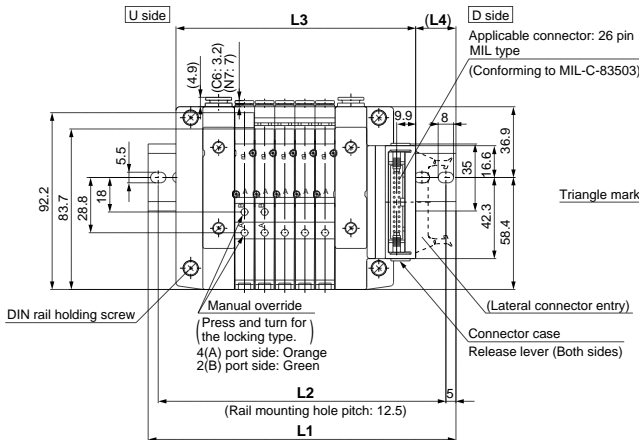
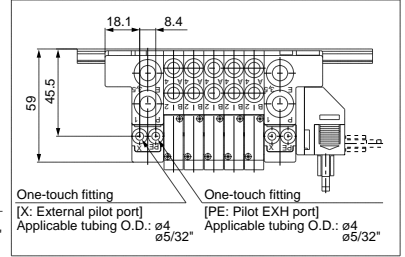

Applicable connector: 20 pin MIL type (Conforming to MIL-C-83503)

Applicable connector: 10 pin MIL type (Conforming to MIL-C-83503)

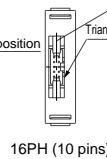
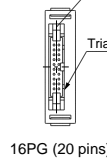

Refer to page 244 (for D-sub connector) for dimensions with individual SUP/EXH spacer.

L Dimension

n	2	3	4	5	6	7	8	9	10	11	12	13	14	15	16	17	18
L1	135.5	135.5	148	160.5	173	185.5	198	198	210.5	223	235.5	248	260.5	260.5	273	285.5	298
L2	125	125	137.5	150	162.5	175	187.5	187.5	200	212.5	225	237.5	250	250	262.5	275	287.5
L3	93.5	104	114.5	125	135.5	146	156.5	167	177.5	188	198.5	209	219.5	230	240.5	251	261.5
L4	24.5	19	20	21	22	23	24	19	20	21	22	23	24	18.5	19.5	20.5	21.5

Dimensions: Series 10-SV1000 for Flat Ribbon Cable

• Tie-rod base manifold: 10-SS5V1-10^P_{PH} D₂ - [Stations] $\frac{U}{B}$ (R) - C_{3, N1} C_{4, N3} C_{6, N7} (-D)

• When P, E port outlets are indicated on the U side or D side, the P, E ports on the opposite side are plugged.
 • External pilot port positions are the same as P, E port outlet positions.

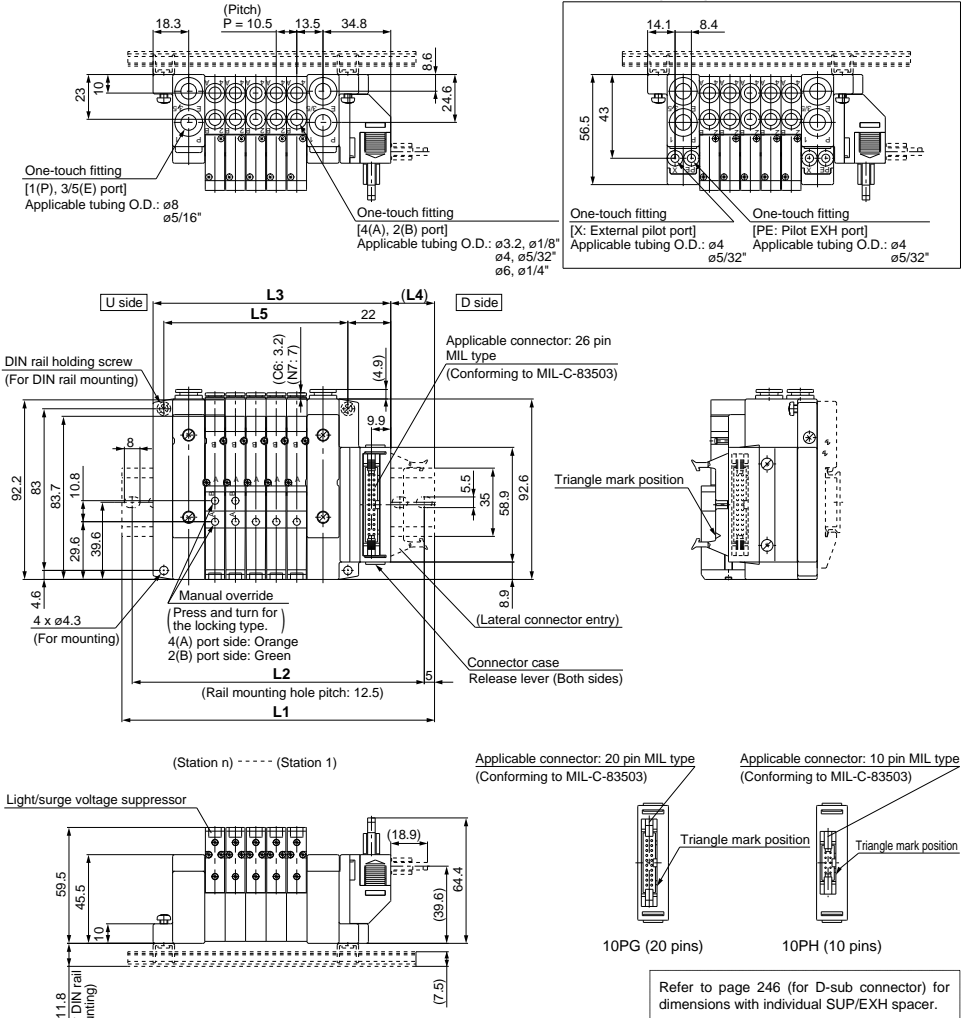

L Dimension

n	2	3	4	5	6	7	8	9	10	11	12	13	14	15	16	17	18	19	20
L1	123	135.5	148	160.5	173	173	185.5	198	210.5	223	235.5	248	248	260.5	273	285.5	298	310.5	310.5
L2	112.5	125	137.5	150	162.5	162.5	175	187.5	200	212.5	225	237.5	237.5	250	262.5	275	287.5	300	300
L3	90.5	101	111.5	122	132.5	143	153.5	164	174.5	185	195.5	206	216.5	227	237.5	248	258.5	269	279.5
L4	19.5	20.5	21.5	22.5	23.5	18.5	19.5	20.5	21.5	22.5	23.5	24.5	19	20	21	22	23	24	19
L5	63	73.5	84	94.5	105	115.5	126	136.5	147	157.5	168	178.5	189	199.5	210	220.5	231	241.5	252

Directional Control Valves

Air Cylinders

Rotary Actuators

Air Grippers

Air Preparation Equipment

Modular F. R.

Pressure Control Equipment

Fittings & Tubing

Flow Control Equipment

Pressure Switches/ Pressure Sensors

Dimensions: Series 10-SV2000 for Flat Ribbon Cable

• Tie-rod base manifold: 10-SS5V2-10^P_{PH} D₂ - Stations $\frac{U}{B}$ (R) - C4, N3
C6, N7 (D) C8, N9 (-D)

- When P, E port outlets are indicated on the U side or D side, the P, E ports on the opposite side are plugged.
- External pilot port positions are the same as P, E port outlet positions.

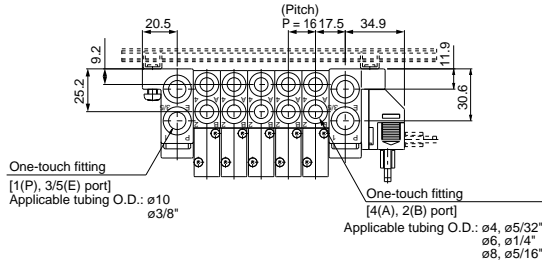

With external pilot specifications

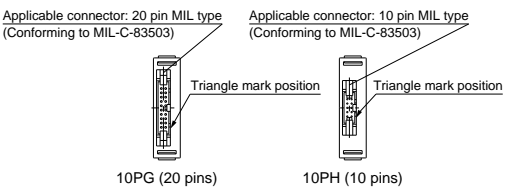
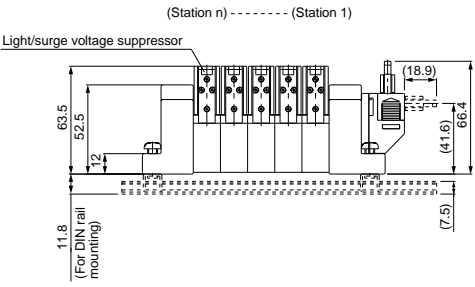
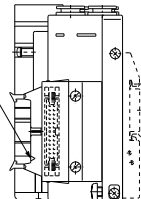
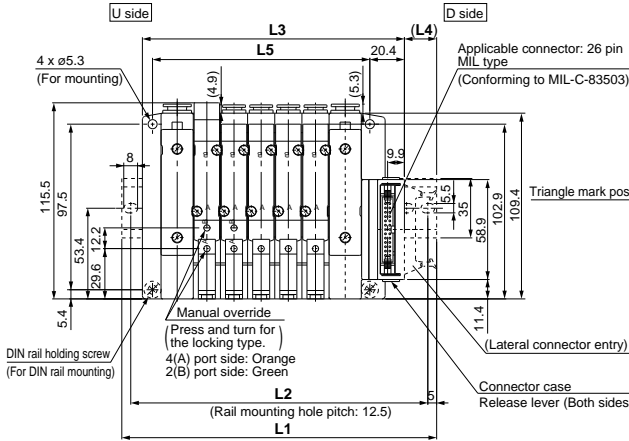
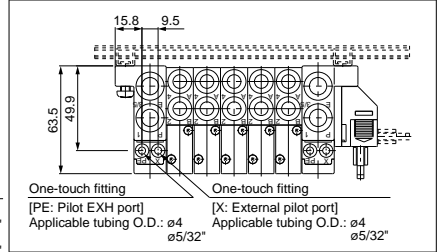

Refer to page 247 (for D-sub connector) for dimensions with individual SUP/EXH spacer.

L Dimension

n	2	3	4	5	6	7	8	9	10	11	12	13	14	15	16	17	18	19	20
L1	148	160.5	173	185.5	210.5	223	235.5	248	273	285.5	298	323	335.5	348	360.5	385.5	398	410.5	435.5
L2	137.5	150	162.5	175	200	212.5	225	237.5	262.5	275	287.5	312.5	325	337.5	350	375	387.5	400	425
L3	106.4	122.4	138.4	154.4	170.4	186.4	202.4	218.4	234.4	250.4	266.4	282.4	298.4	314.4	330.4	346.4	362.4	378.4	394.4
L4	24	22.5	20.5	19	23.5	21.5	20	18	22.5	21	19	23.5	22	20	18.5	23	21	19.5	24
L5	80	96	112	128	144	160	176	192	208	224	240	256	272	288	304	320	336	352	368

Dimensions: Series 10-SV4000 for Flat Ribbon Cable

• Tie-rod base manifold: 10-SS5V4-10^P_{PH} D₂- [Stations] U_B (R) - 02^{C8}_{C10} 03^{N9}_{C12} N₁₁ (-D)

• When P, E port outlets are indicated on the U side or D side, the P, E ports on the opposite side are plugged.
 • External pilot port positions are the same as P, E port outlet positions.

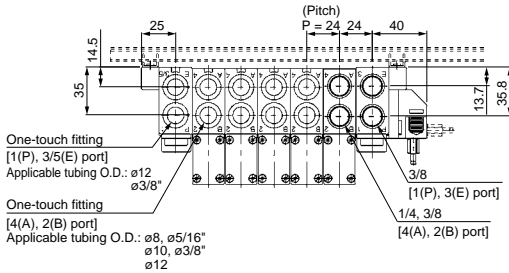

With external pilot specifications

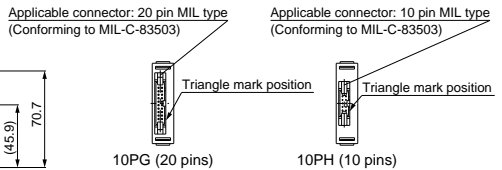
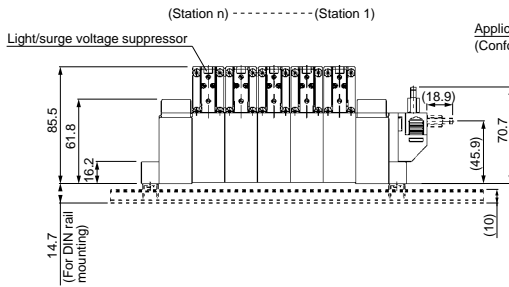
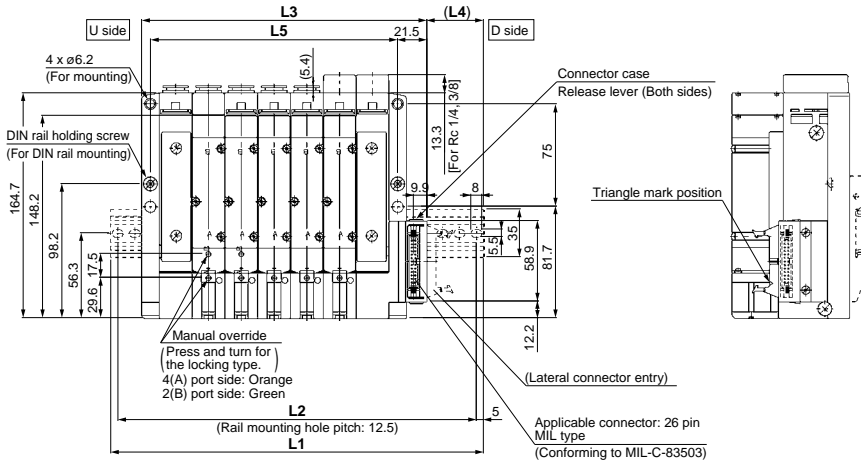
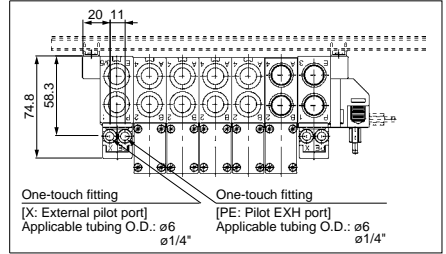

Refer to page 249 (for D-sub connector) for dimensions with individual SUP/EXH spacer.

L Dimension

L	n	2	3	4	5	6	7	8	9	10	11	12	13	14	15	16	17	18	19	20
L1	185.5	210.5	235.5	260.5	285.5	310.5	335.5	348	373	398	423	448	473	498	523	548	573	598	623	
L2	175	200	225	250	275	300	325	337.5	362.5	387.5	412.5	437.5	462.5	487.5	512.5	537.5	562.5	587.5	612.5	
L3	137	161	185	209	233	257	281	305	329	353	377	401	425	449	473	497	521	545	569	
L4	31.5	31.5	31.5	31.5	31.5	31.5	31.5	31.5	31.5	31.5	31.5	31.5	31.5	31.5	31.5	31.5	31.5	31.5	31.5	31.5
L5	109	133	157	181	205	229	253	277	301	325	349	373	397	421	445	469	493	517	541	

Series 10-SV Manifold Option (Common for Type 16 and 10)

Relay output module

By adding a relay output module to the 10-SV series manifold, devices up to 110 VAC, 3 A (large type solenoid valves, etc.) can be controlled together with 10-SV series valves.

How to Order

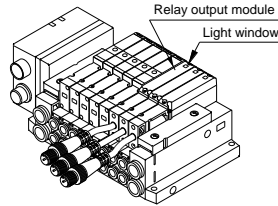
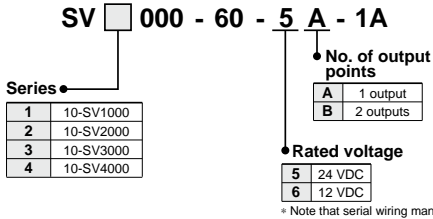

Relay output module specifications

Item	Specifications			
	1 output [connector with lead wire (M12)]		2 outputs [connector with lead wire (M12)]	
No. of output points	1 output [connector with lead wire (M12)]		2 outputs [connector with lead wire (M12)]	
Output type	<p>Contact type ("a" contact)</p>		<p>Contact type ("a" contact)</p>	
Load voltage	110 VAC	30 VDC	110 VAC	30 VDC
Load current	3 A	3 A	0.3 A	1 A
Indicator light	Orange		A side: Orange B side: Green	
Enclosure	Based on IP67 (IEC60529)			
Current consumption	20 mA or less			
Polarity	Non-polar			
Weight (g)	48			

Y type connector

Used to branch a two output relay output module to two separate systems.

How to Order

EX500 - ACY00 - S



Relay output module and Y type connector wiring example

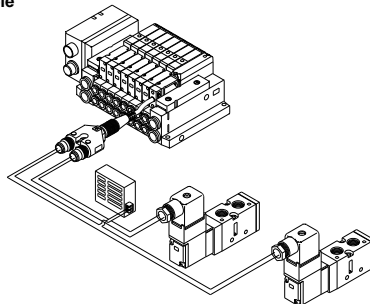
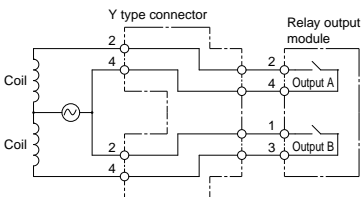

Directional Control Valves
Air Cylinders
Rotary Actuators
Air Grippers
Air Preparation Equipment
Modular F. R.
Pressure Control Equipment
Fittings & Tubing
Flow Control Equipment
Pressure Switches/ Pressure Sensors

Manifold Option

■ Blanking plate assembly

Used in situations where valves will be added in the future.

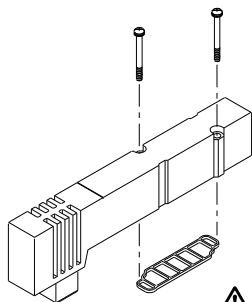

⚠ Caution

Mounting screw tightening torques

Series	Blanking plate assembly part no.
10-SV1000	SV1000-67-1A
10-SV2000	SV2000-67-1A
10-SV3000	SV3000-67-1A
10-SV4000	SV4000-67-1A

M2: 0.15 N·m

M3: 0.6 N·m

M4: 1.4 N·m

■ SUP/EXH block disk

[SUP block disk]

By placing a SUP block disk in a manifold valve's pressure supply passage, two different high and low pressures can be supplied to one manifold.

[EXH block disk]

By installing an EXH block disk in a manifold valve's exhaust passage, the valve's exhaust can be separated so that it will not affect other valves. It can also be used on a manifold with mixed positive pressure and vacuum. (Two pieces are required to block EXH on both sides. However, the 10-SV1000 and 2000 series type 10 manifolds require only one piece.)

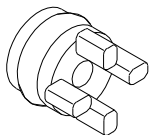

Type 16, Cassette base

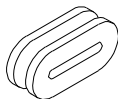

Type 10, Tie-rod base

Series	Manifold type	SUP block disk	EXH block disk
10-SV1000	10	SV1000-59-1A	SV1000-59-2A
	16	SX3000-77-1A	SX3000-77-1A
10-SV2000	10	SV2000-59-1A	SV2000-59-2A
	16	SV2000-59-3A	SV2000-59-3A
10-SV3000	10	SV3000-59-1A	SV3000-59-1A
10-SV4000	10	SY9000-57-1A	SY9000-57-1A

■ Label for block disk

These labels are attached to manifolds in which SUP and EXH block disks have been installed, in order to identify the installed locations. (Three sheets each included.)

SV1000 - 74 - 1A

Label for SUP block disk



Label for EXH block disk



Label for SUP/EXH block disk



* When a block disk is concurrently ordered by specifying on the manifold specification sheet, etc., a label will be stuck on the position where block disk is mounted.

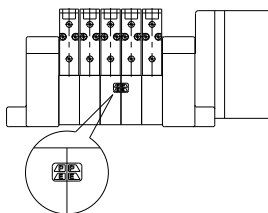

■ Plug (White)

These are inserted in unused cylinder ports and P, E ports.

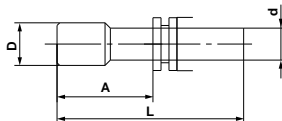

Applicable fitting size d	Model	A	L	D
ø4	10-KQP-04	16	32	ø6
ø6	10-KQP-06	18	35	ø8
ø8	10-KQP-08	20.5	39	ø10
ø10	10-KQP-10	22	43	ø12
ø12	10-KQP-12	24	44.5	ø14
ø1/8"	10-KQP-01	16	31.5	ø5
ø5/32"	10-KQP-03	16	32	ø6
ø1/4"	10-KQP-07	18	35	ø8.5
ø5/16"	10-KQP-09	20.5	39	ø10
ø3/8"	10-KQP-11	22	43	ø11.5

Manifold Option

■Circular connector / Cable assembly (26 pins)

AXT100 – MC26 – □

Lead wire length

Part no.	L dimension
AXT100-MC26-015	1.5 m
AXT100-MC26-030	3 m
AXT100-MC26-050	5 m

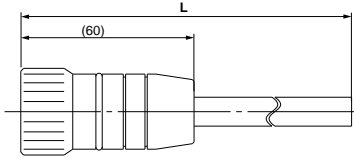

Plug terminal no.
(Arrangement as seen from lead wire side)

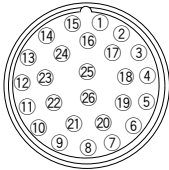

Circular connector cable assembly Terminal no.

Terminal no.	Lead wire color	Dot marking
1	Black	None
2	Brown	None
3	Red	None
4	Orange	None
5	Yellow	None
6	Pink	None
7	Blue	None
8	Purple	White
9	Gray	Black
10	White	Black
11	White	Red
12	Yellow	Red
13	Orange	Red
14	Yellow	Black
15	Pink	Black
16	Blue	White
17	Purple	None
18	Gray	None
19	Orange	Black
20	Red	White
21	Brown	White
22	Pink	Red
23	Gray	Red
24	Black	White
25	White	None

Note) Terminal no. 26 is connected to 25 inside the connector.

■D-sub connector / Cable assembly (25 pins)

AXT100 – DS25 – □

Lead wire length

Part no.	L dimension
AXT100-DS25-015	1.5 m
AXT100-DS25-030	3 m
AXT100-DS25-050	5 m

When a commercially available connector is required, use a 25 pin female connector conforming to MIL-C-24308.

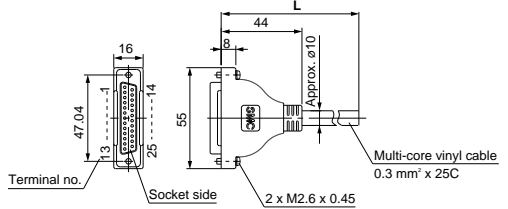

D-sub connector cable assembly Terminal no.

Terminal no.	Lead wire color	Dot marking
1	Black	None
2	Brown	None
3	Red	None
4	Orange	None
5	Yellow	None
6	Pink	None
7	Blue	None
8	Purple	White
9	Gray	Black
10	White	Black
11	White	Red
12	Yellow	Red
13	Orange	Red
14	Yellow	Black
15	Pink	Black
16	Blue	White
17	Purple	None
18	Gray	None
19	Orange	Black
20	Red	White
21	Brown	White
22	Pink	Red
23	Gray	Red
24	Black	White
25	White	None

Circular connector, D-sub connector cable assembly Electric characteristics

Item	Characteristics
Conductor resistance Ω/km, 20°C	65 or less
Withstand voltage VAC, 1 minute	1000
Insulation resistance MΩkm, 20°C	5 or less

Note) The minimum bending radius of each cable is 20 mm.

Manifold Option

■ Flat ribbon cable / Cable assembly

AXT100 – FC□ – □

Cable length (L)	10 pins	20 pins	26 pins
1.5 m	AXT100-FC10-1	AXT100-FC20-1	AXT100-FC26-1
3 m	AXT100-FC10-2	AXT100-FC20-2	AXT100-FC26-2
5 m	AXT100-FC10-3	AXT100-FC20-3	AXT100-FC26-3
Connector width (W)	17.2	30	37.5

* For other commercial connectors, use a type with strain relief conforming to MIL-C-83503.

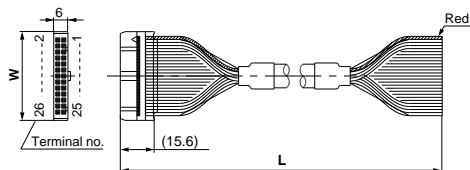

Example of connector manufacturers

- HIROSE ELECTRIC CO., LTD.
- Japan Aviation Electronics Industry, Limited
- 3M Japan Limited
- J.S.T. Mfg. Co., Ltd.
- Fujitsu Limited

■ 10-SV1000/2000 and EX500 series input unit

DIN rail dimensions and weights

VZ1000 – 11 – 1 – □

* As for □, enter the number from the DIN rail dimensions table.

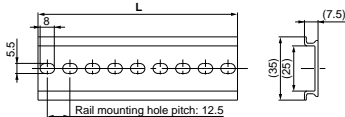

No.	0	1	2	3	4	5	6	7	8	9
L dimension	98	110.5	123	135.5	148	160.5	173	185.5	198	210.5
Weight (g)	17.6	19.9	22.1	24.4	26.6	28.9	31.1	33.4	35.6	37.9
No.	10	11	12	13	14	15	16	17	18	19
L dimension	223	235.5	248	260.5	273	285.5	298	310.5	323	335.5
Weight (g)	40.1	42.4	44.6	46.9	49.1	51.4	53.6	55.9	58.1	60.4
No.	20	21	22	23	24	25	26	27	28	29
L dimension	348	360.5	373	385.5	398	410.5	423	435.5	448	460.5
Weight (g)	62.5	64.9	67.1	69.4	71.6	73.9	76.1	78.4	80.6	82.9
No.	30	31	32	33	34	35	36	37	38	39
L dimension	473	485.5	498	510.5	523	535.5	548	560.5	573	585.5
Weight (g)	85.1	87.4	89.6	91.9	94.1	96.4	98.6	100.9	103.1	105.4
No.	40	41	42	43	44	45	46	47	48	49
L dimension	598	610.5	623	635.5	648	660.5	673	685.5	698	710.5
Weight (g)	107.6	109.9	112.1	114.4	116.6	118.9	121.1	123.4	125.6	127.9
No.	50	51	52	53	54	55	56	57	58	59
L dimension	723	735.5	748	760.5	773	785.5	798	810.5	823	835.5
Weight (g)	130.1	132.4	134.6	136.9	139.1	141.4	143.6	145.9	148.1	150.4
No.	60	61	62	63	64	65	66	67	68	69
L dimension	848	860.5	873	885.5	898	910.5	923	935.5	948	960.5
Weight (g)	152.6	154.9	157.1	159.4	161.6	163.9	166.1	168.4	170.6	172.9
No.	70	71								
L dimension	973	985.5								
Weight (g)	175.1	177.4								

■ 10-SV3000/4000 DIN rail dimensions and weights

VZ1000 – 11 – 4 – □

* As for □, enter the number from the DIN rail dimensions table.

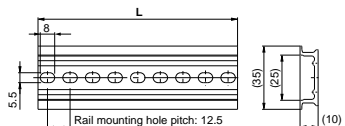

No.	0	1	2	3	4	5	6	7	8	9	10	11	12	13	14	15	16	17	18	19	20
L dimension	98	110.5	123	135.5	148	160.5	173	185.5	198	210.5	223	235.5	248	260.5	273	285.5	298	310.5	323	335.5	348
Weight (g)	24.8	28	31.1	34.3	37.4	40.6	43.8	46.9	50.1	53.3	56.4	59.6	62.7	65.9	69.1	72.2	75.4	78.6	81.7	84.9	88
No.	21	22	23	24	25	26	27	28	29	30	31	32	33	34	35	36	37	38	39	40	41
L dimension	360.5	373	385.5	398	410.5	423	435.5	448	460.5	473	485.5	498	510.5	523	535.5	548	560.5	573	585.5	598	610.5
Weight (g)	91.2	94.4	97.5	100.7	103.9	107	110.2	113.3	116.5	119.7	122.8	126	129.2	132.3	135.5	138.6	141.8	145	148.1	151.3	154.5
No.	42	43	44	45	46	47	48	49	50	51	52	53	54	55	56	57	58	59	60	61	62
L dimension	623	635.5	648	660.5	673	685.5	698	710.5	723	735.5	748	760.5	773	785.5	798	810.5	823	835.5	848	860.5	873
Weight (g)	157.6	160.8	163.9	167.1	170.3	173.4	176.6	179.8	182.9	186.1	189.2	192.4	195.6	198.7	201.9	205.1	208.2	211.4	214.5	217.7	220.9
No.	63	64	65	66	67	68	69	70	71												
L dimension	885.5	898	910.5	923	935.5	948	960.5	973	985.5												
Weight (g)	224	227.2	230.4	233.5	236.7	239.8	243	246.2	249.3												

Manifold Option

Individual SUP spacer assembly

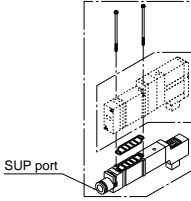

Individual EXH spacer assembly

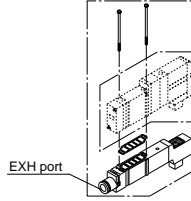

How to order individual SUP/EXH spacer assembly

Series 10-SV1000

SV1000 — **38** — **1A** — **C6**

• **Port size**

C3	ø3.2 One-touch fitting
C4	ø4 One-touch fitting
C6	ø6 One-touch fitting
N1	ø1/8" One-touch fitting
N3	ø5/32" One-touch fitting
N7	ø1/4" One-touch fitting

• **Spacer type**

38	Individual SUP spacer
39	Individual EXH spacer

Series 10-SV2000/10-SV3000/10-SV4000

SV **2 000** — **38** — **1** **A**

• **Series**

2	10-SV2000
3	10-SV3000
4	10-SV4000

• **Thread type** ^(Note)

Nil	Rc
F	G
N	NPT
T	NPTF

Note) 10-SV2000/3000/4000 port size

Series	Port size
10-SV2000	1/8
10-SV3000	1/4
10-SV4000	

Accessory

Series	Round head combination screw	Gasket
10-SV1000	SX3000-22-9 (M2 x 39.5)	SX3000-57-4
10-SV2000	SV2000-21-6 (M3 x 46)	SY5000-11-15
10-SV3000	SV3000-21-3 (M4 x 53)	SY7000-11-11
10-SV4000	SV2000-21-5 (M3 x 60)	SY9000-11-2

Directional Control Valves

Air Cylinders

Rotary Actuators

Air Grippers

Air Preparation Equipment

Modular F. R.

Pressure Control Equipment

Fittings & Tubing

Flow Control Equipment

Pressure Switches/ Pressure Sensors

Series 10-SV1000/2000/3000/4000

Single Unit/Sub-plate Type
[IP67 Compliant]

How to Order

10 - SV 1 1 00 - **5 W1 U D** - - -

Clean series

Series

1	10-SV1000
2	10-SV2000
3	10-SV3000
4	10-SV4000

Actuation type

10-SV1000/2000/3000/4000	
1	2 position single (A)4 2(B) (EA)5 1 3(EB) (P)
2	2 position double (A)4 2(B) (EA)5 1 3(EB) (P)
10-SV1000/2000/3000	
3	3 position closed center (A)4 2(B) (EA)5 1 3(EB) (P)
4	3 position exhaust center (A)4 2(B) (EA)5 1 3(EB) (P)
5	3 position pressure center (A)4 2(B) (EA)5 1 3(EB) (P)
10-SV1000	
A	4 position dual 3 port valve: N.C./N.C. 4(A) 2(B) 5(EA) 1(P) 3(EB)
B	4 position dual 3 port valve: N.O./N.O. 4(A) 2(B) 5(EA) 1(P) 3(EB)
C	4 position dual 3 port valve: N.C./N.O. 4(A) 2(B) 5(EA) 1(P) 3(EB)
10-SV2000	
A	4 position dual 3 port valve: N.C./N.C. 4(A) 2(B) 5(EA) 1(P) 3(EB)
B	4 position dual 3 port valve: N.O./N.O. 4(A) 2(B) 5(EA) 1(P) 3(EB)
C	4 position dual 3 port valve: N.C./N.O. 4(A) 2(B) 5(EA) 1(P) 3(EB)

Pilot type

Nil	Internal pilot
R	External pilot

* External pilot specifications are not available for 4 position dual 3 port valves.

Rated voltage

5	24 VDC
6	12 VDC

Thread type

Nil	Rc
F	G
N	NPT
T	NPTF

Port size

Symbol	Port size	Applicable series
Nil	Without sub-plate	
01	1/8	10-SV1000
02	1/4	10-SV2000
03	3/8	10-SV3000
04	1/2	10-SV4000

Made to Order

Nil	—
X90	Main valve fluororubber (Refer to page 272.)

Manual override

Nil	Non-locking push type
D	Push-turn locking slotted type

Light/Surge voltage suppressor

U	With light/surge voltage suppressor
R	With surge voltage suppressor

M12 waterproof connector

Symbol	Cable length (mm)
W1	300
W2	500
W3	1000
W4	2000
W7	5000

* 10-SV3000 and 4000 are not available with 4 position dual 3 port valves.

10-SV Series Solenoid Valve Specifications



Fluid		Air
Internal pilot operating pressure range (MPa)	2 position single	0.15 to 0.7
	4 position dual 3 port valve	
	2 position double	
External pilot operating pressure range (MPa)	3 position	-100 kPa to 0.7
	Operating pressure range	
	2 position single, double	
	3 position	0.25 to 0.7
	Ambient and fluid temperature (°C)	
Max. operating frequency (Hz)	2 position single, double	5
	4 position dual 3 port valve	
	3 position	3
Manual override		Non-locking push type
		Push-turn locking slotted type
Pilot exhaust method	Internal pilot	Main/Pilot valve common exhaust
	External pilot	Pilot valve individual exhaust
Lubrication		Not required
Mounting orientation		Unrestricted
Impact/Vibration resistance (m/s²)		150/30 (8.3 to 2000 Hz)
Enclosure		IP67 (Based on IEC60529)
Electrical entry		M12 waterproof connector
Coil rated voltage		24 VDC, 12 VDC
Allowable voltage fluctuation		±10% of rated voltage
Power consumption (W)		0.6 (With light: 0.65)
Surge voltage suppressor		Zener diode
Indicator light		LED

Note) Impact resistance: No malfunction occurred when it was tested with a drop tester in the axial direction and at right angles to the main valve and armature in both energized and deenergized states once for each condition. (Default settings)

Vibration resistance: No malfunction occurred in a one-sweep test between 45 and 2000 Hz. Test was performed in both energized and de-energized states in the axial direction and at right angles to the main valve and armature. (Default settings)

Response Time

Actuation type	Response time (ms) (at the pressure of 0.5 MPa)			
	10-SV1000	10-SV2000	10-SV3000	10-SV4000
2 position single	11 or less	25 or less	28 or less	40 or less
2 position double	10 or less	17 or less	26 or less	40 or less
3 position	18 or less	29 or less	32 or less	82 or less
4 position dual 3 port valve	15 or less	33 or less	—	—

Note) Based on dynamic performance test, JIS B 8375-1981. (Coil temperature: 20°C, at rated voltage)

M12 Waterproof Connector Wiring Specifications

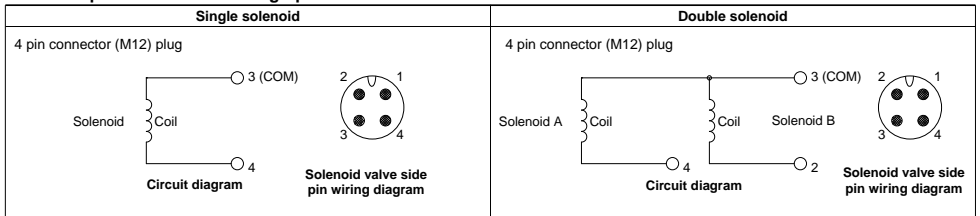

Note) Solenoid valves have no polarity.

Connection (Female Side) Connector Cable

As the parts are not supplied from SMC, refer to the application examples listed in the below. (For detail such as catalog availability, etc., please contact each manufacturer.)

Connector size	Number of pins	Manufacturer	Applicable series example
M12	4	Correns Corporation	VA-4D
		OMRON Corporation	XS2
		Azbil Corporation	PA5-41
		HIROSE ELECTRIC CO., LTD.	HR24
		DDK Ltd.	CM01-8DP4S

* This connector is a female connector for ① relay output module and ② single unit/sub-plate.

Single Unit/Sub-plate Type 10-SV

Flow Rate Characteristics/Weight

10-SV1000

Valve model	Actuation type		Port size	Flow rate characteristics <small>Note 1)</small>						Weight (g) <small>Note 2)</small>
				1 → 4/2 (P → A/B)			4/2 → 5/3 (A/B → EA/EB)			M12 waterproof connector (Cable length 300 mm)
				C[dm ³ /(s·bar)]	b	Cv	C[dm ³ /(s·bar)]	b	Cv	
10-SV1□00-□-01□	2 position	Single	1/8	1.0	0.30	0.24	1.1	0.30	0.26	123 (88)
		Double								128 (93)
	3 position	Closed center		0.77	0.28	0.18	0.85	0.30	0.19	130 (95)
		Exhaust center		0.73	0.31	0.18	1.1 [0.55]	0.26 [0.52]	0.24 [0.16]	
		Pressure center		1.2 [0.51]	0.24 [0.45]	0.29 [0.14]	0.89	0.47	0.24	
	4 position dual	N.C./N.C.		0.68	0.35	0.18	1.1	0.39	0.29	128 (93)
		Pressure center		0.87	0.31	0.23	0.77	0.44	0.21	
		N.O./N.O.								

Note 1) []: Denotes normal position. Note 2) (): Denotes without sub-plate.

10-SV2000

Valve model	Actuation type		Port size	Flow rate characteristics <small>Note 1)</small>						Weight (g) <small>Note 2)</small>
				1 → 4/2 (P → A/B)			4/2 → 5/3 (A/B → EA/EB)			M12 waterproof connector (Cable length 300 mm)
				C[dm ³ /(s·bar)]	b	Cv	C[dm ³ /(s·bar)]	b	Cv	
10-SV2□00-□-02□	2 position	Single	1/4	2.4	0.41	0.64	2.8	0.29	0.66	159 (96)
		Double								163 (100)
	3 position	Closed center		1.8	0.47	0.50	1.8	0.40	0.47	168 (105)
		Exhaust center		1.4	0.55	0.44	3.0 [1.2]	0.33 [0.48]	0.72 [0.37]	
		Pressure center		3.3 [0.84]	0.36 [0.60]	0.85 [0.28]	1.8	0.40	0.48	
	4 position dual	N.C./N.C.		2.2	0.40	0.55	2.6	0.31	0.60	163 (100)
		Pressure center		2.7	0.24	0.57	2.3	0.36	0.54	
		N.O./N.O.								

Note 1) []: Denotes normal position. Note 2) (): Denotes without sub-plate.

10-SV3000

Valve model	Actuation type		Port size	Flow rate characteristics <small>Note 1)</small>						Weight (g) <small>Note 2)</small>
				1 → 4/2 (P → A/B)			4/2 → 5/3 (A/B → EA/EB)			M12 waterproof connector (Cable length 300 mm)
				C[dm ³ /(s·bar)]	b	Cv	C[dm ³ /(s·bar)]	b	Cv	
10-SV3□00-□-02□	2 position	Single	1/4	4.1	0.41	1.1	4.1	0.29	1.0	250 (121)
		Double								253 (124)
	3 position	Closed center		3.0	0.43	0.80	2.6	0.41	0.72	26 (132)
		Exhaust center		2.6	0.42	0.71	4.7 [1.7]	0.35 [0.48]	1.1 [0.49]	
		Pressure center		5.3 [2.3]	0.39 [0.49]	1.3 [0.65]	2.2	0.49	0.63	
10-SV3□00-□-03□	2 position	Single	3/8	4.9	0.29	1.2	4.5	0.27	1.1	235
		Double								238
	3 position	Closed center		3.0	0.40	0.80	2.6	0.45	0.73	246
		Exhaust center		2.6	0.42	0.71	4.8 [1.7]	0.35 [0.48]	1.1 [0.34]	
		Pressure center		5.3 [2.3]	0.31 [0.51]	1.3 [0.64]	2.3	0.45	0.66	

Note 1) []: Denotes normal position. Note 2) (): Denotes without sub-plate.

10-SV4000

Valve model	Actuation type		Port size	Flow rate characteristics <small>Note 1)</small>						Weight (g) <small>Note 2)</small>
				1 → 4/2 (P → A/B)			4/2 → 5/3 (A/B → EA/EB)			M12 waterproof connector (Cable length 300 mm)
				C[dm ³ /(s·bar)]	b	Cv	C[dm ³ /(s·bar)]	b	Cv	
10-SV4□00-□-03□	2 position	Single	3/8	7.9	0.34	2.0	9.6	0.43	2.5	505 (208)
		Double								509 (212)
	3 position	Closed center		7.5	0.33	1.8	7.3	0.30	1.7	530 (233)
		Exhaust center		7.2	0.34	1.7	13 [4.0]	0.23 [0.41]	2.8 [0.95]	
		Pressure center		12 [3.3]	0.26 [0.41]	2.8 [0.84]	6.7	0.40	1.9	
10-SV4□00-□-04□	2 position	Single	1/2	8.0	0.48	2.2	10	0.29	2.5	484
		Double								488
	3 position	Closed center		7.6	0.32	1.8	7.3	0.32	1.8	509
		Exhaust center		7.3	0.42	2.0	13 [4.7]	0.32 [0.54]	3.6 [1.5]	
		Pressure center		12 [3.3]	0.33 [0.51]	3.3 [0.94]	7.4	0.33	1.9	

Note 1) []: Denotes normal position. Note 2) (): Denotes without sub-plate.

Dimensions: Series 10-SV1000

2 position single/double, 4 position dual 3 port [M12 waterproof connector type]

10-SV1□00(R)-□W□□-01□

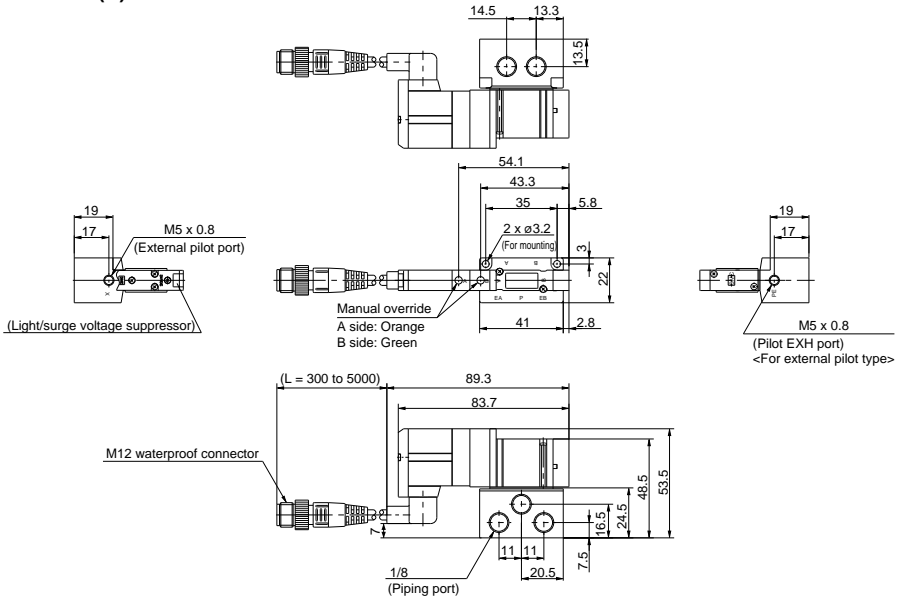

3 position closed center / exhaust center / pressure center [M12 waterproof connector type]

10-SV1□00(R)-□W□□-01□

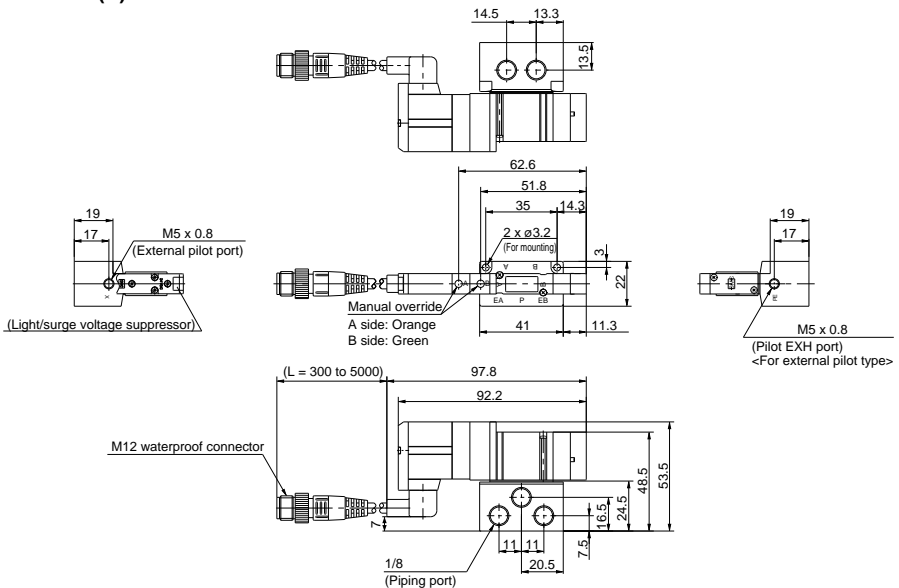

Dimensions: Series 10-SV2000

2 position single/double, 4 position dual 3 port [M12 waterproof connector type]

10-SV2□00(R)-□W□□-02□

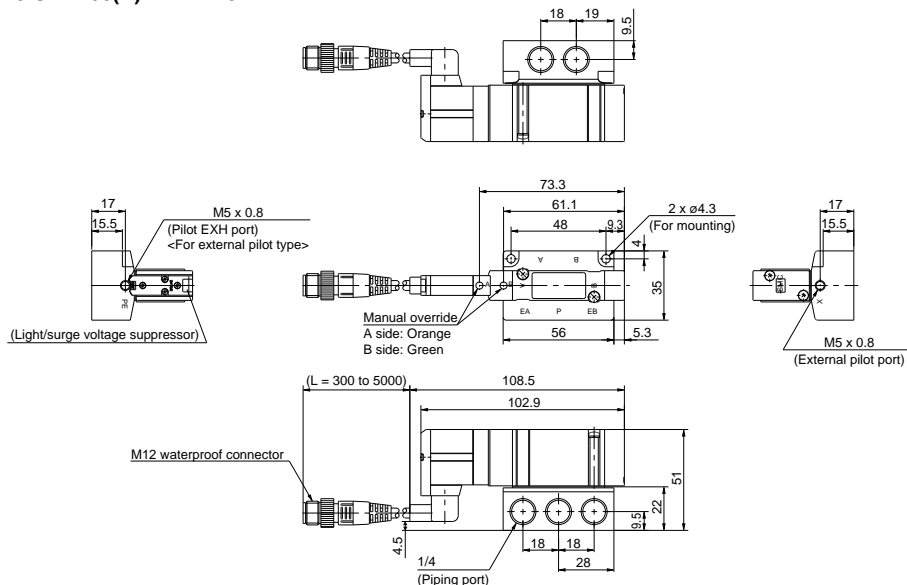

3 position closed center / exhaust center / pressure center [M12 waterproof connector type]

10-SV2□00(R)-□W□□-02□

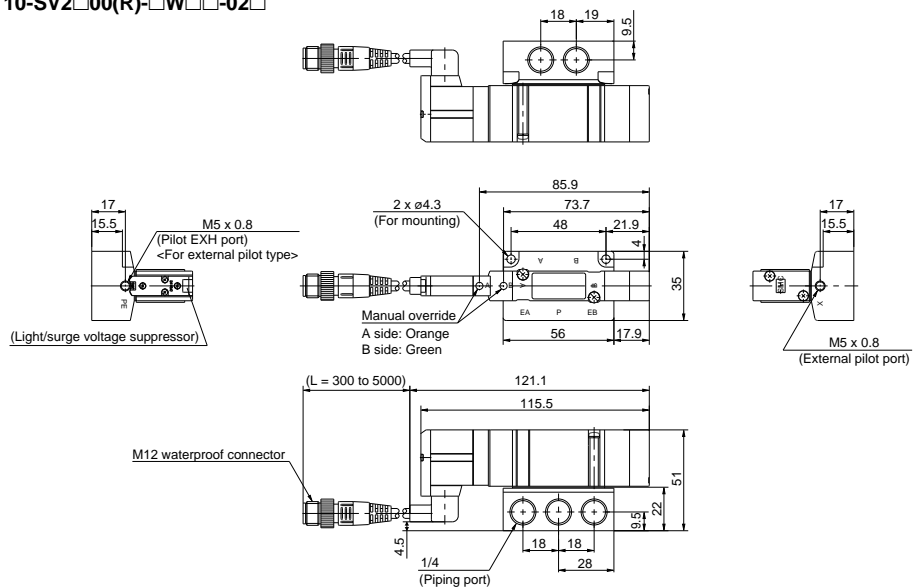

Dimensions: Series 10-SV4000

2 position single/double [M12 waterproof connector type]

10-SV4□00(R)-□W□□-03, 04□

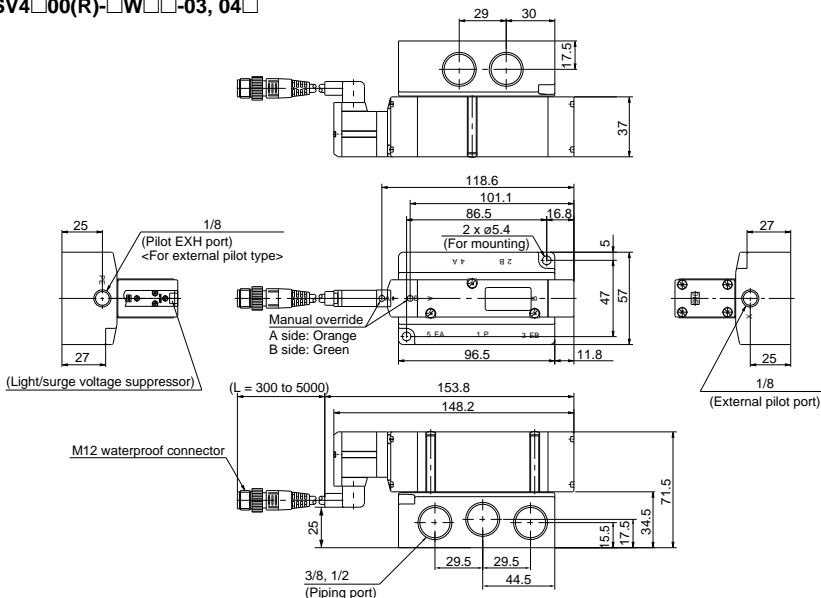

3 position closed center / exhaust center / pressure center [M12 waterproof connector type]

10-SV4□00(R)-□W□□-03, 04□

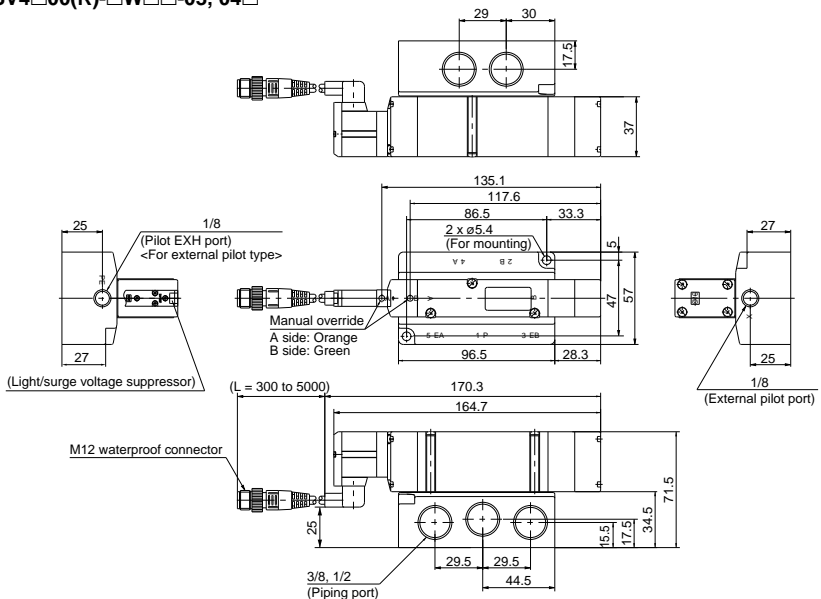

⚠ Specific Product Precautions 1

Be sure to read this before handling.

⚠ Warning

Operating Environment

1. Do not use valves in atmospheres of corrosive gases, chemicals, salt water, water, steam, or where there is direct contact with any of these.
2. Products compliant with IP65 and IP67 enclosures (Based on IEC529) are protected against dust and water, however, these products cannot be used in water.
3. Products compliant with IP65 and IP67 enclosures satisfy the specifications by mounting each product properly. Be sure to read the Specific Product Precautions for each product.

⚠ Warning

Manual Override Operation

Handle carefully, as connected equipment can be actuated through manual override operation.

■ Non-locking push type

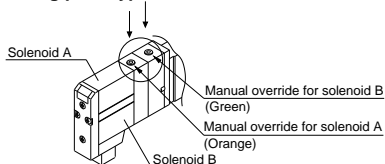

■ Push-turn locking slotted type

While pressing the lock down, turn it in the direction of the arrow. If it does not turn, it can be operated the same way as the non-locking type.

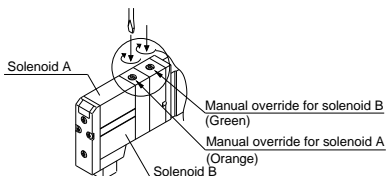

⚠ Caution

When locking the manual override with the push-turn locking slotted type, be sure to push the lock down before turning it. Turning without first pushing it down can cause damage to the manual override and other trouble such as air leakage, etc.

⚠ Caution

Exhaust Throttle

With the 10-SV series, pilot valve and main valve share a common exhaust inside the valve. Therefore, do not block the exhaust port when installing the piping.

⚠ Caution

Series 10-SV Used as a 3 Port Valve

When using a 5 port valve as a 3 port valve

The 10-SV series can be used as normally closed (N.C.) or normally open (N.O.) 3 port valves by closing one of the cylinder ports (A or B) with a plug. However, they should be used with the exhaust ports kept open. They are convenient at times when a double solenoid type 3 port valve is required.

Plug position		B port	A port
Actuation		N.C.	N.O.
Number of solenoids	Single		
	Double		

⚠ Caution

Light/Surge Voltage Suppressor

Solenoid valves have no polarity.

Light/Surge voltage suppressor

Single solenoid

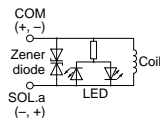

Double solenoid, 3 position type

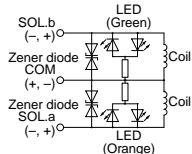

Surge voltage suppressor

Single solenoid

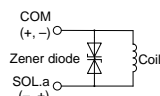

Double solenoid, 3 position type

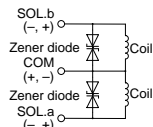

⚠ Caution

Light Indication

When equipped with light and surge voltage suppressor, the light window turns orange when solenoid A is energized, and it turns green when solenoid B is energized.

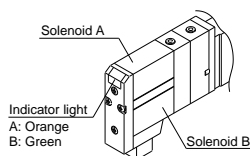

⚠ Specific Product Precautions 2

Be sure to read this before handling.

⚠ Caution

Valve Replacement, Adding/Removing Manifold Stations

Replacing solenoid valves and adding/removing manifold stations may cause external leakage. So, it is recommended to ask SMC for repair. When repair work is performed by the user, the user shall be responsible for the work since SMC cannot perform the inspection or check.

⚠ Caution

Connector Entry Directions

Connector entry directions for D-sub connectors and flat ribbon cables can be changed. To change the connector's entry direction, press the levers on both sides of the connector, take it off, and change the direction as shown in the drawing. Since lead wire assemblies are attached to the connector, excessive pulling or twisting can cause broken wires or other trouble. Also, take precautions so that lead wires are not caught and pinched when installing the connector.

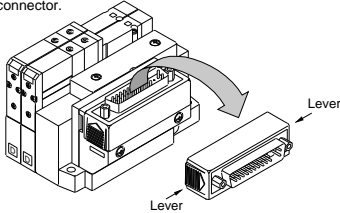

⚠ Caution

How to Order Manifold

The letter "S" or "D" is indicated on manifold blocks for the 10-SV series as shown below. This indication refers to the type of substrate assembly (single wiring or double wiring) inside the manifold blocks.

When the manifold specification sheet does not include wiring specifications, all stations will be double wiring specification (D). In this case, single and double solenoid valves can be mounted in any position, but when a single valve is used, there will be an unused control signal. To avoid this, indicate positions of manifold blocks for single wiring specification (S) and double wiring specification (D) on the manifold specification sheet. (Note that double, 3 or 4 position valves cannot be used for manifolds blocks with single wiring specification (S).)

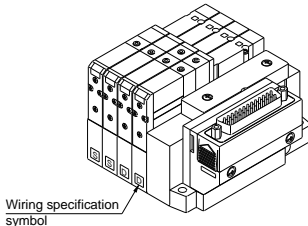

⚠ Caution

Substrate Assemblies inside Manifolds

Substrate assemblies inside of manifolds cannot be taken apart. Attempting to do so may damage parts.

⚠ Caution

One-touch Fittings

1. Tubing attachment/detachment for One-touch fittings

1) Attaching tubing

- Take a tubing with no flaws on its periphery and cut it off at a right angle. When cutting the tubing, use tube cutters TK-1, 2 or 3. Do not use pinchers, nippers or scissors, etc. If cutting is done with tools other than tube cutters, the tubing may be cut diagonally or become flattened, etc., making a secure installation impossible, and causing problems such as the tubing coming out after installation or air leakage. Allow some extra length in the tubing.
- Grasp the tubing, slowly push it straight (0 to 5°) into the One-touch fitting until it comes to a stop.
- After inserting the tubing, pull on it lightly to confirm that it will not come out. If it is not installed securely all the way into the fitting, this can cause problems such as air leakage or the tubing coming out.

2) Detaching tubing

- Push in the release button sufficiently, pushing its collar equally around the circumference.
- Pull out the tubing while holding down the release button so that it does not come out. If the release button is not pressed down sufficiently, there will be increased bite on the tubing and it will become more difficult to pull it out.
- When the removed tubing is to be used again, cut off the portion which had been secured before reusing it. If the same portion of the tubing is reused, this can cause trouble such as air leakage or difficulty in removing the tubing.

⚠ Caution

Other Tubing Brands

1. When using tubing other than SMC brand tubing, confirm that the following specifications are satisfied with respect to the outside diameter tolerance of the tubing.

- Nylon tubing within ± 0.1 mm
- Soft nylon tubing within ± 0.1 mm
- Polyurethane tubing within $+0.15$ mm
within -0.2 mm

Do not use tubing which do not meet these outside diameter tolerances. It may not be possible to connect them, or they may cause other trouble, such as air leakage or the tubing coming out after connection.

⚠ Caution

Built-in Back Pressure Check Valve Type

- Valves with built-in back pressure check valve are to protect the back pressure inside a valve. For this reason, use caution the valves with external pilot specifications cannot be pressurized from exhaust port [3/5(E)]. As compared with the types which do not integrate the back pressure check valve, C value of the flow rate characteristics goes down. For details, please contact SMC.
- Do not switch valves when A or B port is open to the atmosphere, or while the actuators and air operated equipment are in operation. The back pressure prevention seal may be peeled off, which may cause air leakage or malfunctions. Use caution especially when performing a trial operation or maintenance work.

⚠ Specific Product Precautions 3

Be sure to read this before handling.

EX500/EX250/EX260/EX120

⚠ Warning

1. These products are intended for use in general factory automation equipment.
Avoid using these products in machinery/equipment which affects human safety, and in cases where malfunction or failure can result in extensive damage.
2. Do not use in an explosive atmosphere, environment with inflammable gases, or corrosive atmosphere.
This can cause injury or fire, etc.
3. Work such as transporting, installing, piping, wiring, operation, control and maintenance should be performed by personnel with specialized knowledge.
There is a danger of electrocution, injury or fire, etc.
4. Install an external emergency stop circuit that can promptly stop operation and shut off the power supply.
5. Do not remodel these products, as there is a danger of injury and damage.
6. Do not wipe the product with chemicals, etc.

⚠ Caution

1. Read the operation manual carefully, strictly observe the precautions and operate within the range of the specifications.
2. Do not drop these products or submit them to strong impacts. This can cause damage, failure or malfunction, etc.
3. In locations with poor electrical conditions, take steps to ensure a steady flow of the rated power supply. Use of a voltage outside of the specifications can cause malfunction, damage to the unit, electrocution or fire, etc.
4. Do not touch connector terminals or internal substrates when current is being supplied. There is a danger of malfunction, damage to the unit or electrocution if connector terminals or internal substrates are touched when current is being supplied.
Be sure that the power supply is OFF when adding or removing manifold valves or input blocks, etc., or when connecting or disconnecting connectors.
5. Operate at an ambient temperature that is within the specifications. Even when the ambient temperature range is within the specifications, do not use in locations where there are rapid temperature changes.
6. Keep wire scraps and other extraneous material from getting inside these products. This can cause fire, failure or malfunction, etc.
7. Give consideration to the operating environment depending on the type of enclosure being used.
To achieve IP65 or IP67 protection, provide appropriate wiring between all units using electrical wiring cables, communication connectors and cables with M12 connectors. Also, provide waterproof caps when there are unused ports, and perform proper mounting of input units, input blocks, SI units and manifold valves, etc. Provide a cover or other protection for applications in which there is constant exposure to water.
8. Obey the proper tightening torque.
There is a possibility of damaging threads if tightening exceeds the tightening torque range.
9. Provide adequate protection when operating in locations such as the following:
 - Where noise is generated by static electricity, etc.
 - Where there is a strong electric field
 - Where there is a danger of exposure to radiation
 - When in close proximity to power supply lines

⚠ Caution

10. When these products are installed in equipment, provide adequate protection against noise by using noise filters, etc.
11. Since these products are components that are used after installation in other equipment, the customer should confirm conformity to EMC directives for the finished product.
12. Do not remove the name plate.
13. Perform periodic inspections and confirm normal operation. It may otherwise be impossible to guarantee safety due to unexpected malfunction or erroneous operation.
14. Do not use in places where there are cyclic temperature changes.
In case that the cyclic temperature is beyond normal temperature changes, the inside the product is likely to be adversely affected.
15. Do not use in direct sunlight.
Do not use in direct sunlight. It may cause malfunction or damage.
16. Do not use in places where there is radiated heat around it.
Such a place is likely to cause malfunction.

Safety Instructions for Power Supply

⚠ Caution

1. Operation is possible with a single power supply or a separate power supply. However, be sure to provide two wiring systems (one for solenoid valves, and one for input and control units).
2. Use the following UL approved products for DC power supply combinations.
 - 1) Controlled voltage current circuit conforming to UL508
Circuit uses the secondary coil of an isolated transformer as the power supply, satisfying the following conditions.
 - Max. voltage (with no load): 30 Vrms (42.4 V peak) or less
 - Max. current: (1) 8 A or less (including shorts), and
(2) When controlled by a circuit protector (fuse, etc.) with the following rating

No-load voltage (V peak)	Max. current rating
0 to 20 [V]	5.0
Over 20 [V] to 30 [V]	100
	Peak voltage value

- 2) A circuit (class 2 circuit) with maximum 30 Vrms (42.4 V peak) or less, and a power supply consisting of a class 2 power supply unit conforming to UL1310, or a class 2 transformer conforming to UL1585

Safety Instructions for Cable

⚠ Caution

1. Be careful of miswiring. This can cause malfunction, damage and fire in the unit.
2. To prevent noise and surge in signal lines, keep all wiring separate from power lines and high voltage lines. Otherwise, this can cause malfunction.
3. Check wiring insulation, as defective insulation can cause damage to the unit due to excessive voltage or current.
4. Do not bend or pull cables repeatedly, and do not place heavy objects on them or allow them to be pinched. This can cause broken lines.

⚠ Specific Product Precautions 4

Be sure to read this before handling.

EX600

Design/Selection

⚠ Warning

- Use this product within the specification range.**
Using beyond the specified range can cause fire, malfunction, or damage to the system.
Confirm the specifications when operating.
- When using for an interlock circuit:**
 - Provide a multiple interlock system which is operated by another system (such as mechanical protection function).
 - Perform an inspection to check that it is working properly.

This may cause possible injury due to malfunction.

⚠ Caution

- When applicable to UL, use a Class 2 power supply unit conforming to UL1310 for direct current power supply.**
- Use this product within the specified voltage range.**
Using beyond the specified voltage range is likely to cause the units and connecting devices to be damaged or to malfunction.
- The power supply for the unit should be 0 V as the standard for both power supply for output as well as power supply for control/input.**

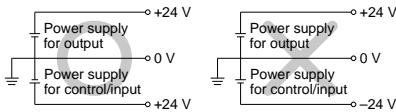

- Do not install a unit in a place where it can be used as a foothold.**
Applying any excessive load such as stepping on the unit by mistake or placing a foot on it, will cause it to break.
- Keep the surrounding space free for maintenance.**
When designing a system, take into consideration the amount of free space needed for performing maintenance.
- Do not remove the name plate.**
Improper maintenance or incorrect use of operation manual can cause failure and malfunction. Also, there is a risk of losing conformity with safety standards.
- Beware of inrush current when the power supply is turned on.**
Some connected loads can apply an initial charge current which will trigger the over current protection function, causing the unit to malfunction.

Mounting

⚠ Caution

- When handling and assembling units:**
 - Do not touch the sharp metal parts of the connector or plug.
 - Do not apply excessive force to the unit when disassembling.
The connecting portions of the unit are firmly joined with seals.
 - When joining units, take care not to get fingers caught between units.
Injury can result.
- Do not drop, bump, or apply excessive impact.**
Otherwise, the unit can become damaged, malfunction, or fail to function.
- Observe the tightening torque range.**
Tightening outside of the allowable torque range will likely damage the screw.
IP67 when guaranteed if the screws are not tightened to the specified torque.
- When lifting a large size manifold solenoid valve unit, take care to avoid causing stress to the valve connection joint.**
The connection parts of the unit may be damaged.
Because the unit may be heavy, carrying and installation should be performed by more than one operator to avoid strain or injury.
- When placing a manifold, mount it on a flat surface.**
Torsion in the whole manifold can lead to trouble such as air leakage or defective insulation.

Wiring

⚠ Caution

- Confirm grounding to maintain the safety of the reduced wiring system and for anti-noise performance.**
Provide a specific grounding as close to the unit as possible to minimize the distance to grounding.
- Avoid repeatedly bending or stretching the cable and applying a heavy object or force to it.**
Wiring applying repeated bending and tensile stress to the cable can break the circuit.
- Avoid miswiring.**
If miswired, there is a danger of malfunction or damage to the reduced wiring system.
- Do not wire while energizing the product.**
There is a danger of malfunction or damage to the reduced wiring system or input/output equipment.
- Avoid wiring the power line and high pressure line in parallel.**
Noise or surge produced by signal line resulting from the power line or high pressure line could cause malfunction.
Wiring of the reduced wiring system or input/output device and the power line or high pressure line should be separated from each other.

Directional Control Valves

Air Cylinders

Rotary Actuators

Air Grippers

Air Preparation Equipment

Modular F. R.

Pressure Control Equipment

Fittings & Tubing

Flow Control Equipment

Pressure Switches/ Pressure Sensors

⚠ Specific Product Precautions 5

Be sure to read this before handling.

EX600

Wiring

⚠ Caution

6. Confirm the wiring insulation.

Defective insulation (contact with other circuits, improper insulation between terminals, etc.) may cause damage to the reduced wiring system or input/output device due to excessive voltage or current.

7. When a reduced wiring system is installed in machinery/equipment, provide adequate protection against noise by using noise filters, etc.

Noise in signal lines may cause malfunction.

8. When connecting wires of input/output device or Handheld Terminal, prevent water, solvent or oil from entering inside from the connector section.

This can cause damage, equipment failure or malfunction.

9. Avoid wiring patterns in which excessive stress is applied to the connector.

This may cause malfunction or damage to the unit due to contact failure.

Operating Environment

⚠ Warning

1. Do not use in an atmosphere containing an inflammable gas or explosive gas.

Use in such an atmosphere is likely to cause a fire or explosion. This system is not explosion-proof.

⚠ Caution

1. Select the proper type of enclosure according to the environment of operation.

IP65/67 is achieved when the following conditions are met.

1) Provide appropriate wiring between all units using electrical wiring cables, communication connectors and cables with M12 connectors.

2) Suitable mounting of each unit and manifold valve.

3) Be sure to mount a seal cap on any unused connectors.

If using in an environment that is exposed to water splashes, please take measures such as using a cover.

When the enclosure is IP40, do not use in an operating environment or atmosphere where it may come in contact with corrosive gas, chemical agents, seawater, water, or water vapor. When connected to EX600-D□□E or EX600-D□□F, manifold enclosure is IP40.

Also, the Handheld Terminal conforms to IP20, so prevent foreign matter from entering inside, and water, solvent or oil from coming in direct contact with it.

2. Provide adequate protection when operating in locations such as the following.

Failure to do so may cause damage or malfunction.

The effect of countermeasures should be checked in individual equipment and machine.

1) Where noise is generated by static electricity, etc.

2) Where there is a strong electric field

3) Where there is a danger of exposure to radiation

4) When in close proximity to power supply lines

Operating Environment

⚠ Caution

3. Do not use in an environment where oil and chemicals are used.

Operating in environments with coolants, cleaning solvents, various oils or chemicals may cause adverse effects (damage, malfunction) to the unit even in a short period of time.

4. Do not use in an environment where the product could be exposed to corrosive gas or liquid.

This may damage the unit and cause it to malfunction.

5. Do not use in locations with sources of surge generation.

Installation of the unit in an area around the equipment (electromagnetic lifters, high frequency induction furnaces, welding machine, motors, etc.), which generates the large surge voltage could cause to deteriorate an internal circuitry element of the unit or result in damage. Implement countermeasures against the surge from the generating source, and avoid touching the lines with each other.

6. Use the product type that has an integrated surge absorption element when directly driving a load which generates surge voltage by relay, solenoid valves or lamp.

When a surge generating load is directly driven, the unit may be damaged.

7. The product is CE marked, but not immune to lightning strikes. Take measures against lightning strikes in your system.

8. Keep dust, wire scraps and other extraneous material from getting inside the product.

This may cause malfunction or damage.

9. Mount the unit in such locations, where no vibration or shock is affected.

This may cause malfunction or damage.

10. Do not use in places where there are cyclic temperature changes.

In case that the cyclic temperature is beyond normal temperature changes, the internal unit is likely to be adversely effected.

11. Do not use in direct sunlight.

Do not use in direct sunlight. It may cause malfunction or damage.

12. Use this product within the specified ambient temperature range.

This may cause malfunction.

13. Do not use in places where there is radiated heat around it.

Such a place is likely to cause malfunction.

Adjustment/Operation

⚠ Warning

1. Do not perform operation or setting with wet hands.

There is a risk of electrical shock.

⚠ Specific Product Precautions 6

Be sure to read this before handling.

EX600

Adjustment/Operation

⚠ Warning

<Handheld Terminal>

- Do not apply pressure to the LCD.
There is a possibility of the crack of LCD and injuring.
- The forced input/output function is used to change the signal status forcibly. When operating this function, be sure to check the safety of the surroundings and installation.
Otherwise, injury or equipment damage could result.
- Incorrect setting of parameters can cause malfunction. Be sure to check the settings before use.
This may cause injury or equipment damage.

⚠ Caution

- Use a watchmaker's screwdriver with thin blade for the setting of each switch of the SI Unit.
When setting the switch, do not touch other unrelated parts.
This may cause parts damage or malfunction due to a short circuit.
- Provide adequate setting for the operating conditions.
Failure to do so could result in malfunction.
Refer to the operation manual for setting of the switches.
- For the details of programming and address setting, refer to the manual from the PLC manufacturer.
The content of programming related to protocol is designed by the manufacturer of the PLC used.

<Handheld Terminal>

- Do not press the setting buttons with a sharp pointed object.
This may cause damage or malfunction.
- Do not apply excessive load and impact to the setting buttons.
This may cause damage, equipment failure or malfunction.

When the order does not include the SI Unit, the valve plate to connect the manifold and SI Unit is not mounted. Use attached valve holding screws and mount the valve plate.
(Tightening torque: 0.6 to 0.7 N·m)

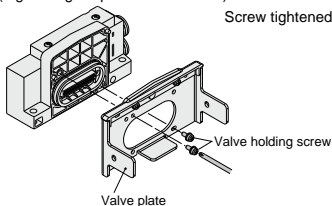

Maintenance

⚠ Warning

- Do not disassemble, modify (including circuit board replacement) or repair this product.
Such actions are likely to cause injuries or breakage.
- When an inspection is performed,
 - Turn off the power supply.
 - Stop the air supply, exhaust the residual pressure in piping and verify that the air is released before performing maintenance work.
Unexpected malfunction of system components and injury can result.

⚠ Caution

- When handling and replacing the unit:
 - Do not touch the sharp metal parts of the connector or plug.
 - Do not apply excessive force to the unit when disassembling.
The connecting portions of the unit are firmly joined with seals.
 - When joining units, take care not to get fingers caught between units.
Injury can result.
- Perform periodic inspection.
Unexpected malfunction in the system composition devices is likely to occur due to malfunction of machinery or equipment.
- After maintenance, make sure to perform an appropriate functionality inspection.
In cases of abnormality such as faulty operation, stop operation. Unexpected malfunction in the system composition devices is likely to occur.
- Do not use benzene and thinner for cleaning units.
Damage to the surface or erasure of the display can result. Wipe off any stains with a soft cloth.
If the stain is persistent, wipe off with a cloth soaked in a dilute solution of neutral detergent and wrung out tightly, and then finish with a dry cloth.

Other

⚠ Caution

- Refer to the catalog of each series for Common Precautions and Specific Product Precautions on manifold solenoid valves.

■ Trademark

DeviceNet™ is a trademark of ODVA. EtherNet/IP™ is a trademark of ODVA. CompoNet™ is a trademark of ODVA.
EtherCAT® is registered trademark and patented technology, licensed by Beckhoff Automation GmbH, Germany.

Series 10-SYJ3000/5000/7000

Rubber Seal
4/5 Port Solenoid Valve







Manifold variations	A, B port size								Manifold option			
	M3	M5	1/8	One-touch fittings						Blanking plate	Individual SUP spacer	Individual EXH spacer
				ø4	ø6	ø8	ø5/32"	ø1/4"	ø5/16"			

Individual wiring

Common SUP/Common EXH	5 port body ported	Type 20	10-SYJ3000 P. 299	●	—	—	—	—	—	—	—	—	—	●	—	—	
				10-SYJ5000 P. 327	—	●	—	●	●	—	●	●	—	●	—	●	
Common SUP/Common EXH	5 port body ported	Type 21	10-SYJ7000 P. 357	—	—	●	—	●	●	—	●	●	●	—	—	●	
Common SUP/Common EXH	4 port base mounted	Type 31	10-SYJ3000 P. 299	●	—	—	—	—	—	—	—	—	●	—	—	—	
Common SUP/Common EXH	4 port base mounted	Type 32	10-SYJ3000 P. 299	—	●	—	●	—	—	●	—	—	●	—	—	—	
Common SUP/Common EXH	5 port base mounted	Type 40	10-SYJ5000 P. 327	—	●	—	—	—	—	—	—	—	●	—	●	—	
				10-SYJ7000 P. 357	—	—	●	—	—	—	—	—	—	—	●	●	●
Common SUP/Common EXH	5 port base mounted	Type 41	10-SYJ3000 P. 299	—	●	—	●	—	—	●	—	—	●	—	—	—	
				10-SYJ5000 P. 327	—	●	—	—	—	—	—	—	—	●	●	●	—
					10-SYJ7000 P. 357	—	—	●	—	—	—	—	—	—	—	●	●
Common SUP/Common EXH	5 port base mounted	Type 42	10-SYJ5000 P. 327	—		—	●	—	●	—	—	●	—	●	●	●	
				10-SYJ7000 P. 357	—	—	—	—	●	●	—	●	●	●	●	●	—
Common SUP/Common EXH	5 port base mounted	Type 43	10-SYJ5000 P. 327	—	—	—	●	—	—	●	—	—	●	●	●	—	
Common SUP/Individual EXH	5 port base mounted	Type 46	10-SYJ3000 P. 299	—	●	—	●	—	—	●	—	—	●	—	—	—	

Manifold variations	A, B port size						Manifold option		
	M3	M5	1/8	One-touch fittings			Blanking plate	Individual SUP spacer	Individual EXH spacer
				ø4	ø6	ø8			

Flat Ribbon Cable

5 port body ported 	Type 20P 10-SYJ5000 P. 328	—	●	—	●	●	—	●	●	—	●	—	—
5 port body ported 	Type 21P 10-SYJ3000 P. 300	●	—	—	—	—	—	—	—	—	●	—	—
5 port body ported 	10-SYJ7000 P. 358	—	—	●	—	●	●	—	●	●	●	—	—
4 port base mounted 	Type 32P 10-SYJ3000 P. 300	—	●	—	●	—	—	●	—	—	●	—	—
5 port base mounted 	Type 41P 10-SYJ5000 P. 328	—	●	—	—	—	—	—	—	—	●	—	—
5 port base mounted 	Type 43P 10-SYJ5000 P. 328	—	—	—	●	—	—	●	—	—	●	—	—

Directional Control Valves

Air Cylinders

Rotary Actuators

Air Grippers

Air Preparation Equipment

Modular F. R.

Pressure Control Equipment







Fittings & Tubing

Flow Control Equipment

Pressure Switches/ Pressure Sensors

Manifold variations	A, B port size						Manifold option		
	M3	M5	1/8	One-touch fittings			Blanking plate	Individual SUP spacer	Individual EXH spacer
				ø4	ø6	ø8			

EX510 Gateway-type Serial Transmission System

5 port body ported  Type 20SA	10-SYJ5000 P. 325	—	●	—	●	●	—	●	●	—	●	—	—
5 port body ported  Type 21SA	10-SYJ3000 P. 297	●	—	—	—	—	—	—	—	—	●	—	—
	10-SYJ7000 P. 355	—	—	●	—	●	●	—	●	●	●	—	—
4 port base mounted  Type 32SA	10-SYJ3000 P. 298	—	●	—	●	—	—	●	—	—	●	—	—
5 port base mounted  Type 41SA	10-SYJ5000 P. 326	—	●	—	—	—	—	—	—	—	●	—	—
	10-SYJ7000 P. 356	—	—	●	—	—	—	—	—	●	●	—	—
5 port base mounted  Type 42SA	10-SYJ5000 P. 326	—	—	●	—	—	—	—	—	—	●	—	—
5 port base mounted  Type 43SA	10-SYJ5000 P. 326	—	—	—	●	—	—	●	—	—	●	—	—

Manifold option

Individual SUP spacer assembly

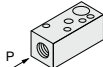

Individual EXH spacer assembly

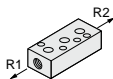





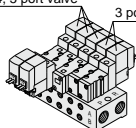





3 port valve and 4/5 port valve mixed mounting

4, 5 port valve 3 port valve

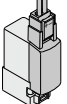

* Refer to page 301 for further information on the 10-SYJ3000 series, page 330 on the 10-SYJ5000 series and page 360 on the 10-SYJ7000 series.

Variations

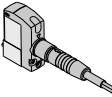
	Series	Sonic conductance: C [dm ² /(s·bar)]	Actuation type	Voltage	Electrical entry	Option	Manual override		
						With light/surge voltage suppressor			
Body ported	10-SYJ3000  P. 283	Effective area 0.9 mm ² { 4/2 → 5/3 } { (A/B → EA/EB) }		For DC ■ 24 VDC 12 VDC 6 VDC 5 VDC 3 VDC	Grommet 	For DC ■ With surge voltage suppressor			
	10-SYJ5000  P. 311	0.47 { 4/2 → 5/3 } { (A/B → EA/EB) }						L plug connector 	■ With light/surge voltage suppressor
	10-SYJ7000  P. 342	2.4 { 4/2 → 5/3 } { (A/B → EA/EB) }						2 position ● Single ● Double M plug connector 	
Base mounted	10-SYJ3000  P. 283	0.46 { 4/2 → 5/3 } { (A/B → EA/EB) }	3 position ● Closed center ● Exhaust center ● Pressure center	For AC ■ 100 VAC ^{50/60} Hz 110 VAC ^{50/60} Hz 200 VAC ^{50/60} Hz 220 VAC ^{50/60} Hz		For AC (Note) ■ With light/surge voltage suppressor	■ Non-locking push type		
	10-SYJ5000  P. 311	0.83 { 4/2 → 5/3 } { (A/B → EA/EB) }						DIN terminal  (10-SYJ5000, 7000 only)	■ Push-turn locking slotted type
	10-SYJ7000  P. 342	2.9 { 4/2 → 5/3 } { (A/B → EA/EB) }						M8 connector 	■ Push-turn locking lever type

Note) All AC voltage models have built-in surge voltage suppressor.

Directional
Control Valves

Air Cylinders

Rotary Actuators

Air Grippers

Air Preparation
Equipment

Modular F. R.

Pressure Control
Equipment

Fittings & Tubing

Flow Control
Equipment

Pressure Switches/
Pressure Sensors

Series 10-SYJ3000 Rubber Seal 4/5 Port Solenoid Valve

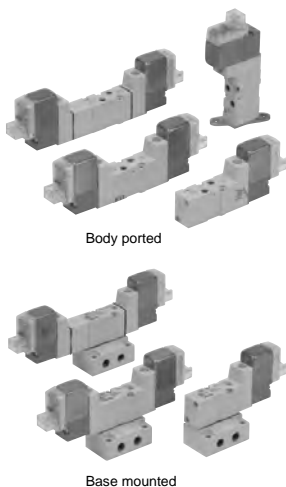

Specifications

Fluid		Air
Operating pressure range (MPa)	2 position single	0.15 to 0.7
	2 position double	0.1 to 0.7
	3 position	0.2 to 0.7
Ambient and fluid temperature (°C)		-10 to 50 (No freezing)
Response time (ms) ^{Note 1)} (at 0.5 MPa)	2 position single, double	15 or less
	3 position	30 or less
	2 position single, double	10
Max. operating frequency (Hz)	2 position single, double	10
	3 position	3
Manual override (Manual operation)		Non-locking push type, Push-turn locking slotted type, Push-turn locking lever type
Pilot exhaust method		Main/Pilot valve common exhaust
Lubrication		Not required
Mounting orientation		Unrestricted
Impact/Vibration resistance (m/s²) ^{Note 2)}		150/30
Enclosure		Dust proof (* M8 connector conforms to IP65.)

* Based on IEC60529

Note 1) Based on dynamic performance test, JIS B 8375-1981. (Coil temperature: 20°C, at rated voltage, without surge voltage suppressor)

Note 2) Impact resistance: No malfunction occurred when it was tested in the axial direction and at right angles to the main valve and armature in both energized and de-energized states once for each condition. (Default settings)

Vibration resistance: No malfunction occurred in a one-sweep test between 45 and 2000 Hz. Test was performed in both energized and de-energized states in the axial direction and at right angles to the main valve and armature. (Default settings)

Solenoid Specifications

Symbol 5 port

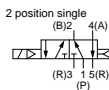

4 port (Manifold)

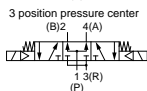
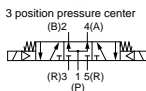
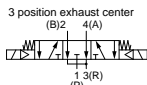
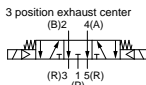
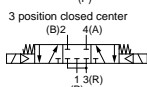
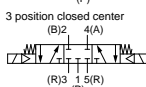
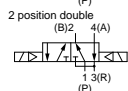
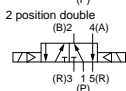
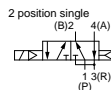

Electrical entry		Grommet (G), (H), L plug connector (L), M plug connector (M), M8 connector (W)	
Coil rated voltage (V)	DC	24, 12, 6, 5, 3	
	AC ^{50/60} Hz	100, 110, 200, 220	
Allowable voltage fluctuation		±10% of rated voltage *	
Power consumption (W)	DC	Standard 0.35 (With light: 0.4)	
	With power saving circuit	0.1 (With light only) * [Starting 0.4, Holding 0.1]	
Apparent power (VA) *	AC	100 V	0.78 (With light: 0.81)
		110 V	0.86 (With light: 0.89)
		[115 V]	[0.94 (With light: 0.97)]
		200 V	1.18 (With light: 1.22)
		220 V [230 V]	1.30 (With light: 1.34) [1.42 (With light: 1.46)]
Surge voltage suppressor		Diode (Non-polarity type: Varistor)	
Indicator light		LED	

* Common between 110 VAC and 115 VAC, and between 220 VAC and 230 VAC.

* For 115 VAC and 230 VAC, the allowable voltage is -15% to +5% of rated voltage.

* For details, refer to page 372.

Bracket Mounting

- Insert the lower hook of the mounting bracket into the groove on the bottom of the valve as shown.
- Press the valve and mounting bracket together until the upper hook of the bracket snaps into place in the groove on top of the valve.

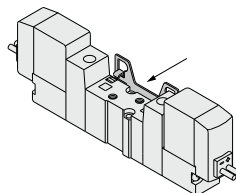
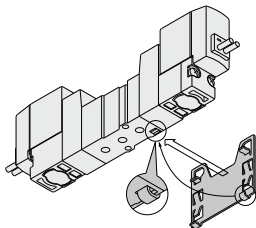

Made to Order
(For details, refer to page 369.)

Flow Rate Characteristics/Weight

Valve model	Actuation type	Port size		Weight (g) ^{Note 3, 4)}			Effective area (mm ²)	Flow rate characteristics ^{Note 2)}													
		1, 5, 3 (P, EA, EB)	4, 2 (A, B)	Grommet	L/M plug connector	M8 connector		1→4/2 (P→A/B)			4/2→5/3 (A/B→EA/EB)										
								C [dm ³ /s-bar]	b	Cv	C [dm ³ /s-bar]	b	Cv								
5 port Base mounted (with sub-plate)	2 position	Single	M5 x 0.8	M5 x 0.8	62 (36)	63 (37)	67 (41)	—	0.46	0.36	0.12	0.46	0.35	0.12							
		Double			79 (53)	81 (55)	89 (63)														
	3 position	Closed center			82 (56)	84 (58)	92 (66)								—	0.47	0.33	0.12	0.47	0.31	0.12
		Exhaust center													—	0.36	0.39	0.10	0.59 [0.40]	0.43 [0.33]	0.16 [0.11]
10-SYJ3543	Pressure center	—	0.58 [0.32]	0.42 [0.33]	0.16 [0.080]	0.46	0.32	0.11													
	Single	M3 x 0.5	M3 x 0.5	36	37	41	0.9	—	—	—	—	—	—	—							
Double	53			55	63																
3 position	Closed center			56	58	66									—	—	—	—	—	—	—
	Exhaust center														—	—	—	—	—	—	
10-SYJ3523	Pressure center	—	—	—	—	—	—	—													
	Single	1/8	M5 x 0.8	36	37	41	—	—	—	—	—	—	—								
Double	53			55	63																
3 position	Closed center			56	58	66								—	—	—	—	—	—		
	Exhaust center													—	—	—	—	—	—		
10-SYJ3533	Pressure center	—	—	—	—	—	—														
	Single	—	—	—	—	—	—														

Note 1) Dedicated for manifold base. For details, refer to page 293.
 Note 2) [] denotes normal position. Exhaust center: 4/2 → 5/3, Pressure center: 1 → 4/2
 Note 3) (): Without sub-plate.
 Note 4) For DC voltages. For AC voltages, add 3 g to the weight of the single solenoid and 6 g to the weight of the double solenoid and 3 position types.

Cylinder Speed Chart

Use as a guide for selection.
 Please confirm the actual conditions with SMC Model Selection Software.

Body Ported

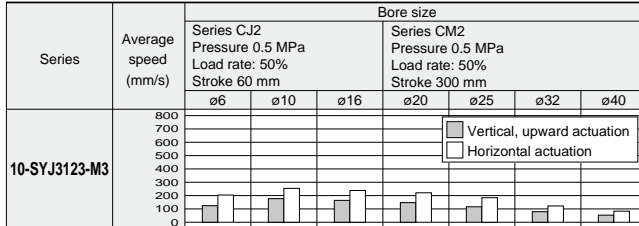

Base Mounted

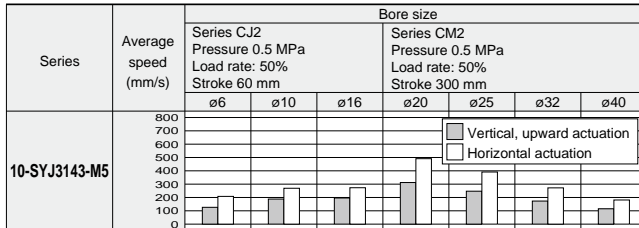

* Cylinder is in extending. Speed controller is meter-out, which is directly connected with cylinder and its needle is fully opened.
 * Average speed of cylinder is obtained by dividing the full stroke time by the stroke.
 * Load factor: ((Load mass x 9.8)/Theoretical force) x 100%

Conditions

Body ported			Base mounted	
Series CJ2	Series CM2	Series CJ2	Series CM2	
Tubing diameter x Length	ø4 x 1 m	ø6 x 1 m		
Speed controller	AS1002F-04	AS2002F-06 AS2002F-06		
Silencer	AN120-M5	AN120-M5		

Directional Control Valves
 Air Cylinders
 Rotary Actuators
 Air Grippers
 Air Preparation Equipment
 Modular F. R.
 Pressure Control Equipment
 Fittings & Tubing
 Flow Control Equipment
 Pressure Switches/ Pressure Sensors

Construction

2 position single

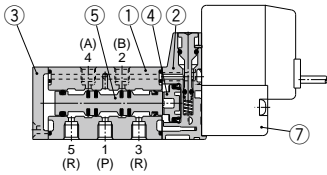
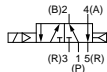

2 position double

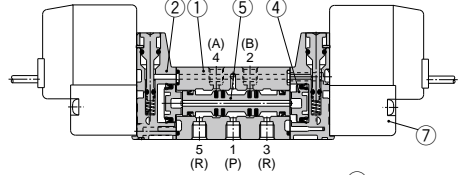
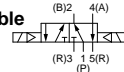

3 position closed center/exhaust center/pressure center

3 position closed center

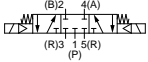

3 position exhaust center



3 position pressure center

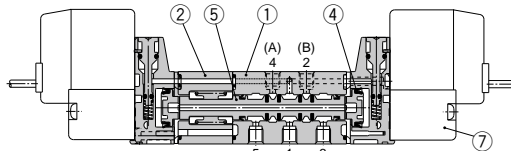
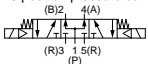

(This figure shows a closed center type.)

Component Parts

No.	Description	Material	Note
1	Body	Zinc die-casted	White
2	Piston plate	Resin	White
3	End cover	Resin	White
4	Piston	Resin	
5	Spool valve assembly	Aluminum, H-NBR	

Replacement Parts

No.	Description	Part no.	Note
6	Sub-plate ^(Note)	SYJ3000-22-1(-Q)	Zinc die-casted
7	Pilot valve	V111(T)-□□□	

(Note) Add suffix "-Q" for the CE-compliant product.

How to Order Pilot Valve Assembly

V111 □ — 5 G □

Coil type

NH	Standard
T	With power saving circuit (24, 12 VDC only)

* Power saving circuit is not available for W□ type.

Light/Surge voltage suppressor

NH	Without light/surge voltage suppressor
S	With surge voltage suppressor
Z	With light/surge voltage suppressor
R	With surge voltage suppressor (Non-polar type)
U	With light/surge voltage suppressor (Non-polar type)

* For AC voltage valves there is no "S" option. It is already built into the rectifier circuit.

* For type "R" and "U", only DC voltage is available.

* Power saving circuit is only available for the "Z" type.

Rated voltage

5	24 VDC
6	12 VDC
V	6 VDC
S	5 VDC
R	3 VDC
1	100 VAC 50/60 Hz
2	200 VAC 50/60 Hz
3	110 VAC 50/60 Hz [115 VAC 50/60 Hz]
4	220 VAC 50/60 Hz [230 VAC 50/60 Hz]

* For type W□, only DC voltage is available.

* CE-compliant: For DC only.

Electrical entry

G	Grommet, 300 mm lead wire
H	Grommet, 600 mm lead wire
L	L plug connector
LN	With lead wire
LO	Without lead wire
M	M plug connector
MN	With lead wire
MO	Without lead wire
WO	Without connector
M8	Without connector cable
W□	With connector cable ^(Note 1)

* For connector cable of M8 connector, refer to page 374.

Note 1) Enter the cable length symbols in □. Please be sure to fill in the blank referring to page 374.

(Note) Since V111 is CE-compliant as standard, the suffix "-Q" is not necessary.

Directional Control Valves
 Air Cylinders
 Rotary Actuators
 Air Grippers
 Air Preparation Equipment
 Modular F. R.
 Pressure Control Equipment
 Fittings & Tubing
 Flow Control Equipment
 Pressure Switches/Pressure Sensors

2 Position Single

* []: AC

Grommet (G), (H): 10-SYJ3123-□^G□□-M3

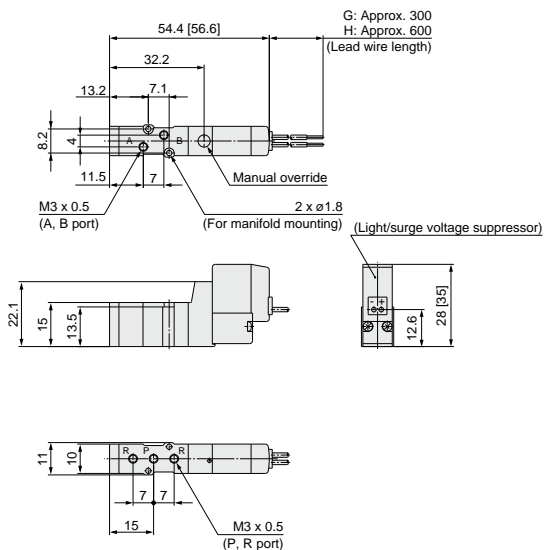

With bracket:

10-SYJ3123-□^G□□-M3-F

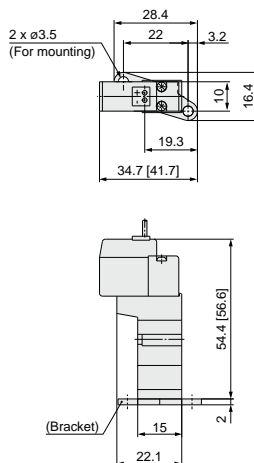

L plug connector (L):
10-SYJ3123-□L□□-M3 (-F)

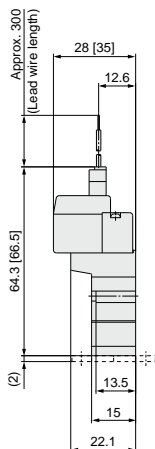

M plug connector (M):
10-SYJ3123-□M□□-M3 (-F)

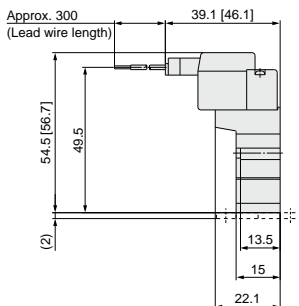

M8 connector (WO):
10-SYJ3123-□WO□□-M3 (-F)

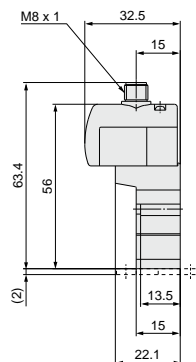

* Refer to page 375 for dimensions with connector cable.

2 Position Double

* []: AC

Grommet (G), (H): 10-SYJ3223-□_G□□□-M3 (-F)

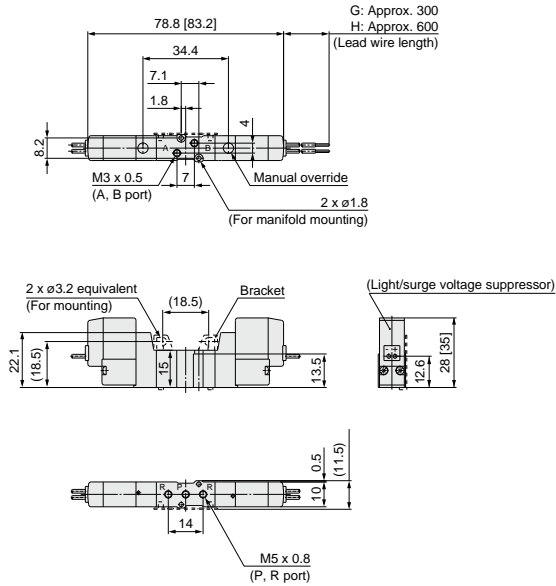

L plug connector (L):
10-SYJ3223-□L□□-M3 (-F)

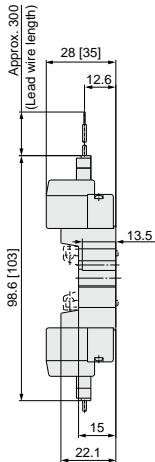

M plug connector (M):
10-SYJ3223-□M□□-M3 (-F)

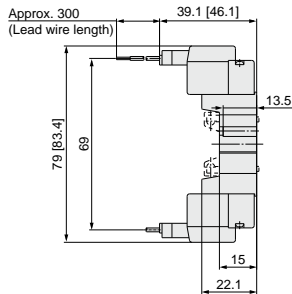

M8 connector (WO):
10-SYJ3223-□WO□□-M3 (-F)

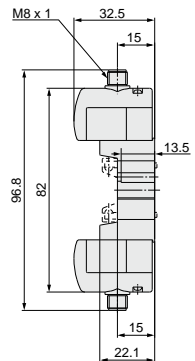

* Refer to page 375 for dimensions with connector cable.

Directional Control Valves
Air Cylinders
Rotary Actuators
Air Grippers
Air Preparation Equipment
Modular F. R.
Pressure Control Equipment
Fittings & Tubing
Flow Control Equipment
Pressure Switches/ Pressure Sensors

3 Position Closed Center/Exhaust Center/Pressure Center

* []: AC

Grommet (G), (H): 10-SYJ3^{3/4}23-□□□□-M3 (-F)

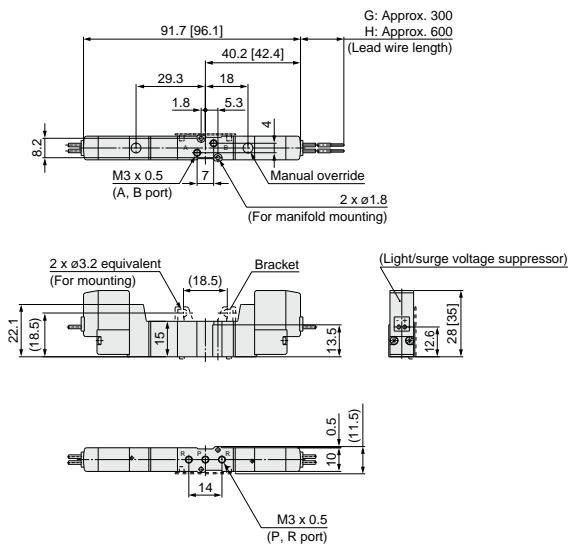

L plug connector (L):
10-SYJ3^{3/4}23-□□□□-M3 (-F)

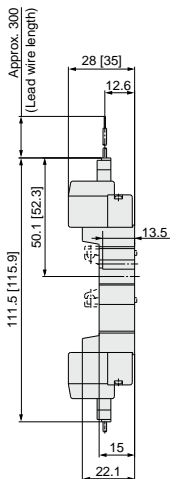

M plug connector (M):
10-SYJ3^{3/4}23-□□□□-M3 (-F)

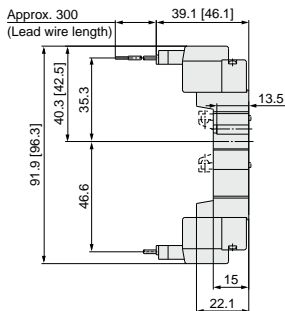

M8 connector (WO):
10-SYJ3^{3/4}23-□□□□-M3 (-F)

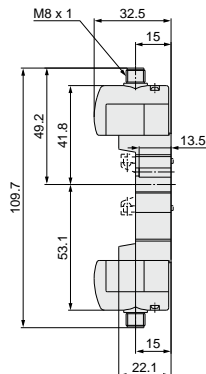

* Refer to page 375 for dimensions with connector cable.

2 Position Double

* []: AC

Grommet (G), (H): 10-SYJ3243-□_H□□-M5

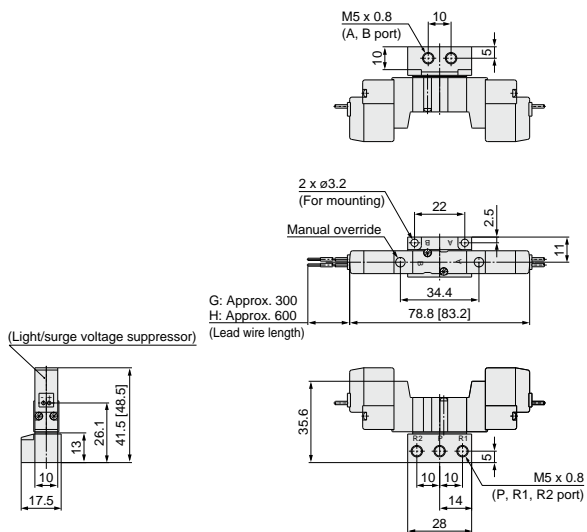

L plug connector (L):
10-SYJ3243-□L□□-M5

M plug connector (M):
10-SYJ3243-□M□□-M5

M8 connector (WO):
10-SYJ3243-□WO□□-M5

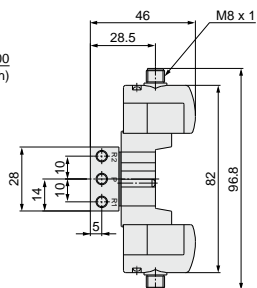
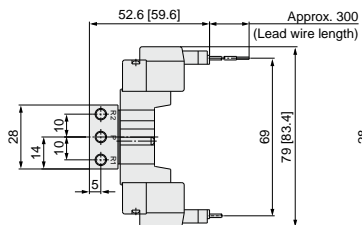
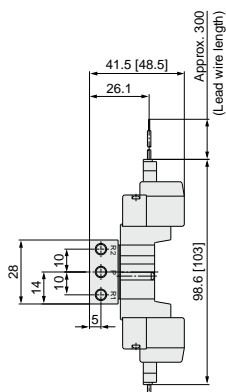

* Refer to page 375 for dimensions with connector cable.

3 Position Closed Center/Exhaust Center/Pressure Center

* []: AC

Grommet (G), (H): 10-SYJ3_{3/4}43-□_H□□-M5

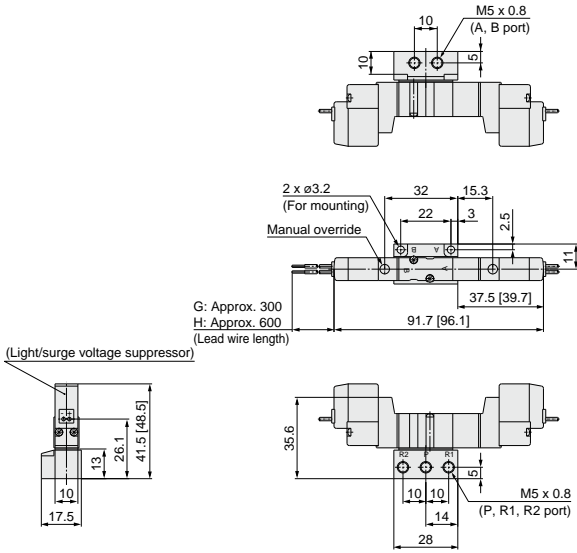

L plug connector (L):
10-SYJ3_{3/4}43-□L□□-M5

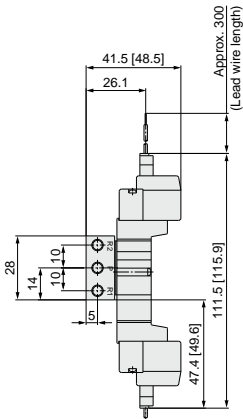

M plug connector (M):
10-SYJ3_{3/4}43-□M□□-M5

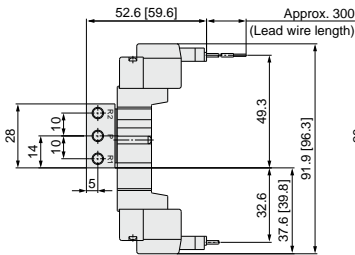

M8 connector (WO):
10-SYJ3_{3/4}43(R)-□WO□□-M5□

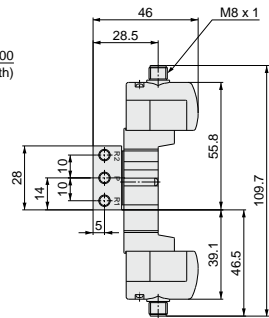

* Refer to page 375 for dimensions with connector cable.

Standard Manifold



Manifold Specifications

Model		Type 20	Type 31, S31	Type 32, S32	Type 41, S41	Type 46, S46
Manifold type		Single base/B mount				
P (SUP), R (EXH)		Common SUP/Common EXH				Common SUP Individual EXH
Valve stations		2 to 20 stations				
A, B port Porting specifications	Location	Valve	Base			
	Direction	Top	Side			
Port size	P, R port	M5 x 0.8		1/8		P: 1/8 R: M5 x 0.8
	A, B port	M3 x 0.5		M5 x 0.8, C4 (ø4 One-touch fitting)		

Flow Rate Characteristics

Manifold			Port size		Flow rate characteristics						Effective area (mm ²)
					1 → 4/2 (P → A/B)			4/2 → 5/3 (A/B → R)			
			1(P), 5/3(R) port	2(B), 4(A) port	C [dm ³ /(s·bar)]	b	Cv	C [dm ³ /(s·bar)]	b	Cv	
Body ported for internal pilot	Type 10-SS5YJ3-20	10-SYJ3□23	M5 x 0.8	M3 x 0.5	—	—	—	—	—	—	0.9
	Type 10-SS5YJ3-31 S31	10-SYJ3□33	M5 x 0.8	M3 x 0.5	—	—	—	—	—	—	0.9
Base mounted for internal pilot	Type 10-SS5YJ3-32-M5	10-SYJ3□33	1/8	M5 x 0.8	0.25	0.19	0.060	0.32	0.25	0.077	—
	Type 10-SS5YJ3-32-C4			C4	0.25	0.18	0.059	0.30	0.27	0.075	—
	Type 10-SS5YJ3-32-M5			M5 x 0.8	0.25	0.26	0.060	0.29	0.15	0.062	—
	Type 10-SS5YJ3-32-C4	C4	0.24	0.21	0.057	0.27	0.18	0.062	—		
	Type 10-SS5YJ3-41-M5	10-SYJ3□43	1/8	M5 x 0.8	0.32	0.25	0.081	0.33	0.19	0.079	—
	Type 10-SS5YJ3-41-C4			C4	0.32	0.28	0.079	0.35	0.24	0.084	—
	Type 10-SS5YJ3-41-M5			M5 x 0.8	0.33	0.29	0.082	0.34	0.17	0.081	—
	Type 10-SS5YJ3-41-C4	C4	0.32	0.27	0.079	0.34	0.24	0.084	—		
	Type 10-SS5YJ3-46-M5	10-SYJ3□43	1/8	M5 x 0.8	0.20	0.25	0.048	0.10	0.12	0.024	—
	Type 10-SS5YJ3-46-C4			C4	0.21	0.27	0.050	0.21	0.13	0.047	—
	Type 10-SS5YJ3-46-M5			M5 x 0.8	0.20	0.25	0.048	0.19	0.16	0.024	—
	Type 10-SS5YJ3-46-C4	C4	0.22	0.34	0.057	0.10	0.090	0.024	—		

Note) The values are for individually operated 2 position type manifold bases.

How to Order Manifold (Example)

Instruct by specifying the valves and blanking plate assembly to be mounted on the manifold along with the manifold base model no.

Example:

- 10-SS5YJ3-20-03 1 set (Manifold base)
- 10-SS5YJ3-S41-03-C4 ... 1 set (Manifold base)
- * 10-SYJ3123-5G-M3 ... 2 sets (Valve)
- * 10-SYJ3143-5LZ 2 sets (Valve)
- * SYJ3000-21-12A 1 set (Blanking plate assembly)
- * SYJ3000-21-12A 1 set (Blanking plate assembly)

↳ The asterisk denotes the symbol for assembly. Prefix it to the part no. of the solenoid valve, etc.

* Use manifold specification sheet.



Note) CE-compliant:
For DC only.

[Option]

Flat Ribbon Cable Manifold

- Multiple valve wiring is simplified through the use of the flat ribbon cable connector.
- Clean appearance

For flat ribbon cables, each valve is wired on the print board of the manifold base to allow the external wiring to be piped all together with the 26 pin MIL connector.

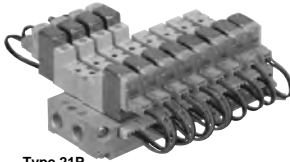

Type 21P

Flat Ribbon Cable Manifold Specifications

Model		Type 21P	Type 32P
Manifold type		Single base/B mount	
P (SUP), R (EXH)		Common SUP, Common EXH	
Valve stations		4 to 12 stations	
A, B port Porting specifications	Location	Valve	Base
	Direction	Top	Side
Port size	P, R port	1/8	
	A, B port	M3 x 0.5	M5 x 0.8, C4 (Ø4 One-touch fitting)
Applicable flat ribbon cable connector		Socket: 26 pin MIL type with strain relief (Conforming to MIL-C-83503)	
Internal wiring		Common between +COM and -COM (Z type: +COM only)	
Rated voltage <small>Note 2)</small>		24, 12 VDC/100, 110 VAC	

Note 1) The withstand voltage specifications for the wiring unit section conforms to JIS C 0704, Grade 1 or its equivalent.
Note 2) CE-compliant: For DC only.

Flow Rate Characteristics

Manifold	Port size	Flow rate characteristics						Effective area (mm ²)			
		1 → 4/2 (P → A/B)			4/2 → 5/3 (A/B → R)						
		C [dm ³ /(s·bar)]	b	Cv	C [dm ³ /(s·bar)]	b	Cv				
Body ported for internal pilot	Type 10-SS5YJ3-21P	10-SYJ3-23	1/8	M3 x 0.5	-	-	-	-	-	0.9	
Base mounted for internal pilot	Type 10-SS5YJ3-32P-M5	10-SYJ3-33	1/8	M5 x 0.8	0.25	0.19	0.060	0.32	0.25	0.077	-
	Type 10-SS5YJ3-32P-C4				C4	0.25	0.18	0.059	0.3	0.27	0.075

Note) The values are for individually operated 2 position type manifold bases.

How to Order Manifold

- 10-SS5YJ3-32P-07-C4 (-Q) 1 pc. (Manifold base) * SYJ3000-21-13A (-Q) 1 pc. (Blanking plate assembly)
- * 10-SYJ3133-5LOU (-Q) 3 pcs. (Valve) * SY3000-37-28A 3 pcs. (Connector assembly)
- * 10-SYJ3233-5LOU (-Q) 3 pcs. (Valve) * SY3000-37-29A 3 pcs. (Connector assembly)

↳ The asterisk denotes the symbol for assembly. Prefix it to the part no. of the solenoid valve, etc.

Note) Please indicate the connector assembly part no. below that connects the valve and the manifold.

How to Order Valve

Note) CE-compliant: [Option]
For DC only.

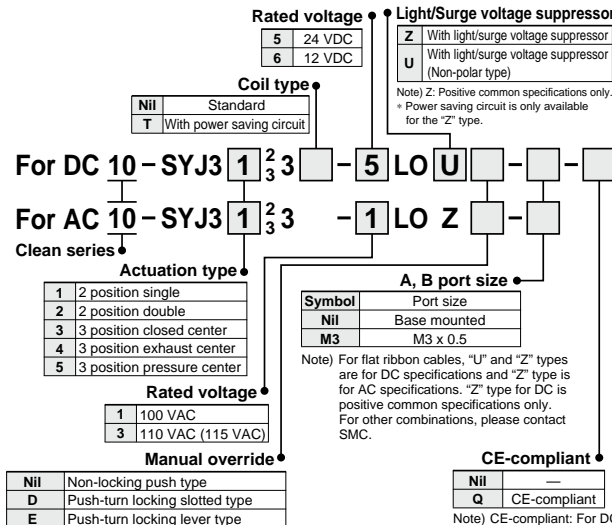

Connector Assembly

For 12, 24 VDC

Single solenoid	SY3000-37-28A
Double solenoid, 3 position type	SY3000-37-29A

For 100 VAC

Single solenoid	SY3000-37-46A
Double solenoid, 3 position type	SY3000-37-47A

For 110 VAC (115 VAC)

Single solenoid	SY3000-37-54A
Double solenoid, 3 position type	SY3000-37-55A

Directional Control Valves
Air Cylinders
Air Actuators
Rotary Actuators
Air Grippers
Air Preparation Equipment
Modular F. R.
Pressure Control Equipment
Fittings & Tubing
Flow Control Equipment
Pressure Switches/Pressure Sensors

EX510 Gateway-type Serial Transmission System

Manifold for EX510 Serial Wiring Specifications

Model		Type 21SA	Type 32SA
Manifold type		Single base/B mount	
P (SUP), R (EXH)		Common SUP, Common EXH	
Valve stations		4 to 16 stations	
A, B port Porting specifications	Location	Valve	Base
	Direction	Top	Side
Port size	P, R port	1/8	
	A, B port	M3 x 0.5	M5 x 0.8, C4 (ø4 One-touch fitting)
Rated voltage		24 VDC	

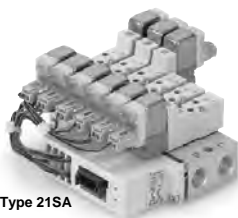

Type 21SA

Flow Rate Characteristics

Manifold			Port size 1(P), 5/3(R) 2(B), 4(A) port	Flow rate characteristics						Effective area (mm ²)	
				1 → 4/2 (P → A/B)			4/2 → 5/3 (A/B → R)				
				C (dm ³ /s-bar)	b	Cv	C (dm ³ /s-bar)	b	Cv		
Body ported for internal pilot	Type 10-SSSYJ3-21SA	10-SYJ3□23	1/8	M3 x 0.5	—	—	—	—	—	0.9	
Base mounted for internal pilot	Type 10-SSSYJ3-32SA-M5	10-SYJ3□33	1/8	M5 x 0.8	0.25	0.19	0.060	0.32	0.25	0.077	—
	Type 10-SSSYJ3-32SA-C4			C4	0.25	0.18	0.059	0.3	0.27	0.075	—

Note) The values are for individually operated 2 position type manifold bases.

How to Order Manifold

10-SS5YJ3-21SA-06..... 1 set (Type 21SA, 6-station manifold part no.)

* 10-SYJ3123-5LOU-M3..... 4 sets (Single solenoid part no.)

* 10-SYJ3223-5LOU-M3..... 2 sets (Double solenoid part no.)

↳ The asterisk denotes the symbol for assembly. Prefix it to the part no. of the solenoid valve, etc.

Add the valve and option part number under the manifold base part number.

When entry of part numbers becomes complicated, indicate by the manifold specification sheet. For a EX510 manifold, the length of the lead wire for a connector assembly depends on the number of stations. Therefore, the manifold assembly is shipped with the valves (including blanking plates) and connector assembly mounted on it, as the standard specification. Be sure to specify the part no. of the solenoid valves to be mounted.

How to Order Manifold

10-SS5YJ3-21SA - **04** - -

- Clean series**
- SI unit**

Nil	NPN output (+ COM.)
N	PNP output (- COM.)
- CE-compliant**

Nil	—
Q	CE-compliant
- Valve stations**

Symbol	Stations	Note
04	4 stations	Double wiring ^{Note 1)}
:	:	
08	8 stations	Specified layout ^{Note 2)} (Up to 16 solenoids)
04	4 stations	
:	:	
16	16 stations	
- P, R port thread type**

Nil	Rc
00F	G
00N	NPT
00T	NPTF
- SI unit part no.**

Symbol	SI unit specifications	SI unit part no.	Page
Nil	NPN output (+ COM.)	EX510-S001	WEB catalog
N	PNP output (- COM.)	EX510-S101	

· Includes the number of the blanking plate assemblies.
 Note 1) Double wiring: Use of a single solenoid will result in an unused control signal. If this is not desired, order with a specified layout.
 Note 2) Specified layout: Indicate wiring specifications on the manifold specification sheet. (Note that double and 3 position valves cannot be used where single solenoid wiring has been specified.)

Refer to the **WEB catalog** and the Operation Manual for the details of the EX510 Gateway-type Serial Transmission System. Please download the Operation Manual via our website, <http://www.smcworld.com>

How to Order Valve

10-SYJ3 **1** **23** - **5LO** **Z** - **M3** -

- Clean series**
- Coil type**

Nil	Standard
T	With power saving circuit
- Rated voltage: 24 VDC**
- Light/Surge voltage suppressor**

Z	With light/surge voltage suppressor
U	With light/surge voltage suppressor (Non-polar type)

* Power saving circuit is only available for the "Z" type.
- Manual override**

Nil	Non-locking push type
D	Push-turn locking slotted type
E	Push-turn locking lever type
- Actuation type**

1	2 position single
2	2 position double
3	3 position closed center
4	3 position exhaust center
5	3 position pressure center
- A, B port size**
- CE-compliant**

Nil	—
Q	CE-compliant

How to Order Manifold Assembly (Example)

Example

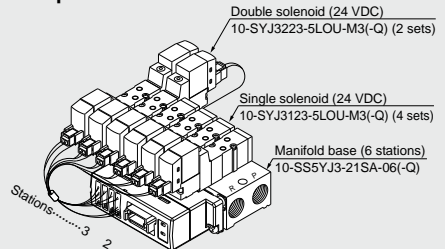

10-SS5YJ3-21SA-06 (-Q).....1 set (Type 21SA, 6-station manifold part no.)
 *10-SYJ3123-5LOU-M3 (-Q)....4 sets (Single solenoid part no.)
 *10-SYJ3223-5LOU-M3 (-Q)....2 sets (Double solenoid part no.)
 ↳ The asterisk denotes the symbol for assembly. Prefix it to the part no. of the solenoid valve, etc.

Add the valve and option part number under the manifold base part number. When entry of part numbers becomes complicated, indicate by the manifold specification sheet. For a EX510 manifold, the length of the lead wire for a connector assembly depends on the number of stations. Therefore, the manifold assembly is shipped with the valves (including blanking plates) and connector assembly mounted on it, as the standard specification. Be sure to specify the part no. of the solenoid valves to be mounted.

Series 10-SYJ3000

EX510 Gateway-type Serial Transmission System
Base Mounted Manifold



How to Order Manifold

10-SS5YJ3-32SA [] - **04** - **M5** [] - []

↓ Clean series

SI unit

Nil	NPN output (+ COM.)
N	PNP output (- COM.)

Valve stations

Symbol	Stations	Note
04	4 stations	Double wiring ^{Note 1)}
:	:	
08	8 stations	Specified layout ^{Note 2)} (Up to 16 solenoids)
04	4 stations	
:	:	
16	16 stations	

• Includes the number of the blanking plate assemblies.
Note 1) Double wiring: Use of a single solenoid will result in an unused control signal. If this is not desired, order with a specified layout.
Note 2) Specified layout: Indicate wiring specifications on the manifold specification sheet. (Note that double and 3 position valves cannot be used where single solenoid wiring has been specified.)

• P, R port thread type

Nil	Rc
F	G
N	NPT
T	NPTF

• A, B port size

M5	M5 x 0.8
C4	ø4 One-touch fitting
N3	ø5/32" One-touch fitting

SI unit part no.

Symbol	SI unit specifications	SI unit part no.	Page
Nil	NPN output (+ COM.)	EX510-S001	WEB
N	PNP output (- COM.)	EX510-S101	catalog

Refer to the **WEB catalog** and the Operation Manual for the details of the EX510 Gateway-type Serial Transmission System. Please download the Operation Manual via our website, <http://www.smcworld.com>

How to Order Valve

10-SYJ3 [] **1** **33** [] - **5LO** **Z** [] - []

↓ Clean series

Coil type

Nil	Standard
T	With power saving circuit

Rated voltage: 24 VDC

Light/Surge voltage suppressor

Z	With light/surge voltage suppressor
U	With light/surge voltage suppressor (Non-polar type)

* Power saving circuit is only available for the "Z" type.

Manual override

Nil	Non-locking push type
D	Push-turn locking slotted type
E	Push-turn locking lever type

Actuation type

1	2 position single
2	2 position double
3	3 position closed center
4	3 position exhaust center
5	3 position pressure center

CE-compliant

Nil	—
Q	CE-compliant

How to Order Manifold Assembly (Example)

Example

10-SS5YJ3-32SA-06-M5 (-Q).....1 set (Type Z2S, 6-station manifold part no.)
 * 10-SYJ3133-5LOU (-Q).....4 sets (Single solenoid part no.)
 * 10-SYJ3233-5LOU (-Q).....2 sets (Double solenoid part no.)

— The asterisk denotes the symbol for assembly. Prefix it to the part no. of the solenoid valve, etc.

Add the valve and option part number under the manifold base part number. When entry of part numbers becomes complicated, indicate by the manifold specification sheet. For a EX510 manifold, the length of the lead wire for a connector assembly depends on the number of stations. Therefore, the manifold assembly is shipped with the valves (including blanking plates) and connector assembly mounted on it, as the standard specification. Be sure to specify the part no. of the solenoid valves to be mounted.

Directional Control Valves
 Air Cylinders
 Rotary Actuators
 Air Grippers
 Air Preparation Equipment
 Modular F. R.
 Pressure Control Equipment
 Fittings & Tubing
 Flow Control Equipment
 Pressure Switches/Pressure Sensors



Note) CE-compliant:
For DC only.

[Option]

Individual Wiring

Common SUP/Common EXH

Note) For more than 10 stations, supply pressure to P port on both sides and exhaust from R port on both sides. Except type 41.

Type 20 (5 port/Body ported)

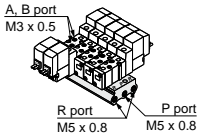

How to Order

10-SS5YJ3-20-05-□-□

Clean series

02	2 stations
:	:
20	20 stations

CE-compliant

Nil	—
Q	CE-compliant

Applicable solenoid valve
10-SYJ3□23-□□□□-M3(-Q)

Applicable blanking plate assembly
Refer to page 302.

Type 31 (4 port/Base mounted)

Type 31 Type S31 (Single solenoid pilot valve is on same side as the A, B port.)

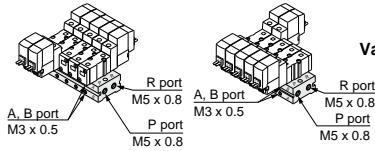

How to Order

10-SS5YJ3-□-31-05-M3-□

Clean series

Valve mounting direction

Nil	Single solenoid pilot valve is on opposite side as the A, B port.
S	Single solenoid pilot valve is on same side as the A, B port.

Stations

02	2 stations
:	:
20	20 stations

CE-compliant

Nil	—
Q	CE-compliant

Applicable solenoid valve
10-SYJ3□33-□□□□(-Q)

Applicable blanking plate assembly
Refer to page 302.

Type 32 (4 port/Base mounted)

Type 32 Type S32 (Single solenoid pilot valve is on same side as the A, B port.)

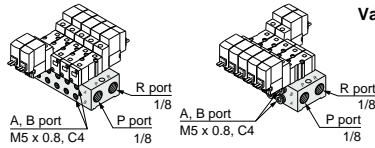

How to Order

10-SS5YJ3-□-32-05-M5-□-□

Clean series

Valve mounting direction

Nil	Single solenoid pilot valve is on opposite side as the A, B port.
S	Single solenoid pilot valve is on same side as the A, B port.

Stations

02	2 stations
:	:
20	20 stations

A, B port size

M5	M5 x 0.8
C4	ø4 One-touch fitting
N3	ø5/32" One-touch fitting

CE-compliant

Nil	—
Q	CE-compliant

P, R port thread type

Nil	Rc
F	G
N	NPT
T	NPTF

Type 41 (5 port/Base mounted)

Type 41 Type S41 (Single solenoid pilot valve is on same side as the A, B port.)

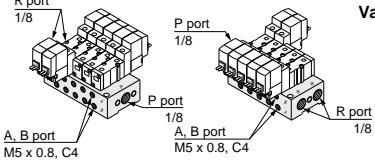

How to Order

10-SS5YJ3-□-41-05-C4-□-□

Clean series

Valve mounting direction

Nil	Single solenoid pilot valve is on opposite side as the A, B port.
S	Single solenoid pilot valve is on same side as the A, B port.

Stations

02	2 stations
:	:
20	20 stations

A, B port size

M5	M5 x 0.8
C4	ø4 One-touch fitting
N3	ø5/32" One-touch fitting

CE-compliant

Nil	—
Q	CE-compliant

P, R port thread type

Nil	Rc
F	G
N	NPT
T	NPTF

Applicable solenoid valve
10-SYJ3□43-□□□□(-Q)
Applicable blanking plate assembly
Refer to page 302.

Common SUP/Individual EXH

Note) For more than 10 stations, supply pressure to P port on both sides.

Type 46 (5 port/Base mounted)

Type 46 Type S46 (Single solenoid pilot valve is on same side as the A, B port.)

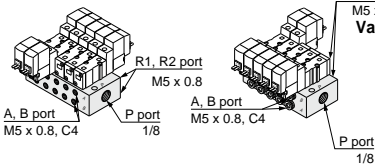

How to Order

10-SS5YJ3-□-46-05-M5-□-□

Clean series

Valve mounting direction

Nil	Single solenoid pilot valve is on opposite side as the A, B port.
S	Single solenoid pilot valve is on same side as the A, B port.

Stations

02	2 stations
:	:
20	20 stations

A, B port size

M5	M5 x 0.8
C4	ø4 One-touch fitting
N3	ø5/32" One-touch fitting

CE-compliant

Nil	—
Q	CE-compliant

Applicable solenoid valve
10-SYJ3□43-□□□□(-Q)
Applicable blanking plate assembly
Refer to page 302.





Note) CE-compliant:
For DC only. [Option]

Flat Ribbon Cable Manifold

Common SUP/Common EXH

Note) For more than 10 stations, supply pressure to P port on both sides and exhaust from R port on both sides. Except type 41.

Type 21P (5 port/Body ported)

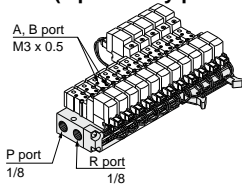

How to Order

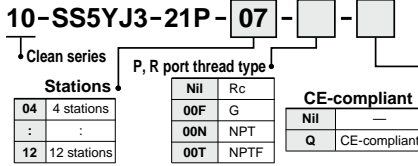

Applicable solenoid valve
Refer to page 294.

Applicable connector assembly
Refer to page 294.

Applicable blanking plate assembly
Refer to page 302.

Type 32P (4 port/Base mounted)

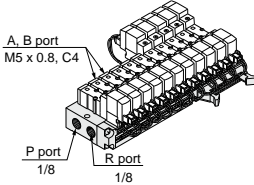

How to Order

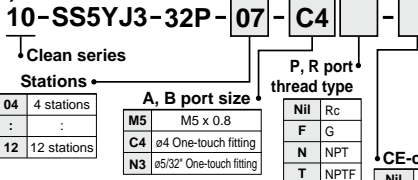

Applicable solenoid valve
Refer to page 294.

Applicable connector assembly
Refer to page 294.

Applicable blanking plate assembly
Refer to page 302.

EX510 Gateway-type Serial Transmission System

Type 21SA (5 port/Body ported)

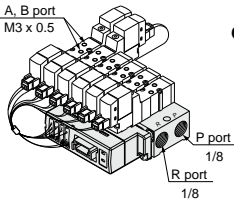

How to Order

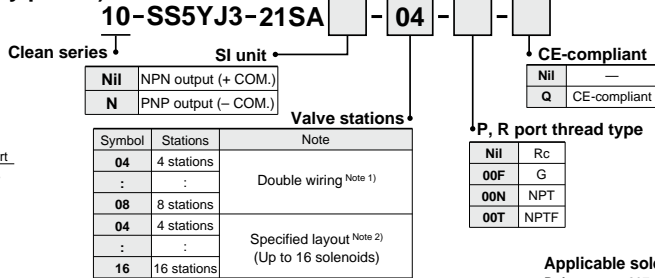

- Includes the number of the blanking plate assemblies.
Note 1) Double wiring: Use of a single solenoid will result in an unused control signal. If this is not desired, order with a specified layout.
Note 2) Specified layout: Indicate wiring specifications on the manifold specification sheet. (Note that double and 3 position valves cannot be used where single solenoid wiring has been specified.)

Applicable solenoid valve
Refer to page 297.

Applicable blanking plate assembly
Refer to page 302.

Type 32SA (4 port/Base mounted)

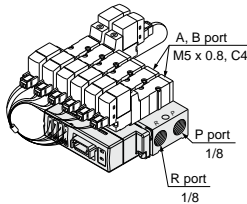

How to Order

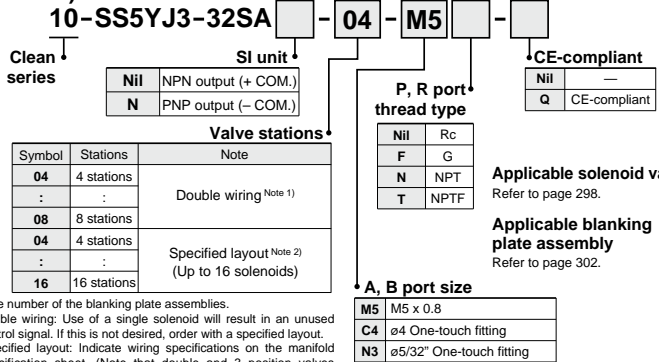

- Includes the number of the blanking plate assemblies.
Note 1) Double wiring: Use of a single solenoid will result in an unused control signal. If this is not desired, order with a specified layout.
Note 2) Specified layout: Indicate wiring specifications on the manifold specification sheet. (Note that double and 3 position valves cannot be used where single solenoid wiring has been specified.)

Applicable solenoid valve
Refer to page 298.

Applicable blanking plate assembly
Refer to page 302.

Directional Control Valves
Air Cylinders
Rotary Actuators
Air Grippers
Air Preparation Equipment
Modular F. R.
Pressure Control Equipment
Fittings & Tubing
Flow Control Equipment
Pressure Switches/ Pressure Sensors

Combination of Blanking Plate Assembly and Manifold Base

Blanking plate assembly SYJ3000-21-12A(-Q)

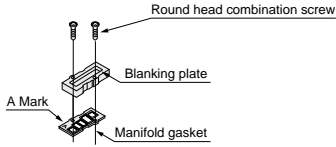

Applicable manifold base

- Type 10-SS5YJ3-20(-Q)
- Type 10-SS5YJ3-21SA(-Q)
- Type 10-SS5YJ3-41(-Q)
- Type 10-SS5YJ3-S41(-Q)
- Type 10-SS5YJ3-46(-Q)
- Type 10-SS5YJ3-S46(-Q)
- Type 10-SS5YJ3-31(-Q)
- Type 10-SS5YJ3-S31(-Q)
- Type 10-SS5YJ3-32(-Q)
- Type 10-SS5YJ3-S32(-Q)
- Type 10-SS5YJ3-32SA(-Q)

Manifold base

Note) Manifold gasket "SYJ3000-14-2" can be used with the following manifold bases.

- Manifold base of
- Type 10-SS5YJ3-31(-Q)
 - S31(-Q)
 - 32(-Q)
 - S32(-Q)
 - 32SA(-Q)

Blanking plate assembly SYJ3000-21-13A(-Q)

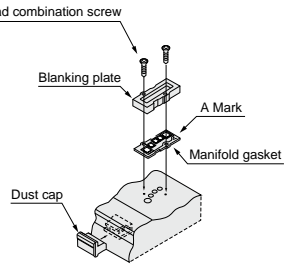

Applicable manifold base

- 10-SS5YJ3-21P(-Q)
- 10-SS5YJ3-32P(-Q)

Manifold base

Caution

Mounting screw tightening torque

M1.7: 0.12 N·m

Use caution to the assembly orientation for solenoid valves, gasket, and optional parts.

Directional Control Valves

Air Cylinders

Rotary Actuators

Air Grippers

Air Preparation Equipment

Modular F. R.

Pressure Control Equipment

Fittings & Tubing

Flow Control Equipment

Pressure Switches/ Pressure Sensors

Type 20 Manifold: Top Ported/10-SS5YJ3-20- Stations

* []: AC

Grommet (G)

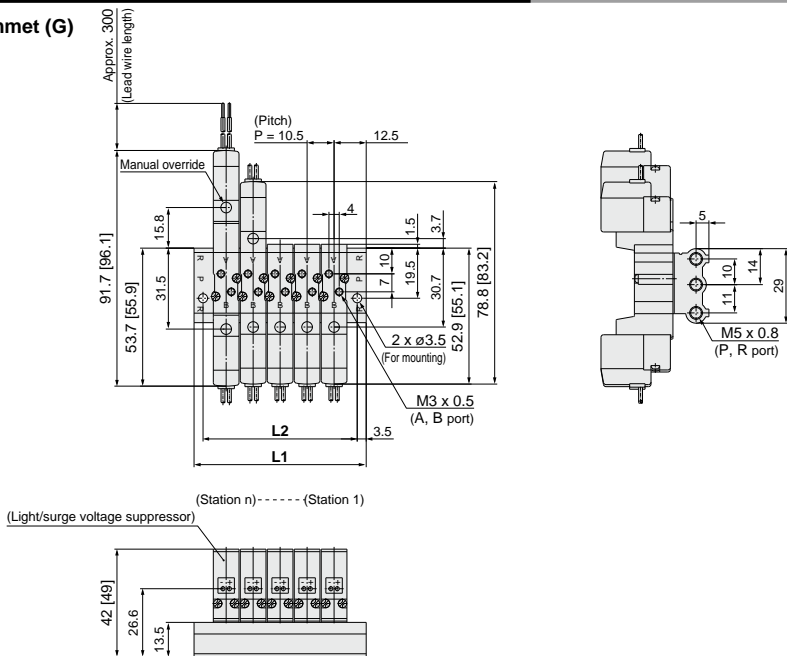

L plug connector (L)

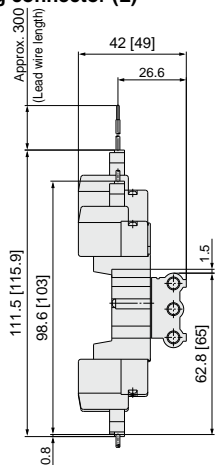

M plug connector (M)

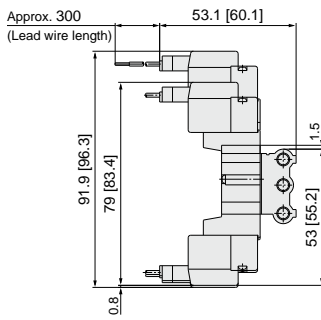

M8 connector (WO)

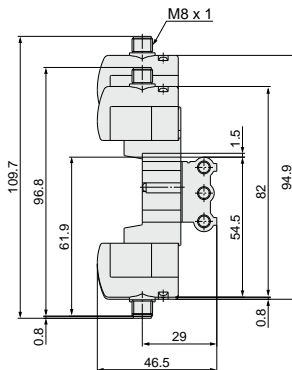

* Refer to page 375 for dimensions with connector cable.

Station	Station 2	3	4	5	6	7	8	9	10	11	12	13	14	15	16	17	18	19	Station 20
L1	35.5	46	56.5	67	77.5	88	98.5	109	119.5	130	140.5	151	161.5	172	182.5	193	203.5	214	224.5
L2	28.5	39	49.5	60	70.5	81	91.5	102	112.5	123	133.5	144	154.5	165	175.5	186	196.5	207	217.5

Type 31 Manifold: Side Ported/10-SS5YJ3-31- Stations -M3

* [] : AC

Grommet (G)

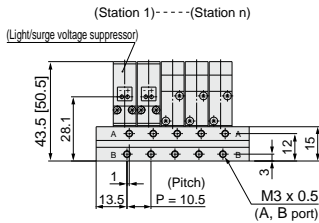
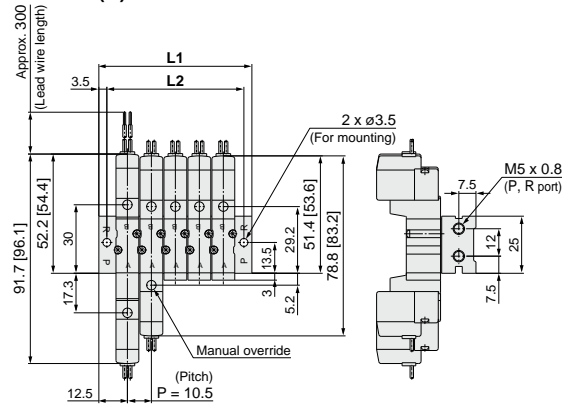

Type S31 Manifold: Side Ported 10-SS5YJ3-S31- Stations -M3

(Single solenoid pilot valve is on same side as the A, B port.)

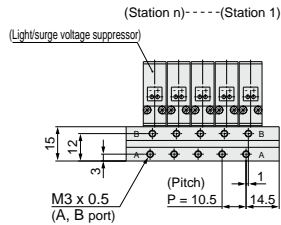
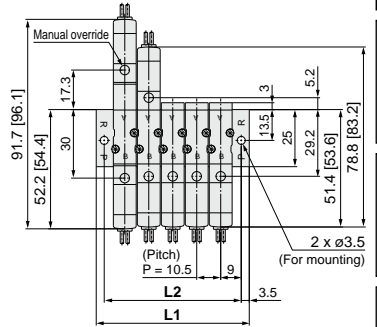

L plug connector (L)

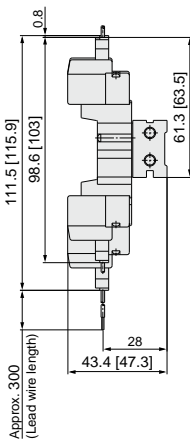

M plug connector (M)

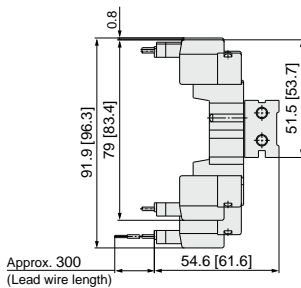

M8 connector (WO)

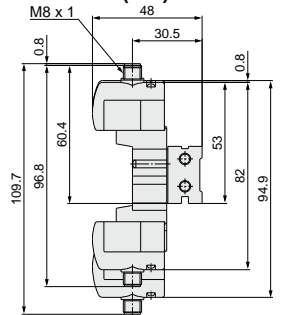

* Refer to page 375 for dimensions with connector cable.

Station	Station 2	3	4	5	6	7	8	9	10	11	12	13	14	15	16	17	18	19	Station 20
L1	35.5	46	56.5	67	77.5	88	98.5	109	119.5	130	140.5	151	161.5	172	182.5	193	203.5	214	224.5
L2	28.5	39	49.5	60	70.5	81	91.5	102	112.5	123	133.5	144	154.5	165	175.5	186	196.5	207	217.5

Type 32 Manifold: Side Ported/10-SS5YJ3-32- **Stations** -M5, **C4** **N3** □

* [] : AC

Grommet (G)
For M5

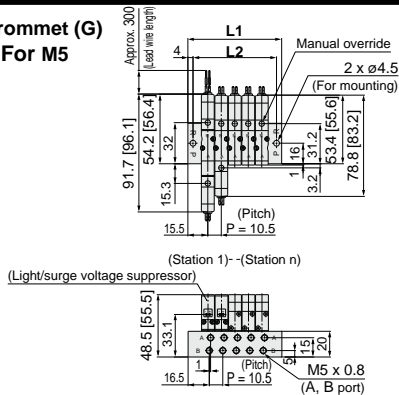

For C4 □ **(Built-in One-touch fitting)**

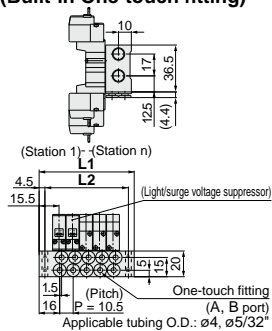

L plug connector (L)

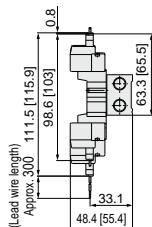

M plug connector (M)

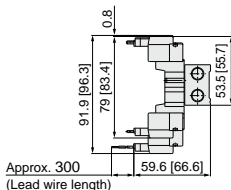

M8 connector (WO)

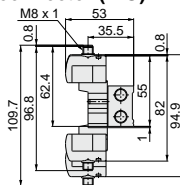

* Refer to page 375 for dimensions with connector cable.

Type S32 Manifold: Side Ported (Single solenoid pilot valve is on same side as the A, B port.) **/10-SS5YJ3-S32-** **Stations** -M5, **C4** **N3** □

For M5

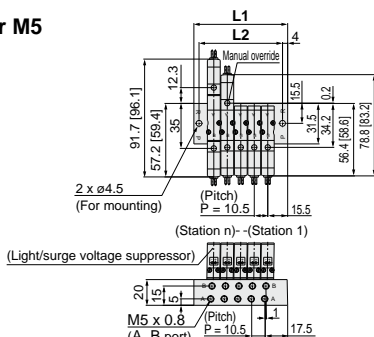

For C4 □ **(Built-in One-touch fitting)**

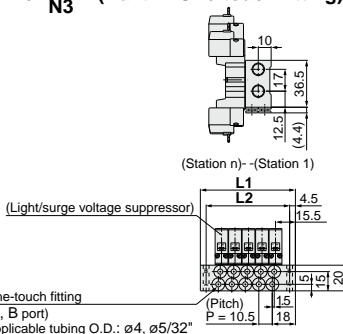

10-SS5YJ3-32, S32- **Stations** -M5

Station	Station 2	3	4	5	6	7	8	9	10	11	12	13	14	15	16	17	18	19	Station 20
L1	41.5	52	62.5	73	83.5	94	104.5	115	125.5	136	146.5	157	167.5	178	188.5	199	209.5	220	230.5
L2	33.5	44	54.5	65	75.5	86	96.5	107	117.5	128	138.5	149	159.5	170	180.5	191	201.5	212	222.5

10-SS5YJ3-32, S32- **Stations** -C4

Station	Station 2	3	4	5	6	7	8	9	10	11	12	13	14	15	16	17	18	19	Station 20
L1	42.5	53	63.5	74	84.5	95	105.5	116	126.5	137	147.5	158	168.5	179	189.5	200	210.5	221	231.5
L2	33.5	44	54.5	65	75.5	86	96.5	107	117.5	128	138.5	149	159.5	170	180.5	191	201.5	212	222.5

Type 41 Manifold: Side Ported/10-SS5YJ3-41- Stations -M5, C4 N3

* [] : AC

**Grommet (G)
For M5**

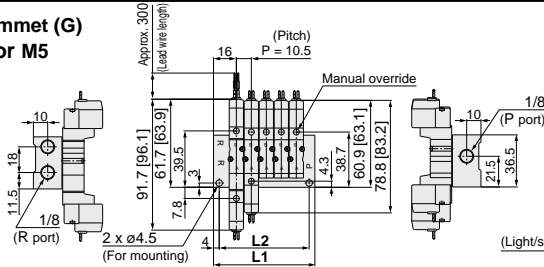

For C4 N3 (Built-in One-touch fitting)

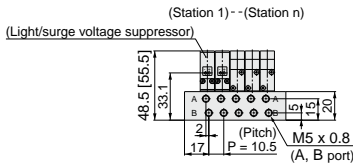
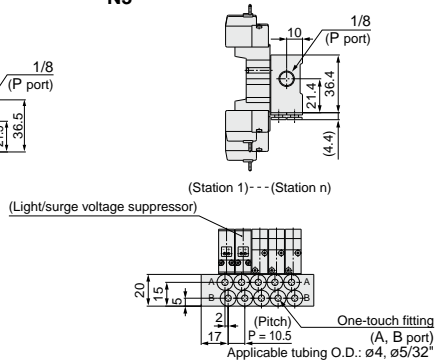

L plug connector (L)

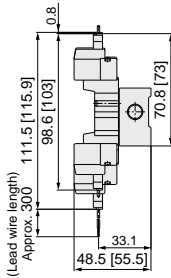

M plug connector (M)

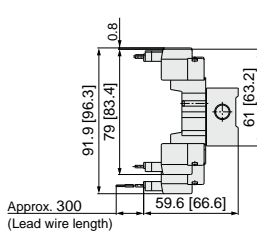

M8 connector (WO)

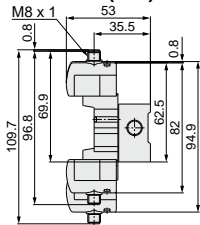

* Refer to page 375 for dimensions with connector cable.

Type S41 Manifold: Side Ported (Single solenoid pilot valve is on same side as the A, B port.) /10-SS5YJ3-S41- Stations -M5, C4 N3

For M5

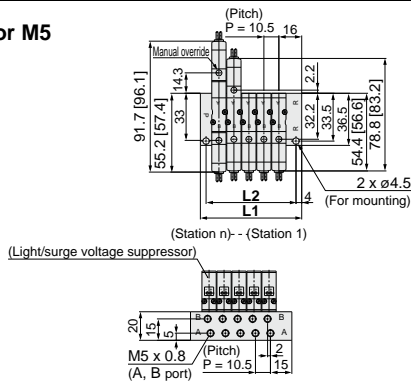

For C4 N3 (Built-in One-touch fitting)

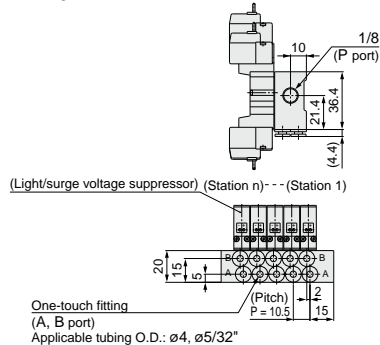

Station	Station 2	3	4	5	6	7	8	9	10	11	12	13	14	15	16	17	18	19	Station 20
L1	39.5	50	60.5	71	81.5	92	102.5	113	123.5	134	144.5	155	165.5	176	186.5	197	207.5	218	228.5
L2	31.5	42	52.5	63	73.5	84	94.5	105	115.5	126	136.5	147	157.5	168	178.5	189	199.5	210	220.5

Directional Control Valves
Air Cylinders
Rotary Actuators
Air Grippers
Air Preparation Equipment
Modular F. R.
Pressure Control Equipment
Fittings & Tubing
Flow Control Equipment
Pressure Switches/Pressure Sensors

Type 46 Manifold: Side Ported/10-SS5YJ3-46- Stations -M5, C4 N3

* []: AC

**Grommet (G)
For M5**

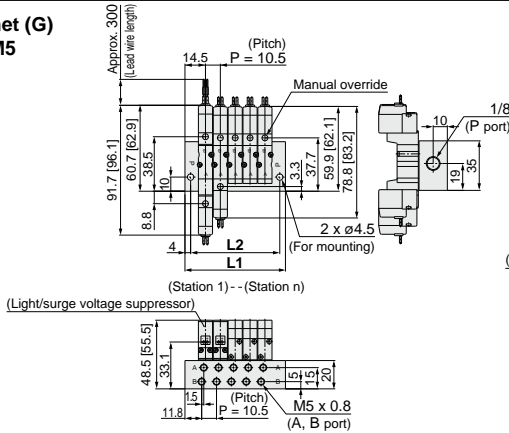

For C4 N3 (Built-in One-touch fitting)

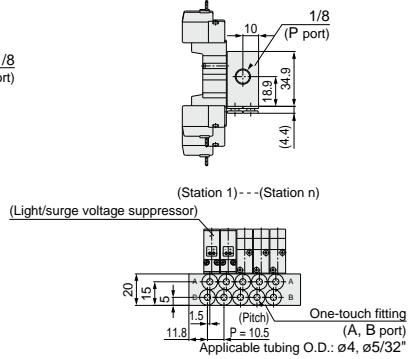

L plug connector (L)

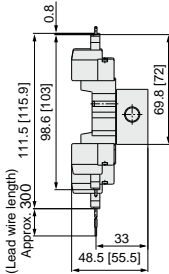

M plug connector (M)

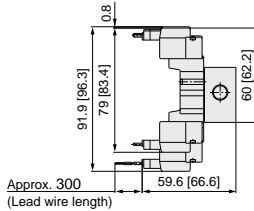

M8 connector (WO)

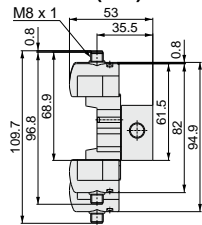

* Refer to page 375 for dimensions with connector cable.

Type S46 Manifold: Side Ported (Single solenoid pilot valve is on same side as the A, B port.) /10-SS5YJ3-S46- Stations -M5, C4 N3

For M5

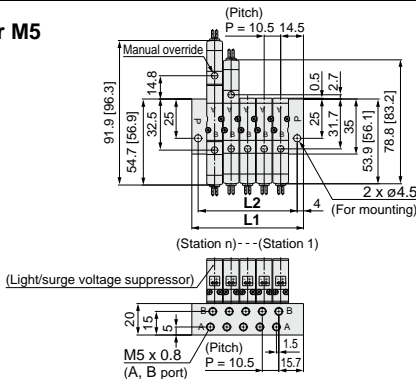

For C4 N3 (Built-in One-touch fitting)

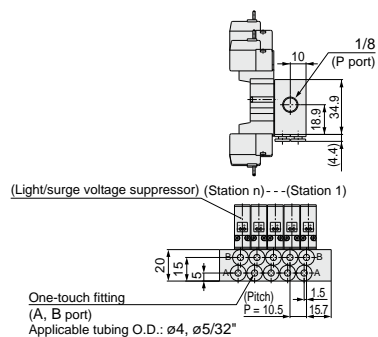

Station	Station 2	3	4	5	6	7	8	9	10	11	12	13	14	15	16	17	18	19	Station 20
L1	39.5	50	60.5	71	81.5	92	102.5	113	123.5	134	144.5	155	165.5	176	186.5	197	207.5	218	228.5
L2	31.5	42	52.5	63	73.5	84	94.5	105	115.5	126	136.5	147	157.5	168	178.5	189	199.5	210	220.5

Flat Ribbon Cable Manifold

* []: AC

10-SS5YJ3-21P- Stations -00

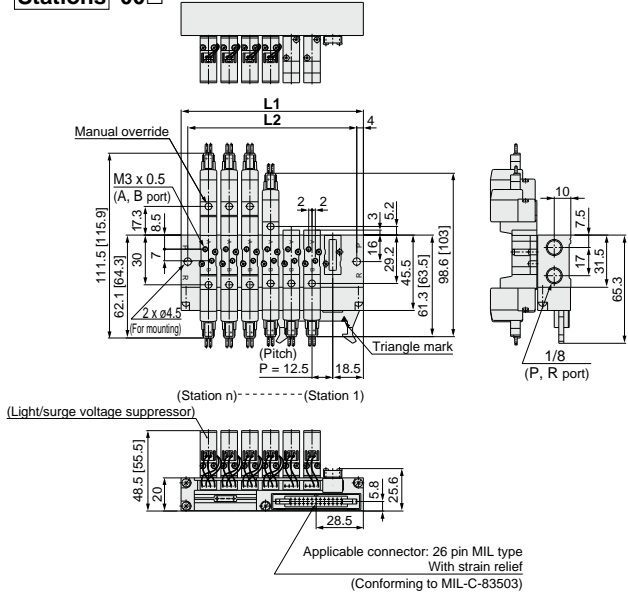

10-SS5YJ3-32P- Stations -M5, C4 N3
For M5

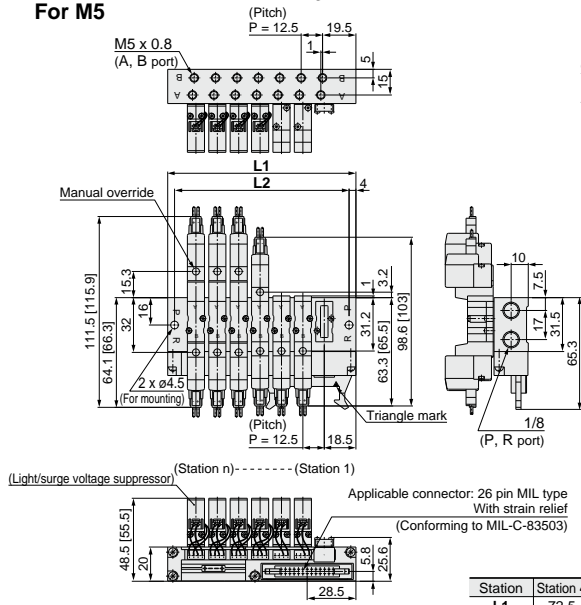

For **C4 N3** (Built-in One-touch fitting)

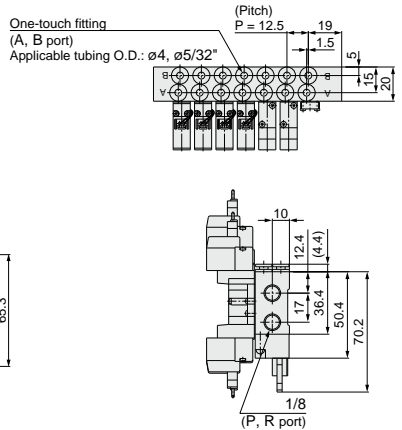

Station	Station 4	5	6	7	8	9	10	11	Station 12
L1	72.5	85	97.5	110	122.5	135	147.5	160	172.5
L2	64.5	77	89.5	102	114.5	127	139.5	152	164.5

Directional Control Valves

Air Cylinders

Rotary Actuators

Air Grippers

Air Preparation Equipment

Modular F. R.

Pressure Control Equipment

Fittings & Tubing

Flow Control Equipment

Pressure Switches/ Pressure Sensors

EX510 Gateway-type Serial Transmission System

10-SYJ3000: 10-SS5YJ3-21SA□-Stations□-□

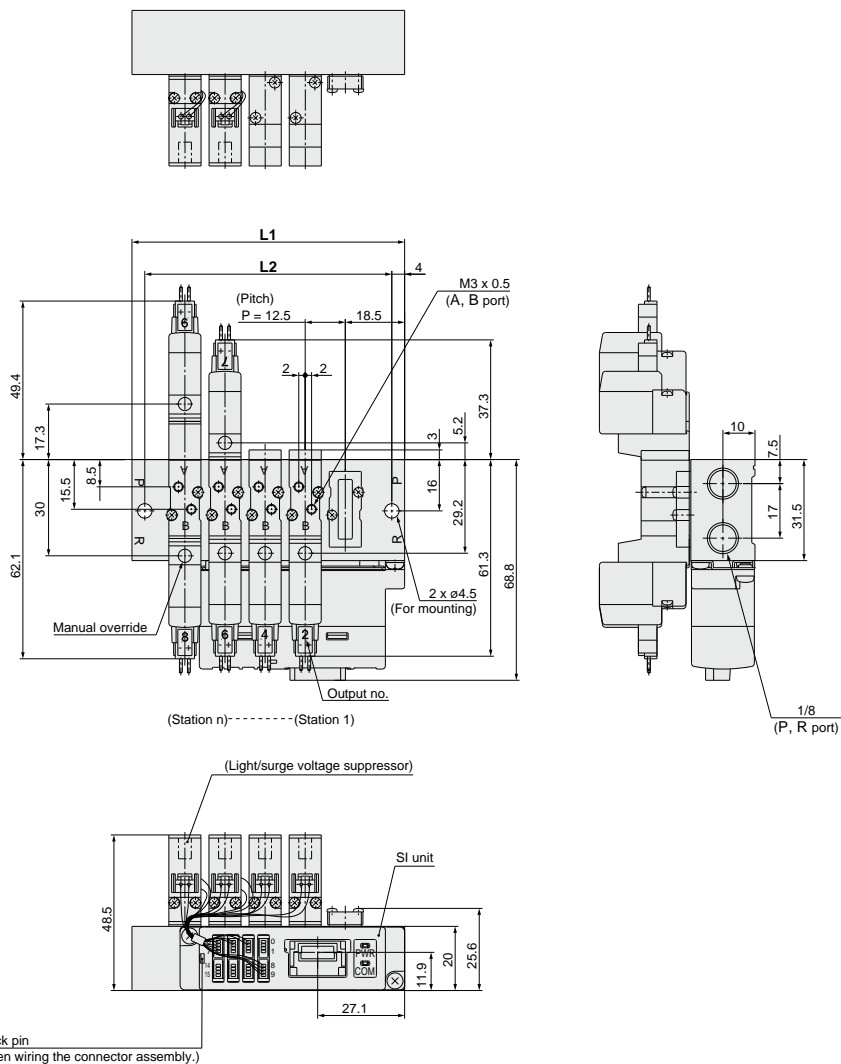

Station	Station 4	5	6	7	8	9	10	11	12	13	14	15	Station 16
L1	72.5	85	97.5	110	122.5	135	147.5	160	172.5	185	197.5	210	222.5
L2	64.5	77	89.5	102	114.5	127	139.5	152	164.5	177	189.5	202	214.5

EX510 Gateway-type Serial Transmission System

10-SYJ3000: 10-SS5YJ3-32SA□-Stations-M5, C4, N3□ For C4, N3□ (Built-in One-touch fitting)

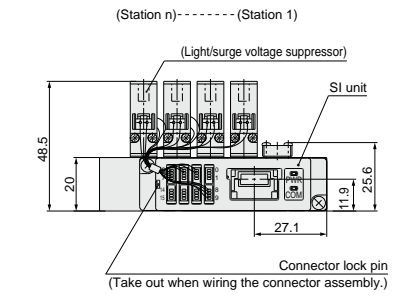
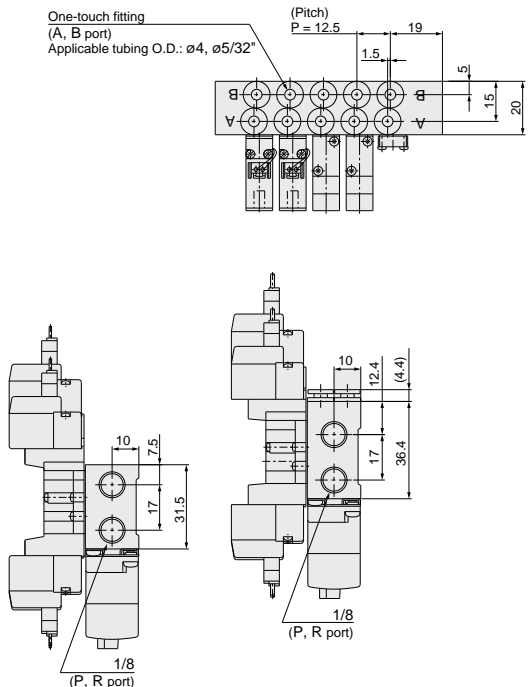
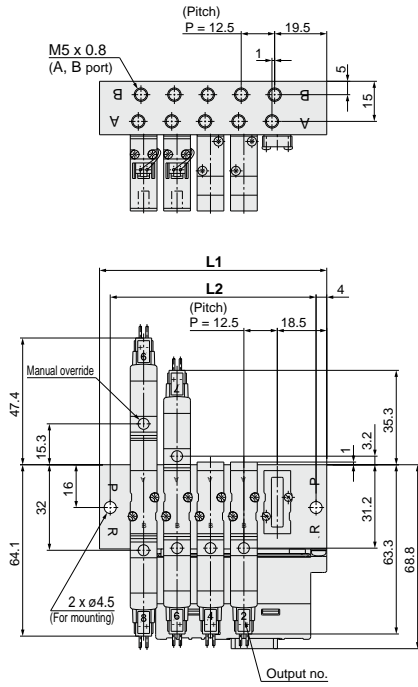

Station	Station 4	5	6	7	8	9	10	11	12	13	14	15	Station 16
L1	72.5	85	97.5	110	122.5	135	147.5	160	172.5	185	197.5	210	222.5
L2	64.5	77	89.5	102	114.5	127	139.5	152	164.5	177	189.5	202	214.5

- Directional Control Valves
- Air Cylinders
- Rotary Actuators
- Air Grippers
- Air Preparation Equipment
- Modular F. R.
- Pressure Control Equipment
- Fittings & Tubing
- Flow Control Equipment
- Pressure Switches/ Pressure Sensors

Flow Rate Characteristics/Weight

Valve model	Actuation type	Port size		Flow rate characteristics <small>Note 1)</small>						Weight (g) <small>Note 2, 3)</small>					
		1, 5, 3 (P, EA, EB)	4, 2 (A, B)	1 → 4/2 (P → A/B)			4/2 → 5/3 (A/B → EA/EB)			Grommet	L/M plug connector	DIN terminal	M8 connector		
				C [dm ³ /(s·bar)]	b	Cv	C [dm ³ /(s·bar)]	b	Cv						
Body ported	10-SYJ5□23-□-M5	2 position	Single	M5 x 0.8	M5 x 0.8	0.47	0.41	0.13	0.47	0.41	0.13	46	47	68	51
			Double			0.49	0.44	0.13	0.44	0.40	0.12	64	66	108	74
		3 position	Closed center			0.46	0.37	0.12	0.47 [0.39]	0.43 [0.35]	0.13 [0.10]	75	77	119	85
			Exhaust center Pressure center			0.49 [0.39]	0.51 [0.38]	0.14 [0.10]	0.45	0.42	0.12				
	10-SYJ5□23-□-C4	2 position	Single	M5 x 0.8	C4 (ø4 One-touch fitting)	0.69	0.39	0.18	0.44	0.39	0.12	53	54	75	58
			Double			0.69	0.40	0.19	0.43	0.40	0.12	71	73	115	81
		3 position	Closed center			0.56	0.40	0.15	0.41 [0.41]	0.37 [0.37]	0.10 [0.11]	82	84	126	72
			Exhaust center Pressure center			0.57 [0.41]	0.4 [0.37]	0.15 [0.10]	0.41	0.37	0.10				
	10-SYJ5□23-□-C6	2 position	Single	M5 x 0.8	C6 (ø6 One-touch fitting)	0.70	0.36	0.19	0.47	0.40	0.12	53	54	75	58
			Double			0.72	0.37	0.19	0.44	0.34	0.12	71	73	115	81
		3 position	Closed center			0.67	0.54	0.19	0.41 [0.41]	0.38 [0.38]	0.11 [0.11]	82	84	126	92
			Exhaust center Pressure center			0.82 [0.44]	0.41 [0.39]	0.23 [0.12]	0.41	0.36	0.11				
Base mounted	10-SYJ5□43-□-□1	2 position	Single	1/8	1/8	0.79	0.21	0.19	0.83	0.32	0.21	80 (49)	81 (47)	102 (68)	51
			Double			0.80	0.28	0.18	0.86	0.34	0.20	98 (64)	100 (66)	142 (108)	74
		3 position	Closed center			0.71	0.26	0.18	1.1 [0.60]	0.24 [0.44]	0.26 [0.18]	109 (75)	111 (77)	153 (119)	85
	Exhaust center		0.99 [0.47]	0.29 [0.38]	0.24 [0.12]	0.72	0.38	0.18							
	Pressure center														

Note 1) []: denotes normal position. Exhaust center: 4/2 → 5/3, Pressure center: 1 → 4/2

Note 2) (): Without sub-plate.

Note 3) For DC voltages. For AC voltages, add 3 g to the weight of the single solenoid and 6 g to the weight of the double solenoid and 3 position types.

Directional Control Valves

Air Cylinders

Rotary Actuators

Air Grippers

Air Preparation Equipment

Modular F. R.

Pressure Control Equipment

Fittings & Tubing

Flow Control Equipment

Pressure Switches/ Pressure Sensors



How to Order

Note) AC-type models that are CE-compliant have DIN terminals only.

[Option]

Actuation type

1	2 position single solenoid
2	2 position double solenoid
3	3 position closed center
4	3 position exhaust center
5	3 position pressure center

Light/Surge voltage suppressor

Electrical entry for G, H, L, M, W

Nil	Without light/surge voltage suppressor
S	With surge voltage suppressor
Z	With light/surge voltage suppressor
R	With surge voltage suppressor (Non-polar type)
U	With light/surge voltage suppressor (Non-polar type)

* For AC voltage valves there is no "S" option. It is already built into the rectifier circuit.
 * For type "R" and "U", only DC voltage is available.
 * Power saving circuit is only available for the "Z" type.

Electrical entry for D, Y

Nil	Without light/surge voltage suppressor
S	With surge voltage suppressor (Non-polar type)
Z	With light/surge voltage suppressor (Non-polar type)

* DOZ and YOZ are not available.
 * For AC voltage valves there is no "S" option. It is already built into the rectifier circuit.

Rated voltage

DC	AC (50/60 Hz)
5	1
6	2
V	3
S	4
R	

* DC specifications of type D, Y, DO and YO are only available with 12 and 24 VDC.
 * For type W□, only DC voltage is available. Note) AC-type models that are CE-compliant have DIN terminals only.

A, B port size

M5	M5 x 0.8
C4	ø4 One-touch fitting
C6	ø6 One-touch fitting
N3	ø5/32" One-touch fitting
N7	ø1/4" One-touch fitting

Bracket

Nil: Without bracket
F: With bracket

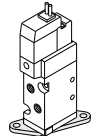

Note) The mounting bracket is supplied unattached.
 * 2 position single type only.

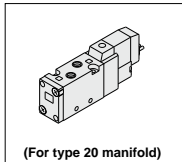

Body ported

Base mounted

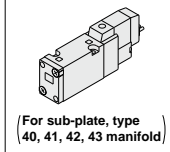

Clean series

Body option

3: Main/Pilot valve common exhaust type

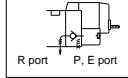

Coil type

Nil	Standard
T	With power saving circuit <24, 12 VDC only>

* Power saving circuit is not available for D, Y, DO, YO or W□ types.

CE-compliant

Nil	—
Q	CE-compliant

Note) AC-type models that are CE-compliant have DIN terminals only.

Thread type

Nil	Rc
F	G
N	NPT
T	NPTF

Manual override

Nil: Non-locking push type



D: Push-turn locking slotted type

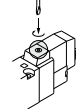

E: Push-turn locking lever type

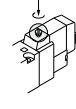

Note) When placing an order for body ported solenoid valves as a single unit, the mounting screws for the manifold and gasket are not attached. Order them separately, if necessary. (For details, refer to page 329.)

Electrical entry

Grommet	24, 12, 6, 5, 3 VDC 100, 110, 200, 220 VAC		24, 12 VDC 100, 110, 200, 220 VAC		24, 12, 6, 5, 3 VDC	
	L plug connector	M plug connector	DIN terminal	M8 connector	DIN terminal	M8 connector
G: Lead wire length 300 mm	L: With lead wire (Length 300 mm)	M: With lead wire (Length 300 mm)	MN: Without lead wire	D, Y: With connector	WO: Without connector cable	
H: Lead wire length 600 mm	LN: Without lead wire	LO: Without connector	MO: Without connector	DO, YO: Without connector	W□: With connector cable (Note 1)	

CE	DC	—
compliant	AC	—

* LN, MN type: With 2 sockets.
 * Refer to page 371 for the lead wire length of L and M plug connectors.
 * Refer to page 374 for the connector assembly with cover for L and M plug connectors.
 * DIN terminal type "Y" which conforms to EN-175301-803C (former DIN4365C) is also available. For details, refer to page 373.
 * For connector cable of M8 connector, refer to page 374.
 * M8 connector conforming to IEC60947-5-2 standard is also available. Refer to page 369 for details.

Note 1) Enter the cable length symbols in □. Please be sure to fill in the blank referring to page 374.



Construction

2 position single

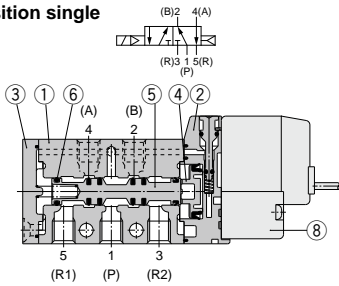

2 position double

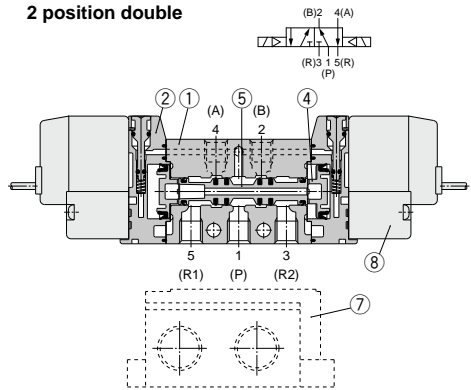

3 position closed center/exhaust center/pressure center

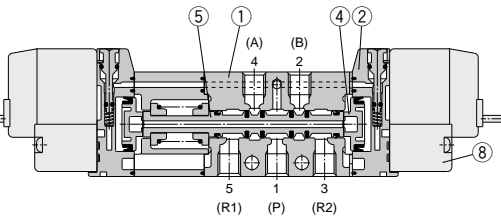
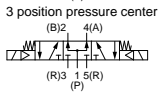
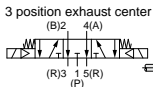
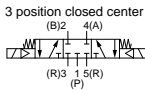

(This figure shows a closed center type.)

Component Parts

No.	Description	Material	Note
1	Body	Aluminum die-casted	White
2	Piston plate	Resin	White
3	End cover	Resin	White
4	Piston	Resin	—
5	Spool valve assembly	Aluminum, H-NBR	—
6	Spool spring	Stainless steel	—

Replacement Parts

No.	Description	Part no.	Note
7	Sub-plate ^(Note)	SYJ5000-22-1(-Q)	Aluminum die-casted
8	Pilot valve	V111(T)-□□□	—
—	Bracket assembly	SYJ5000-13-3A	—

* Add suffix "-Q" for the CE-compliant product.

Directional Control Valves

Air Cylinders

Rotary Actuators

Air Grippers

Air Preparation Equipment

Modular F. R.

Pressure Control Equipment

Fittings & Tubing

Flow Control Equipment

Pressure Switches/ Pressure Sensors

How to Order Pilot Valve Assembly

V111 - 5 G

● **Coil type**

Nil	Standard
T	With power saving circuit (24, 12 VDC only)

* Power saving circuit is not available for W type.

● **Rated voltage**

5	24 VDC
6	12 VDC
V	6 VDC
S	5 VDC
R	3 VDC
1	100 VAC 50/60 Hz
2	200 VAC 50/60 Hz
3	110 VAC 50/60 Hz [115 VAC 50/60 Hz]
4	220 VAC 50/60 Hz [230 VAC 50/60 Hz]

* For type W , only DC voltage is available.
* CE-compliant: For DC only.

● **Light/Surge voltage suppressor**

Nil	Without light/surge voltage suppressor
S	With surge voltage suppressor
Z	With light/surge voltage suppressor
R	With surge voltage suppressor (Non-polar type)
U	With light/surge voltage suppressor (Non-polar type)

* For AC voltage valves there is no "S" option. It is already built into the rectifier circuit.
* For type "R" and "U", only DC voltage is available.
* Power saving circuit is only available for the "Z" type.

● **Electrical entry**

G	Grommet, 300 mm lead wire
H	Grommet, 600 mm lead wire
L	With lead wire
LN	L plug connector Without lead wire
LO	Without connector
M	With lead wire
MN	M plug connector Without lead wire
MO	Without connector
WO	M8 Without connector cable
W <input type="checkbox"/>	connector With connector cable ^{Note 1)}

* For connector cable of M8 connector, refer to page 374.
Note 1) Enter the cable length symbols in . Please be sure to fill in the blank referring to page 374.

V115 - 5 D

● **Rated voltage**

5	24 VDC
6	12 VDC
1	100 VAC 50/60 Hz
2	200 VAC 50/60 Hz
3	110 VAC 50/60 Hz [115 VAC 50/60 Hz]
4	220 VAC 50/60 Hz [230 VAC 50/60 Hz]

* DC specifications of type D and DO are only available with 12 and 24 VDC.

* Power saving circuit is not available for D or DO types.

● **Light/Surge voltage suppressor**

Nil	Without light/surge voltage suppressor
S	With surge voltage suppressor (Non-polar type)
Z	With light/surge voltage suppressor (Non-polar type)

* DOZ and YOZ are not available.
* For AC voltage valves there is no "S" option. It is already built into the rectifier circuit.

● **Electrical entry**

D	DIN terminal	With connector
DO	(Type D)	Without connector
Y	DIN terminal	With connector
YO	(Type Y)	Without connector

Note) Do not replace V111 (G, H, L, M, W) with V115 (DIN terminal) and vice versa when replacing pilot valve assembly only.

Note) Since V111 and V115 are CE-compliant as standard, the suffix "-Q" is not necessary.

2 Position Single

* [] : AC

Grommet (G), (H): 10-SYJ5123-□^G_H□□-M5

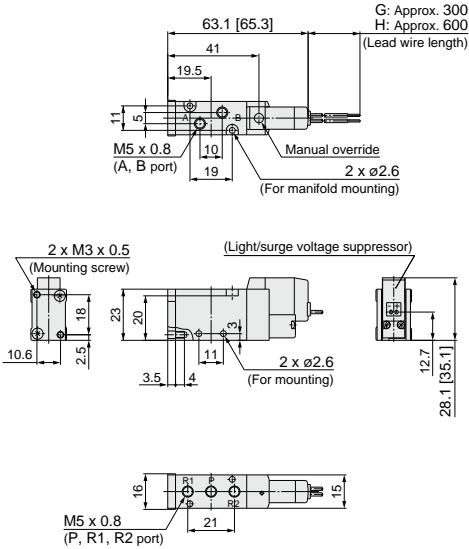

With bracket:
10-SYJ5123-□^G_H□□-M5-F

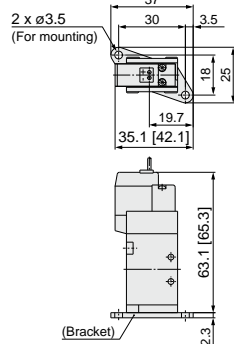

Built-in One-touch fitting:
10-SYJ5123-□^G_H□□-C4, N3, C6, N7 (-F)

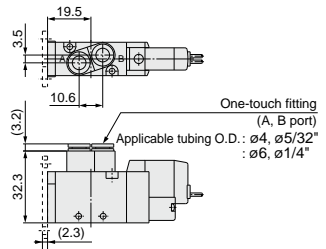

L plug connector (L):
10-SYJ5123-□L□□-M5(-F)

M plug connector (M):
10-SYJ5123-□M□□-M5(-F)

DIN terminal (D, Y):
10-SYJ5123-□□□-M5(-F)

M8 connector (WO):
10-SYJ5123-□WO□□-M5(-F)

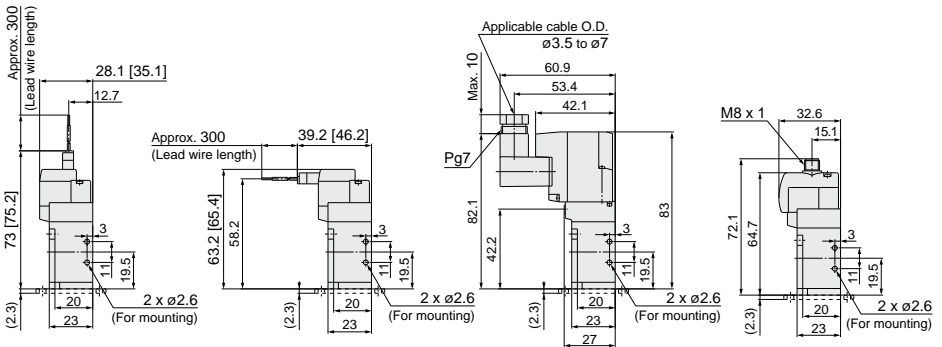

* Refer to page 375 for dimensions with connector cable.

2 Position Double

* []: AC

Grommet (G), (H): 10-SYJ5223-□^G□□-M5

Built-in One-touch fitting:
10-SYJ5223-□^G□□-M5 ^{C4, N3}
□□-C6, N7

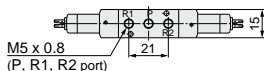
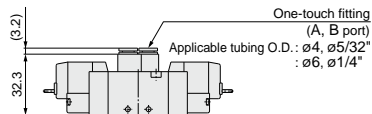
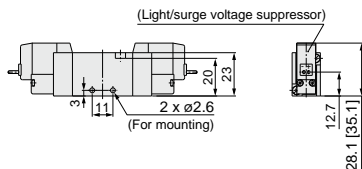
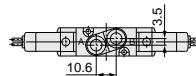
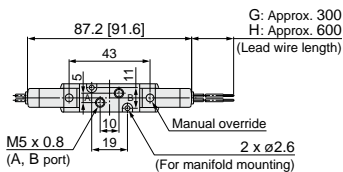

L plug connector (L):
10-SYJ5223-□L□□-M5

M plug connector (M):
10-SYJ5223-□M□□-M5

DIN terminal (D, Y):
10-SYJ5223-□^D□□-M5

M8 connector (WO):
10-SYJ5223-□WO□□-M5

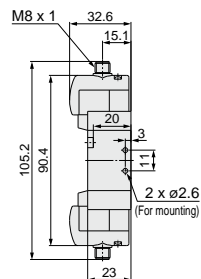
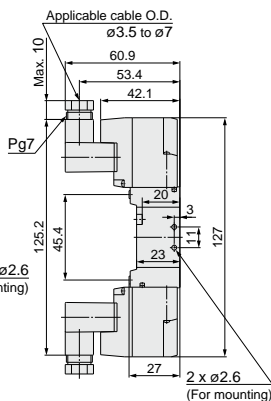
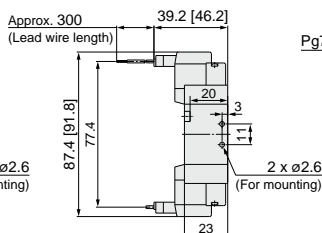
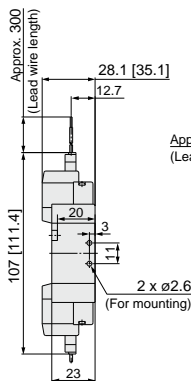

* Refer to page 375 for dimensions with connector cable.

3 Position Closed Center/Exhaust Center/Pressure Center

* [] : AC

Grommet (G), (H): 10-SYJ5³/₅23-□^G□□-M5

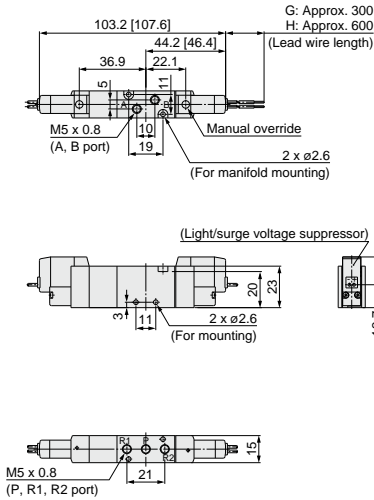

**Built-in One-touch fitting:
10-SYJ5³/₅23-□^{C4, N3}□□-C6, N7**

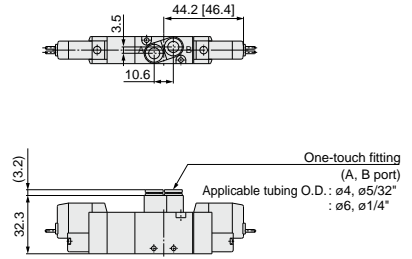

**L plug connector (L):
10-SYJ5³/₅23-□L□□-M5**

**M plug connector (M):
10-SYJ5³/₅23-□M□□-M5**

**DIN terminal (D, Y):
10-SYJ5³/₅23-□Y□□-M5**

**M8 connector (WO):
10-SYJ5³/₅23-□WO□□-M5**

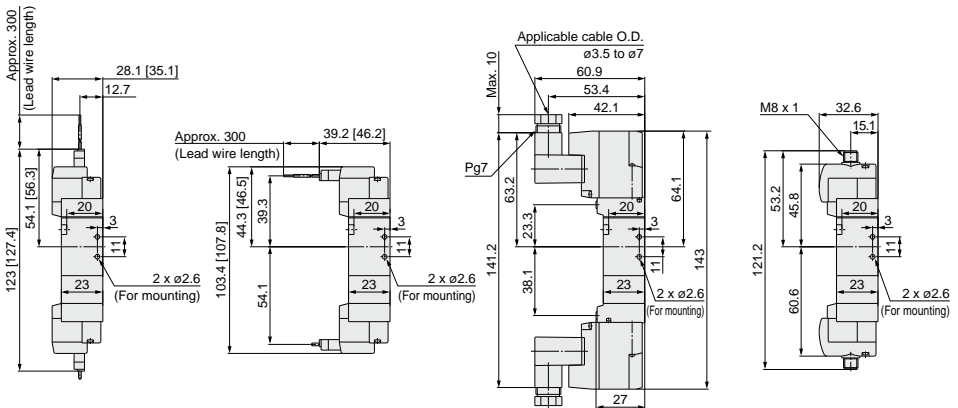

* Refer to page 375 for dimensions with connector cable.

Directional Control Valves

Air Cylinders

Rotary Actuators

Air Grippers

Air Preparation Equipment

Modular F. R.

Pressure Control Equipment

Fittings & Tubing

Flow Control Equipment

Pressure Switches/Pressure Sensors

2 Position Single

* []: AC

Grommet (G), (H): 10-SYJ5143-□^G□□-01□

Built-in throttle valve:
10-SYJ5153-□^G□□-01□

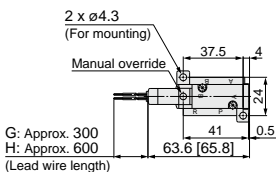
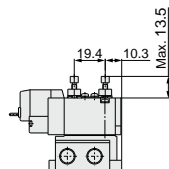
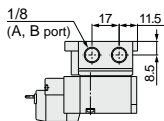

(Light/surge voltage suppressor)

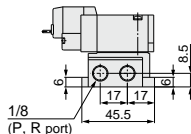
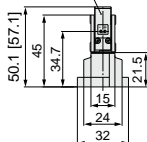

L plug connector (L):
10-SYJ5143-□L□□-01□

M plug connector (M):
10-SYJ5143-□M□□-01□

DIN terminal (D, Y):
10-SYJ5143-□^D□□-01□

M8 connector (WO):
10-SYJ5143-□WO□□-01□

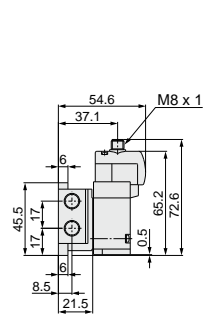
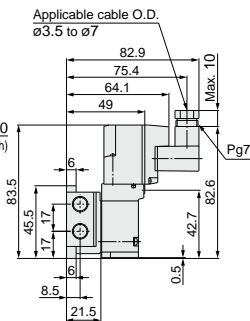
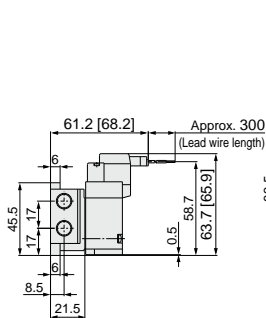
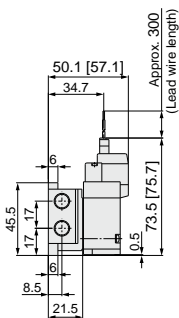

* Refer to page 375 for dimensions with connector cable.

2 Position Double

* [] : AC

Grommet (G), (H): 10-SYJ5243-□_G□□-01□

Built-in throttle valve:
10-SYJ5253-□_H□□-01□

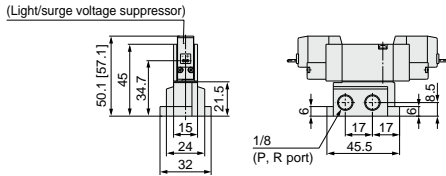
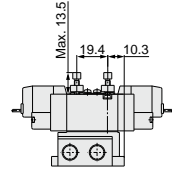
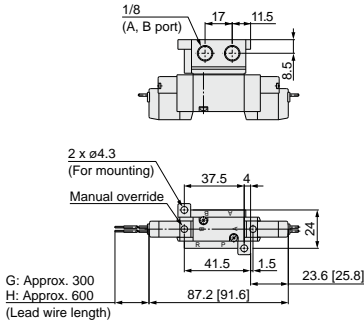

L plug connector (L):
10-SYJ5243-□L□□-01□

M plug connector (M):
10-SYJ5243-□M□□-01□

DIN terminal (D, Y):
10-SYJ5243-□_D□□-01□

M8 connector (WO):
10-SYJ5243-□WO□□-01□

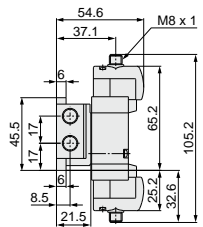
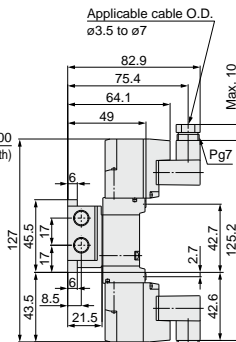
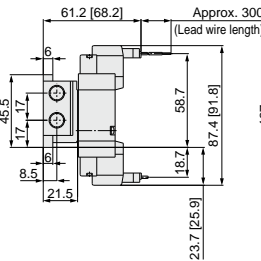
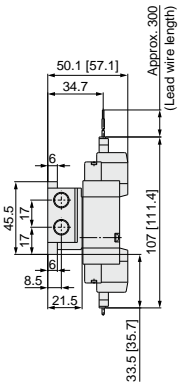

* Refer to page 375 for dimensions with connector cable.

Directional Control Valves

Air Cylinders

Rotary Actuators

Air Grippers

Air Preparation Equipment

Modular F. R.

Pressure Control Equipment

Fittings & Tubing

Flow Control Equipment

Pressure Switches/ Pressure Sensors

3 Position Closed Center/Exhaust Center/Pressure Center

* [] : AC

Grommet (G), (H): 10-SYJ5³/₅43-□^G□□-01□

Built-in throttle valve:
10-SYJ5³/₅43-□^G□□-01□

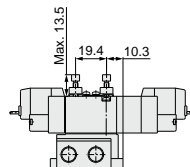
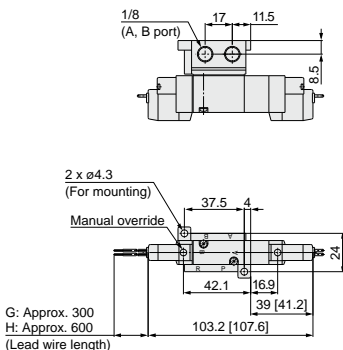

(Light/surge voltage suppressor)

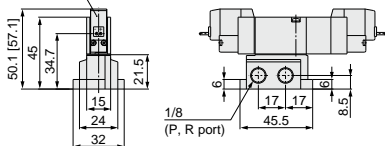

L plug connector (L):

10-SYJ5³/₅43-□□□-01□

M plug connector (M):

10-SYJ5³/₅43-□□□-01□

DIN terminal (D, Y):

10-SYJ5³/₅43-□□□-01□

M8 connector (WO):

10-SYJ5³/₅43-□□□-01□

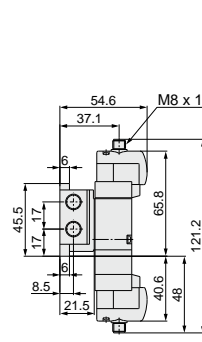
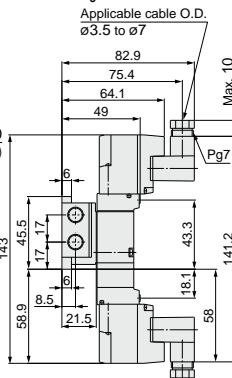
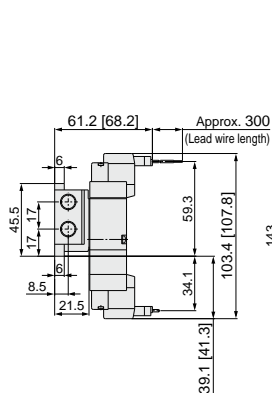
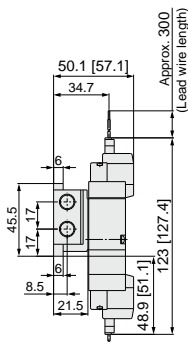

* Refer to page 375 for dimensions with connector cable.

Manifold Specifications



Standard Manifold



Manifold Specifications

Model		Type 20	Type 40	Type 41	Type 42	Type 43
Manifold type		Single base/B mount				
P (SUP), R (EXH)		Common SUP, Common EXH				
Valve stations		2 to 20 stations				
A, B port Porting specifications	Location	Valve	Base	Base		
	Direction	Top	Bottom	Side		
Port size	P, R port	1/8			1/4	1/8
	A, B port	M5 x 0.8, C4 (ø4 One-touch fitting) C6 (ø6 One-touch fitting)	M5 x 0.8		1/8, C6 (ø6 One-touch fitting)	C4 (ø4 One-touch fitting)

Flow Rate Characteristics

Manifold			Port size		Flow rate characteristics					
					1 → 4/2 (P → A/B)			4/2 → 5/3 (A/B → R)		
					C [dm ³ /(s·bar)]	b	Cv	C [dm ³ /(s·bar)]	b	Cv
Body ported for internal pilot	Type 10-SS5YJ5-20	10-SYJ5-23	1/8	M5 x 0.8	0.46	0.39	0.12	0.75	0.32	0.19
			1/8	C4	0.62	0.33	0.16	0.83	0.27	0.20
			1/8	C6	0.79	0.36	0.21	0.91	0.36	0.24
Base mounted for internal pilot	Type 10-SS5YJ5-40	10-SYJ5-43	1/8	M5 x 0.8	0.55	0.35	0.15	0.64	0.26	0.16
			1/8	M5 x 0.8	0.59	0.35	0.16	0.68	0.23	0.17
	Type 10-SS5YJ5-42-C6	10-SYJ5-43	1/4	1/8	0.74	0.22	0.18	0.82	0.31	0.21
			1/4	C6	0.71	0.24	0.17	0.8	0.29	0.20
			1/8	C4	0.55	0.29	0.14	0.74	0.32	0.19

Note) The values are for individually operated 2 position type manifold bases.

How to Order Manifold (Example)

Instruct by specifying the valves and blanking plate assembly to be mounted on the manifold along with the manifold base model no.

- Example: 10-SS5YJ5-20-03 1 pc. (Manifold base)
 * 10-SYJ5123-5G-M5 2 pcs. (Valve)
 * SYJ5000-21-5A 1 pc. (Blanking plate assembly)
- 10-SS5YJ5-43-03-C4 1 pc. (Manifold base)
 * 10-SYJ5143-5LZ 1 pc. (Valve)
 * 10-SYJ5243-5LZ 1 pc. (Valve)
 * SYJ5000-21-6A 1 pc. (Blanking plate assembly)

↳ The asterisk denotes the symbol for assembly. Prefix it to the part no. of the solenoid valve, etc.

* Use manifold specification sheet.

Directional Control Valves

Air Cylinders

Rotary Actuators

Air Grippers

Air Preparation Equipment

Modular F. R.

Pressure Control Equipment

Fittings & Tubing

Flow Control Equipment

Pressure Switches/ Pressure Sensors



Flat Ribbon Cable Manifold

Note) CE-compliant:
For DC only.

[Option]

• **Multiple valve wiring is simplified through the use of the flat ribbon cable connector.**

• **Clean appearance**

For flat ribbon cables, each valve is wired on the print board of the manifold base to allow the external wiring to be piped all together with the 26 pin MIL connector.

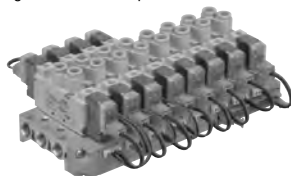

Flat Ribbon Cable Manifold Specifications

Model		Type 20	Type 41P	Type 43P
Manifold type		Single base/B mount		
P (SUP), R (EXH)		Common SUP, Common EXH		
Valve stations		3 to 12 stations		
A, B port	Location	Valve	Base	
Porting specifications	Direction	Top		
P, R port		1/8		
Port size	A, B port	M5 x 0.8, C4 (ø4 One-touch fitting) C6 (ø6 One-touch fitting)	M5 x 0.8	C4 (ø4 One-touch fitting)
	Applicable flat ribbon cable connector	Socket: 26 pin MIL type with strain relief (Conforming to MIL-C-83503)		
Internal wiring		Common between +COM and -COM (Z type: +COM only).		
Rated voltage <small>Note 2)</small>		24, 12 VDC/100, 110 VAC		

Note 1) The withstand voltage specifications for the wiring unit section conforms to JIS C 0704, Grade 1 or its equivalent.
Note 2) CE-compliant: For DC only.

Flow Rate Characteristics

Manifold		Port size	Flow rate characteristics					
			1 → 4/2 (P → A/B)			4/2 → 5/3 (A/B → R)		
1P), 5/3R)	2(B), 4(A) port	C	b	Cv	C	b	Cv	
		[dm ³ /(s·bar)]	[dm ³ /(s·bar)]		[dm ³ /(s·bar)]			
Body ported for internal pilot	Type 10-SS5YJ5-20P	1/8 M5 x 0.8	0.46	0.39	0.12	0.75	0.32	0.19
	10-SYJ5-23	1/8 C4	0.62	0.33	0.16	0.83	0.27	0.20
		1/8 C6	0.79	0.36	0.21	0.91	0.36	0.24
Base mounted for internal pilot	Type 10-SS5YJ5-41P	1/8 M5 x 0.8	0.59	0.35	0.16	0.68	0.23	0.17
	10-SYJ5-43	1/8 C4	0.55	0.29	0.14	0.74	0.32	0.19

Note) The values are for individually operated 2 position type manifold bases.

How to Order Manifold (Example)

Instruct by specifying the valves and blanking plate assembly to be mounted on the manifold along with the manifold base model no.

Example: **10-SS5YJ5-41P-07-C4 (-Q) ... 1 pc. (Manifold base)**
 * **10-SYJ5143-SLOU (-Q) 3 pcs. (Valve)**
 * **10-SYJ5243-SLOU (-Q) 3 pcs. (Valve)**
 * **SYJ5000-21-7A 1 pc. (Blanking plate assembly)**
 * **SY3000-37-28A 3 pcs. (Connector assembly)**
 * **SY3000-37-29A 3 pcs. (Connector assembly)**

↳ The asterisk denotes the symbol for assembly. Prefix it to the part no. of the solenoid valve, etc.

Note) Please indicate the connector assembly part no. below that connects the valve and the manifold.

How to Order Valve

Note) CE-compliant:
For DC only.



[Option]

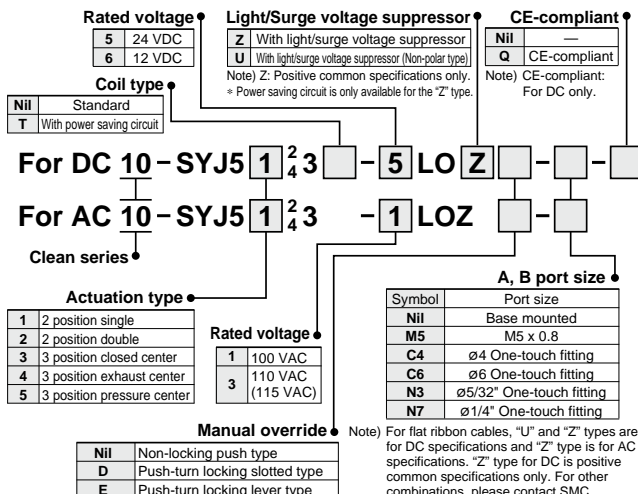

Note) For flat ribbon cables, "U" and "Z" types are for DC specifications and "Z" type is for AC specifications. "Z" type for DC is positive common specifications only. For other combinations, please contact SMC.

Connector Assembly

20P	
For 12, 24 VDC	
Single solenoid	SY3000-37-28A
Double solenoid, 3 position type	SY3000-37-29A
Single solenoid	
With individual EXH spacer assembly	SY3000-37-3A
Double solenoid, 3 position type	
With individual EXH spacer assembly	SY3000-37-4A
With 3 port adapter plate	SY3000-37-3A
For 100 VAC	
Single solenoid	SY3000-37-46A
Double solenoid, 3 position type	SY3000-37-47A
Single solenoid	
With individual EXH spacer assembly	SY3000-37-32A
Double solenoid, 3 position type	
With individual EXH spacer assembly	SY3000-37-33A
With 3 port adapter plate	SY3000-37-32A
For 110 VAC	
Single solenoid	SY3000-37-54A
Double solenoid, 3 position type	SY3000-37-55A
Single solenoid	
With individual EXH spacer assembly	SY3000-37-35A
Double solenoid, 3 position type	
With individual EXH spacer assembly	SY3000-37-36A
With 3 port adapter plate	SY3000-37-35A

EX510 Gateway-type Serial Transmission System

Manifold for EX510 Serial Wiring Specifications

Model		Type 20SA	Type 41SA	Type 42SA	Type 43SA
Manifold type		Single base/B mount			
P (SUP), R (EXH)		Common SUP, Common EXH			
Valve stations		3 to 16 stations			
A, B port Porting specifications	Location	Valve	Base		
	Direction	Top	Side		
Port size	P, R port	1/8		1/4	
	A, B port	M5 x 0.8 C4(ø4 One-touch fitting) C6(ø6 One-touch fitting)	M5 x 0.8	1/8	C4 (ø4 One-touch fitting)
Rated voltage		24 VDC			

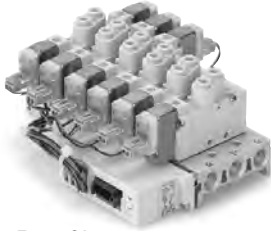

Type 20SA

Flow Rate Characteristics

Manifold		Port size		Flow rate characteristics						
				1 → 4/2(P → A/B)			4/2 → 5/3(A/B → R)			
		1(P), 5/3(R) port	2(B), 4(A) port	C (dm ³ /(s·bar))	b	Cv	C (dm ³ /(s·bar))	b	Cv	
Body ported for internal pilot	Type 10-SSSYJ5-20SA	10-SYJ5□23	1/8	M5 x 0.8	0.46	0.39	0.12	0.75	0.32	0.19
			1/8	C4	0.62	0.33	0.16	0.83	0.27	0.20
Base mounted for internal pilot	Type 10-SSSYJ5-41SA		1/8	M5 x 0.8	0.59	0.35	0.16	0.68	0.23	0.17
	Type 10-SSSYJ5-42SA-01	10-SYJ5□43	1/4	1/8	0.74	0.22	0.18	0.82	0.31	0.21
	Type 10-SSSYJ5-43SA		1/8	C4	0.55	0.29	0.14	0.74	0.32	0.19

Note) The values are for individually operated 2 position type manifold bases.

How to Order Manifold (Example)

10-SSSYJ5-20SA-05	1 set (Type 20SA, 5-station manifold part no.)
* 10-SYJ5123-5LOU-M5	3 sets (Single solenoid part no.)
* 10-SYJ5223-5LOU-M5	2 sets (Double solenoid part no.)

↳ The asterisk denotes the symbol for assembly. Prefix it to the part no. of the solenoid valve, etc.

Add the valve and option part number under the manifold base part number.

When entry of part numbers becomes complicated, indicate by the manifold specification sheet. For an EX510 manifold, the length of the lead wire for a connector assembly depends on the number of stations. Therefore, the manifold assembly is shipped with the valves (including blanking plates) and connector assembly mounted on it, as the standard specification. Be sure to specify the part no. of the solenoid valves to be mounted.

Type 41P, 43P

For 12, 24 VDC	
Single solenoid	SY3000-37-28A
Double solenoid, 3 position type	SY3000-37-29A
Single solenoid With individual SUP/EXH spacer assembly	SY3000-37-3A
Double solenoid, 3 position type With individual SUP/EXH spacer assembly	SY3000-37-4A
Single solenoid With interface regulator	SY3000-37-3A
Double solenoid, 3 position type With interface regulator	SY3000-37-6A
With 3 port adapter plate	SY3000-37-3A

For 100 VAC

Single solenoid	SY3000-37-46A
Double solenoid, 3 position type	SY3000-37-47A
Single solenoid With individual SUP/EXH spacer assembly	SY3000-37-32A
Double solenoid, 3 position type With individual SUP/EXH spacer assembly	SY3000-37-33A
Single solenoid With interface regulator	SY3000-37-15A
Double solenoid, 3 position type With interface regulator	SY3000-37-34A
With 3 port adapter plate	SY3000-37-32A

For 110 VAC

Single solenoid	SY3000-37-54A
Double solenoid, 3 position type	SY3000-37-55A
Single solenoid With individual SUP/EXH spacer assembly	SY3000-37-35A
Double solenoid, 3 position type With individual SUP/EXH spacer assembly	SY3000-37-36A
Single solenoid With interface regulator	SY3000-37-19A
Double solenoid, 3 position type With interface regulator	SY3000-37-37A
With 3 port adapter plate	SY3000-37-35A

Directional Control Valves

Air Cylinders

Rotary Actuators

Air Grippers

Air Preparation Equipment

Modular F. R.

Pressure Control Equipment

Fittings & Tubing

Flow Control Equipment

Pressure Switches/ Pressure Sensors

How to Order Manifold

10 - SS5YJ5 - 20SA [] - **03** - [] - []

- Clean series**
- SI unit**

Nil	NPN output (+ COM.)
N	PNP output (- COM.)
- CE-compliant**

Nil	—
Q	CE-compliant
- Valve stations**

Symbol	Stations	Note
03	3 stations	Double wiring ^{Note 1)}
:	:	
:	:	
08	8 stations	Specified layout ^{Note 2)} (Up to 16 solenoids)
03	3 stations	
:	:	
:	:	
16	16 stations	
- P, R port thread type**

Nil	Rc
00F	G
00N	NPT
00T	NPTF
- SI unit part no.**

Symbol	SI unit specifications	SI unit part no.	Page
Nil	NPN output (+ COM.)	EX510-S001	WEB
N	PNP output (- COM.)	EX510-S101	catalog

* Includes the number of the blanking plate assemblies.
Note 1) Double wiring: Use of a single solenoid will result in an unused control signal. If this is not desired, order with a specified layout.
Note 2) Specified layout: Indicate wiring specifications on the manifold specification sheet. (Note that double and 3 position valves cannot be used where single solenoid wiring has been specified.)

Refer to the **WEB catalog** and the Operation Manual for the details of the EX510 Gateway-type Serial Transmission System. Please download the Operation Manual via our website, <http://www.smworld.com>

How to Order Valve

10 - SYJ5 [1] [23] [] - **5LO** [Z] [] - **M5** - []

- Clean series**
- Rated voltage: 24 VDC**
- Light/Surge voltage suppressor**

Z	With light/surge voltage suppressor
U	With light/surge voltage suppressor (Non-polar type)

* Power saving circuit is only available for the "Z" type.
- Manual override**

Nil	Non-locking push type
D	Push-turn locking slotted type
E	Push-turn locking lever type
- Coil type**

Nil	Standard
T	With power saving circuit
- A, B port size**

M5	M5 x 0.8
C4	ø4 One-touch fitting
C6	ø6 One-touch fitting
N3	ø5/32" One-touch fitting
N7	ø1/4" One-touch fitting
- CE-compliant**

Nil	—
Q	CE-compliant
- Actuation type**

1	2 position single
2	2 position double
3	3 position closed center
4	3 position exhaust center
5	3 position pressure center

How to Order Manifold Assembly (Example)

Example

10-SS5YJ5-20SA-05 (-Q) 1 set (Type 20SA, 5-station manifold part no.)
*** 10-SYJ5123-5LOU-M5 (-Q) 3 sets (Single solenoid part no.)**
*** 10-SYJ5223-5LOU-M5 (-Q) 2 sets (Double solenoid part no.)**

↳ The asterisk denotes the symbol for assembly. Prefix it to the part no. of the solenoid valve, etc.

Add the valve and option part number under the manifold base part number. When entry of part numbers becomes complicated, indicate by the manifold specification sheet. For a EX510 manifold, the length of the lead wire for a connector assembly depends on the number of stations. Therefore, the manifold assembly is shipped with the valves (including blanking plates) and connector assembly mounted on it, as the standard specification. Be sure to specify the part no. of the solenoid valves to be mounted.

Series 10-SYJ5000

EX510 Gateway-type Serial Transmission System
Base Mounted Manifold



How to Order Manifold

Diagram illustrating the order structure for the manifold assembly:

10-SS5YJ5-41SA - **03** - **M5** - []

10-SS5YJ5-42SA - **03** - **01** - []

10-SS5YJ5-43SA - **03** - **C4** - []

SI unit

Nil	NPN output (+ COM.)
N	PNP output (- COM.)

Valve stations

Symbol	Stations	Note
03	3 stations	Double wiring ^{Note 1)}
:	:	
08	8 stations	Specified layout ^{Note 2)} (Up to 16 solenoids)
03	3 stations	
:	:	
16	16 stations	

A, B port size

C4	ø4 One-touch fitting
N3	ø5/32" One-touch fitting

A, B port size

M5	M5 x 0.8
----	----------

A, B port size

01	1/8
----	-----

CE-compliant

Nil	—
Q	CE-compliant

P, R, A, B port thread type

Nil	Rc
F	G
N	NPT
T	NPTF

SI unit part no.

Symbol	SI unit specifications	SI unit part no.	Page
Nil	NPN output (+ COM.)	EX510-S001	WEB catalog
N	PNP output (- COM.)	EX510-S101	

Refer to the **WEB catalog** and the Operation Manual for the details of the EX510 Gateway-type Serial Transmission System. Please download the Operation Manual via our website, <http://www.smcworld.com>

Clean series

Actuation type

1	2 position single
2	2 position double
3	3 position closed center
4	3 position exhaust center
5	3 position pressure center

Coil type

Nil	Standard
T	With power saving circuit

Rated voltage: 24 VDC

Light/Surge voltage suppressor

Z	With light/surge voltage suppressor
U	With light/surge voltage suppressor (Non-polar type)

* Power saving circuit is only available for the "Z" type.

Manual override

Nil	Non-locking push type
D	Push-turn locking slotted type
E	Push-turn locking lever type

CE-compliant

Nil	—
Q	CE-compliant

How to Order Valve

10-SYJ5 **1** **43** - **5LO** **Z** - []

Clean series

Actuation type

1	2 position single
2	2 position double
3	3 position closed center
4	3 position exhaust center
5	3 position pressure center

Coil type

Nil	Standard
T	With power saving circuit

Rated voltage: 24 VDC

Light/Surge voltage suppressor

Z	With light/surge voltage suppressor
U	With light/surge voltage suppressor (Non-polar type)

* Power saving circuit is only available for the "Z" type.

Manual override

Nil	Non-locking push type
D	Push-turn locking slotted type
E	Push-turn locking lever type

CE-compliant

Nil	—
Q	CE-compliant

How to Order Manifold Assembly (Example)

Example

10-SS5YJ5-41SA-05-M5 (-Q) ... 1 set (Type 41SA, 5-station manifold part no.)
*** 10-SYJ5143-5LOU (-Q) 3 sets (Single solenoid part no.)**
*** 10-SYJ5243-5LOU (-Q) 2 sets (Double solenoid part no.)**

The asterisk denotes the symbol for assembly. Prefix it to the part no. of the solenoid valve, etc.

Add the valve and option part number under the manifold base part number. When entry of part numbers becomes complicated, indicate by the manifold specification sheet. For a EX510 manifold, the length of the lead wire for a connector assembly depends on the number of stations. Therefore, the manifold assembly is shipped with the valves (including blanking plates) and connector assembly mounted on it, as the standard specification. Be sure to specify the part no. of the solenoid valves to be mounted.

Directional Control Valves

Air Cylinders

Rotary Actuators

Air Grippers

Air Preparation Equipment

Modular F. R.

Pressure Control Equipment

Fittings & Tubing

Flow Control Equipment

Pressure Switches/ Pressure Sensors



Note) AC-type models that are CE-compliant have DIN terminals only.

[Option]

Individual Wiring

Common SUP/Common EXH

Note) For more than 8 stations, supply pressure to P port on both sides and exhaust from R port on both sides.

Type 20 (5 port/Body ported)

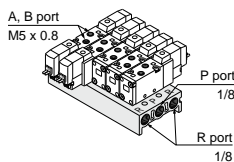

How to Order

10-SS5YJ5-20-05 - [] - []

Clean series

Number of stations

02	2 stations
:	:
20	20 stations

P, R port thread type

Nil	Rc
00F	G
00N	NPT
00T	NPTF

CE-compliant

Nil	—
Q	CE-compliant

Applicable solenoid valve

10-SYJ5□23-□□□□-M5^{N3}(-Q)
C6^{N7}

Applicable blanking plate assembly

Refer to page 329.

Applicable individual EXH spacer assembly

Refer to page 330.

Type 40 (5 port/Base mounted)

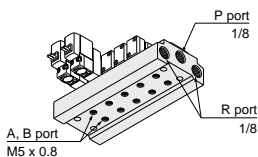

How to Order

10-SS5YJ5-40-05-M5 - [] - []

Clean series

Stations

02	2 stations
:	:
20	20 stations

A, B port size

M5	M5 x 0.8
----	----------

P, R port thread type

Nil	Rc
F	G
N	NPT
T	NPTF

CE-compliant

Nil	—
Q	CE-compliant

Applicable solenoid valve

10-SYJ5□43-□□□□(-Q)

Applicable blanking plate assembly

Refer to page 329.

Applicable individual EXH spacer assembly

Refer to page 330.

Type 41 (5 port/Base mounted)

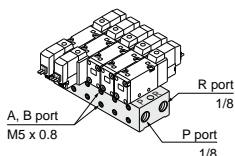

How to Order

10-SS5YJ5-41-05-M5 - [] - []

Clean series

Stations

02	2 stations
:	:
20	20 stations

A, B port size

M5	M5 x 0.8
----	----------

P, R port thread type

Nil	Rc
F	G
N	NPT
T	NPTF

CE-compliant

Nil	—
Q	CE-compliant

Type 42 (5 port/Base mounted)

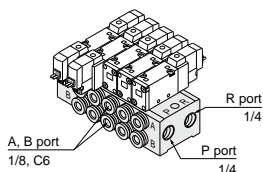

How to Order

10-SS5YJ5-42-05-C6 - [] - []

Clean series

Stations

02	2 stations
:	:
20	20 stations

A, B port size

01	1/8
C6	ø6 One-touch fitting
N7	ø1/4 One-touch fitting

Thread type

Nil	Rc
F	G
N	NPT
T	NPTF

CE-compliant

Nil	—
Q	CE-compliant

Applicable solenoid valve

10-SYJ5□43-□□□□(-Q)

Applicable blanking plate assembly

Refer to page 329.

Applicable individual EXH spacer assembly

Refer to page 330.

Applicable individual SUP spacer assembly

Refer to page 330.

Type 43 (5 port/Base mounted)

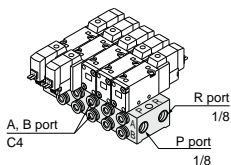

How to Order

10-SS5YJ5-43-05-C4 - [] - []

Clean series

Stations

02	2 stations
:	:
20	20 stations

A, B port size

C4	ø4 One-touch fitting
N3	ø5/32 One-touch fitting

P, R port thread type

Nil	Rc
F	G
N	NPT
T	NPTF

CE-compliant

Nil	—
Q	CE-compliant



Note) CE-compliant: For DC only. [Option]

Flat Ribbon Cable Manifold

Common SUP/Common EXH

Note) For more than 8 stations, supply pressure to P port on both sides and exhaust from R port on both sides.

Type 20P (5 port/Body ported)

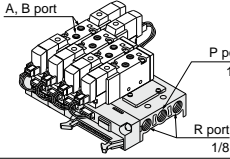

How to Order

Clean series

Number of stations

03	3 stations
:	:
12	12 stations

P, R port thread type

Nil	Rc
00F	G
00N	NPT
00T	NPTF

CE-compliant

Nil	—
Q	CE-compliant

Applicable solenoid valve
Refer to page 323.

Applicable blanking plate assembly
Refer to page 329.

Applicable connector assembly
Refer to page 323.

Type 41P (5 port/Base mounted)

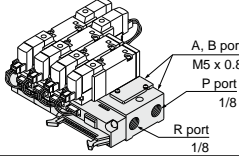

How to Order

Clean series

Number of stations

03	3 stations
:	:
12	12 stations

P, R port thread type

Nil	Rc
F	G
N	NPT
T	NPTF

CE-compliant

Nil	—
Q	CE-compliant

Applicable solenoid valve
Refer to page 323.

Applicable blanking plate assembly
Refer to page 329.

Applicable connector assembly
Refer to page 323.

Type 43P (5 port/Base mounted)

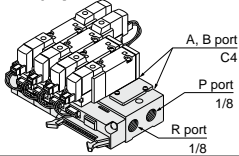

How to Order

Clean series

Number of stations

03	3 stations
:	:
12	12 stations

P, R port thread type

Nil	Rc
F	G
N	NPT
T	NPTF

A, B port size

C4	ø4 One-touch fitting
N3	ø5/32" One-touch fitting

CE-compliant

Nil	—
Q	CE-compliant

EX510 Gateway-type Serial Transmission System



[Option]

Type 20SA (5 port/Body ported)

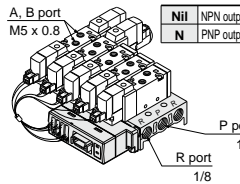

How to Order

Clean series

SI unit

Nil	NPN output (+COM.)
N	PNP output (-COM.)

Valve stations

Symbol	Stations	Note
03	3 stations	Double wiring (Note 1)
:	:	
08	8 stations	Specified layout (Note 2) (Up to 16 solenoids)
03	3 stations	
16	16 stations	

P, R port thread type

Nil	Rc
00F	G
00N	NPT
00T	NPTF

CE-compliant

Nil	—
Q	CE-compliant

Note 1) Double wiring: Use of a single solenoid will result in an unused control signal. If this is not desired, order with a specified layout.
Note 2) Specified layout: Indicate wiring specifications on the manifold specification sheet. (Note that double and 3 position valves cannot be used where single solenoid wiring has been specified.)

Applicable solenoid valve
Refer to page 325.

Applicable blanking plate assembly
Refer to page 329.

Type 41SA (5 port/Base mounted)

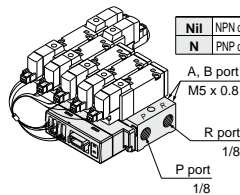

How to Order

Clean series

SI unit

Nil	NPN output (+COM.)
N	PNP output (-COM.)

Valve stations

Symbol	Stations	Note
03	3 stations	Double wiring (Note 1)
:	:	
08	8 stations	Specified layout (Note 2) (Up to 16 solenoids)
03	3 stations	
16	16 stations	

A, B port size

M5	M5 x 0.8
----	----------

CE-compliant

Nil	—
Q	CE-compliant

Note 1) Double wiring: Use of a single solenoid will result in an unused control signal. If this is not desired, order with a specified layout.
Note 2) Specified layout: Indicate wiring specifications on the manifold specification sheet. (Note that double and 3 position valves cannot be used where single solenoid wiring has been specified.)

Applicable solenoid valve
Refer to page 326.

Applicable blanking plate assembly
Refer to page 329.

Type 42SA (5 port/Base mounted)

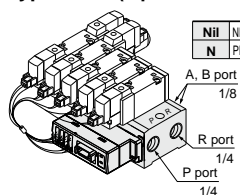

How to Order

Clean series

SI unit

Nil	NPN output (+COM.)
N	PNP output (-COM.)

Valve stations

Symbol	Stations	Note
03	3 stations	Double wiring (Note 1)
:	:	
08	8 stations	Specified layout (Note 2) (Up to 16 solenoids)
03	3 stations	
16	16 stations	

P, R port thread type

Nil	Rc
F	G
N	NPT
T	NPTF

A, B port size

01	1/8
----	-----

CE-compliant

Nil	—
Q	CE-compliant

Note 1) Double wiring: Use of a single solenoid will result in an unused control signal. If this is not desired, order with a specified layout.
Note 2) Specified layout: Indicate wiring specifications on the manifold specification sheet. (Note that double and 3 position valves cannot be used where single solenoid wiring has been specified.)

Applicable solenoid valve
Refer to page 326.

Applicable blanking plate assembly
Refer to page 329.

Directional Control Valves
Air Cylinders
Rotary Actuators
Air Grippers
Air Preparation Equipment
Modular F. R.
Pressure Control Equipment
Fittings & Tubing
Flow Control Equipment
Pressure Switches/Pressure Sensors

EX510 Gateway-type Serial Transmission System

Type 43SA (5 port/Base mounted) How to Order

10-SS5YJ5-43SA [] - **03** - **C4** [] - []

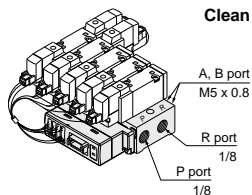

Clean series ↓

SI unit	
Nil	NPN output (+ COM.)
N	PNP output (- COM.)

Valve stations		
Symbol	Station	Note
03	3 stations	Double wiring ^{Note 1)}
:	:	:
08	8 stations	
03	3 stations	Specified layout ^{Note 2)}
:	:	(Up to 16 solenoids)
16	16 stations	

P, R, A, B port thread type	
Nil	Rc
F	G
N	NPT
T	NPTF

A, B port size	
C4	ø4 One-touch fitting
N3	ø5/32" One-touch fitting

Applicable solenoid valve
Refer to page 326.

Applicable blanking plate assembly
Refer to "Blanking Plate Assembly" below.

CE-compliant	
Nil	—
Q	CE-compliant

· Includes the number of the blanking plate assemblies.
 Note 1) Double wiring: Use of a single solenoid will result in an unused control signal. If this is not desired, order with a specified layout.
 Note 2) Specified layout: Indicate wiring specifications on the manifold specification sheet. (Note that double and 3 position valves cannot be used where single solenoid wiring has been specified.)

Combinations of Solenoid Valve, Manifold Gasket and Manifold Base

<Standard>

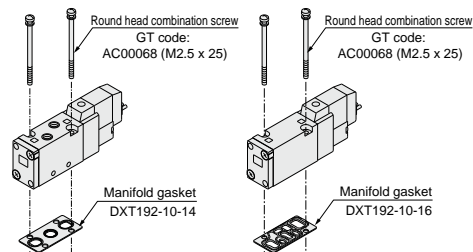

Applicable manifold base
 · Type 10-SS5YJ5-20
 · Type 10-SS5YJ5-20P
 · Type 10-SS5YJ5-20SA

Applicable manifold base
 Sub-plate · Type 10-SS5YJ5-41P
 · Type 10-SS5YJ5-40 · Type 10-SS5YJ5-43P
 · Type 10-SS5YJ5-41 · Type 10-SS5YJ5-41SA
 · Type 10-SS5YJ5-42 · Type 10-SS5YJ5-42SA
 · Type 10-SS5YJ5-43 · Type 10-SS5YJ5-43SA

<CE-compliant>

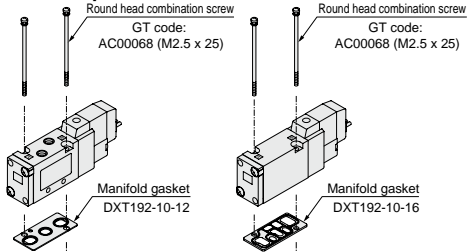

Applicable manifold base
 · Type 10-SS5YJ5-20-Q
 · Type 10-SS5YJ5-20P-Q
 · Type 10-SS5YJ5-20SA-Q

Applicable manifold base
 Sub-plate · Type 10-SS5YJ5-41P-Q
 · Type 10-SS5YJ5-40-Q · Type 10-SS5YJ5-43P-Q
 · Type 10-SS5YJ5-41-Q · Type 10-SS5YJ5-41SA-Q
 · Type 10-SS5YJ5-42-Q · Type 10-SS5YJ5-42SA-Q
 · Type 10-SS5YJ5-43-Q · Type 10-SS5YJ5-43SA-Q

Blanking Plate Assembly

SYJ5000-21-5A

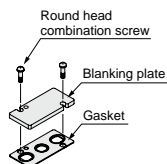

Applicable manifold base
 · 10-SS5YJ5-20(-Q)
 · 10-SS5YJ5-20SA(-Q)

SYJ5000-21-6A

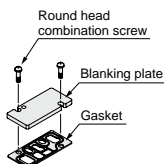

Applicable manifold base
 · 10-SS5YJ5-40(-Q)
 · 10-SS5YJ5-41(-Q)
 · 10-SS5YJ5-42(-Q)
 · 10-SS5YJ5-43(-Q)
 · 10-SS5YJ5-41SA(-Q)
 · 10-SS5YJ5-42SA(-Q)
 · 10-SS5YJ5-43SA(-Q)

SYJ5000-21-7A

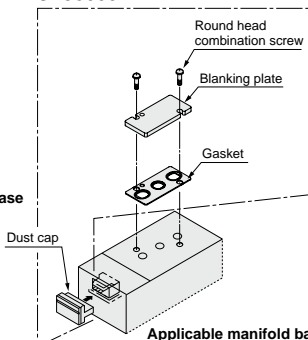

SYJ5000-21-8A

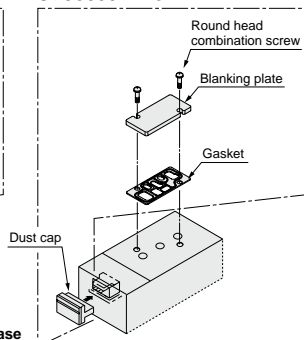

Caution

Mounting screw tightening torque
M2.5: 0.45 N·m

Use caution to the assembly orientation for solenoid valves, gasket, and optional parts.

Mix Installation of the 10-SYJ500 and the 10-SYJ5000 Valves on the Same Manifold

- Use of an adapter plate makes it possible to mount the 10-SYJ500 on the 10-SYJ5000 manifold bases.
- When mounting the SYJ500 valve on the 10-SYJ5000 manifold, the SYJ500 pilot valve must be positioned on the same side of the manifold as a SYJ5000 single solenoid. (Refer to the figure below.)
- For base mounted type, the A port of the 3 port valve flows out the B port of the manifold base.

Adapter Plate Assembly

<Standard>

SYJ500-3-2A

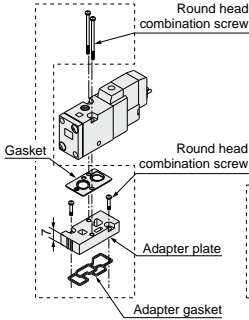

Applicable manifold base

- Type 10-SS5YJ5-20
- Type 10-SS5YJ5-20P

SYJ500-3-1A

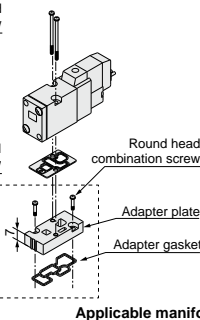

Applicable manifold base

- Type 10-SS5YJ5-40
- Type 10-SS5YJ5-41
- Type 10-SS5YJ5-42
- Type 10-SS5YJ5-43
- Type 10-SS5YJ5-41P
- Type 10-SS5YJ5-42P
- Type 10-SS5YJ5-43P

<CE-compliant>

SYJ500-3-1A-1-Q

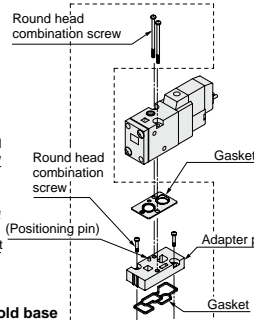

Applicable manifold base

- Type 10-SS5YJ5-20-Q
- Type 10-SS5YJ5-20P-Q

SYJ500-3-1A-2-Q

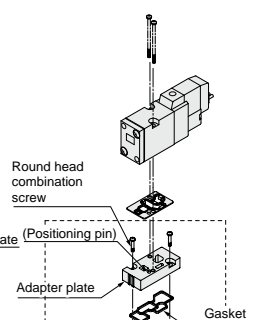

Applicable manifold base

- Type 10-SS5YJ5-40-Q
- Type 10-SS5YJ5-41-Q
- Type 10-SS5YJ5-42-Q
- Type 10-SS5YJ5-43-Q
- Type 10-SS5YJ5-41P-Q
- Type 10-SS5YJ5-43P-Q

Individual EXH Spacer Assembly

SYJ5000-17-3A

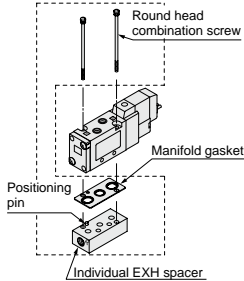

Applicable manifold base

- 10-SS5YJ5-20(-Q)
- 10-SS5YJ5-20P(-Q)

SYJ5000-17-4A

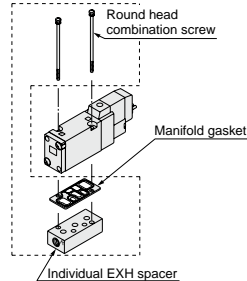

Applicable manifold base

- 10-SS5YJ5-40(-Q)
- 10-SS5YJ5-41(-Q)
- 10-SS5YJ5-42(-Q)
- 10-SS5YJ5-43(-Q)
- 10-SS5YJ5-41P(-Q)
- 10-SS5YJ5-43P(-Q)

Individual SUP Spacer Assembly

SYJ5000-16-2 A(-Q)

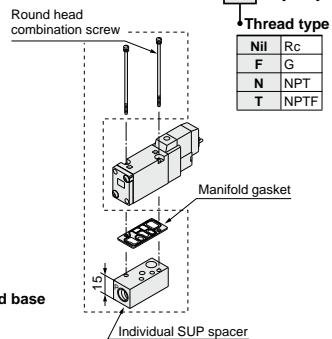

Applicable manifold base

- Type 10-SS5YJ5-41(-Q)
- Type 10-SS5YJ5-42(-Q)
- Type 10-SS5YJ5-43(-Q)
- Type 10-SS5YJ5-41P(-Q)
- Type 10-SS5YJ5-43P(-Q)

⚠ Caution

Mounting screw tightening torque

M2.5: 0.45 N·m

Use caution to the assembly orientation for solenoid valves, gasket, and optional parts.

Type 20: Top Ported/10-SS5YJ5-20- Stations -00□

* [] : AC

Grommet (G)

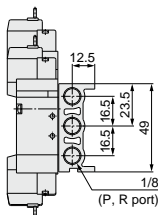
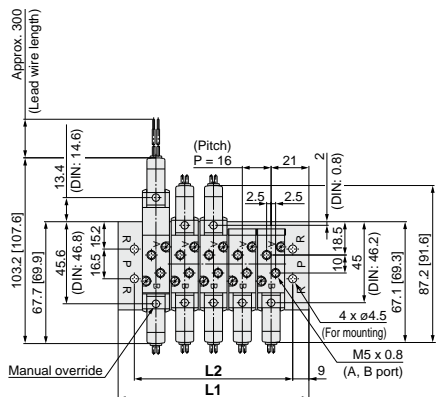

For C4, N3, C6, N7 (Built-in One-touch fitting)

(Station n) - - - - - (Station 1)

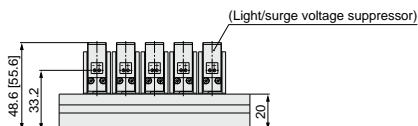

One-touch fitting (A, B port)
Applicable tubing O.D.:
 $\phi 4, \phi 5/32, \phi 6, \phi 1/4"$

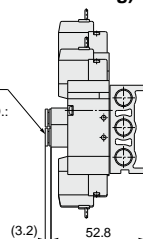

L plug connector (L)

M plug connector (M)

DIN terminal (D, Y)

M8 connector (WO)

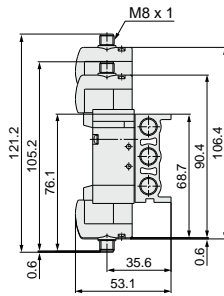
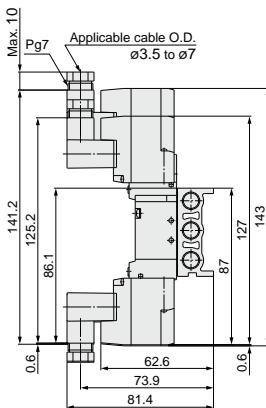
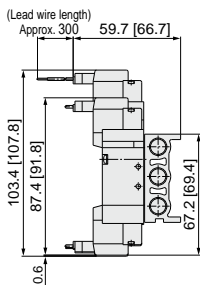
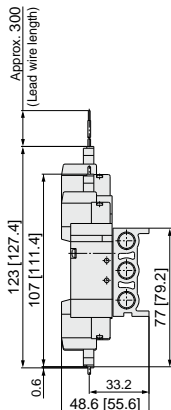

* Refer to page 375 for dimensions with connector cable.

Station	Station 2	3	4	5	6	7	8	9	10	11	12	13	14	15	16	17	18	19	Station 20
L1	58	74	90	106	122	138	154	170	186	202	218	234	250	266	282	298	314	330	346
L2	40	56	72	88	104	120	136	152	168	184	200	216	232	248	264	280	296	312	328

Type 40: Bottom Ported/10-SS5YJ5-40-Stations-M5

* [] : AC

Grommet (G)

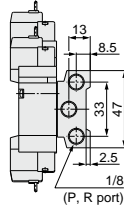
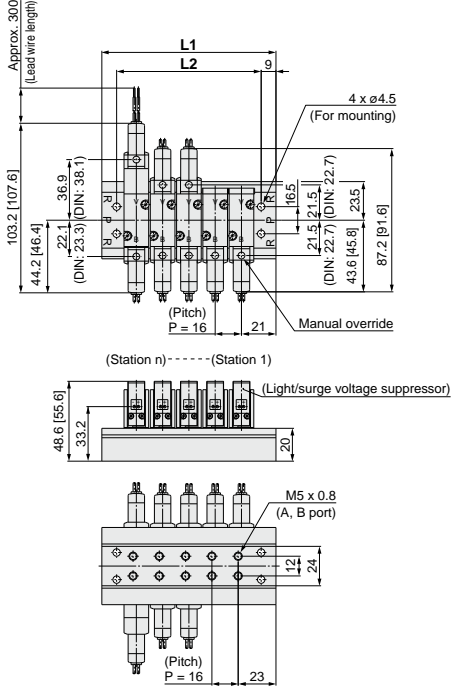

Built-in throttle valve

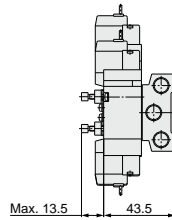

L plug connector (L)

M plug connector (M)

DIN terminal (D, Y)

M8 connector (WO)

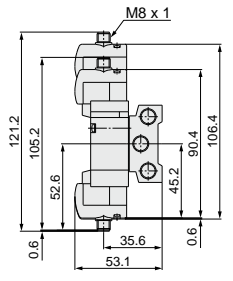
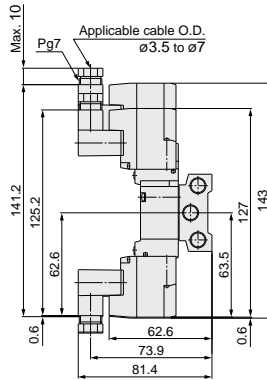
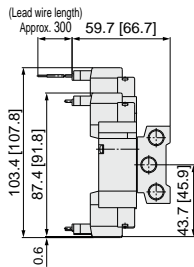
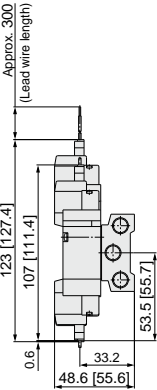

* Refer to page 375 for dimensions with connector cable.

Station	Station 2	3	4	5	6	7	8	9	10	11	12	13	14	15	16	17	18	19	Station 20
L1	58	74	90	106	122	138	154	170	186	202	218	234	250	266	282	298	314	330	346
L2	40	56	72	88	104	120	136	152	168	184	200	216	232	248	264	280	296	312	328

Directional Control Valves

Air Cylinders

Rotary Actuators

Air Grippers

Air Preparation Equipment

Modular F. R.

Pressure Control Equipment

Fittings & Tubing

Flow Control Equipment

Pressure Switches/ Pressure Sensors

Type 41: Side Ported/10-SS5YJ5-41- Stations -M5

* []: AC

Grommet (G)

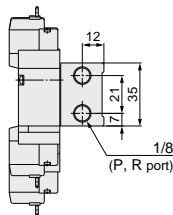
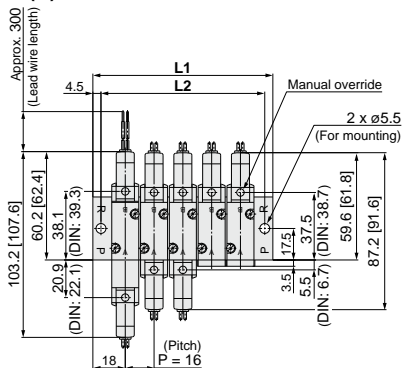

(Station 1)----- (Station n)

Built-in throttle valve

(Light/surge voltage suppressor)

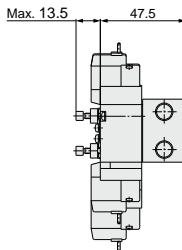
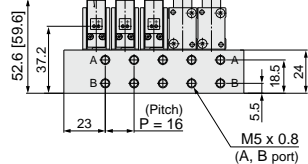

L plug connector (L)

M plug connector (M)

DIN terminal (D, Y)

M8 connector (WO)

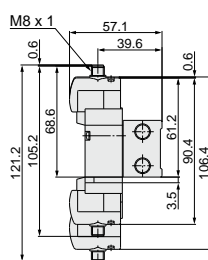
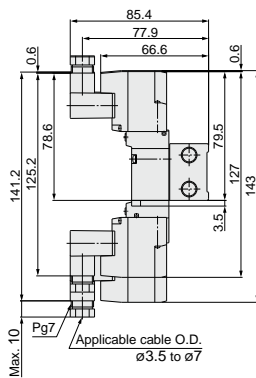
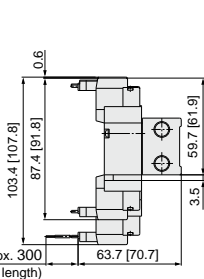
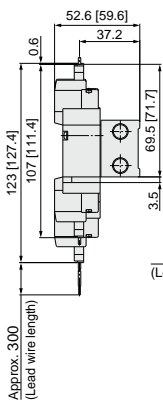

* Refer to page 375 for dimensions with connector cable.

Station	Station 2	3	4	5	6	7	8	9	10	11	12	13	14	15	16	17	18	19	Station 20
L1	52	68	84	100	116	132	148	164	180	196	212	228	244	260	276	292	308	324	340
L2	43	59	75	91	107	123	139	155	171	187	203	219	235	251	267	283	299	315	331

Type 42: Side Ported/10-SS5YJ5-42-Stations-01, C6 N7 □

* [] : AC

**Grommet (G)
For 01 □**

For C6 □ (Built-in One-touch fitting)

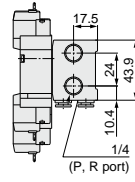
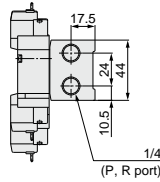
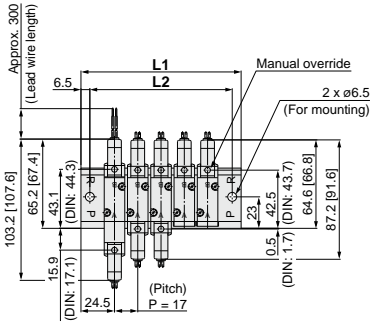

(Station 1) ---- (Station n)

(Light/surge voltage suppressor)

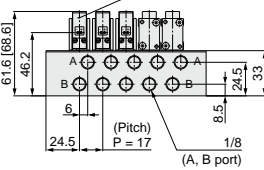

Built-in throttle valve

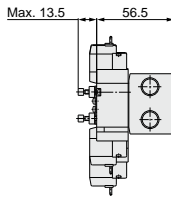

(Station 1) ---- (Station n)
(Light/surge voltage suppressor)

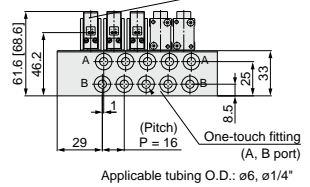

Applicable tubing O.D.: ø6, ø1/4"

* Other dimensions are the same as the grommet type.

L plug connector (L)

M plug connector (M)

DIN terminal (D, Y)

M8 connector (WO)

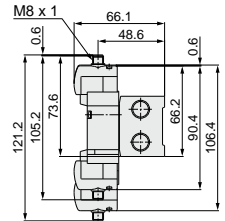
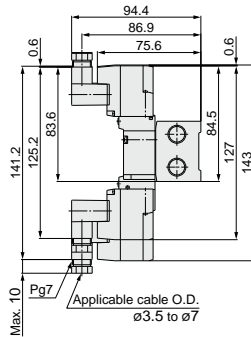
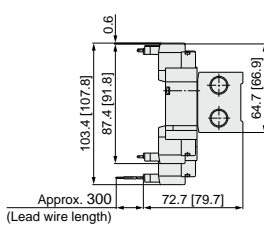
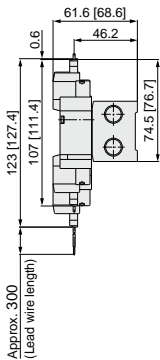

* Refer to page 375 for dimensions with connector cable.

A, B port size	Station	Station 2	3	4	5	6	7	8	9	10	11	12	13	14	15	16	17	18	19	Station 20
For 1/8	L1	66	83	100	117	134	151	168	185	202	219	236	253	270	287	304	321	338	355	372
	L2	53	70	87	104	121	138	155	172	189	206	223	240	257	274	291	308	325	342	359
For C6/N7	L1	65	81	97	113	129	145	161	177	193	209	225	241	257	273	289	305	321	337	353
	L2	52	68	84	100	116	132	148	164	180	196	212	228	244	260	276	292	308	324	340

Directional Control Valves
Air Cylinders
Rotary Actuators
Air Grippers
Air Preparation Equipment
Modular F. R.
Pressure Control Equipment
Fittings & Tubing
Flow Control Equipment
Pressure Switches/ Pressure Sensors

Type 43: Side Ported/10-SS5YJ3-43-Stations - C4
N3

* []: AC

Grommet (G)

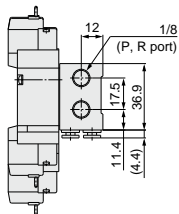
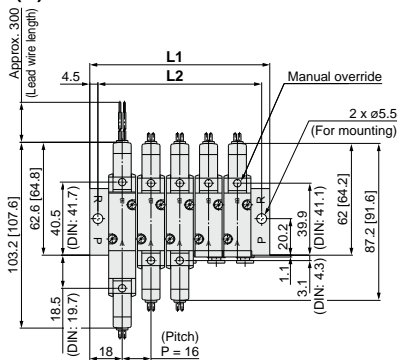

Built-in throttle valve

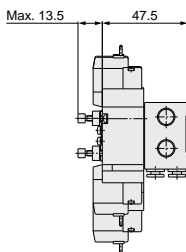
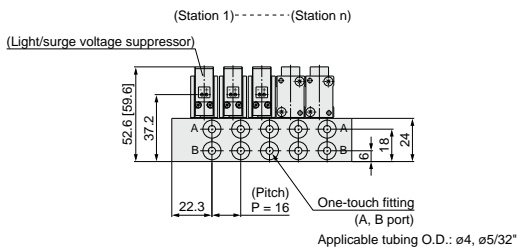

L plug connector (L)

M plug connector (M)

DIN terminal (D, Y)

M8 connector (WO)

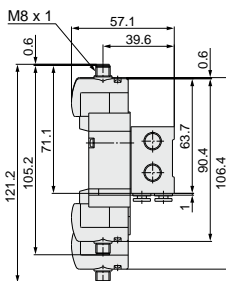
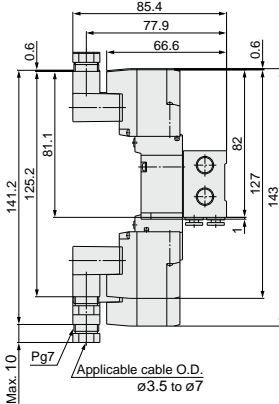
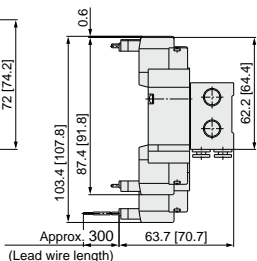
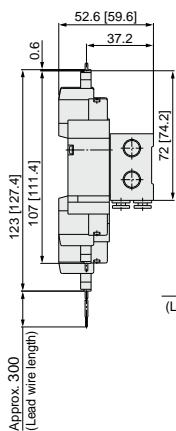

* Refer to page 375 for dimensions with connector cable.

Station	Station 2	3	4	5	6	7	8	9	10	11	12	13	14	15	16	17	18	19	Station 20
L1	52	68	84	100	116	132	148	164	180	196	212	228	244	260	276	292	308	324	340
L2	43	59	75	91	107	123	139	155	171	187	203	219	235	251	267	283	299	315	331

Flat Ribbon Cable Manifold

* []: AC

10-SS5YJ5-43P- Stations - C4 N3

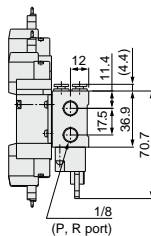
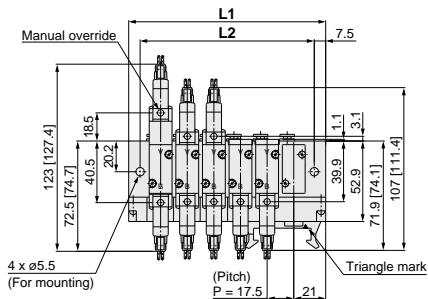
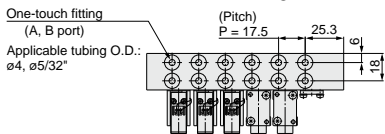

Built-in throttle valve

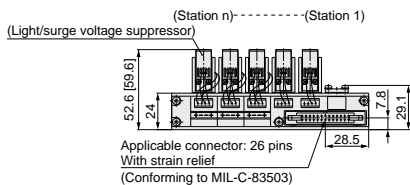
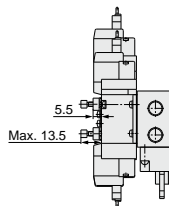

Station	Station 3	4	5	6	7	8	9	10	11	Station 12
L1	77	94.5	112	129.5	147	164.5	182	199.5	217	234.5
L2	62	79.5	97	114.5	132	149.5	167	184.5	202	219.5

EX510 Gateway-type Serial Transmission System

10-SS5YJ5-20SA □ - Stations □ - □

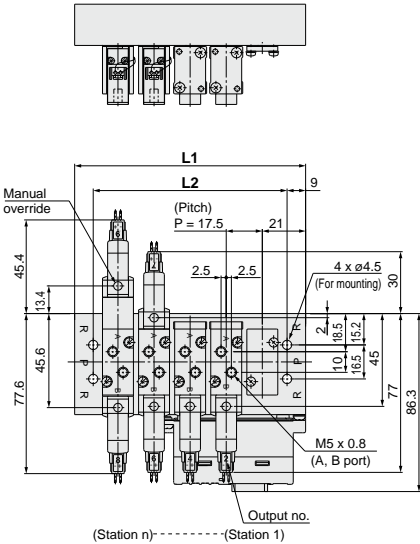

For C4, N3
C6, N7 (Built-in One-touch fitting)

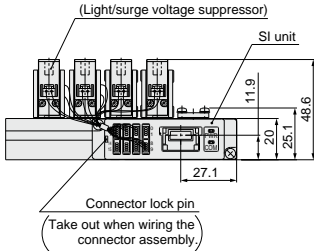
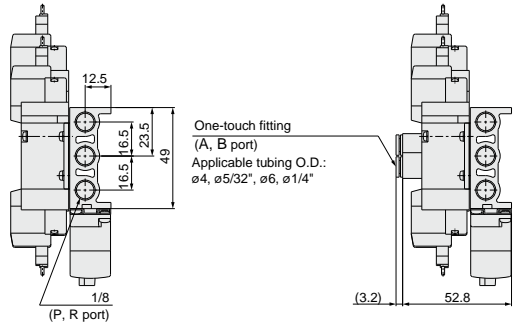

Station	Station 3	4	5	6	7	8	9	10	11	12	13	14	15	Station 16
L1	77	94.5	112	129.5	147	164.5	182	199.5	217	234.5	252	269.5	287	304.5
L2	59	76.5	94	111.5	129	146.5	164	181.5	199	216.5	234	251.5	269	286.5

Directional Control Valves

Air Cylinders

Rotary Actuators

Air Grippers

Air Preparation Equipment

Modular F. R.

Pressure Control Equipment

Fittings & Tubing

Flow Control Equipment

Pressure Switches/ Pressure Sensors

EX510 Gateway-type Serial Transmission System

10-SS5YJ5-41SA□ - Stations -M5□

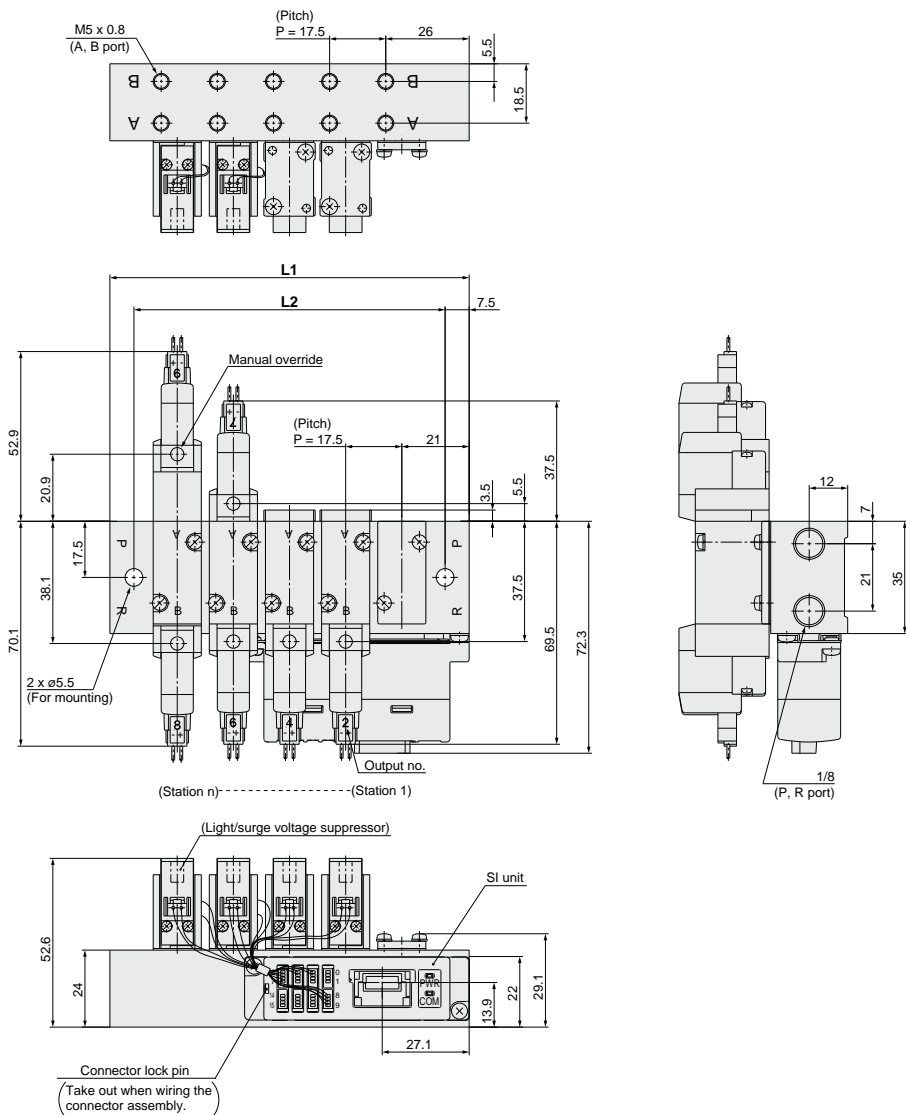

Station	Station 3	4	5	6	7	8	9	10	11	12	13	14	15	Station 16
L1	77	94.5	112	129.5	147	164.5	182	199.5	217	234.5	252	269.5	287	304.5
L2	62	79.5	97	114.5	132	149.5	167	184.5	202	219.5	237	254.5	272	289.5

EX510 Gateway-type Serial Transmission System

10-SS5YJ-42SA□-Stations-01□

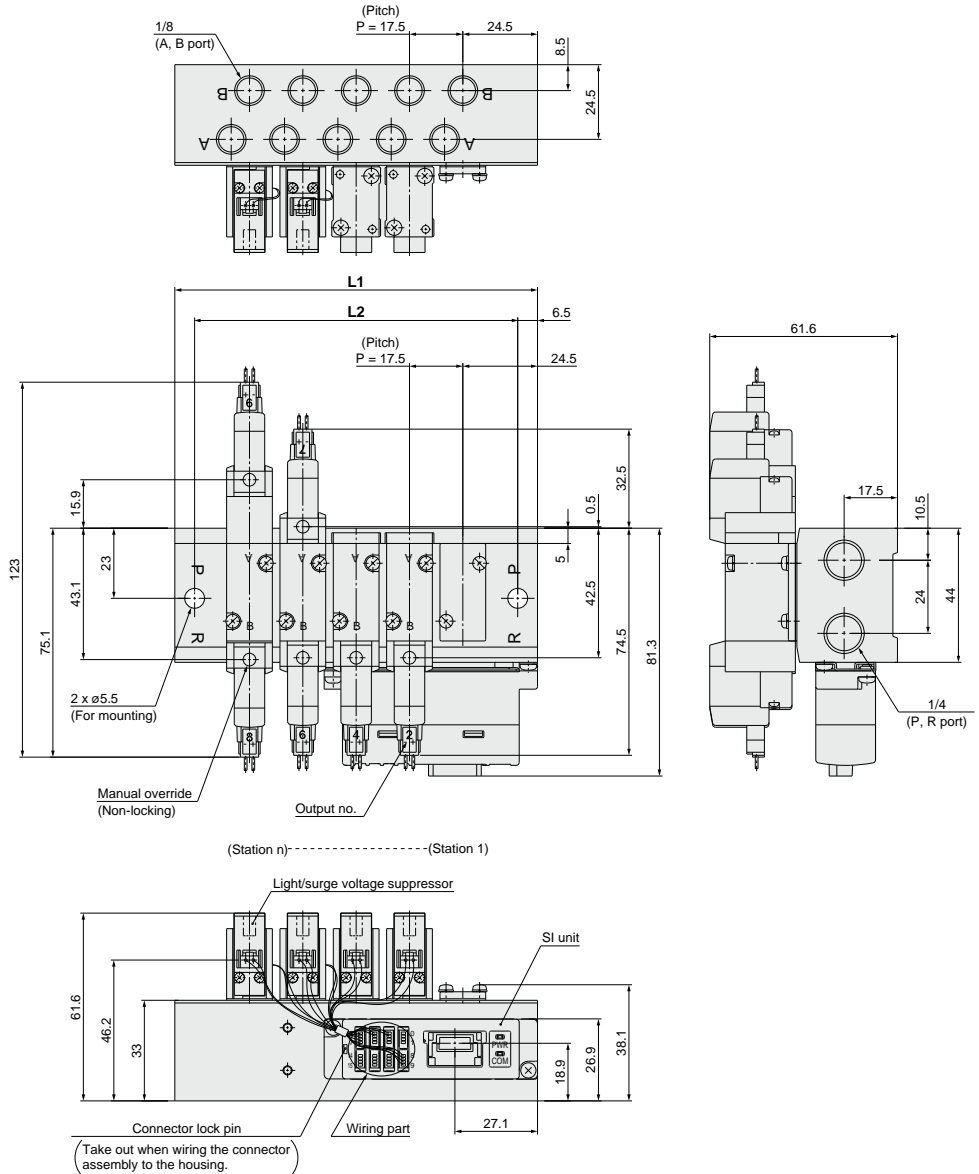

Station	Station 4	5	6	7	8	9	10	11	12	13	14	15	Station 16
L1	101.5	119	136.5	154	171.5	189	206.5	224	241.5	259	276.5	294	311.5
L2	88.5	106	123.5	141	158.5	176	193.5	211	228.5	246	263.5	281	298.5

Directional Control Valves

Air Cylinders

Rotary Actuators

Air Grippers

Air Preparation Equipment

Modular F. R.

Pressure Control Equipment

Fittings & Tubing

Flow Control Equipment

Pressure Switches/ Pressure Sensors

EX510 Gateway-type Serial Transmission System

**10-SS5YJ5-43SA□ - Stations - C4□
N3□**

One-touch fitting
(A, B port)
Applicable tubing O.D.: $\phi 4, \phi 5/32''$

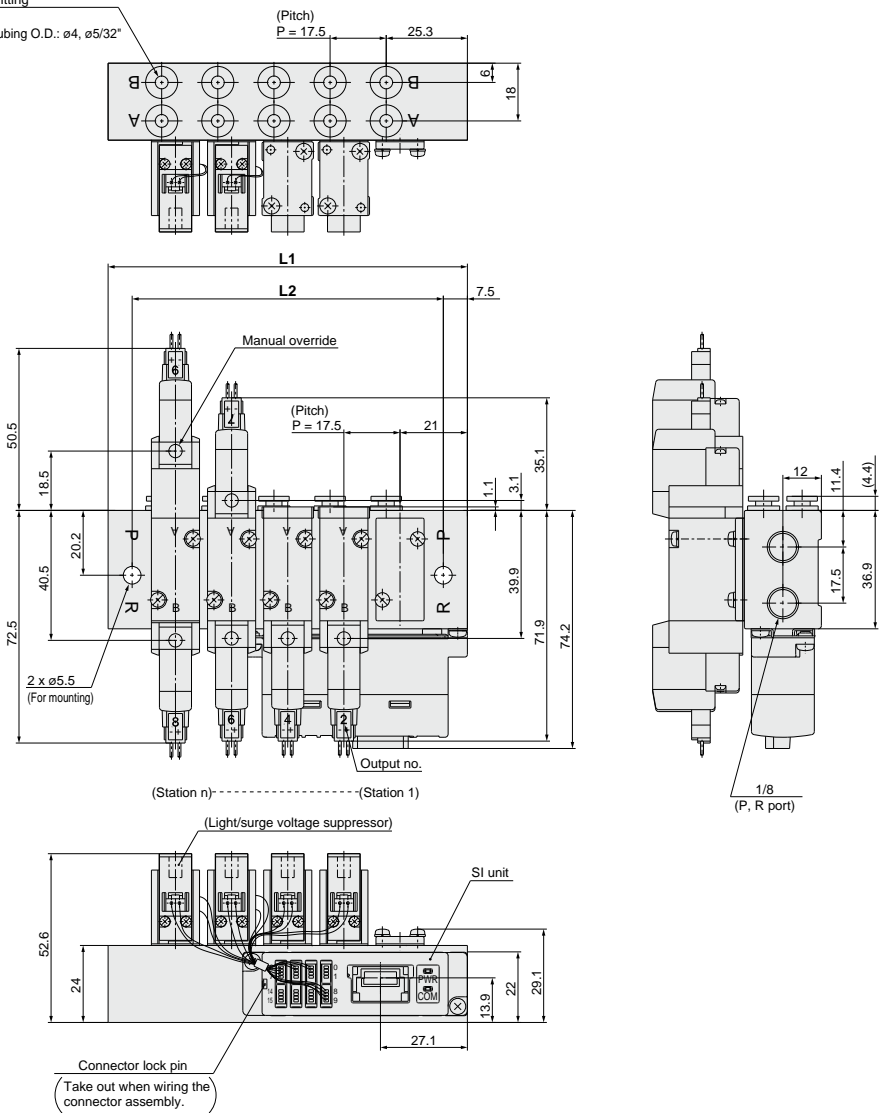

Station	Station 3	4	5	6	7	8	9	10	11	12	13	14	15	Station 16
L1	77	94.5	112	129.5	147	164.5	182	199.5	217	234.5	252	269.5	287	304.5
L2	62	79.5	97	114.5	132	149.5	167	184.5	202	219.5	237	254.5	272	289.5

Series 10-SYJ7000 Rubber Seal 5 Port Solenoid Valve

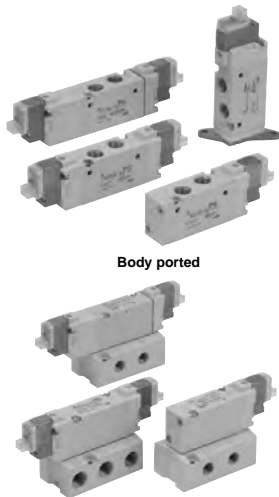

Body ported

Base mounted

Symbol

Body ported

2 position single

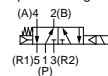

2 position double

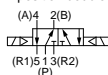

3 position closed center

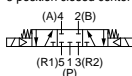

3 position exhaust center



3 position pressure center

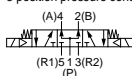

Base mounted

2 position single solenoid

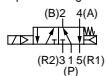

2 position double solenoid

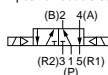

3 position closed center

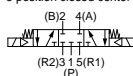

3 position exhaust center

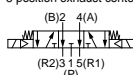

3 position pressure center

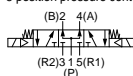

Specifications

Fluid		Air
Operating pressure range (MPa)	2 position single	0.15 to 0.7
	2 position double	0.1 to 0.7
	3 position	0.15 to 0.7
Ambient and fluid temperature (°C)		-10 to 50 (No freezing)
Response time (ms) ^{Note 1)} (at 0.5 MPa)	2 position single, double	30 or less
	3 position	60 or less
Max. operating frequency (Hz)	2 position single, double	5
	3 position	3
Manual override (Manual operation)	Non-locking push type, Push-turn locking slotted type, Push-turn locking lever type	
Pilot exhaust method	Main/Pilot valve common exhaust	
Lubrication	Not required	
Mounting orientation	Unrestricted	
Impact/Vibration resistance (m/s ²) ^{Note 2)}	150/30	
Enclosure	Dust proof (* M8 connector conforms to IP65.)	

* Based on IEC60529

Note 1) Based on dynamic performance test, JIS B 8375-1981. (Coil temperature: 20°C, at rated voltage, without surge suppressor)

Note 2) Impact resistance: No malfunction occurred when it was tested in the axial direction and at right angles to the main valve and armature in both energized and de-energized states once for each condition. (Default settings)

Vibration resistance: No malfunction occurred in a one-sweep test between 45 and 2000 Hz. Test was performed in both energized and de-energized states in the axial direction and at right angles to the main valve and armature. (Default settings)

Solenoid Specifications

Electrical entry	Grommet (G), (H) L plug connector (L) M plug connector (M) DIN terminal (D), (Y) M8 connector (W)		
	G, H, L, M, W		D, Y
Coil rated voltage (V)	DC	24, 12, 6, 5, 3	
	AC 50/60 Hz	100, 110, 200, 220	
Allowable voltage fluctuation	±10% of rated voltage *		
Power consumption (W)	DC	Standard	0.35 (With light: 0.4 (DIN terminal with light: 0.45))
		With power saving circuit	0.1 (With light only) * [Starting 0.4, Holding 0.1]
Apparent power (VA) *	AC	100 V	0.78 (With light: 0.81) 0.78 (With light: 0.87)
		110 V	0.86 (With light: 0.89) 0.86 (With light: 0.97)
		[115 V]	[0.94 (With light: 0.97)] [0.94 (With light: 1.07)]
		200 V	1.18 (With light: 1.22) 1.15 (With light: 1.30)
		220 V [230 V]	1.30 (With light: 1.34) 1.27 (With light: 1.46) [1.42 (With light: 1.46)] [1.39 (With light: 1.60)]
Surge voltage suppressor	Diode (DIN terminal, Varistor when non-polar types)		
Indicator light	LED (Neon light when AC with DIN terminal)		

* Common between 110 VAC and 115 VAC, and between 220 VAC and 230 VAC.

* For 115 VAC and 230 VAC, the allowable voltage is -15% to +5% of rated voltage.

* For details, refer to page 372.



Made to Order
(For details, refer to page 369.)

Directional Control Valves

Air Cylinders

Rotary Actuators

Air Grippers

Air Preparation Equipment

Modular F. R.

Pressure Control Equipment

Fittings & Tubing

Flow Control Equipment

Pressure Switches/ Pressure Sensors

Flow Rate Characteristics/Weight

Valve model	Actuation type	Port size		Flow rate characteristics ^{Note 1)}						Weight (g) ^{Note 2, 3)}					
		1, 5, 3 (P, EA, EB)	4, 2 (A, B)	1 → 4/2 (P → A/B)			4/2 → 5/3 (A/B → EA/EB)			Grommet	L/M plug connector	DIN terminal	M8 connector		
		C [dm ³ /(s·bar)]	b	Cv	C [dm ³ /(s·bar)]	b	Cv								
Body ported	10-SYJ7□23-□-01	2 position	Single	1/8	1/8	2.2	0.36	0.58	2.4	0.34	0.63	108	110	152	118
			Double			1.8	0.37	0.45	2.0	0.35	0.49				
		3 position	Closed center			1.2	0.50	0.34	3.0 [1.3]	0.35 [0.52]	0.73 [0.39]				
			Exhaust center			3.0 [0.83]	0.37 [0.50]	0.78 [0.25]	1.8	0.37	0.45				
			Pressure center			1.6	0.33	0.4	2.2	0.32	0.53				
						1.4	0.27	0.35	1.9	0.33	0.49				
	10-SYJ7□23-□-C6	2 position	Single	1/8	C6 (ø6 One-touch fitting)	1.1	0.37	0.27	2.5 [1.3]	0.32 [0.54]	0.61 [0.38]	119	121	163	129
			Double			1.8 [0.78]	0.36 [0.40]	0.45 [0.22]	1.6	0.30	0.39				
		3 position	Closed center			2.0	0.39	0.52	2.3	0.34	0.61				
			Exhaust center			1.7	0.35	0.42	2.0	0.29	0.49				
			Pressure center			1.2	0.38	0.33	2.6 [1.3]	0.35 [0.49]	0.67 [0.38]				
						1.9 [0.86]	0.57 [0.46]	0.59 [0.25]	1.7	0.39	0.42				
10-SYJ7□23-□-C8	2 position	Single	1/8	C8 (ø8 One-touch fitting)	2.3	0.45	0.57	2.8	0.37	0.71	188 (108)	190 (110)	232 (152)	198 (118)	
		Double			1.9	0.36	0.48	2.1	0.46	0.57					
	3 position	Closed center			1.2	0.48	0.35	3.4 [1.3]	0.36 [0.57]	0.86 [0.41]					
		Exhaust center			3.3 [0.85]	0.43 [0.54]	0.78 [0.25]	2.1	0.45	0.56					
		Pressure center			2.3	0.41	0.61	2.9	0.35	0.74					
					1.9	0.46	0.50	2.2	0.44	0.60					
Base mounted	10-SYJ7□43-□-01	2 position	Single	1/8	1/8	2.3	0.45	0.57	2.8	0.37	0.71	188 (108)	190 (110)	232 (152)	198 (118)
			Double			1.9	0.36	0.48	2.1	0.46	0.57				
		3 position	Closed center			1.2	0.48	0.35	3.4 [1.3]	0.36 [0.57]	0.86 [0.41]				
			Exhaust center			3.3 [0.85]	0.43 [0.54]	0.78 [0.25]	2.1	0.45	0.56				
			Pressure center			2.3	0.41	0.61	2.9	0.35	0.74				
						1.9	0.46	0.50	2.2	0.44	0.60				
	10-SYJ7□43-□-02	2 position	Single	1/4	1/4	2.3	0.41	0.61	2.9	0.35	0.74	188 (108)	190 (110)	232 (152)	198 (118)
			Double			1.9	0.46	0.50	2.2	0.44	0.60				
		3 position	Closed center			1.3	0.45	0.35	3.7 [1.4]	0.27 [0.56]	0.87 [0.43]				
			Exhaust center			3.6 [0.83]	0.23 [0.55]	0.84 [0.25]	2.1	0.47	0.58				
			Pressure center			2.3	0.41	0.61	2.9	0.35	0.74				
						1.9	0.46	0.50	2.2	0.44	0.60				

Note 1 [] : denotes normal position. Exhaust center: 4/2 → 5/3, Pressure center: 1 → 4/2

Note 2 () : Without sub-plate.

Note 3) For DC voltages. For AC voltages, add 3 g to the weight of the single solenoid and 6 g to the weight of the double solenoid and 3 position types.

Cylinder Speed Chart

Use as a guide for selection.

Please confirm the actual conditions with SMC Model Selection Software.

Body Ported

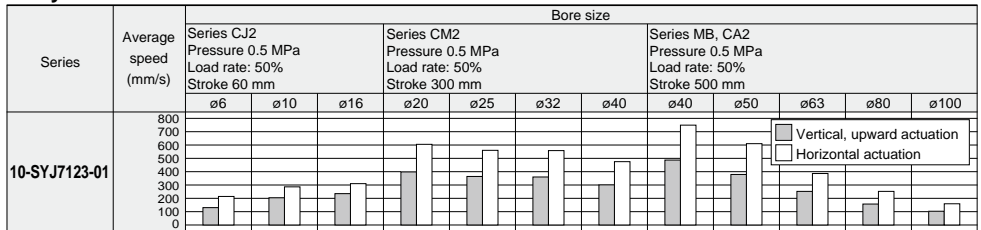

Base Mounted

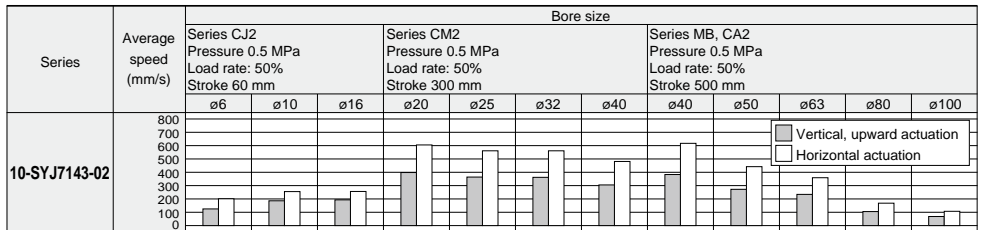

* Cylinder is in extending. Speed controller is meter-out, which is directly connected with cylinder and its needle is fully opened.

* Average speed of cylinder is obtained by dividing the full stroke time by the stroke.

* Load factor: ((Load mass x 9.8)/Theoretical force) x 100%

Conditions

	Body ported	Series CJ2	Series CM2	Series MB/CA2
10-SYJ7123-01	Tubing diameter x Length	ø6 x 1 m		ø12 x 1 m
	Speed controller	AS2302F-06	AS3302F-06	AS4002F-12
	Silencer	AN110-01	AN20-02	

	Base mounted	Series CJ2	Series CM2	Series MB/CA2
10-SYJ7143-02	Tubing diameter x Length	ø6 x 1 m		
	Speed controller	AS1302F-06	AS3002F-06	
	Silencer	AN110-01	AN20-02	AN3301F-06

Construction

2 position single

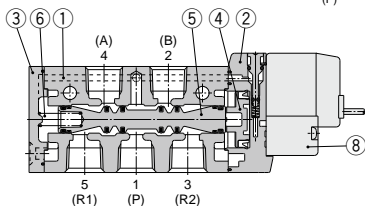

2 position double

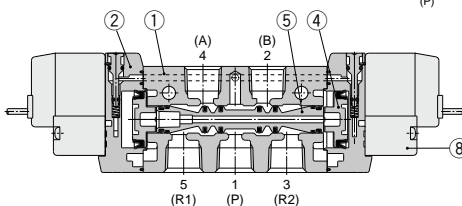
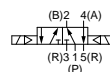

3 position closed center/exhaust center/pressure center

3 position closed center

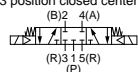

3 position exhaust center



3 position pressure center

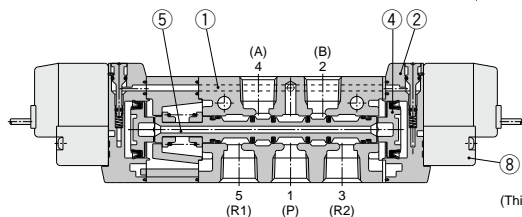

(This figure shows a closed center type.)

Component Parts

No.	Description	Material	Note
1	Body	Aluminum die-casted	White
2	Piston plate	Resin	White
3	End cover	Aluminum die-casted	White
4	Piston	Resin	—
5	Spool valve assembly	Aluminum, H-NBR	—
6	Spool spring	Stainless steel	—

Replacement Parts

No.	Description	Part no.	Note
7	Sub-plate ^(Note)	SYJ7000-22-1(-Q) SYJ7000-22-2(-Q)	1/8 Aluminum die-casted 1/4
8	Pilot valve	V111(T)-□□□	—

Note) Add suffix "-Q" for the CE-compliant product.

How to Order Pilot Valve Assembly

V111 - 5 G

Coil type

Nii	Standard
T	With power saving circuit (24, 12 VDC only)

* Power saving circuit is not available for W□ type.

Rated voltage

5	24 VDC
6	12 VDC
V	6 VDC
S	5 VDC
R	3 VDC
1	100 VAC 50/60 Hz
2	200 VAC 50/60 Hz
3	110 VAC 50/60 Hz [115 VAC 50/60 Hz]
4	220 VAC 50/60 Hz [230 VAC 50/60 Hz]

* For type W□, only DC voltage is available.
* CE-compliant: For DC only.

Light/Surge voltage suppressor

Nii	Without light/surge voltage suppressor
S	With surge voltage suppressor
Z	With light/surge voltage suppressor
R	With surge voltage suppressor (Non-polar type)
U	With light/surge voltage suppressor (Non-polar type)

* For AC voltage valves there is no "S" option. It is already built into the rectifier circuit.
* For type R and U, only DC voltage is available.
* Power saving circuit is only available for the "Z" type.

Electrical entry

G	Grommet, 300 mm lead wire
H	Grommet, 600 mm lead wire
L	With lead wire
LN	Without lead wire
LO	Without connector
M	With lead wire
MN	Without lead wire
MO	Without connector
WO	Without connector cable
W□	With connector cable ^(Note 1)

* For connector cable of M8 connector, refer to page 374.

V115 - 5 D

Rated voltage

5	24 VDC
6	12 VDC
1	100 VAC 50/60 Hz
2	200 VAC 50/60 Hz
3	110 VAC 50/60 Hz [115 VAC 50/60 Hz]
4	220 VAC 50/60 Hz [230 VAC 50/60 Hz]

Light/Surge voltage suppressor

Nii	Without light/surge voltage suppressor
S	With surge voltage suppressor (Non-polar type)
Z	With light/surge voltage suppressor (Non-polar type)

* DOZ is not available.
* For AC voltage valves there is no "S" option. It is already built into the rectifier circuit.

Electrical entry

D	DIN terminal	With connector
DO	(Type D)	Without connector
Y	DIN terminal	With connector
YO	(Type Y)	Without connector

Note) Do not replace V111 (G, H, L, M, W) with V115 (DIN terminal) and vice versa when replacing pilot valve assembly only.

Note 1) Enter the cable length symbols in □. Please be sure to fill in the blank referring to page 374.

Note) Since V111 and V115 are CE-compliant as standard, the suffix "-Q" is not necessary.

2 Position Single

Grommet (G), (H): 10-SYJ7123-□□□□-01□

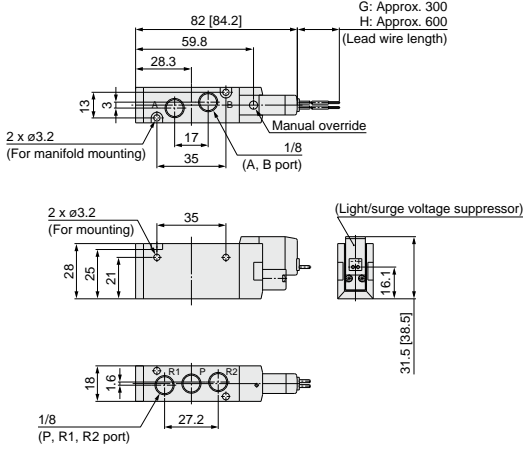

With bracket:
10-SYJ7123-□□□□-01□-F

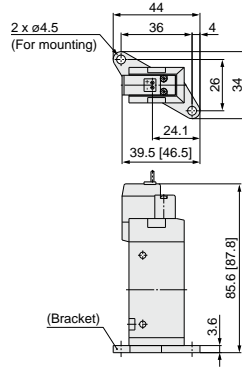

Built-in One-touch fitting:
10-SYJ7123-□□□□-C6, N7 □□ (-F)

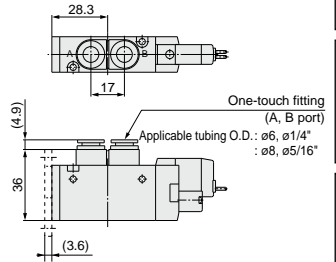

L plug connector (L):
10-SYJ7123-□□□□-01□ (-F)

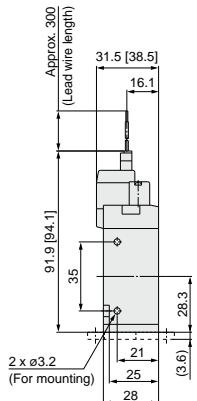

M plug connector (M):
10-SYJ7123-□□□□-01□ (-F)

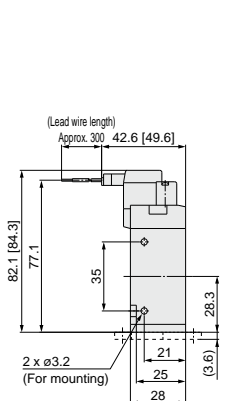

DIN terminal (D, Y):
10-SYJ7123-□□□□-01□ (-F)

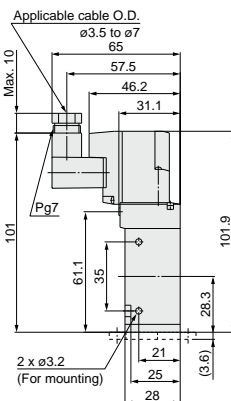

M8 connector (WO):
10-SYJ7123-□□□□-01□ (-F)

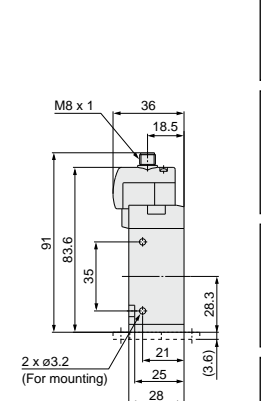

* Refer to page 375 for dimensions with connector cable.

Directional Control Valves

Air Cylinders

Rotary Actuators

Air Grippers

Air Preparation Equipment

Modular F. R.

Pressure Control Equipment

Fittings & Tubing

Flow Control Equipment

Pressure Switches/ Pressure Sensors

2 Position Double

* []: AC

Grommet (G), (H): 10-SYJ7223-□□□□-01□

Built-in One-touch fitting:
 C6, N7
 C8, N9 □

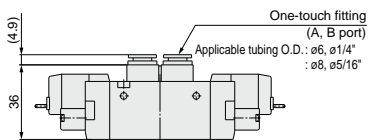
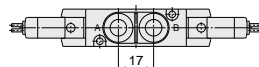
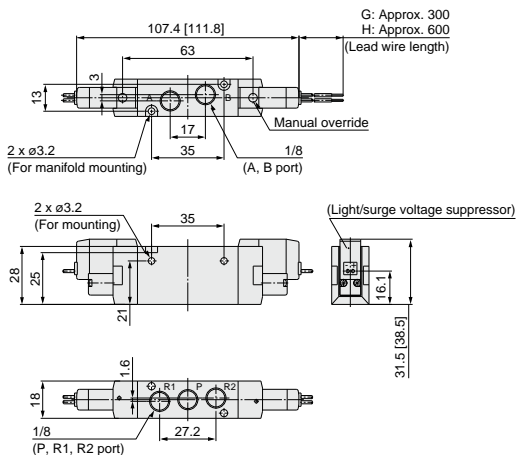

L plug connector (L):
 10-SYJ7223-□□□□-01□

M plug connector (M):
 10-SYJ7223-□M□□-01□

DIN terminal (D, Y):
 10-SYJ7223-□Y□□-01□

M8 connector (WO):
 10-SYJ7223-□WO□□-01□

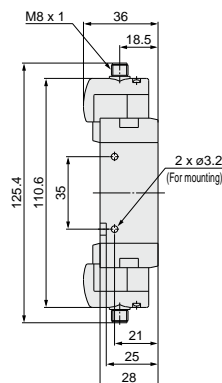
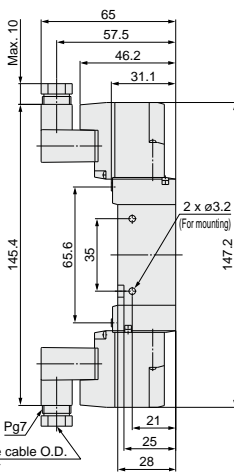
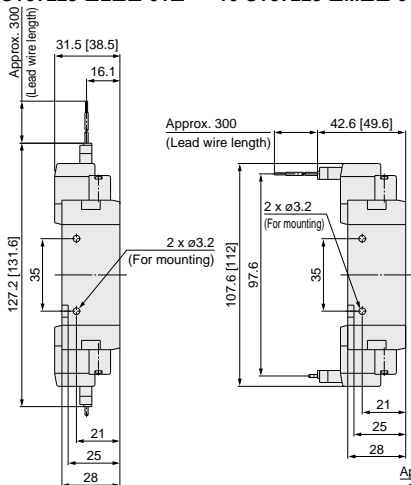

* Refer to page 375 for dimensions with connector cable.

3 Position Closed Center/Exhaust Center/Pressure Center

* []: AC

Grommet (G), (H): 10-SYJ7³/₅23-□^G□□-01□

Built-in One-touch fitting:
10-SYJ7³/₅23-□^G□□-□^{C6, N7}□^{C8, N9}□

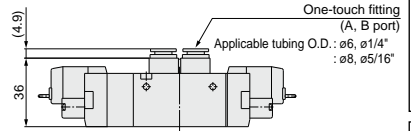
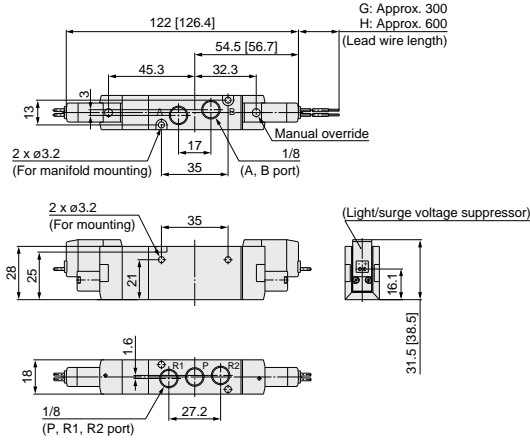

L plug connector (L):
10-SYJ7³/₅23-□^L□□-01□

M plug connector (M):
10-SYJ7³/₅23-□^M□□-01□

DIN terminal (D, Y):
10-SYJ7³/₅23-□^D□□-01□

M8 connector (WO):
10-SYJ7³/₅23-□^{WO}□□-01□

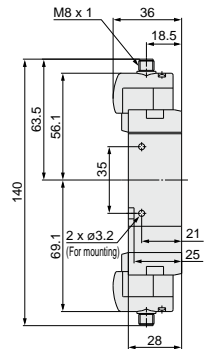
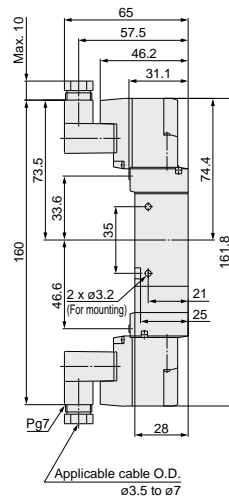
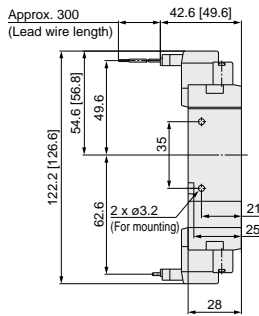
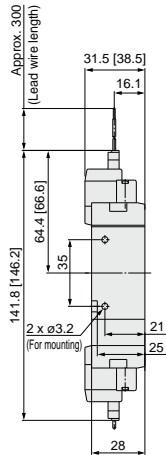

* Refer to page 375 for dimensions with connector cable.

2 Position Single

* []: AC

Grommet (G), (H): 10-SYJ7143-□□□□-01□□

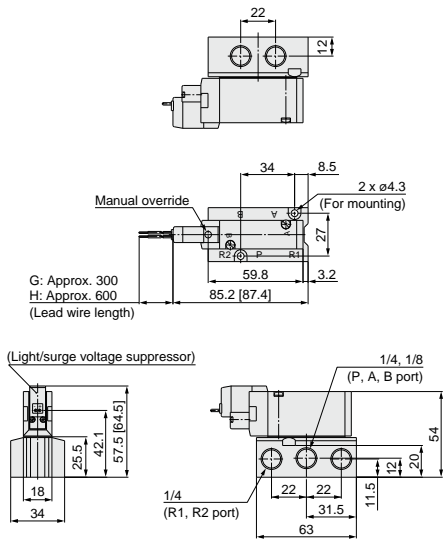

L plug connector (L):
10-SYJ7143-□□□□-01□□

M plug connector (M):
10-SYJ7143-□□□□-01□□

DIN terminal (D, Y):
10-SYJ7143-□□□□-01□□

M8 connector (WO):
10-SYJ7143-□□□□-01□□

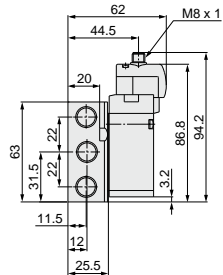
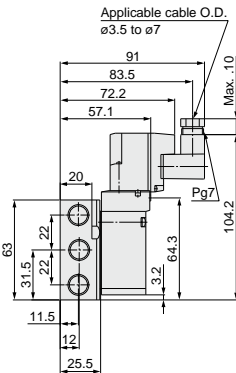
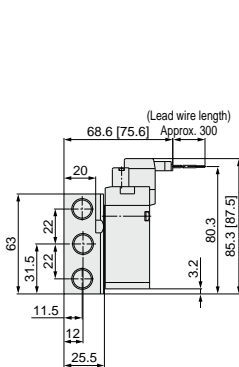
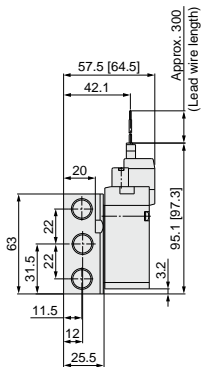

* Refer to page 375 for dimensions with connector cable.

2 Position Double

* []: AC

Grommet (G), (H): 10-SYJ7243-□□^G□□□□-01□□

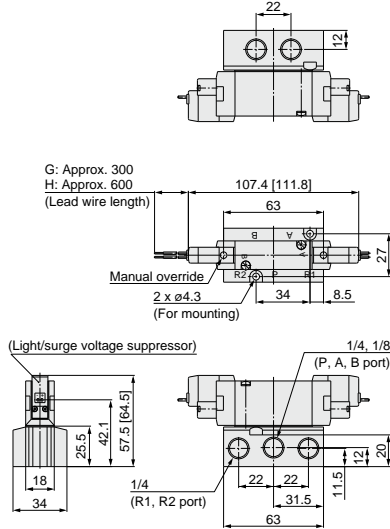

L plug connector (L):
10-SYJ7243-□□□□-01□□

M plug connector (M):
10-SYJ7243-□□□□-01□□

DIN terminal (D, Y):
10-SYJ7243-□□□□-01□□

M8 connector (WO):
10-SYJ7243-□□WO□□-01□□

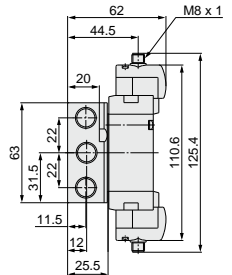
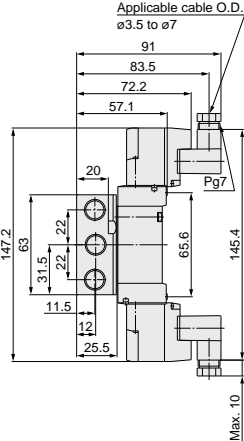
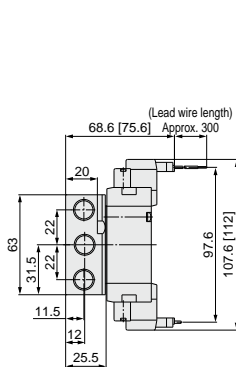
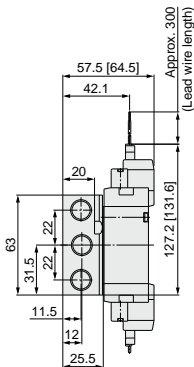

* Refer to page 375 for dimensions with connector cable.

Directional Control Valves
Air Cylinders
Rotary Actuators
Air Grippers
Air Preparation Equipment
Modular F. R.
Pressure Control Equipment
Fittings & Tubing
Flow Control Equipment
Pressure Switches/Pressure Sensors

3 Position Closed Center/Exhaust Center/Pressure Center

* []: AC

Grommet (G), (H): 10-SYJ7³/₅43-□□□□-01□□

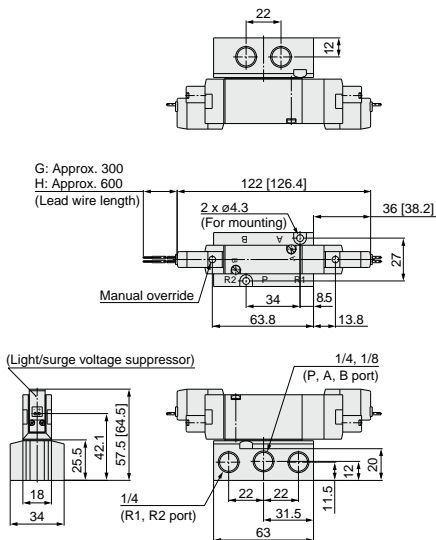

L plug connector (L):
10-SYJ7³/₅43-□□□□-01□□

M plug connector (M):
10-SYJ7³/₅43-□□□□-01□□

DIN terminal (D, Y):
10-SYJ7³/₅43-□□□□-01□□

M8 connector (WO):
10-SYJ7³/₅43-□□□□-01□□

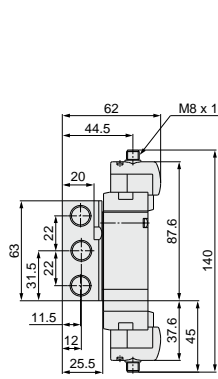
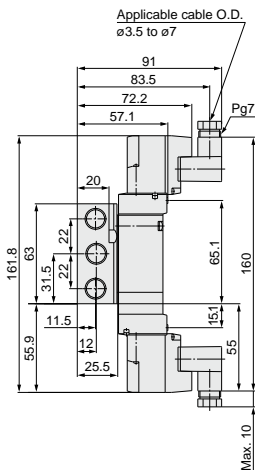
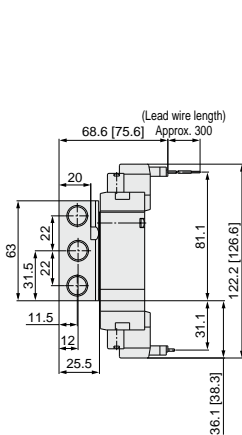
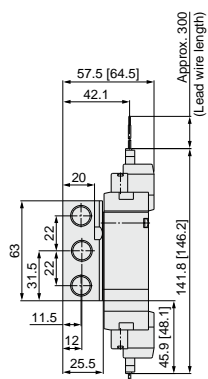

* Refer to page 375 for dimensions with connector cable.

Manifold Specifications



Standard Manifold



Manifold Specifications

Model		Type 20	Type 21	Type 40	Type 41	Type 42
Manifold type		Single base/B mount				
P (SUP), R (EXH)		Common SUP, Common EXH				
Valve stations		2 to 15 stations		2 to 20 stations		
A, B port	Location	Valve		Base	Base	
	Direction	Top		Bottom	Side	
Porting specifications	P, R port	1/8		1/4		
	A, B port	1/8 C6 (ø6 One-touch fitting) C8 (ø8 One-touch fitting)		1/8		C6 (ø6 One-touch fitting) C8 (ø8 One-touch fitting)

Flow Rate Characteristics

Manifold			Port size		Flow rate characteristics					
					1 → 4/2 (P → A/B)			4/2 → 5/3 (A/B → R)		
			1(P), 5/3(R) port	2(B), 4(A) port	C (dm ³ /(s·bar))	b	Cv	C (dm ³ /(s·bar))	b	Cv
Body ported for internal pilot	Type 10-SS5YJ7-20	10-SYJ7□23	1/8	1/8	2.2	0.35	0.57	2.3	0.26	0.55
			1/8	C6	1.4	0.32	0.37	2.0	0.25	0.49
			1/8	C8	1.7	0.38	0.45	2.1	0.25	0.51
	Type 10-SS5YJ7-21		1/4	1/8	2.1	0.36	0.55	2.3	0.26	0.54
			1/4	C6	1.4	0.32	0.36	2.1	0.24	0.50
			1/4	C8	1.8	0.37	0.50	2.1	0.20	0.50
Base mounted for internal pilot	Type 10-SS5YJ7-40	10-SYJ7□43	1/4	1/8	2.1	0.28	0.51	2.5	0.23	0.59
	Type 10-SS5YJ7-41		1/4	1/8	2.0	0.30	0.50	2.2	0.30	0.55
	Type 10-SS5YJ7-42-C6		1/4	C6	1.5	0.32	0.38	2.2	0.23	0.52
	Type 10-SS5YJ7-42-C8		1/4	C8	1.9	0.24	0.46	2.2	0.26	0.53

Note) The values are for individually operated 2 position type manifold bases.

How to Order Manifold (Example)

Instruct by specifying the valves and blanking plate assembly to be mounted on the manifold along with the manifold base model no.

- Example: ● 10-SS5YJ7-20-03 1 pc. (Manifold base)
 * 10-SYJ7123-5G-01 2 pcs. (Valve)
 * SYJ7000-21-1A 1 pc. (Blanking plate assembly)
- 10-SS5YJ7-41-03-01 1 pc. (Manifold base)
 * 10-SYJ7143-5LZ 1 pc. (Valve)
 * 10-SYJ7243-5LZ 1 pc. (Valve)
 * SYJ7000-21-1A 1 pc. (Blanking plate assembly)

↳The asterisk denotes the symbol for assembly. Prefix it to the part no. of the solenoid valve, etc.

Directional Control Valves

Air Cylinders

Rotary Actuators

Air Grippers

Air Preparation Equipment

Modular F. R.

Pressure Control Equipment

Fittings & Tubing

Flow Control Equipment

Pressure Switches/ Pressure Sensors

Note) CE-compliant:
For DC only.



Flat Ribbon Cable Manifold

- Multiple valve wiring is simplified through the use of the flat ribbon cable connector.
- Clean appearance

For flat ribbon cables, each valve is wired on the print board of the manifold base to allow the external wiring to be piped all together with the 26 pin MIL connector.



Flat Ribbon Cable Manifold Specifications

Model		Type 21P
Manifold type		Single base/B mount
P (SUP), R (EXH)		Common SUP, Common EXH
Valve stations		3 to 12 stations
A, B port location		Valve
Port size	P, R port	1/4
	A, B port	1/8, C6, C8
Applicable flat ribbon cable connector		Socket: 26 pin MIL type with strain relief (Conforming to MIL-C-83503)
Internal wiring		Common between +COM and -COM (Z type: +COM only).
Rated voltage ^{Note 3)}		24, 12 VDC, 100, 110 VAC

Note 1) The values are for individually operated 2 position type manifold bases.

Note 2) The withstand voltage specifications for the wiring unit section is JIS C 0704, Grade 1 or its equivalent.

Note 3) CE-compliant: For DC only.

Flow Rate Characteristics

Manifold	Port size	Flow rate characteristics									
		1 → 4/2 (P → A/B)			4/2 → 5/3 (A/B → R)						
		C	b	Cv	C	b	Cv				
Body ported for internal pilot	Type 10-SS5YJ7-21P-01 Type 10-SS5YJ7-21P-C6 Type 10-SS5YJ7-21P-C8	1(P), 5/3(R) port	2(B), 4(A) port	1/4	1/8	2.1	0.36	0.55	2.3	0.26	0.54
				1/4	C6	1.4	0.32	0.36	2.1	0.24	0.50
				1/4	C8	1.8	0.37	0.50	2.1	0.20	0.50

Note) The values are for individually operated 2 position type manifold bases.

How to Order Manifold (Example)

Instruct by specifying the valves, blanking plate assembly and connector assembly to be mounted on the manifold along with the manifold base model no.

Example:

- 10-SS5YJ7-21P-07 (-Q) 1 pc. (Manifold base)
- * 10-SYJ7123-5LOU-C8 (-Q) ... 3 pcs. (Valve)
- * 10-SYJ7223-5LOU-C8 (-Q) ... 3 pcs. (Valve)
- * SYJ7000-21-3A (-Q) 1 pc. (Blanking plate assembly)
- * SY3000-37-3A 3 pcs. (Connector assembly)
- * SY3000-37-4A 3 pcs. (Connector assembly)

↳The asterisk denotes the symbol for assembly. Prefix it to the part no. of the solenoid valve, etc.

Note) Please indicate the connector assembly part no. below that connects the valve and the manifold.

How to Order Valve

Note) CE-compliant:
For DC only.

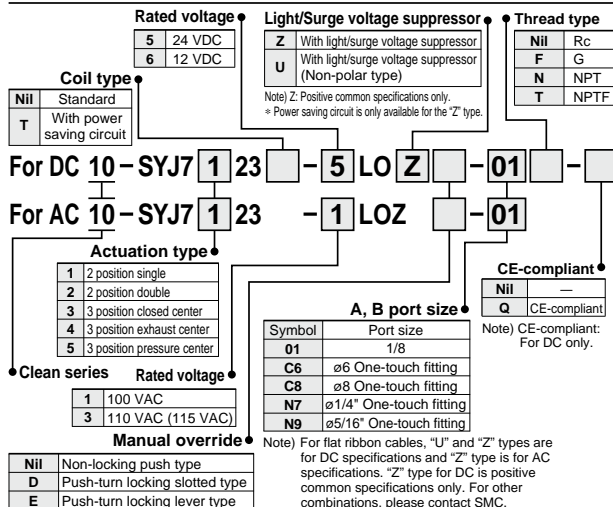

Connector Assembly

For 12, 24 VDC

Single solenoid	SY3000-37-3A
Double solenoid, 3 position type	SY3000-37-4A
Single solenoid	SY3000-37-3A
With individual EXH spacer assembly	
Double solenoid, 3 position type	SY3000-37-6A
With individual EXH spacer assembly	
With 3 port adapter plate	SY3000-37-3A

For 100 VAC

Single solenoid	SY3000-37-32A
Double solenoid, 3 position type	SY3000-37-33A
Single solenoid	SY3000-37-15A
With individual EXH spacer assembly	
Double solenoid, 3 position type	SY3000-37-34A
With individual EXH spacer assembly	
With 3 port adapter plate	SY3000-37-32A

For 110 VAC

Single solenoid	SY3000-37-35A
Double solenoid, 3 position type	SY3000-37-36A
Single solenoid	SY3000-37-19A
With individual EXH spacer assembly	
Double solenoid, 3 position type	SY3000-37-37A
With individual EXH spacer assembly	
With 3 port adapter plate	SY3000-37-35A

EX510 Gateway-type Serial Transmission System

Manifold for EX510 Serial Wiring Specifications

Model		Type 21SA	Type 41SA
Manifold type		Single base/B mount	
P (SUP), R (EXH)		Common SUP, Common EXH	
Valve stations		3 to 16 stations	
A, B port Porting specifications	Location	Valve	Base
	Direction	Top	Side
Port size	P, R port	1/4	
	A, B port	1/8, C6, C8 (ø6, ø8 One-touch fitting)	1/8
Rated voltage		24 VDC	

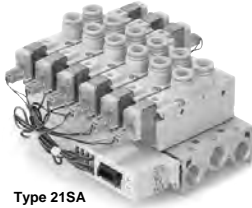

Type 21SA

Flow Rate Characteristics

Manifold				Port size		Flow rate characteristics					
						1 → 4/2 (P → A/B)			4/2 → 5/3 (A/B → R)		
				1(P), 5/3(R) port	2(B), 4(A) port	C (dm ³ /s·bar)	b	Cv	C (dm ³ /s·bar)	b	Cv
Body ported for internal pilot	Type 10-SS5YJ7-21SA	10-SYJ7□20	1/4	1/8	2.1	0.36	0.55	2.3	0.26	0.54	
			1/4	C6	1.4	0.32	0.36	2.1	0.24	0.50	
Base mounted for internal pilot	Type 10-SS5YJ7-41SA	10-SYJ7□40	1/4	C8	1.8	0.37	0.50	2.1	0.20	0.50	
			1/4	1/8	2.0	0.30	0.50	2.2	0.30	0.55	

How to Order Manifold (Example)

10-SS5YJ7-21SA-05	1 set (Type 21SA, 5-station manifold part no.)
* 10-SYJ7123-5LOU-01	3 sets (Single solenoid part no.)
* 10-SYJ7223-5LOU-01	2 sets (Double solenoid part no.)

↳ The asterisk denotes the symbol for assembly. Prefix it to the part no. of the solenoid valve, etc.

Add the valve and option part number under the manifold base part number.

When entry of part numbers becomes complicated, indicate by the manifold specification sheet. For a EX510 manifold, the length of the lead wire for a connector assembly depends on the number of stations. Therefore, the manifold assembly is shipped with the valves (including blanking plates) and connector assembly mounted on it, as the standard specification. Be sure to specify the part no. of the solenoid valves to be mounted.

Directional
Control Valves

Air Cylinders

Rotary Actuators

Air Grippers

Air Preparation
Equipment

Modular F. R.

Pressure Control
Equipment

Fittings & Tubing

Flow Control
Equipment

Pressure Switches/
Pressure Sensors

How to Order Manifold

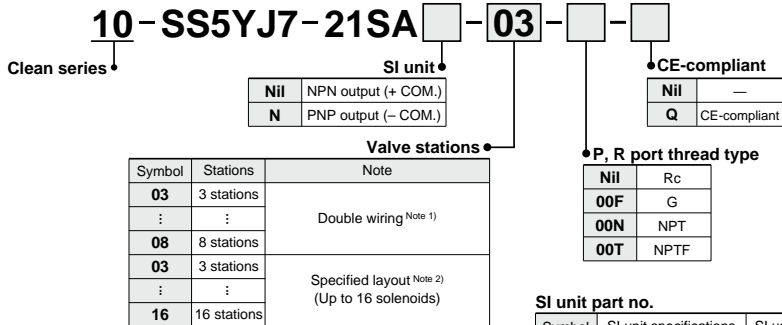

Includes the number of the blanking plate assemblies.
 Note 1) Double wiring: Use of a single solenoid will result in an unused control signal. If this is not desired, order with a specified layout.
 Note 2) Specified layout: Indicate wiring specifications on the manifold specification sheet. (Note that double and 3 position valves cannot be used where single solenoid wiring has been specified.)

SI unit part no.

Symbol	SI unit specifications	SI unit part no.	Page
Nil	NPN output (+ COM.)	EX510-S001	WEB catalog
N	PNP output (- COM.)	EX510-S101	WEB catalog

Refer to the **WEB catalog** and the Operation Manual for the details of the EX510 Gateway-type Serial Transmission System. Please download the Operation Manual via our website, <http://www.smcworld.com>

How to Order Valve

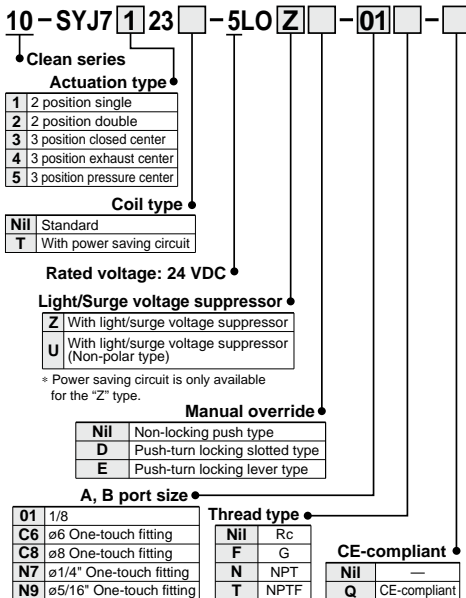

How to Order Manifold Assembly (Example)

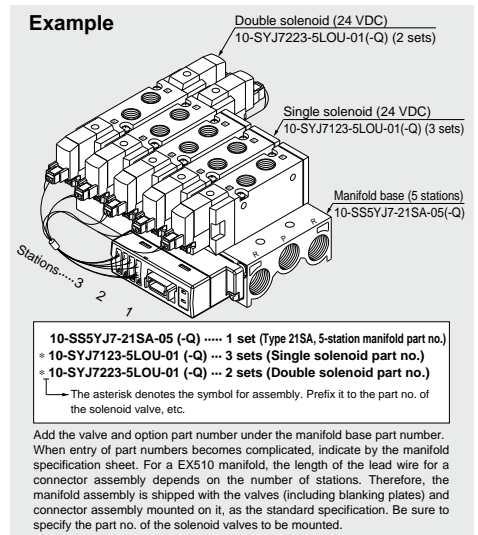

Series 10-SYJ7000

EX510 Gateway-type Serial Transmission System
Base Mounted Manifold



How to Order Manifold

10-SS5YJ7-41SA - **03** - **01** -

- Clean series**
- SI unit**

Nil	NPN output (+ COM.)
N	PNP output (- COM.)
- CE-compliant**

Nil	—
Q	CE-compliant
- P, R, A, B port thread type**

Nil	Rc
F	G
N	NPT
T	NPTF
- A, B port size**

01	1/8
----	-----
- Valve stations**

Symbol	Stations	Note
03	3 stations	Double wiring ^{Note 1)}
:	:	
08	8 stations	Specified layout ^{Note 2)} (Up to 16 solenoids)
03	3 stations	
:	:	
16	16 stations	

SI unit part no.

Symbol	SI unit specifications	SI unit part no.	Page
Nil	NPN output (+ COM.)	EX510-S001	WEB catalog
N	PNP output (- COM.)	EX510-S101	WEB catalog

Refer to the **WEB catalog** and the Operation Manual for the details of the EX510 Gateway-type Serial Transmission System. Please download the Operation Manual via our website, <http://www.smcworld.com>

Includes the number of the blanking plate assemblies.
Note 1) Double wiring: Use of a single solenoid will result in an unused control signal. If this is not desired, order with a specified layout.
Note 2) Specified layout: Indicate wiring specifications on the manifold specification sheet. (Note that double and 3 position valves cannot be used where single solenoid wiring has been specified.)

How to Order Valve

10-SYJ7 **1** **43** - **5LO** **Z** -

- Clean series**
- Actuation type**

1	2 position single
2	2 position double
3	3 position closed center
4	3 position exhaust center
5	3 position pressure center
- Coil type**

Nil	Standard
T	With power saving circuit
- Rated voltage: 24 VDC**
- Light/Surge voltage suppressor**

Z	With light/surge voltage suppressor
U	With light/surge voltage suppressor (Non-polar type)
- * Power saving circuit is only available for the "Z" type.
- Manual override**

Nil	Non-locking push type
D	Push-turn locking slotted type
E	Push-turn locking lever type
- CE-compliant**

Nil	—
Q	CE-compliant

How to Order Manifold Assembly (Example)

Example

10-SS5YJ7-41SA-05 (-Q) 1 set (Type 41SA, 5-station manifold part no.)
*** 10-SYJ7143-5LOU-01 (-Q) ... 3 sets (Single solenoid part no.)**
*** 10-SYJ7243-5LOU-01 (-Q) ... 2 sets (Double solenoid part no.)**

The asterisk denotes the symbol for assembly. Prefix it to the part no. of the solenoid valve, etc.

Add the valve and option part number under the manifold base part number. When entry of part numbers becomes complicated, indicate by the manifold specification sheet. For a EX510 manifold, the length of the lead wire for a connector assembly depends on the number of stations. Therefore, the manifold assembly is shipped with the valves (including blanking plates) and connector assembly mounted on it, as the standard specification. Be sure to specify the part no. of the solenoid valves to be mounted.

Directional Control Valves
 Air Cylinders
 Rotary Actuators
 Air Grippers
 Air Preparation Equipment
 Modular F. R.
 Pressure Control Equipment
 Fittings & Tubing
 Flow Control Equipment
 Pressure Switches/ Pressure Sensors



Note) AC-type models that are CE-compliant have DIN terminals only. [Option]

Individual Wiring

Common SUP/Common EXH

Type 20 (5 port/Body ported)

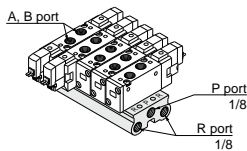

How to Order

10-SS5YJ7-20-05 - [] - []

Clean series

Stations

02	2 stations
:	:
15	15 stations

P, R port thread type

Nil	Rc
00F	G
00N	NPT
00T	NPTF

CE-compliant

Nil	—
Q	CE-compliant

Applicable solenoid valve

10-SYJ□23-□□□□-01 C6 N7(-Q) C8 N9*

Applicable blanking plate assembly

Refer to page 360.

Note) For more than 6 stations, supply pressure to P port on both sides and exhaust from R port on both sides.

Type 21 (5 port/Body ported)

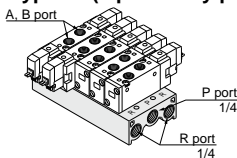

How to Order

10-SS5YJ7-21-05 - [] - []

Clean series

Stations

02	2 stations
:	:
20	15 stations

P, R port thread type

Nil	Rc
00F	G
00N	NPT
00T	NPTF

CE-compliant

Nil	—
Q	CE-compliant

Applicable individual EXH spacer assembly

Refer to page 359.

Note) For more than 10 stations, supply pressure to P port on both sides and exhaust from R port on both sides.

Type 40 (5 port/Base mounted)

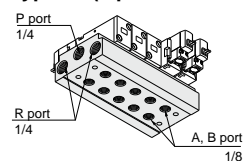

How to Order

10-SS5YJ7-40-05-01 - [] - []

Clean series

Stations

02	2 stations
:	:
20	20 stations

A, B port size

01	1/8
----	-----

Thread type

Nil	Rc
F	G
N	NPT
T	NPTF

CE-compliant

Nil	—
Q	CE-compliant

Applicable solenoid valve

10-SYJ□43-□□□□(-Q)

Applicable blanking plate assembly

Refer to page 360.

Note) For more than 10 stations, supply pressure to P port on both sides and exhaust from R port on both sides.

Type 41 (5 port/Base mounted)

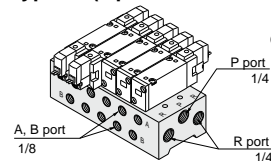

How to Order

10-SS5YJ7-41-05-01 - [] - []

Clean series

Stations

02	2 stations
:	:
20	20 stations

Thread type

Nil	Rc
F	G
N	NPT
T	NPTF

CE-compliant

Nil	—
Q	CE-compliant

Applicable individual EXH spacer assembly

Refer to page 359.

Note) For more than 8 stations, supply pressure to P port on both sides and exhaust from R port on both sides.

Type 42 (5 port/Base mounted)

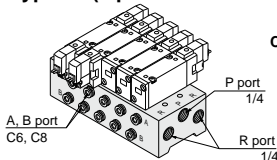

How to Order

10-SS5YJ7-42-05-C6 - [] - []

Clean series

Stations

02	2 stations
:	:
20	20 stations

A, B port size

C6	ø6 One-touch fitting
C8	ø8 One-touch fitting
N7	ø1/4" One-touch fitting
N9	ø5/16" One-touch fitting

Thread type

Nil	Rc
F	G
N	NPT
T	NPTF

CE-compliant

Nil	—
Q	CE-compliant

Applicable individual SUP spacer assembly

Refer to page 359.

Note) For more than 8 stations, supply pressure to P port on both sides and exhaust from R port on both sides.



Note) CE-compliant:
For DC only. [Option]

Flat Ribbon Cable Manifold

Common SUP/Common EXH

Type 21P (5 port/Body ported)

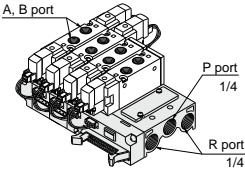

How to Order

10 - SS5YJ7 - 21P - 05 - [] - []

Clean series

Stations

03	3 stations
:	:
12	12 stations

P, R port thread type

Nil	Rc
00F	G
00N	NPT
00T	NPTF

CE compliant

Nil	—
Q	CE compliant

Applicable solenoid valve
Refer to page 353.

Applicable blanking plate assembly
Refer to page 360.

Applicable connector assembly
Refer to page 353.

Note) For more than 10 stations, supply pressure to P port on both sides and exhaust from R port on both sides.

EX510 Gateway-type Serial Transmission System

Type 21SA (5 port/Body ported)

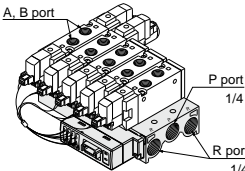

How to Order

10 - SS5YJ7 - 21SA [] - 03 - [] - []

Clean series

Valve stations

Nil	Stations	Note
03	3 stations	Double wiring (Note 1)
:	:	
08	8 stations	Specified layout (Note 2) (Up to 16 solenoids)
03	3 stations	
:	:	
16	16 stations	

P, R port thread type

Nil	Rc
00F	G
00N	NPT
00T	NPTF

CE-compliant

Nil	—
Q	CE-compliant

Applicable solenoid valve
Refer to page 355.

Applicable blanking plate assembly
Refer to page 360.

SI unit*

Nil	NPN output (+ COM.)
N	PNP output (- COM.)

* Includes the number of the blanking plate assemblies.

Note 1) Double wiring: Use of a single solenoid will result in an unused control signal. If this is not desired, order with a specified layout.

Note 2) Specified layout: Indicate wiring specifications on the manifold specification sheet. (Note that double and 3 position valves cannot be used where single solenoid wiring has been specified.)

Type 41SA (5 port/Base mounted)

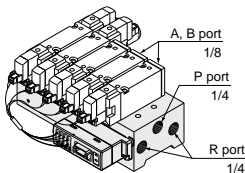

How to Order

10 - SS5YJ7 - 41SA [] - 03 - 01 - [] - []

Clean series

Valve stations

Nil	Stations	Note
03	3 stations	Double wiring (Note 1)
:	:	
08	8 stations	Specified layout (Note 2) (Up to 16 solenoids)
03	3 stations	
:	:	
16	16 stations	

A, B port size

01	1/8
----	-----

P, R, A, B port thread type

Nil	Rc
F	G
N	NPT
T	NPTF

CE-compliant

Nil	—
Q	CE-compliant

Applicable solenoid valve
Refer to page 356.

Applicable blanking plate assembly
Refer to page 360.

SI unit*

Nil	NPN output (+ COM.)
N	PNP output (- COM.)

* Includes the number of the blanking plate assemblies.

Note 1) Double wiring: Use of a single solenoid will result in an unused control signal. If this is not desired, order with a specified layout.

Note 2) Specified layout: Indicate wiring specifications on the manifold specification sheet. (Note that double and 3 position valves cannot be used where single solenoid wiring has been specified.)

Directional Control Valves

Air Cylinders

Rotary Actuators

Air Grippers

Air Preparation Equipment

Modular F. R.

Pressure Control Equipment

Fittings & Tubing

Flow Control Equipment

Pressure Switches/ Pressure Sensors

Combinations of Solenoid Valve, Manifold Gasket and Manifold Base

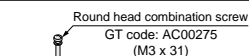

Applicable manifold base

- Type 10-SS5YJ7-20(-Q)
- Type 10-SS5YJ7-21(-Q)
- Type 10-SS5YJ7-21P(-Q)
- Type 10-SS5YJ7-21SA(-Q)

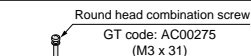

Applicable manifold base

- Sub-plate
- Type 10-SS5YJ7-40(-Q)
- Type 10-SS5YJ7-41(-Q)
- Type 10-SS5YJ7-42(-Q)
- Type 10-SS5YJ7-41SA(-Q)

Individual EXH Spacer Assembly

SYJ7000-17-1 □ A(-Q)

Thread type

NH	Rc
F	G
N	NPT
T	NPTF

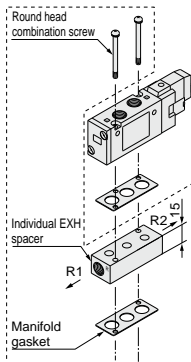

Applicable manifold base

- Type 10-SS5YJ7-20(-Q)
- Type 10-SS5YJ7-21(-Q)
- Type 10-SS5YJ7-21P(-Q)
- Type 10-SS5YJ7-21SA(-Q)

SYJ7000-17-2 □ A(-Q)

Thread type

NH	Rc
F	G
N	NPT
T	NPTF

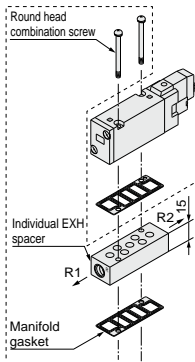

Applicable manifold base

- Type 10-SS5YJ7-40(-Q)
- Type 10-SS5YJ7-41(-Q)
- Type 10-SS5YJ7-42(-Q)
- Type 10-SS5YJ7-41SA(-Q)

Individual SUP Spacer Assembly

SYJ7000-16-2 □ A(-Q)

Thread type

NH	Rc
F	G
N	NPT
T	NPTF

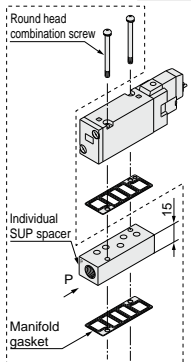

Applicable manifold base

- Type 10-SS5YJ7-40(-Q)
- Type 10-SS5YJ7-41(-Q)
- Type 10-SS5YJ7-42(-Q)
- Type 10-SS5YJ7-41SA(-Q)

⚠ Caution

Mounting screw tightening torque

M3: 0.8 N·m

Use caution to the assembly orientation for solenoid valves, gasket, and optional parts.

Mix Installation of the 10-SYJ700 and the 10-SYJ7000 Valves on the Same Manifold

- Use of an adapter plate makes it possible to mount the 10-SYJ700 on the 10-SYJ7000 manifold bases.
- When mounting the SYJ700 valve on the 10-SYJ7000 manifold, the SYJ700 pilot valve must be positioned on the same side of the manifold as a SYJ7000 single solenoid. (Refer to the figure below.)
- For base mounted type, the A port of the 3 port valve flows out the B port of the manifold base.

Adapter plate assembly SYJ700-3-1A(-Q)

SYJ700 series
Body ported

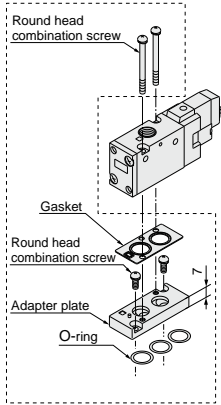

Applicable manifold base
 · Type 10-SS5YJ7-20(-Q)
 · Type 10-SS5YJ7-21(-Q)
 · Type 10-SS5YJ7-40
 · Type 10-SS5YJ7-21P(-Q)
 · Type 10-SS5YJ7-21SA(-Q)

Adapter plate assembly SYJ700-3-2A(-Q)

SYJ700 series
Base mounted

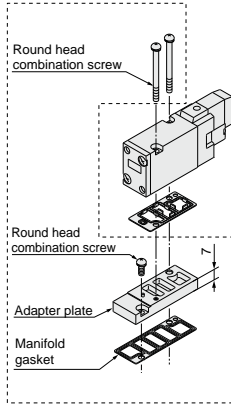

Applicable manifold base
 · Type 10-SS5YJ7-40(-Q)
 · Type 10-SS5YJ7-41(-Q)
 · Type 10-SS5YJ7-42(-Q)
 · Type 10-SS5YJ7-41SA(-Q)

Blanking Plate Assembly

<Standard> SYJ7000-21-1A

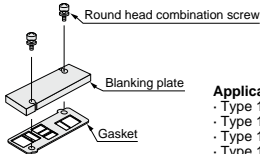

Applicable manifold base
 · Type 10-SS5YJ7-20
 · Type 10-SS5YJ7-21
 · Type 10-SS5YJ7-40
 · Type 10-SS5YJ7-41
 · Type 10-SS5YJ7-42
 · Type 10-SS5YJ7-41SA

SYJ7000-21-3A

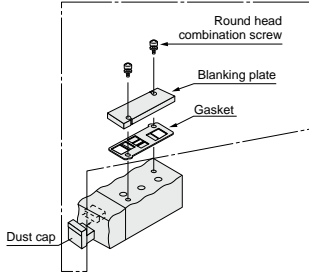

Applicable manifold base
 · Type 10-SS5YJ7-21P

<CE-compliant> SYJ7000-21-1A-1-Q

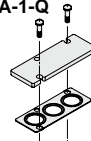

Applicable manifold base
 · Type 10-SS5YJ7-20-Q
 · Type 10-SS5YJ7-21-Q
 · Type 10-SS5YJ7-21SA-Q

SYJ7000-21-1A-2-Q

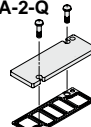

Applicable manifold base
 · Type 10-SS5YJ7-40-Q
 · Type 10-SS5YJ7-41-Q
 · Type 10-SS5YJ7-42-Q
 · Type 10-SS5YJ7-41SA-Q

SYJ7000-21-3A-Q

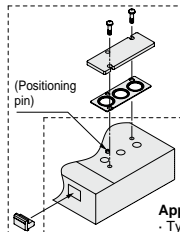

Applicable manifold base
 · Type 10-SS5YJ7-21P-Q

Grommet (G)

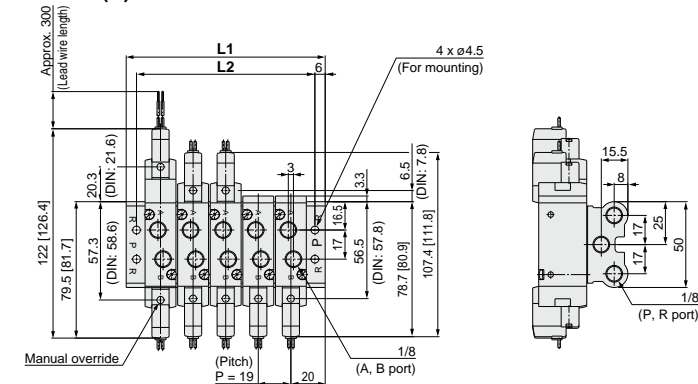

Built-in One-touch fitting

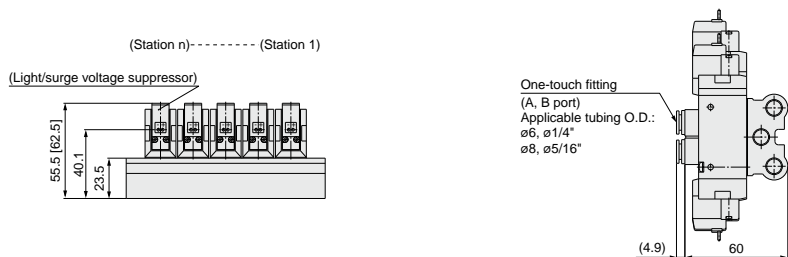

L plug connector (L)

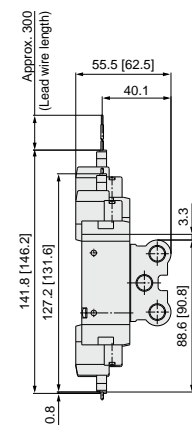

M plug connector (M)

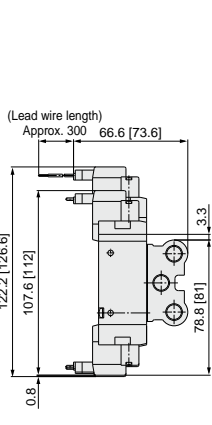

DIN terminal (D, Y)

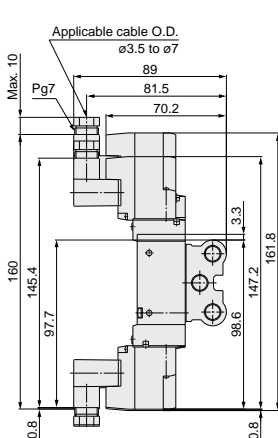

M8 connector (WO)

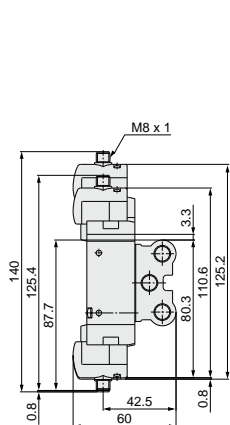

* Refer to page 375 for dimensions with connector cable.

Station	Station 2	3	4	5	6	7	8	9	10	11	12	13	14	Station 15
L1	59	78	97	116	135	154	173	192	211	230	249	268	287	306
L2	47	66	85	104	123	142	161	180	199	218	237	256	275	294

Type 21: Top Ported/10-SS5YJ7-21- Stations (-00□)

* []: AC

Grommet (G)

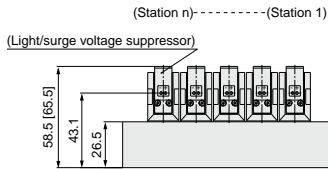
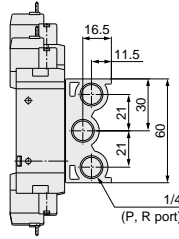
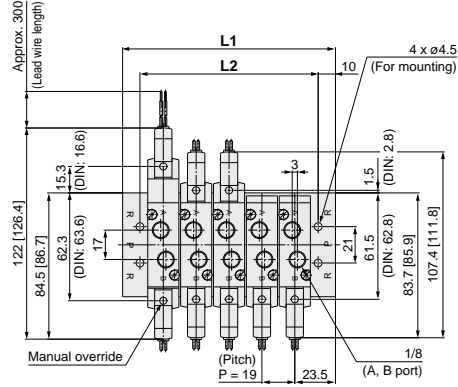

Built-in One-touch fitting

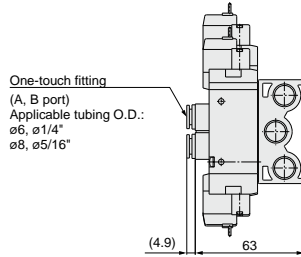

L plug connector (L)

M plug connector (M)

DIN terminal (D, Y)

M8 connector (WO)

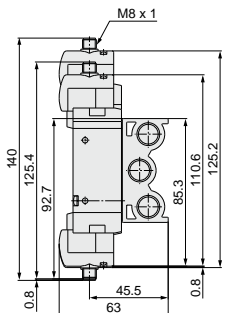
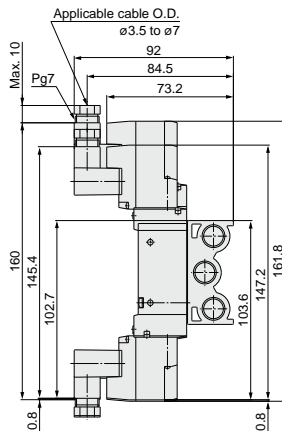
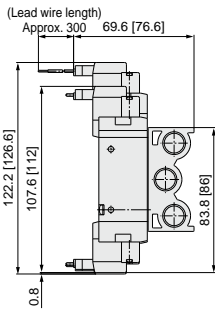
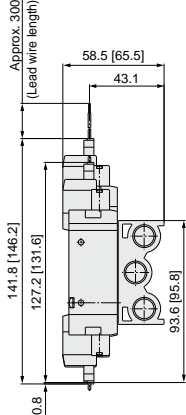

* Refer to page 375 for dimensions with connector cable.

Station	Station 2	3	4	5	6	7	8	9	10	11	12	13	14	15	16	17	18	19	Station 20
L1	66	85	104	123	142	161	180	199	218	237	256	275	294	313	332	351	370	389	408
L2	46	65	84	103	122	141	160	179	198	217	236	255	274	293	312	331	350	369	388

Directional Control Valves
 Air Cylinders
 Rotary Actuators
 Air Grippers
 Air Preparation Equipment
 Modular F. R.
 Pressure Control Equipment
 Fittings & Tubing
 Flow Control Equipment
 Pressure Switches/ Pressure Sensors

Type 40: Bottom Ported/10-SS5YJ7-40- Stations -01 □

* [] : AC

Grommet (G)

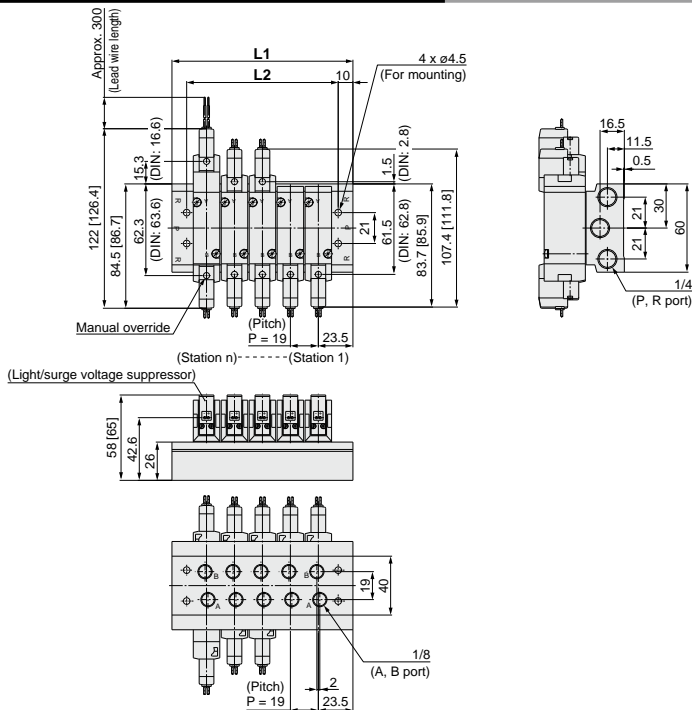

L plug connector (L)

M plug connector (M)

DIN terminal (D, Y)

M8 connector (WO)

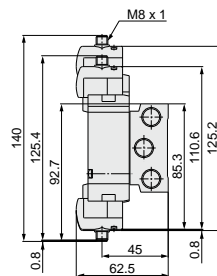
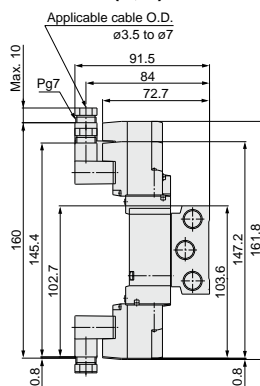
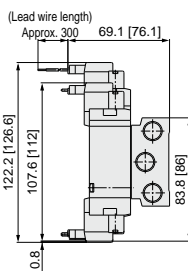
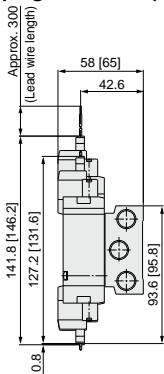

* Refer to page 375 for dimensions with connector cable.

Station	Station 2	3	4	5	6	7	8	9	10	11	12	13	14	15	16	17	18	19	Station 20
L1	66	85	104	123	142	161	180	199	218	237	256	275	294	313	332	351	370	389	408
L2	46	65	84	103	122	141	160	179	198	217	236	255	274	293	312	331	350	369	388

Type 41: Side Ported/10-SS5YJ7-41- Stations-01 □

* []: AC

Grommet (G)

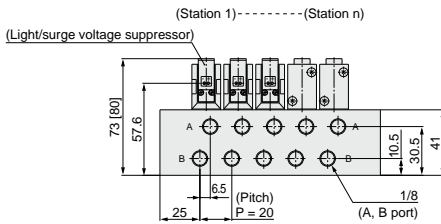
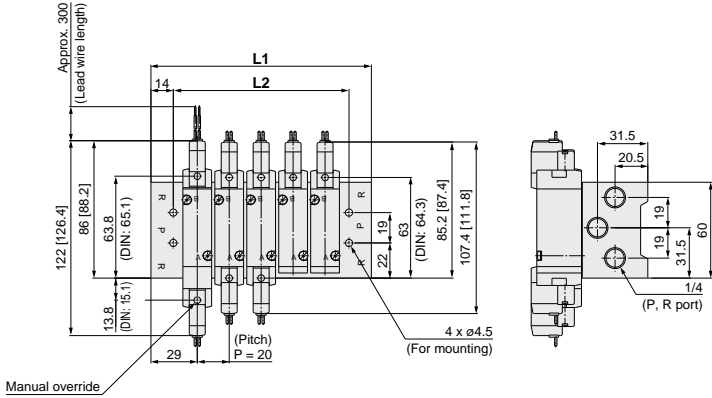

L plug connector (L)

M plug connector (M)

DIN terminal (D, Y)

M8 connector (WO)

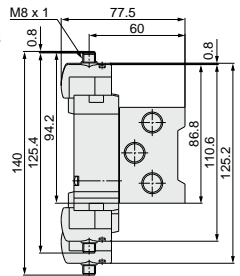
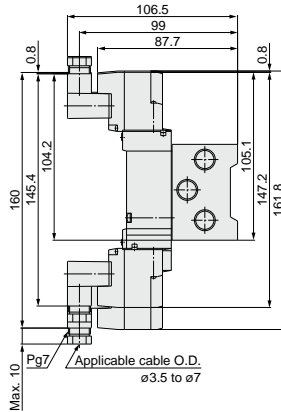
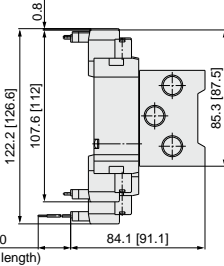
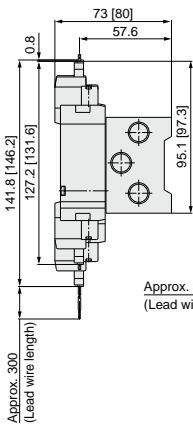

* Refer to 375 for dimensions with connector cable.

Station	Station 2	3	4	5	6	7	8	9	10	11	12	13	14	15	16	17	18	19	Station 20
L1	78	98	118	138	158	178	198	218	238	258	278	298	318	338	358	378	398	418	438
L2	50	70	90	110	130	150	170	190	210	230	250	270	290	310	330	350	370	390	410

Directional Control Valves

Air Cylinders

Rotary Actuators

Air Grippers

Air Preparation Equipment

Modular F. R.

Pressure Control Equipment

Fittings & Tubing

Flow Control Equipment

Pressure Switches/ Pressure Sensors

Type 42: Side Ported/10-SS5YJ7-42-**Stations**-**C6, N7**
C8, N9 □

* []: AC

Grommet (G)

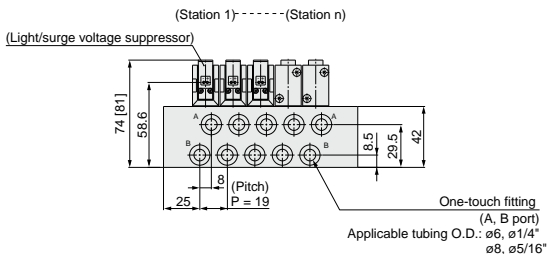
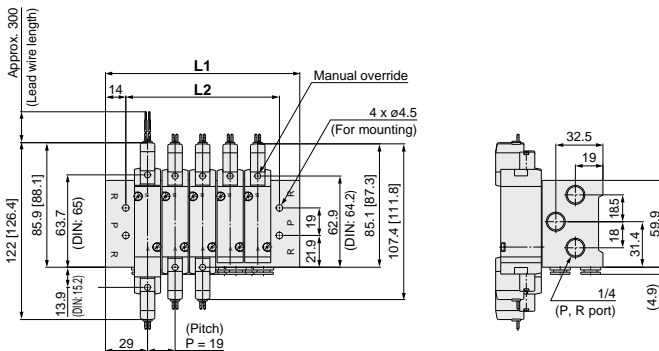

L plug connector (L)

M plug connector (M)

DIN terminal (D, Y)

M8 connector (WO)

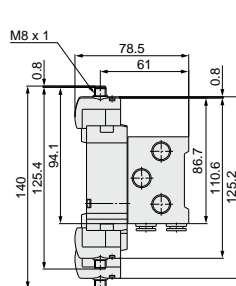
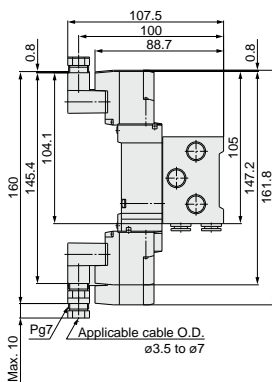
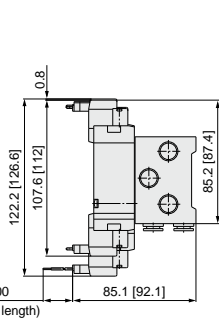
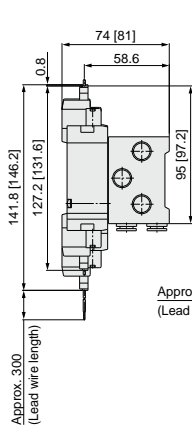

* Refer to page 375 for dimensions with connector cable.

Station	Station 2	3	4	5	6	7	8	9	10	11	12	13	14	15	16	17	18	19	Station 20
L1	77	96	115	134	153	172	191	210	229	248	267	286	305	324	343	362	381	400	419
L2	49	68	87	106	125	144	163	182	201	220	239	258	277	296	315	334	353	372	391

Flat Ribbon Cable Manifold

* []: AC

10-SS5YJ7-21P- Stations (—00□)

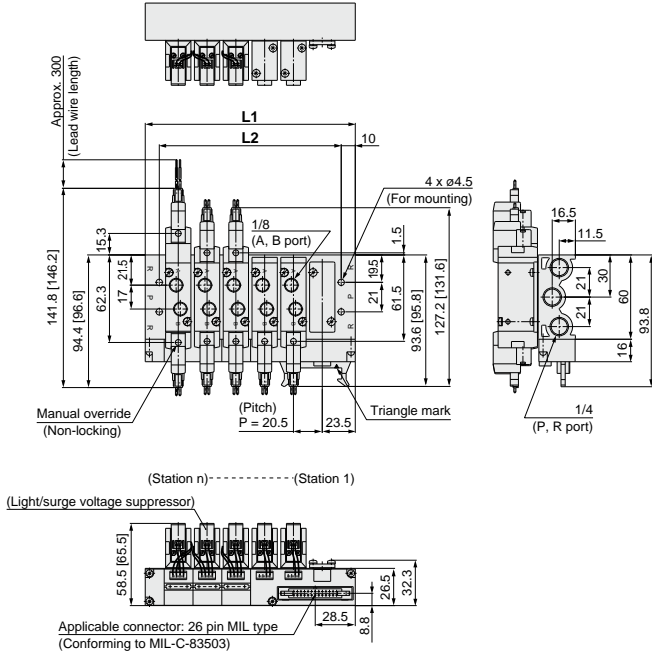

Built-in One-touch fitting

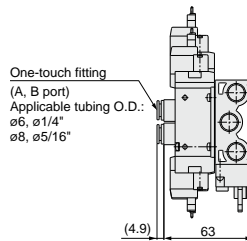

Station	Station 3	4	5	6	7	8	9	10	11	Station 12
L1	88	108.5	129	149.5	170	190.5	211	231.5	252	272.5
L2	68	88.5	109	129.5	150	170.5	191	211.5	232	252.5

EX510 Gateway-type Serial Transmission System

10-SS5YJ7-21SA□ - Stations □ - □

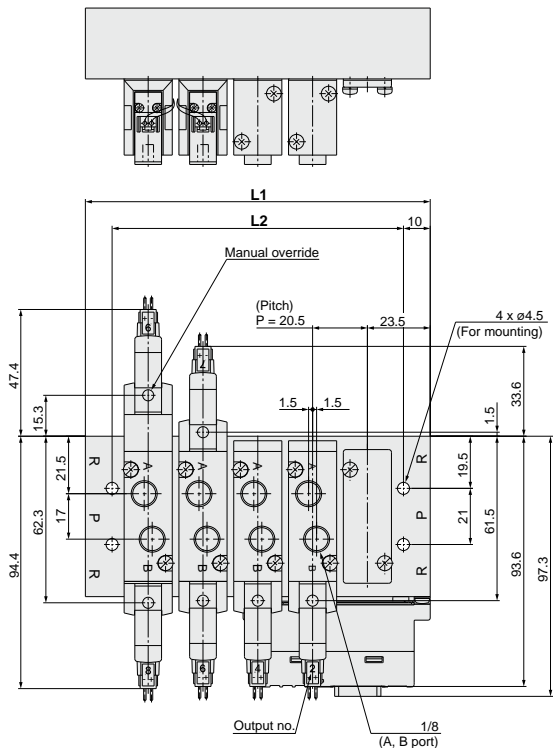

(Station n)----- (Station 1)

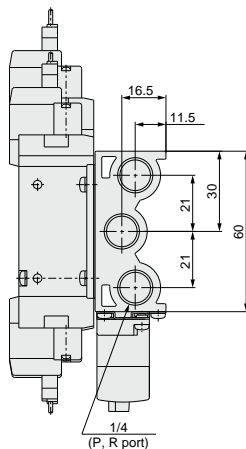
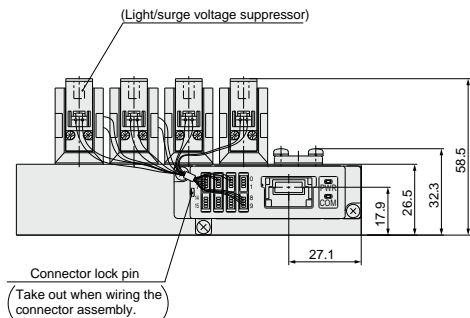

Built-in One-touch fitting

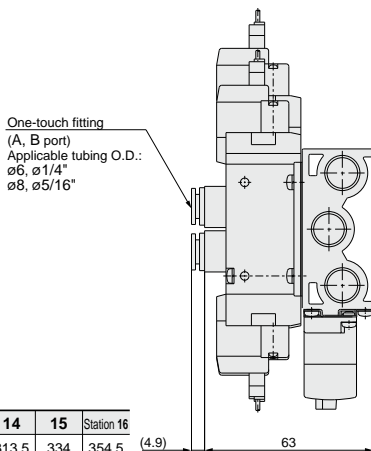

Station	Station 3	4	5	6	7	8	9	10	11	12	13	14	15	Station 16
L1	88	108.5	129	149.5	170	190.5	211	231.5	252	272.5	293	313.5	334	354.5
L2	68	88.5	109	129.5	150	170.5	191	211.5	232	252.5	273	293.5	314	334.5

EX510 Gateway-type Serial Transmission System

10-SS5YJ7-41SA□ - Stations -01□

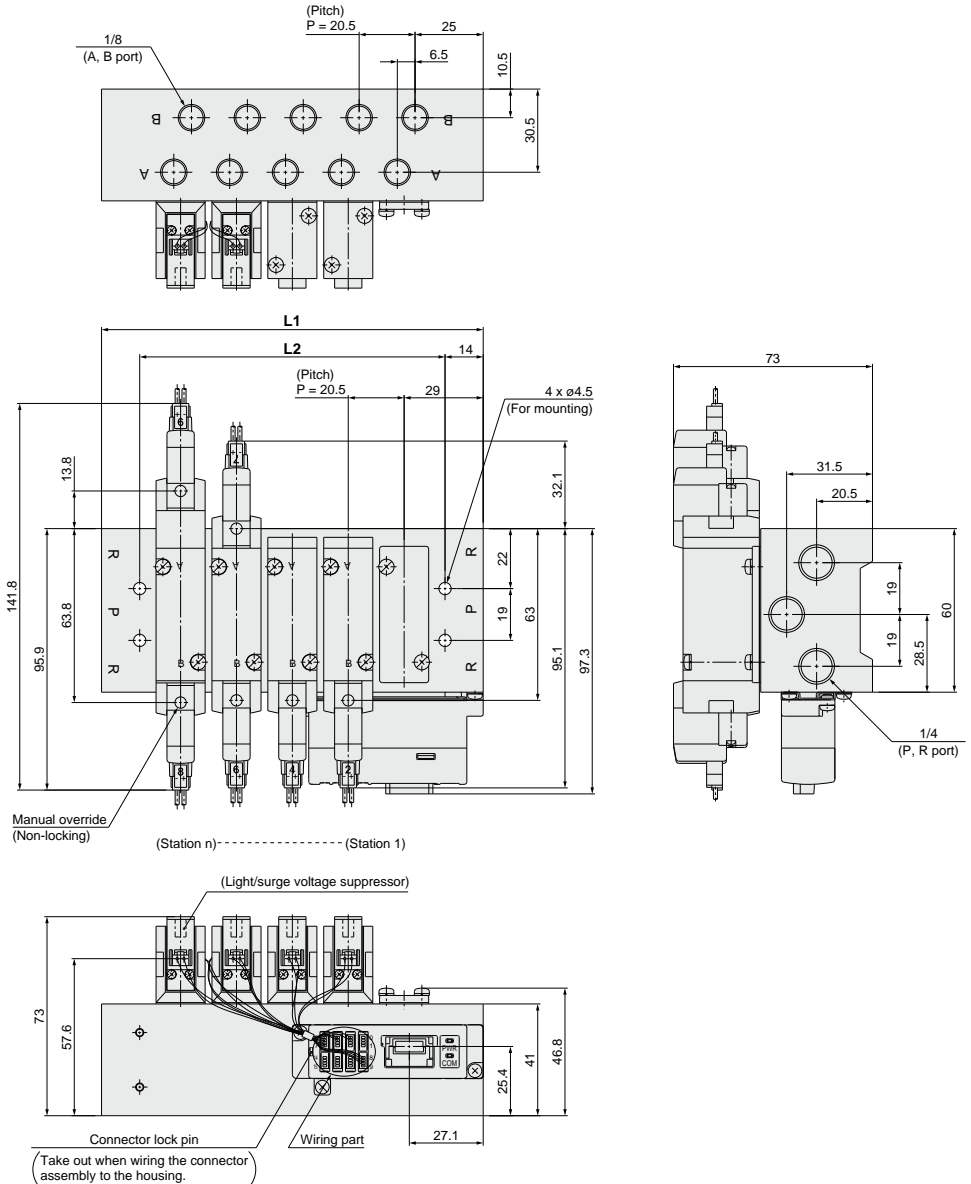

Station	Station 3	4	5	6	7	8	9	10	11	12	13	14	15	Station 16
L1	99	119.5	140	160.5	181	201.5	222	242.5	263	283.5	304	324.5	345	365.5
L2	71	91.5	112	132.5	153	173.5	194	214.5	235	255.5	276	296.5	317	337.5

Directional Control Valves

Air Cylinders

Rotary Actuators

Air Grippers

Air Preparation Equipment

Modular F. R.

Pressure Control Equipment

Fittings & Tubing

Flow Control Equipment

Pressure Switches/ Pressure Sensors



[Option]

How to Order Valve

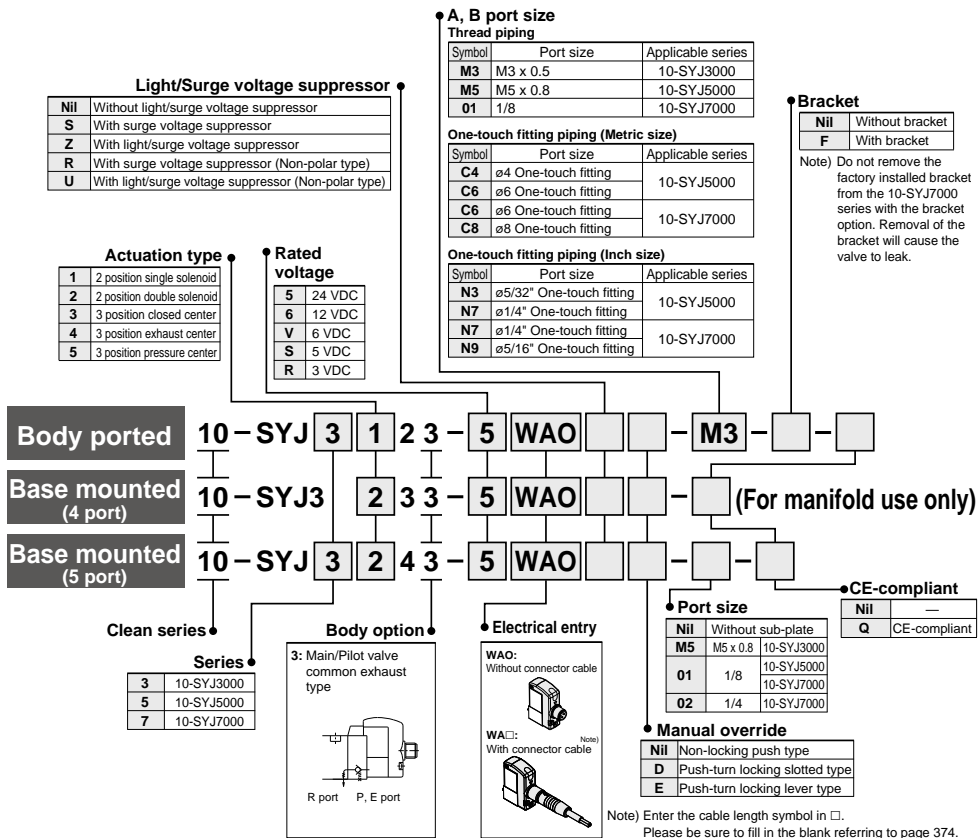

How to Order Pilot Valve Assembly

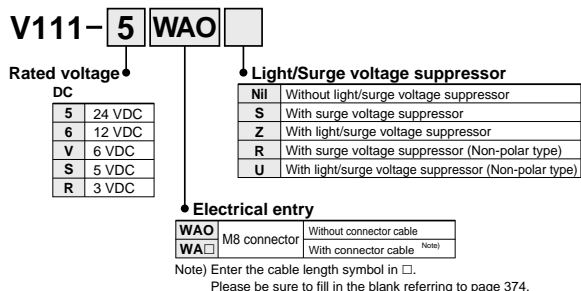

Note) Since V111 is CE-compliant as standard, the suffix "-Q" is not necessary.



Series 10-SYJ3000/5000/7000 Specific Product Precautions 1

Be sure to read this before handling.
Refer to page 1382 for Safety Instructions and pages 677 to 683 for 3/4/5 Port Solenoid Valve Precautions.

Manual Override Operation

Warning

When the manual override is operated, connected equipment will be actuated. Confirm safety before operating.

■ Non-locking push type [Standard]

Press in the direction of the arrow.



■ Push-turn locking slotted type [Type D]

While pressing the lock down, turn it in the direction of the arrow.
If it does not turn, it can be operated the same way as the non-locking type.

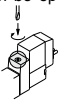

Locked position



Caution

When operating the locking type D with a screw driver, turn it gently using a watchmakers screw driver.
[Torque: Less than 0.1 N·m]

■ Push-turn locking lever type [Type E]

While pressing the lever down, turn it in the direction of the arrow.
If it does not turn, it can be operated the same way as the non-locking type.



Locked position



Caution

When locking the manual override on the push-turn locking types (D, E), be sure to push the lock down before turning it. Turning without first pushing it down can cause damage to the manual override and trouble such as air leakage, etc.

Solenoid Valve for 200, 220 VAC Specifications

Warning

Solenoid valves with grommet and L/M type plug connector AC specifications have a built-in rectifier circuit in the pilot section to operate the DC coil.

With 200, 220 VAC specification pilot valves, this built-in rectifier generates heat when energized. The surface may become hot depending on the energization state; therefore, do not touch the solenoid valves.

10-SYJ3000/5000/7000 Series Mixed Installation of 3 Port and 5 Port Valves on Same Manifold

Caution

The 10-SYJ3000/5000/7000 and 10-SYJ300/500/700 series can be mounted on the same manifold. How to mount on the same manifold is shown on the following pages.

10-SYJ3000, 10-SYJ300	P. 301
10-SYJ5000, 10-SYJ500	P. 330
10-SYJ7000, 10-SYJ700	P. 360

When using 4/5 port valves as a 3 port valve
The 10-SYJ3000/5000/7000/9000 series can be used as normally closed (N.C.) or normally open (N.O.) 3 port valves by closing one of the cylinder ports (A or B) with a plug. However, they should be used with the exhaust ports kept open. Can be used when a double solenoid, 3 port valve is required.

Plug position		B port	A port
Actuation type		N.C.	N.O.
Number of solenoids	Single		
	Double		

(Symbols above: Series 10-SYJ5000)

Directional Control Valves

Air Cylinders

Rotary Actuators

Air Grippers

Air Preparation Equipment

Modular F. R.

Pressure Control Equipment

Fittings & Tubing

Flow Control Equipment

Pressure Switches/ Pressure Sensors



Series 10-SYJ3000/5000/7000 Specific Product Precautions 2

Be sure to read this before handling.

Refer to page 1382 for Safety Instructions and pages 677 to 683 for 3/4/5 Port Solenoid Valve Precautions.

How to Use Plug Connector

⚠ Caution

1. Attaching and detaching connectors

- To attach a connector, hold the lever and connector unit between your fingers and insert straight onto the pins of the solenoid valve so that the lever's pawl is pushed into the groove and locks.
- To detach a connector, remove the pawl from the groove by pushing the lever downward with your thumb, and pull the connector straight out.

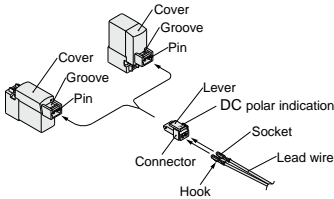

2. Crimping connection of lead wire and socket

Strip 3.2 to 3.7 mm at the end of the lead wires, insert the end of the core wires evenly into the sockets, and then crimp it with a crimping tool. When this is done, take care that the coverings of the lead wires do not enter the core wire crimping area.

Use an exclusive crimping tool for crimping.
(Please contact SMC for the dedicated crimping tools.)

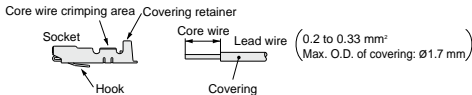

3. Attaching and detaching sockets with lead wires

• Attaching

Insert the sockets into the square holes of the connector (+, - indication), and continue to push the sockets all the way in until they lock by hooking into the seats in the connector. (When they are pushed in, the hooks open and they are locked automatically.) Then confirm that they are locked by pulling lightly on the lead wires.

• Detaching

To detach a socket from a connector, pull out the lead wire while pressing the socket's hook with a thin tipped stick (approx. 1 mm). If the socket is to be used again, first spread the hook outward.

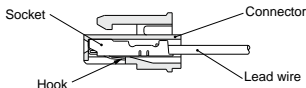

Plug Connector Lead Wire Length

⚠ Caution

Standard length is 300 mm, but the following lengths are also available.

How to Order Connector Assembly

For DC: **SY100-30-4A**

For 100 VAC: **SY100-30-1A**

For 200 VAC: **SY100-30-2A**

For other voltages of AC: **SY100-30-3A**

Without lead wire: **SY100-30-A**
(with connector and 2 of sockets only)

• Lead wire length

Nil	300 mm
6	600 mm
10	1000 mm
15	1500 mm
20	2000 mm
25	2500 mm
30	3000 mm
50	5000 mm

How to Order

Specify the part numbers of the solenoid valve without connector and the connector assembly with protective cover separately.

Example) Lead wire length 2000 mm

For DC 10-SYJ3120-5LO-M3 **For AC** 10-SYJ3120-1LO-M3
SY100-30-4A-20 SY100-30-1A-20



Series 10-SYJ3000/5000/7000 Specific Product Precautions 3

Be sure to read this before handling.
Refer to page 1382 for Safety Instructions and pages 677 to 683 for 3/4/5 Port Solenoid Valve Precautions.

Surge Voltage Suppressor

Caution

<For DC>
Grommet, L/M Plug Connector



■ Polar type (Standard)

With surge voltage suppressor (□S)

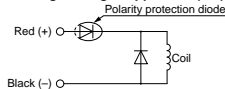

With light/surge voltage suppressor (□Z)

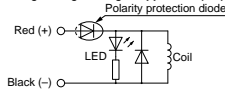

■ Non-polar type

With surge voltage suppressor (□R)

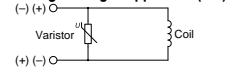

With light/surge voltage suppressor (□U)

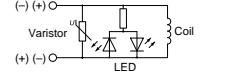

- Connect the polar type in accordance with the +, - polarity indication. (The non-polar type can be used with the connections made either way.)
- Since voltage specifications other than standard 24 and 12 VDC do not have diodes for polarity protection, be careful not to make errors in the polarity.
- When wiring is done at the factory, positive (+) is red and negative (-) is black.

■ With power saving circuit

Power consumption is decreased by 1/4 by reducing the wattage required to hold the valve in an energized state. (Effective energizing time is over 62 ms at 24 VDC.)

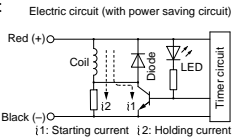

Operating Principle

With the above circuit, the current consumption when holding is reduced to save energy. Please refer to the electric wave data to the right.

- Please be careful not to reverse the polarity, since a diode to prevent the reversed current is not provided for the power saving circuit.

(The electric wave form of the energy saving 10-SYJ5□□0T)

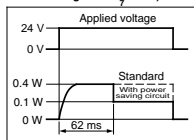

DIN Terminal



With surge voltage suppressor (DS)

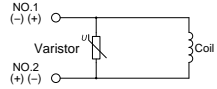

With light/surge voltage suppressor (DZ)

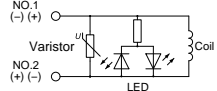

DIN terminal has no polarity.

M8 Connector

■ Polar type (Standard)

With surge voltage suppressor (□S)

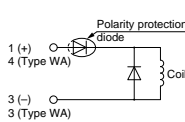

With light/surge voltage suppressor (□Z)

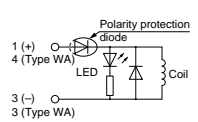

■ Non-polar type

With surge voltage suppressor (□R)

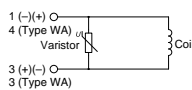

With light/surge voltage suppressor (□U)

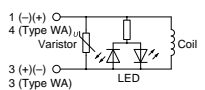

Solenoid valve side pin wiring diagram

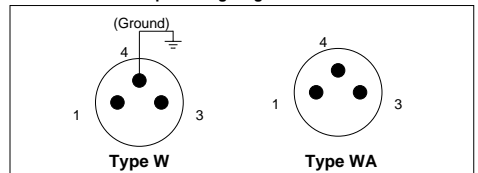

- For wiring of the polar type, connect + to 1 and - to 3 for type W, and + to 4 and - to 3 for type WA.
- Since voltage specifications other than standard 24 and 12 VDC do not have diodes for polarity protection, be careful not to make errors in the polarity.
- The WA-type valve cannot be grounded.

Directional Control Valves

Air Cylinders

Rotary Actuators

Air Grippers

Air Preparation Equipment

Modular F. R.

Pressure Control Equipment

Fittings & Tubing

Flow Control Equipment

Pressure Switches/ Pressure Sensors



Series 10-SYJ3000/5000/7000 Specific Product Precautions 4

Be sure to read this before handling.

Refer to page 1382 for Safety Instructions and pages 677 to 683 for 3/4/5 Port Solenoid Valve Precautions.

Surge Voltage Suppressor

<For AC>

(There is no "S" option, because the generation of surge voltage is prevented by a rectifier.)

Grommet, L/M Plug Connector

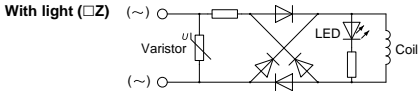

DIN Terminal

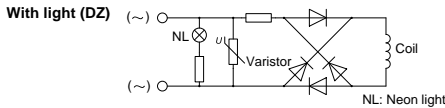

Note) The surge voltage suppressor of the varistor has residual voltage corresponding to the protective element and rated voltage. Therefore, protect the controller side from the surge voltage. The residual voltage of the diode is approximately 1 V.

DIN Terminal Type Y

- DIN connector type Y is a DIN connector that conforms to the DIN pitch 8-mm standard.
- D-type DIN connector with 9.4 mm pitch between terminals is not interchangeable.
- DIN connector except D-type has the "N" indication at the end of voltage symbol. (In case of DIN connector without light, "N" is not indicated. Please refer to the name plate to distinguish models.)
- Dimensions are the same as D-type DIN connector.
- When exchanging the pilot valve assembly only, V115-□D is interchangeable with V115-□Y. Do not replace V114 (G, H, L, M, W) with V115-□D/□Y (DIN terminal), and vice versa.

How to Use DIN Terminal

⚠ Caution

Connection

1. Loosen the holding screw and pull the connector out of the solenoid valve terminal block.
2. After removing the holding screw, insert a flat head screwdriver or similar object into the notch on the bottom of the terminal block and pry it open, separating the terminal block and the housing.
3. Loosen the terminal screws (slotted screws) on the terminal block, insert the cores of the lead wires into the terminals according to the connection method, and fasten them securely with the terminal screws.
4. Secure the cord by fastening the ground nut.

⚠ Caution

When making connections, take note that using other than the supported size ($\phi 3.5$ to $\phi 7$) heavy duty cord will not satisfy IP65 (enclosure) standards. Also, be sure to tighten the ground nut and holding screw within their specified torque ranges.

⚠ Caution

Changing the entry direction

After separating the terminal block and housing, the cord entry can be changed by attaching the housing in the desired direction 373

How to Use DIN Terminal

(4 directions at 90° intervals).

* If equipped with a light, be careful not to damage the light with the cord's lead wires.

Precautions

Plug in and pull out the connector vertically without tilting to one side.

Compatible cables

Cord O.D.: $\phi 3.5$ to $\phi 7$

(Reference) 0.5 mm², 2-core or 3-core, equivalent to JIS C 3306

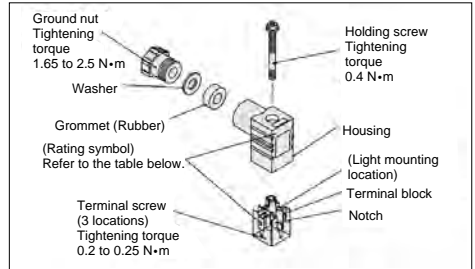

DIN Connector Part No.

⚠ Caution

<Type D>

Without light		SY100-61-1
With light		
Rated voltage	Voltage symbol	Part no.
24 VDC	24V	SY100-61-3-05
12 VDC	12V	SY100-61-3-06
100 VAC	100V	SY100-61-2-01
200 VAC	200V	SY100-61-2-02
110 VAC	110V	SY100-61-2-03
220 VAC	220V	SY100-61-2-04

< Type Y >

Without light		SY100-82-1
With light		
Rated voltage	Voltage symbol	Part no.
24 VDC	24VN	SY100-82-3-05
12 VDC	12VN	SY100-82-3-06
100 VAC	100VN	SY100-82-2-01
200 VAC	200VN	SY100-82-2-02
110 VAC (115 VAC)	110VN	SY100-82-2-03
220 VAC (230 VAC)	220VN	SY100-82-2-04

Circuit Diagram with Light

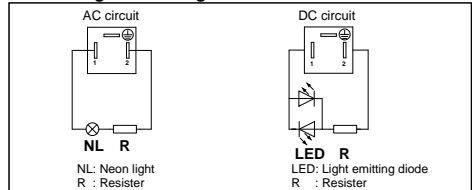



Series 10-SYJ3000/5000/7000 Specific Product Precautions 6

Be sure to read this before handling.
Refer to page 1382 for Safety Instructions and pages 677 to 683 for 3/4/5 Port Solenoid Valve Precautions.

M8 Connector

2. To order connector cable only

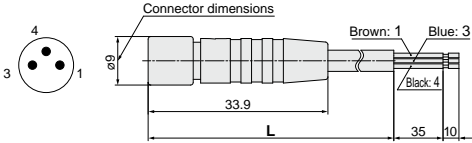

Cable length (L)	Part no.
300 mm	V100-49-1-1
500 mm	V100-49-1-2
1000 mm	V100-49-1-3
2000 mm	V100-49-1-4
5000 mm	V100-49-1-7

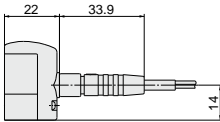

Flat Ribbon Cable Manifold

Caution

Type 21P

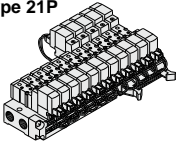

Type 32P

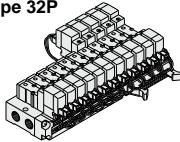

- In the manifold valves, the wiring to the individual valves is provided on a printed circuit board, and the connection to the external wires is consolidated through the use of a flat ribbon cable.
- A single MIL type flat ribbon cable connects the entire manifold to your power source. This greatly reduces installation time.

Flat Ribbon Cable Manifold

Manifold Internal Wiring

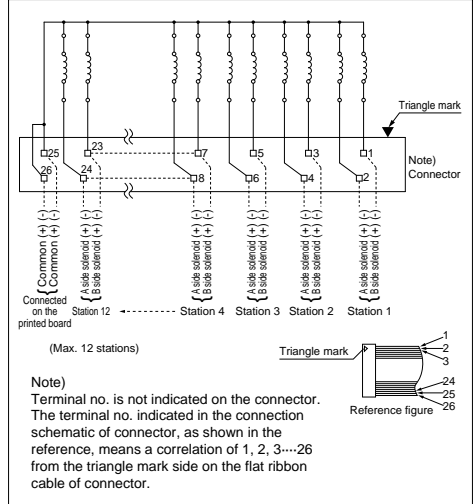

- For more than 10 stations, both poles of the common should be wired.
- For single solenoid, connect to the B side solenoid.
- The maximum number of stations that can be accommodated is 12. For more stations, contact SMC.
- Only non-polar valves are available for the DC flat ribbon cable manifold, therefore negative COM or positive COM wiring of the manifold is possible. The valve does not switch with negative COM if a Z type is used. Be sure to use a positive COM.

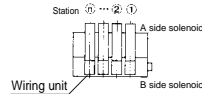



Series 10-SYJ3000/5000/7000 Specific Product Precautions 7

Be sure to read this before handling.

Refer to page 1382 for Safety Instructions and pages 677 to 683 for 3/4/5 Port Solenoid Valve Precautions.

EX510 Gateway-type Serial Transmission System

When ordering the connector assembly only

For single solenoid (SY3000-37-81A-□-N)

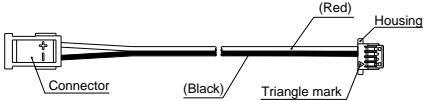

For double solenoid (SY3000-37-81A-□-□)

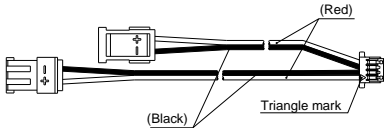

Connector Assembly Order No.

(Can be used for the manifold without a specified layout (8 stations or less))

Model	Part no.	Connector mounting position
10-SS5YJ3- ²⁰ / ₃₂ SA	SY3000-37-81A-2-N	Single : For 1 to 4 stations
	SY3000-37-81A-2-5	Double/3 position: For 1 to 4 stations
	SY3000-37-81A-1-N	Single : For 5 to 8 stations
10-SS5YJ5- ²⁰ / ₄₃ SA	SY3000-37-81A-1-4	Double/3 position: For 5 to 8 stations
	SY3000-37-81A-2-N	Single : For 1 to 8 stations
	SY3000-37-81A-2-5	Double/3 position: For 1 to 8 stations
10-SS5YJ7- ²⁰ / ₄₃ SA	SY3000-37-81A-3-N	Single : For 1 to 8 stations
	SY3000-37-81A-3-6	Double/3 position: For 1 to 4 stations
	SY3000-37-81A-3-7	Double/3 position: For 5 to 8 stations

Note) The above is for the station addition or maintenance. When ordering a connector assembly separately, the number is not printed on the connector.

When ordering connector assembly (except housing)

SY3000-37-80A-□

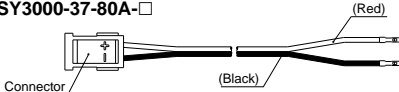

Connector Assembly Order No.

(Can be used for the manifold with a specified layout)

Model	Part no.	Connector mounting position
10-SS5YJ3- ²¹ / ₃₂ SA	SY3000-37-80A-5	For A side
	SY3000-37-80A-2	For B side
	SY3000-37-80A-7	For A side
	SY3000-37-80A-4	For B side
10-SS5YJ5- ²⁰ / ₄₃ SA	SY3000-37-80A-5	For A side
	SY3000-37-80A-2	For B side
	SY3000-37-80A-7	For A side
	SY3000-37-80A-4	For B side
10-SS5YJ7- ²¹ / ₄₃ SA	SY3000-37-80A-9	For A side
	SY3000-37-80A-7	For B side
	SY3000-37-80A-7	For A side
	SY3000-37-80A-3	For B side
	SY3000-37-80A-10	For A side
	SY3000-37-80A-6	For B side
	SY3000-37-80A-12	For A side
	SY3000-37-80A-9	For B side

Note 1) The above is for station addition or maintenance. When ordering a connector assembly separately, the number is not printed on the connector.

Note 2) After inserting the connector assembly into the housing, be sure to confirm that the lead wire will not come off by tightly pulling the wire. Furthermore, do not reuse the lead wire after it has been inserted and removed.

Note 3) Wiring is set longer than the actual wiring distance.

When ordering the housing only

SY3000-44-3A (8 pcs/set)

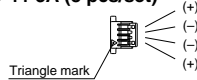

Bracket

Caution

For bracket attached types of 10-SYJ3000 (Single) and 10-SYJ7000, do not use it without bracket.

Solenoid Valve Mounting

Caution

Mount so that there is no slippage or deformation in gaskets, and tighten with the tightening torque as shown below.

Series	Thread size	Tightening torque
10-SYJ3000	M1.7	0.12 N·m
10-SYJ5000	M2.5	0.45 N·m
10-SYJ7000	M3	0.8 N·m

Replacement of Pilot Valve

Caution

Pilot valves in this series are improved to provide excellent energy saving results. However following this improvement, these new valves are no longer compatible with the existing pilot valve used at the interface. Consult with SMC if you need to exchange these pilot valves, for manual override (marked in orange) of the adapter plate.

New valve

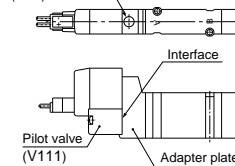
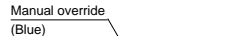

Existing valve

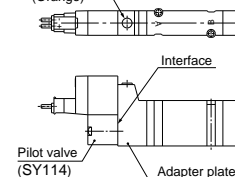
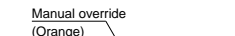

Directional Control Valves

Air Cylinders

Rotary Actuators

Air Grippers

Air Preparation Equipment

Modular F. R.

Pressure Control Equipment

Fittings & Tubing

Flow Control Equipment

Pressure Switches/ Pressure Sensors

Series 10-SZ3000 5 Port Solenoid Valve Cassette Type Manifold

Series 10-SZ3000 / Plug-in Type



Model		D-sub connector Type 60F	Flat ribbon cable type 60P□		
			Type 60P	Type 60PG	Type 60PH
Manifold		Plug-in type			
1 (P: SUP), 3/5 (R: EXH)		Common SUP, EXH			
Valve stations (With power terminal)		2 to 20 stations		2 to 16 stations	2 to 8 stations
Applicable connector		D-sub connector Conforming to MIL-C-24308 JIS-X-5101	Flat ribbon cable connector Socket: 26 pin MIL type with strain relief Conforming to MIL-C-83503	Flat ribbon cable connector Socket: 20 pin MIL type with strain relief Conforming to MIL-C-83503	Flat ribbon cable connector Socket: 10 pin MIL type with strain relief Conforming to MIL-C-83503
Internal wiring		+COM, -COM			
4(A), 2(B) port Porting specifications	Location	Valve			
	Direction	Lateral, Upward, Downward			
Port size	Metric	1(P), 3/5(R) port: ø8		4(A), 2(B) port: M5, ø4, ø6	
	Inch	1(P), 3/5(R) port: ø5/16"		4(A), 2(B) port: ø5/32", ø1/4"	

Series 10-SZ3000 / Non Plug-in Type



Model		Type 10-SS5Z3-60	
Manifold		Non plug-in type	
1 (P: SUP), 3/5 (R: EXH)		Common SUP, EXH	
Valve stations		2 to 20 stations	
4(A), 2(B) port Porting specifications	Location	Valve	
	Direction	Lateral, Upward, Downward	
Port size	Metric	1(P), 3/5(R) port: ø8	
	Inch	1(P), 3/5(R) port: ø5/16"	
		4(A), 2(B) port: M5, ø4, ø6	
		4(A), 2(B) port: ø5/32", ø1/4"	

Series 10-SZ3000 / Serial Transmission Type



Protocol type	CE-compliant
NKE Corp.: Fieldbus System	—
NKE Corp.: Fieldbus H System	—
Panasonic Industrial Devices SUNX Co., Ltd.: S-LINK (16 outputs)	—
Panasonic Industrial Devices SUNX Co., Ltd.: S-LINK (8 outputs)	—
DeviceNet™	○
OMRON Corp.: CompoBus/S (16 outputs)	○
OMRON Corp.: CompoBus/S (8 outputs)	○
CC-Link	○

Series 10-SZ3000

5 Port Solenoid Valve
Plug-in Type



How to Order

An order cannot be placed with only the manifold part no. Be sure to order solenoid valves for mounting at the same time while referring to the ordering example.

• Plug-in manifold with power supply terminal

10-SS5Z3-60 F D 1 - 05 U - P - - -

• Clean series

• CE-compliant

Nil	—
Q	CE-compliant

• Connector type

F: D-sub connector (25 pins)

P: Flat ribbon cable (26 pins)

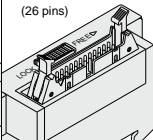
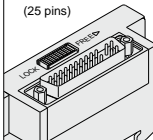

PG: Flat ribbon cable (20 pins)

PH: Flat ribbon cable (10 pins)

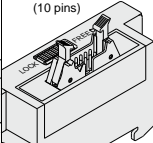
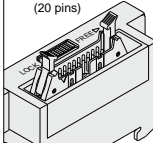

SUP/EXH block mounting position

U	U side (2 to 10 stations)
D	D side (2 to 10 stations)
B	Both sides (2 to 20 stations)
M*	Special specifications

* For special specifications, indicate separately with the manifold specification sheet.
Note) A total of up to 3 SUP/EXH blocks can be mounted. Please contact SMC if 4 or more will be mounted.

• Option

When a longer DIN rail is desired than the specified stations, specify the station number to be required.

• Power supply terminal

Symbol	Specifications
P	24 VDC, Positive common
P12	12 VDC, Positive common
N	24 VDC, Negative common
N12	12 VDC, Negative common

• SUP/EXH block fitting type

Nil	Straight
L	Elbow (Upward)
B	Elbow (Downward)

• Pilot type

Nil	Internal pilot
R	External pilot

• Valve stations

F: D-sub connector

Symbol	Stations	Note
02	2 stations	Double wiring ^{Note 1)}
∴	∴	
10	10 stations	Specified layout ^{Note 2)} (Up to 21 solenoids possible)
02	2 stations	
∴	∴	
20	20 stations	

P: Flat ribbon cable connector (26 pins)

Symbol	Stations	Note
02	2 stations	Double wiring
∴	∴	
11	11 stations	Specified layout (Up to 22 solenoids possible)
02	2 stations	
∴	∴	
20	20 stations	

• Connector mounting position

Symbol	Mounting position
D	D side

• Connector entry direction

1: Perpendicular connector 2: Lateral connector

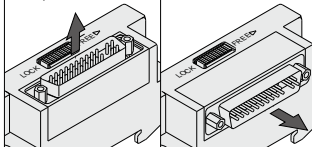

PG: Flat ribbon cable connector (20 pins)

Symbol	Stations	Note
02	2 stations	Double wiring
∴	∴	
08	8 stations	Specified layout (Up to 16 solenoids possible)
02	2 stations	
∴	∴	
16	16 stations	

PH: Flat ribbon cable connector (10 pins)

Symbol	Stations	Note
02	2 stations	Double wiring
∴	∴	
04	4 stations	Specified layout (Up to 8 solenoids possible)
02	2 stations	
∴	∴	
08	8 stations	

Note 1) Double wiring: Single, double, 3 position and 4 position solenoid valves can be used at all of the manifold stations.

Note 2) Specified layout: Indicate wiring specifications on the manifold specification sheet.

(Note that double, 3 position and 4 position valves cannot be used where single solenoid wiring has been specified.)

Directional Control Valves

Air Cylinders

Rotary Actuators

Air Grippers

Air Preparation Equipment

Modular F. R.

Pressure Control Equipment

Fittings & Tubing

Flow Control Equipment

Pressure Switches/ Pressure Sensors



An order cannot be placed with only the manifold part no. Be sure to order solenoid valves for mounting at the same time while referring to the ordering example.

How to Order

• Plug-in manifold without power supply terminal

10-SS5Z3-60 F D 1 - 05 U - - -

• Clean series

• CE-compliant

Nil	—
Q	CE-compliant

• Connector type

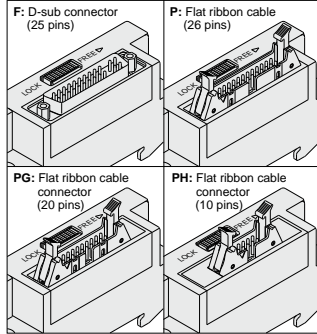

• SUP/EXH block mounting position

U	U side (2 to 10 stations)
D	D side (2 to 10 stations)
B	Both sides (2 to 20 stations)
M*	Special specifications

* For special specifications, indicate separately with the manifold specification sheet.
 (Note) A total of up to 3 SUP/EXH blocks can be mounted. Please contact SMC if 4 or more will be mounted.

• Option

When a longer DIN rail is desired than the specified stations, specify the station number to be required.

• SUP/EXH block fitting type

Nil	Straight
L	Elbow (Upward)
B	Elbow (Downward)

• Pilot type

Nil	Internal pilot
R	External pilot

• Valve stations

• Connector mounting position

Symbol	Mounting position
D	D side

• Connector entry direction

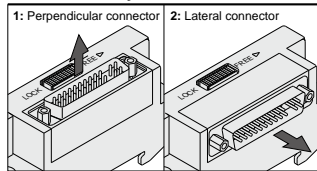

F: D-sub connector

Symbol	Stations	Note
02	2 stations	Double wiring ^{Note 1)}
:	:	
12	12 stations	
02	2 stations	Specified layout ^{Note 2)} (Up to 24 solenoids possible)
:	:	
20	20 stations	

P: Flat ribbon cable connector (26 pins)

Symbol	Stations	Note
02	2 stations	Double wiring
:	:	
12	12 stations	
02	2 stations	Specified layout (Up to 25 solenoids possible)
:	:	
20	20 stations	

PG: Flat ribbon cable connector (20 pins)

Symbol	Stations	Note
02	2 stations	Double wiring
:	:	
09	9 stations	
02	2 stations	Specified layout (Up to 19 solenoids possible)
:	:	
19	19 stations	

PH: Flat ribbon cable connector (10 pins)

Symbol	Stations	Note
02	2 stations	Double wiring
:	:	
04	4 stations	
02	2 stations	Specified layout (Up to 9 solenoids possible)
:	:	
09	9 stations	

Note 1) Double wiring: Single, double, 3 position and 4 position solenoid valves can be used at all of the manifold stations.

Note 2) Specified layout: Indicate wiring specifications on the manifold specification sheet.

(Note that double, 3 position and 4 position valves cannot be used where single solenoid wiring has been specified.)



How to Order

• How to order solenoid valve For plug-in (Common for both with and without power supply terminals)

10 - SZ3 1 60 [] [] - 5 [] [] LOZ [] [] - C6 - []

• Clean series

Actuation type

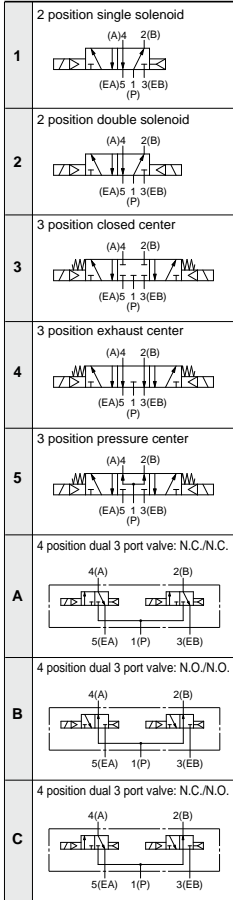

Rated voltage

5	24 VDC
6	12 VDC

• When using on a manifold with power supply terminals, be sure to match with the manifold's voltage specifications.

Back pressure check valve

Nil	None
K	Built-in

• The built-in back pressure check valve type has an effective area approximately 20% smaller.
• The product with back pressure check valve is not available for 3 position solenoid valves.

Pilot type

Nil	Internal pilot
R	External pilot

• External pilot specifications are not available for 4 position dual 3 port valves.

Switch

Nil: Without switch

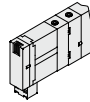

J: With switch

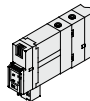

* For switch operation, refer to page 412.

Common specifications

Nil	Positive common
N	Negative common

• When using on a manifold with power supply terminals, be sure to match with the manifold's common specifications.

Manual override

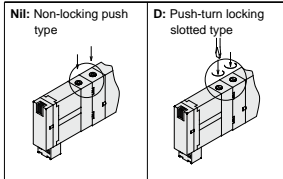

CE-compliant

Nil	—
Q	CE-compliant

A, B port size

C4: ø4 One-touch fitting
C6: ø6 One-touch fitting
N3: ø5/32" One-touch fitting
N7: ø1/4" One-touch fitting



M5: M5 x 0.8



Elbow fitting assembly (Upward)

L4: ø4 elbow fitting assembly
L6: ø6 elbow fitting assembly



Elbow fitting assembly (Downward)

B4: ø4 elbow fitting assembly
B6: ø6 elbow fitting assembly

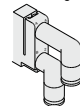

Directional Control Valves

Air Cylinders

Rotary Actuators

Air Grippers

Air Preparation Equipment

Modular F. R.

Pressure Control Equipment

Fittings & Tubing

Flow Control Equipment

Pressure Switches/ Pressure Sensors

How to Order Valve Manifold Assembly

Ordering example (10-SZ3000, positive common with power supply terminals)

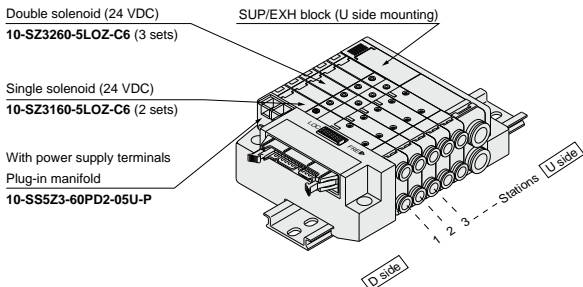

10-SS5Z3-60PD2-05U-P 1 set (Manifold part no.)
 * 10-SZ3160-5LOZ-C6 2 sets (Single solenoid part no.)
 * 10-SZ3260-5LOZ-C6 3 sets (Double solenoid part no.)

The asterisk denotes the symbol for assembly.
 Prefix to the part no. of the solenoid valve, etc.

Stations are counted from the D side as the 1st one.
 Add the valve part number under the manifold part number.
 For complex arrangements, specify them on the manifold specification sheet.



Made to Order
 (For details, refer to page 411.)

Manifold Specifications

Model	D-sub connector Type 60F	Flat ribbon cable type 60P□		
		Type 60P	Type 60PG	Type 60PH
Manifold	Plug-in type			
1 (P: SUP), 3/5 (R: EXH)	Common SUP, EXH			
Valve stations (With power terminal)	2 to 20 stations	2 to 16 stations	2 to 8 stations	
Applicable connector	D-sub connector Conforming to MIL-C-24308 JIS-X-5101	Flat ribbon cable connector Socket: 26 pin MIL type with strain relief Conforming to MIL-C-83503	Flat ribbon cable connector Socket: 20 pin MIL type with strain relief Conforming to MIL-C-83503	Flat ribbon cable connector Socket: 10 pin MIL type with strain relief Conforming to MIL-C-83503
Internal wiring	+COM, -COM			
4(A), 2(B) port	Location	Valve		
Porting specifications	Direction	Lateral, Upward, Downward		
Port size	Metric	1(P), 3/5(R) port: ø8	4(A), 2(B) port: M5, ø4, ø6	
	Inch	1(P), 3/5(R) port: ø5/16"	4(A), 2(B) port: ø5/32", ø1/4"	
Weight W (g) ^{Note 2)} (n1: Stations n2: Number of SUP/EXH blocks m: Weight of DIN rail)	W = 3.2n1 + 53n2 + m + 126.5			

Note 1) In cases such as those where many valves are operated simultaneously, use type B (double side SUP/EXH), applying pressure to the 1(P) ports on both sides and exhausting from the 3(R) ports on both sides.

Note 2) The weight W is the value for the D-sub connector manifold with power supply terminals only. To obtain the weight with solenoid valves attached, add the solenoid valve weights given on page 382 for the appropriate number of stations. For DIN rail weight, refer to page 384.

Flow Rate Characteristics

Port size		Flow rate characteristics					
1, 5, 3 (P, EA, EB)	4, 2 (A, B)	1 → 2/4 (P → A/B)			4/2 → (A/B → R)		
		C [dm ³ /(s·bar)]	b	Cv	C [dm ³ /(s·bar)]	b	Cv
C8	C4	0.58 [0.49]	0.26 [0.36]	0.14 [0.13]	0.76 [0.65]	0.15 [0.20]	0.18 [0.15]
	C6	0.73 [0.64]	0.24 [0.27]	0.18 [0.16]	0.77 [0.74]	0.19 [0.16]	0.19 [0.19]
	M5	0.60 [0.57]	0.38 [0.35]	0.17 [0.15]	0.67 [0.58]	0.16 [0.39]	0.16 [0.16]

Note) - The values are for individually operated 2 position type manifold bases with 5 stations.

- Values inside [] are for 4 position dual 3 port valves.

Solenoid Valve Specifications

Series		10-SZ3000	
Fluid		Air	
Internal pilot operating pressure range (MPa)	2 position single	0.15 to 0.7	
	2 position double	0.1 to 0.7	
	3 position	0.2 to 0.7	
	4 position dual 3 port valve	0.15 to 0.7	
Operating pressure range		-100 kPa to 0.7	
External pilot operating pressure range (MPa)	Pilot pressure range	2 position single	0.25 to 0.7
		2 position double	0.25 to 0.7
		3 position	0.25 to 0.7
Ambient and fluid temperature (°C)		-10 to 50 (No freezing. Refer to page 680.)	
Max. operating frequency (Hz)	2 position single, double	10	
	4 position dual 3 port valve		
	3 position	3	
Manual override (Manual operation)		Non-locking push type, Push-turn locking slotted type	
Pilot type		Main/Pilot valve common exhaust	
Lubrication		Not required	
Mounting orientation		Unrestricted	
Impact/Vibration resistance (m/s ²) ^(Note)		150/30	
Enclosure		Dust proof	

Note) Impact resistance: No malfunction occurred when it was tested with a drop tester in the axial direction and at right angles to the main valve and armature in both energized and de-energized states once for each condition. (Default settings)

Vibration resistance: No malfunction occurred in a one-sweep test between 45 and 2000 Hz. Test was performed in both energized and de-energized states in the axial direction and at right angles to the main valve and armature. (Default settings)

Solenoid Specifications

Electrical entry	L type (For plug-in), M type plug connector (M)
Coil rated voltage (V) ^(Note)	24, 12 VDC
Allowable voltage fluctuation	±10% of rated voltage
Power consumption (W)	0.6 (With light: 0.65)
Surge voltage suppressor	Diode
Indicator light	LED

Response Time

Note) Based on dynamic performance test, JIS B 8375-1981. (Coil temperature: 20°C, at rated voltage)

Actuation type	Response time (ms) (at the pressure of 0.5 MPa)	
	Without surge voltage suppressor	With surge voltage suppressor S, Z type
2 position single	12 or less	15 or less
2 position double	10 or less	13 or less
3 position	15 or less	20 or less
4 position dual 3 port valve	30 or less	35 or less

Weight

Valve model	Actuation type		Port size	Weight (g)	
			4(A), 2(B)		
10-SZ3□60□□-□C4 N3	2 position	Single	C4 N3 (One-touch fitting)	78	
		Double		84	
	3 position	Closed center		88	88
		Exhaust center			
		Pressure center			
	4 position	Dual 3 port valve		84	
10-SZ3□60□□-□C6 N7	2 position	Single	C6 N7 (One-touch fitting)	74	
		Double		81	
	3 position	Closed center		85	85
		Exhaust center			
		Pressure center			
	4 position	Dual 3 port valve		81	
10-SZ3□60□□-□M5	2 position	Single	M5 x 0.8	69	
		Double		75	
	3 position	Closed center		79	79
		Exhaust center			
		Pressure center			
	4 position	Dual 3 port valve		75	

Manifold Option

■SUP block disk

By installing a SUP block disk in the pressure supply passage of a manifold valve, it is possible to supply two or more different high and low pressures to one manifold. (Use in combination with a pilot port block disk.)



Series	Part no.
10-SZ3000	SZ3000-114-4A

■EXH block disk

By installing an EXH block disk in the exhaust passage of a manifold valve, it is possible to divide the valve's exhaust so that it does not affect another valve. (Two block disks are needed to divide both exhausts.)



Series	Part no.
10-SZ3000	SZ3000-114-4A

■Pilot port block disk

By installing a pilot port block disk in the pilot passage of a manifold valve, it can be function as an internal pilot/external pilot mixed manifold. (Use in combination with a SUP or EXH block disk.)



Series	Part no.
10-SZ3000	SZ3000-114-2A

■Blanking block assembly SZ3000-55-1A

These are mounted when later addition of valves is planned, etc.

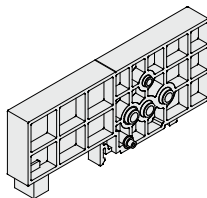

■Plug (White)

These are inserted in unused cylinder ports or SUP/EXH ports. Purchase orders are available in units of 10 pieces.

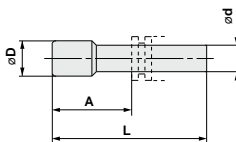

Dimensions

Applicable fitting size ϕd	Model	A	L	D
4	10-KQP-04	16	32	$\phi 6$
6	10-KQP-06	18	35	$\phi 8$
8	10-KQP-08	20.5	39	$\phi 10$
5/32"	10-KQP-03	16	32	$\phi 6$
1/4"	10-KQP-07	18	35	$\phi 8.5$
5/16"	10-KQP-09	20.5	39	$\phi 10$

Manifold Option

■DIN rail dimensions / Weight

VZ1000-11-1-□

Refer to the L dimension tables
* Enter a number from the DIN rail dimension table below.

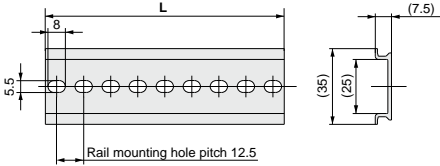

No.	0	1	2	3	4	5	6	7	8	9
L dimension	98	110.5	123	135.5	148	160.5	173	185.5	198	210.5
Weight (g)	17.6	19.9	22.1	24.4	26.6	28.9	31.1	33.4	35.6	37.9

No.	10	11	12	13	14	15	16	17	18	19
L dimension	223	235.5	248	260.5	273	285.5	298	310.5	323	335.5
Weight (g)	40.1	42.4	44.6	46.9	49.1	51.4	53.6	55.9	58.1	60.4

■Flat ribbon cable type / Cable assembly

AXT100-FC□-to-□

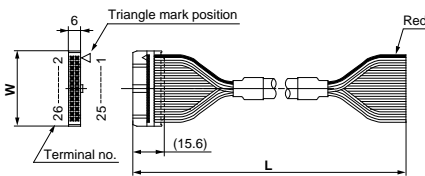

Flat Ribbon Cable Assembly

Cable length (L)	10 pins	20 pins	26 pins
1.5 m	AXT100-FC10-1	AXT100-FC20-1	AXT100-FC26-1
3 m	AXT100-FC10-2	AXT100-FC20-2	AXT100-FC26-2
5 m	AXT100-FC10-3	AXT100-FC20-3	AXT100-FC26-3
Connector width (W)	17.2	30	37.5

* For other commercial connectors, use a type with strain relief conforming to MIL-C-83503.

Example of connector manufacturers

- HIROSE ELECTRIC CO., LTD.
- Japan Aviation Electronics Industry, Limited
- 3M Japan Limited
- J.S.T. Mfg. Co., Ltd.
- Fujitsu Limited

■D-sub connector (25 pins) / Cable assembly

AXT100-DS25-015
030
050

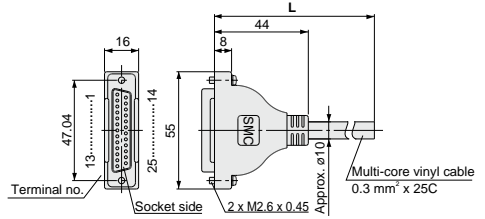

D-sub Connector Cable Assembly Terminal No.

Terminal no.	Lead wire color	Dot marking
1	Black	None
2	Brown	None
3	Red	None
4	Orange	None
5	Yellow	None
6	Pink	None
7	Blue	None
8	Purple	White
9	Gray	Black
10	White	Black
11	White	Red
12	Yellow	Red
13	Orange	Red
14	Yellow	Black
15	Pink	Black
16	Blue	White
17	Purple	None
18	Gray	None
19	Orange	Black
20	Red	White
21	Brown	White
22	Pink	Red
23	Gray	Red
24	Black	White
25	White	None

D-sub Connector Cable Assembly

Cable length (L)	Assembly part no.	Note
1.5 m	AXT100-DS25-015	Cable 25 cores x 24AWG
3 m	AXT100-DS25-030	
5 m	AXT100-DS25-050	

* For other commercial connectors, use a 25 pin type with female connector conforming to MIL-C-24308.

Example of connector manufacturers

- HIROSE ELECTRIC CO., LTD.
- Japan Aviation Electronics Industry, Limited
- J.S.T. Mfg. Co., Ltd.
- Fujitsu Limited

Electric Characteristics

Item	Characteristics
Conductor resistance Ω/km, 20°C	65 or less
Withstand limit VAC, 1 minute	1000
Insulation resistance MΩ/km, 20°C	5 or less

Note) The minimum bending radius of the D-sub connector cable is 20 mm.

Directional Control Valves

Air Cylinders

Rotary Actuators

Air Grippers

Air Preparation Equipment

Modular F. R.

Pressure Control Equipment

Fittings & Tubing

Flow Control Equipment

Pressure Switches/ Pressure Sensors

Manifold Electrical Wiring

Type 60F D-sub Connector Type (25 pins)

● Without Power Supply Terminal

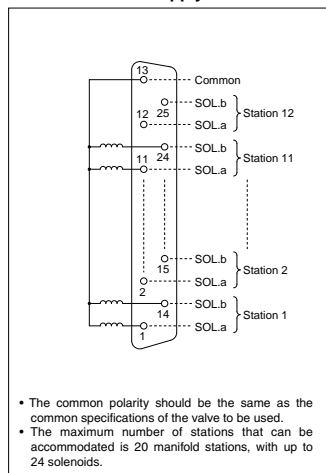

- The circuits above are for the double wiring specification with up to 10 or 12 stations. Connect to SOL.A for a single solenoid. Moreover, when wiring instructions are given on the manifold specification sheet, the "A" signal for single and the "A, B" signals for double should be wired in order 1, 14, 2, 15.....etc., without skipping or leaving any connectors remaining.
- Stations are counted from the D side as the 1st one.

● With Power Supply Terminal

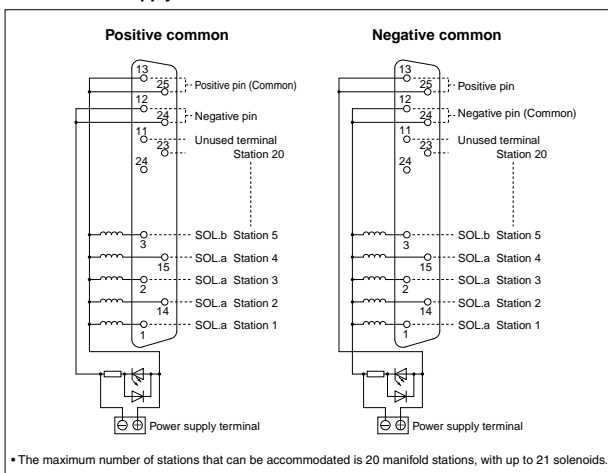

• The maximum number of stations that can be accommodated is 20 manifold stations, with up to 21 solenoids.

Type 60P Flat Ribbon Cable Type (26 pins)

● Without Power Supply Terminal

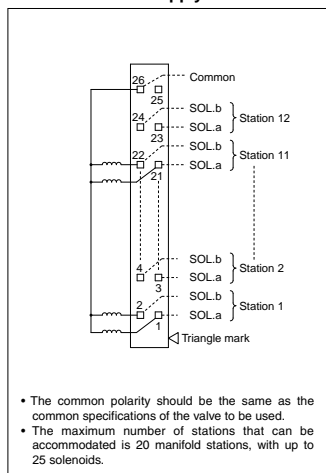

- The circuits above are for the double wiring specification with up to 11 or 12 stations. Connect to SOL.A for a single solenoid. Moreover, when wiring instructions are given on the manifold specification sheet, the "A" signal for single and the "A, B" signals for double should be wired in order 1, 2, 3, 4.....etc., without skipping or leaving any connectors remaining.
- Stations are counted from the D side as the 1st one.
- Since terminal numbers are not indicated on the flat cable, use the triangle mark as a reference for wiring.

● With Power Supply Terminal

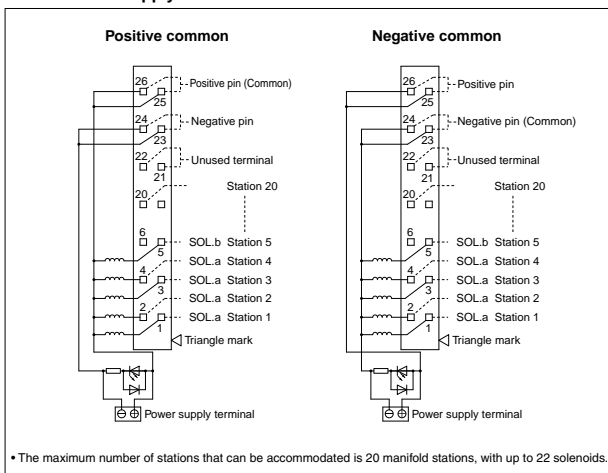

• The maximum number of stations that can be accommodated is 20 manifold stations, with up to 22 solenoids.

Manifold Electrical Wiring

Type 60PG Flat Ribbon Cable Type (20 pins)

● Without Power Supply Terminal

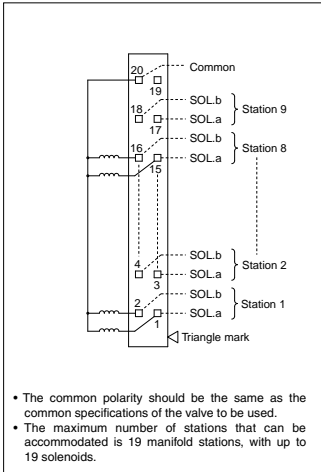

- The common polarity should be the same as the common specifications of the valve to be used.
- The maximum number of stations that can be accommodated is 19 manifold stations, with up to 19 solenoids.

● With Power Supply Terminal

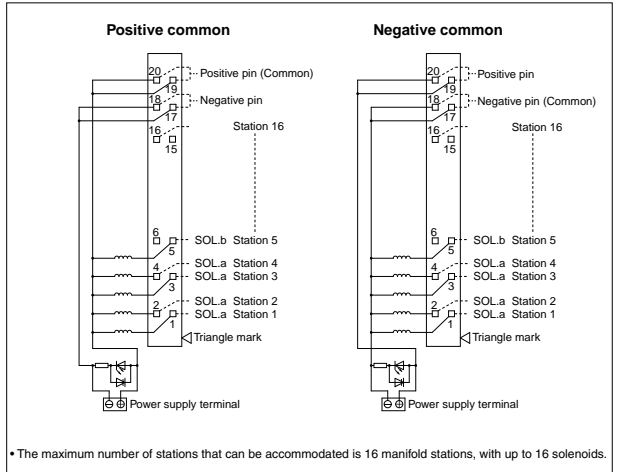

- The maximum number of stations that can be accommodated is 16 manifold stations, with up to 16 solenoids.

- The circuits above are for the double wiring specification with up to 8 or 9 stations. Connect to SOL.A for a single solenoid. Moreover, when wiring instructions are given on the manifold specification sheet, the "A" signal for single and the "A, B" signals for double should be wired in order 1, 2, 3, 4.....etc., without skipping or leaving any connectors remaining.
- Stations are counted from the D side as the 1st one.
- Since terminal numbers are not indicated on the flat cable, use the triangle mark as a reference for wiring.

Type 60PH Flat Ribbon Cable Type (10 pins)

● Without Power Supply Terminal

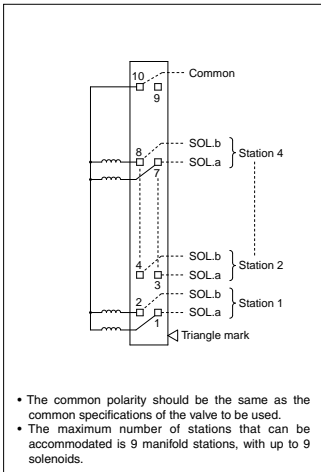

- The common polarity should be the same as the common specifications of the valve to be used.
- The maximum number of stations that can be accommodated is 9 manifold stations, with up to 9 solenoids.

● With Power Supply Terminal

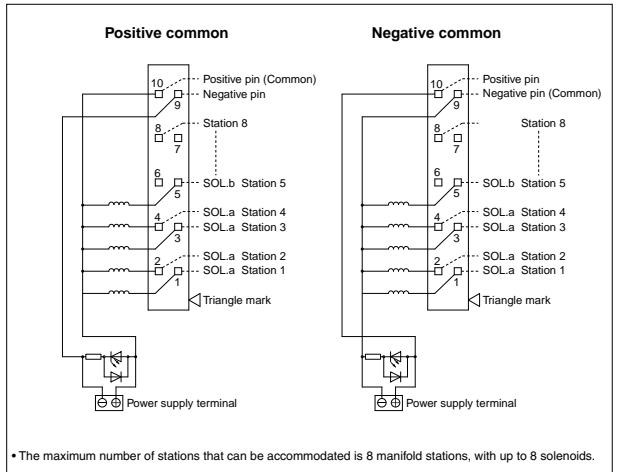

- The maximum number of stations that can be accommodated is 8 manifold stations, with up to 8 solenoids.

- The circuits above are for the double wiring specification with up to 4 stations. Connect to SOL.A for a single solenoid. Moreover, when wiring instructions are given on the manifold specification sheet, the "A" signal for single and the "A, B" signals for double should be wired in order 1, 2, 3, 4.....etc., without skipping or leaving any connectors remaining.
- Stations are counted from the D side as the 1st one.
- Since terminal numbers are not indicated on the flat cable, use the triangle mark as a reference for wiring.

Directional Control Valves

Air Cylinders

Rotary Actuators

Air Grippers

Air Preparation Equipment

Modular F. R.

Pressure Control Equipment

Fittings & Tubing

Flow Control Equipment

Pressure Switches/ Pressure Sensors

Wiring of Plug-in Type Manifold with Power Supply Terminal (Example)

- Since the power supply to drive valves with power supply terminals can be supplied from either the control side or the manifold side, these wiring examples should be used for reference when wiring is performed.

1. Wiring example when using manifold power supply terminal

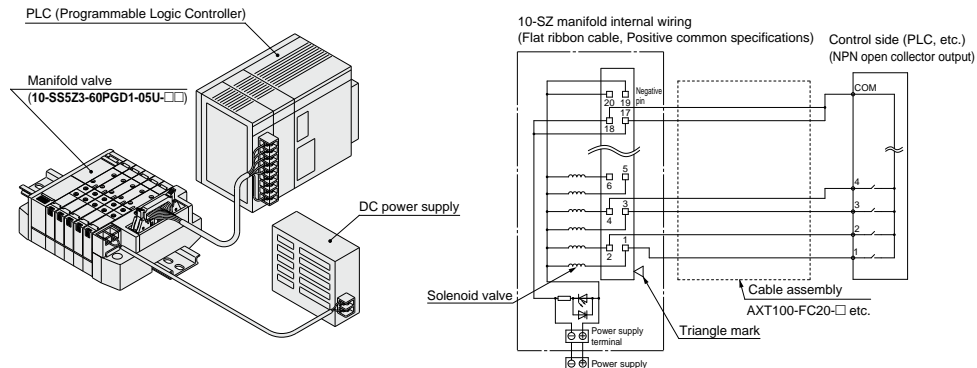

2. Wiring example when not using manifold power supply terminal (Power is supplied to the control side or along the wiring, etc.)

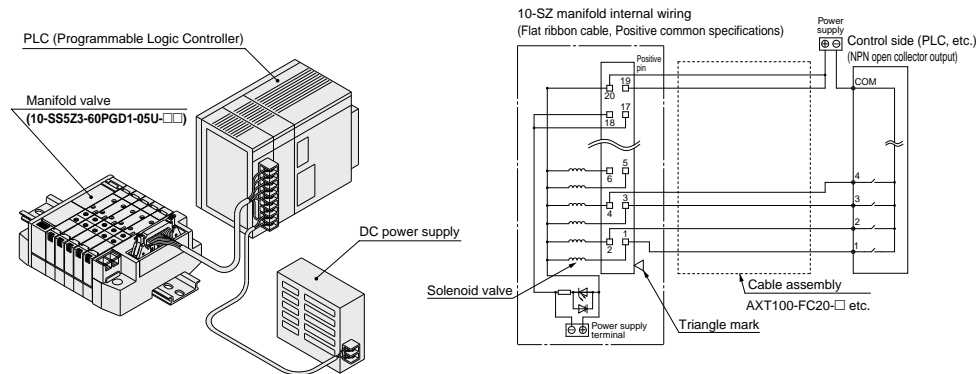

⚠ Caution

- Signal wire, COM position, etc. of PLC are different from each manufacturer. When connecting with PLC, read the specifications carefully and understand the electrical circuit. Poor wiring could cause damage to PLC, power source, etc. as well as manifold and valve.

Dimensions: 10-SZ3000 for Plug-in

10-SS5Z3-60FD₂ - [Stations] U-□

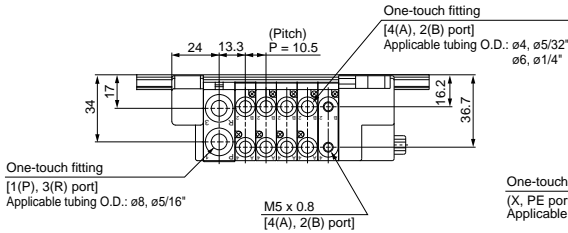

[With External Pilot Specifications]

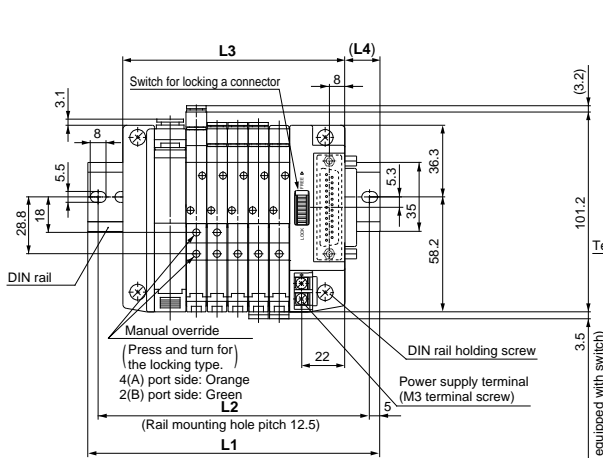
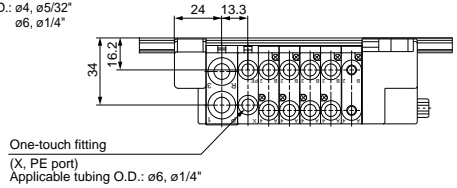

Applicable D-sub connector: {JIS-X-5101 / MIL-C-24308} equivalent

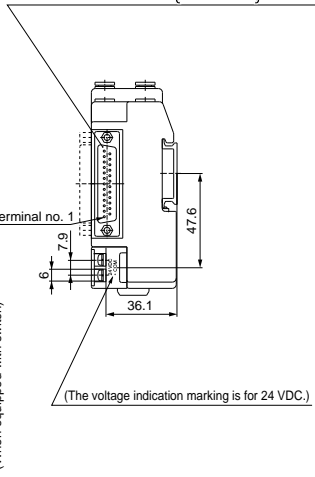

(Station n) (Station 1)

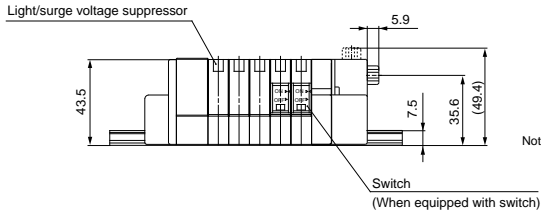

Note) For manifold dimensions with elbow fitting, refer to page 392.

Internal Pilot Manifold L Dimension										
n	2	3	4	5	6	7	8	9	10	n: Stations
L1	110.5	123	135.5	148	148	160.5	173	185.5	198	
L2	100	112.5	125	137.5	137.5	150	162.5	175	187.5	
L3	81	91.5	102	112.5	123	133.5	144	154.5	165	
L4	15	16	17	18	12.5	13.5	14.5	15.5	16.5	

External Pilot Manifold L Dimension										
n	2	3	4	5	6	7	8	9	10	n: Stations
L1	123	135.5	148	148	160.5	173	185.5	198	210.5	
L2	112.5	125	137.5	137.5	150	162.5	175	187.5	200	
L3	91.5	102	112.5	123	133.5	144	154.5	165	175.5	
L4	16	17	18	12.5	13.5	14.5	15.5	16.5	17.5	

Directional Control Valves
Air Cylinders
Rotary Actuators
Air Grippers
Air Preparation Equipment
Modular F. R.
Pressure Control Equipment
Fittings & Tubing
Flow Control Equipment
Pressure Switches/Pressure Sensors

Dimensions: 10-SZ3000 for Plug-in

10-SS5Z3-60FD $\frac{1}{2}$ - [Stations] B-□

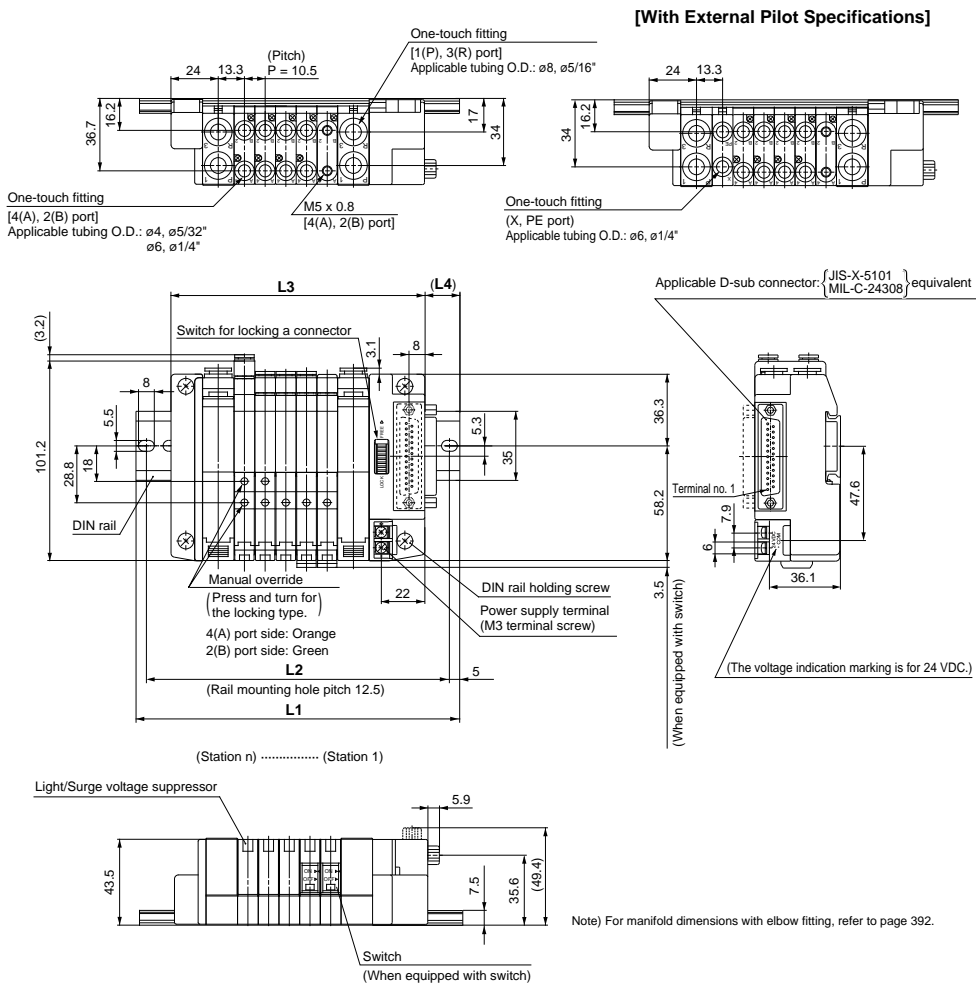

(Station n) (Station 1)

Note) For manifold dimensions with elbow fitting, refer to page 392.

Internal Pilot Manifold L Dimension

L	n: Stations																			
	2	3	4	5	6	7	8	9	10	11	12	13	14	15	16	17	18	19	20	
L1	123	135.5	148	160.5	173	173	185.5	198	210.5	223	235.5	248	248	260.5	273	285.5	298	310.5	310.5	
L2	112.5	125	137.5	150	162.5	162.5	175	187.5	200	212.5	225	237.5	237.5	250	262.5	275	287.5	300	300	
L3	97	107.5	118	128.5	139	149.5	160	170.5	181	191.5	202	212.5	223	233.5	244	254.5	265	275.5	286	
L4	13	14	15	16	17	12	13	14	15	16	17	18	12.5	13.5	14.5	15.5	16.5	17.5	12.5	

External Pilot Manifold L Dimension

L	n: Stations																			
	2	3	4	5	6	7	8	9	10	11	12	13	14	15	16	17	18	19	20	
L1	135.5	148	160.5	173	173	185.5	198	210.5	223	235.5	248	248	260.5	273	285.5	298	310.5	310.5	323	
L2	125	137.5	150	162.5	162.5	175	187.5	200	212.5	225	237.5	237.5	250	262.5	275	287.5	300	300	312.5	
L3	107.5	118	128.5	139	149.5	160	170.5	181	191.5	202	212.5	223	233.5	244	254.5	265	275.5	286	296.5	
L4	14	15	16	17	12	13	14	15	16	17	18	12.5	13.5	14.5	15.5	16.5	17.5	12.5	13.5	

Dimensions: 10-SZ3000 for Plug-in

10-SS5Z3-60PD 1/2 - [Stations] B-□ (26 pins)

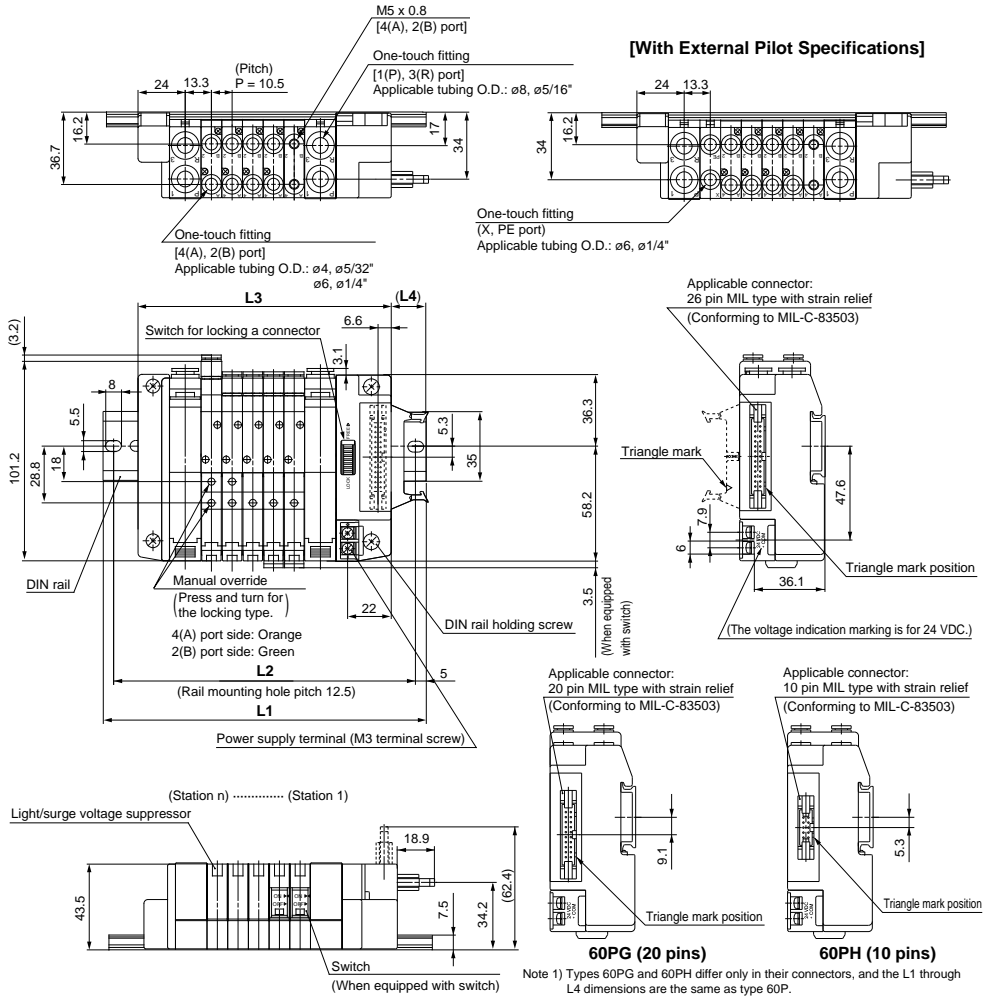

Internal Pilot Manifold L Dimension

n	2	3	4	5	6	7	8	9	10	11	12	13	14	15	16	17	18	19	20
L1	123	135.5	148	160.5	173	173	185.5	198	210.5	223	235.5	248	248	260.5	273	285.5	298	310.5	310.5
L2	112.5	125	137.5	150	162.5	162.5	175	187.5	200	212.5	225	237.5	237.5	250	262.5	275	287.5	300	300
L3	97	107.5	118	128.5	139	149.5	160	170.5	181	191.5	202	212.5	223	233.5	244	254.5	265	275.5	286
L4	13	14	15	16	17	12	13	14	15	16	17	18	12.5	13.5	14.5	15.5	16.5	17.5	12.5

External Pilot Manifold L Dimension

n	2	3	4	5	6	7	8	9	10	11	12	13	14	15	16	17	18	19	20
L1	135.5	148	160.5	173	173	185.5	198	210.5	223	235.5	248	248	260.5	273	285.5	298	310.5	310.5	323
L2	125	137.5	150	162.5	162.5	175	187.5	200	212.5	225	237.5	237.5	250	262.5	275	287.5	300	300	312.5
L3	107.5	118	128.5	139	149.5	160	170.5	181	191.5	202	212.5	223	233.5	244	254.5	265	275.5	286	296.5
L4	14	15	16	17	12	13	14	15	16	17	18	12.5	13.5	14.5	15.5	16.5	17.5	12.5	13.5

Dimensions with Elbow Fitting: 10-SZ3000 for Plug-in, D-sub Connector

10-SS5Z3-60FD₂ - [Stations] U_B - □

(The fitting dimension of the flat ribbon cable and non plug-in types is the same.)

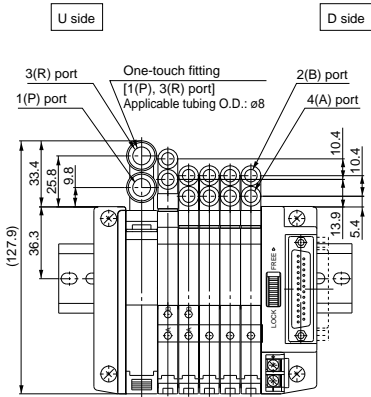
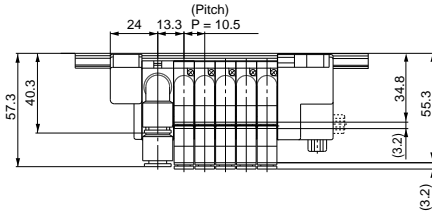

(Station n) ---- (Station 1)

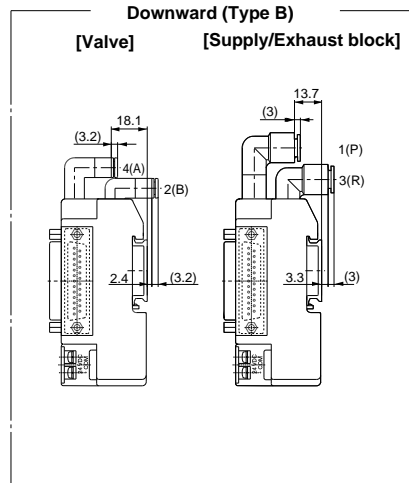
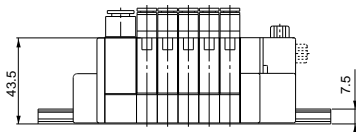

Directional Control Valves

Air Cylinders

Rotary Actuators

Air Grippers

Air Preparation Equipment

Modular F. R.

Pressure Control Equipment

Fittings & Tubing

Flow Control Equipment

Pressure Switches/ Pressure Sensors

Series 10-SZ3000

5 Port Solenoid Valve
Non Plug-in Type



How to Order

An order cannot be placed with only the manifold part no. Be sure to order solenoid valves for mounting at the same time while referring to the ordering example.

• Non plug-in manifold

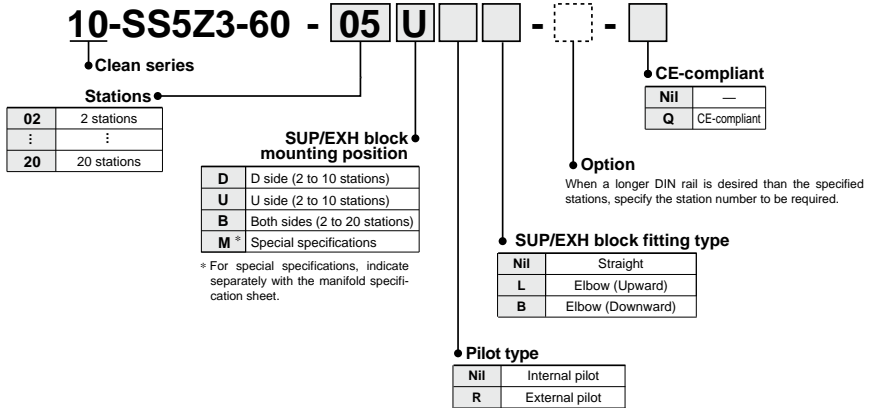

How to Order Valve Manifold Assembly

Ordering example (10-SZ3000, Non plug-in)

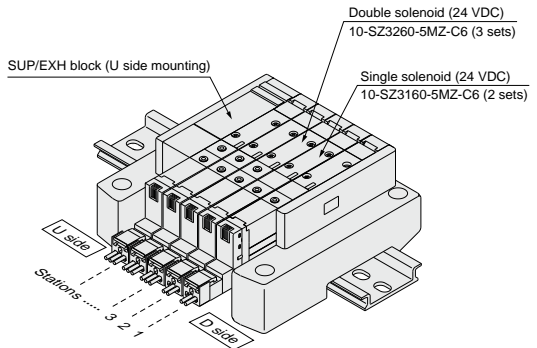

10-SS5Z3-60-05U.....1 set (Manifold part no.)
 * 10-SZ3160-5MZ-C6.....2 sets (Single solenoid part no.)
 * 10-SZ3260-5MZ-C6.....3 sets (Double solenoid part no.)

→The asterisk denotes the symbol for assembly. Prefix to the part no. of the solenoid valve, etc.

Stations are counted from the D side as the 1st one.
 Add the valve part number under the manifold part number.
 For complex arrangements, specify them on the manifold specification sheet.

How to Order

10-SZ3 1 60 - 5 M - C6 -

● Clean series

Actuation type ●

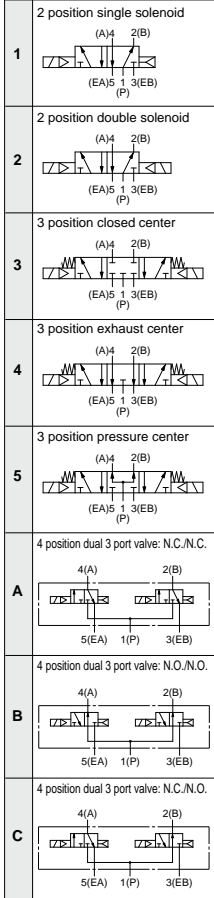

Pilot type ●

Nil	Internal pilot
R	External pilot

● External pilot specifications are not available for 4 position dual 3 port valves.

Back pressure check valve ●

Nil	None
K	Built-in

● The built-in back pressure check valve type has an effective area approximately 20% smaller.
● The product with back pressure check valve is not available for 3 position solenoid valves.

Rated voltage ●

5	24 VDC
6	12 VDC

Common specifications ●

Nil	Positive common
N	Negative common

● The symbol is "Nil" for no light/surge voltage suppressor.

● CE-compliant

Nil	—
Q	CE-compliant

● A, B port size

C4: ø4 One-touch fitting
C6: ø6 One-touch fitting
N3: ø5/32" One-touch fitting
N7: ø1/4" One-touch fitting



M5: M5 x 0.8



Elbow fitting assembly (Upward)
L4: ø4 elbow fitting assembly
L6: ø6 elbow fitting assembly



Elbow fitting assembly (Downward)
B4: ø4 elbow fitting assembly
B6: ø6 elbow fitting assembly

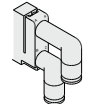

● Manual override

Nil: Non-locking push type

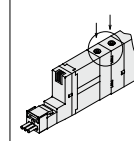

D: Push-turn locking slotted type

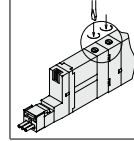

● Light/Surge voltage suppressor

Nil	Without light/surge voltage suppressor
S	With surge voltage suppressor
Z	With light/surge voltage suppressor

● Electrical entry

M: With lead wire (Length 300 mm) MN: Without lead wire MO: Without connector

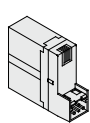
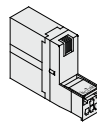
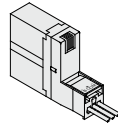

Directional Control Valves
Air Cylinders
Rotary Actuators
Air Grippers
Air Preparation Equipment
Modular F. R.
Pressure Control Equipment
Fittings & Tubing
Flow Control Equipment
Pressure Switches/Pressure Sensors



Made to Order
(For details, refer to page 411.)

Manifold Specifications

Model		Type 10-SSSZ3-60	
Manifold		Non plug-in type	
1 (P: SUP), 3/5 (R: EXH)		Common SUP, EXH	
Valve stations		2 to 20 stations	
4(A), 2(B) port Porting specifications	Location	Valve	
	Direction	Lateral, Upward, Downward	
Port size	Metric	1(P), 3/5(R) port: ø8	4(A), 2(B) port: M5, ø4, ø6
	Inch	1(P), 3/5(R) port: ø5/16"	4(A), 2(B) port: ø5/32", ø1/4"
Weight W (g) ^{Note 2)} (n: Number of SUP/EXH blocks) (m: Weight of DIN rail)		W = 34n + m + 89	

Note 1) In cases such as those where many valves are operated simultaneously, use type B (double side SUP/EXH), applying pressure to the 1(P) ports on both sides and exhausting from the 3(R) ports on both sides.
 Note 2) The weight W is the value for the manifold only. To obtain the weight with solenoid valves attached, add the solenoid valve weights given on page 382 for the appropriate number of stations. For DIN rail weight, refer to page 384.

Flow Rate Characteristics

Port size		Flow rate characteristics					
1, 5, 3 (P, EA, EB)	4, 2 (A, B)	1 → 2/4 (P → A/B)			4/2 → 3 (A/B → R)		
		C [dm ³ /(s·bar)]	b	Cv	C [dm ³ /(s·bar)]	b	Cv
C8	C4	0.58 [0.49]	0.26 [0.36]	0.14 [0.13]	0.76 [0.65]	0.15 [0.20]	0.18 [0.15]
	C6	0.73 [0.64]	0.24 [0.27]	0.18 [0.16]	0.77 [0.74]	0.19 [0.16]	0.19 [0.19]
	M5	0.60 [0.57]	0.38 [0.35]	0.17 [0.15]	0.67 [0.58]	0.16 [0.39]	0.16 [0.16]

Note) · The values are for individually operated 2 position type manifold bases with 5 stations.
 · Values inside [] are for 4 position dual 3 port valves.

Dimensions: 10-SZ3000 for Non Plug-in

10-SS5Z3-60- [Stations] U

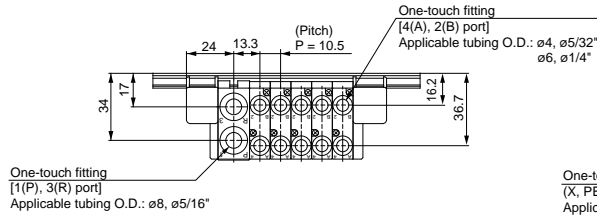

One-touch fitting [1(P), 3(R) port]
Applicable tubing O.D.: ø8, ø5/16"

[With External Pilot Specifications]

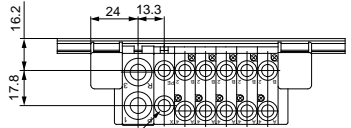

One-touch fitting (X, PE port)
Applicable tubing O.D.: ø6, ø1/4"

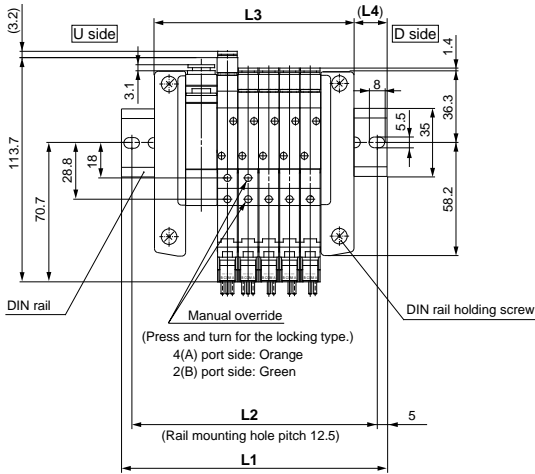

(Station n).....(Station 1)

Light/Surge voltage suppressor

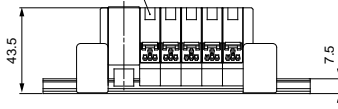

Note) For manifold dimensions with elbow fitting, refer to page 392.

Internal Pilot Manifold					L Dimension					n: Stations												
L	0	2	3	4	5	6	7	8	9	10	L	0	2	3	4	5	6	7	8	9	10	
L1	98	110.5	123	135.5	135.5	148	160.5	173	185.5		L1	110.5	123	135.5	135.5	148	160.5	173	185.5	198		
L2	87.5	100	112.5	125	125	137.5	150	162.5	175		L2	100	112.5	125	125	137.5	150	162.5	175	187.5		
L3	70	80.5	91	101.5	112	122.5	133	143.5	154		L3	80.5	91	101.5	112	122.5	133	143.5	154	164.5		
L4	14	15	16	17	12	13	14	15	16		L4	15	16	17	12	13	14	15	16	17		

External Pilot Manifold					L Dimension					n: Stations												
L	0	2	3	4	5	6	7	8	9	10	L	0	2	3	4	5	6	7	8	9	10	
L1	110.5	123	135.5	135.5	148	160.5	173	185.5	198		L1	110.5	123	135.5	135.5	148	160.5	173	185.5	198		
L2	100	112.5	125	125	137.5	150	162.5	175	187.5		L2	100	112.5	125	125	137.5	150	162.5	175	187.5		
L3	80.5	91	101.5	112	122.5	133	143.5	154	164.5		L3	80.5	91	101.5	112	122.5	133	143.5	154	164.5		
L4	15	16	17	12	13	14	15	16	17		L4	15	16	17	12	13	14	15	16	17		

Dimensions: 10-SZ3000 for Non Plug-in

10-SS5Z3-60- [Stations] D

[With External Pilot Specifications]

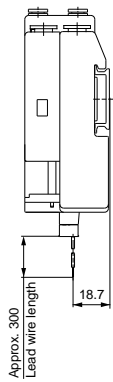
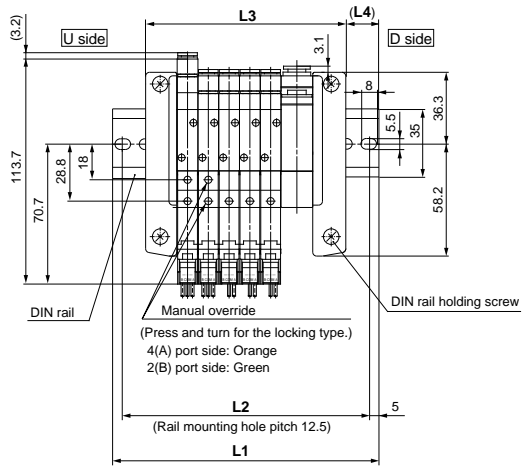
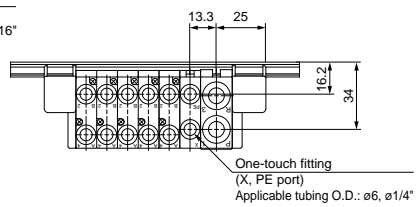
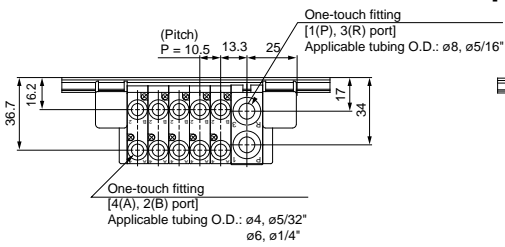

(Station n).....(Station 1)

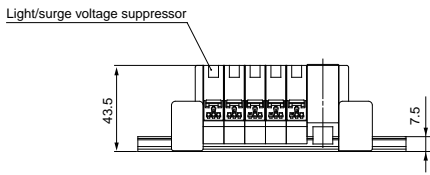

Note) For manifold dimensions with elbow fitting, refer to page 392.

Internal Pilot Manifold		L Dimension								n: Stations
L	n	2	3	4	5	6	7	8	9	10
L1	98	110.5	123	135.5	135.5	148	160.5	173	185.5	
L2	87.5	100	112.5	125	125	137.5	150	162.5	175	
L3	70	80.5	91	101.5	112	122.5	133	143.5	154	
L4	14	15	16	17	12	13	14	15	16	

External Pilot Manifold		L Dimension								n: Stations
L	n	2	3	4	5	6	7	8	9	10
L1	110.5	123	135.5	135.5	148	160.5	173	185.5	198	
L2	100	112.5	125	125	137.5	150	162.5	175	187.5	
L3	80.5	91	101.5	112	122.5	133	143.5	154	164.5	
L4	15	16	17	12	13	14	15	16	17	

Dimensions: 10-SZ3000 for Non Plug-in

10-SS5Z3-60- [Stations] B

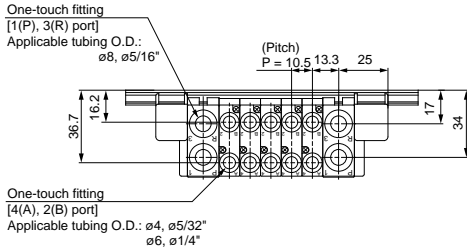

[With External Pilot Specifications]

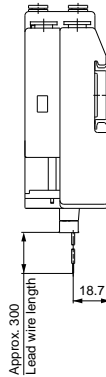
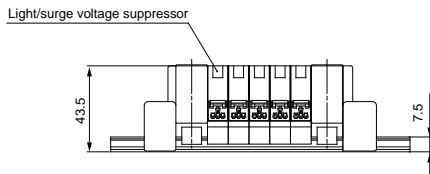
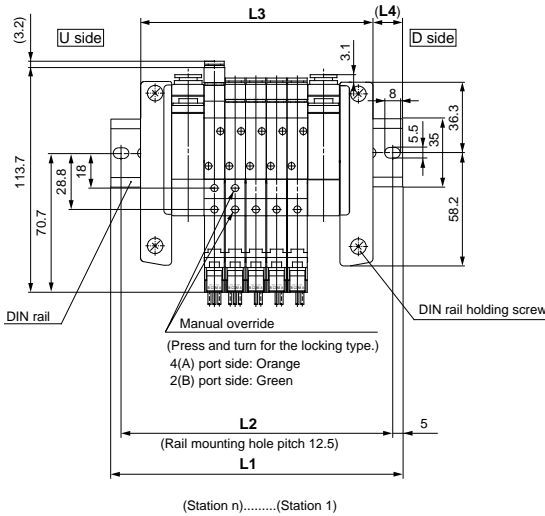
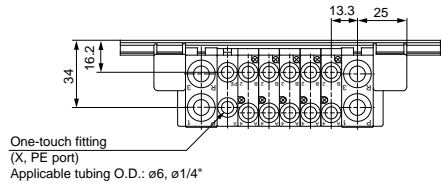

Note) For manifold dimensions with elbow fitting, refer to page 392.

Internal Pilot Manifold L Dimension

L	n	2	3	4	5	6	7	8	9	10	11	12	13	14	15	16	17	18	19	20
L1	n: Stations	110.5	123	135.5	148	160.5	173	173	185.5	198	210.5	223	235.5	235.5	248	260.5	273	285.5	298	310.5
L2	n: Stations	100	112.5	125	137.5	150	162.5	162.5	175	187.5	200	212.5	225	225	237.5	250	262.5	275	287.5	300
L3	n: Stations	86	96.5	107	117.5	128	138.5	149	159.5	170	180.5	191	201.5	212	222.5	233	243.5	254	264.5	275
L4	n: Stations	12	13	14	15	16	17	12	13	14	15	16	17	12	13	14	15	16	17	18

External Pilot Manifold L Dimension

L	n	2	3	4	5	6	7	8	9	10	11	12	13	14	15	16	17	18	19	20
L1	n: Stations	123	135.5	148	160.5	173	173	185.5	198	210.5	223	235.5	235.5	248	260.5	273	285.5	298	310.5	310.5
L2	n: Stations	112.5	125	137.5	150	162.5	162.5	175	187.5	200	212.5	225	225	237.5	250	262.5	275	287.5	300	300
L3	n: Stations	96.5	107	117.5	128	138.5	149	159.5	170	180.5	191	201.5	212	222.5	233	243.5	254	264.5	275	285.5
L4	n: Stations	13.5	14.5	15.5	16.5	17.5	12	13	14	15	16	17	12	13	14	15	16	17	18	12.5

Directional Control Valves
Air Cylinders
Rotary Actuators
Air Grippers
Air Preparation Equipment
Modular F. R.
Pressure Control Equipment
Fittings & Tubing
Flow Control Equipment
Pressure Switches/ Pressure Sensors

Type 60S□ Series 10-SZ3000

EX140 Integrated-type (For Output)
Serial Transmission System



Note) Refer to the SI unit part no. for the SI unit comparable with CE.



An order cannot be placed with only the manifold part no. Be sure to order solenoid valves for mounting at the same time while referring to the ordering example.

How to Order Manifold

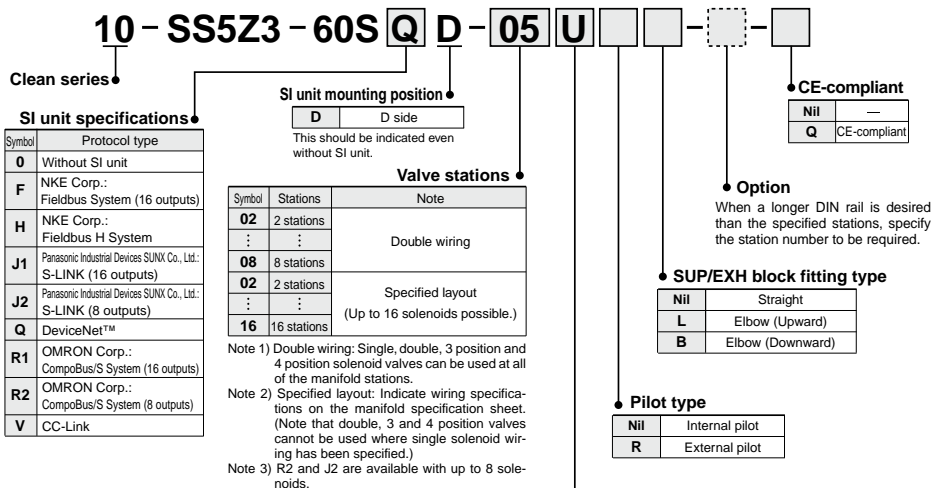

SI unit part no.

Symbol	Protocol type	SI unit part no.	CE-compliant
F	NKE Corp.: Fieldbus System	EX140-SUW1	—
H	NKE Corp.: Fieldbus H System	EX140-SUH1	—
J1	Panasonic Industrial Devices SUNX Co., Ltd.: S-LINK (16 outputs)	EX140-SSL1	—
J2	Panasonic Industrial Devices SUNX Co., Ltd.: S-LINK (8 outputs)	EX140-SSL2	—
Q	DeviceNet™	EX140-SDN1	○
R1	OMRON Corp.: CompoBus/S (16 outputs)	EX140-SCS1	○
R2	OMRON Corp.: CompoBus/S (8 outputs)	EX140-SCS2	○
V	CC-Link	EX140-SMJ1	○

SUP/EXH block mounting position

Symbol	Position
U	U side (2 to 10 stations)
D	D side (2 to 10 stations)
B	Both sides (2 to 16 stations)
M	Special specifications

* For special specifications, indicate separately with the manifold specification sheet.
Note) A total of up to 3 SUP/EXH blocks can be mounted. Please contact SMC if 4 or more will be mounted.

How to Order Valve Manifold Assembly

Ordering example (CompoBus/S compatible SI unit)

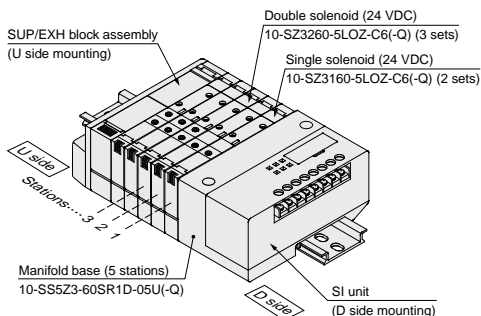

10-SS5Z3-60SR1D-05U (-Q).....1 set (Manifold part no.)
 * **10-SZ3160-5LOZ-C6 (-Q).....2 sets (Single solenoid part no.)**
 * **10-SZ3260-5LOZ-C6 (-Q).....3 sets (Double solenoid part no.)**

↳ The asterisk denotes the symbol for assembly. Prefix it to the part no. of the solenoid valve, etc.

Stations are counted from the D side as the 1st one.
Add the valve part number under the manifold part number.
For complex arrangements, specify them on the manifold specification sheet.

How to Order Solenoid Valve

10-SZ3 1 60 - 5 LOZ - C6 -

• Clean series

• Actuation type

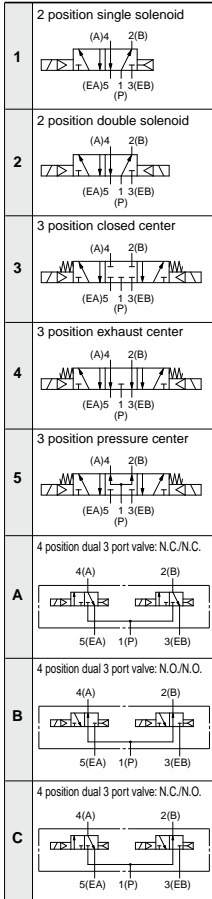

• Rated voltage
5 24 VDC

• CE-compliant
Nil —
Q CE-compliant

• Made to Order

Nil	—
X90	Main valve fluororubber (Refer to page 411.)

• Switch

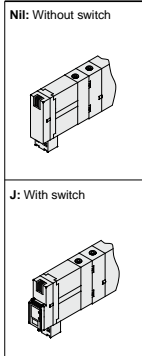

* For switch operation, refer to page 412.

• Manual override

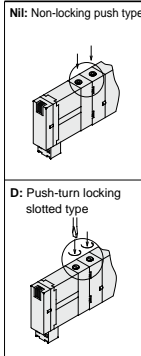

• A, B port size

C4: ø4 One-touch fitting
C6: ø6 One-touch fitting



M5: M5 x 0.8



Elbow fitting assembly (Upward)
L4: ø4 elbow fitting assembly
L6: ø6 elbow fitting assembly



Elbow fitting assembly (Downward)
B4: ø4 elbow fitting assembly
B6: ø6 elbow fitting assembly

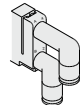

• Back pressure check valve

Nil	None
K	Built-in

- The built-in back pressure check valve type has an effective area approximately 20% smaller.
- The product with back pressure check valve is not available for 3 position solenoid valves.

• Pilot type

Nil	Internal pilot
R	External pilot

- External pilot specifications are not available for 4 position dual 3 port valves.

Directional Control Valves

Air Cylinders

Rotary Actuators

Air Grippers

Air Preparation Equipment

Modular F. R.

Pressure Control Equipment

Fittings & Tubing

Flow Control Equipment

Pressure Switches/ Pressure Sensors

Dimensions: 10-SZ3000 for EX140 Integrated-type (For Output) Serial Transmission System

10-SS5Z3-60S □ D- Stations U

[With External Pilot Specifications]

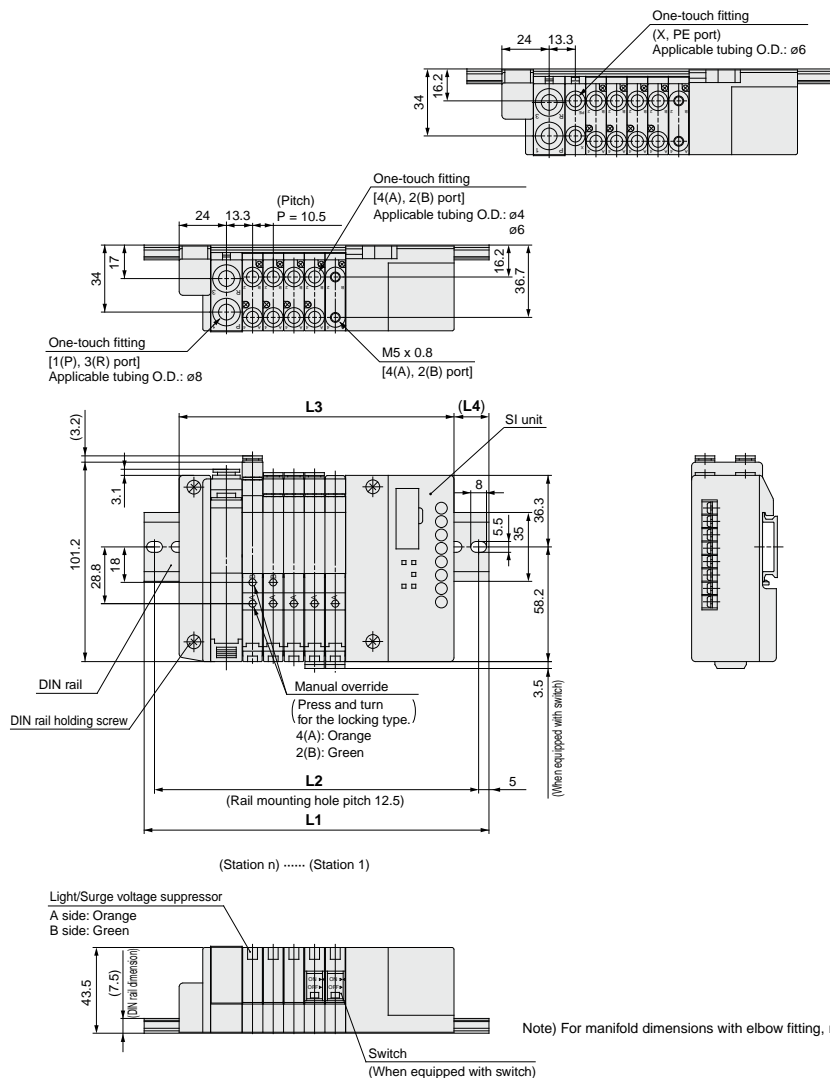

Note) For manifold dimensions with elbow fitting, refer to page 392.

Internal Pilot Manifold		L Dimension										n: Stations
L	n	2	3	4	5	6	7	8	9	10		
L1	135.5	148	160.5	173	185.5	185.5	198	210.5	223			
L2	125	137.5	150	162.5	175	175	187.5	200	212.5			
L3	108	118.5	129	139.5	150	160.5	171	181.5	192			
L4	14	15	16	17	18	12.5	13.5	14.5	15.5			

External Pilot Manifold		L Dimension										n: Stations
L	n	2	3	4	5	6	7	8	9	10		
L1	148	160.5	173	185.5	185.5	198	210.5	223	235.5			
L2	137.5	150	162.5	175	175	187.5	200	212.5	225			
L3	118.5	129	139.5	150	160.5	171	181.5	192	202.5			
L4	15	16	17	18	12.5	13.5	14.5	15.5	16.5			

Dimensions: 10-SZ3000 for EX140 Integrated-type (For Output) Serial Transmission System

10-SS5Z3-60S □ D- Stations B

[With External Pilot Specifications]

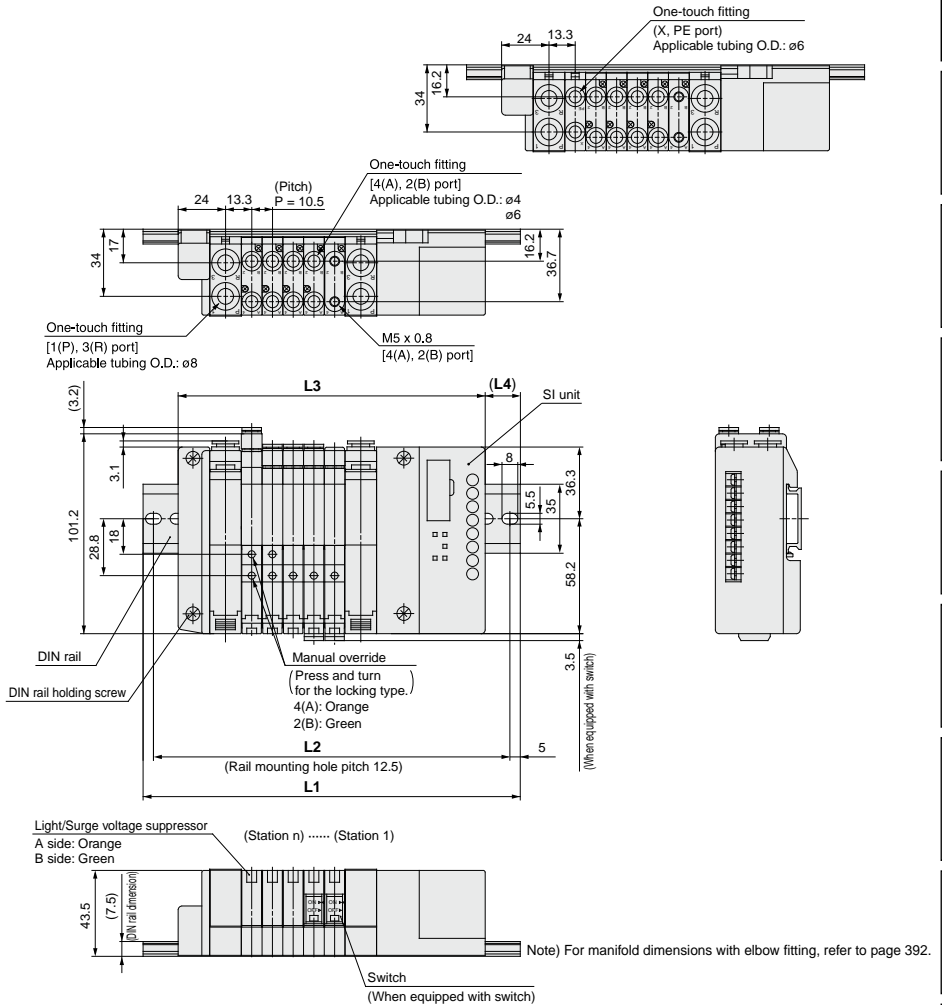

Internal Pilot Manifold L Dimension n: Stations

n	2	3	4	5	6	7	8	9
L1	148	160.5	173	185.5	198	210.5	210.5	223
L2	137.5	150	162.5	175	187.5	200	200	212.5
L3	124	134.5	145	155.5	166	176.5	187	197.5
L4	12	13	14	15	16	17	12	13

n	10	11	12	13	14	15	16
L1	235.5	248	260.5	273	285.5	285.5	298
L2	225	237.5	250	262.5	275	275	287.5
L3	208	218.5	229	239.5	250	260.5	271
L4	14	15	16	17	18	12.5	13.5

External Pilot Manifold L Dimension n: Stations

n	2	3	4	5	6	7	8	9
L1	160.5	173	185.5	198	210.5	210.5	223	235.5
L2	150	162.5	175	187.5	200	200	212.5	225
L3	134.5	145	155.5	166	176.5	187	197.5	208
L4	13	14	15	16	17	12	13	14

n	10	11	12	13	14	15	16
L1	248	260.5	273	285.5	285.5	298	310.5
L2	237.5	250	262.5	275	275	287.5	300
L3	218.5	229	239.5	250	260.5	271	281.5
L4	15	16	17	18	12.5	13.5	14.5

Directional Control Valves
Air Cylinders
Rotary Actuators
Air Grippers
Air Preparation Equipment
Modular F. R.
Pressure Control Equipment
Fittings & Tubing
Pressure Switches/ Pressure Sensors

Type 60S6B Series 10-SZ3000

EX510 Gateway-type
Serial Transmission System



An order cannot be placed with only the manifold part no. Be sure to order solenoid valves for mounting at the same time while referring to the ordering example.

How to Order Manifold

10 - SS5Z3 - 60S6B [] D - 05 U [] [] [] [] [] []

Clean series

SI unit specifications

Nil	NPN output (+ COM)
N	PNP output (- COM)

Unit mounting position

D	D side
---	--------

CE-compliant

Nil	—
Q	CE-compliant

Option

When a longer DIN rail is desired than the specified stations, specify the station number to be required. (Max. 16)

SUP/EXH block fitting type

Nil	Straight
L	Elbow (Upward)
B	Elbow (Downward)

Pilot type

Nil	Internal pilot
R	External pilot

SUP/EXH block mounting position

U	U side	2 to 10 stations
D	D side	2 to 10 stations
B	Both sides	2 to 16 stations
M	Special specifications*	

* For special specifications, indicate separately with the manifold specification sheet.

Note) A total of up to 3 SUP/EXH blocks can be mounted. Please contact SMC if 4 or more will be mounted.

Valve stations

Symbol	Stations	Note
02	2 stations	Double wiring ^{Note 1)}
:	:	
08	8 stations	
02	2 stations	Specified layout ^{Note 2)} (Up to 16 solenoids possible.)
:	:	
16	16 stations	

* Includes the number of blanking block assemblies.

Note 1) Double wiring: Single, double, 3 position and 4 position solenoid valves can be used at all of the manifold stations.

Note 2) Specified layout: Indicate wiring specifications on the manifold specification sheet. (Note that double, 3 and 4 position valves cannot be used where single solenoid wiring has been specified.)

How to Order Valve Manifold Assembly

Ordering example

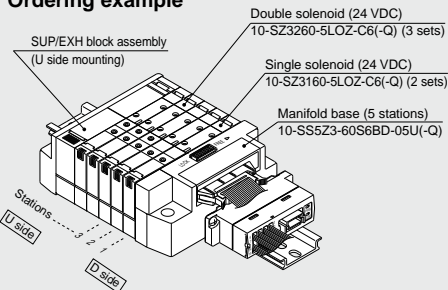

10-SS5Z3-60S6BD-05U (-Q)...1 set (Type 60S6B 5-station manifold part no.)
 * 10-SZ3160-5LOZ-C6 (-Q).....2 sets (Single solenoid part no.)
 * 10-SZ3260-5LOZ-C6 (-Q).....3 sets (Double solenoid part no.)

The asterisk denotes the symbol for assembly. Prefix it to the part no. of the solenoid valve, etc.

- Stations are counted from the D side as the 1st one.
- Add the valve part number under the manifold part number.
- For complex arrangements, specify them on the manifold specification sheet.

SI unit part no.

Symbol	SI unit specifications	SI unit part no.
Nil	NPN output (+ COM)	EX510-S002B
N	PNP output (- COM)	EX510-S102B

How to Order

● How to order solenoid valve For plug-in (Common for both with and without power supply terminals)

10 - SZ3 1 60 [] [] - 5 [] LOZ [] [] - C6 - [] - []

● Clean series

● Actuation type ●

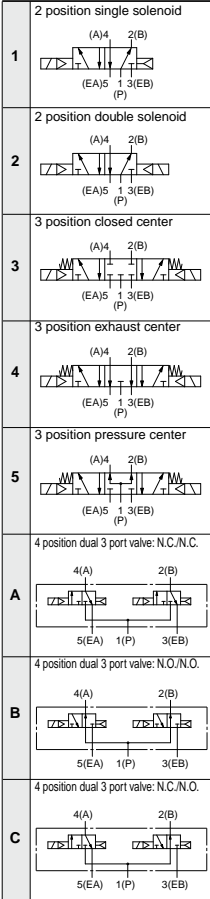

● Rated voltage

5	24 VDC
---	--------

● Back pressure check valve

Nil	None
K	Built-in

- The built-in back pressure check valve type has an effective area approximately 20% smaller.
- The product with back pressure check valve is not available for 3 position solenoid valves.

● Pilot type

Nil	Internal pilot
R	External pilot

- External pilot specifications are not available for 4 position dual 3 port valves.

● Switch

Nil: Without switch

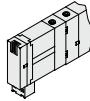

J: With switch

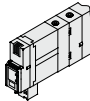

- * For switch operation, refer to page 412.

● Common specifications

Nil	Positive common
N	Negative common

- When the SI unit specifications are PNP output (-COM), the common specifications of valves should be negative common.

● Manual override

Nil: Non-locking push type

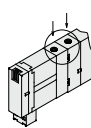

D: Push-turn locking slotted type

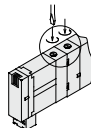

● CE-compliant

Nil	—
Q	CE-compliant

● Made to Order

Nil	—
X90	Main valve fluororubber (Refer to page 411.)

● A, B port size

- C4: ø4 One-touch fitting
- C6: ø6 One-touch fitting



M5: M5 x 0.5



- Elbow fitting assembly (Upward)
- L4: ø4 elbow fitting assembly
- L6: ø6 elbow fitting assembly



- Elbow fitting assembly (Downward)
- B4: ø4 elbow fitting assembly
- B6: ø6 elbow fitting assembly

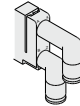

Directional Control Valves

Air Cylinders

Rotary Actuators

Air Grippers

Air Preparation Equipment

Modular F. R.

Pressure Control Equipment

Fittings & Tubing

Flow Control Equipment

Pressure Switches/ Pressure Sensors

Dimensions: 10-SZ3000 for EX510 Gateway-type Serial Transmission System

10-SS5Z3-60S6B □ D-Stations U □

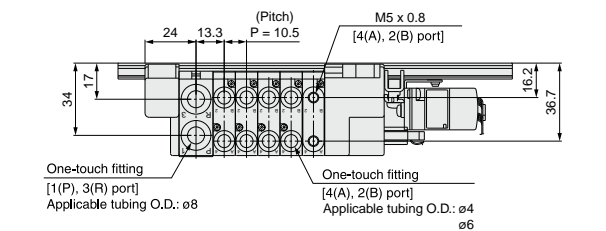

[With External Pilot Specifications]

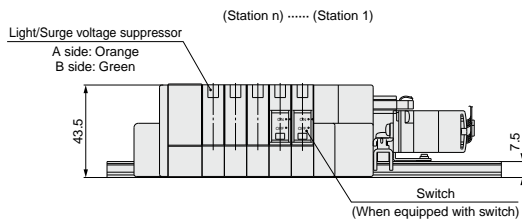
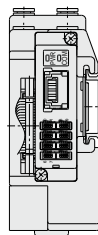
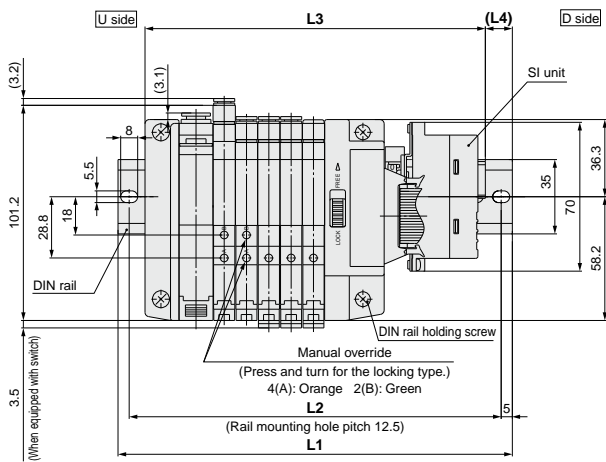
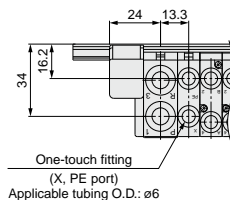

Note) For manifold dimensions with elbow fitting, refer to page 392.

Internal Pilot Manifold L Dimension

n: Stations

L \ n	2	3	4	5	6	7	8	9	10
L1	160.5	173	185.5	185.5	198	210.5	223	235.5	248
L2	150	162.5	175	175	187.5	200	212.5	225	237.5
L3	128.6	139.1	149.6	160.1	170.6	181.1	191.6	202.1	212.6
L4	16	17	18	12.5	13.5	14.5	15.5	16.5	17.5

External Pilot Manifold L Dimension

n: Stations

L \ n	2	3	4	5	6	7	8	9	10
L1	173	185.5	185.5	198	210.5	223	235.5	248	260.5
L2	162.5	175	175	187.5	200	212.5	225	237.5	250
L3	139.1	149.6	160.1	170.6	181.1	191.6	202.1	212.6	223.1
L4	17	18	12.5	13.5	14.5	15.5	16.5	17.5	18.5

Dimensions: 10-SZ3000 for EX510 Gateway-type Serial Transmission System

10-SS5Z3-60S6B □ D- Stations B- □

[With External Pilot Specifications]

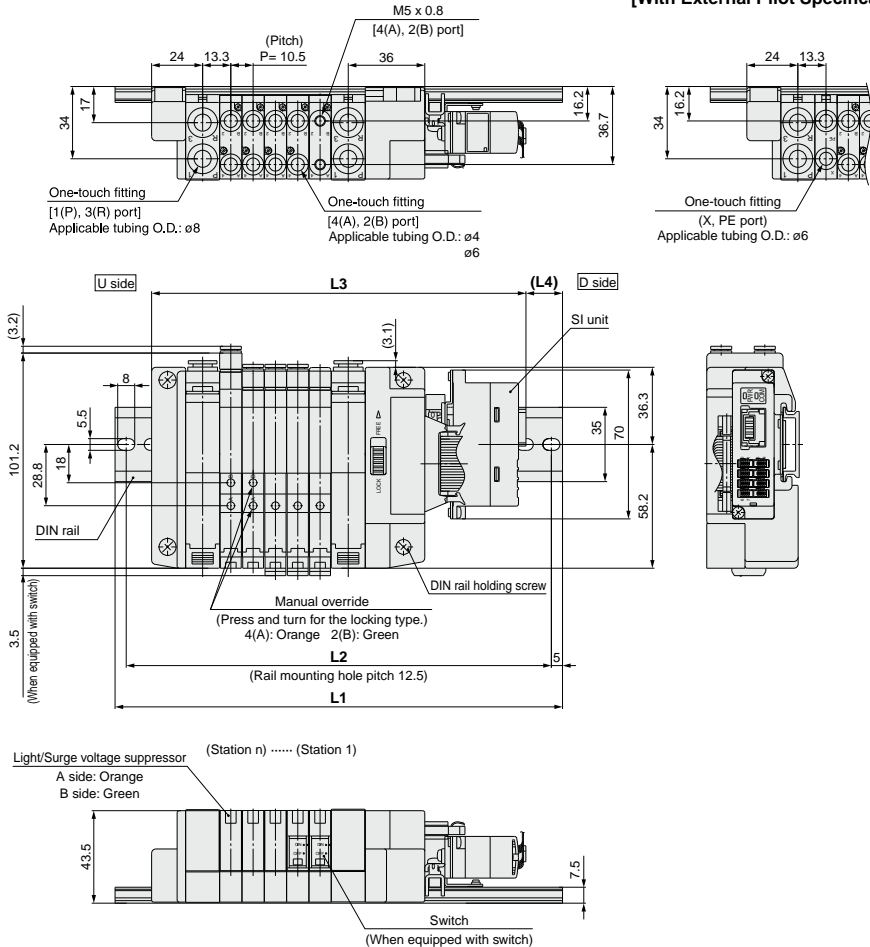

Note) For manifold dimensions with elbow fitting, refer to page 392.

Internal Pilot Manifold L Dimension

L \ n	2	3	4	5	6	7	8	9	10	11	12	13	14	15	16
L1	173	185.5	198	210.5	223	223	235.5	248	260.5	273	285.5	298	298	310.5	323
L2	162.5	175	187.5	200	212.5	212.5	225	237.5	250	262.5	275	287.5	287.5	300	312.5
L3	144.6	155.1	165.6	176.1	186.6	197.1	207.6	218.1	228.6	239.1	249.6	260.1	270.6	281.1	291.6
L4	14	15	16	17	18	13	14	15	16	17	18	19	13.5	14.5	15.5

External Pilot Manifold L Dimension

L \ n	2	3	4	5	6	7	8	9	10	11	12	13	14	15	16
L1	185.5	198	210.5	223	223	235.5	248	260.5	273	285.5	298	298	310.5	323	335.5
L2	175	187.5	200	212.5	212.5	225	237.5	250	262.5	275	287.5	287.5	300	312.5	325
L3	155.1	165.6	176.1	186.6	197.1	207.6	218.1	228.6	239.1	249.6	260.1	270.6	281.1	291.6	302.1
L4	15	16	17	18	13	14	15	16	17	18	19	13.5	14.5	15.5	16.5

Directional Control Valves
Air Cylinders
Rotary Actuators
Air Grippers
Air Preparation Equipment
Modular F. R.
Pressure Control Equipment
Fittings & Tubing
Flow Control Equipment
Pressure Switches/Pressure Sensors

Type 60GD Series 10-SZ3000

PC Wiring System
Plug-in Type



How to Order Manifold

An order cannot be placed with only the manifold part no. Be sure to order solenoid valves for mounting at the same time while referring to the ordering example.

10 — SS5Z3 — 60GD 1 — 05 U [] [] [] []

- Clean series**
- Connector entry direction**

1	Upward
2	Lateral
- Valve stations**

Symbol	Stations	Note
02	2 stations	Double wiring
⋮	⋮	
08	8 stations	Specified layout (Up to 16 solenoids possible.)
02	2 stations	
⋮	⋮	
16	16 stations	

Note 1) Double wiring: Single, double, 3 position and 4 position solenoid valves can be used at all of the manifold stations.
Specified layout: Indicate wiring specifications on the manifold specification sheet. (Note that double, 3 and 4 position valves cannot be used where single solenoid wiring has been specified.)
Note 2) The number of the blanking block is also included.
- SUP/EXH block assembly mounting position**

U	U side (2 to 10 stations)
D	D side (2 to 10 stations)
B	Both sides (2 to 16 stations)
M*	Special specifications

* For special specifications, indicate separately with the manifold specification sheet.
Note) A total of up to 3 SUP/EXH blocks can be mounted. Please contact SMC if 4 or more will be mounted.
- CE-compliant**

Nil	—
Q	CE-compliant
- Option**
When a longer DIN rail is desired than the specified stations, specify the station number to be required.
- SUP/EXH block assembly fitting type**

Nil	Straight
L	Elbow (Upward)
B	Elbow (Downward)
- Pilot type**

Nil	Internal pilot
R	External pilot

How to Order Valve

10 — SZ3 1 60 [] [] **5 LOZ** [] [] **C6** [] []

- Clean series**
- Actuation type**

1	2 position single solenoid
2	2 position double solenoid
3	3 position closed center
4	3 position exhaust center
5	3 position pressure center
A	4 position dual 3 port valve: N.C./N.C.
B	4 position dual 3 port valve: N.O./N.O.
C	4 position dual 3 port valve: N.C./N.O.
- Switch**

Nil	Without switch
J	With switch
- Rated voltage**

5	24 VDC
---	--------
- Back pressure check valve**

Nil	None
K	Built-in

 - The built-in back pressure check valve type has an effective area approximately 20% smaller.
 - The product with back pressure check valve is not available for 3 position solenoid valves.
- Pilot type**

Nil	Internal pilot
R	External pilot

 - External pilot specifications are not available for 4 position dual 3 port valve.
- CE-compliant**

Nil	—
Q	CE-compliant
- Made to Order**

Nil	—
X90	Main valve fluororubber (Refer to page 411.)
- A, B port size**

C4	ø4 One-touch fitting
C6	ø6 One-touch fitting
M5	M5 x 0.5
L4	ø4 Elbow fitting assembly (Upward)
L6	ø6 Elbow fitting assembly (Upward)
B4	ø4 Elbow fitting assembly (Downward)
B6	ø6 Elbow fitting assembly (Downward)
- Manual override**

Nil	Non-locking push type
D	Push-turn locking slotted type

How to Order Valve Manifold Assembly

Ordering example (10-SZ3000, positive common with power supply terminal)

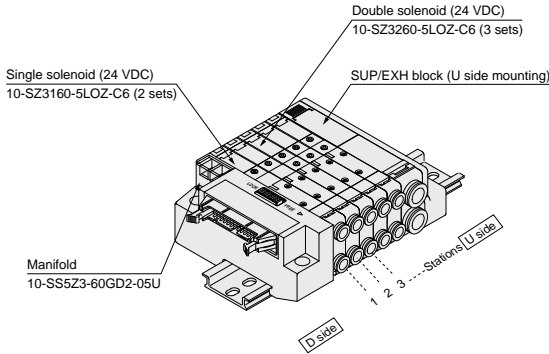

- 10-SS5Z3-60GD2-05U.....1 set (Manifold part no.)
 * 10-SZ3160-5LOZ-C6.....2 sets (Single solenoid part no.)
 * 10-SZ3260-5LOZ-C6.....3 sets (Double solenoid part no.)
- The asterisk denotes the symbol for assembly.
 Prefix it to the part no. of the solenoid valve, etc.
- Stations are counted from the D side as the 1st one.
 - Add the valve part number under the manifold part number.
- For complex arrangements, specify them on the manifold specification sheet.

Manifold Specifications

Model		Flat ribbon cable type 60G
Manifold		Plug-in type
P(SUP)/R(EXH)		Common SUP, EXH
Valve stations ^{Note 1)}		2 to 16 stations
Applicable connector		Flat ribbon cable connector Socket: 20 pin MIL type with strain relief Conforming to MIL-C-83503
A, B port	Location	Valve
Porting specifications	Direction	Lateral
	P, R port	C8
Port size	A/B port	C4, C6, M5
	Weight W(g) ^{Note 2)} (n1: Stations n2: Number of SUP/EXH blocks m: Weight of DIN rail)	$W = 3.2n_1 + 53n_2 + m + 126.5$

Note 1) This manifold is applicable to up to 16 solenoid valves. When many valves are operated simultaneously, use B type (SUP/EXH both sides), applying pressure to the P ports on both sides and exhaust from the R ports on both sides.

Note 2) The weight W is the value for the manifold only. To obtain the weight with solenoid valves attached, add the weight of the solenoid valve stations to that of the manifold. For DIN rail weight, refer to page 384.

Manifold Electrical Wiring

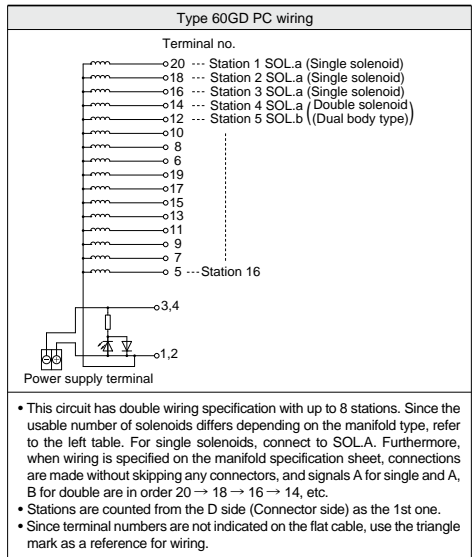

Directional Control Valves

Air Cylinders

Rotary Actuators

Air Grippers

Air Preparation Equipment

Modular F. R.

Pressure Control Equipment

Fittings & Tubing

Flow Control Equipment

Pressure Switches/ Pressure Sensors

Dimensions: 10-SZ3000 for Plug-in

10-SS5Z3-60GD₂ - Stations U-□

[With External Pilot Specifications]

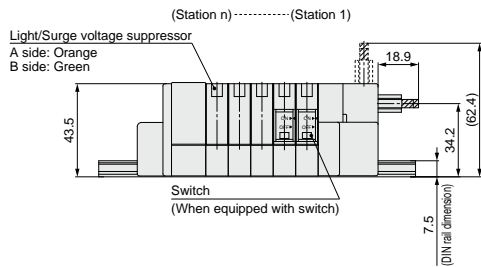
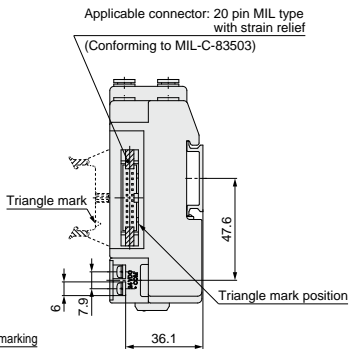
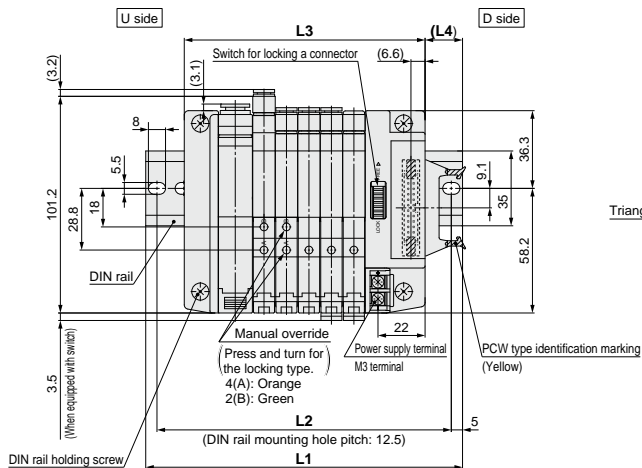
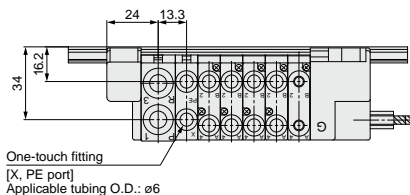
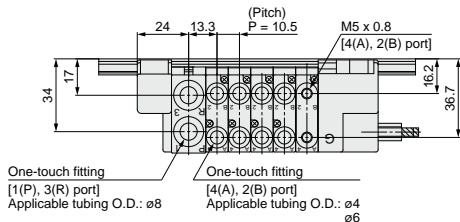

Internal Pilot Manifold L Dimension n: Stations

L \ n	2	3	4	5	6	7	8	9	10
L1	110.5	123	135.5	148	148	160.5	173	185.5	198
L2	100	112.5	125	137.5	137.5	150	162.5	175	187.5
L3	81	91.5	102	112.5	123	133.5	144	154.5	165
L4	15	16	17	18	12.5	13.5	14.5	15.5	16.5

External Pilot Manifold L Dimension n: Stations

L \ n	2	3	4	5	6	7	8	9	10
L1	123	135.5	148	148	160.5	173	185.5	198	210.5
L2	112.5	125	137.5	137.5	150	162.5	175	187.5	200
L3	91.5	102	112.5	123	133.5	144	154.5	165	175.5
L4	16	17	18	12.5	13.5	14.5	15.5	16.5	17.5

Dimensions: 10-SZ3000 for Plug-in

10-SS5Z3-60GD₂ - Stations B-□

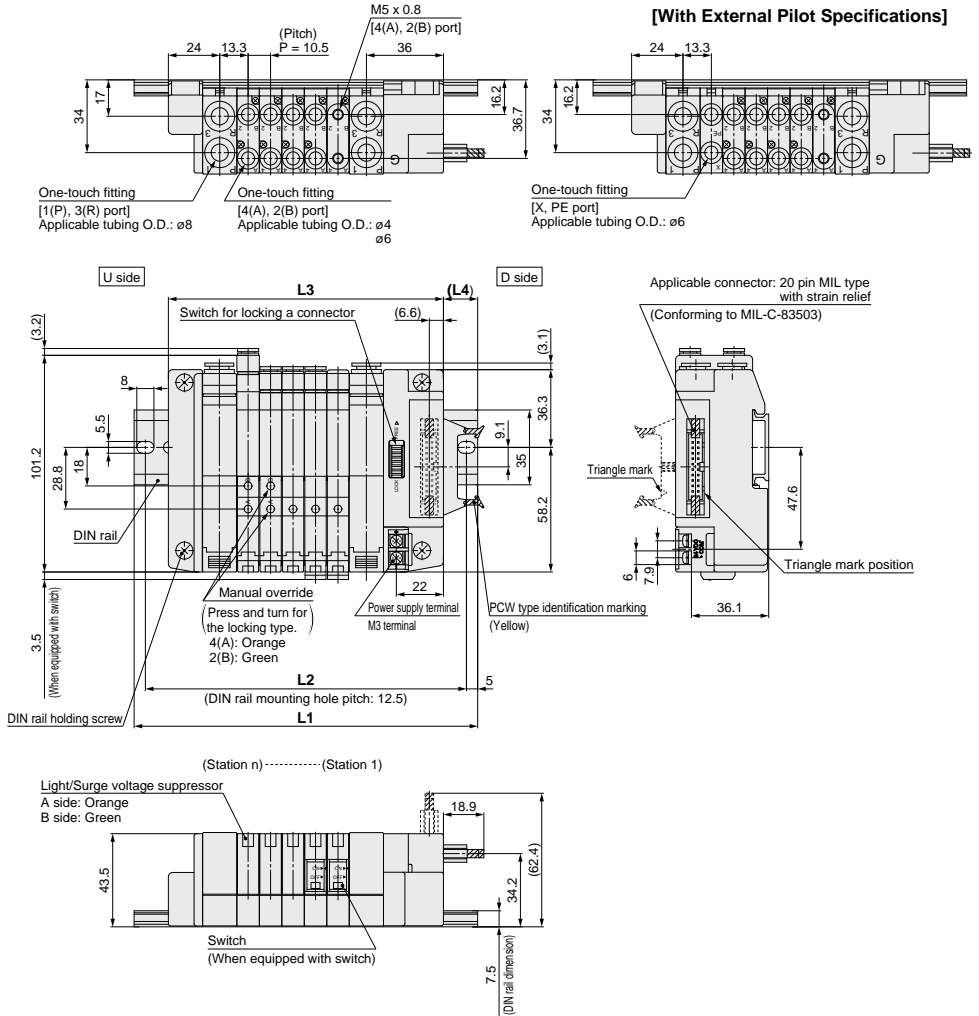

Internal Pilot Manifold L Dimension

L	n	n: Stations															
		2	3	4	5	6	7	8	9	10	11	12	13	14	15	16	
L1	123	135.5	148	160.5	173	173	185.5	198	210.5	223	235.5	248	248	260.5	273		
L2	125	137.5	150	162.5	162.5	175	187.5	200	212.5	225	237.5	237.5	250	262.5			
L3	97	107.5	118	128.5	139	149.5	160	170.5	181	191.5	202	212.5	223	233.5	244		
L4	13	14	15	16	17	12	13	14	15	16	17	18	12.5	13.5	14.5		

External Pilot Manifold L Dimension

L	n	n: Stations															
		2	3	4	5	6	7	8	9	10	11	12	13	14	15	16	
L1	135.5	148	160.5	173	173	185.5	198	210.5	223	235.5	248	248	260.5	273	285.5		
L2	125	137.5	150	162.5	162.5	175	187.5	200	212.5	225	237.5	237.5	250	262.5	275		
L3	107.5	118	128.5	139	149.5	160	170.5	181	191.5	202	212.5	223	233.5	244	254.5		
L4	14	15	16	17	12	13	14	15	16	17	18	12.5	13.5	14.5	15.5		

Directional Control Valves

Air Cylinders

Rotary Actuators

Air Grippers

Air Preparation Equipment

Modular F. R.

Pressure Control Equipment

Fittings & Tubing

Flow Control Equipment

Pressure Switches/Pressure Sensors

Series 10-SZ3000

Made to Order

Please contact SMC for detailed specifications, delivery and pricing.

1 Main Valve Fluororubber Specifications -X90

Symbol

Fluororubber is used for rubber parts of the main valve to allow use in applications such as the following.

1. When using a lubricant other than the recommended turbine oil, and there is a possibility of malfunction due to swelling of the spool valve seals.
2. When ozone enters or is generated in the air supply.

Model no.

10-SZ3 60(R) -X90

- Entry is the same as standard products.
Specifications and performance are the same as standard products.

Note) Because in series -X90 fluororubber is used for only main valve, the rubber parts of the application/usage in conditions requiring heat resistance should be avoided.

2 Plug-in Manifold Connector and Serial Unit Mounted on U Side

Products are also available with the plug-in manifold connector mounting position and the serial unit mounting position on the reverse side (U side). For details about part numbers and wiring specifications, etc., please contact SMC.

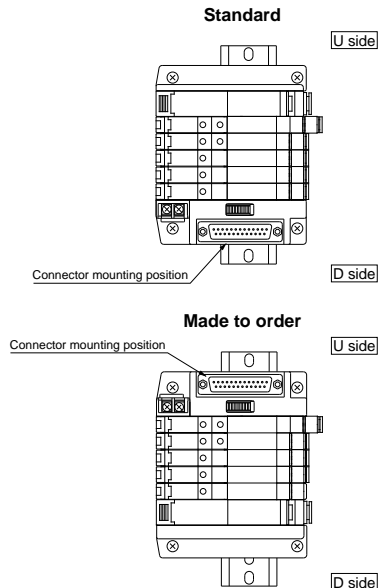

⚠ Specific Product Precautions 1

Be sure to read this before handling.

⚠ Warning

Manual Override Operation

Handle carefully, as connected equipment can be actuated through manual override operation.

■ Non-locking push type

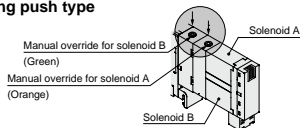

■ Push-turn locking slotted type

While pressing the lock down, turn it in the direction of the arrow. If it does not turn, it can be operated the same way as the non-locking type.

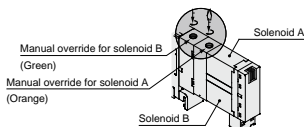

⚠ Caution

When locking the manual override on the push-turn locking slotted type, be sure to push the lock down before turning it. Turning without first pushing it down can cause damage to the manual override and other trouble such as air leakage, etc.

⚠ Warning

Valves with Switches

When turning OFF with the switch, be sure to move the switch to the locked position. Connected equipment may be actuated if current flow occurs with the switch at an improper position.

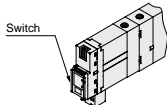

ON position



OFF position



Normal operating state. Switching of valve is based on an electric signal from the connector.

The valve coil is kept in a de-energized state even when there is an electric signal from the connector.

Electric circuit diagram (With positive common and light/surge voltage suppressor)

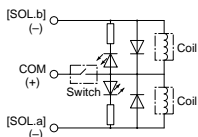

⚠ Caution

How to Use Plug Connector

When attaching and detaching a connector, first shut off the electric power and the air supply.

Also, crimp the lead wires and sockets securely.

1. Attaching and detaching connectors

- To attach a connector, hold the lever and connector unit between your fingers and insert straight onto the pins of the solenoid valve so that the lever's pawl is pushed into the groove and locks.
- To detach a connector, remove the pawl from the groove by pushing the lever downward with your thumb, and pull the connector straight out.

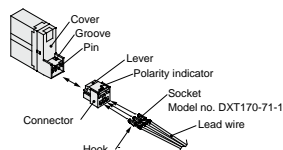

2. Crimping connection of lead wire and socket

Strip 3.2 to 3.7 mm at the end of lead wires, insert the end of the core wires evenly into the sockets, and then crimp it with a crimping tool. When this is done, take care that the coverings of the lead wires do not enter the core wire crimping area. (Crimping tool: Model no. DXT170-75-1)

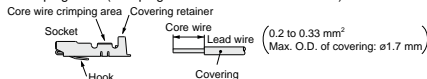

3. Attaching and detaching lead wire with socket

- Attaching**
Insert the sockets into the square holes of the connector (⊕ and ⊖ indication), and continue to push the sockets all the way in until they lock by hooking into the seats in the connector. (When they are pushed in, the hooks open and they are locked automatically.) Then confirm that they are locked by pulling lightly on the lead wires.
- Detaching**
To detach a socket from a connector, pull out the lead wire while pressing the socket's hook with a thin tipped stick (approx. 1 mm). If the socket is to be used again, first spread the hook outward.

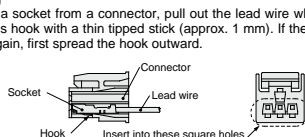

■ Plug connector lead wire length

Standard length is 300 mm, but the following lengths are also available.

How to Order M Type Connector Assembly

Positive common specifications

- For single solenoid: **SX100-40-4S-**
- For double solenoid
- For 3 position type: **SX100-40-4D-**
- For 4 position type

Negative common specifications

- For single solenoid: **SX100-41-4S-**
- For double solenoid
- For 3 position type: **SX100-41-4D-**
- For 4 position type

Lead wire length

Nil	300 mm
6	600 mm
10	1000 mm
15	1500 mm
20	2000 mm
25	2500 mm
30	3000 mm
50	5000 mm

How to Order

Specify the part numbers of the solenoid valve without connector and the connector assembly with protective cover separately.

<Example> Lead wire length 2000 mm
10-SZ3160-5MO-MS
SX100-40-4S-20

Directional Control Valves

Air Cylinders

Rotary Actuators

Air Grippers

Air Preparation Equipment

Modular F. R.

Pressure Control Equipment

Fittings & Tubing

Flow Control Equipment

Pressure Switches/ Pressure Sensors

⚠ Specific Product Precautions 2

Be sure to read this before handling.

⚠ Caution

Common Connector Assembly for Manifold

By using a common connector assembly for the solenoid valves on a manifold, the common wiring for each solenoid valve is reduced to one line, making it possible to achieve labor savings on wiring work.

Common connector assembly part numbers

Positive common specifications

For single solenoid

SX100-42-4S



For double solenoid,
3 position, 4 position types

SX100-42-4D



With common lead wire for
single solenoid

SX100-40-4S



With common lead wire for
double solenoid, 3 position,
4 position types

SX100-40-4D



(Lead wire length 300 mm)

Negative common specifications

For single solenoid

SX100-43-4S



For double solenoid,
3 position, 4 position types

SX100-43-4D



With common lead wire for
single solenoid

SX100-41-4S



With common lead wire for
double solenoid, 3 position,
4 position types

SX100-41-4D



(Lead wire length 300 mm)

How to Order

Include the common connector assembly part number together with the manifold and solenoid valve part numbers. If the arrangement becomes complicated, then indicate on the manifold specification sheet.

Note 1) Take note that applications with unused connectors or with blanking plates between stations are not possible.

Note 2) For the solenoid valve, specify "without connector" for the plug connector type. The grommet type cannot be used.

Note 3) In places where signals will be sent to the common wiring, use a connector assembly with a common lead wire. (This is limited to the first station or the last station of a manifold.)

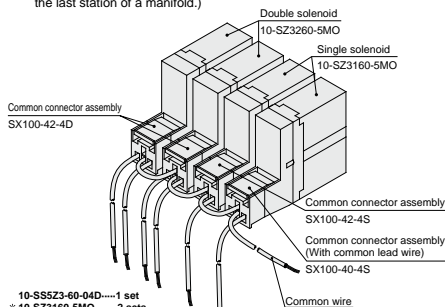

- 10-SS523-60-04D.....1 set
 - * 10-SZ3160-5MO.....2 sets
 - * 10-SZ3260-5MO.....2 sets
 - * SX100-40-4S.....1 set (with common lead wire for single solenoid)
 - * SX100-42-4S.....1 set (For single solenoid)
 - * SX100-42-4D.....2 sets (For double solenoid, for 3 position, for 4 position)
- † The asterisk denotes the symbol for assembly. Prefix it to the part no. of solenoid valve, etc.

Common Connector Assembly Wiring

When ordering common connector assemblies only, wiring should be performed as outlined in the drawing below. For details on attachment of sockets, refer to the How to Use Plug Connector on page 412.

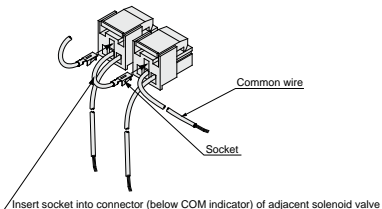

⚠ Caution

One-touch Fittings

The pitch determined for each of the 10-SZ series piping ports (P, A, B, etc.) is based on the assumption that the 10-KQ2 series One-touch fittings will be used. For this reason, other pipe fittings may interfere with each other depending on their type and size. Dimensions should be confirmed in a fitting catalog before they are used.

⚠ Caution

Exhaust Throttle

With the 10-SZ series, the pilot valve and main valve share a common exhaust inside the valve. Therefore, do not block the exhaust port when installing the piping.

⚠ Caution

10-SZ3000 Series Used as a 3 Port Valve

When using a 5 port valve as a 3 port valve

The 10-SZ3000 series valves can be used as normally closed (N.C.) or normally open (N.O.) 3 port valves by closing one of the cylinder ports (A or B) with a plug. However, they should be used with the exhaust ports kept open. They are convenient at times when a double solenoid type 3 port valve is required.

		B port	A port
		N.C.	N.O.
Number of solenoids	Single		
	Double		

⚠ Specific Product Precautions 3

Be sure to read this before handling.

⚠ Caution

Light/Surge Voltage Suppressor

Positive common specifications

Single solenoid type

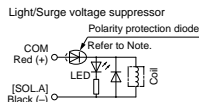

Negative common specifications

Single solenoid type

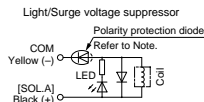

Surge voltage suppressor

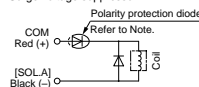

Surge voltage suppressor

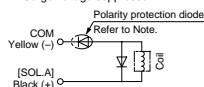

Positive common specifications

Double solenoid, 3 position,
4 position types

Light/surge voltage suppressor

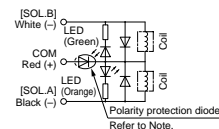

Negative common specifications

Double solenoid, 3 position,
4 position types

Light/surge voltage suppressor

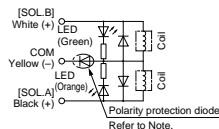

Surge voltage suppressor

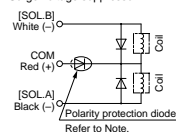

Surge voltage suppressor

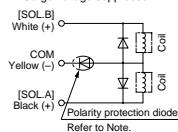

Note) Connect so that polarity is matched to the connector's (+), (-) and A, B and COM indicators. In case of voltage specifications other than 12 or 24 VDC, take care to avoid mistaking polarity, as there is no diode to prevent reverse current.

In the event that lead wires are connected in advance, they will be as shown below.

Positive common specifications

- A (-): **Black**
- COM (+): **Red**
- B (-): **White** (No lead wire in case of single solenoid)

Negative common specifications

- A (+): **Black**
- COM (-): **Yellow**
- B (+): **White** (No lead wire in case of single solenoid)

⚠ Caution

Light Indication

When equipped with indicator light and surge voltage suppressor, the light window turns orange when solenoid A is energized, and it turns green when solenoid B is energized.

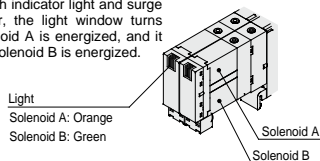

⚠ Caution

Changing the Connector Entry Direction

To change the connector entry direction, set the switch on the top of the connector block to the FREE position, and turn the connector. Make sure to set the switch back to the LOCK position before connecting the connector. (When the switch is difficult to slide, move the connector a little so that it will slide easier.)

If an excessive force is applied on the connector in the LOCK position, the connector floats in the FREE position, it may cause the lead wire, etc. to break. Thus, refrain from using in these ways.

Switch for locking a connector

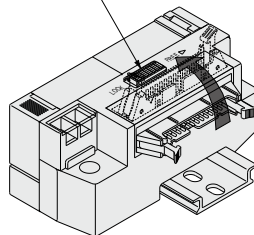

Directional Control Valves

Air Cylinders

Rotary Actuators

Air Grippers

Air Preparation Equipment

Modular F. R.

Pressure Control Equipment

Fittings & Tubing

Flow Control Equipment

Pressure Switches/ Pressure Sensors

⚠ Specific Product Precautions 4

Be sure to read this before handling.

⚠ Caution**One-touch Fittings****1. Tubing attachment/detachment for One-touch fittings****1) Attaching of tubing**

(1) Take a tubing with no flaws on its periphery and cut it off at a right angle. When cutting the tubing, use tube cutters TK-1, 2 or 3. Do not use pinchers, nippers or scissors, etc. If cutting is done with tools other than tube cutter, the tubing may be cut diagonally or become flattened, making a secure installation impossible, and cause problems such as the tubing coming out after installation or air leakage.

Allow some extra length in the tubing.

(2) Grasp the tubing and push it in slowly, inserting it securely all the way into the fitting.

(3) After inserting the tubing, pull on it lightly to confirm that it will not come out. If it is not installed securely all the way into the fitting, this can cause problems such as air leakage or the tubing coming out.

2) Detaching of tubing

(1) Push in the release button sufficiently, pushing its collar equally around the circumference.

(2) Pull out the tubing while holding down the release button so that it does not come out. If the release button is not pressed down sufficiently, there will be increased bite on the tubing and it will become more difficult to pull it out.

(3) When the removed tubing is to be used again, cut off the portion which had been secured before reusing it. If the same portion of the tubing is reused, this can cause trouble such as air leakage or difficulty in removing the tubing.

⚠ Caution**Other Tubing Brands**

1. When using tubing other than SMC brand tubing, confirm that the following specifications are satisfied with respect to the outside diameter tolerance of the tubing.

- 1) Nylon tubing within ± 0.1 mm
- 2) Soft nylon tubing within ± 0.1 mm
- 3) Polyurethane tubing within $+0.15$ mm, within -0.2 mm

Do not use tubing which do not meet these outside diameter tolerances. It may not be possible to connect them, or they may cause other trouble, such as air leakage or the tubing coming out after connection.

⚠ Caution**Built-in Back Pressure Check Valve**

1. Valves with built-in back pressure check valve are to protect the back pressure inside a valve. For this reason, use caution that the valves with external pilot specifications cannot be pressurized from exhaust port [3(R)]. As compared with the types which do not integrate the back pressure check valve, C value of the flow rate characteristics goes down. For details, please contact SMC.
2. Do not switch valves when A or B port is open to the atmosphere, or while the actuators and air operated equipment are in operation. The back pressure prevention seal may be peeled off, which may cause air leakage or malfunctions. Use caution especially when performing a trial operation or maintenance work.

Pressure Switches/
Pressure Sensors

Flow Control
Equipment

Fittings & Tubing

Pressure Control
Equipment

Modular F. R.

Air Preparation
Equipment

Air Grippers





Rotary Actuators

Air Cylinders

Directional
Control Valves

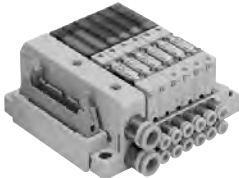
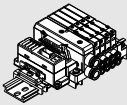
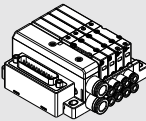
Series 10-S0700 5 Port Solenoid Valve

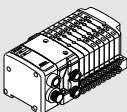
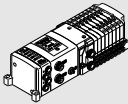
Variations

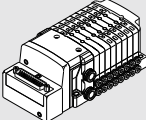
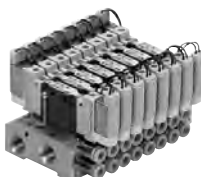
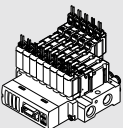
	S kit Serial Transmission (Fieldbus System)				F kit D-sub Connector
	EX500 Gateway-type Serial Transmission System	EX510 Gateway-type Serial Transmission System	EX250 For Input/Output Serial Transmission System	EX600 For Input/Output Serial Transmission System	MIL Standard
	Applicable Network · DeviceNet™ · PROFIBUS DP · CC-Link · EtherNet/IP™	Applicable Network · DeviceNet™ · PROFIBUS DP · CC-Link	Applicable Network · DeviceNet™ · PROFIBUS DP · CANopen · CC-Link · AS-Interface · EtherNet/IP™	Applicable Network · DeviceNet™ · PROFIBUS DP · CC-Link	
Slim Compact Plug-in Manifold Bar Base 	—	 Page 425	—	 Page 429	
Plug-in Manifold Stacking Base 	 Page 447	—	 Page 449	 Page 451	 Page 457
Plug Lead Manifold Bar Base 	—	 Page 495	—	—	—

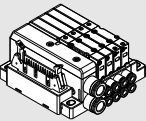
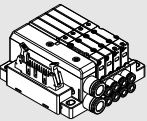
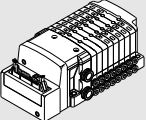
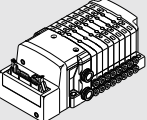
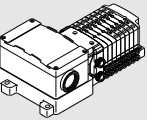
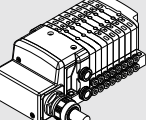
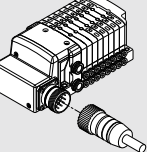
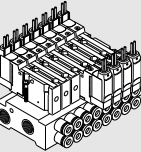
P kit Flat Ribbon Cable	J kit PC Wiring System Compatible Flat Ribbon Cable	T kit Terminal Block Box	L kit Lead Wire	M kit Circular Connector	C kit Connector
MIL Standard · 26 pins, 20 pins	MIL Standard · 20 pins				
 Page 433	 Page 437	—	—	—	—
 Page 461	 Page 465	 Page 469	 Page 473	 Page 477	—
—	—	—	—	—	 Page 491

Directional Control Valves
 Air Cylinders
 Rotary Actuators
 Air Grippers
 Air Preparation Equipment
 Modular F. R.
 Pressure Control Equipment
 Fittings & Tubing
 Flow Control Equipment
 Pressure Switches/ Pressure Sensors

Options

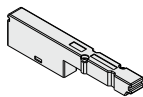
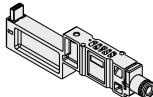
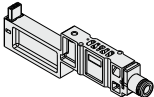
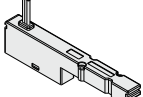

Slim Compact Plug-in Manifold Bar Base / Options

<p>Blanking plate SS0700-10A-3 Page 440</p> 	<p>Individual SUP spacer S0700-P-3-C Page 440</p> 	<p>Individual EXH spacer S0700-R-3-C Page 440</p> 	<p>Blanking plate with output SS0700-1C3- Page 440</p> 
---	---	---	--

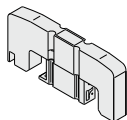
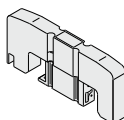
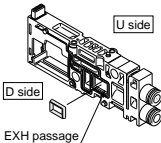
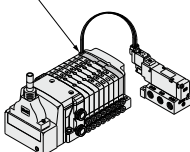
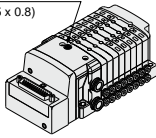
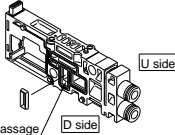
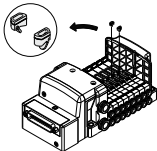
Plug-in Manifold Stacking Base / Options

<p>Blanking plate SS0700-10A-1 Page 481</p> 	<p>Individual SUP/EXH spacer SS0700-PR-1 Page 481</p> 	<p>EXH block plate SS0700-B-R Page 482</p> 	<p>Blanking plate with output SS0700-1C- Page 483</p> <p>Blanking plate with output</p> 
<p>External pilot [-R] Page 481</p> <p>External pilot port (M5 x 0.8)</p> 	<p>SUP block plate SS0700-B-P Page 482</p> 	<p>Back pressure check valve [-B] SS0700-7A-1 Page 482</p> 	

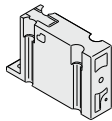
Plug Lead Manifold Bar Base / Options

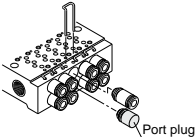
<p>Blanking plate SS0700-10A-5 Page 497</p> 	<p>Individual SUP spacer SS0700-P-5-M5 Page 497</p>  <p>* Compatible with 8.5 mm pitch only</p>	<p>Individual EXH spacer SS0700-R-5-M5 Page 497</p>  <p>* Compatible with 8.5 mm pitch only</p>	<p>Port plug VVQ0000-CP Page 497</p>  <p>Port plug</p>
---	--	--	--

External pilot [-R]
Page 441

External pilot port
(M5 x 0.8)

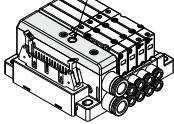

DIN rail mounting bracket
SS0700-57A-3 Page 441

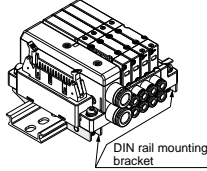

Port plug
VVQ000-CP Page 483

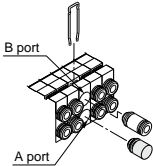

Blanking plug
(For One-touch fitting)
KJP-02
KQ2P-23/04/06 Page 483

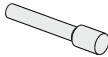

DIN rail mounting bracket
SS0700-57A-□ Page 483

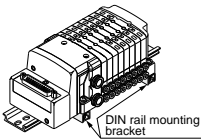

Name plate [-N]
SS0700-N-Station (1 to Max. stations)
Page 484

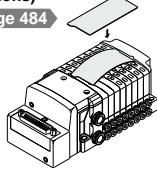

External pilot [-R]
Page 497

External pilot port
(M3 x 0.5)

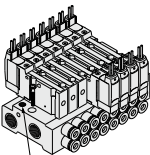

Blanking plug
(For One-touch fitting)
KJP-02
KQ2P-23/04/06 Page 498

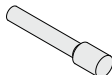

Directional Control Valves

Air Cylinders

Rotary Actuators

Air Grippers

Air Preparation Equipment

Modular F. R.

Pressure Control Equipment

Fittings & Tubing

Flow Control Equipment

Pressure Switches/ Pressure Sensors

Valve Specifications

Valve Specifications

Model

Series	Actuation type	Model	Flow rate characteristics						Note 2) Response time (msec)	Weight (g)	
			1→4/2 (P→A/B)			4/2→5/3 (A/B→R1/R2)					
			C [dm ³ /(s·bar)]	b	Cv	C [dm ³ /(s·bar)]	b	Cv			
Slim compact Plug-in manifold Bar base	2-position	Single	S0711	0.39	0.39	0.11	0.37	0.39	0.10	18 or less	36
		Double	S0721	0.39	0.39	0.11	0.37	0.39	0.10	10 or less	41
	4-position	Dual 3-port valve	S07 ^A _B _C	0.34	0.34	0.09	0.33	0.33	0.08	18 or less	41
Plug-in manifold Stacking base	2-position	Single	S0710	0.39	0.39	0.11	0.37	0.39	0.10	18 or less	30
		Double	S0720	0.39	0.39	0.11	0.37	0.39	0.10	10 or less	38
	4-position	Dual 3-port valve	S07 ^A _B _C	0.34	0.34	0.09	0.33	0.33	0.08	18 or less	38
Plug lead manifold Bar base	2-position	Single	S0715	0.39	0.39	0.11	0.37	0.39	0.10	12 or less	28
		Double	S0725	0.39	0.39	0.11	0.37	0.39	0.10	10 or less	36
	4-position	Dual 3-port valve	S07 ^A _B _C	0.34	0.34	0.09	0.33	0.33	0.08	12 or less	36

Note 1) Values for cylinder port fitting size C6

Note 2) Based on JIS B 8375-1993 (Supply pressure: 0.5 MPa, with indicator light and surge voltage suppressor, clean air. This will change depending on pressure and air quality.) The value when ON for the double type.

Specifications

Valve specifications	Valve construction		Rubber seal
	Fluid		Air/Inert gas
	Max. operating pressure		0.7 MPa
	Min. operating pressure		0.2 MPa
	Ambient and fluid temperature		-10 to 50°C ^{Note 1)}
	Max. operating cycle		5 Hz
	Pilot valve exhaust method		Common exhaust ^{Note 2)}
	Pilot valve manual override		Push type
	Lubrication		Not required
	Impact/Vibration resistance ^{Note 3)}		30/100 m/s ²
Electrical specifications	Enclosure		IP40
	Coil rated voltage		24 VDC
	Allowable voltage fluctuation		±10% of rated voltage
	Coil insulation type		Class B or equivalent
	Power consumption (Current)	24 VDC	DC 0.35 W (15 mA)

Note 1) Use dry air to prevent condensation when operating at low temperatures.

Note 2) Since the pilot EXH of valves with the external pilot specification also has a common exhaust specification, the 3(R) port should be released to the atmosphere.

Note 3) Impact resistance: No malfunction occurred when it was tested with a drop tester in the axial direction and at right angles to the main valve and armature in both energized and de-energized states once for each condition.

Vibration resistance: No malfunction occurred in a one-sweep test between 8.3 and 2000 Hz. Test was performed in both energized and de-energized states in the axial direction and at right angles to the main valve and armature.

Manifold Specifications

Manifold Specifications

Model

Base model		Piping specifications		Connection type	Note 1) Applicable stations	Note 3) 5-station weight (g)	Note 3) Addition per station (g)
		Port size					
		1(P), 3(R)	4(A), 2(B)				
Slim compact Plug-in manifold Bar base	10-SS0751-□□□□	C6 (ø6) C8 (ø8) N7 (ø1/4") N9 (ø5/16") Option (Direct EXH outlet with built-in silencer)	C2 (ø2) C3 (ø3.2) C4 (ø4) N1 (ø1/8") N3 (ø5/32")	S kit: Serial transmission (EX510)	Max. 16 stations	320	19 Note 7)
				F kit: D-sub connector	Max. 24 stations	185	17
				P kit: Flat ribbon cable	Max. 24 stations	181	17
				J kit: PC wiring compatible flat ribbon cable	Max. 16 stations	181	17
Plug-in manifold Stacking base	10-SS0750-□□□□	C6 (ø6) C8 (ø8) N7 (ø1/4") N9 (ø5/16") Option (Direct EXH outlet with built-in silencer)	C2 (ø2) C3 (ø3.2) C4 (ø4) N1 (ø1/8") N3 (ø5/32")	S kit: Serial transmission (EX500)	Max. 16 stations	360	20
				S kit: Serial transmission (EX250)	Max. 24 stations Note 2)	560 Note 4)	20
				F kit: D-sub connector	Max. 24 stations	330	20
				P kit: Flat ribbon cable	Max. 24 stations	325	20
				J kit: PC wiring compatible flat ribbon cable	Max. 16 stations	325	20
				T kit: Terminal block box	Max. 20 stations	660	20
				L kit: Lead wire	Max. 24 stations	455 Note 5)	20
M kit: Circular connector	Max. 24 stations	390	20				
Plug lead manifold Bar base	10-SS0755-□□□□ (Manifold pitch: 8.5 mm*)	Rc1/8	M5 thread C2 (ø2) C3 (ø3.2) C4 (ø4) N1 (ø1/8") N3 (ø5/32")	C kit: Connector	Max. 20 stations	115	20
				S kit: Serial transmission (EX510)	Max. 16 stations	115	20
Single unit	10-S07□5-5□-M5	M5 thread	M5 thread	Connector kit	—	14 Note 6)	

Note 1) Maximum stations for mixed single and double wiring (special wiring specifications)

Note 2) Differs depending on the serial unit type. For details, refer to page 449.

Note 3) Weight excluding valve. Refer to page 421 for valve weight.

Note 4) Weight with one input block

Note 5) Weight with lead wire length 0.6 m

Note 6) Weight of sub-plate only. Refer to page 421 for valve weight.

Note 7) Including DIN rail weight

* The manifold pitch 7.5 mm type is available as special order.

Directional Control Valves

Air Cylinders

Rotary Actuators

Air Grippers

Air Preparation Equipment

Modular F. R.

Pressure Control Equipment

Fittings & Tubing

Flow Control Equipment

Pressure Switches/ Pressure Sensors

Cylinder Speed Chart

Use as a guide for selection.
Please confirm the actual conditions with
SMC Model Selection Software.

Base Mounted

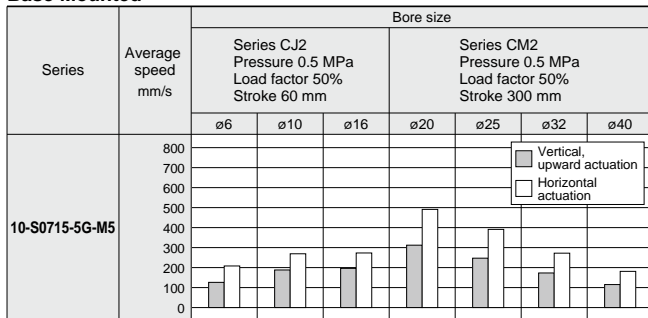

- * It is when the cylinder is extending that is meter-out controlled by speed controller which is directly connected with cylinder, and its needle valve with being fully open.
- * The average velocity of the cylinder is what the stroke is divided by the total stroke time.
- * Load factor: ((Load mass x 9.8)/Theoretical force) x 100%

Conditions

Base mounted		Series CJ2	Series CM2
10-S0715-5G-M5	Tubing diameter x Length	ø6 x 1 m	
	Speed controller	AS2001F-06	AS2301F-06
	Silencer	AN120-M5	

Symbol

Model	Actuation type	Symbol
10-S0710 10-S0711 10-S0715	2-position single	
10-S0720 10-S0721 10-S0725	2-position double	
10-S07A0 10-S07A1 10-S07A5	4-position dual 3-port (N.C. + N.C.) [Exhaust center]	
10-S07B0 10-S07B1 10-S07B5	4-position dual 3-port (N.O. + N.O.) [Pressure center]	
10-S07C0 10-S07C1 10-S07C5	4-position dual 3-port (N.C. + N.O.)	

Slim Compact Plug-in Manifold Bar Base

Serial Transmission

S kit

Slim Compact
Plug-in Manifold
Bar Base

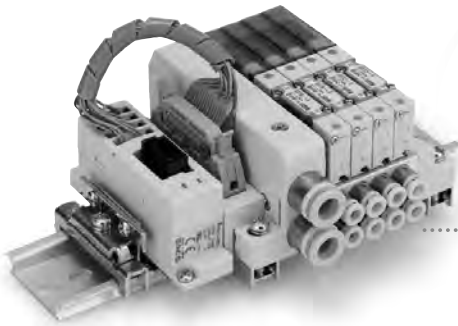

Gateway-type
Serial Transmission
System
EX510



Page 425

Directional
Control Valves

Air Cylinders

Rotary Actuators

Air Grippers

Air Preparation
Equipment

Modular F. R.

Pressure Control
Equipment

Fittings & Tubing

Flow Control
Equipment

Pressure Switches/
Pressure Sensors



Series 10-S0700 Slim Compact Plug-in Manifold Bar Base kit (Serial Transmission) EX510 Gateway-type Serial Transmission System

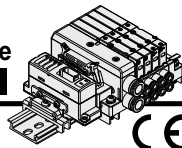

How to Order Manifold

10-SS0751-08 C4 C8 SB -

Clean series

Stations

Symbol	Stations
01	1 station
:	:
16 (Note)	16 stations

Note) The maximum number of stations will be different depending on the wiring specifications.

Cylinder port size

Symbol	Port size	
C2	With ø2 One-touch fitting	Metric
C3	With ø3.2 One-touch fitting	
C4	With ø4 One-touch fitting	
N1	With ø1/8" One-touch fitting	Inch
N3	With ø5/32" One-touch fitting	

Standard station	Max. number of stations for special wiring specifications	Max. number of solenoids
1 to 8 stations	16 stations	16

Actuation type	Single	Double, Dual 3-port
Number of solenoids	1	2

P, R port size

Symbol	Port size	
Nil	With ø8 One-touch fitting (Note)	Metric
C6	With ø6 One-touch fitting	
C8	With ø8 One-touch fitting	
N7	With ø1/4" One-touch fitting	Inch
N9	With ø5/16" One-touch fitting	

Note) The P, R port size is ø5/16" when the cylinder ports are inch sizes.

Option

Symbol	Specifications
Nil	None
K (Note 2)	Special wiring specifications (Except double wiring)
R (Note 3)	External pilot

Note 1) When two or more options are specified, indicate them alphabetically.
Example) -KR

Note 2) Indicate the wiring specifications for mixed single and double wirings.

Note 3) For details, refer to page 441.

* For manifold optional parts, refer to pages 440 and 441.

* For manifold exploded view, refer to page 443.

SI unit output polarity

SI unit output polarity	
Nil	+COM.
N	-COM.

S kit
EX510 serial wiring

Refer to the **WEB catalog** for details on the EX510 Gateway-type Serial Transmission System.

How to Order Valve

10-S07 1 1 - 5

Clean series

Actuation type

Symbol	Specifications
1	2-position single
2	2-position double
A	4-position dual 3-port (N.C. + N.C.) [Exhaust center]
B	4-position dual 3-port (N.O. + N.O.) [Pressure center]
C	4-position dual 3-port (N.C. + N.O.)

Note) For symbol, refer to page 423.

Voltage: 24 VDC

Function

Symbol	Specifications
Nil	Standard
R	External pilot (Note)

Note) Not compatible with dual 3-port valves. The 3(R) port is released to the atmosphere. (Pressurization and vacuum are not allowed.)

Base mounted plug-in

How to Order Manifold Assembly

Specify the part numbers for valves and options together beneath the manifold base part number.

<Example>

Serial transmission kit

10-SS0751-08C4C8SB...1 set - Manifold base part no.

* 10-S0711-5 3 sets - Valve part no. (Stations 1 to 3)

* 10-S0721-5 2 sets - Valve part no. (Stations 4 to 5)

* 10-S07A1-5 2 sets - Valve part no. (Stations 6 to 7)

* SS0700-10A-3 1 set - Blanking plate part no. (Station 8)

Prefix the asterisk to the part no. of the solenoid valve, etc.

Write sequentially from the 1st station on the D side. When part no. written collectively are complicated, specify on the manifold specification sheet.

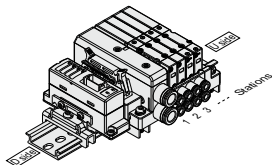

10-SS0751
S kit (Serial transmission: EX510)

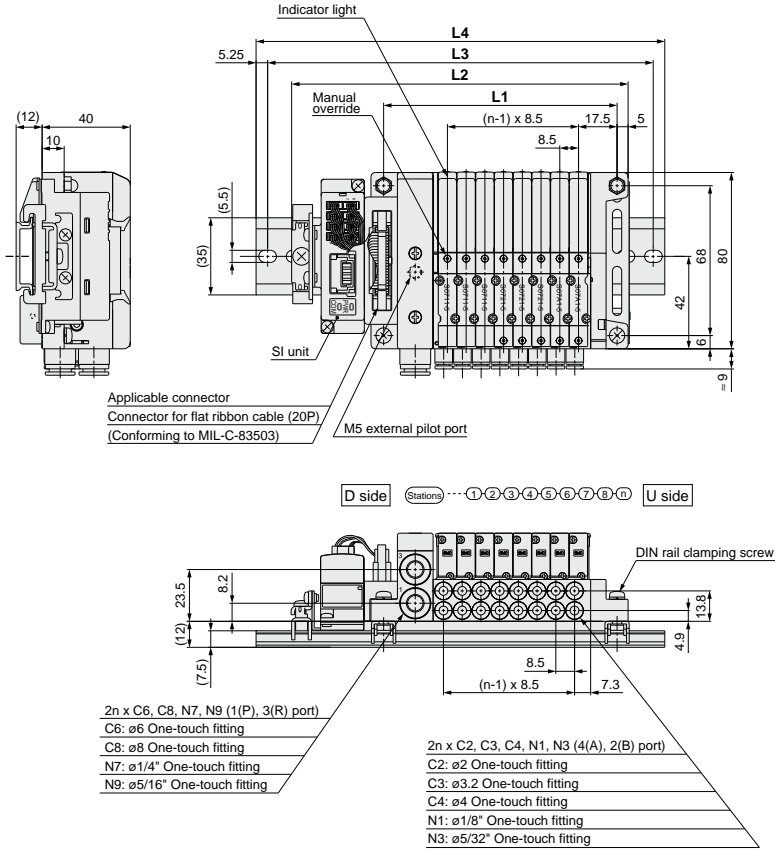

Dimensions

Formula L1 = 8.5n + 38, L2 = 8.5n + 84.7 n: Station (Maximum 16 stations)

L \ n	2	3	4	5	6	7	8	9	10	11	12	13	14	15	16
L1	55	63.5	72	80.5	89	97.5	106	114.5	123	131.5	140	148.5	157	165.5	174
L2	101.7	110.2	118.7	127.2	135.7	144.2	152.7	161.2	169.7	178.2	186.7	195.2	203.7	212.2	220.7
L3	125	137.5	150	150	162.5	175	175	187.5	200	200	212.5	225	225	237.5	250
L4	135.5	148	160.5	160.5	173	185.5	185.5	198	210.5	210.5	223	235.5	235.5	248	260.5

Slim Compact Plug-in Manifold Bar Base

D-sub Connector

F kit

Slim Compact
Plug-in Manifold
Bar Base



MIL Standard

- 25 pins
- Cable length:
1.5 m, 3 m, 5 m

Page 429



Directional
Control Valves

Air Cylinders

Rotary Actuators

Air Grippers

Air Preparation
Equipment

Modular F. R.

Pressure Control
Equipment

Fittings & Tubing

Flow Control
Equipment

Pressure Switches/
Pressure Sensors

F

Series 10-S0700 Slim Compact Plug-in Manifold Bar Base kit (D-sub Connector)

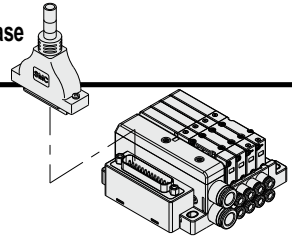

- The D-sub connector reduces installation labor for electrical connections.
- Using the D-sub connector (25P) conforming to MIL standard permits the use of commercial connectors and gives a wide interchangeability.

Electrical Wiring Specifications

D-sub connector

As the standard electrical wiring specifications, double wiring (connected to SOL.A and SOL.B) is adopted for the internal wiring of each station for 12 stations or less, regardless of valve and option types. Mixed single and double wiring is available as an option. For details, refer to "Special Wiring Specifications" (Option) below.

D-sub connector assembly wire color (AXT100-DS25-015 to 050)

Terminal no.	Polarity	Lead wire color	Dot marking
Station 1 SOL.A 1	(-)	(+)	Black None
Station 1 SOL.B 14	(-)	(+)	Yellow Black
Station 2 SOL.A 2	(-)	(+)	Brown None
Station 2 SOL.B 15	(-)	(+)	Pink Black
Station 3 SOL.A 3	(-)	(+)	Red None
Station 3 SOL.B 16	(-)	(+)	Blue White
Station 4 SOL.A 4	(-)	(+)	Orange None
Station 4 SOL.B 17	(-)	(+)	Purple None
Station 5 SOL.A 5	(-)	(+)	Yellow None
Station 5 SOL.B 18	(-)	(+)	Gray None
Station 6 SOL.A 6	(-)	(+)	Pink None
Station 6 SOL.B 19	(-)	(+)	Orange Black
Station 7 SOL.A 7	(-)	(+)	Blue None
Station 7 SOL.B 20	(-)	(+)	Red White
Station 8 SOL.A 8	(-)	(+)	Purple White
Station 8 SOL.B 21	(-)	(+)	Brown White
Station 9 SOL.A 9	(-)	(+)	Gray Black
Station 9 SOL.B 22	(-)	(+)	Pink Red
Station 10 SOL.A 10	(-)	(+)	White Black
Station 10 SOL.B 23	(-)	(+)	Gray Red
Station 11 SOL.A 11	(-)	(+)	White Red
Station 11 SOL.B 24	(-)	(+)	Black White
Station 12 SOL.A 12	(-)	(+)	Yellow Red
Station 12 SOL.B 25	(-)	(+)	White None
COM. 13	(+)	(-)	Orange Red

Note) Mounting valve has no polarity. It can also be used as a negative common.

Special Wiring Specifications (Option) [-K]

Mixed single and double wiring are available as an option. The maximum number of manifold stations is determined by the number of solenoids. Count one point for a single solenoid type and two points for a double solenoid type. The total number of solenoids (points) must not exceed 24.

1. How to Order valve
Indicate an option symbol, -K, for the manifold part number and be sure to specify the mounting position and number of stations of the single and double wiring on the manifold specification sheet.

2. Wiring specifications
Connector terminal numbers are connected from solenoid station 1 on the A side in the order indicated by the arrows without skipping any terminal numbers.

Cable Assembly

AXT100-DS25-030
015
050

(The D-sub connector cable assemblies can be ordered with manifolds.)
Refer to "How to Order Manifold."

D-sub connector cable assembly Wire Color by Terminal No.

Terminal no.	Lead wire color	Dot marking
1	Black	None
2	Brown	None
3	Red	None
4	Orange	None
5	Yellow	None
6	Pink	None
7	Blue	None
8	Purple	White
9	Gray	Black
10	White	Black
11	White	Red
12	Yellow	Red
13	Orange	Red
14	Yellow	Black
15	Pink	Black
16	Blue	White
17	Purple	None
18	Gray	None
19	Orange	Black
20	Red	White
21	Brown	White
22	Pink	Red
23	Gray	Red
24	Black	White
25	White	None

D-sub Connector Cable Assembly (Option)

Cable length (L)	Assembly part no.	Note
1.5 m	AXT100-DS25-015	
3 m	AXT100-DS25-030	Cable 0.3 mm ² x 25 cores
5 m	AXT100-DS25-050	

* For other commercial connectors, use a 25-pin type with female connector conforming to MIL-C-24308.
* Cannot be used for movable wiring.

Example of connector manufacturers

- Fujitsu Limited
- Japan Aviation Electronics Industry, Limited
- J.S.T. Mfg. Co., Ltd.
- HIROSE ELECTRIC CO., LTD.

Note) The minimum bending radius of D-sub connector cable is 20 mm.





How to Order Manifold

10-SS0751-08 C4 C8 FD1 -

Clean series

Stations

Symbol	Stations
01	1 station
:	:
24 ^(Note)	24 stations

(Note) The maximum number of stations will be different depending on the wiring specifications.

Cylinder port size

Symbol	Port size	
C2	With ø2 One-touch fitting	Metric
C3	With ø3.2 One-touch fitting	
C4	With ø4 One-touch fitting	Inch
N1	With ø1/8" One-touch fitting	
N3	With ø5/32" One-touch fitting	

P, R port size

Symbol	Port size	
Nil	With ø8 One-touch fitting ^(Note)	Metric
C6	With ø6 One-touch fitting	
C8	With ø8 One-touch fitting	Inch
N7	With ø1/4" One-touch fitting	
N9	With ø5/16" One-touch fitting	

(Note) The P, R port size is ø5/16" when the cylinder ports are inch sizes.

Option

Symbol	Specifications
Nil	None
D	With DIN rail (Rail length: Standard)
D0	Without DIN rail (With bracket)
D□ ^(Note 2)	With DIN rail Designated length (□: Station)
K ^(Note 3)	Special wiring specifications (Except double wiring)
R ^(Note 4)	External pilot

Note 1) When two or more options are specified, indicate them alphabetically. Example) -DKR
Note 2) The available number of stations is larger than the number of manifold stations.

Note 3) Indicate the wiring specifications for mixed single and double wirings.

Note 4) For details, refer to page 441.

* For manifold optional parts, refer to pages 440 to 441.

* For manifold exploded view, refer to page 443.

Kit type/Cable length

Kit type	Symbol	Specifications	Standard station	Max. number of stations for special wiring specifications	Max. number of solenoids
F kit	FD0	D-sub connector (25P), without cable	1 to 12 stations	24 stations	24
	FD1	D-sub connector (25P), with 1.5 m cable			
	FD2	D-sub connector (25P), with 3.0 m cable			
	FD3	D-sub connector (25P), with 5.0 m cable			

(Note) The maximum number of stations is determined by the total number of solenoids. For mixed single and double wirings, enter "-K" to the order code options.

Actuation type	Single	Double, Dual 3-port
Number of solenoids	1	2

How to Order Valve

10-S07 1 1 - 5

Clean series

Actuation type

Symbol	Specifications
1	2-position single
2	2-position double
A	4-position dual 3-port (N.C. + N.C.) [Exhaust center]
B	4-position dual 3-port (N.O. + N.O.) [Pressure center]
C	4-position dual 3-port (N.C. + N.O.)

(Note) For symbol, refer to page 423.

Voltage

Symbol	Specifications
5	24 VDC
6	12 VDC

Function

Symbol	Specifications
Nil	Standard
R	External pilot ^(Note)

(Note) Not compatible with dual 3-port valves. The 3(R) port is released to the atmosphere. (Pressurization and vacuum are not allowed.)

Base mounted plug-in

How to Order Manifold Assembly

Specify the part numbers for valves and options together beneath the manifold base part number.

<Example>

D-sub connector kit
 10-SS0751-08C4C8FD1...1 set - Manifold base part no.
 = 10-S0711-5 3 sets - Valve part no. (Stations 1 to 3)
 = 10-S0721-5 2 sets - Valve part no. (Stations 4 to 5)
 = 10-S07A1-5 2 sets - Valve part no. (Stations 6 to 7)
 = SS0700-10A-3 1 set - Blanking plate part no. (Station 8)

Write sequentially from the 1st station on the D side. When part no. written collectively are complicated, specify on the manifold specification sheet.

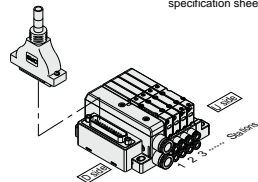

Directional Control Valves

Air Cylinders

Rotary Actuators

Air Grippers

Air Preparation Equipment

Modular F. R.

Pressure Control Equipment

Fittings & Tubing

Flow Control Equipment

Pressure Switches/ Pressure Sensors

F

Series 10-S0700 kit (D-sub Connector)

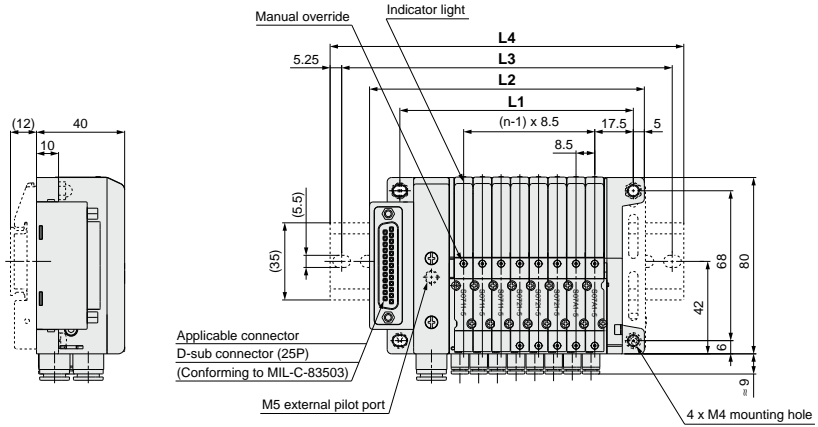

D side Stations ① ② ③ ④ ⑤ ⑥ ⑦ ⑧ n U side

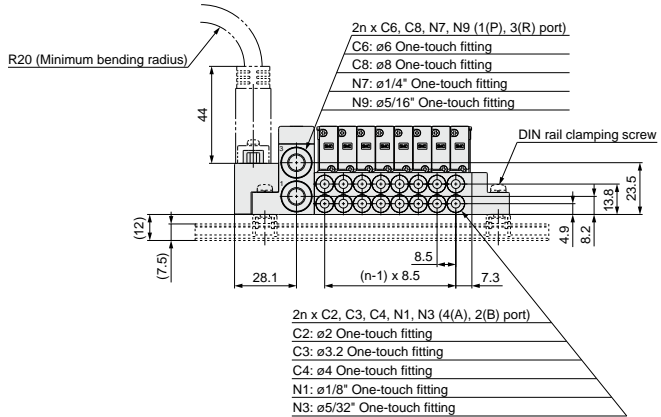

Dimensions

Formula L1 = 8.5n + 38, L2 = 8.5n + 56.7 n: Station (Maximum 24 stations)

L \ n	2	3	4	5	6	7	8	9	10	11	12	13	14	15	16	17	18	19	20	21	22	23	24
L1	55	63.5	72	80.5	89	97.5	106	114.5	123	131.5	140	148.5	157	165.5	174	182.5	191	199.5	208	216.5	225	233.5	242
L2	73.7	82.2	90.7	99.2	107.7	116.2	124.7	133.2	141.7	150.2	158.7	167.2	175.7	184.2	192.7	201.2	209.7	218.2	226.7	235.2	243.7	252.2	260.7
L3	100	112.5	112.5	125	137.5	150	162.5	175	187.5	187.5	200	212.5	212.5	225	237.5	237.5	250	262.5	262.5	275	275	287.5	287.5
L4	110.5	123	123	135.5	148	148	160.5	173	173	185.5	198	198	210.5	223	223	235.5	248	248	260.5	273	285.5	285.5	298

Slim Compact Plug-in Manifold Bar Base

Flat Ribbon Cable

P kit

Slim Compact
Plug-in Manifold
Bar Base



MIL Standard

- 26 pins, 20 pins
- Cable length:
1.5 m, 3 m, 5 m

Page 433



Directional
Control Valves

Air Cylinders

Rotary Actuators

Air Grippers

Air Preparation
Equipment

Modular F. R.

Pressure Control
Equipment

Fittings & Tubing

Flow Control
Equipment

Pressure Switches/
Pressure Sensors

P Series 10-S0700 Slim Compact Plug-in Manifold Bar Base kit (Flat Ribbon Cable)

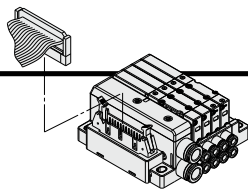

- Flat ribbon cable connector reduces installation labor for electrical connection.
- Using the connector for flat ribbon cable (26P, 20P) conforming to MIL standard permits the use of commercial connectors and gives a wide interchangeability.

Electrical Wiring Specifications

Flat ribbon cable connector

Double wiring (connected to SOL.A and SOL.B) is adopted for the internal wiring of each station, regardless of valve and option types. Mixed single and double wiring is available as an option. For details, refer to "Special Wiring Specifications" (Option) below.

Connector terminal no.
Triangle mark indicator position

26 □	□ 25
24 □	□ 23
22 □	□ 21
20 □	□ 19
18 □	□ 17
16 □	□ 15
14 □	□ 13
12 □	□ 11
10 □	□ 9
8 □	□ 7
6 □	□ 5
4 □	□ 3
2 □	□ 1

<26P>

Terminal no.	Polarity
SOL.A ₁	(-)
SOL.B ₁	(+)
SOL.A ₂	(-)
SOL.B ₂	(+)
SOL.A ₃	(-)
SOL.B ₃	(+)
SOL.A ₄	(-)
SOL.B ₄	(+)
SOL.A ₅	(-)
SOL.B ₅	(+)
SOL.A ₆	(-)
SOL.B ₆	(+)
SOL.A ₇	(-)
SOL.B ₇	(+)
SOL.A ₈	(-)
SOL.B ₈	(+)
SOL.A ₉	(-)
SOL.B ₉	(+)
SOL.A ₁₀	(-)
SOL.B ₁₀	(+)
SOL.A ₁₁	(-)
SOL.B ₁₁	(+)
SOL.A ₁₂	(-)
SOL.B ₁₂	(+)
SOL.A ₁₃	(-)
SOL.B ₁₃	(+)
SOL.A ₁₄	(-)
SOL.B ₁₄	(+)
SOL.A ₁₅	(-)
SOL.B ₁₅	(+)
SOL.A ₁₆	(-)
SOL.B ₁₆	(+)
SOL.A ₁₇	(-)
SOL.B ₁₇	(+)
SOL.A ₁₈	(-)
SOL.B ₁₈	(+)
SOL.A ₁₉	(-)
SOL.B ₁₉	(+)
SOL.A ₂₀	(-)
SOL.B ₂₀	(+)
SOL.A ₂₁	(-)
SOL.B ₂₁	(+)
SOL.A ₂₂	(-)
SOL.B ₂₂	(+)
SOL.A ₂₃	(-)
SOL.B ₂₃	(+)
SOL.A ₂₄	(-)
SOL.B ₂₄	(+)
COM.	(+)
COM.	(-)

<20P>

Terminal no.	Polarity
SOL.A ₁	(-)
SOL.B ₁	(+)
SOL.A ₂	(-)
SOL.B ₂	(+)
SOL.A ₃	(-)
SOL.B ₃	(+)
SOL.A ₄	(-)
SOL.B ₄	(+)
SOL.A ₅	(-)
SOL.B ₅	(+)
SOL.A ₆	(-)
SOL.B ₆	(+)
SOL.A ₇	(-)
SOL.B ₇	(+)
SOL.A ₈	(-)
SOL.B ₈	(+)
SOL.A ₉	(-)
SOL.B ₉	(+)
SOL.A ₁₀	(-)
SOL.B ₁₀	(+)
SOL.A ₁₁	(-)
SOL.B ₁₁	(+)
SOL.A ₁₂	(-)
SOL.B ₁₂	(+)
SOL.A ₁₃	(-)
SOL.B ₁₃	(+)
SOL.A ₁₄	(-)
SOL.B ₁₄	(+)
SOL.A ₁₅	(-)
SOL.B ₁₅	(+)
SOL.A ₁₆	(-)
SOL.B ₁₆	(+)
SOL.A ₁₇	(-)
SOL.B ₁₇	(+)
SOL.A ₁₈	(-)
SOL.B ₁₈	(+)
COM.	(+)
COM.	(-)

Positive Negative (Note)
COM COM

Note) Mounting valve has no polarity. It can also be used as a negative common.

Cable Assembly

AXT100-FC²⁰₂₆¹₃

(Type 26P flat ribbon cable connector assemblies can be ordered with manifolds. Refer to "How to Order Manifold.")

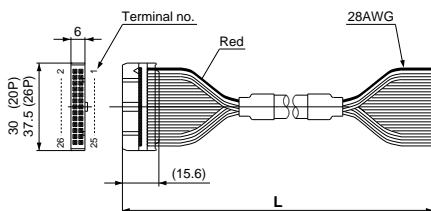

Flat Ribbon Cable Connector Assembly (Option)

Cable length (L)	Assembly part no.	
	26P	20P
1.5 m	AXT100-FC26-1	AXT100-FC20-1
3 m	AXT100-FC26-2	AXT100-FC20-2
5 m	AXT100-FC26-3	AXT100-FC20-3

- * For other commercial connectors, use a 20- or 26-pin type with strain relief conforming to MIL-C-83503.
- * Cannot be used for movable wiring.

Example of connector manufacturers

- HIROSE ELECTRIC CO., LTD.
- 3M Japan Limited
- Fujitsu Limited
- Japan Aviation Electronics Industry, Limited
- J.S.T. Mfg. Co., Ltd.
- Oki Electric Cable Co., Ltd.

Special Wiring Specifications (Option) [-K]

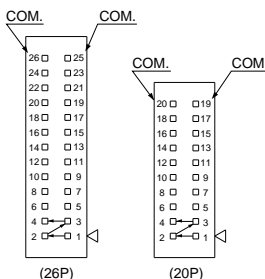

Mixed single and double wiring are available as an option. The maximum number of manifold stations is determined by the number of solenoids. Count one point for a single solenoid type and two points for a double solenoid type. The total number of solenoids (points) must not exceed 24 for 26P, 18 for 20P.

- How to Order valve**
Indicate an option symbol, -K, for the manifold part number and be sure to specify the mounting position and number of stations of the single and double wiring on the manifold specification sheet.
- Wiring specifications**
Connector terminal numbers are connected from solenoid station 1 on the A side in the order indicated by the arrows without skipping any terminal numbers.



How to Order Manifold

10-SS0751-08 C4 C8 PD1 -

Clean series

Stations

Symbol	Stations
01	1 station
:	:
24	24 stations

Note) The maximum number of stations will be different depending on the wiring specifications.

Cylinder port size

Symbol	Port size	
C2	With ø2 One-touch fitting	Metric
C3	With ø3.2 One-touch fitting	
C4	With ø4 One-touch fitting	
N1	With ø1/8" One-touch fitting	Inch
N3	With ø5/32" One-touch fitting	

P, R port size

Symbol	Port size	
Nil	With ø8 One-touch fitting ^{Note)}	Metric
C6	With ø6 One-touch fitting	
C8	With ø8 One-touch fitting	
N7	With ø1/4" One-touch fitting	Inch
N9	With ø5/16" One-touch fitting	

Note) The P, R port size is ø5/16" when the cylinder ports are inch sizes.

Option

Symbol	Specifications
Nil	None
D	With DIN rail (Rail length: Standard)
D0	Without DIN rail (With bracket)
D□ ^{Note 2)}	With DIN rail Designated length (□: Station)
K ^{Note 3)}	Special wiring specifications (Except double wiring)
R ^{Note 4)}	External pilot

- Note 1) When two or more options are specified, indicate them alphabetically. Example) -DKR
- Note 2) The available number of stations is larger than the number of manifold stations.
- Note 3) Indicate the wiring specifications for mixed single and double wirings.
- Note 4) For details, refer to page 441.
- * For manifold optional parts, refer to pages 440 to 441.
- * For manifold exploded view, refer to page 443.

Kit type/Cable length

Kit type	Symbol	Specifications	Standard station	Max. number of stations for special wiring specifications	Max. number of solenoids
P kit	PD0	Flat ribbon cable (26P), without cable	1 to 12 stations	24 stations	24
	PD1	Flat ribbon cable (26P), with 1.5 m cable			
	PD2	Flat ribbon cable (26P), with 3.0 m cable			
	PD3	Flat ribbon cable (26P), with 5.0 m cable			
	PDC	Flat ribbon cable (20P), without cable	1 to 9 stations	18 stations	18

Note) The maximum number of stations is determined by the total number of solenoids. For mixed single and double wirings, enter "K" to the order code options.

Actuation type	Single	Double, Dual 3-port
Number of solenoids	1	2

How to Order Valve

10-S07 1 1 - 5

Clean series

Actuation type

Symbol	Specifications
1	2-position single
2	2-position double
A	4-position dual 3-port (N.C. + N.C.) [Exhaust center]
B	4-position dual 3-port (N.O. + N.O.) [Pressure center]
C	4-position dual 3-port (N.C. + N.O.)

Note) For symbol, refer to page 423.

Voltage

Symbol	Specifications
5	24 VDC
6	12 VDC

Function

Symbol	Specifications
Nil	Standard
R	External pilot ^{Note)}

Note) Not compatible with dual 3-port valves. The 3(R) port is released to the atmosphere. (Pressurization and vacuum are not allowed.)

Base mounted plug-in

How to Order Manifold Assembly

Specify the part numbers for valves and options together beneath the manifold base part number.

<Example>

Flat ribbon cable kit

- 10-SS0751-08C4C8PD1...1 set - Manifold base part no.
- * 10-S0711-5 2 sets - Valve part no. (Stations 1 to 3)
- * 10-S0721-5 4 sets - Valve part no. (Stations 4 to 5)
- * 10-S07A1-5 1 set - Valve part no. (Stations 6 to 7)
- * SS0700-10A-3 1 set - Blanking plate part no. (Station 8)

Prefix the asterisk to the part no. of the solenoid valve, etc. Write sequentially from the 1st station on the D side. When part no. written collectively are complicated, specify on the manifold specification sheet.

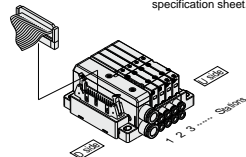

Directional Control Valves

Air Cylinders

Rotary Actuators

Air Grippers

Air Preparation Equipment

Modular F. R.

Pressure Control Equipment

Fittings & Tubing

Flow Control Equipment

Pressure Switches/Pressure Sensors

P

Series 10-S0700 kit (Flat Ribbon Cable)

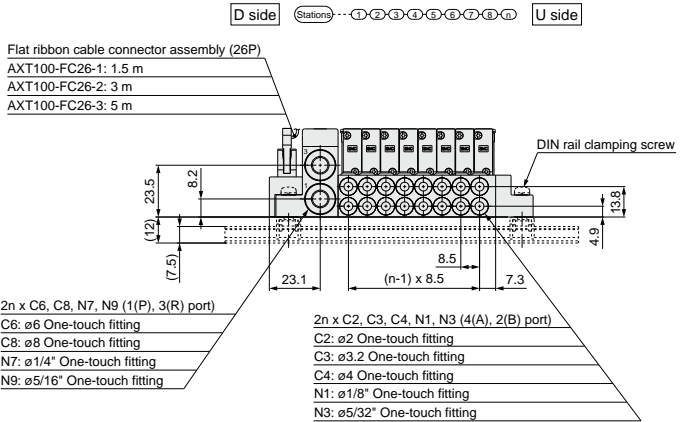
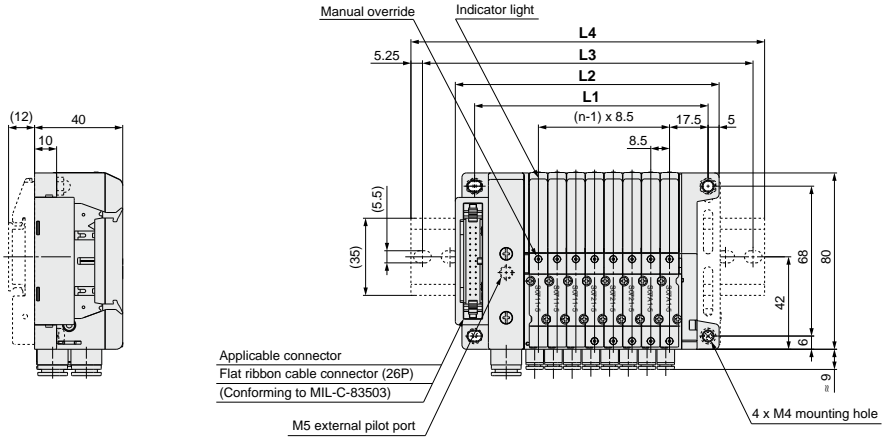

Dimensions

Formula L1 = 8.5n + 38, L2 = 8.5n + 51.7

n: Station (Maximum 24 stations)

L	n	2	3	4	5	6	7	8	9	10	11	12	13	14	15	16	17	18	19	20	21	22	23	24
L1	55	63.5	72	80.5	89	97.5	106	114.5	123	131.5	140	148.5	157	165.5	174	182.5	191	199.5	208	216.5	225	233.5	242	
L2	68.7	77.2	85.7	94.2	102.7	111.2	119.7	128.2	136.7	145.2	153.7	162.2	170.7	179.2	187.7	196.2	204.7	213.2	221.7	230.2	238.7	247.2	255.7	
L3	100	100	112.5	125	137.5	150	150	162.5	175	175	187.5	200	200	212.5	225	225	237.5	250	250	262.5	275	275	287.5	
L4	110.5	110.5	123	135.5	148	148	160.5	160.5	173	185.5	185.5	198	210.5	210.5	223	235.5	235.5	248	260.5	260.5	273	285.5	285.5	

Slim Compact Plug-in Manifold Bar Base

PC Wiring System Compatible Flat Ribbon Cable

J kit

Slim Compact
Plug-in Manifold
Bar Base



MIL Standard

■ 20 pins

PC wiring system
compatible



▶ Page 437

Directional
Control Valves

Air Cylinders

Rotary Actuators

Air Grippers

Air Preparation
Equipment

Modular F. R.

Pressure Control
Equipment

Fittings & Tubing

Flow Control
Equipment

Pressure Switches/
Pressure Sensors

J

Series 10-S0700 Slim Compact Plug-in Manifold Bar Base kit (PC Wiring System Compatible Flat Ribbon Cable)

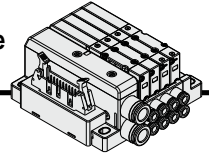

- Compatible with PC wiring system.
- Using connector for flat ribbon cable (20P) conforming to MIL standard permits the use of commercial connectors and gives a wide interchangeability.
- Top or side receptacle position can be selected in accordance with the available mounting space.

Electrical Wiring Specifications

Double wiring (connected to SOL.A and SOL.B) is adopted for the internal wiring of each station, regardless of valve and option types. Mixed single and double wiring is available as an option. For details, refer to "Special Wiring Specifications" (Option) below.

Flat ribbon cable connector

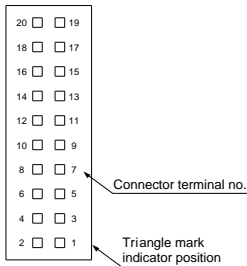

Special Wiring Specifications (Option) [-K]

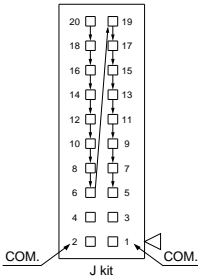

J kit
Flat ribbon cable connector (20P)
PC wiring system compatible

Mixed single and double wiring are available as an option. The maximum number of manifold stations is determined by the number of solenoids. Count one point for a single solenoid type and two points for a double solenoid type. The total number of solenoids (points) must not exceed 16.

1. How to Order valve

Indicate an option symbol, -K, for the manifold part number and be sure to specify the mounting position and number of stations of the single and double wiring on the manifold specification sheet.

2. Wiring specifications

Connector terminal numbers are connected from solenoid station 1 on the A side in the order indicated by the arrows without skipping any terminal numbers.

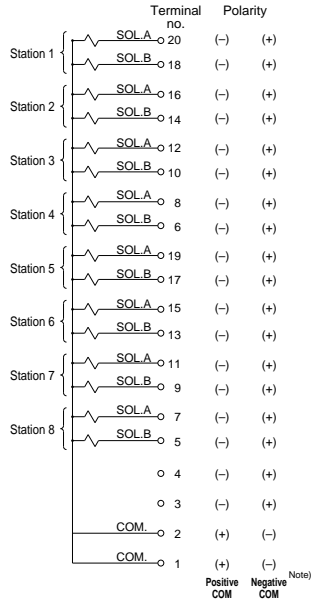

Note) Mounting valve has no polarity. It can also be used as a negative common.

For details about the PC wiring system, refer to the catalog CAT.ES02-20 separately.



How to Order Manifold

10-SS0751-08 C4 C8 JD0 -

Clean series

Symbol	Stations
01	1 station
⋮	⋮
16	16 stations

Note) The maximum number of stations will be different depending on the wiring specifications.

Cylinder port size

Symbol	Port size	
	Port size	
C2	With ø2 One-touch fitting	Metric
C3	With ø3.2 One-touch fitting	
C4	With ø4 One-touch fitting	
N1	With ø1/8" One-touch fitting	Inch
N3	With ø5/32" One-touch fitting	

P, R port size

Symbol	Port size
Nil	With ø8 One-touch fitting ^{Note)}
C6	With ø6 One-touch fitting
C8	With ø8 One-touch fitting
N7	With ø1/4" One-touch fitting
N9	With ø5/16" One-touch fitting

Note) The P, R port size is ø5/16" when the cylinder ports are inch sizes.

Option

Symbol	Specifications
Nil	None
D	With DIN rail (Rail length: Standard)
D0	Without DIN rail (With bracket)
D□ ^{Note 2)}	With DIN rail Designated length (□: Station)
K ^{Note 3)}	Special wiring specifications (Except double wiring)
R ^{Note 4)}	External pilot

- Note 1) When two or more options are specified, indicate them alphabetically. Example) -DKR
- Note 2) The available number of stations is larger than the number of manifold stations.
- Note 3) Indicate the wiring specifications for mixed single and double wirings.
- Note 4) For details, refer to page 441.
- * For manifold optional parts, refer to pages 440 to 441.
- * For manifold exploded view, refer to page 443.

Kit type

Kit type	Symbol	Specifications	Standard station	Max. number of stations for special wiring specifications	Max. number of solenoids
J kit	JD0	Flat ribbon cable (20P) PC wiring system compatible ^{Note 1)}	1 to 8 stations	16 stations	16

- Note 1) For 20P type cable assembly of J kit, order it separately.
- Note 2) The maximum number of stations is determined by the total number of solenoids.
- For mixed single and double wirings, enter "-K" to the order code options.

Actuation type	Single	Double, Dual 3-port
Number of solenoids	1	2

How to Order Valve

10-S07 1 1 - 5

Clean series

Actuation type

Symbol	Specifications
1	2-position single
2	2-position double
A	4-position dual 3-port (N.C. + N.C.) [Exhaust center]
B	4-position dual 3-port (N.O. + N.O.) [Pressure center]
C	4-position dual 3-port (N.C. + N.O.)

Note) For symbol, refer to page 423.

Voltage

Symbol	Specifications
5	24 VDC
6	12 VDC

Function

Symbol	Specifications
Nil	Standard
R	External pilot ^{Note)}

Note) Not compatible with dual 3-port valves. The 3(R) port is released to the atmosphere. (Pressurization and vacuum are not allowed.)

Base mounted plug-in

How to Order Manifold Assembly

Specify the part numbers for valves and options together beneath the manifold base part number.

<Example>

- Flat ribbon cable kit
- 10-SS0751-08C4C8JD0... 1 set - Manifold base part no.
- = 10-S0711-5 3 sets - Valve part no. (Stations 1 to 3)
- = 10-S0721-5 2 sets - Valve part no. (Stations 4 to 5)
- = 10-S07A1-5 2 sets - Valve part no. (Stations 6 to 7)
- = SS0700-10A-3 1 set - Blanking plate part no. (Station 8)

Write sequentially from the 1st station on the D side. When part no. written collectively are complicated, specify on the manifold specification sheet.

Prefix the asterisk to the part no. of the solenoid valve, etc.

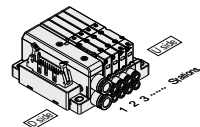

Directional Control Valves

Air Cylinders

Rotary Actuators

Air Grippers

Air Preparation Equipment

Modular F. R.

Pressure Control Equipment

Fittings & Tubing

Flow Control Equipment

Pressure Switches/ Pressure Sensors



Series 10-S0700 kit (PC Wiring System Compatible Flat Ribbon Cable)

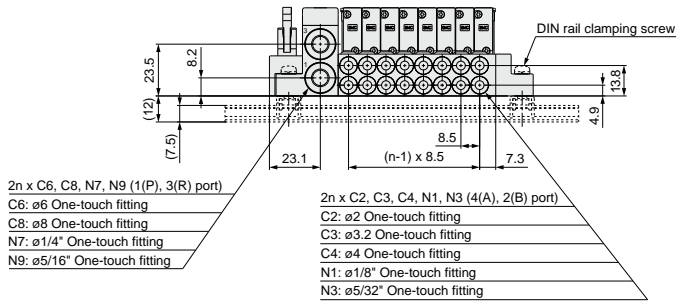
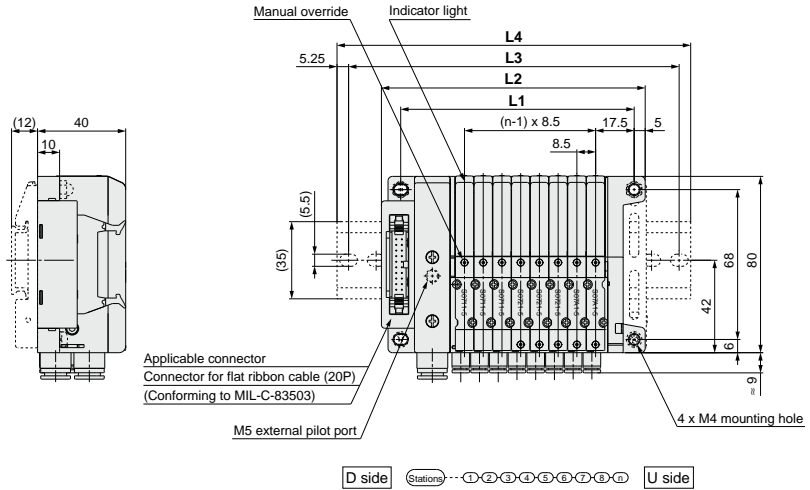

Dimensions

Formula L1 = 8.5n + 38, L2 = 8.5n + 51.7 n: Station (Maximum 16 stations)

L \ n	2	3	4	5	6	7	8	9	10	11	12	13	14	15	16
L1	55	63.5	72	80.5	89	97.5	106	114.5	123	131.5	140	148.5	157	165.5	174
L2	68.7	77.2	85.7	94.2	102.7	111.2	119.7	128.2	136.7	145.2	153.7	162.2	170.7	179.2	187.7
L3	100	100	112.5	125	137.5	150	150	162.5	175	175	187.5	200	200	212.5	212.5
L4	110.5	110.5	123	135.5	148	148	160.5	160.5	173	185.5	185.5	198	210.5	210.5	223

Series 10-S0700 Slim Compact Plug-in Manifold Bar Base

Manifold Optional Parts

Blanking plate assembly

SS0700-10A-3

It is used by attaching on the manifold block for being prepared for removing a valve for maintenance reasons or planning to mount a spare valve, etc.

Weight: 8 g

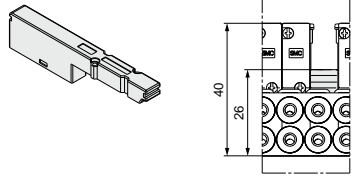

Individual SUP spacer

SS0700-P-3-C

Mounted on the manifold block to make an independent supply port when each solenoid valve uses different operating pressure.

Weight: 15 g

Port size

Symbol	Applicable tubing
C2	Applicable tubing ø2
C3	Applicable tubing ø3
C4	Applicable tubing ø4
N1	Applicable tubing ø1/8"
N3	Applicable tubing ø5/32"

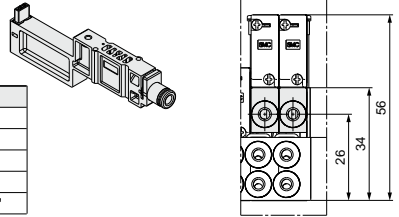

Individual EXH spacer

SS0700-R-3-C

Mounted on the manifold block to make an independent exhaust port when the exhaust from one valve affects valves on other stations in the air circuit.

Weight: 15 g

Port size

Symbol	Applicable tubing
C2	Applicable tubing ø2
C3	Applicable tubing ø3
C4	Applicable tubing ø4
N1	Applicable tubing ø1/8"
N3	Applicable tubing ø5/32"

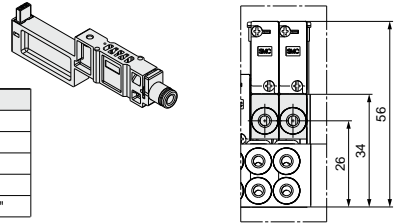

Blanking plate with output

SS0700-1C3-

Lead wire length (mm)

Nii	600
10	1000
15	1500
20	2000
25	2500
30	3000

Blanking plate with a connector for individually outputting electricity to drive a single valve or equipment that are not on the manifold base.

Note 1) Electric current should be 0.5 A or less. (Including the mounted valves)
When the current is output from two positions at the same time, the current should be 0.25 A or less.

Note 2) Please consult with SMC for the max. allowable current for serial transmission kit.

Weight: 23 g



Blanking plate with output

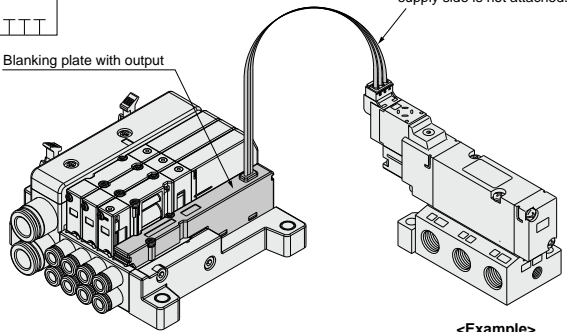

<Example>

Directional Control Valves

Air Cylinders

Rotary Actuators

Air Grippers

Air Preparation Equipment

Modular F. R.

Pressure Control Equipment

Fittings & Tubing

Flow Control Equipment

Pressure Switches/ Pressure Sensors

Series 10-S0700 Slim Compact Plug-in Manifold Bar Base

Manifold Optional Parts

External pilot [-R]

This can be used when the air pressure is 0.1 to 0.2 MPa lower than the minimum operating pressure of the solenoid valves or used for vacuum specifications.

Add R to the part numbers of manifolds and valves to indicate the external pilot specifications.

An M5 port will be installed on the top side of the manifold's SUP/EXH block.

● How to Order Valve (Example)

10-S0710 R -5

↓ External pilot

● How to Order Manifold (Example)

* Indicate R for an option.

10-SS0750-08C4FD1-R

↓ External pilot

External pilot port
(M5 x 0.8)

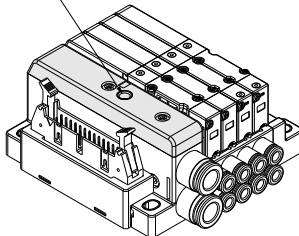

- Note 1) Not compatible with dual 3-port valves.
- Note 2) When the internal pilot type of valves are mixed up on the manifold, order the manifold suitable for the specifications of the external pilot valve.
- Note 3) Since the pilot EXH of valves with the external pilot specification also has a common exhaust specification, the 3(R) port should be released to the atmosphere.

DIN rail mounting bracket

SS0700-57A-3

It is used for mounting a manifold on a DIN rail. The DIN rail mounting bracket is fixed to the manifold end plate. (The specification is the same as that for the option "-D".)

1 set of DIN rail mounting bracket is included for 1 manifold (2 or 3 DIN rail mounting brackets (S, T kit)).

* When ordering this option incorporated with a manifold, suffix "-D" to the end of the manifold part number.

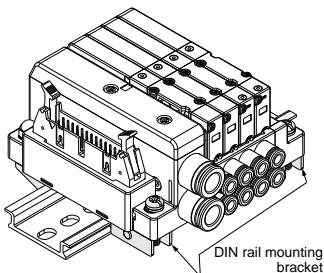

Series 10-S0700 Slim Compact Plug-in Manifold Bar Base Construction

Single: 10-S0711

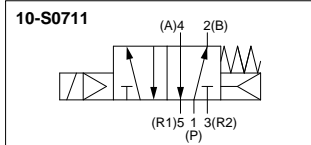
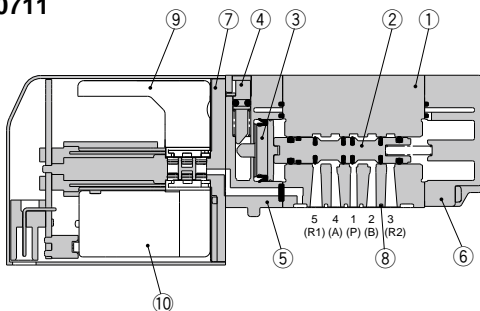

Double: 10-S0721

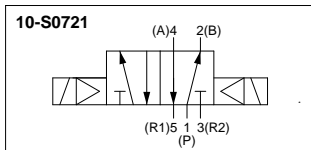
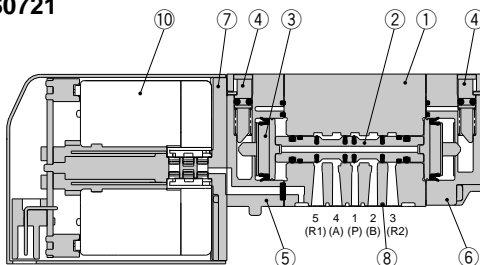

Dual 3-Port: 10-S07B1
A
C

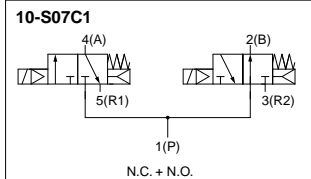
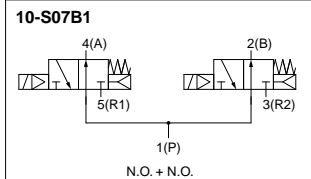
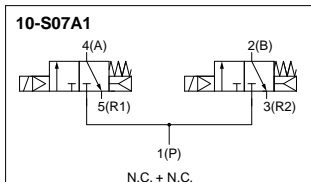
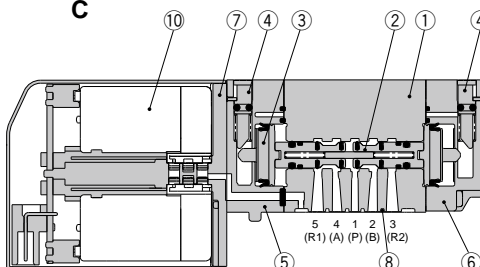

Component Parts

No.	Description	Material
1	Body	Zinc die-casted
2	Spool	Aluminum
3	Piston	Resin
4	Manual override	Resin
5	Adapter plate	Resin
6	End plate	Resin
7	Pilot spacer	Resin
8	Interface gasket	HNBR
9	Plate	Resin
10	Pilot valve assembly <small>(Note)</small>	—

Note) Please consult with SMC for pilot valve replacement.

Directional Control Valves

Air Cylinders

Rotary Actuators

Air Grippers

Air Preparation Equipment

Modular F. R.

Pressure Control Equipment

Fittings & Tubing

Flow Control Equipment

Pressure Switches/ Pressure Sensors

Series 10-S0700 Slim Compact Plug-in Manifold Bar Base Manifold Exploded View

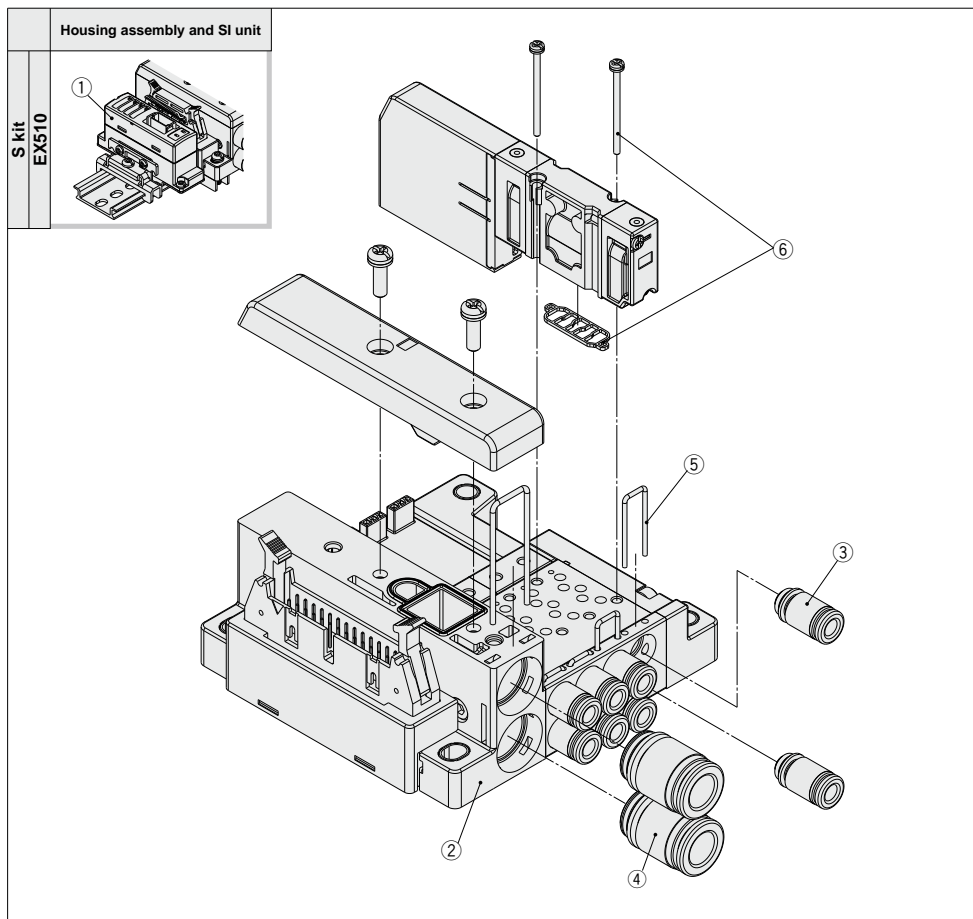

* It is not possible to increase or decrease the number of stations or change the wiring kit on the slim compact plug-in manifold bar base.
To change them, please change the entire base unit.

Manifold Assembly Part No.

No.	Description	Part no.	Note
①	SI unit	EX510-S002A	NPN (Positive common)
		EX510-S102A	PNP (Negative common)
②	Base unit	SS0751-□□□□	Refer to How to Order for each kit.

③ Fitting assembly part number for cylinder port**VVQ0000-50A-□**↓ **Port size**

Symbol	Applicable tubing
C2	Applicable tubing ø2
C3	Applicable tubing ø3
C4	Applicable tubing ø4
N1	Applicable tubing ø1/8"
N3	Applicable tubing ø5/32"

Note 1) Purchase orders are available in units of 10 pieces.

Note 2) For One-touch fittings replacement, refer to the Specific Product Precautions 2.

④ Fitting assembly part number for P, R port**VVQ1000-51A-□**↓ **Port size**

Symbol	Applicable tubing
C6	Applicable tubing ø6
C8	Applicable tubing ø8
N7	Applicable tubing ø1/4"
N9	Applicable tubing ø5/16"

Note 1) Purchase orders are available in units of 10 pieces.

Note 2) For One-touch fittings replacement, refer to the Specific Product Precautions 2.

No.	Description	Part no.
⑤	Clip	SS0700-80A-5

Note) 1 set includes 10 pieces.

No.	Description	Part no.
⑥	Gasket, Screw	SS0700-GS-3

Note) Above part number consists of 10 units. Each unit has one gasket and two screws.

Directional Control Valves

Air Cylinders

Rotary Actuators

Air Grippers

Air Preparation Equipment

Modular F. R.

Pressure Control Equipment

Fittings & Tubing

Flow Control Equipment

Pressure Switches/ Pressure Sensors

Plug-in Manifold Stacking Base

Serial Transmission

S kit

Plug-in Manifold
Stacking Base



Gateway-type
Serial Transmission System

EX500

Page 447



Integrated-type (For I/O)
Serial Transmission System

EX250

Page 449



Integrated-type (For I/O)
Serial Transmission System (Fieldbus System)

EX600

Page 451



Directional
Control Valves

Air Cylinders

Rotary Actuators

Air Grippers

Air Preparation
Equipment

Modular F. R.

Pressure Control
Equipment

Fittings & Tubing

Flow Control
Equipment

Pressure Switches/
Pressure Sensors



Series 10-S0700 Plug-in Manifold Stacking Base kit (Serial Transmission) EX500 Gateway-type Serial Transmission System

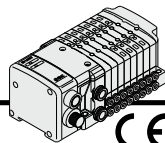

How to Order Manifold

10-SS0750-08 C4 C8 SDA2 - B

① Stations

Symbol	Stations
01	1 station
:	:
16 (Note)	16 stations

Note) The maximum number of stations will be different depending on the wiring specifications.

② Cylinder port size

Symbol	Port size	
C2	With ø2 One-touch fitting	Metric
C3	With ø3.2 One-touch fitting	
C4	With ø4 One-touch fitting	
CM	Mixed sizes and with port plug (Note)	Inch
N1	With ø1/8" One-touch fitting	
N3	With ø5/32" One-touch fitting	
NM	Mixed sizes and with port plug (Note)	

Note) Specify "Mixed sizes and with port plug" on the manifold specification sheet.

③ P, R port size

Symbol	Port size	
Nil	With ø8 One-touch fitting (Note)	Metric
C6	With ø6 One-touch fitting	
C8	With ø8 One-touch fitting	
N7	With ø1/4" One-touch fitting	Inch
N9	With ø5/16" One-touch fitting	

Note) The P, R port size is ø5/16" when the cylinder ports are inch sizes.

④ Kit type

S kit	Gateway-type serial transmission	Symbol	Specifications	Standard station	Max. number of stations for special wiring specifications	Max. number of solenoids
		SD0	Without SI unit			
		SDA2	DeviceNet™, PROFIBUS DP, CC-Link, EtherNet/IP™			

Note 1) The maximum number of stations is determined by the total number of solenoids.

For mixed single and double wirings, enter "K" to the order code options.

Note 2) For SI unit part number, refer to page 444.

Actuation type	Single	Double, Dual 3 port
Number of solenoids	1	2

⑤ SI unit COM.

SI unit COM.	EX500				
	DeviceNet™	PROFIBUS DP	CC-Link	EtherNet/IP™	
Nil +COM.	○	○	○	○	○
N -COM.	○	○	○	○	○

Note) The symbol is nil for no SI unit (SD0).

Refer to the Best Pneumatics No. 1 for details on the EX500 Gateway-type Serial Transmission System.

How to Order Manifold Assembly

Specify the part numbers for valves and options together beneath the manifold base part number.

<Example>

Serial transmission kit

- 10-SS0750-08C4SDA2 -- 1 set -- Manifold base part no.
 * 10-S0710-5 3 sets -- Valve part no. (Stations 1 to 3)
 * 10-S0720-5 2 sets -- Valve part no. (Stations 4 to 5)
 * 10-S07A0-5 2 sets -- Valve part no. (Stations 6 to 7)
 * SS0700-10A-1 1 set -- Blanking plate part no. (Station 8)

Prefix the asterisk to the part no. of the solenoid valve, etc.

Write sequentially from the 1st station on the D side. When part no. written collectively are complicated, specify on the manifold specification sheet.

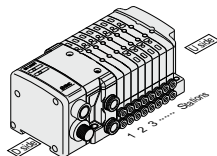

How to Order Valve

10-S07 1 0 - 5

Clean series

Actuation type

Voltage: 24 VDC

Function

Symbol	Specifications
Nil	Standard
R	External pilot (Note)

Note) Not compatible with dual 3-port valves.

The 3(R) port is released to the atmosphere. (Pressurization and vacuum are not allowed.)

Base mounted plug-in

Symbol	Specifications
1	2-position single
2	2-position double
A	4-position dual 3-port (N.C. + N.O.) [Exhaust center]
B	4-position dual 3-port (N.O. + N.O.) [Pressure center]
C	4-position dual 3-port (N.C. + N.O.)

Note) For symbol, refer to page 423.

10-SS0750
S kit (Serial transmission: EX500)

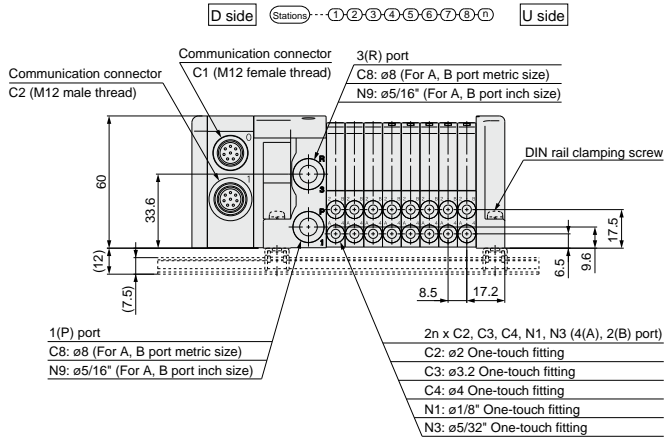
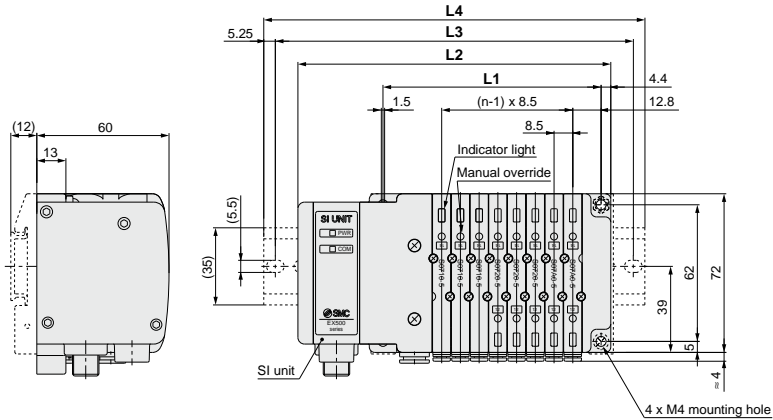

Dimensions

Formula $L1 = 8.5n + 31$, $L2 = 8.5n + 74$ n: Station (Maximum 16 stations)

L \ n	2	3	4	5	6	7	8	9	10	11	12	13	14	15	16
L1	48	56.5	65	73.5	82	90.5	99	107.5	116	124.5	133	141.5	150	158.5	167
L2	91	99.5	108	116.5	125	133.5	142	150.5	159	167.5	176	184.5	193	201.5	210
L3	112.5	125	137.5	137.5	150	162.5	162.5	175	187.5	187.5	200	212.5	212.5	225	237.5
L4	123	135.5	148	148	160.5	173	173	185.5	198	198	210.5	223	223	235.5	248



Series 10-S0700 Plug-in Manifold Stacking Base kit (Serial Transmission)

EX250 Integrated-type (For Input/Output) Serial Transmission System

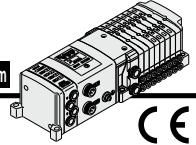

How to Order Manifold

10-SS0750-08 C4 C8 SDQ N - B

Clean series ↓

① Stations

Symbol	Stations
01	1 station
⋮	⋮
24 (Note)	24 stations

Note) The maximum number of stations will be different depending on the wiring specifications.

② Cylinder port size

Symbol	Port size	
C2	With ø2 One-touch fitting	Metric
C3	With ø3.2 One-touch fitting	
C4	With ø4 One-touch fitting	
CM	Mixed sizes and with port plug (Note)	
N1	With ø1/8" One-touch fitting	Inch
N3	With ø5/32" One-touch fitting	
NM	Mixed sizes and with port plug (Note)	

Note) Specify "Mixed sizes and with port plug" on the manifold specification sheet.

③ P, R port size

Symbol	Port size	
Nil	With ø8 One-touch fitting (Note)	Metric
C6	With ø6 One-touch fitting	
C8	With ø8 One-touch fitting	Inch
N7	With ø1/4" One-touch fitting	
N9	With ø5/16" One-touch fitting	

Note) The P, R port size is ø5/16" when the cylinder ports are inch sizes.

④ Kit type

Kit type	Note 2) Symbol	Specifications	Standard station	Max. number of stations for special wiring specifications	Max. number of solenoids			
S kit	SD0	Without SI unit	1 to 12 stations	24 stations	24			
	SDQ	DeviceNet™						
	SDN	PROFIBUS DP						
	SDV	CC-Link						
	SDY	CANopen						
	SDZEN	EtherNet/IP™						
	SDTA	AS-Interface 31 slave, 8 in/8 out, 2 isolated common type				1 to 4 stations	8 stations	8
	SDTB	AS-Interface 31 slave, 4 in/4 out, 2 isolated common type				1 to 2 stations	4 stations	4
	SDTC	AS-Interface 31 slave, 8 in/8 out, 1 common type				1 to 4 stations	8 stations	8
	SDTD	AS-Interface 31 slave, 4 in/4 out, 1 common type				1 to 2 stations	4 stations	4

Note 1) The maximum number of stations is determined by the total number of solenoids.

For mixed single and double wirings, enter "K" to the order code options.

Note 2) For SI unit part number, refer to page 444.

Actuation type	Single	Double, Dual 3-port
Number of solenoids	1	2

How to Order Valve

10-S07 1 0 - 5

Clean series ↓

Actuation type ↓

Symbol	Specifications
1	2-position single
2	2-position double
A	4-position dual 3-port (N.C. + N.C.) [Exhaust center]
B	4-position dual 3-port (N.O. + N.O.) [Pressure center]
C	4-position dual 3-port (N.C. + N.O.)

Note) For symbol, refer to page 423.

Function ↓

Symbol	Specifications
Nil	Standard
R	External pilot (Note)

Note) Not compatible with dual 3-port valves.

The 3(R) port is released to the atmosphere. (Pressurization and vacuum are not allowed.)

Base mounted plug-in



⑤ SI unit COM.

SI unit COM.	DeviceNet™	PROFIBUS DP	EX250			
			CC-Link	AS-Interface	CANopen	EtherNet/IP™
Nil	+COM.	—	—	○	—	—
N	-COM.	—	○	—	○	○

Note) The symbol is nil for no SI unit (SD0).

⑥ Input block (for I/O unit only)

Symbol	Specifications
Nil	SI unit/Input block: None (SD0)
0	Input block: None
1	Input block: 1 pc.
⋮	⋮
8	Input block: 8 pcs.

Note) The symbol is nil for no SI unit (SD0).

⑦ Input block type (for I/O unit only)

Symbol	Specifications
Nil	Input block: None
1	M12 2 inputs
2	M12 4 inputs
3	M8 4 inputs (3 pins)

Note) The symbol is nil for no SI unit (SD0).

⑧ Input block COM. (for I/O unit only)

Symbol	Specifications
Nil	PNP sensor input (+COM.) or without input block
N	NPN sensor input (-COM.)

Note) The symbol is nil for no SI unit (SD0).

⑨ Option

Symbol	Specifications
Nil	None
B (Note 2)	With back pressure check valve (All stations)
D	With DIN rail (Rail length: Standard)
D0	Without DIN rail (With bracket)
D□ (Note 3)	With DIN rail Designated length (□: Station)
K (Note 4)	Special wiring specifications (Except double wiring)
N	With name plate
R (Note 5)	External pilot

Note 1) When two or more options are specified, indicate them alphabetically. Example) -BKN

Note 2) When installing a back pressure check valve on the required station, enter the part number and specify the station position on the manifold specification sheet.

Note 3) The available number of stations is larger than the number of manifold stations.

Note 4) Indicate the wiring specifications for mixed single and double wirings.

Note 5) For details, refer to page 481.

* For manifold optional parts, refer to pages 481 to 484.

* For manifold exploded view, refer to page 487.

Refer to the **WEB catalog** for details on the EX250 Integrated-type (For Input/Output) Serial Transmission System.

How to Order Manifold Assembly

Specify the part numbers for valves and options together beneath the manifold base part number.

<Example>

Serial transmission kit

10-SS0750-08C(SDQ)N13N ... 1 set - Manifold base part no.
 * 10-S0710-5 3 sets - Valve part no. (Stations 1 to 3)
 * 10-S0720-5 2 sets - Valve part no. (Stations 4 to 5)
 * 10-S07A0-5 2 sets - Valve part no. (Stations 6 to 7)
 * SS0700-10A-1 1 set - Blanking plate part no. (Station 8)

Prefix the asterisk to the part no. of the solenoid valve, etc.
 Write sequentially from the 1st station on the D side. When part no. written collectively are complicated, specify on the manifold specification sheet.

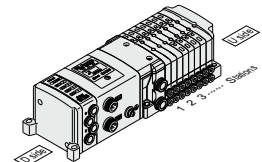

10-SS0750
S kit (Serial transmission: EX250)

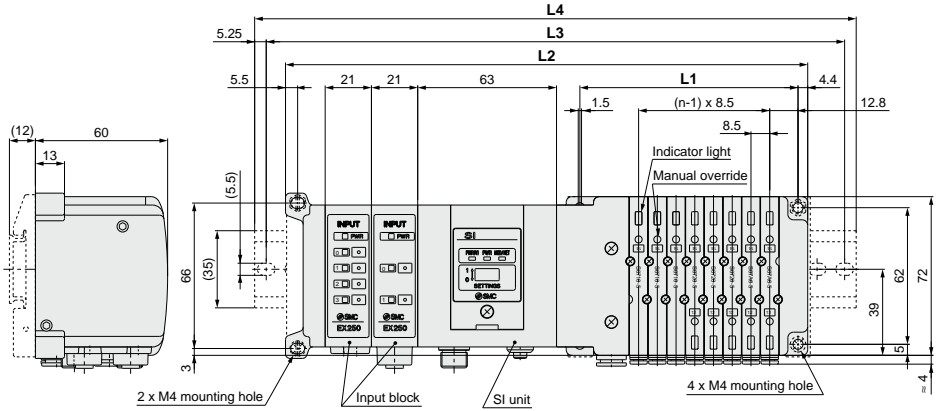

D side Stations ① ② ③ ④ ⑤ ⑥ ⑦ ⑧ ⑨ U side

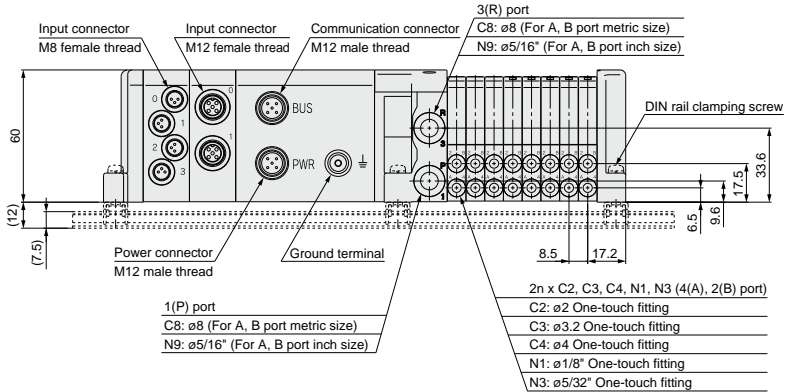

Dimensions

Formula L1 = 8.5n + 31, L2 = 8.5n + 169 (For 2 input blocks, 21 mm is added per 1 pc.) n: Station (Maximum 24 stations)

L \ n	2	3	4	5	6	7	8	9	10	11	12	13	14	15	16
L1	48	56.5	65	73.5	82	90.5	99	107.5	116	124.5	133	141.5	150	158.5	167
L2	186	194.5	203	211.5	220	228.5	237	245.5	254	262.5	271	279.5	288	296.5	305
L3	212.5	225	225	237.5	250	250	262.5	275	275	287.5	300	300	312.5	325	325
L4	223	235.5	235.5	248	260.5	260.5	273	285.5	285.5	298	310.5	310.5	323	335.5	335.5

L \ n	17	18	19	20	21	22	23	24
L1	175.5	184	192.5	201	209.5	218	226.5	235
L2	313.5	322	330.5	339	347.5	356	364.5	373
L3	337.5	350	350	362.5	375	387.5	387.5	400
L4	348	360.5	360.5	373	385.5	398	398	410.5

Directional Control Valves
 Air Cylinders
 Rotary Actuators
 Air Grippers
 Air Preparation Equipment
 Modular F. R.
 Pressure Control Equipment
 Fittings & Tubing
 Flow Control Equipment
 Pressure Switches/ Pressure Sensors

S

Series 10-S0700 Plug-in Manifold Stacking Base kit (Serial Transmission) EX600 Integrated-type (For Input/Output) Serial Transmission System (Fieldbus System)

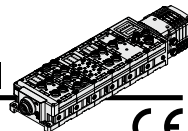

How to Order Manifold

10-SS0750-08 C4 SD6Q 2 N 1 - B

Clean series

Symbol	Stations
01	1 station
⋮	⋮
24 ^{Note)}	24 stations

Note) Max. number of stations depends on the wiring specifications.

Cylinder port size

Symbol	Port size	
C2	With ø2 One-touch fitting	Metric
C3	With ø3.2 One-touch fitting	
C4	With ø4 One-touch fitting	
CM	Mixed sizes and with port plug ^{Note)}	
N1	With ø1/8" One-touch fitting	Inch
N3	With ø5/32" One-touch fitting ^{Note)}	
NM	Mixed sizes and with port plug ^{Note)}	

Note) Indicate the sizes on the manifold specification sheet for CM and NM.

Kit type

Kit type	Symbol	Specifications	Standard station	Max. number of stations for special wiring specifications	Max. number of solenoids
S kit	SD60	Without SI unit	1 to 12 stations	24 stations	24
	SD6Q	DeviceNet™			
	SD6N	PROFIBUS DP			
	SD6V	CC-Link			

Note) Max. station number depends on the number of solenoid valve.

Add the option symbol "-K" when the combination of single wiring and double wiring is specified.

- When "Without SI unit" is specified, valve plate to connect the manifold and SI unit is not mounted. Refer to page 512 for mounting method.
- I/O unit cannot be chosen without SI unit.

Actuation type	Single	Double, Dual 3-port
Number of solenoid valves	1	2

End plate type

Symbol	Specifications
Nil	No end plate
2	Power supply with M12 connector (Max. supplied current 2 A)
3	Power supply with 7/8 inch connector (Max. supplied current 8 A)

Note) The symbol is nil for no SI unit.

Option

Symbol	Specifications
Nil	None
B ^{Note 2)}	With back pressure check valve (All sta.)
D	With DIN rail (Rail length: Standard)
D0	With DIN rail bracket (Without rail)
D□ ^{Note 3)}	With DIN rail length specified (□: Sta.)
K ^{Note 4)}	Special wiring specifications (Except double wiring)
N	With name plate
R	External pilot

Note 1) When two or more symbols are specified, indicate them alphabetically. Example) -BKN

Note 2) When back pressure check valve is used only for specified station, specify back pressure check valve part number, and specify station number to which the valve is mounted on the manifold specification sheet.

Note 3) Specified station number shall be longer than manifold station number.

Note 4) When single wiring and double wiring are mixed, specify wiring type of each station on the manifold specification sheet.

Note 5) When "Without SI unit (SD60)" is specified, "With DIN rail (D)" cannot be selected.

I/O unit station number

Symbol	Specifications
Nil	None
1	1 station
⋮	⋮
9	9 stations

Note 1) The symbol is nil for no SI unit.

Note 2) SI unit is not included in I/O unit station number.

Note 3) When I/O unit is selected, it is shipped separately, and assembled by customer. Refer to the attached operation manual for mounting method.

SI unit COM.

Symbol	Specifications
Nil	+COM.
N	-COM.

Note) The symbol is nil for no SI unit.

Refer to the Fieldbus System (For Input/Output) catalog CAT.E02-24 for details on the EX600 Integrated-type (For I/O) Serial Transmission System.

How to Order Manifold Assembly (Example)

Example

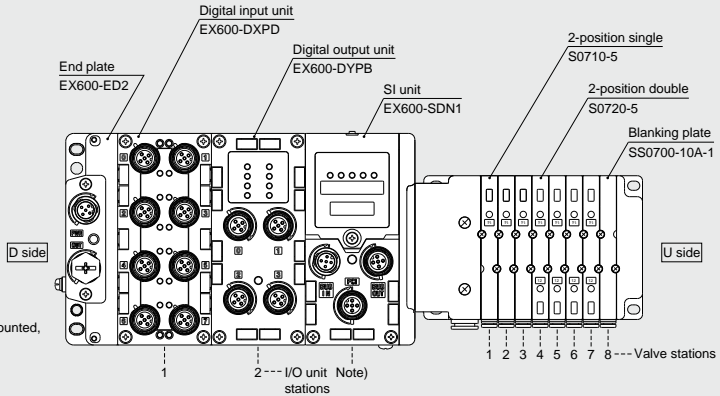

For the I/O unit part number mounted, refer to CAT.E02-24 catalog.

- Digital input unit
- Digital output unit
- Analog input unit

Serial transmission kit

Part Number	Quantity	Description
10-SS0750-08C4SD6Q2N2	1 set	Manifold base part number
* 10-S0710-5	3 sets	Valve part number (Stations 1 to 3)
* 10-S0720-5	4 sets	Valve part number (Stations 4 to 7)
* SS0700-10A-1	1 set	Blanking plate number (Station 8)
* EX600-DXPD	1 set	I/O unit part number (Station 1)
* EX600-DYPB	1 set	I/O unit part number (Station 2)

The asterisk denotes the symbol for assembly. Prefix it to the part no. of the solenoid valve, etc.

Enter in order starting from the first station on the D side. If arrangement becomes complicated, specify on the manifold specification sheet.

Enter in order starting from the first station on the D side.

Note) Do not enter the SI unit part number and the end plate part number together.

How to Order Valve

10-S0710-5

Clean series

Actuation type

Coil voltage

5 24 VDC

Function

Symbol	Specifications
NII	Standard
R	External pilot ^{Note)}

Note) Not compatible with dual 3-port valves. The 3(R) port is released to the atmosphere. (Pressurization and vacuum are not allowed.)

Base mounted plug-in

1	2-position single	A	4-position dual 3-port valve (N.C. + N.C.) [Exhaust center]
	2-position double	B	4-position dual 3-port valve (N.O. + N.O.) [Pressure center]
2	2-position single	C	4-position dual 3-port valve (N.C. + N.O.)
	2-position double		



Series 10-S0700 Plug-in Manifold Stacking Base

kit (Serial Transmission) EX600 Integrated-type (For Input/Output) Serial Transmission System (Fieldbus System)

Power Supply with M12 Connector

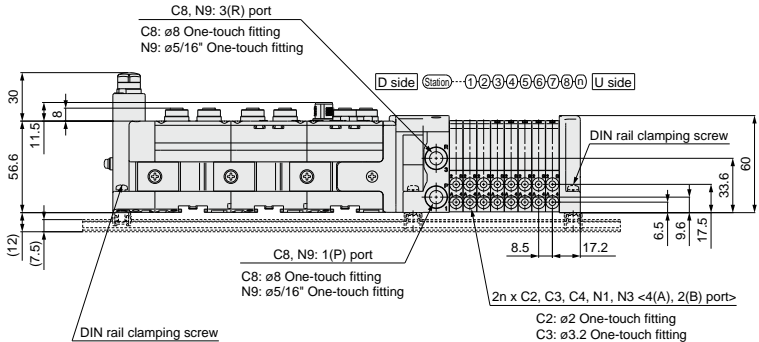
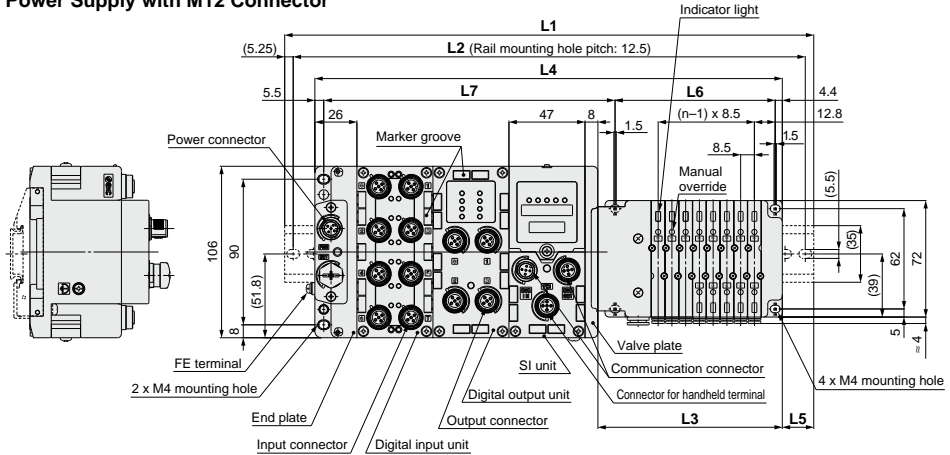

$L2 = L1 - 10.5$
 $L3 = 8.5 \times n1 + 46$
 $L4 = L3 + 81 + 47 \times n2$
 $L5 = (L1 - L4) / 2$
 $L6 = 8.5 \times n1 + 31$
 $L7 = 47 \times n2 + 86.1$

- C2: ø2 One-touch fitting
- C3: ø3.2 One-touch fitting
- C4: ø4 One-touch fitting
- N1: ø1/8" One-touch fitting
- N3: ø5/32" One-touch fitting

L1: DIN Rail Overall Length

I/O unit stations (n2)	Valve stations (n1)																							
	1	2	3	4	5	6	7	8	9	10	11	12	13	14	15	16	17	18	19	20	21	22	23	24
0	173	185.5	185.5	198	210.5	210.5	223	235.5	235.5	248	260.5	260.5	273	285.5	285.5	298	310.5	310.5	323	335.5	335.5	348	360.5	373
1	223	223	235.5	248	248	260.5	273	273	285.5	298	298	310.5	323	323	335.5	348	360.5	360.5	373	385.5	385.5	398	410.5	410.5
2	260.5	273	285.5	285.5	298	310.5	310.5	323	335.5	348	348	360.5	373	373	385.5	398	398	410.5	423	423	435.5	448	448	460.5
3	310.5	323	335.5	335.5	348	360.5	360.5	373	385.5	385.5	398	410.5	410.5	423	435.5	435.5	448	460.5	460.5	473	485.5	485.5	498	510.5
4	360.5	373	373	385.5	398	398	410.5	423	423	435.5	448	448	460.5	473	473	485.5	498	498	510.5	523	523	535.5	548	560.5
5	410.5	410.5	423	435.5	435.5	448	460.5	460.5	473	485.5	485.5	498	510.5	523	523	535.5	548	548	560.5	573	573	585.5	598	598
6	448	460.5	473	473	485.5	498	510.5	510.5	523	535.5	535.5	548	560.5	560.5	573	585.5	585.5	598	610.5	610.5	623	635.5	635.5	648
7	498	510.5	523	523	535.5	548	548	560.5	573	573	585.5	598	598	610.5	623	623	635.5	648	648	660.5	673	673	685.5	698
8	548	560.5	560.5	573	585.5	585.5	598	610.5	610.5	623	635.5	635.5	648	660.5	660.5	673	685.5	698	698	710.5	723	723	735.5	748
9	598	598	610.5	623	623	635.5	648	648	660.5	673	685.5	685.5	698	710.5	710.5	723	735.5	735.5	748	760.5	760.5	773	785.5	785.5

Plug-in Manifold Stacking Base

D-sub Connector

F kit

Plug-in Manifold
Stacking Base



MIL Standard

- 25 pins
- Cable length:
1.5 m, 3 m, 5 m

Connector mounting
direction: Top or side
selectable

Page 457



Directional
Control Valves

Air Cylinders

Rotary Actuators

Air Grippers

Air Preparation
Equipment

Modular F. R.

Pressure Control
Equipment

Fittings & Tubing

Flow Control
Equipment

Pressure Switches/
Pressure Sensors

F

Series 10-S0700 Plug-in Manifold Stacking Base kit (D-sub Connector)

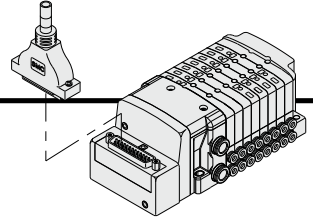

- The D-sub connector reduces installation labor for electrical connections.
- Using the D-sub connector (25P) conforming to MIL standard permits the use of commercial connectors and gives a wide interchangeability.
- Top or side receptacle position can be selected in accordance with the available mounting space.

Electrical Wiring Specifications

D-sub connector

As the standard electrical wiring specifications, double wiring (connected to SOL.A and SOL.B) is adopted for the internal wiring of each station for 12 stations or less, regardless of valve and option types. Mixed single and double wiring is available as an option. For details, refer to "Special Wiring Specifications" (Option) below.

D-sub connector assembly
wire color (AXT100-DS25-030 050)

Terminal no.	Polarity	Lead wire color	Dot marking
Station 1 SOL.A 1	(-)	(+) Black	None
Station 1 SOL.B 14	(-)	(+) Yellow	Black
Station 2 SOL.A 2	(-)	(+) Brown	None
Station 2 SOL.B 15	(-)	(+) Pink	Black
Station 3 SOL.A 3	(-)	(+) Red	None
Station 3 SOL.B 16	(-)	(+) Blue	White
Station 4 SOL.A 4	(-)	(+) Orange	None
Station 4 SOL.B 17	(-)	(+) Purple	None
Station 5 SOL.A 5	(-)	(+) Yellow	None
Station 5 SOL.B 18	(-)	(+) Gray	None
Station 6 SOL.A 6	(-)	(+) Pink	None
Station 6 SOL.B 19	(-)	(+) Orange	Black
Station 7 SOL.A 7	(-)	(+) Blue	None
Station 7 SOL.B 20	(-)	(+) Red	White
Station 8 SOL.A 8	(-)	(+) Purple	White
Station 8 SOL.B 21	(-)	(+) Brown	White
Station 9 SOL.A 9	(-)	(+) Gray	Black
Station 9 SOL.B 22	(-)	(+) Pink	Red
Station 10 SOL.A 10	(-)	(+) White	Black
Station 10 SOL.B 23	(-)	(+) Gray	Red
Station 11 SOL.A 11	(-)	(+) White	Red
Station 11 SOL.B 24	(-)	(+) Black	White
Station 12 SOL.A 12	(-)	(+) Yellow	Red
Station 12 SOL.B 25	(-)	(+) White	None
COM. 13	(+)	(-) Orange	Red

Note) Mounting valve has no polarity. It can also be used as a negative common.

Special Wiring Specifications (Option) [-K]

(25P)

Mixed single and double wiring are available as an option. The maximum number of manifold stations is determined by the number of solenoids. Count one point for a single solenoid type and two points for a double solenoid type. The total number of solenoids (points) must not exceed 24.

1. How to Order valve
Indicate an option symbol, -K, for the manifold part number and be sure to specify the mounting position and number of stations of the single and double wiring on the manifold specification sheet.

2. Wiring specifications
Connector terminal numbers are connected from solenoid station 1 on the A side in the order indicated by the arrows without skipping any terminal numbers.

Cable Assembly

015
AXT100-DS25-030
050

(The D-sub connector cable assemblies can be ordered with manifolds. Refer to "How to Order Manifold.")

D-sub connector cable assembly
Wire Color by Terminal No.

Terminal no.	Lead wire color	Dot marking
1	Black	None
2	Brown	None
3	Red	None
4	Orange	None
5	Yellow	None
6	Pink	None
7	Blue	None
8	Purple	White
9	Gray	Black
10	White	Black
11	White	Red
12	Yellow	Red
13	Orange	Red
14	Yellow	Black
15	Pink	Black
16	Blue	White
17	Purple	None
18	Gray	None
19	Orange	Black
20	Red	White
21	Brown	White
22	Pink	Red
23	Gray	Red
24	Black	White
25	White	None

D-sub Connector Cable Assembly (Option)

Cable length (L)	Assembly part no.	Note
1.5 m	AXT100-DS25-015	Cable 0.3 mm ² x 25 cores
3 m	AXT100-DS25-030	
5 m	AXT100-DS25-050	

* For other commercial connectors, use a 25-pin type with female connector conforming to MIL-C-24308.
* Cannot be used for movable wiring.

Electrical Characteristics

Item	Property
Conductor resistance Ω/km, 20°C	65 or less
Voltage limit V, 1 minute, AC	1000
Insulation resistance MΩ/km, 20°C	5 or more

Note) The minimum bending radius of D-sub connector cable is 20 mm.

Example of connector manufacturers

- Fujitsu Limited
- Japan Aviation Electronics Industry, Limited
- J.S.T. Mfg. Co., Ltd.
- HIROSE ELECTRIC CO., LTD.



How to Order Manifold

10-SS0750-08 C4 C8 FD1-B

Clean series

Symbol	Stations
02	2 stations
⋮	⋮
24 (Note)	24 stations

Note) The maximum number of stations will be different depending on the wiring specifications.

Cylinder port size

Symbol	Port size	
C2	With ø2 One-touch fitting	Metric
C3	With ø3.2 One-touch fitting	
C4	With ø4 One-touch fitting	
CM	Mixed sizes and with port plug (Note)	
N1	With ø1/8" One-touch fitting	Inch
N3	With ø5/32" One-touch fitting	
NM	Mixed sizes and with port plug (Note)	

Note) Indicate the sizes on the manifold specification sheet for CM and NM.

P, R port size

Symbol	Port size	
Nil	With ø8 One-touch fitting (Note)	Metric
C6	With ø6 One-touch fitting	
C8	With ø8 One-touch fitting	
N7	With ø1/4" One-touch fitting	Inch
N9	With ø5/16" One-touch fitting	

Note) The P, R port size is ø5/16" when the cylinder ports are inch sizes.

Option

Symbol	Specifications
Nil	None
B (Note 2)	With back pressure check valve (All stations)
D	With DIN rail (Rail length: Standard)
D0	Without DIN rail (With bracket)
D□ (Note 3)	With DIN rail Designated length (□: Station)
K (Note 4)	Special wiring specifications (Except double wiring)
N	With name plate
R (Note 5)	External pilot

Note 1) When two or more options are specified, indicate them alphabetically. Example) -BKN
 Note 2) When installing a back pressure check valve on the required station, enter the part number and specify the station position on the manifold specification sheet.
 Note 3) The available number of stations is larger than the number of manifold stations.

Note 4) Indicate the wiring specifications for mixed single and double wirings.
 Note 5) For details, refer to page 481.
 * For manifold optional parts, refer to pages 481 to 484.
 * For manifold exploded view, refer to page 487.

Kit type/Cable length

Kit type	Symbol	Specifications	Standard station	Max. number of stations for special wiring specifications	Max. number of solenoids
F kit	FD0	D-sub connector (25P), without cable	1 to 12 stations	24 stations	24
	FD1	D-sub connector (25P), with 1.5 m cable			
	FD2	D-sub connector (25P), with 3.0 m cable			
	FD3	D-sub connector (25P), with 5.0 m cable			

Note) The maximum number of stations is determined by the total number of solenoids. For mixed single and double wirings, enter "K" to the order code options.

Actuation type	Single	Double, Dual 3-port
Number of solenoids	1	2

How to Order Valve

10-S07 1 0 - 5

Clean series

Actuation type

Symbol	Specifications
1	2-position single
2	2-position double
A	4-position dual 3-port (N.C. + N.C.) [Exhaust center]
B	4-position dual 3-port (N.O. + N.O.) [Pressure center]
C	4-position dual 3-port (N.C. + N.O.)

Note) For symbol, refer to page 423.

Voltage

Symbol	Specifications
5	24 VDC
6	12 VDC

Function

Symbol	Specifications
Nil	Standard
R	External pilot (Note)

Note) Not compatible with dual 3-port valves. The 3(R) port is released to the atmosphere. (Pressurization and vacuum are not allowed.)

Base mounted plug-in

How to Order Manifold Assembly

Specify the part numbers for valves and options together beneath the manifold base part number.

<Example>

D-sub connector kit
 10-SS0750-08C4FD1...1 set - Manifold base part no.
 = 10-S0710-53 sets - Valve part no. (Stations 1 to 3)
 = 10-S0720-52 sets - Valve part no. (Stations 4 to 5)
 = 10-S07A0-52 sets - Valve part no. (Stations 6 to 7)
 = SS0700-10A-11 set - Blanking plate part no. (Station 8)

Write sequentially from the 1st station on the D side. When part no. written collectively are complicated, specify on the manifold specification sheet.

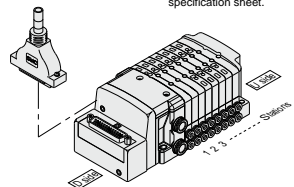

Directional Control Valves

Air Cylinders

Rotary Actuators

Air Grippers

Air Preparation Equipment

Modular F. R.

Pressure Control Equipment

Fittings & Tubing

Flow Control Equipment

Pressure Switches/ Pressure Sensors

F

Series 10-S0700 kit (D-sub Connector)

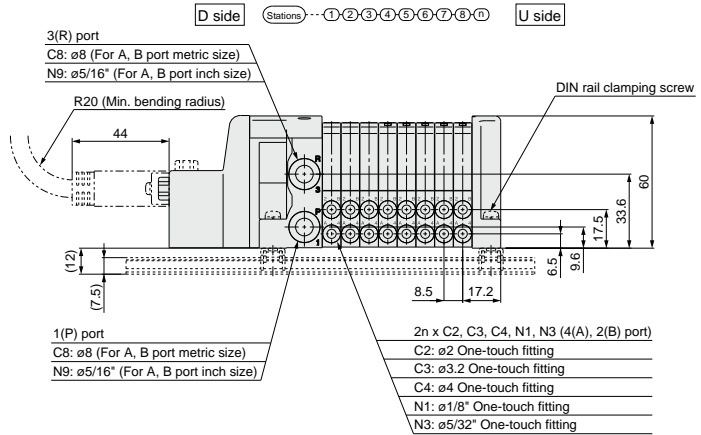
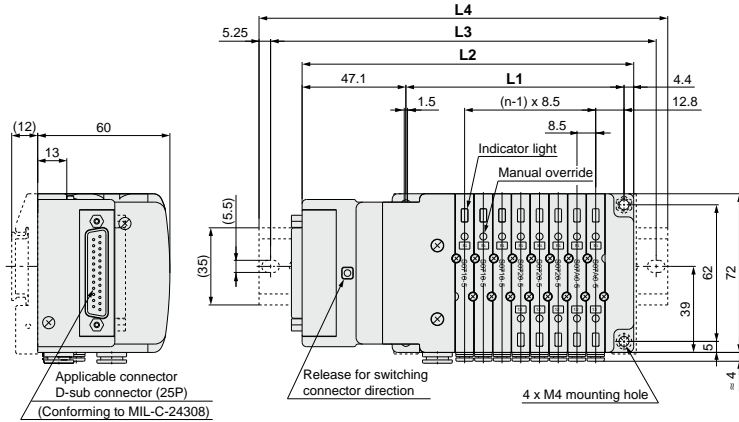

Dimensions

Formula L1 = 8.5n + 31, L2 = 8.5n + 82.5 n: Station (Maximum 24 stations)

L \ n	2	3	4	5	6	7	8	9	10	11	12	13	14	15	16	17	18	19	20	21	22	23	24
L1	48	56.5	65	73.5	82	90.5	99	107.5	116	124.5	133	141.5	150	158.5	167	175.5	184	192.5	201	209.5	218	226.5	235
L2	99.5	108	116.5	125	133.5	142	150.5	159	167.5	176	184.5	193	201.5	210	218.5	227	235.5	244	252.5	261	269.5	278	286.5
L3	125	137.5	137.5	150	162.5	162.5	175	187.5	187.5	200	212.5	212.5	225	237.5	250	250	262.5	275	275	287.5	300	300	312.5
L4	135.5	148	148	160.5	173	173	185.5	198	198	210.5	223	223	235.5	248	260.5	260.5	273	285.5	285.5	298	310.5	310.5	323

Plug-in Manifold Stacking Base

Flat Ribbon Cable

P kit

Plug-in Manifold
Stacking Base



MIL Standard

■ 26 pins, 20 pins

■ Cable length
1.5 m, 3 m, 5 m

Connector mounting
direction: Top or side
selectable

Page 461



Directional
Control Valves

Air Cylinders

Rotary Actuators

Air Grippers

Air Preparation
Equipment

Modular F. R.

Pressure Control
Equipment

Fittings & Tubing

Flow Control
Equipment

Pressure Switches/
Pressure Sensors

P Series 10-S0700 Plug-in Manifold Stacking Base kit (Flat Ribbon Cable)

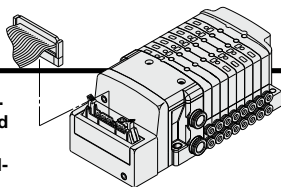

- Flat ribbon cable connector reduces installation labor for electrical connection.
- Using the connector for flat ribbon cable (26P, 20P) conforming to MIL standard permits the use of commercial connectors and gives a wide interchangeability.
- Top or side receptacle position can be selected in accordance with the available mounting space.

Electrical Wiring Specifications

Flat ribbon cable connector

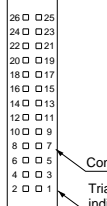

Double wiring (connected to SOL.A and SOL.B) is adopted for the internal wiring of each station, regardless of valve and option types.
Mixed single and double wiring is available as an option. For details, refer to "Special Wiring Specifications" (Option) below.

Connector terminal no.

Triangle mark indicator position

<26P>

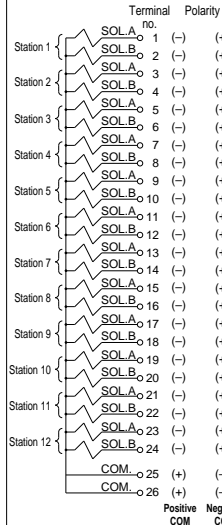

<20P>

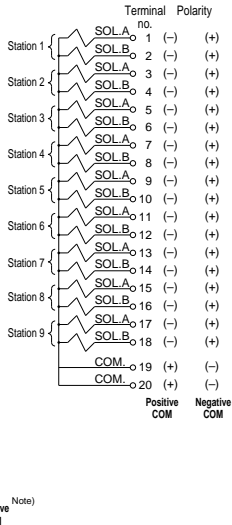

Note) Mounting valve has no polarity. It can also be used as a negative common.

Cable Assembly

AXT100-FC²⁰₂₆¹₂³

(Type 26P flat ribbon cable connector assemblies can be ordered) with manifolds. Refer to "How to Order Manifold."

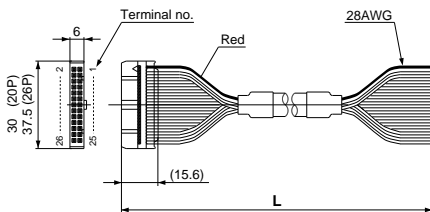

Flat Ribbon Cable Connector Assembly (Option)

Cable length (L)	Assembly part no.	
	26P	20P
1.5 m	AXT100-FC26-1	AXT100-FC20-1
3 m	AXT100-FC26-2	AXT100-FC20-2
5 m	AXT100-FC26-3	AXT100-FC20-3

- * For other commercial connectors, use a 20- or 26-pin type with strain relief conforming to MIL-C-83503.
- * Cannot be used for movable wiring.

Example of connector manufacturers

- HIROSE ELECTRIC CO., LTD.
- 3M Japan Limited
- Fujitsu Limited
- Japan Aviation Electronics Industry, Limited
- J.S.T. Mfg. Co., Ltd.
- Oki Electric Cable Co., Ltd.

Special Wiring Specifications (Option) [-K]

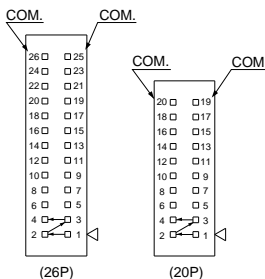

Mixed single and double wiring are available as an option. The maximum number of manifold stations is determined by the number of solenoids. Count one point for a single solenoid type and two points for a double solenoid type. The total number of solenoids (points) must not exceed 24 for 26P, 18 for 20P.

1. How to Order valve
Indicate an option symbol, -K, for the manifold part number and be sure to specify the mounting position and number of stations of the single and double wiring on the manifold specification sheet.

2. Wiring specifications
Connector terminal numbers are connected from solenoid station 1 on the A side in the order indicated by the arrows without skipping any terminal numbers.



How to Order Manifold

10-SS0750-08 C4 C8 PD1-B

Clean series

Symbol	Stations
02	2 stations
⋮	⋮
24	24 stations

Note) The maximum number of stations will be different depending on the wiring specifications.

Cylinder port size

Symbol	Port size	
C2	With ø2 One-touch fitting	Metric
C3	With ø3.2 One-touch fitting	
C4	With ø4 One-touch fitting	
CM	Mixed sizes and with port plug ^{Note)}	
N1	With ø1/8" One-touch fitting	Inch
N3	With ø5/32" One-touch fitting	
NM	Mixed sizes and with port plug ^{Note)}	

Note) Indicate the sizes on the manifold specification sheet for CM and NM.

P, R port size

Symbol	Port size	
Nii	With ø8 One-touch fitting ^{Note)}	Metric
C6	With ø6 One-touch fitting	
C8	With ø8 One-touch fitting	
N7	With ø1/4" One-touch fitting	Inch
N9	With ø5/16" One-touch fitting	

Note) The P, R port size is ø5/16" when the cylinder ports are inch sizes.

Option

Symbol	Specifications
Nil	None
B	With back pressure check valve (All stations)
D	With DIN rail (Rail length: Standard)
D0	Without DIN rail (With bracket)
D□ ^{Note 3)}	With DIN rail Designated length (□: Station)
K ^{Note 4)}	Special wiring specifications (Except double wiring)
N	With name plate
R ^{Note 5)}	External pilot

- Note 1) When two or more options are specified, indicate them alphabetically. Example) -BKN
 - Note 2) When installing a back pressure check valve on the required station, enter the part number and specify the station position on the manifold specification sheet.
 - Note 3) The available number of stations is larger than the number of manifold stations.
 - Note 4) Indicate the wiring specifications for mixed single and double wirings.
 - Note 5) For details, refer to page 481.
- * For manifold optional parts, refer to pages 481 to 484.
* For manifold exploded view, refer to page 487.

Kit type/Cable length

Kit type	Symbol	Specifications	Standard station	Max. number of stations for special wiring specifications	Max. number of solenoids
P kit	PD0	Flat ribbon cable (26P), without cable	1 to 12 stations	24 stations	24
	PD1	Flat ribbon cable (26P), with 1.5 m cable			
	PD2	Flat ribbon cable (26P), with 3.0 m cable			
	PD3	Flat ribbon cable (26P), with 5.0 m cable			
	PDC	Flat ribbon cable (20P), without cable			

Note) The maximum number of stations is determined by the total number of solenoids. For mixed single and double wirings, enter "K" to the order code options.

Actuation type	Single	Double, Dual 3-port
Number of solenoids	1	2

How to Order Valve

10-S07 1 0 - 5

Clean series

Actuation type

Symbol	Specifications
1	2-position single
2	2-position double
A	4-position dual 3-port (N.C. + N.C.) [Exhaust center]
B	4-position dual 3-port (N.O. + N.O.) [Pressure center]
C	4-position dual 3-port (N.C. + N.O.)

Note) For symbol, refer to page 423.

Base mounted plug-in

Voltage

Symbol	Specifications
5	24 VDC
6	12 VDC

Function

Symbol	Specifications
Nil	Standard
R	External pilot ^{Note)}

Note) Not compatible with dual 3-port valves. The 3(R) port is released to the atmosphere. (Pressurization and vacuum are not allowed.)

How to Order Manifold Assembly

Specify the part numbers for valves and options together beneath the manifold base part number.

<Example>

Flat ribbon cable kit

- 10-SS0750-08C4PD1-1 1 set - Manifold base part no.
- * 10-S0710-5 2 sets - Valve part no. (Stations 1 to 3)
- * 10-S0720-5 4 sets - Valve part no. (Stations 4 to 5)
- * 10-S07A0-5 1 set - Valve part no. (Stations 6 to 7)
- * SS0700-10A-1 1 set - Blanking plate part no. (Station 8)

Prefix the asterisk to the part no. of the solenoid valve, etc.

Write sequentially from the 1st station on the D side. When part no. written collectively are complicated, specify on the manifold specification sheet.

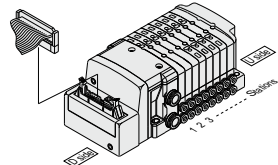

Directional Control Valves

Air Cylinders

Rotary Actuators

Air Grippers

Air Preparation Equipment

Modular F. R.

Pressure Control Equipment

Fittings & Tubing

Flow Control Equipment

Pressure Switches/ Pressure Sensors

P

Series 10-S0700 kit (Flat Ribbon Cable)

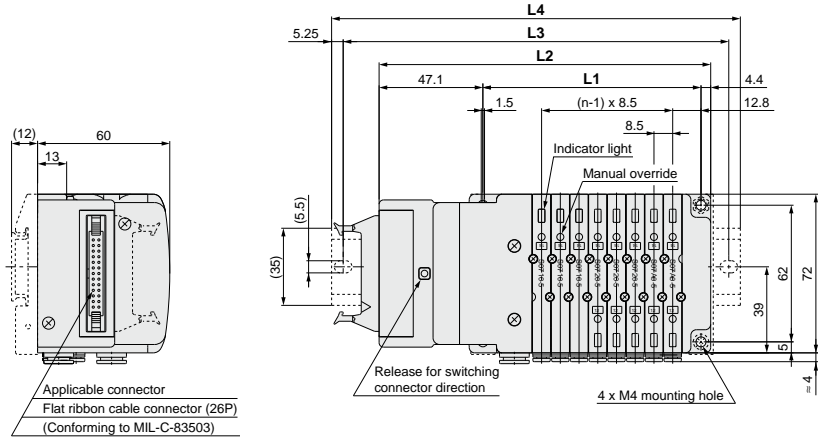

D side Stations 1 2 3 4 5 6 7 8 11 U side

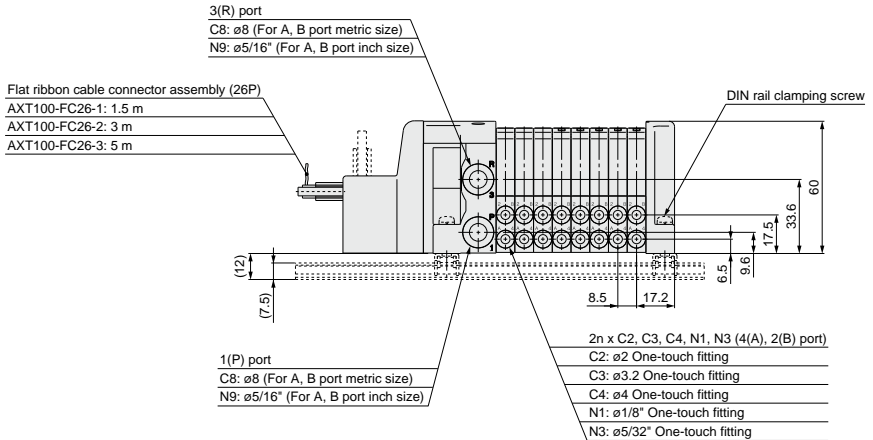

Dimensions

Formula L1 = 8.5n + 31, L2 = 8.5n + 82.5 n: Station (Maximum 24 stations)

L \ n	2	3	4	5	6	7	8	9	10	11	12	13	14	15	16	17	18	19	20	21	22	23	24
L1	48	56.5	65	73.5	82	90.5	99	107.5	116	124.5	133	141.5	150	158.5	167	175.5	184	192.5	201	209.5	218	226.5	235
L2	99.5	108	116.5	125	133.5	142	150.5	159	167.5	176	184.5	193	201.5	210	218.5	227	235.5	244	252.5	261	269.5	278	286.5
L3	125	137.5	150	162.5	175	187.5	200	212.5	225	237.5	250	262.5	275	287.5	300	312.5	325	337.5	350	362.5	375	387.5	400
L4	135.5	148	160.5	173	185.5	198	210.5	223	235.5	248	260.5	273	285.5	298	310.5	323	335.5	348	360.5	373	385.5	398	410.5

Plug-in Manifold Stacking Base

PC Wiring System Compatible Flat Ribbon Cable

J kit

Plug-in Manifold
Stacking Base

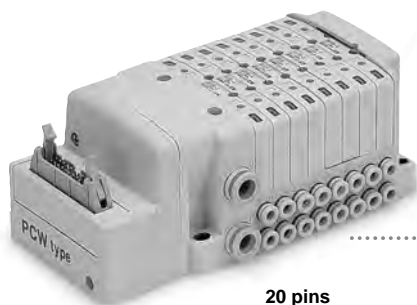

20 pins

MIL Standard

■ 20 pins

PC wiring system
compatible



Page 465

Directional
Control Valves

Air Cylinders

Rotary Actuators

Air Grippers

Air Preparation
Equipment

Modular F. R.

Pressure Control
Equipment

Fittings & Tubing

Flow Control
Equipment

Pressure Switches/
Pressure Sensors

J

Series 10-S0700 Plug-in Manifold Stacking Base kit (PC Wiring System Compatible Flat Ribbon Cable)

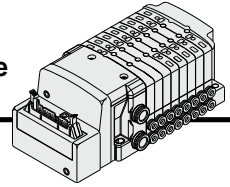

- Compatible with PC wiring system.
- Using connector for flat ribbon cable (20P) conforming to MIL standard permits the use of commercial connectors and gives a wide interchangeability.
- Top or side receptacle position can be selected in accordance with the available mounting space.

Electrical Wiring Specifications

Double wiring (connected to SOL.A and SOL.B) is adopted for the internal wiring of each station, regardless of valve and option types. Mixed single and double wiring is available as an option. For details, refer to "Special Wiring Specifications" (Option) below.

Flat ribbon cable connector

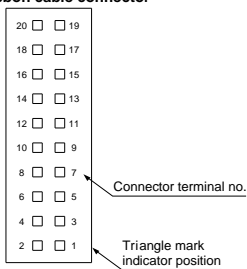

Special Wiring Specifications (Option) [-K]

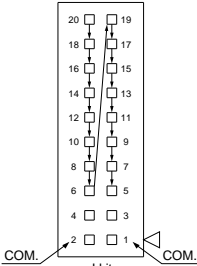

J kit
Flat ribbon cable connector (20P)
PC wiring system compatible

Mixed single and double wiring are available as an option. The maximum number of manifold stations is determined by the number of solenoids. Count one point for a single solenoid type and two points for a double solenoid type. The total number of solenoids (points) must not exceed 16.

1. How to Order valve

Indicate an option symbol, -K, for the manifold part number and be sure to specify the mounting position and number of stations of the single and double wiring on the manifold specification sheet.

2. Wiring specifications

Connector terminal numbers are connected from solenoid station 1 on the A side in the order indicated by the arrows without skipping any terminal numbers.

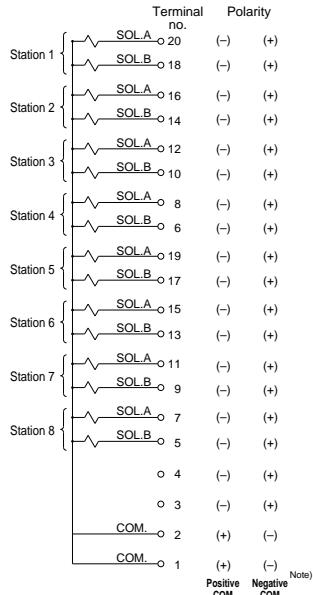

Note) Mounting valve has no polarity. It can also be used as a negative common.

For details about the PC wiring system, refer to the catalog CAT.ES02-20 separately.



How to Order Manifold

10-SS0750-08 C4 C8 JD0 - B

Clean series

Symbol	Stations
02	2 stations
⋮	⋮
16	16 stations

Note) The maximum number of stations will be different depending on the wiring specifications.

Cylinder port size

Symbol	Port size	
C2	With ø2 One-touch fitting	Metric
C3	With ø3.2 One-touch fitting	
C4	With ø4 One-touch fitting	
CM	Mixed sizes and with port plug <small>Note)</small>	
N1	With ø1/8" One-touch fitting	Inch
N3	With ø5/32" One-touch fitting	
NM	Mixed sizes and with port plug <small>Note)</small>	

Note) Indicate the sizes on the manifold specification sheet for CM and NM.

P, R port size

Symbol	Port size	
Nil	With ø8 One-touch fitting <small>Note)</small>	Metric
C6	With ø6 One-touch fitting	
C8	With ø8 One-touch fitting	
N7	With ø1/4" One-touch fitting	Inch
N9	With ø5/16" One-touch fitting	

Note) The P, R port size is ø5/16" when the cylinder ports are inch sizes.

Option

Symbol	Specifications
Nil	None
B <small>Note 2)</small>	With back pressure check valve (All stations)
D	With DIN rail (Rail length: Standard)
D0	Without DIN rail (With bracket)
D□ <small>Note 3)</small>	With DIN rail Designated length (□: Station)
K <small>Note 4)</small>	Special wiring specifications (Except double wiring)
N	With name plate
R <small>Note 5)</small>	External pilot

- Note 1) When two or more options are specified, indicate them alphabetically. Example) -BKN
- Note 2) When installing a back pressure check valve on the required station, enter the part number and specify the station position on the manifold specification sheet.
- Note 3) The available number of stations is larger than the number of manifold stations.
- Note 4) Indicate the wiring specifications for mixed single and double wirings.
- Note 5) For details, refer to page 481.
- * For manifold optional parts, refer to pages 481 to 484.
- * For manifold exploded view, refer to page 487.

Kit type

Kit type	Symbol	Specifications	Standard station	Max. number of stations for special wiring specifications	Max. number of solenoids
J kit	JD0	Flat ribbon cable (20P) PC wiring system compatible <small>Note 1)</small>	1 to 8 stations	16 stations	16

- Note 1) For 20P type cable assembly of J kit, order it separately.
- Note 2) The maximum number of stations is determined by the total number of solenoids. For mixed single and double wirings, enter "-K" to the order code options.

Actuation type	Single	Double, Dual 3-port
Number of solenoids	1	2

How to Order Valve

10-S07 1 0 □ - 5

Clean series

Actuation type

Symbol	Specifications
1	2-position single
2	2-position double
A	4-position dual 3-port (N.C. + N.C.) [Exhaust center]
B	4-position dual 3-port (N.O. + N.O.) [Pressure center]
C	4-position dual 3-port (N.C. + N.O.)

Note) For symbol, refer to page 423.

Voltage

Symbol	Specifications
5	24 VDC
6	12 VDC

Function

Symbol	Specifications
Nil	Standard
R	External pilot <small>Note)</small>

Note) Not compatible with dual 3-port valves. The 3(R) port is released to the atmosphere. (Pressurization and vacuum are not allowed.)

Base mounted plug-in

How to Order Manifold Assembly

Specify the part numbers for valves and options together beneath the manifold base part number.

<Example>

Flat ribbon cable kit
 10-SS0750-08C4JD0-1 set - Manifold base part no.
 * 10-S0710-5 3 sets - Valve part no. (Stations 1 to 3)
 * 10-S0720-5 2 sets - Valve part no. (Stations 4 to 5)
 * 10-S07A0-5 2 sets - Valve part no. (Stations 6 to 7)
 * SS0700-10A-1 1 set - Blanking plate part no. (Station 8)

Write sequentially from the 1st station on the D side. When part no. written collectively are complicated, specify on the manifold specification sheet.

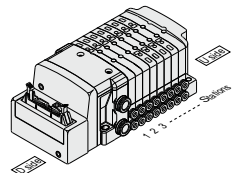

Directional Control Valves

Air Cylinders

Rotary Actuators

Air Grippers

Air Preparation Equipment

Modular F. R.

Pressure Control Equipment

Fittings & Tubing

Flow Control Equipment

Pressure Switches/ Pressure Sensors

J

Series 10-S0700

kit (PC Wiring System Compatible Flat Ribbon Cable)

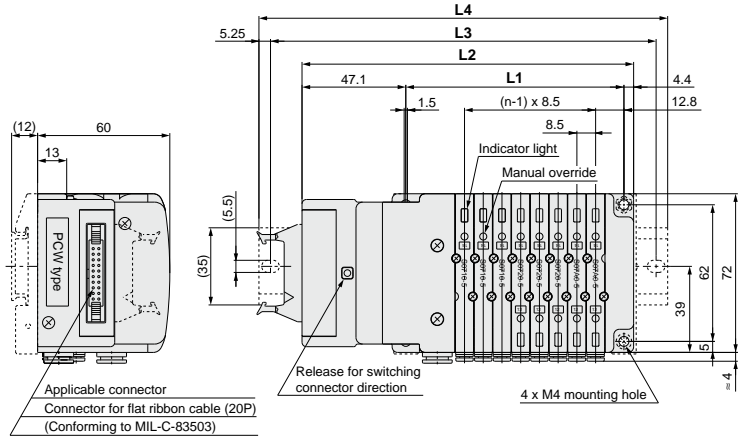

D side Stations ① ② ③ ④ ⑤ ⑥ ⑦ ⑧ ⑩ U side

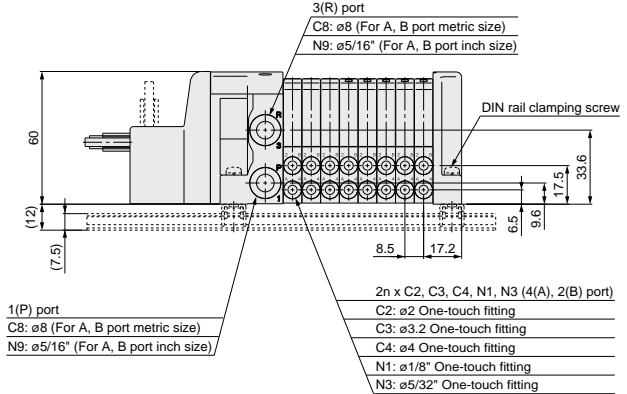

Dimensions

Formula L1 = 8.5n + 31, L2 = 8.5n + 82.5 n: Station (Maximum 16 stations)

L \ n	2	3	4	5	6	7	8	9	10	11	12	13	14	15	16
L1	48	56.5	65	73.5	82	90.5	99	107.5	116	124.5	133	141.5	150	158.5	167
L2	99.5	108	116.5	125	133.5	142	150.5	159	167.5	176	184.5	193	201.5	210	218.5
L3	125	137.5	137.5	150	162.5	162.5	175	187.5	187.5	200	212.5	212.5	225	237.5	250
L4	135.5	148	148	160.5	173	173	185.5	198	198	210.5	223	223	235.5	248	260.5

Plug-in Manifold Stacking Base

Terminal Block Box

T kit

Plug-in Manifold
Stacking Base



With
Terminal
Block Box

Page 469



Directional
Control Valves

Air Cylinders

Rotary Actuators

Air Grippers

Air Preparation
Equipment

Modular F. R.

Pressure Control
Equipment

Fittings & Tubing

Flow Control
Equipment

Pressure Switches/
Pressure Sensors

T

Series 10-S0700 Plug-in Manifold Stacking Base kit (Terminal Block Box)

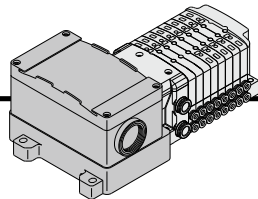

- This kit has a small terminal box inside a junction box. The electrical entry port (G3/4) permits connection of conduit fittings.

Terminal Block Connection

Step 1. How to remove terminal block cover

Loosen the 4 mounting screws (M4) and open the terminal block cover.

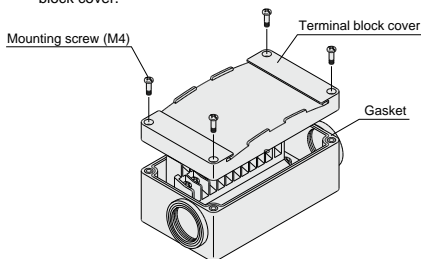

Step 3. How to replace terminal block cover

Securely tighten the screws with the torque shown in the table below, after confirming that the gasket is installed correctly.

Proper tightening torque (N·m)
0.7 to 1.2

Step 2. The diagram below shows the terminal block wiring schematic. All stations are provided with double solenoid wiring.

Connect each wire to the power supply side, according to the markings provided inside the terminal block.

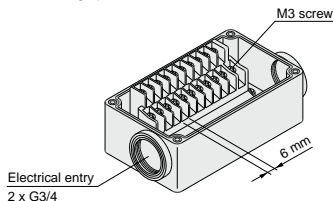

- Applicable crimped terminal: 1.25-3S, 1.25Y-3, 1.25Y-3N, 1.25Y-3.5

Electrical Wiring Specifications

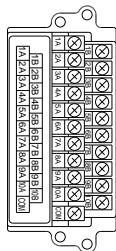

Double wiring (connected to SOL.A and SOL.B) is adopted for the internal wiring of each station, regardless of valve and option types. Mixed single and double wiring is available as an option.

Note) Mounting valve has no polarity. It can also be used as a negative common.

Standard wiring

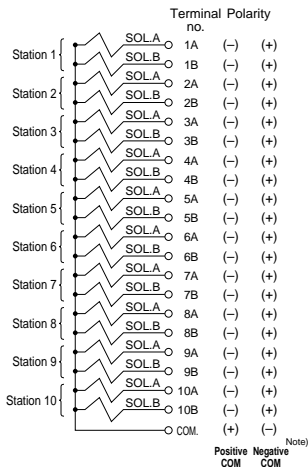

Special Wiring Specifications (Option) [-K]

Mixed single and double wiring are available as an option. The maximum number of manifold stations is determined by the number of solenoids. Count one point for a single solenoid type and two points for a double solenoid type. The total number of solenoids (points) must not exceed 20.

1. How to Order valve

Indicate an option symbol, -K, for the manifold part number and be sure to specify the mounting position and number of stations of the single and double wiring on the manifold specification sheet.

2. Wiring specifications

Connector terminal numbers are connected from solenoid station 1 on the A side in the order indicated by the arrows without skipping any terminal numbers.





How to Order Manifold

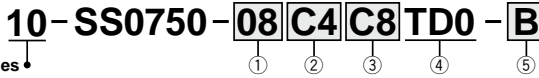

Clean series

① Stations

Symbol	Stations
01	1 station
:	:
20 ^(Note)	20 stations

Note) The maximum number of stations will be different depending on the wiring specifications.

② Cylinder port size

Symbol	Port size	
C2	With ø2 One-touch fitting	Metric
C3	With ø3.2 One-touch fitting	
C4	With ø4 One-touch fitting	
CM	Mixed sizes and with port plug ^(Note)	
N1	With ø1/8" One-touch fitting	Inch
N3	With ø5/32" One-touch fitting	
NM	Mixed sizes and with port plug ^(Note)	

Note) Specify "Mixed sizes and with port plug" on the manifold specification sheet.

③ P, R port size

Symbol	Port size	
Nil	With ø8 One-touch fitting ^(Note)	Metric
C6	With ø6 One-touch fitting	
C8	With ø8 One-touch fitting	
N7	With ø1/4" One-touch fitting	Inch
N9	With ø5/16" One-touch fitting	

Note) The P, R port size is ø5/16" when the cylinder ports are inch sizes.

④ Kit type

Kit type	Symbol	Specifications	Standard station	Max. number of stations for special wiring specifications	Max. number of solenoids
T kit	TD0	Terminal block box	1 to 10 stations	20 stations	20

Note) The maximum number of stations is determined by the total number of solenoids. For mixed single and double wirings, enter "K" to the order code options.

Actuation type	Single	Double, Dual 3-port
Number of solenoids	1	2

⑤ Option

Symbol	Specifications
Nil	None
B ^(Note 2)	With back pressure check valve (All stations)
D	With DIN rail (Rail length: Standard)
D0	Without DIN rail (With bracket)
D□ ^(Note 3)	With DIN rail Designated length (□: Station)
K ^(Note 4)	Special wiring specifications (Except double wiring)
N	With name plate
R ^(Note 5)	External pilot

Note 1) When two or more options are specified, indicate them alphabetically.

Example) -BKN

Note 2) When installing a back pressure check valve on the required station, enter the part number and specify the station position on the manifold specification sheet.

Note 3) The available number of stations is larger than the number of manifold stations.

Note 4) Indicate the wiring specifications for mixed single and double wirings.

Note 5) For details, refer to page 481.

* For manifold optional parts, refer to pages 481 to 484.

* For manifold exploded view, refer to page 487.

How to Order Valve



Clean series

Actuation type

Symbol	Specifications
1	2-position single
2	2-position double
A	4-position dual 3-port (N.C. + N.C.) [Exhaust center]
B	4-position dual 3-port (N.O. + N.O.) [Pressure center]
C	4-position dual 3-port (N.C. + N.O.)

Note) For symbol, refer to page 423.

Voltage

Symbol	Specifications
5	24 VDC
6	12 VDC

Function

Symbol	Specifications
Nil	Standard
R	External pilot ^(Note)

Note) Not compatible with dual 3-port valves.

The 3(R) port is released to the atmosphere. (Pressurization and vacuum are not allowed.)

Base mounted plug-in

How to Order Manifold Assembly

Specify the part numbers for valves and options together beneath the manifold base part number.

<Example>

Terminal block box kit

10-SS0750-08C4TD0 --1 set - Manifold base part no.

* 10-S0710-53 sets - Valve part no. (Stations 1 to 3)

* 10-S0720-52 sets - Valve part no. (Stations 4 to 5)

* 10-S07A0-52 sets - Valve part no. (Stations 6 to 7)

* SS0700-10A-11 set - Blanking plate part no. (Station 8)

Prefix the asterisk to the part no. of the solenoid valve, etc.

Write sequentially from the 1st station on the D side. When part no. written collectively are complicated, specify on the manifold specification sheet.

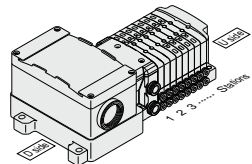

Directional Control Valves

Air Cylinders

Rotary Actuators

Air Grippers

Air Preparation Equipment

Modular F. R.

Pressure Control Equipment

Fittings & Tubing

Flow Control Equipment

Pressure Switches/ Pressure Sensors



Series 10-S0700 kit (Terminal Block Box)

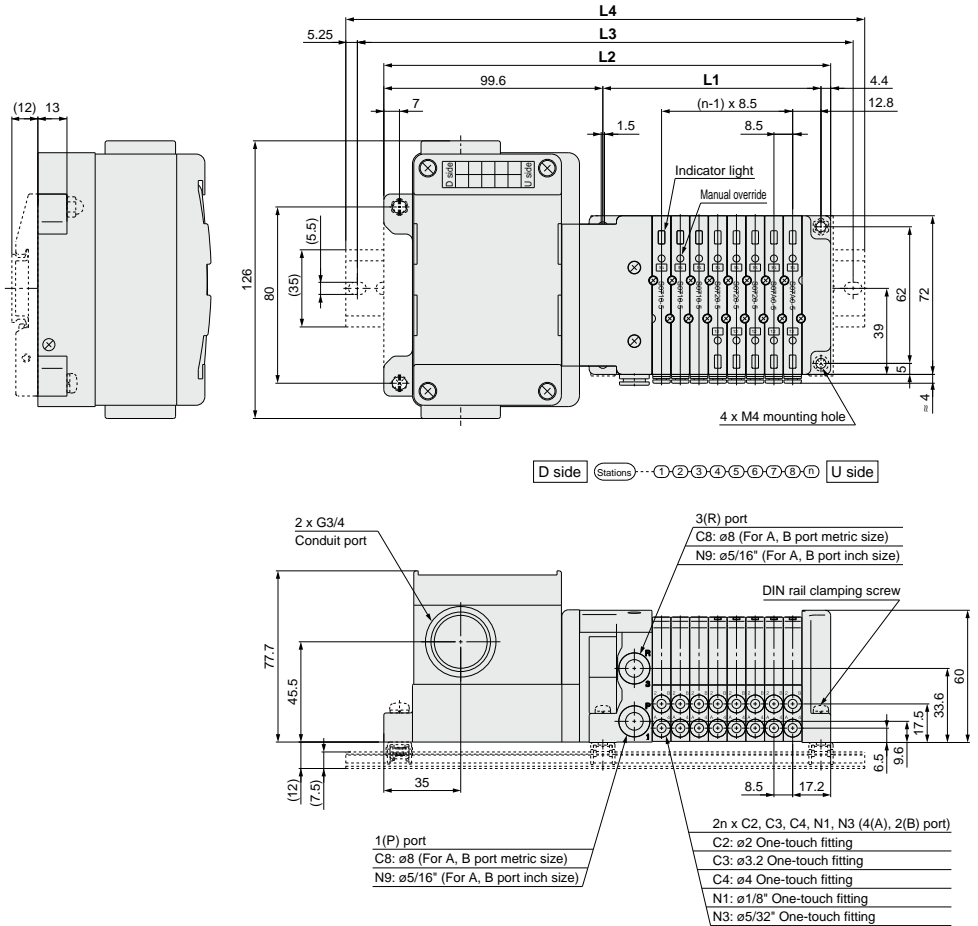

Dimensions

Formula L1 = 8.5n + 31, L2 = 8.5n + 135 n: Station (Maximum 20 stations)

L \ n	2	3	4	5	6	7	8	9	10	11	12	13	14	15	16	17	18	19	20
L1	48	56.5	65	73.5	82	90.5	99	107.5	116	124.5	133	141.5	150	158.5	167	175.5	184	192.5	201
L2	152	160.5	169	177.5	186	194.5	203	211.5	220	228.5	237	245.5	254	262.5	271	279.5	288	296.5	305
L3	175	187.5	200	212.5	225	237.5	250	262.5	275	287.5	297.5	300	300	300	300	312.5	325	325	325
L4	185.5	198	210.5	210.5	223	235.5	235.5	248	260.5	260.5	273	285.5	285.5	298	310.5	310.5	323	335.5	335.5

Plug-in Manifold Stacking Base

Lead Wire

L kit

Plug-in Manifold
Stacking Base

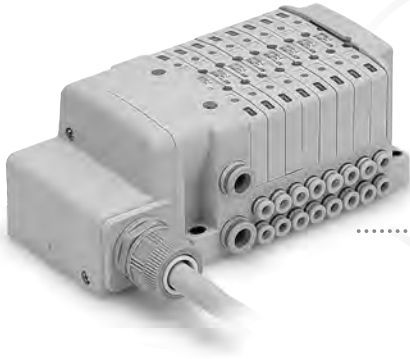

Lead Wire
Direct Entry
Type

Page 473



Directional
Control Valves

Air Cylinders

Rotary Actuators

Air Grippers

Air Preparation
Equipment

Modular F. R.

Pressure Control
Equipment

Fittings & Tubing

Flow Control
Equipment

Pressure Switches/
Pressure Sensors

L Series 10-S0700 Plug-in Manifold Stacking Base kit (Lead Wire)

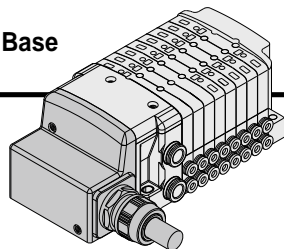

● Direct electrical entry type

Electrical Wiring Specifications

Lead wire specifications

Lead wire

0.3 mm² x 25 cores

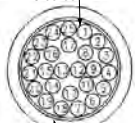

Sheath
Color: White

As the standard electrical wiring specifications, double wiring (connected to SOL.A and SOL.B) is adopted for the internal wiring of each station for 12 stations or less, regardless of valve and option types. Mixed single and double wiring is available as an option. For details, refer to "Special Wiring Specifications" (Option) below.

	Terminal no.	Polarity	Lead wire color	Dot marking
Station 1	SOL.A 1	(-)	(+) Black	None
	SOL.B 14	(-)	(+) Yellow	Black
Station 2	SOL.A 2	(-)	(+) Brown	None
	SOL.B 15	(-)	(+) Pink	Black
Station 3	SOL.A 3	(-)	(+) Red	None
	SOL.B 16	(-)	(+) Blue	White
Station 4	SOL.A 4	(-)	(+) Orange	None
	SOL.B 17	(-)	(+) Purple	None
Station 5	SOL.A 5	(-)	(+) Yellow	None
	SOL.B 18	(-)	(+) Gray	None
Station 6	SOL.A 6	(-)	(+) Pink	None
	SOL.B 19	(-)	(+) Orange	Black
Station 7	SOL.A 7	(-)	(+) Blue	None
	SOL.B 20	(-)	(+) Red	White
Station 8	SOL.A 8	(-)	(+) Purple	White
	SOL.B 21	(-)	(+) Brown	White
Station 9	SOL.A 9	(-)	(+) Gray	Black
	SOL.B 22	(-)	(+) Pink	Red
Station 10	SOL.A 10	(-)	(+) White	Black
	SOL.B 23	(-)	(+) Gray	Red
Station 11	SOL.A 11	(-)	(+) White	Red
	SOL.B 24	(-)	(+) Black	White
Station 12	SOL.A 12	(-)	(+) Yellow	Red
	SOL.B 25	(-)	(+) White	None
	COM 13	(+)	(-) Orange	Red

Positive COM Negative COM (Note)

Note) Mounting valve has no polarity. It can also be used as a negative common.

Lead wire length

SS0750 - 08 C4 LD 0

Lead wire length

0	0.6 m
1	1.5 m
2	3.0 m

Electrical Characteristics

Item	Property
Conductor resistance $\Omega/\text{km}, 20^\circ\text{C}$	65 or less
Voltage limit V, 1 minute, AC	1000
Insulation resistance $\text{M}\Omega/\text{km}, 20^\circ\text{C}$	5 or more

Note) Cannot be used for movable wiring. The minimum bending radius of cable is 20 mm.

Special Wiring Specifications (Option) [-K]

Mixed single and double wiring are available as an option. The maximum number of manifold stations is determined by the number of solenoids. Count one point for a single solenoid type and two points for a double solenoid type. The total number of solenoids (points) must not exceed 24.

1. How to Order valve

Indicate an option symbol, -K, for the manifold part number and be sure to specify the mounting position and number of stations of the single and double wiring on the manifold specification sheet.

2. Wiring specifications

Connector terminal numbers are connected from solenoid station 1 on the A side in the order indicated by the arrows without skipping any terminal numbers.



How to Order Manifold

10-SS0750-08 C4 C8 LD0-B

Clean series

Symbol	Stations
02	2 stations
⋮	⋮
24	24 stations

Note) The maximum number of stations will be different depending on the wiring specifications.

Cylinder port size

Symbol	Port size	
C2	With ø2 One-touch fitting	Metric
C3	With ø3.2 One-touch fitting	
C4	With ø4 One-touch fitting	
CM	Mixed sizes and with port plug ^{Note)}	
N1	With ø1/8" One-touch fitting	Inch
N3	With ø5/32" One-touch fitting	
NM	Mixed sizes and with port plug ^{Note)}	

Note) Specify "Mixed sizes and with port plug" on the manifold specification sheet.

P, R port size

Symbol	Port size	
Nil	With ø8 One-touch fitting ^{Note)}	Metric
C6	With ø6 One-touch fitting	
C8	With ø8 One-touch fitting	
N7	With ø1/4" One-touch fitting	Inch
N9	With ø5/16" One-touch fitting	

Note) The P, R port size is ø5/16" when the cylinder ports are inch sizes.

Option

Symbol	Specifications
Nil	None
B ^{Note 2)}	With back pressure check valve (All stations)
D	With DIN rail (Rail length: Standard)
D0	Without DIN rail (With bracket)
D □ ^{Note 3)}	With DIN rail Designated length (□: Station)
K ^{Note 4)}	Special wiring specifications (Except double wiring)
N	With name plate
R ^{Note 5)}	External pilot

- Note 1) When two or more options are specified, indicate them alphabetically. Example) -BKN
- Note 2) When installing a back pressure check valve on the required station, enter the part number and specify the station position on the manifold specification sheet.
- Note 3) The available number of stations is larger than the number of manifold stations.
- Note 4) Indicate the wiring specifications for mixed single and double wirings.
- Note 5) For details, refer to page 481.

* For manifold optional parts, refer to pages 481 to 484.

* For manifold exploded view, refer to page 487.

Kit type/Cable length

Kit type	Symbol	Specifications	Standard station	Max. number of stations for special wiring specifications	Max. number of solenoids
L kit	LD0	Lead wire, with 0.6 m cable	1 to 12 stations	24 stations	24
	LD1	Lead wire, with 1.5 m cable			
	LD2	Lead wire, with 3.0 m cable			

Note) The maximum number of stations is determined by the total number of solenoids. For mixed single and double wirings, enter "K" to the order code options.

Actuation type	Single	Double, Dual 3-port
Number of solenoids	1	2

How to Order Valve

10-S07 1 0 - 5

Clean series

Actuation type

Symbol	Specifications
1	2-position single
2	2-position double
A	4-position dual 3-port (N.C. + N.C.) [Exhaust center]
B	4-position dual 3-port (N.O. + N.O.) [Pressure center]
C	4-position dual 3-port (N.C. + N.O.)

Note) For symbol, refer to page 423.

Voltage

Symbol	Specifications
5	24 VDC
6	12 VDC

Function

Symbol	Specifications
Nil	Standard
R	External pilot ^{Note)}

Note) Not compatible with dual 3-port valves. The 3(R) port is released to the atmosphere. (Pressurization and vacuum are not allowed.)

Base mounted plug-in

How to Order Manifold Assembly

Specify the part numbers for valves and options together beneath the manifold base part number.

<Example>

Lead wire kit

- 10-SS0750-08C4LD0 --- 1 set - Manifold base part no.
- * 10-S0710-5 3 sets - Valve part no. (Stations 1 to 3)
- * 10-S0720-5 2 sets - Valve part no. (Stations 4 to 5)
- * 10-S07A0-5 2 sets - Valve part no. (Stations 6 to 7)
- * SS0700-10A-1 1 set - Blanking plate part no. (Station 8)

Prefix the asterisk to the part no. of the solenoid valve, etc.

Write sequentially from the 1st station on the D side. When part no. written collectively are complicated, specify on the manifold specification sheet.

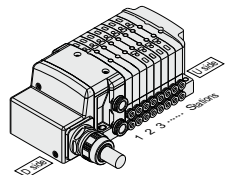

Directional Control Valves

Air Cylinders

Rotary Actuators

Air Grippers

Air Preparation Equipment

Modular F. R.

Pressure Control Equipment

Fittings & Tubing

Flow Control Equipment

Pressure Switches/ Pressure Sensors

Series 10-S0700 kit (Lead Wire)

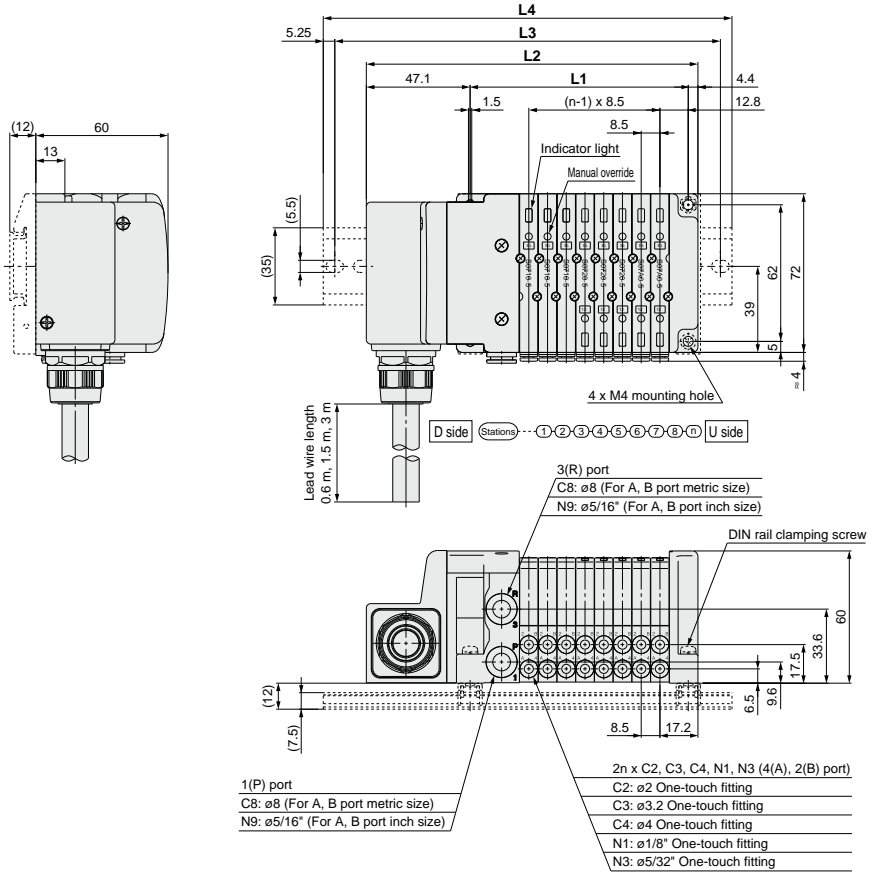

Dimensions

Formula L1 = 8.5n + 31, L2 = 8.5n + 82.5 n: Station (Maximum 24 stations)

L \ n	2	3	4	5	6	7	8	9	10	11	12	13	14	15	16	17	18	19	20	21	22	23	24
L1	48	56.5	65	73.5	82	90.5	99	107.5	116	124.5	133	141.5	150	158.5	167	175.5	184	192.5	201	209.5	218	226.5	235
L2	99.5	108	116.5	125	133.5	142	150.5	159	167.5	176	184.5	193	201.5	210	218.5	227	235.5	244	252.5	261	269.5	278	286.5
L3	125	137.5	137.5	150	162.5	162.5	175	187.5	187.5	200	212.5	225	237.5	250	250	262.5	275	275	287.5	300	300	312.5	312.5
L4	135.5	148	148	160.5	173	173	185.5	198	198	210.5	223	223	235.5	248	260.5	260.5	273	285.5	285.5	298	310.5	310.5	323

Plug-in Manifold Stacking Base

Circular Connector

M kit

Plug-in Manifold
Stacking Base



Circular
Connector
26 Pins

Page 477



Directional
Control Valves

Air Cylinders

Rotary Actuators

Air Grippers

Air Preparation
Equipment

Modular F. R.

Pressure Control
Equipment

Fittings & Tubing

Flow Control
Equipment

Pressure Switches/
Pressure Sensors

M Series 10-S0700 Plug-in Manifold Stacking Base kit (Circular Connector)

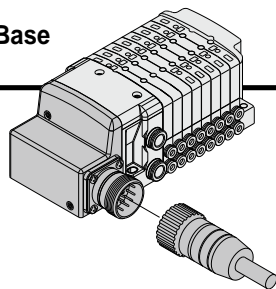

- Simplification and labor savings for wiring work can be achieved by using a circular connector for the electrical connection.

Electrical Wiring Specifications

Circular connector

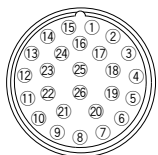

Double wiring (connected to SOL.A and SOL.B) is adopted for the internal wiring of each station, regardless of valve and option types.

Mixed single and double wiring is available as an option. For details, refer to "Special Wiring Specifications" (Option) below.

Terminal no.	Polarity	
SOL.A 1	(-)	(+)
SOL.B 2	(-)	(+)
SOL.A 3	(-)	(+)
SOL.B 4	(-)	(+)
SOL.A 5	(-)	(+)
SOL.B 6	(-)	(+)
SOL.A 7	(-)	(+)
SOL.B 8	(-)	(+)
SOL.A 9	(-)	(+)
SOL.B 10	(-)	(+)
SOL.A 11	(-)	(+)
SOL.B 12	(-)	(+)
SOL.A 13	(-)	(+)
SOL.B 14	(-)	(+)
SOL.A 15	(-)	(+)
SOL.B 16	(-)	(+)
SOL.A 17	(-)	(+)
SOL.B 18	(-)	(+)
SOL.A 19	(-)	(+)
SOL.B 20	(-)	(+)
SOL.A 21	(-)	(+)
SOL.B 22	(-)	(+)
SOL.A 23	(-)	(+)
SOL.B 24	(-)	(+)
COM. 25	(+)	(-)
COM. 26	(+)	(-)

Note) Mounting valve has no polarity. It can also be used as a negative common.

Special Wiring Specifications (Option) [-K]

Mixed single and double wiring are available as an option. The maximum number of manifold stations is determined by the number of solenoids. Count one point for a single solenoid type and two points for a double solenoid type. The total number of solenoids (points) must not exceed 24.

1. How to Order valve

Indicate an option symbol, -K, for the manifold part number and be sure to specify the mounting position and number of stations of the single and double wiring on the manifold specification sheet.

2. Wiring specifications

Connector terminal numbers are connected from solenoid station 1 on the A side in the order indicated by the arrows without skipping any terminal numbers.

Cable Assembly

AXT100-MC26-030
015
050

(Circular connector assembly (26P type) can be included in a specific manifold model number. Refer to "How to Order Manifold.")

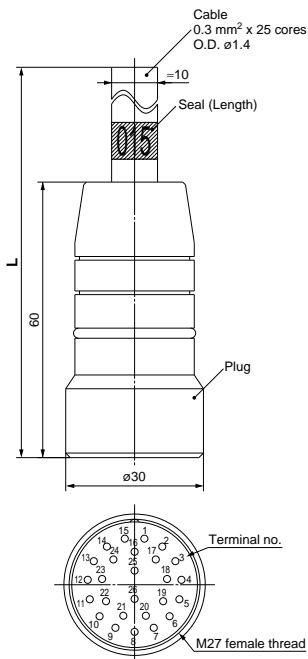

Circular Connector Cable Assembly (Option)

Cable length (L)	Assembly part no.
	26P
1.5 m	AXT100-MC26-015
3 m	AXT100-MC26-030
5 m	AXT100-MC26-050

* Cannot be used for movable wiring.



How to Order Manifold

10-SS0750-08 C4 C8 MD1-B

① ② ③ ④ ⑤

Clean series

① Stations

Symbol	Stations
02	2 stations
⋮	⋮
24 ^{Note)}	24 stations

Note) The maximum number of stations will be different depending on the wiring specifications.

② Cylinder port size

Symbol	Port size	
C2	With ø2 One-touch fitting	Metric
C3	With ø3.2 One-touch fitting	
C4	With ø4 One-touch fitting	
CM	Mixed sizes and with port plug ^{Note)}	
N1	With ø1/8" One-touch fitting	Inch
N3	With ø5/32" One-touch fitting	
NM	Mixed sizes and with port plug ^{Note)}	

Note) Specify "Mixed sizes and with port plug" on the manifold specification sheet.

③ P, R port size

Symbol	Port size	
Nil	With ø8 One-touch fitting ^{Note)}	Metric
C6	With ø6 One-touch fitting	
C8	With ø8 One-touch fitting	Inch
N7	With ø1/4" One-touch fitting	
N9	With ø5/16" One-touch fitting	

Note) The P, R port size is ø5/16" when the cylinder ports are inch sizes.

④ Kit type/Cable length

Kit type	Symbol	Specifications	Standard station	Max. number of stations for special wiring specifications	Max. number of solenoids
M kit	MD0	Circular connector (26P), without cable	1 to 12 stations	24 stations	24
	MD1	Circular connector (26P), with 1.5 m cable			
	MD2	Circular connector (26P), with 3.0 m cable			
	MD3	Circular connector (26P), with 5.0 m cable			

Note) The maximum number of stations is determined by the total number of solenoids. For mixed single and double wirings, enter "K" to the order code options.

Actuation type	Single	Double, Dual 3-port
Number of solenoids	1	2

How to Order Valve

10-S07 1 0 - 5

Clean series

Actuation type

Symbol	Specifications
1	2-position single
2	2-position double
A	4-position dual 3-port (N.C. + N.C.) [Exhaust center]
B	4-position dual 3-port (N.O. + N.O.) [Pressure center]
C	4-position dual 3-port (N.C. + N.O.)

Note) For symbol, refer to page 423.

Base mounted plug-in

Voltage

Symbol	Specifications
5	24 VDC
6	12 VDC

Function

Symbol	Specifications
Nil	Standard
R	External pilot ^{Note)}

Note) Not compatible with dual 3-port valves. The 3(R) port is released to the atmosphere. (Pressurization and vacuum are not allowed.)

⑤ Option

Symbol	Specifications
Nil	None
B ^{Note 2)}	With back pressure check valve (All stations)
D	With DIN rail (Rail length: Standard)
D0	Without DIN rail (With bracket)
D□ ^{Note 3)}	With DIN rail Designated length (□: Station)
K ^{Note 4)}	Special wiring specifications (Except double wiring)
N	With name plate
R ^{Note 5)}	External pilot

Note 1) When two or more options are specified, indicate them alphabetically.

Example) -BKN

Note 2) When installing a back pressure check valve on the required station, enter the part number and specify the station position on the manifold specification sheet.

Note 3) The available number of stations is larger than the number of manifold stations.

Note 4) Indicate the wiring specifications for mixed single and double wirings.

Note 5) For details, refer to page 481.

• For manifold optional parts, refer to pages 481 to 484.

• For manifold exploded view, refer to page 487.

How to Order Manifold Assembly

Specify the part numbers for valves and options together beneath the manifold base part number.

<Example>

Circular connector kit

10-SS0750-08C4MD1...1 set - Manifold base part no.

* 10-S0710-5 3 sets - Valve part no. (Stations 1 to 3)

* 10-S0720-5 2 sets - Valve part no. (Stations 4 to 5)

* 10-S07A0-5 2 sets - Valve part no. (Stations 6 to 7)

* SS0700-10A-1 1 set - Blanking plate part no. (Station 8)

Prefix the asterisk to the part no. of the solenoid valve, etc.

Write sequentially from the 1st station on the D side. When part no. written collectively are complicated, specify on the manifold specification sheet.

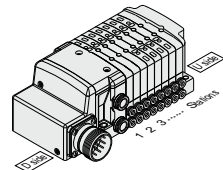

Directional Control Valves

Air Cylinders

Rotary Actuators

Air Grippers

Air Preparation Equipment

Modular F. R.

Pressure Control Equipment

Fittings & Tubing

Flow Control Equipment

Pressure Switches/ Pressure Sensors

M Series 10-S0700 kit (Circular Connector)

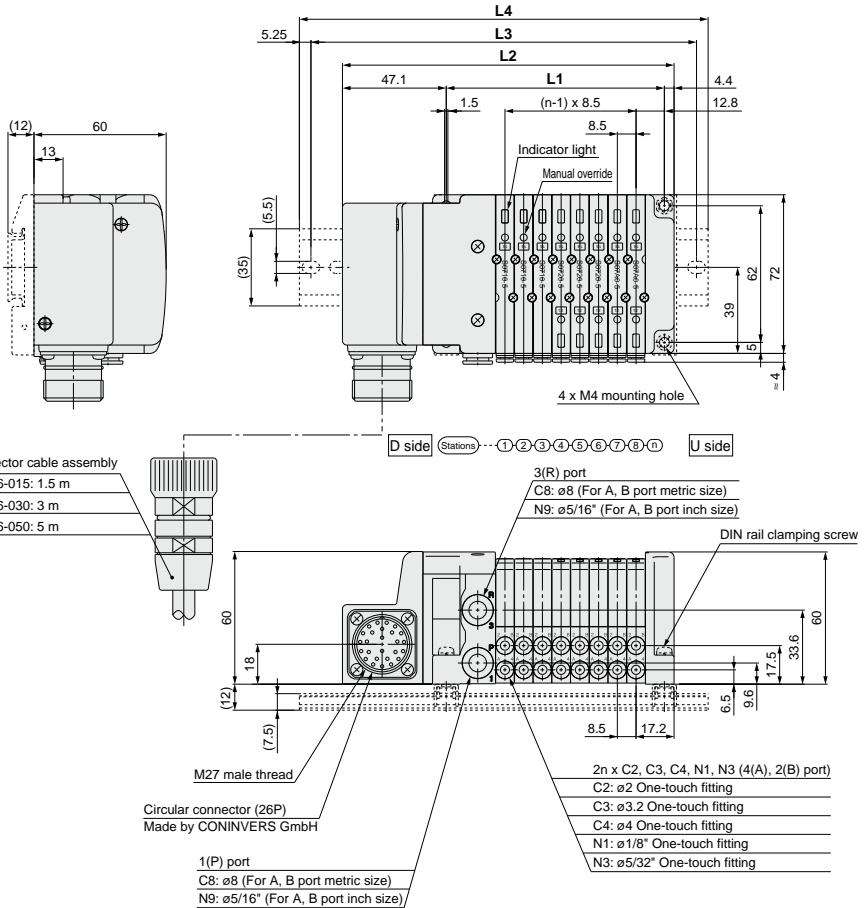

Dimensions

Formula L1 = 8.5n + 31, L2 = 8.5n + 82.5 n: Station (Maximum 24 stations)

L	n	2	3	4	5	6	7	8	9	10	11	12	13	14	15	16	17	18	19	20	21	22	23	24
L1	48	56.5	65	73.5	82	90.5	99	107.5	116	124.5	133	141.5	150	158.5	167	175.5	184	192.5	201	209.5	218	226.5	235	
L2	99.5	108	116.5	125	133.5	142	150.5	159	167.5	176	184.5	193	201.5	210	218.5	227	235.5	244	252.5	261	269.5	278	286.5	
L3	125	137.5	137.5	150	162.5	162.5	175	187.5	187.5	200	212.5	212.5	225	237.5	250	250	262.5	275	275	287.5	300	300	312.5	
L4	135.5	148	148	160.5	173	173	185.5	198	198	210.5	223	223	235.5	248	260.5	260.5	273	285.5	285.5	298	310.5	310.5	323	

Series 10-S0700 Plug-in Manifold Stacking Base

Manifold Optional Parts

Blanking plate

SS0700-10A-1

It is used by attaching on the manifold block for being prepared for removing a valve for maintenance reasons or planning to mount a spare valve, etc.

Weight: 25 g

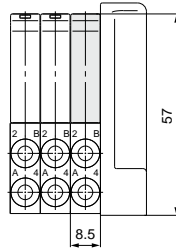
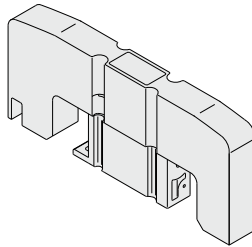

External pilot [-R]

This can be used when the air pressure is 0.1 to 0.2 MPa lower than the minimum operating pressure of the solenoid valves or used for vacuum specifications.

Add R to the part numbers of manifolds and valves to indicate the external pilot specifications.

An M5 port will be installed on the top side of the manifold's SUP/EXH block.

● How to Order Valve (Example)

10-S0710 R -5

↓ External pilot

● How to Order Manifold (Example)

* Indicate R for an option.

10-SS0750-08C4FD1-R

↓ External pilot

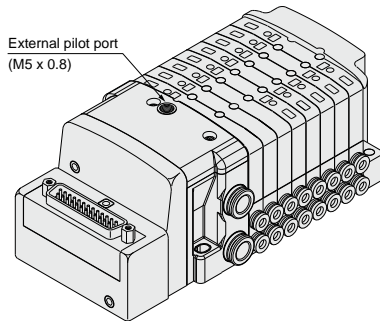

- Note 1) Not compatible with dual 3-port valves.
- Note 2) When the internal pilot type and external pilot type of valves are mixed up on the manifold, order the manifold suitable for the specifications of the external pilot valve.
- Note 3) Since the pilot EXH of valves with the external pilot specification also has a common exhaust specification, the 3(R) port should be released to the atmosphere.

Individual SUP/EXH spacer

SS0700-PR-1

If this spacer is installed instead of a valve, it is possible to add SUP and EXH ports. In this condition, the A port should be an SUP port and the B port an EXH port.

- * Specify the spacer mounting position and SUP/EXH passage shut off positions on the manifold specification sheet.
- * The spacer comes with a SUP block plate and an EXH block plate.
- * Electrical wiring is also connected to the spacer mounting position.

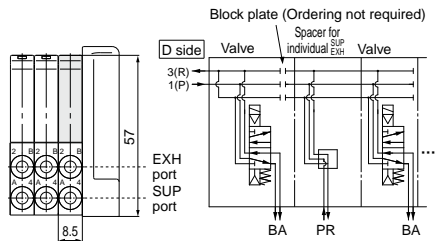
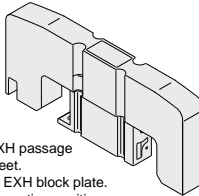

SUP block plate

SS0700-B-P

When different pressures, high and low, are supplied to one manifold, a SUP block plate is inserted between the stations under different pressures.

- * Specify the number of stations on the manifold specification sheet.

<Block indication label>

When using block plates for SUP passage, indication label for confirmation of the blocking position from outside is attached. (One label of each)

- * When ordering a block plate for SUP incorporated with the manifold, a block indication label is attached to the manifold.

Weight: 0.3 g

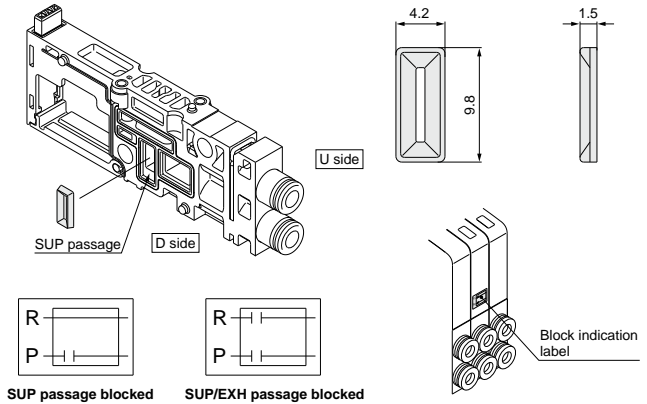

EXH block plate

SS0700-B-R

When valve exhaust affects the other stations on the circuit, insert EXH block plate in between stations to separate valve exhaust.

- * Specify the number of stations on the manifold specification sheet.

<Block indication label>

When using block plates for EXH passage, indication label for confirmation of the blocking position from outside is attached. (One label of each)

- * When ordering a block plate for EXH incorporated with the manifold, a block indication label is attached to the manifold.

Weight: 0.3 g

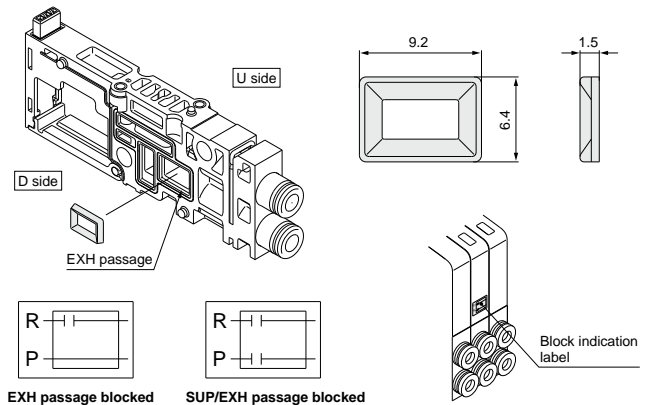

Back pressure check valve [-B]

SS0700-7A-1

It prevents cylinder malfunction caused by other valve exhaust. Insert it into R (EXH) port on the manifold side of a valve which is affected. It is effective when a single action cylinder is used or an exhaust center type solenoid valve is used.

- * When a check valve for back pressure prevention is desired, and is to be installed only in certain manifold stations, clearly write the part number and specify the number of stations on the manifold specification sheet.
- * When ordering this option incorporated with a manifold, suffix "-B" to the end of the manifold part number.

Weight: 0.1 g

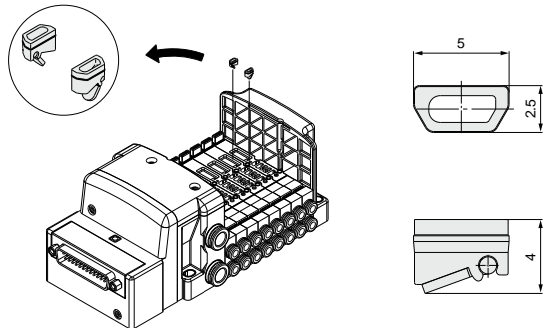

⚠ Precautions

1. The back pressure check valve assembly is assembly parts with a check valve structure. However, as slight air leakage is allowed for the back pressure, take care the exhaust air will not be restricted at the exhaust port.
2. When a back pressure check valve is mounted, the effective area of the valve will decrease by about 20%.

Directional Control Valves
Air Cylinders
Rotary Actuators
Air Grippers
Air Preparation Equipment
Modular F. R.
Pressure Control Equipment
Fittings & Tubing
Flow Control Equipment
Pressure Switches/ Pressure Sensors

Series 10-S0700 Plug-in Manifold Stacking Base

Manifold Optional Parts

Blanking plate with output

SS0700-1C-□

Lead wire length (mm)

Nil	600
10	1000
15	1500
20	2000
25	2500
30	3000

Symbol



Blanking plate with a connector for individually outputting electricity to drive a single valve or equipment that are not on the manifold base.

Note 1) Electric current should be 0.5 A or less.

(Including the mounted valves) When the current is output from two positions at the same time, the current should be 0.25 A or less.

Note 2) Please consult with SMC for the max. allowable current for serial transmission kit.

Weight: 34 g

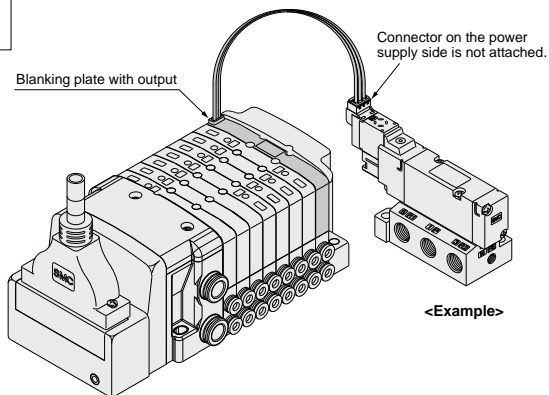

<Example>

Port plug

VVQ0000-CP

The plug is used to block the cylinder port when using a 5-port valve as a 3-port valve.

* When ordering a plug incorporated with a manifold, indicate "CM" for the port size in the manifold part number, as well as, the mounting position and number of stations and cylinder port mounting positions, A and B on the manifold specification sheet.

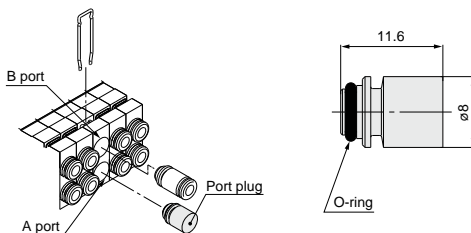

DIN rail mounting bracket

SS0700-57A-□

Symbol	Specifications
Nil	S (EX500), F, P, L M kit
S	S (EX250) kit
T	T kit

It is used for mounting a manifold on a DIN rail. The DIN rail mounted bracket is fixed to the manifold end plate. (The specification is the same as that for the option "-D".)

1 set of DIN rail mounting bracket is included for 1 manifold (2 or 3 DIN rail mounting brackets (S, T kit)).

* When ordering this option incorporated with a manifold, suffix "-D" to the end of the manifold part number.

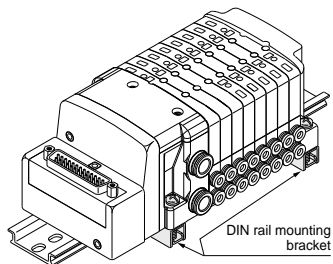

Blanking plug (For One-touch fittings)

KJP-02

23
KQ2P-04
06

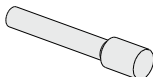

It is inserted into an unused cylinder port and SUP/EXH ports.

Purchasing order is available in units of 10 pieces.

483

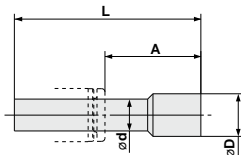

Dimensions

(mm)

Applicable fitting size ad	Model	A	L	D	Weight: g
2	KJP-02	8.2	17	3	0.1
3.2	KQ2P-23	16	31.5	3.2	1
4	KQ2P-04	16	32	6	1
6	KQ2P-06	18	35	8	1

Applicable to DIN rail mounting

Each manifold can be mounted on a DIN rail.
 Order it by indicating a manifold mounting symbol for DIN rail mounting [-D].
 Standard DIN rail which is approx. 30 mm longer than the manifold with the specified number of stations is attached.
 The following options are also available.

● **DIN rail length longer than the standard (for stations to be added later, etc.)**

In the manifold part number, specify -D for the manifold mounting symbol and add the number of required stations after the symbol.

Example) **10-SS0750-08C4FD0-D09K**

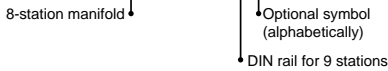

● **How to Order DIN rail only**

DIN rail part number

AXT100-DR-n

Note) For n, enter a number from the No. line in the table below. For L dimension, refer to the dimensions of each kit.

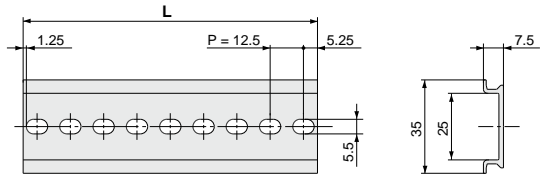

L Dimension

$L = 12.5 \times n + 10.5$

No.	1	2	3	4	5	6	7	8	9	10
L dimension	23	35.5	48	60.5	73	85.5	98	110.5	123	135.5
No.	11	12	13	14	15	16	17	18	19	20
L dimension	148	160.5	173	185.5	198	210.5	223	235.5	248	260.5
No.	21	22	23	24	25	26	27	28	29	30
L dimension	273	285.5	298	310.5	323	335.5	348	360.5	373	385.5
No.	31	32	33	34	35	36	37	38	39	40
L dimension	398	410.5	423	435.5	448	460.5	473	485.5	498	510.5

Name plate [-N]

SS0700-N-Station (1 to max. stations)

It is a transparent resin plate for placing a label that indicates solenoid valve function, etc. Insert it into the groove on the side of the end plate and bend it as shown in the figure.

* When ordering this option incorporated with a manifold, suffix "-N" to the end of the manifold part number.

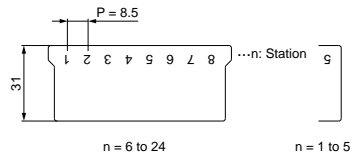
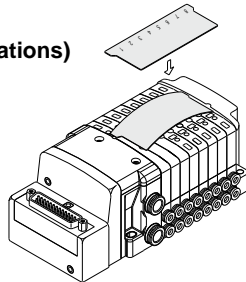

Directional Control Valves

Air Cylinders

Rotary Actuators

Air Grippers

Air Preparation Equipment

Modular F. R.

Pressure Control Equipment

Fittings & Tubing

Flow Control Equipment

Pressure Switches/ Pressure Sensors

Series 10-S0700 Plug-in Manifold Stacking Base Construction

Single: 10-S0710

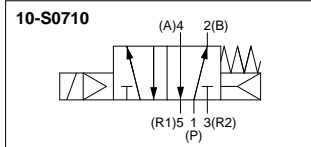
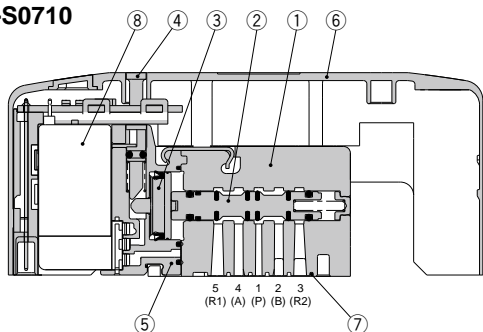

Double: 10-S0720

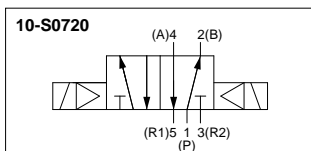
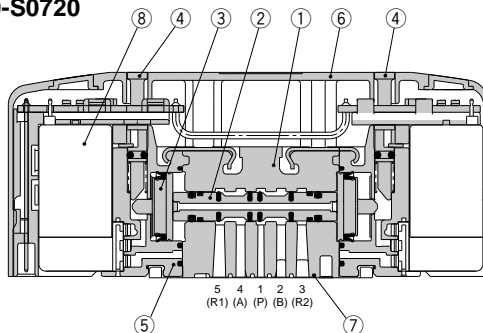

Dual 3-Port: 10-S07B0

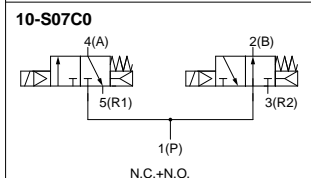
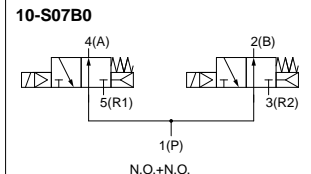
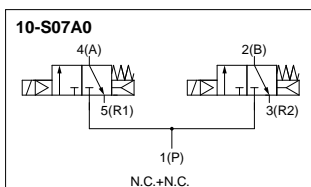
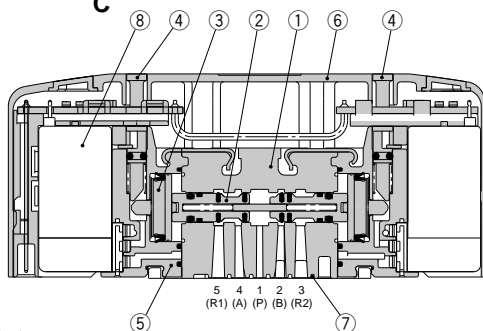

Component Parts

No.	Description	Material
1	Body	Zinc die-casted
2	Spool	Aluminum
3	Piston	Resin
4	Manual override	Resin
5	Adapter plate	Resin
6	Cover	Resin
7	Interface gasket	HNBR
8	Pilot valve assembly ^(Note)	—

Note) Please consult with SMC for pilot valve replacement.

Series 10-S0700/Plug-in Manifold

Manifold Exploded View

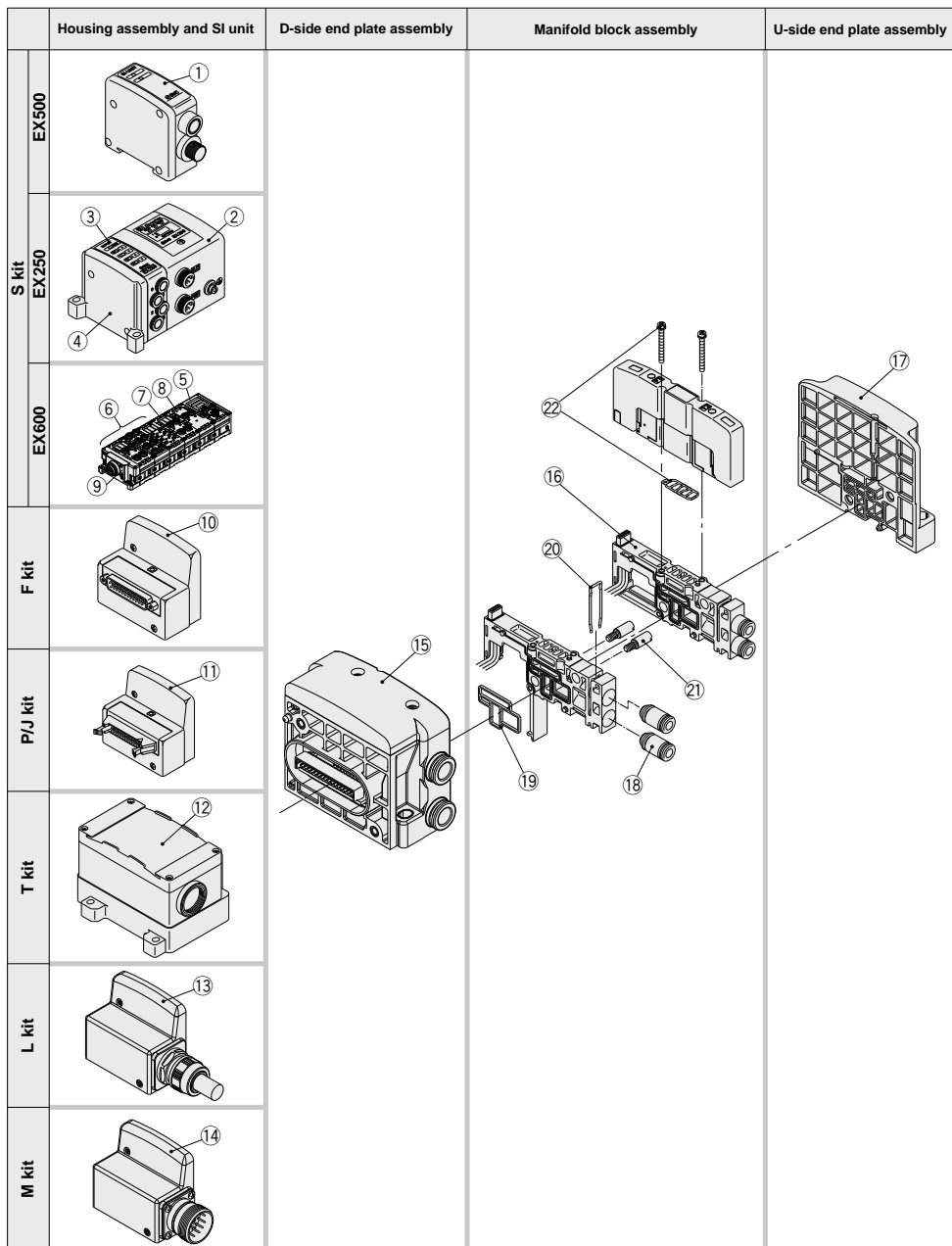

Manifold Assembly Part No.

<Housing Assembly and SI Unit, Input Block>

No.	Description	Part no.	Note
①	SI unit	EX500-Q001	DeviceNet™, PROFIBUS DP, CC-Link, EtherNet/IP™ (+COM.)
		EX500-Q101	DeviceNet™, PROFIBUS DP, CC-Link, EtherNet/IP™ (-COM.)
②	SI unit	EX250-SDN1	DeviceNet™ (-COM.)
		EX250-SPR1	PROFIBUS DP (-COM.)
		EX250-SMJ2	CC-Link (+COM.)
		EX250-SAS3	AS-Interface, 31SLAVE, 8, IN/8, OUT, 2 isolated common type (-COM.)
		EX250-SAS5	AS-Interface, 31SLAVE, 4, IN/4, OUT, 2 isolated common type (-COM.)
		EX250-SAS7	AS-Interface, 31SLAVE, 8, IN/8, OUT, 1 common type (-COM.)
		EX250-SAS9	AS-Interface, 31SLAVE, 4, IN/4, OUT, 1 common type (-COM.)
		EX250-SCA1A	CANopen (-COM.)
③	Input block	EX250-SEN1	EtherNet/IP™
		EX250-IE1	M12, 2 inputs
④	End plate assembly	EX250-IE2	M12, 4 inputs
		EX250-IE3	M8, 4 inputs
		EX250-EA1	Standard
⑤	SI unit	EX250-EA2	DIN rail mounting
		EX600-SDN1	DeviceNet™ PNP (-COM.)
⑥	Digital input unit	EX600-SDN2	DeviceNet™ NPN (+COM.)
		EX600-SMJ1	CC-Link PNP (-COM.)
		EX600-SMJ2	CC-Link NPN (+COM.)
		EX600-SPR1	PROFIBUS DP PNP (-COM.)
		EX600-SPR2	PROFIBUS DP NPN (+COM.)
		EX600-DXNB	NPN input, M12 connector, 5 pins (4 pcs.), 8 inputs
⑦	Digital output unit	EX600-DXPB	PNP input, M12 connector, 5 pins (4 pcs.), 8 inputs
		EX600-DXNC	NPN input, M8 connector, 3 pins (8 pcs.), 8 inputs
		EX600-DXNC1	NPN input, M8 connector, 3 pins (8 pcs.), 8 inputs, with open circuit detection
		EX600-DXPC	PNP input, M8 connector, 3 pins (8 pcs.), 8 inputs
		EX600-DXPC1	PNP input, M8 connector, 3 pins (8 pcs.), 8 inputs, with open circuit detection
		EX600-DXND	NPN input, M12 connector, 5 pins (8 pcs.), 16 inputs
		EX600-DXPD	PNP input, M12 connector, 5 pins (8 pcs.), 16 inputs
		EX600-DYNB	NPN output, M12 connector, 5 pins (4 pcs.), 8 outputs
⑧	Analog input unit	EX600-DYPB	PNP output, M12 connector, 5 pins (4 pcs.), 8 outputs
		EX600-AXA	M12 connector, 5 pins (2 pcs.), 2-channel input
⑨	End plate	EX600-ED2	M12 connector, 5 pins, Max. supply current 2 A
		EX600-ED2-2	M12 connector, 5 pins, Max. supply current 2 A, with DIN rail mounting bracket
		EX600-ED3	7/8 inch connector, 5 pins, Max. supply current 8 A
		EX600-ED3-2	7/8 inch connector, 5 pins, Max. supply current 8 A, with DIN rail mounting bracket
⑩	D-sub connector housing assembly	VVQC1000-F25-1	F kit, 25 pins
⑪	Flat ribbon cable housing assembly	VVQC1000-P26-1	P kit, 26 pins
		VVQC1000-P20-1	P kit, 20 pins
⑫	Flat ribbon cable housing assembly Flat ribbon cable PC wiring system compatible	VVQC1000-J20-1	J kit, 20 pins
		VVQC1000-T0-1	T kit
⑬	Terminal block box housing assembly	VVQC1000-L25-0-1	L kit with 0.6 m lead wire
		VVQC1000-L25-1-1	L kit with 1.5 m lead wire
		VVQC1000-L25-2-1	L kit with 3.0 m lead wire
⑭	Circular connector housing assembly	VVQC1000-M26-1	M kit, 26 pins

Directional Control Valves
 Air Cylinders
 Rotary Actuators
 Air Grippers
 Air Preparation Equipment
 Modular F. R.
 Pressure Control Equipment
 Fittings & Tubing
 Flow Control Equipment
 Pressure Switches/ Pressure Sensors

Manifold Assembly Part No.

⑮ D-side end plate assembly

SS0700-3A-1-**C8** - 

Port size

Symbol	Port size
C8	With ø8 One-touch fitting
N9	With ø5/16" One-touch fitting

Option

Symbol	Specifications
Nil	Common EXH
R	External pilot
S	Direct EXH outlet with built-in silencer

Note) When both options are specified, indicate as "-RS".

⑰ U-side end plate assembly

SS0700-2A-2

⑱ Fitting assembly

VVQ000-50A-

Port size

Symbol	Applicable tubing
C2	Applicable tubing ø2
C3	Applicable tubing ø3
C4	Applicable tubing ø4
N1	Applicable tubing ø1/8"
N3	Applicable tubing ø5/32"

Note 1) Purchasing order is available in units of 10 pieces.

Note 2) For One-touch fittings replacement, refer to the Specific Product Precautions.

⑳ Manifold block assembly

SS0700-1A-**PD** **05** - **C3** - 

Wiring specifications

Symbol	Specifications
PD	Double wiring
PS	Single wiring
P0	None

Stations

Symbol	Stations
02	2 stations
:	:
24	24 stations

Option

Symbol	Specifications
Nil	None
B	With back pressure check valve

Port size

Symbol	Port size
C2	With ø2 One-touch fitting
C3	With ø3.2 One-touch fitting
C4	With ø4 One-touch fitting
N1	With ø1/8" One-touch fitting
N3	With ø5/32" One-touch fitting
C0	Without One-touch fitting

<Replacement Parts for Manifold Block>

Replacement Parts

No.	Description	Part no.	Qty.
⑲	Gasket	SS0700-80A-2 ¹⁰ (Note 1)	
20	Clip	SS0700-80A-4 ¹⁰ (Note 1)	
⑳	Tie-rod assembly	SS0700-TR-□ ² (Note 2)	

Note 1) 1 set includes 10 pieces.

Note 2) 1 set includes 2 pieces. Please order when eliminating manifold stations. When adding stations, tie-rods are attached to the manifold block assembly. Therefore, it is not necessary to order.
□: Stations 02 to 24

<Replacement Parts for Valve>

Replacement Parts

No.	Description	Part no.	Qty.
㉒	Gasket, Screw	S0700-GS-5	10

Note) Above part number consists of 10 units.
Each unit has one gasket and two screws.

How to Add Manifold Stations (Plug-in Type / Lead Wire Connection Type)

What to order

- Manifold block assembly (Refer to the above ⑳)

Steps for adding stations

- Loosen hexagon bolts from the end plate at the U-side and remove the end plate.
- Connect the tie-rod for increasing the station number, open the junction cover, mount the manifold block assembly and U-side end plate and tighten them by hexagon bolts.
(Tightening torque: 0.85 to 0.95 N·m)

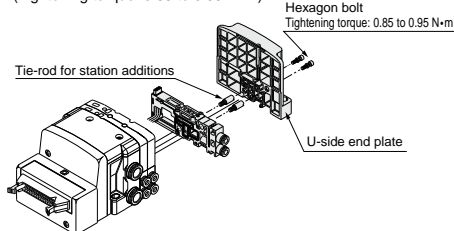

- Connect the round type terminal of red lead wire to the common terminal inside the junction cover.

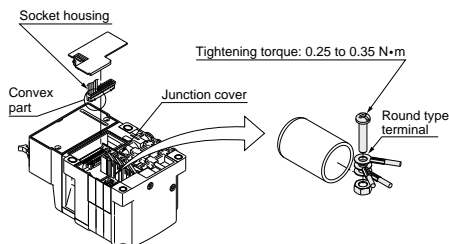

- Take out the socket housing and connect the black and white lead wires. The connection layout is common to all kits.

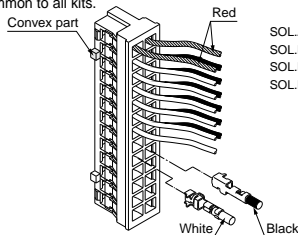

		Terminal no.			
COM.	Red ---1A		1B ---Red	COM.	
SOLA Station 2	Black ---2A		2B ---Black	Station 1	SOLA
SOLB Station 3	White ---3A		3B ---Black	Station 3	SOLA
SOLB Station 4	White ---4A		4B ---Black	Station 4	SOLA
SOLB Station 5	White ---5A		5B ---Black	Station 5	SOLA
	6A		6B ---Black	Station 6	SOLA
	7A				
	8A				
	9A				
	10A				
	11A				
	12A				
	13A				

Plug Lead Manifold Bar Base

Connector

C kit

Plug-in Manifold
Bar Base

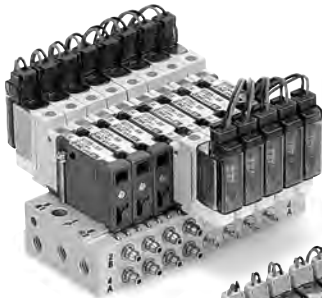

With barb fittings

Individual
Connector

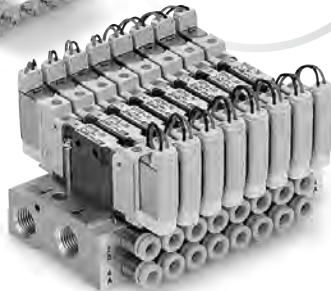

With One-touch fittings



Page 491

Directional
Control Valves

Air Cylinders

Rotary Actuators

Air Grippers

Air Preparation
Equipment

Modular F. R.

Pressure Control
Equipment

Fittings & Tubing

Flow Control
Equipment

Pressure Switches/
Pressure Sensors



Series 10-S0700 Plug Lead Manifold Bar Base kit (Connector)

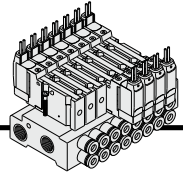

How to Order Manifold

10-SS0755-08C4 C -

Clean series

Plug lead

Stations

Symbol	Stations
02	2 stations
⋮	⋮
20	20 stations

Cylinder port size

Symbol	Port size	Manifold pitch
M5	M5 thread	Metric
C2	With ø2 One-touch fitting	
C3	With ø3.2 One-touch fitting	
C4	With ø4 One-touch fitting	
CM	Mixed sizes and with port plug <small>Note)</small>	8.5
N1	With ø1/8" One-touch fitting	
N3	With ø5/32" One-touch fitting	
NM	Mixed sizes and with port plug <small>Note)</small>	
		Inch

Note) Specify "Mixed sizes and with port plug" on the manifold specification sheet.
* The manifold pitch 7.5 mm type is available as special order.

Option

Symbol	Specifications
Nil	None
R <small>Note)</small>	External pilot

Note) For details, refer to page 497.
* For manifold optional parts, refer to pages 497 to 498.

Connector kit

P, R port thread type

Symbol	Manifold pitch	
	8.5	7.5
Nil	Rc (PT)	M5
F	G (PF)	/
N	NPT	
T	NPTF	

How to Order Valve

10-S07155-5G

Clean series

Actuation type

Symbol	Specifications
1	2-position single
2	2-position double
A	4-position dual 3-port (N.C. + N.C.) [exhaust center]
B	4-position dual 3-port (N.O. + N.O.) [pressure center]
C	4-position dual 3-port (N.C. + N.O.)

Note) For symbol, refer to page 423.

Base mounted plug lead

Electrical entry

Symbol	Specifications
G	Grommet
M	Plug connector, with lead wire (Light/surge voltage suppressor)
MO	Plug connector, without lead wire (Light/surge voltage suppressor)

Voltage

Symbol	Specifications
5	24 VDC
6	12 VDC

Function

Symbol	Specifications
Nil	Standard
R	External pilot <small>Note)</small>

Note) Not compatible with dual 3-port valves.
The 3(R) port is released to the atmosphere.
(Pressurization and vacuum are not allowed.)

How to Order Manifold Assembly

Specify the part numbers for valves and options together beneath the manifold base part number.

<Example>
Connector kit

10-SS0755-07C4C... 1 set - Manifold base part no.
= 10-S0715-5G..... 3 sets - Valve part no. (Stations 1 to 3)
= 10-S0725-5G..... 2 sets - Valve part no. (Stations 4 to 5)
= 10-S07A5-5G..... 2 sets - Valve part no. (Stations 6 to 7)

Prefix the asterisk to the part no. of the solenoid valve, etc.

Write sequentially from the 1st station on the D side. When part no. written collectively are complicated, specify on the manifold specification sheet.

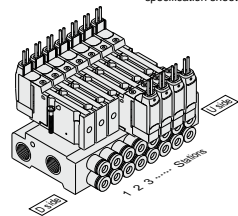

10-SS0755-□ M5
 □ C □
 □ N □

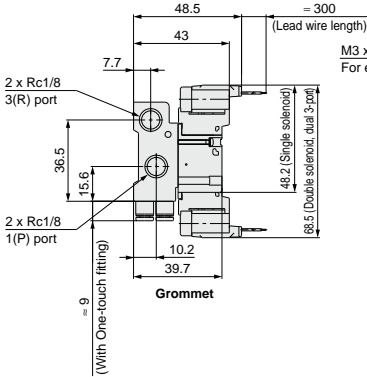

M3 x 0.5 external pilot port
 For external pilot specifications

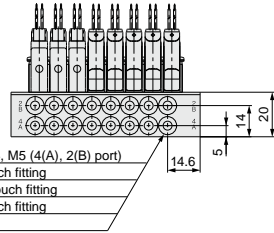
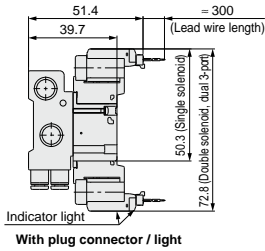
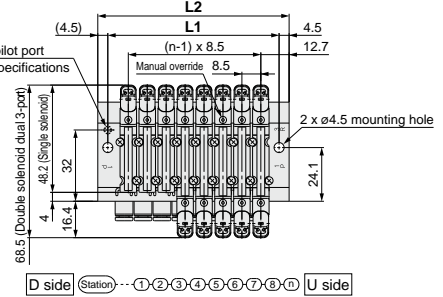

Dimensions

Formula L1 = 8.5n + 8.9, L2 = 8.5n + 17.9 n: Station (Maximum 20 stations)

L \ n	2	3	4	5	6	7	8	9	10	11	12	13	14	15	16	17	18	19	20
L1	25.9	34.4	42.9	51.4	59.9	68.4	76.9	85.4	93.9	102.4	110.9	119.4	127.9	136.4	144.9	153.4	161.9	170.4	178.9
L2	34.9	43.4	51.9	60.4	68.9	77.4	85.9	94.4	102.9	111.4	119.9	128.4	136.9	145.4	153.9	162.4	170.9	179.4	187.9

Directional Control Valves

Air Cylinders

Rotary Actuators

Air Grippers

Air Preparation Equipment

Modular F. R.

Pressure Control Equipment

Fittings & Tubing

Flow Control Equipment

Pressure Switches/ Pressure Sensors

Plug Lead Manifold Bar Base

Serial Transmission

S kit

Plug Lead Manifold
Bar Base

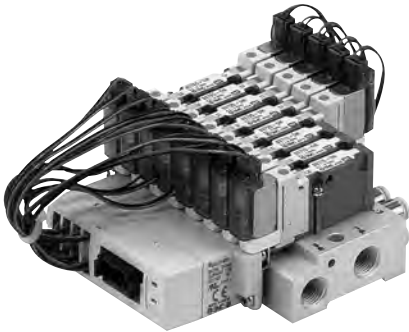

Gateway-type
Serial Transmission
System

EX510

Connect all wiring
using connectors.

Page 495



Directional
Control Valves

Air Cylinders

Rotary Actuators

Air Grippers

Air Preparation
Equipment

Modular F. R.

Pressure Control
Equipment

Fittings & Tubing

Flow Control
Equipment

Pressure Switches/
Pressure Sensors



Series 10-S0700 Plug Lead Manifold Bar Base kit (Serial Transmission) EX510 Gateway-type Serial Transmission System

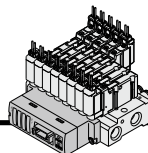

How to Order Manifold

10-SS0755-SA [] 08 C4 [] - []

Clean series

S kit
EX510 serial wiring

SI unit COM.

Nil	+COM.
N	-COM.

Stations

Symbol	Stations
02	2 stations
:	:
16	16 stations

Note) The maximum number of stations is determined by the total number of solenoids. For mixed single and double wirings, enter "K" to the order code options.

Standard station	Max. number of stations for special wiring specifications	Max. number of solenoids
1 to 8 stations	16 stations	16

Actuation type	Single	Double, Dual 3-port
Number of solenoids	1	2

Refer to the **WEB catalog** for details on the EX510 Gateway-type Serial Transmission System.

Option

Symbol	Specifications
Nil	None
K ^{Note 2)}	Special wiring specifications (Except double wiring)
R ^{Note 3)}	External pilot

Note 1) When two or more options are specified, indicate them alphabetically. Example) -KR
Note 2) Indicate the wiring specifications for mixed single and double wirings.
Note 3) For details, refer to page 497.

* For manifold optional parts, refer to pages 497 to 498.

P, R port thread type

Symbol	Manifold pitch
Nil	8.5
N	Rc (PT)
F	G (PF)
N	NPT
T	NPTF

Cylinder port size

Symbol	Port size	
M5	M5 thread	Metric
C2	With ø2 One-touch fitting	
C3	With ø3.2 One-touch fitting	
C4	With ø4 One-touch fitting	
CM	Mixed sizes and with port plug ^{Note)}	Inch
N1	With ø1/8" One-touch fitting	
N3	With ø5/32" One-touch fitting	
NM	Mixed sizes and with port plug ^{Note)}	

Note) Specify "Mixed sizes and with port plug" on the manifold specification sheet.

How to Order Valve

10-S07 1 5 [] - 5 MO

Clean series

Actuation type

Symbol	Specifications
1	2-position single
2	2-position double
A	4-position dual 3-port (N.C. + N.C.) [Exhaust center]
B	4-position dual 3-port (N.O. + N.O.) [Pressure center]
C	4-position dual 3-port (N.C. + N.O.)

Note) For symbol, refer to page 423

Electrical entry

M-type plug connector, without lead wire (Light/surge voltage suppressor)

Voltage: 24 VDC

Function

Symbol	Specifications
Nil	Standard
R	External pilot ^{Note)}

Note) Not compatible with dual 3-port valves. The 3(R) port is released to the atmosphere. (Pressurization and vacuum are not allowed.)

Base mounted plug lead

How to Order Manifold Assembly

Specify the part numbers for valves and options together beneath the manifold base part number.

<Example>

Serial transmission kit

10-SS0755-SA08C4... 1 set - Manifold base part no.

≒ 10-S0715-5MO 3 sets - Valve part no. (Stations 1 to 3)

≒ 10-S0725-5MO 3 sets - Valve part no. (Stations 4 to 6)

≒ 10-S07A5-5MO 2 sets - Valve part no. (Stations 7 to 8)

Write sequentially from the 1st station on the D side. When part no. written collectively are complicated, specify on the manifold specification sheet.

The connector assembly lead wire length used for EX510 manifold varies depending on the number of stations.

Therefore, solenoid valves (including a blanking plate) and connector assembly are assembled when shipped as a standard specification. Please specify the mounting solenoid valve when ordering.

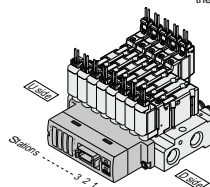

10-SS0755
S kit (Serial transmission: EX510)

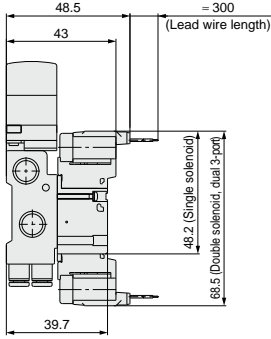

Grommet

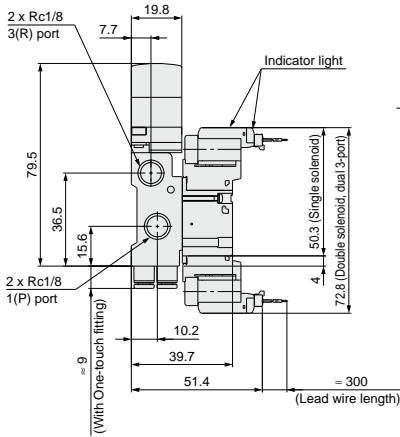

With plug connector / light

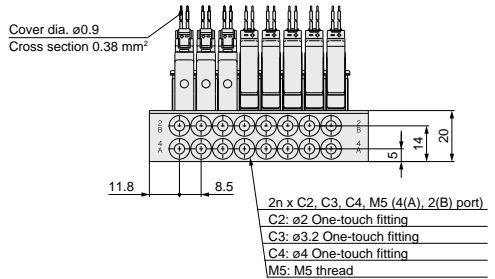
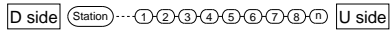
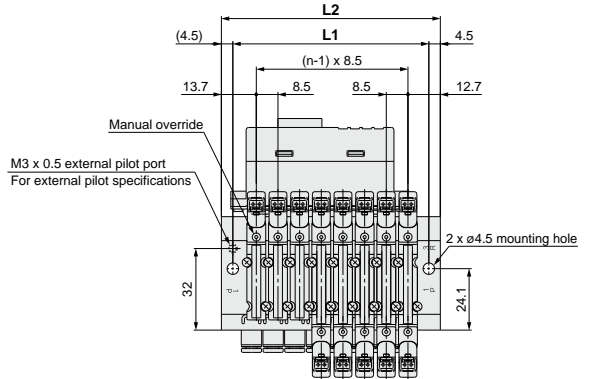
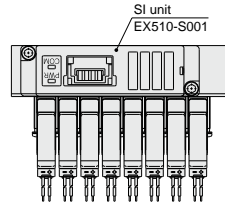

Dimensions

L	n	2	3	4	5	6	7	8	9	10	11	12	13	14	15	16
L1		68.4	68.4	68.4	68.4	68.4	68.4	76.9	85.4	93.9	102.4	110.9	119.4	127.9	136.4	144.9
L2		77.4	77.4	77.4	77.4	77.4	77.4	85.9	94.4	102.9	111.4	119.9	128.4	136.9	145.4	153.9

Directional Control Valves
Air Cylinders
Rotary Actuators
Air Grippers
Air Preparation Equipment
Modular F. R.
Pressure Control Equipment
Fittings & Tubing
Flow Control Equipment
Pressure Switches/
Pressure Sensors

Series 10-S0700 Plug Lead Manifold Bar Base

Manifold Optional Parts

Blanking plate assembly

SS0700-10A-5

It is used by attaching on the manifold block for being prepared for removing a valve for maintenance reasons or planning to mount a spare valve, etc.

Weight: 21 g

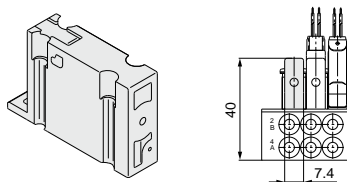

Individual SUP spacer

SS0700-P-5-M5

Port size

M5 M5 thread

Mounted on the manifold block to make an independent supply port when each solenoid valve uses different operating pressure.

Weight: 7 g

* Compatible with 8.5 mm pitch manifold only.

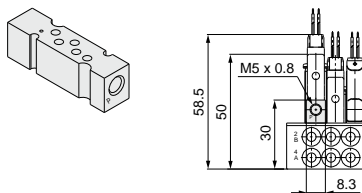

Individual EXH spacer

SS0700-R-5-M5

Port size

M5 M5 thread

Mounted on the manifold block to make an independent exhaust port when the exhaust from one valve affects valves on other stations in the air circuit.

Weight: 7 g

* Compatible with 8.5 mm pitch manifold only.

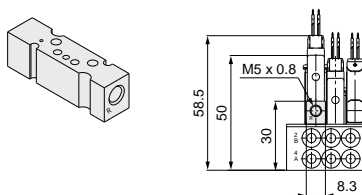

Port plug

VVQ000-CP

The plug is used to block the cylinder port when using a 5-port valve as a 3-port valve.

* When ordering a plug incorporated with a manifold, indicate "CM" for the port size in the manifold no., as well as, the mounting position and number of stations and cylinder port mounting positions, A and B, on the manifold specification sheet.

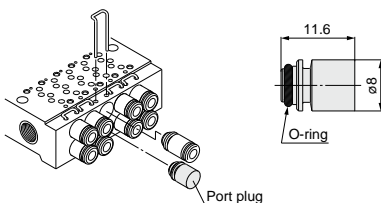

External pilot [-R]

This can be used when the air pressure is 0.1 to 0.2 MPa lower than the minimum operating pressure of the solenoid valves or used for vacuum specifications.

Add R to the part numbers of manifolds and valves to indicate the external pilot specifications.

An M5 port will be installed on the top side of the manifold's SUP/EXH block.

● How to Order Valve (Example)

10-S0715 R -5G

External pilot

● How to Order Manifold (Example)

* Indicate -R for an option.

10-SS0755-08C4C-R

External pilot

External pilot port
(M3 x 0.5)

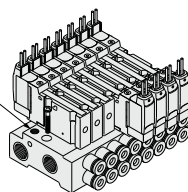

Note 1) The dual 3-port valve is not available.

Note 2) When the internal pilot type and external pilot type of valves are mixed up on the manifold, order the manifold suitable for the specifications of the external pilot valve.

Note 3) Since the pilot EXH of valves with the external pilot specification also has a common exhaust specification, the 3(R) port should be released to the atmosphere.

Blanking plug (For One-touch fittings)

KJP-02

23

KQ2P-04

06

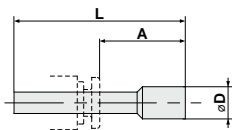
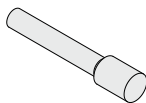

Dimensions

Applicable fitting size $\varnothing d$	Model	A	L	D	Weight (g)
2	KJP-02	8.2	17	3	0.1
3.2	KQ2P-23	16	31.5	3.2	1
4	KQ2P-04	16	32	6	1
6	KQ2P-06	18	35	8	1

Directional Control Valves

Air Cylinders

Rotary Actuators

Air Grippers

Air Preparation Equipment

Modular F. R.

Pressure Control Equipment

Fittings & Tubing

Flow Control Equipment

Pressure Switches/ Pressure Sensors

Series 10-S0700

5 Port Solenoid Valve:
Base Mounted
Plug Lead, Single Unit



How to Order Valve

10-S07 1 5 □ - 5 G - M5

Clean series

Actuation type

Symbol	Specifications
1	2-position single
2	2-position double
A	4-position dual 3-port (N.C. + N.C.) [Exhaust center]
B	4-position dual 3-port (N.O. + N.O.) [Pressure center]
C	4-position dual 3-port (N.C. + N.O.)

Note) For symbol, refer to page 423.

Plug lead

Function

Symbol	Specifications
Nil	Standard
R	External pilot ^{Note)}

Note) Not compatible with dual 3-port valves.

Sub-plate

Symbol	Specifications
Nil	Without sub-plate
M5	With sub-plate

Electrical entry

Symbol	Specifications	Configuration
G	Grommet	
M	M-type plug connector, with lead wire (With light/surge voltage suppressor)	
MO	M-type plug connector, without lead wire (With light/surge voltage suppressor)	

Voltage

Symbol	Specifications
5	24 VDC
6	12 VDC

Dimensions

2-Position Single Grommet (G): 10-S0715(R)-□G-M5

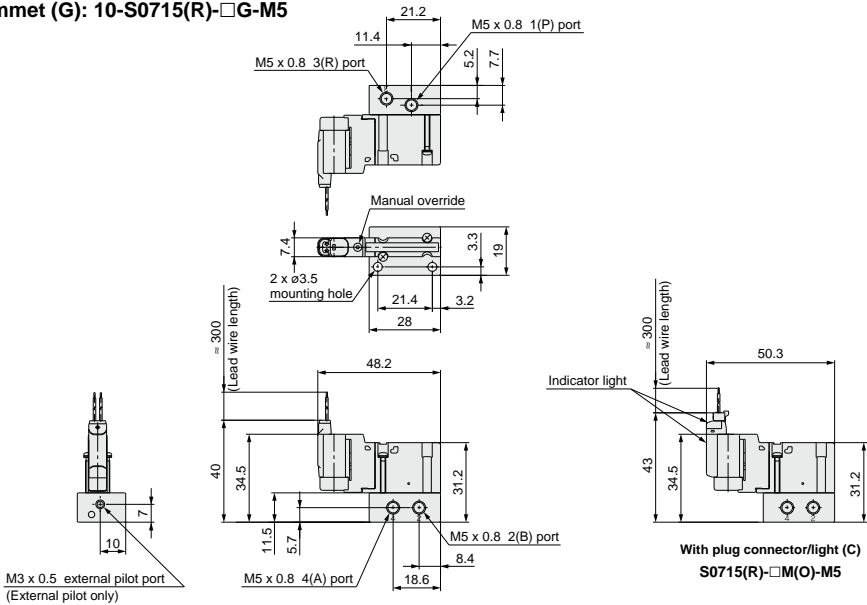

2-Position Double/4-Position Dual 3-Port Grommet (G): 10-S0745(R)-□G-M5

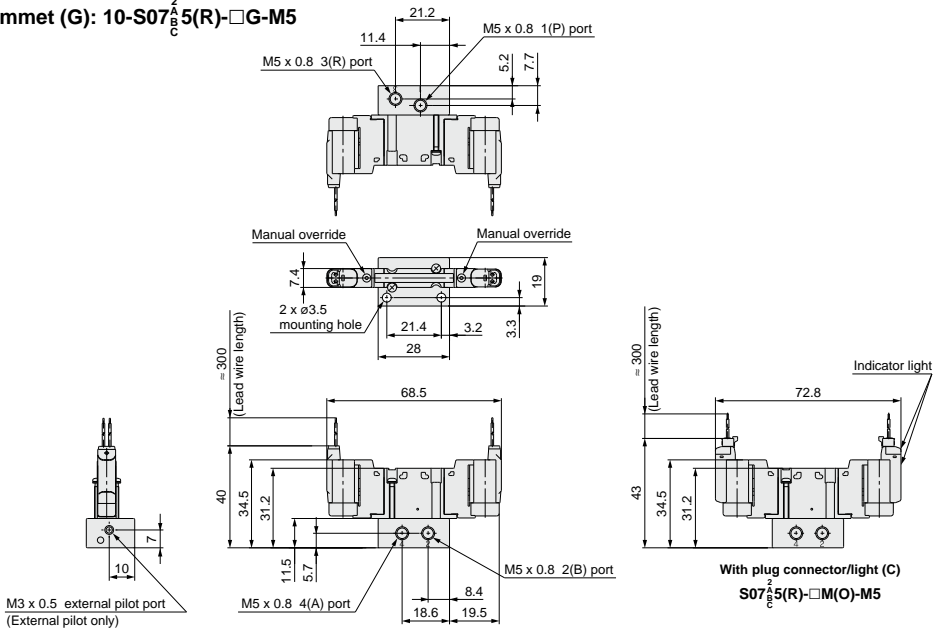

Directional Control Valves
Air Cylinders
Rotary Actuators
Air Grippers
Air Preparation Equipment
Modular F. R.
Pressure Control Equipment
Fittings & Tubing
Flow Control Equipment
Pressure Switches/ Pressure Sensors

Series 10-S0700 Plug Lead Single Unit

Construction: Main Parts/Replacement Parts

2-Position Single

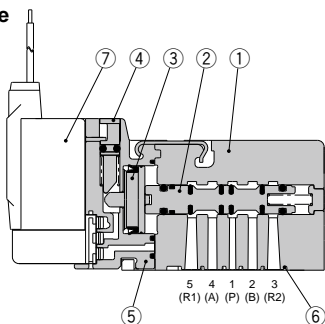

S0715

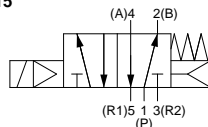

2-Position Double

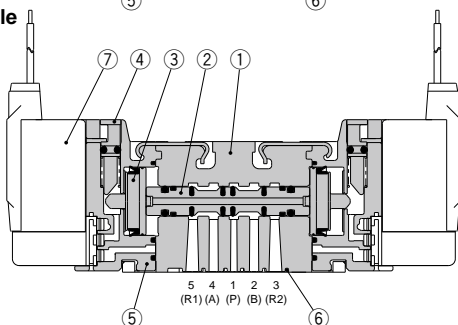

S0725

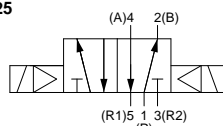

4-Position Dual 3-Port Valve

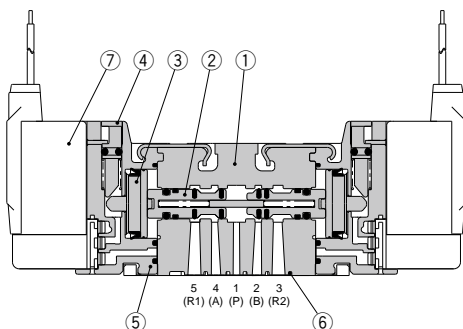

S07A5

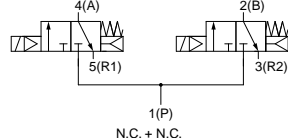

S07B5

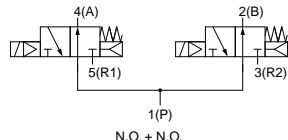

S07C5

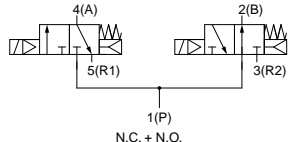

<Pilot Valve Assembly Part No.>

S070P - 5 B G -1

Voltage

Symbol	Specifications
5	24 VDC
6	12 VDC

Accessory

Symbol	Specifications
Nil	None
-1	Stopper plate is included.

Electrical entry

Symbol	Specifications
G	Grommet
C	Plug connector, with lead wire (With light/surge voltage suppressor)
CO	Plug connector, without lead wire (With light/surge voltage suppressor)

(Note) For pilot valve assembly replacement, refer to the Specific Product Precautions 3.

Component Parts

No.	Description	Material
1	Body	Zinc die-casted
2	Spool	Aluminum
3	Piston	Resin
4	Manual override	Resin
5	Adapter plate	Resin
6	Interface gasket	HNBR

Replacement Parts

No.	Description	Material
7	Pilot valve assembly	—

(Note) For pilot valve assembly replacement, refer to the Specific Product Precautions 3.

Series 10-S0700 Plug Lead Replacement Parts

<One-touch Fitting Assembly (For Cylinder Port)>

Manifold pitch	Port size	Part no.
8.5	ø2 One-touch fitting	VVQ0000-50A-C2
	ø3.2 One-touch fitting	VVQ0000-50A-C3
	ø4 One-touch fitting	VVQ0000-50A-C4
	ø1/8" One-touch fitting	VVQ0000-50A-N1
	ø5/32" One-touch fitting	VVQ0000-50A-N3
7.5	ø2 barb fitting	SS070-50A-20
	ø3.2 barb fitting	SS070-50A-32
	ø4 barb fitting	SS070-50A-40

Note) Purchase orders are available in units of 10 pieces.

<Plug Connector Assembly>

S070-14A-□

Lead wire length

Symbol	Length
Nil	150 mm
3	300 mm
6	600 mm
10	1000 mm

Note) Standard wire length of valve with plug connector is 300 mm. When ordering a lead wire length of 600 mm or longer, list the part numbers for the valve without connector and the connector assembly.

<Pilot Valve Assembly>

10-S070P-5 B G -1

Voltage

Symbol	Specifications
5	24 VDC
6	12 VDC

Accessory

Symbol	Specifications
Nil	None
-1	Stopper plate is included.

Electrical entry

Symbol	Specifications
G	Grommet
C	Plug connector, with lead wire (With light/surge voltage suppressor)
CO	Plug connector, without lead wire (With light/surge voltage suppressor)

Note) For pilot valve assembly replacement, refer to the Specific Product Precautions 3.

<Gasket, Screw Assembly>

Part no.
S0700-GS-5

Note) Above part number consists of 10 units.
Each unit has one gasket and two screws.

<Sub-plate>

Part no.
S0700-S-M5

<SI Unit (Series EX510)>

EX510-S 0 01

Output specifications

0	NPN output (+COM.)
1	PNP output (-COM.)

Directional
Control Valves

Air Cylinders

Rotary Actuators

Air Grippers

Air Preparation
Equipment

Modular F. R.

Pressure Control
Equipment

Fittings & Tubing

Flow Control
Equipment

Pressure Switches/
Pressure Sensors



Series 10-S0700

Specific Product Precautions 1

Be sure to read this before handling.

Refer to page 1382 for Safety Instructions and pages 677 to 683 for 3/4/5 Port Solenoid Valve Precautions.

Manual Override

Warning

The manual override is used for switching the main valve.

Push type (Tool required)

Push down on the manual override button with a small screwdriver until it stops.

Plug-in

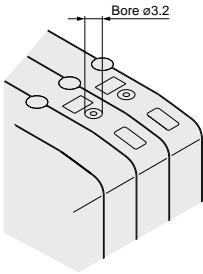

Plug lead

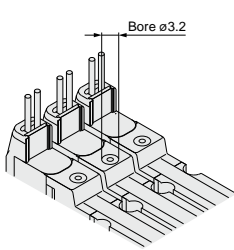

How to Attach/Detach Plug Connector

<Plug lead type only>

To attach a connector, hold the lever and connector unit between your fingers and insert straight onto the pins of the solenoid valve so that the lever's pawl is pushed into the groove and locks.

To detach a connector, remove the pawl from the groove by pushing the lever downward with your thumb, and pull the connector straight out.

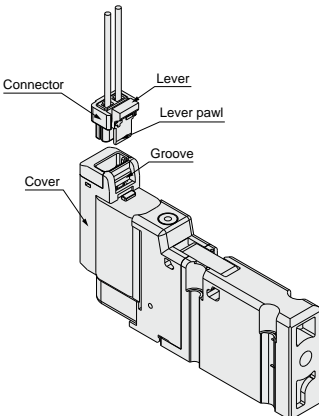

(Note) In order not to damage the connector and cover, do not pull the lead wire excessively (with a force of 10 N or more).

How to Mount Valve

Caution

Tighten the bolts firmly to stop the gasket from coming away from the valve using the appropriate torque as shown on the following table.

Proper tightening torque N·m

0.17 to 0.23

Plug-in

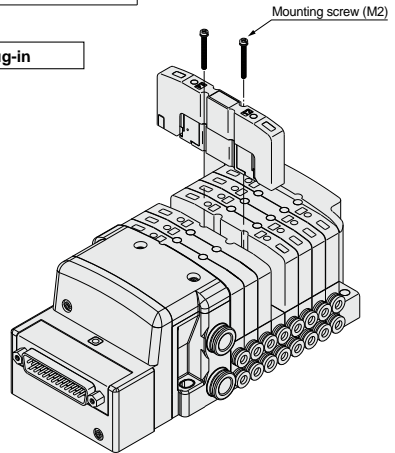

Plug lead

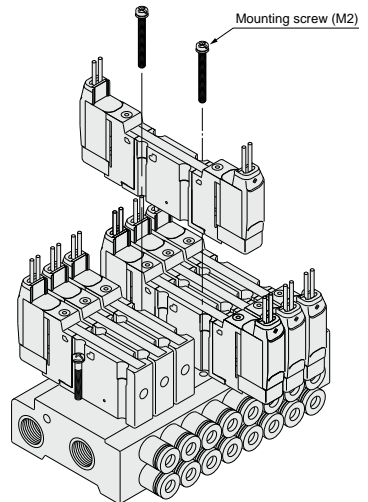



Series 10-S0700

Specific Product Precautions 2

Be sure to read this before handling.

Refer to page 1382 for Safety Instructions and pages 677 to 683 for 3/4/5 Port Solenoid Valve Precautions.

How to Mount/Remove DIN Rail

⚠ Caution

Plug-in

Removal

- 1) Loosen the clamping screw of the end plate on both sides.
- 2) Lift side (a) of the manifold base and slide the end plate in the direction of ② shown in the figure to remove.

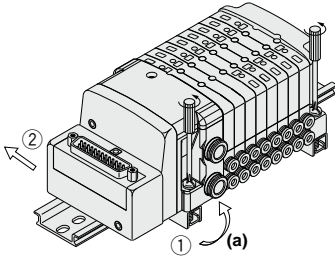

Mounting

- 1) Hook side (b) of the manifold base on the DIN rail.
- 2) Press down side (a) and mount the end plate on the DIN rail. Tighten the clamping screw on side (a) of the end plate. The proper tightening torque for screws is 0.4 to 0.6 N·m.

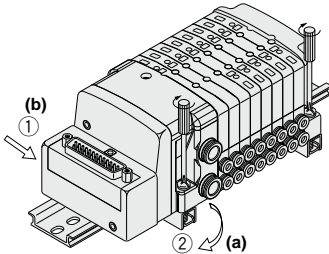

How to Change Connector Entry Direction

⚠ Caution

<Plug-in manifold stacking base>

The connector entry direction can be changed from the top to the side by simply pressing the manual release button.

It is not necessary to use the manual release button when switching from the side to the top.

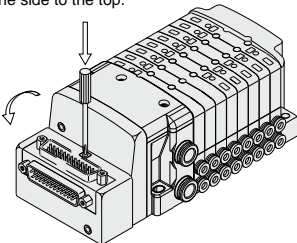

How to Replace Cylinder Port Fittings

⚠ Warning

The cylinder port fittings are a cassette for easy replacement. The fittings are blocked by a clip inserted from the top of the valve.

Remove the clip with a flat blade screwdriver to remove fittings. For replacement, insert the fitting assembly until it strikes against the inside wall and then re-insert the clip to the specified position.

Plug-in

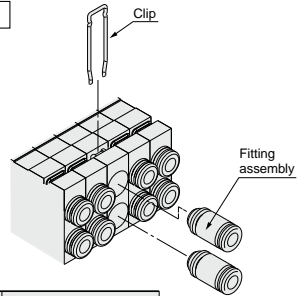

Applicable tubing O.D.	One-touch fitting part no.
Applicable tubing ø2	VVQ0000-50A-C2
Applicable tubing ø3.2	VVQ0000-50A-C3
Applicable tubing ø4	VVQ0000-50A-C4
Applicable tubing ø1/8"	VVQ0000-50A-N1
Applicable tubing ø5/32"	VVQ0000-50A-N3

- * Part number is for one fitting assembly.
- * Please order it in units of 10 pieces.

Plug lead

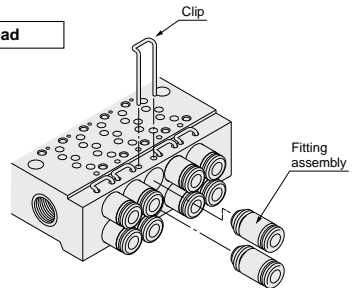

	Applicable tubing O.D.	Fitting part no.
8.5 mm pitch (One-touch fitting)	Applicable tubing ø2	VVQ0000-50A-C2
	Applicable tubing ø3.2	VVQ0000-50A-C3
	Applicable tubing ø4	VVQ0000-50A-C4
	Applicable tubing ø1/8"	VVQ0000-50A-N1
	Applicable tubing ø5/32"	VVQ0000-50A-N3
7.5 mm pitch (Barb fitting)	Barb fitting ø2	SS070-50A-20
	Barb fitting ø3.2	SS070-50A-32
	Barb fitting ø4	SS070-50A-40

- * Part number is for one fitting assembly.
- * Please order it in units of 10 pieces.

Directional Control Valves

Air Cylinders

Rotary Actuators

Air Grippers

Air Preparation Equipment

Modular F. R.

Pressure Control Equipment

Fittings & Tubing

Flow Control Equipment

Pressure Switches/ Pressure Sensors



Series 10-S0700

Specific Product Precautions 3

Be sure to read this before handling.

Refer to page 1382 for Safety Instructions and pages 677 to 683 for 3/4/5 Port Solenoid Valve Precautions.

Internal Wiring Specifications

⚠ Caution

Light/surge voltage suppressor

No polarity by adopting non-polar light.

Plug-in Single/All plug lead types

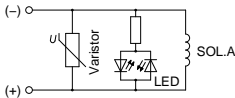

Plug-in Double, Dual 3-port

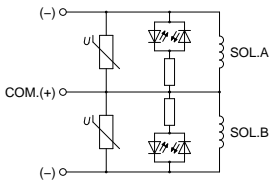

Note) Coil surge voltage generated when OFF is about -60 V. Please contact SMC separately for further suppression of the coil surge voltage.

Plug-in

Slim type plug-in manifold

A: Orange
B: Green

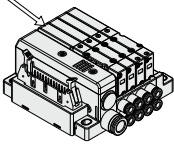

Plug-in manifold

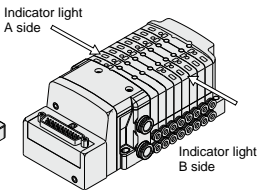

Plug lead manifold

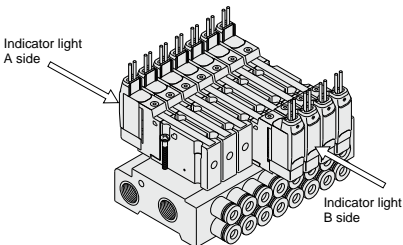

Surge Voltage Intrusion

⚠ Caution

The surge voltage created when the power supply is cut off could apply to the de-energized load equipment through the output circuit. In cases where the energized load equipment has a larger capacity (power consumption) and is connected to the same power supply as the product, the surge voltage could malfunction and/or damage the internal circuit element of the product and the internal device of the output equipment. To avoid this situation, place a diode which can suppress the surge voltage between the COM lines of the load equipment and output equipment.

How to Replace Pilot Valve

⚠ Caution

<Plug lead>

Removal

- 1) Remove the stopper plate from the adapter plate assembly by using a flat blade screwdriver on the concave of the stopper plate.
- 2) Take off the pilot valve in horizontal direction.

Mounting

- 1) Mount the pilot valve on the adapter plate assembly.
- 2) Insert the stopper plate into the adapter plate so that the stopper plate will not protrude from the end of the adapter plate.

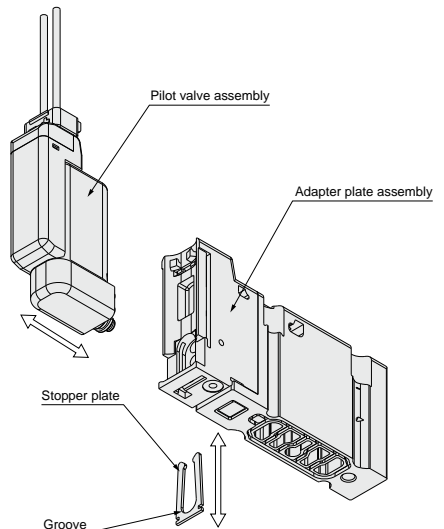



Series 10-S0700

Specific Product Precautions 4

Be sure to read this before handling.

Refer to page 1382 for Safety Instructions and pages 677 to 683 for 3/4/5 Port Solenoid Valve Precautions.

EX500/EX250/EX260

Warning

- These products are intended for use in general factory automation equipment.
Avoid using these products in machinery/equipment which affects human safety, and in cases where malfunction or failure can result in extensive damage.
- Do not use in an explosive atmosphere, environment with inflammable gases, or corrosive atmosphere. This can cause injury or fire, etc.
- Work such as transporting, installing, piping, wiring, operation, control and maintenance should be performed by personnel with specialized knowledge. There is a danger of electrocution, injury or fire, etc.
- Install an external emergency stop circuit that can promptly stop operation and shut off the power supply.
- Do not remodel these products, as there is a danger of injury and damage.

Caution

- Read the operation manual carefully, strictly observe the precautions and operate within the range of the specifications.
- Do not drop these products or submit them to strong impacts. This can cause damage, failure or malfunction, etc.
- In locations with poor electrical conditions, take steps to ensure a steady flow of the rated power supply. Use of a voltage outside of the specifications can cause malfunction, damage to the unit, electrocution or fire, etc.
- Do not touch connector terminals or internal substrates when current is being supplied. There is a danger of malfunction, damage to the unit or electrocution if connector terminals or internal substrates are touched when current is being supplied.

Be sure that the power supply is OFF when adding or removing manifold valves or input blocks, etc., or when connecting or disconnecting connectors.

- Operate at an ambient temperature that is within the specifications. Even when the ambient temperature range is within the specifications, do not use in locations where there are rapid temperature changes.
- Keep wire scraps and other extraneous material from getting inside these products. This can cause fire, failure or malfunction, etc.
- This product is not constructed to withstand water or oil penetration. Therefore it should be fitted with a protective cover when used in environments where it could be exposed to water or oil splash.
- Observe the proper tightening torque.
There is a possibility of damaging threads if tightening exceeds the tightening torque range.
- Adjustment/Operation**
DIP switches and rotary switches should be set with a small watchmakers' screwdriver.

Caution

- Provide adequate protection when operating in locations such as the following:
 - Where noise is generated by static electricity, etc.
 - Where there is a strong electric field
 - Where there is a danger of exposure to radiation
 - When in close proximity to power supply lines
- When these products are installed in equipment, provide adequate protection against noise by using noise filters, etc.
- Since these products are components that are used after installation in other equipment, the customer should confirm conformity to EMC directives for the finished product.
- Do not remove the name plate.
- Perform periodic inspections and confirm normal operation. It may otherwise be impossible to guarantee safety due to unexpected malfunction or erroneous operation.

Safety Instructions on Power Supply

Caution

- Operation is possible with a single power supply or a separate power supply. However, be sure to provide two wiring systems (one for solenoid valves, and one for input and control units).
- Use the following UL approved products for DC power supply combinations.

- Controlled voltage current circuit conforming to UL508
Circuit uses the secondary coil of an isolated transformer as the power supply, satisfying the following conditions.
 - Max. voltage (with no load): 30 Vrms (42.4 V peak) or less
 - Max. current: (1) 8 A or less (including shorts), and (2) When controlled by a circuit protector (fuse, etc.) with the following rating

No-load voltage (V peak)	Max. current rating
0 to 20 [V]	5.0
Over 20 [V] to 30 [V]	100
	Peak voltage value

- A circuit (class 2 circuit) with maximum 30 Vrms (42.4 V peak) or less, and a power supply consisting of a class 2 power supply unit conforming to UL1310, or a class 2 transformer conforming to UL1585

Directional Control Valves

Air Cylinders

Rotary Actuators

Air Grippers

Air Preparation Equipment

Modular F. R.

Pressure Control Equipment

Fittings & Tubing

Flow Control Equipment

Pressure Switches/Pressure Sensors



Series 10-S0700

Specific Product Precautions 5

Be sure to read this before handling.

Refer to page 1382 for Safety Instructions and pages 677 to 683 for 3/4/5 Port Solenoid Valve Precautions.

EX500/EX250

Safety Instructions on Cable

⚠ Caution

1. Be careful of miswiring. This can cause malfunction, damage and fire in the unit.
2. Do not connect cables during energizing.
This could damage or cause malfunction to the SI unit.
3. To prevent noise and surge in signal lines, keep all wiring separate from power lines and high voltage lines. Otherwise, this can cause malfunction.
4. Check wiring insulation, as defective insulation can cause damage to the unit due to excessive voltage or current.
5. Do not bend or pull cables repeatedly, and do not place heavy objects on them or allow them to be pinched. This can cause broken lines.

EX510

Design/Selection

⚠ Warning

1. Use within the allowable voltage range.
Using beyond the allowable voltage range is likely to cause the units and connecting devices to be damaged or to malfunction.
2. Do not use beyond the specification range.
Using beyond the specification range is likely to cause a fire, malfunction, or breakdown in the units and connecting devices. Check the specifications before handling.
3. Establish a backup system beforehand, which employs fail-safe concepts such as multiple equipment and devices to prevent breakage or malfunction of this product.
4. Provide an external emergency stop circuit that will immediately stop an operation and cut off the power supply.
5. When using for an interlock circuit:
 - Provide a double interlock which is operated by another system (such mechanical protection function).
 - Perform an inspection to check that it is working properly because it can cause possible injuries.

⚠ Caution

1. Keep the surrounding space free for maintenance.
When designing a system, take into consideration the amount of free space needed for performing maintenance.
2. Use the following UL approved products for DC power supply combinations.
 - 1) Controlled voltage current circuit conforming to UL508
Circuit uses the secondary coil of an isolated transformer as the power supply, satisfying the following conditions.
 - Max. voltage (with no load): 30 Vrms (42.4 V peak) or less
 - Max. current: (1) 8 A or less (including shorts), and (2) When controlled by a circuit protector (fuse, etc.) with the following rating

No-load voltage (V peak)	Max. current rating
0 to 20 [V]	5.0
Over 20 [V] to 30 [V]	100
	Peak voltage value
 - 2) A circuit (class 2 circuit) with maximum 30 Vrms (42.4 V peak) or less, and a power supply consisting of a class 2 power supply unit conforming to UL1310, or a class 2 transformer conforming to UL1585
3. This product is one of the components to be equipped into a final equipment. Confirm the adaptability to the EMC directive as the whole equipment by customers themselves.
4. The power supply for the Gateway unit should be 0 V as the standard for both power supply for outputs as well as inputs and for the control unit of the Gateway.

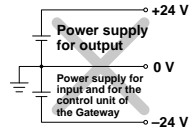
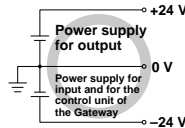



Series 10-S0700

Specific Product Precautions 6

Be sure to read this before handling.

Refer to page 1382 for Safety Instructions and pages 677 to 683 for 3/4/5 Port Solenoid Valve Precautions.

EX510

Mounting

⚠ Caution

- 1. Do not drop, bump, or apply excessive impact.**
Otherwise, the unit can become damaged, malfunction, or fail to function.
- 2. Hold the body while handling this product.**
Otherwise, the unit can become damaged, malfunction, or fail to function.
- 3. Observe the tightening torque range.**
Tightening outside of the allowable torque range will likely damage the product.
- 4. Do not install a unit in a place where it can be used as a scaffold.**
Applying any excessive load such as stepping on the unit by mistake or placing a foot on it, will cause it to break.

Wiring

⚠ Warning

- 1. Avoid miswiring.**
If miswired, there is a probability of damaging units or connecting devices.
- 2. Do not wire while energizing the product.**
It is likely to damage the units or connecting devices.
- 3. Avoid wiring the power line and high pressure line in parallel.**
Noise or surge produced by signal line resulting from the power line or high pressure line could cause a malfunction. Wiring of the reduced wiring system and the power line or high pressure line should be separated from each other.
- 4. Check the wiring insulation.**
Inferior insulation (contact with other circuit, insulation between terminals, etc.) will likely cause damage to the units or connecting devices due to excessive voltage or the influx of current.

⚠ Caution

- 1. Take measures to avoid applying repeated bending force or pulling force to the cable.**
Also, pay attention not to place any heavy matter on the cable or clipping. It is likely to cause a broken wire.
- 2. Check the grounding to maintain the safety of the reduced wiring system and for anti-noise performance.**
Grounding should be close to units and keep the grounding distance short.

Operating Environment

⚠ Warning

- 1. Do not use this product in the presence of dust, particles, water, chemicals, and oil.**
Use with such materials is likely to cause a malfunction or breakage.
- 2. Do not use this product in the presence of a magnetic field.**
Use in such an environment is likely to cause a malfunction.
- 3. Do not use this product in an atmosphere containing an inflammable gas, explosive gas, or corrosive gas.**
Use in such an atmosphere is likely to cause a fire, explosion, or corrosion. This wire-reduced system is not explosion-proof.
- 4. Do not use this product in places where there are cyclic temperature changes.**
In case that the cyclic temperature is beyond normal temperature changes, the internal unit is likely to be adversely affected.
- 5. Do not use this product in places where there is radiated heat around it.**
Such a place is likely to cause a malfunction or breakage.
- 6. Do not use this product near sources that generate a surge which exceeds the benchmark test, even though this product is CE-marked certified.**
The internal circuit components are likely to deteriorate or become damaged when there are equipment (solenoid type lifter, high frequency guided furnace, motor, etc.) which generate a large surge around the reduced wiring system. Take measures to prevent an electrical surge and avoid having the wires touch each other.
- 7. Use the product type that has an integrated surge absorption element when directly driving a load which generates surge voltage by relay or solenoid valves.**
- 8. The reduced wiring system should be installed in places with no vibration or shock.**
Such a place is likely to cause a malfunction or breakage.

Directional Control Valves

Air Cylinders

Rotary Actuators

Air Grippers

Air Preparation Equipment

Modular F. R.

Pressure Control Equipment

Fittings & Tubing

Flow Control Equipment

Pressure Switches/ Pressure Sensors



Series 10-S0700

Specific Product Precautions 7

Be sure to read this before handling.

Refer to page 1382 for Safety Instructions and pages 677 to 683 for 3/4/5 Port Solenoid Valve Precautions.

EX510

Adjustment/Operation

Warning

1. Do not short-circuit a load.

If a load is short-circuited, excessive current can cause damage to the connected devices. The fuse of the input unit will melt. The output and SI unit will activate its overcurrent protection function. However, they cannot cover all modes, so damage is likely to occur.

2. Do not manipulate or perform settings with wet hands.

Performing such activity will likely cause an electrical shock.

Caution

1. DIP switches and rotary switches should be set with a small watchmakers' screwdriver.

Maintenance

Warning

1. Do not disassemble, modify (including circuit board replacement) or repair this product.

Such actions are likely to cause injuries or breakage.

2. Perform periodic inspection.

Confirm that wiring or screws are not loose. Otherwise, unpredicted malfunction in the system composition devices is likely to occur.

3. When an inspection is performed.

- Turn off the power supply.
- Stop the supplied fluid and discharge the fluid in the piping and confirm the release to the atmosphere before performing an inspection. It is likely to cause injuries.

Caution

1. Do not wipe this product with chemicals such as benzene or thinner.

Using such chemicals is likely to cause damage.



Series 10-S0700

Specific Product Precautions 8

Be sure to read this before handling.

Refer to page 1382 for Safety Instructions and pages 677 to 683 for 3/4/5 Port Solenoid Valve Precautions.

EX600

Design/Selection

⚠ Warning

- Use this product within the specification range.**
Using beyond the specified specifications range can cause fire, malfunction, or damage to the system. Check the specifications when operating.
- When using for an interlock circuit:**
 - Provide a multiple interlock system which is operated by another system (such as mechanical protection function).
 - Perform an inspection to confirm that it is working properly. This may cause possible injury due to malfunction.

⚠ Caution

- Use the following UL approved products for DC power supply combinations.**
 - Controlled voltage current circuit conforming to UL508
Circuit uses the secondary coil of an isolated transformer as the power supply, satisfying the following conditions.
 - Max. voltage (with no load): 30 Vrms (42.4 V peak) or less
 - Max. current: (1) 8 A or less (including shorts), and (2) When controlled by a circuit protector (fuse, etc.) with the following rating

No-load voltage (V peak) 0 to 20 [V]	Max. current rating
Over 20 [V] to 30 [V]	100 Peak voltage value
 - A circuit (class 2 circuit) with maximum 30 Vrms (42.4 V peak) or less, and a power supply consisting of a class 2 power supply unit conforming to UL1310, or a class 2 transformer conforming to UL1585

- Use this product within the specified voltage range.**
Using beyond the specified voltage range is likely to cause the units and connecting devices to be damaged or to malfunction.
- The power supply for the unit should be 0 V as the standard for both power supply for output as well as power supply for control/input.**

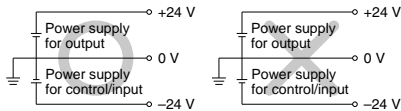

- Do not install a unit in a place where it can be used as a foothold.**
Applying any excessive load such as stepping on the unit by mistake or placing a foot on it, will cause it to break.
- Keep the surrounding space free for maintenance.**
When designing a system, take into consideration the amount of free space needed for performing maintenance.
- Do not remove the name plate.**
Improper maintenance or incorrect use of operation manual can cause failure and malfunction. Also, there is a risk of losing conformity with safety standards.
- Beware of inrush current when the power supply is turned on.**
Some connected loads can apply an initial charge current which will trigger the over current protection function, causing the unit to malfunction.

Mounting

⚠ Caution

- When handling and assembling units:**
 - Do not touch the sharp metal parts of the connector or plug.
 - Do not apply excessive force to the unit when disassembling.
The connecting portions of the unit are firmly joined with seals.
 - When joining units, take care not to get fingers caught between units.
Injury can result.
- Do not drop, bump, or apply excessive impact.**
Otherwise, the unit can become damaged, malfunction, or fail to function.
- Observe the tightening torque range.**
Tightening outside of the allowable torque range will likely damage the product.
IP67 protection class cannot be guaranteed if the screws are not tightened to the specified torque.
- When lifting a large size manifold solenoid valve unit, take care to avoid causing stress to the valve connection joint.**
The connection parts of the unit may be damaged. Because the unit may be heavy, carrying and installation should be performed by more than one operator to avoid strain or injury.
- When placing a manifold, mount it on a flat surface.**
Torsion in the whole manifold can lead to trouble such as air leakage or defective insulation.

Wiring

⚠ Caution

- Check the grounding to maintain the safety of the reduced wiring system and for anti-noise performance.**
Provide a specific grounding as close to the unit as possible to minimize the distance to grounding.
- Avoid repeatedly bending or stretching the cable and applying a heavy object or force to it.**
Wiring applying repeated bending and tensile stress to the cable can break the circuit.
- Avoid miswiring.**
If miswired, there is a danger of malfunction or damage to the reduced wiring system.
- Do not wire while energizing the product.**
There is a danger of malfunction or damage to the reduced wiring system or input/output equipment.

Directional Control Valves

Air Cylinders

Rotary Actuators

Air Grippers

Air Preparation Equipment

Modular F. R.

Pressure Control Equipment

Fittings & Tubing

Flow Control Equipment

Pressure Switches/ Pressure Sensors



Series 10-S0700

Specific Product Precautions 9

Be sure to read this before handling.

Refer to page 1382 for Safety Instructions and pages 677 to 683 for 3/4/5 Port Solenoid Valve Precautions.

EX600

Wiring

Caution

5. **Avoid wiring the power line and high pressure line in parallel.**

Noise or surge produced by signal line resulting from the power line or high pressure line could cause malfunction.

Wiring of the reduced wiring system or input/output device and the power line or high pressure line should be separated from each other.

6. **Check the wiring insulation.**

Defective insulation (contact with other circuits, improper insulation between terminals, etc.) may cause damage to the reduced wiring system or input/output device due to excessive voltage or current.

7. **When a reduced wiring system is installed in machinery/equipment, provide adequate protection against noise by using noise filters, etc.**

Noise in signal lines may cause a malfunction.

8. **When connecting wires of input/output device or handheld terminal, prevent water, solvent or oil from entering inside from the connector section.**

This can cause damage, equipment failure or malfunction.

9. **Avoid wiring patterns in which excessive stress is applied to the connector.**

This may cause malfunction or damage to the unit due to contact failure.

Operating Environment

Warning

1. **Do not use in an atmosphere containing an inflammable gas or explosive gas.**

Use in such an atmosphere is likely to cause a fire or explosion. This system is not explosion-proof.

Caution

1. **Select the proper type of enclosure according to the environment of operation.**

IP65/67 is achieved when the following conditions are met.

- 1) Provide appropriate wiring between all units using electrical wiring cables, communication connectors and cables with M12 connectors.

- 2) Suitable mounting of each unit and manifold valve.

- 3) Be sure to mount a seal cap on any unused connectors.

If using in an environment that is exposed to water splashes, please take measures such as using a cover.

Also, the Handheld Terminal conforms to IP20, so prevent foreign matter from entering inside, and water, solvent or oil from coming in direct contact with it.

Operating Environment

Caution

2. **Provide adequate protection when operating in locations such as the following.**

Failure to do so may cause damage or malfunction.

The effect of countermeasures should be checked in individual equipment and machine.

- 1) Where noise is generated by static electricity, etc.

- 2) Where there is a strong electric field

- 3) Where there is a danger of exposure to radiation

- 4) When in close proximity to power supply lines

3. **Do not use in an environment where oil and chemicals are used.**

Operating in environments with coolants, cleaning solvents, various oils or chemicals may cause adverse effects (damage, malfunction) to the unit even in a short period of time.

4. **Do not use in an environment where the product could be exposed to corrosive gas or liquid.**

This may damage the unit and cause it to malfunction.

5. **Do not use in locations with sources of surge generation.**

Installation of the unit in an area around the equipment (electromagnetic lifters, high frequency induction furnaces, welding machine, motors etc.), which generates the large surge voltage could cause to deteriorate an internal circuitry element of the unit or result in damage. Implement countermeasures against the surge from the generating source, and avoid touching the lines with each other.

6. **Use the product type that has an integrated surge absorption element when directly driving a load which generates surge voltage by relay, solenoid valves or lamp.**

When a surge generating load is directly driven, the unit may be damaged.

7. **The product is CE marked, but not immune to lightning strikes. Take measures against lightning strikes in your system.**

8. **Keep dust, wire scraps and other extraneous material from getting inside the product.**

This may cause a malfunction or damage.

9. **Mount the unit in such locations, where no vibration or shock is affected.**

This may cause a malfunction or damage.

10. **Do not use in places where there are cyclic temperature changes.**

In case that the cyclic temperature is beyond normal temperature changes, the internal unit is likely to be adversely affected.

11. **Do not use in direct sunlight.**

Do not use in direct sunlight. It may cause a malfunction or damage.

12. **Use this product within the specified ambient temperature range.**

This may cause a malfunction.

13. **Do not use in places where there is radiated heat around it.**

Such a place is likely to cause a malfunction.



Series 10-S0700

Specific Product Precautions 10

Be sure to read this before handling.

Refer to page 1382 for Safety Instructions and pages 677 to 683 for 3/4/5 Port Solenoid Valve Precautions.

EX600

Adjustment/Operation

Warning

1. Do not perform operation or setting with wet hands.
There is a risk of electrical shock.

<Handheld Terminal>

2. Do not apply pressure to the LCD.
There is a possibility of the crack of LCD and injuring.
3. The forced input/output function is used to change the signal status forcibly. When operating this function, be sure to check the safety of the surroundings and installation.
Otherwise, injury or equipment damage could result.
4. Incorrect setting of parameters can cause malfunction. Be sure to check the settings before use.
This may cause injury or equipment damage.

Caution

1. Use a watchmakers' screwdriver with thin blade for the setting of each switch of the SI unit.
When setting the switch, do not touch other unrelated parts.
This may cause parts damage or malfunction due to a short-circuit.
2. Provide adequate setting for the operating conditions.
Failure to do so could result in malfunction.
Refer to the operation manual for setting of the switches.
3. For details on programming and address setting, refer to the manual from the PLC manufacturer.
The content of programming related to protocol is designed by the manufacturer of the PLC used.

<Handheld Terminal>

4. Do not press the setting buttons with a sharp pointed object.
This may cause damage or malfunction.
5. Do not apply excessive load and impact to the setting buttons.
This may cause damage, equipment failure or malfunction.

When the order does not include the SI unit, the valve plate to connect the manifold and SI unit is not mounted. Use attached valve fixing screws and mount the valve plate.
(Tightening torque: 0.6 to 0.7 N·m)

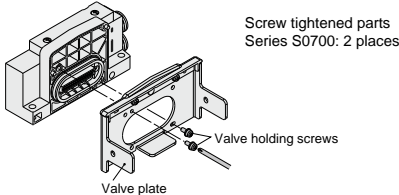

Maintenance

Warning

1. Do not disassemble, modify (including circuit board replacement) or repair this product.
Such actions are likely to cause injuries or breakage.
2. When an inspection is performed,
 - Turn off the power supply.
 - Stop the air supply, exhaust the residual pressure in piping and verify that the air is released before performing maintenance work.
 Unexpected malfunction of system components and injury can result.

Caution

1. When handling and replacing the unit:
 - Do not touch the sharp metal parts of the connector or plug.
 - Do not apply excessive force to the unit when disassembling.
The connecting portions of the unit are firmly joined with seals.
 - When joining units, take care not to get fingers caught between units.
Injury can result.
2. Perform periodic inspection.
Unexpected malfunction in the system composition devices is likely to occur due to malfunction of machinery or equipment.
3. After maintenance, make sure to perform an appropriate functionality inspection.
In cases of abnormality such as faulty operation, stop operation. Unexpected malfunction in the system composition devices is likely to occur.
4. Do not use benzene and thinner for cleaning units.
Damage to the surface or erasure of the display can result. Wipe off any stains with a soft cloth.
If the stain is persistent, wipe off with a cloth soaked in a dilute solution of neutral detergent and wrung out tightly, and then finish with a dry cloth.

Directional Control Valves

Air Cylinders

Rotary Actuators

Air Grippers

Air Preparation Equipment

Modular F. R.

Pressure Control Equipment

Fittings & Tubing

Flow Control Equipment

Pressure Switches/ Pressure Sensors

■ Trademark
DeviceNet™ is a trademark of ODVA.
The product names stated in this catalog may be trademarks of their respective owners.

Series ¹⁰⁻₂₁₋VQ1000/2000

5 Port Solenoid Valve

Base Mounted



Manifold type	Series	D-sub connector	Flat ribbon cable	Connector	Serial
Plug-in	10-/21-VQ1000	●	●	—	●
	10-/21-VQ2000	●	●	—	●

¹⁰⁻₂₁₋VQ1000 How to Order, Manifold Options P. 515

¹⁰⁻₂₁₋VQ2000 How to Order, Manifold Options P. 517

¹⁰⁻₂₁₋VQ1000/2000 Model, Standard/Manifold Specifications P. 521

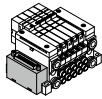

¹⁰⁻₂₁₋VQ1000/2000
F kit (D-sub connector) P. 523



¹⁰⁻₂₁₋VQ1000/2000
P kit (Flat ribbon cable) P. 527

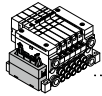

¹⁰⁻₂₁₋VQ1000/2000
J kit (Flat ribbon cable) P. 531

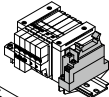

¹⁰⁻₂₁₋VQ1000/2000
G kit (Flat ribbon cable with terminal block) P. 535

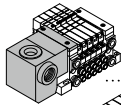

¹⁰⁻₂₁₋VQ1000/2000
T kit (Terminal block box) P. 539

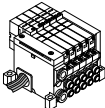

¹⁰⁻₂₁₋VQ1000/2000
L kit (Lead wire) P. 543

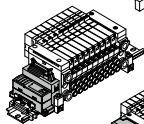

¹⁰⁻₂₁₋VQ1000/2000
S kit (Serial transmission) EX510 P. 547



¹⁰⁻₂₁₋VQ1000/2000
S kit (Serial transmission) EX120/123/124 P. 551

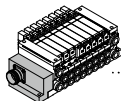

¹⁰⁻₂₁₋VQ2000
M kit (Circular connector) P. 557

¹⁰⁻₂₁₋VQ2000 Sub-plate Single Unit P. 560

¹⁰⁻₂₁₋VQ1000/2000 Semi-standard P. 561

¹⁰⁻₂₁₋VQ1000/2000 Construction P. 564

¹⁰⁻₂₁₋VQ1000/2000 Exploded View of Manifold P. 567

¹⁰⁻₂₁₋VQ1000/2000 Manifold Optional Parts P. 571

¹⁰⁻₂₁₋VQ1000/2000 Specific Product Precautions P. 575

Directional Control Valves

Air Cylinders

Rotary Actuators

Air Grippers

Air Preparation Equipment

Modular F. R.

Pressure Control Equipment

Fittings & Tubing

Flow Control Equipment

Pressure Switches/Pressure Sensors

Series 10-21-VQ1000

Base Mounted Plug-in Unit

Note) For CE compliant models, DC-type only.



How to Order Manifold

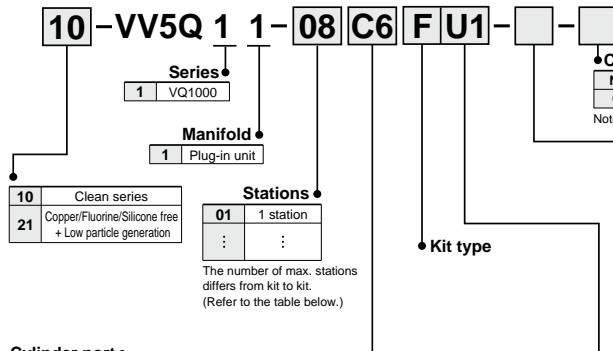

Cylinder port

Symbol	Port size	Symbol	Port size
C3	With ø3.2 One-touch fitting	L5	Top ported elbow M5 thread
C4	With ø4 One-touch fitting	B3	Bottom ported elbow with ø3.2 One-touch fitting
C6	With ø6 One-touch fitting	B4	Bottom ported elbow with ø4 One-touch fitting
M5	M5 thread	B6	Bottom ported elbow with ø6 One-touch fitting
CM (Note 1)	Mixed sizes and with port plug	B5	Bottom ported elbow M5 thread
L3	Top ported elbow with ø3.2 One-touch fitting	LM (Note 1)	Elbow port, mixed sizes
L4	Top ported elbow with ø4 One-touch fitting	MM (Note 2)	Mixed size for different types of piping, option installed
L6	Top ported elbow with ø6 One-touch fitting		

Note 1) Indicate "Mixed sizes and with port plug" by means of the manifold specification sheet.
 Note 2) When selecting the mixed size for different types of piping or dual flow fitting assembly, enter "MM" and give instructions on the manifold specification sheet.
 Note 3) Inch-size One-touch fittings are also available. Refer to page 563 for details.
 Note 4) M5 fittings for M5 thread are attached without being incorporated.

Simple specials are available with SMC Simple Specials System. Refer to the **WEB catalog** for details on applicable models.

CE compliant

Nil	—
Q	CE compliant

Note) For CE compliant models, DC-type only.

Option

Symbol	Option
Nil	None
2	200/220 VAC models (F/L kit only)
B (Note 2)	With back pressure check valve
D	DIN rail mounting
D0	With DIN rail bracket (Without DIN rail)
D□ (Note 5)	With ejector unit
K (Note 3)	Special wiring spec. (Except double wiring)
N	With name plate
R (Note 4)	External pilot

Note 1) When two or more symbols are specified, indicate them alphabetically. Example: -BNR

Note 2) Models with a suffix "B" have check valves for prevention of back pressure at all manifold stations. When a back pressure check valve is desired, and is to be installed only in certain manifold stations, specify the mounting position by means of the manifold specification sheet.

Note 3) Specify the wiring specifications by means of the manifold specification sheet. (Except L kit)

Note 4) Indicate "R" for the valve with external pilot.

Note 5) □: Station. Example: D08: The number of stations that may be displayed is longer than the manifold number of stations.

Kit type/Electrical entry/Cable length

F kit (D-sub connector)		P kit (Flat ribbon cable)		J kit (Flat ribbon cable 20P)		G kit (Flat ribbon cable with terminal block)																																																																																																	
<p>Note 1) 25P</p>		<p>Note 1) 26P</p>		<p>20P</p>		<p>The voltage used for the valve is 24 VDC.</p> <p>20P</p> <p>Order separately SI unit made by OMRON Corp.</p>																																																																																																	
<table border="1"> <tr> <th colspan="2">Connector entry direction</th> <th colspan="2">P. 523</th> </tr> <tr> <th>Top entry</th> <th>Side entry</th> <th>Top entry</th> <th>Side entry</th> </tr> <tr> <td>U0</td> <td>S0</td> <td>U0</td> <td>S0</td> </tr> <tr> <td>U1</td> <td>S1</td> <td>U1</td> <td>S1</td> </tr> <tr> <td>U2</td> <td>S2</td> <td>U2</td> <td>S2</td> </tr> <tr> <td>U3</td> <td>S3</td> <td>U3</td> <td>S3</td> </tr> </table>		Connector entry direction		P. 523		Top entry	Side entry	Top entry	Side entry	U0	S0	U0	S0	U1	S1	U1	S1	U2	S2	U2	S2	U3	S3	U3	S3	<table border="1"> <tr> <th colspan="2">Connector entry direction</th> <th colspan="2">P. 527</th> </tr> <tr> <th>Top entry</th> <th>Side entry</th> <th>Top entry</th> <th>Side entry</th> </tr> <tr> <td>U0</td> <td>S0</td> <td>U0</td> <td>S0</td> </tr> <tr> <td>U1</td> <td>S1</td> <td>U1</td> <td>S1</td> </tr> <tr> <td>U2</td> <td>S2</td> <td>U2</td> <td>S2</td> </tr> <tr> <td>U3</td> <td>S3</td> <td>U3</td> <td>S3</td> </tr> </table>		Connector entry direction		P. 527		Top entry	Side entry	Top entry	Side entry	U0	S0	U0	S0	U1	S1	U1	S1	U2	S2	U2	S2	U3	S3	U3	S3	<table border="1"> <tr> <th colspan="2">Connector entry direction</th> <th colspan="2">P. 531</th> </tr> <tr> <th>Top entry</th> <th>Side entry</th> <th>Top entry</th> <th>Side entry</th> </tr> <tr> <td>U0</td> <td>S0</td> <td>U0</td> <td>S0</td> </tr> <tr> <td>U1</td> <td>S1</td> <td>U1</td> <td>S1</td> </tr> <tr> <td>U2</td> <td>S2</td> <td>U2</td> <td>S2</td> </tr> <tr> <td>U3</td> <td>S3</td> <td>U3</td> <td>S3</td> </tr> </table>		Connector entry direction		P. 531		Top entry	Side entry	Top entry	Side entry	U0	S0	U0	S0	U1	S1	U1	S1	U2	S2	U2	S2	U3	S3	U3	S3	<table border="1"> <tr> <th colspan="2">Connector entry direction</th> <th colspan="2">P. 535</th> </tr> <tr> <th>Top entry</th> <th>Side entry</th> <th>Top entry</th> <th>Side entry</th> </tr> <tr> <td>U0</td> <td>S0</td> <td>U0</td> <td>S0</td> </tr> <tr> <td>U1</td> <td>S1</td> <td>U1</td> <td>S1</td> </tr> <tr> <td>U2</td> <td>S2</td> <td>U2</td> <td>S2</td> </tr> <tr> <td>U3</td> <td>S3</td> <td>U3</td> <td>S3</td> </tr> </table>		Connector entry direction		P. 535		Top entry	Side entry	Top entry	Side entry	U0	S0	U0	S0	U1	S1	U1	S1	U2	S2	U2	S2	U3	S3	U3	S3
Connector entry direction		P. 523																																																																																																					
Top entry	Side entry	Top entry	Side entry																																																																																																				
U0	S0	U0	S0																																																																																																				
U1	S1	U1	S1																																																																																																				
U2	S2	U2	S2																																																																																																				
U3	S3	U3	S3																																																																																																				
Connector entry direction		P. 527																																																																																																					
Top entry	Side entry	Top entry	Side entry																																																																																																				
U0	S0	U0	S0																																																																																																				
U1	S1	U1	S1																																																																																																				
U2	S2	U2	S2																																																																																																				
U3	S3	U3	S3																																																																																																				
Connector entry direction		P. 531																																																																																																					
Top entry	Side entry	Top entry	Side entry																																																																																																				
U0	S0	U0	S0																																																																																																				
U1	S1	U1	S1																																																																																																				
U2	S2	U2	S2																																																																																																				
U3	S3	U3	S3																																																																																																				
Connector entry direction		P. 535																																																																																																					
Top entry	Side entry	Top entry	Side entry																																																																																																				
U0	S0	U0	S0																																																																																																				
U1	S1	U1	S1																																																																																																				
U2	S2	U2	S2																																																																																																				
U3	S3	U3	S3																																																																																																				
<table border="1"> <tr> <th>Kit</th> <th>Cable</th> <th>Stations</th> </tr> <tr> <td>F</td> <td>S0 Without cable</td> <td>2 to 24</td> </tr> <tr> <td>U1</td> <td>S1 With cable (1.5 m)</td> <td>2 to 24</td> </tr> <tr> <td>U2</td> <td>S2 With cable (3 m)</td> <td>2 to 24</td> </tr> <tr> <td>U3</td> <td>S3 With cable (5 m)</td> <td>2 to 24</td> </tr> </table>		Kit	Cable	Stations	F	S0 Without cable	2 to 24	U1	S1 With cable (1.5 m)	2 to 24	U2	S2 With cable (3 m)	2 to 24	U3	S3 With cable (5 m)	2 to 24	<table border="1"> <tr> <th>Kit</th> <th>Cable</th> <th>Stations</th> </tr> <tr> <td>P</td> <td>S0 Without cable</td> <td>2 to 24</td> </tr> <tr> <td>U1</td> <td>S1 With cable (1.5 m)</td> <td>2 to 24</td> </tr> <tr> <td>U2</td> <td>S2 With cable (3 m)</td> <td>2 to 24</td> </tr> <tr> <td>U3</td> <td>S3 With cable (5 m)</td> <td>2 to 24</td> </tr> </table>		Kit	Cable	Stations	P	S0 Without cable	2 to 24	U1	S1 With cable (1.5 m)	2 to 24	U2	S2 With cable (3 m)	2 to 24	U3	S3 With cable (5 m)	2 to 24	<table border="1"> <tr> <th>Kit</th> <th>Cable</th> <th>Stations</th> </tr> <tr> <td>J</td> <td>S0 Without cable</td> <td>2 to 24</td> </tr> <tr> <td>U1</td> <td>S1 With cable (1.5 m)</td> <td>2 to 24</td> </tr> <tr> <td>U2</td> <td>S2 With cable (3 m)</td> <td>2 to 24</td> </tr> <tr> <td>U3</td> <td>S3 With cable (5 m)</td> <td>2 to 24</td> </tr> </table>		Kit	Cable	Stations	J	S0 Without cable	2 to 24	U1	S1 With cable (1.5 m)	2 to 24	U2	S2 With cable (3 m)	2 to 24	U3	S3 With cable (5 m)	2 to 24	<table border="1"> <tr> <th>Kit</th> <th>Cable</th> <th>Stations</th> </tr> <tr> <td>G</td> <td>S0 Without cable</td> <td>2 to 16</td> </tr> <tr> <td>1</td> <td>S1 With cable (1.5 m)</td> <td>2 to 16</td> </tr> <tr> <td>2</td> <td>S2 With cable (3 m)</td> <td>2 to 16</td> </tr> <tr> <td>3</td> <td>S3 With cable (5 m)</td> <td>2 to 16</td> </tr> </table>		Kit	Cable	Stations	G	S0 Without cable	2 to 16	1	S1 With cable (1.5 m)	2 to 16	2	S2 With cable (3 m)	2 to 16	3	S3 With cable (5 m)	2 to 16																																				
Kit	Cable	Stations																																																																																																					
F	S0 Without cable	2 to 24																																																																																																					
U1	S1 With cable (1.5 m)	2 to 24																																																																																																					
U2	S2 With cable (3 m)	2 to 24																																																																																																					
U3	S3 With cable (5 m)	2 to 24																																																																																																					
Kit	Cable	Stations																																																																																																					
P	S0 Without cable	2 to 24																																																																																																					
U1	S1 With cable (1.5 m)	2 to 24																																																																																																					
U2	S2 With cable (3 m)	2 to 24																																																																																																					
U3	S3 With cable (5 m)	2 to 24																																																																																																					
Kit	Cable	Stations																																																																																																					
J	S0 Without cable	2 to 24																																																																																																					
U1	S1 With cable (1.5 m)	2 to 24																																																																																																					
U2	S2 With cable (3 m)	2 to 24																																																																																																					
U3	S3 With cable (5 m)	2 to 24																																																																																																					
Kit	Cable	Stations																																																																																																					
G	S0 Without cable	2 to 16																																																																																																					
1	S1 With cable (1.5 m)	2 to 16																																																																																																					
2	S2 With cable (3 m)	2 to 16																																																																																																					
3	S3 With cable (5 m)	2 to 16																																																																																																					

Note 1) Besides the above, F/P kit with different number of pins are available. Refer to page 561 for details.

Note 2) Refer to page 562 for details.

(Note) For CE compliant models, DC-type only. **CE** [Option]

How to Order Valve

10-VQ 1 1 0 0 - 5 - 1 -

- Series**
- 1 VQ1000
- 10** Clean series
- 21** Copper/Fluorine/Silicone free + Low particle generation

- Seal**
- 0 Metal seal
 - 1 Rubber seal

- Actuation type**
- 1 2-position single (AVB)
 - 2 2-position double (Metal)
 - 2 2-position double (Rubber)
 - 3 3-position closed center (AVB)
 - 3 3-position exhaust center (AVB)
 - 4 3-position pressure center (AVB)
 - 5 3-position pressure center (AVB)

Symbol	Specifications	Function	
		DC	AC
Nil	Standard	(0.4 W) <input type="radio"/>	(Note 1) <input type="radio"/>
B	High-speed response type	(0.95 W) <input type="radio"/>	<input type="radio"/>
K (Note 2)	High-pressure type (1.0 MPa)	(0.95 W) <input type="radio"/>	<input type="radio"/>
N (Note 3)	Negative common	<input type="radio"/>	<input type="radio"/>
R (Note 3)	External pilot	<input type="radio"/>	<input type="radio"/>

Note 1) Refer to page 522 for power consumption of AC type.
 Note 2) Metal seal only
 Note 3) For external pilot and negative common specifications, refer to "Semi-standard" on pages 562 to 563.
 Note 4) When two or more symbols are specified, indicate them alphabetically. Combination of [B] and [K] is not possible.

- CE compliant**
- | | |
|-----|--------------|
| Nil | — |
| Q | CE compliant |
- (Note) For CE compliant models, DC-type only.

- Manual override**
- Nil:** Non-locking push type (Tool required)
 - B:** Locking type (Tool required)
 - C:** Locking type (Manual)
 - D:** Slide locking type (Manual)

- Light/surge voltage suppressor**
- | | |
|----------|------|
| Nil | Yes |
| E (Note) | None |
- (Note) Not applicable to the S kit.

- Coil voltage**
- | | | CE compliant |
|----------|--------------------|--------------|
| 1 | 100 VAC (50/60 Hz) | — |
| 2 (Note) | 200 VAC (50/60 Hz) | — |
| 3 | 110 VAC (50/60 Hz) | — |
| 4 (Note) | 220 VAC (50/60 Hz) | — |
| 5 | 24 VDC | ● |
| 6 | 12 VDC | ● |
- (Note) 200 and 220 VAC: F/L kit only

How to Order Manifold Assembly

Example

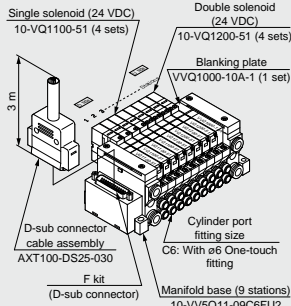

10-VV5Q11-09C6FU2 ... 1 set (F kit 9-station manifold base part no.)
 *10-VQ1100-51 ... 4 sets (Single solenoid part no.)
 *10-VQ1200-51 ... 4 sets (Double solenoid part no.)
 *VVQ1000-10A-1 ... 1 set (Blanking plate part no.)

The asterisk denotes the symbol for assembly. Prefix it to the part no. of the solenoid valve, etc.

Specify the part numbers for valves and options together beneath the manifold base part number. Besides, when the arrangement will be complicated, specify them by means of the manifold specification sheet.

Caution

Use the standard (DC) specification when continuously energizing for long periods of time.

T kit (Terminal block box)

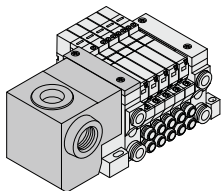

P. 539

T kit O Terminal block box 2 to 24 stations (Note 2)

L kit (Lead wire)

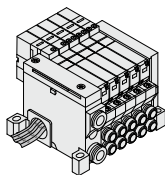

P. 543

L kit		1 to 8 stations
0	With cable (0.6 m)	
1	With cable (1.5 m)	
2	With cable (3 m)	

S kit (Serial transmission)

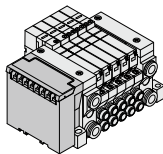

The valve is equipped with an indicator light and surge voltage suppressor, and the voltage is 24 VDC. The dust proof SI unit is also available. Refer to page 551 for details.
 (Note) Refer to "SI Unit Part No." on page 551 when ordering the CE-compliant SI unit. **P. 551**

S kit		(Note 2)
0	Without SI unit	
F1	NKE Corp.: Fieldbus System	Max. 16 stations
H	NKE Corp.: Fieldbus H System	
J1	Panasonic Industrial Devices SUNX Co., Ltd.: S-LINK (16 outputs)	
J2	Panasonic Industrial Devices SUNX Co., Ltd.: S-LINK (8 outputs)	Max. 8 stations
Q	DeviceNet™	Max. 16 stations
R1	OMRON Corp.: CompoBus/S (16 outputs)	Max. 16 stations
R2	OMRON Corp.: CompoBus/S (8 outputs)	Max. 8 stations
V	CC-Link	
ZB	CompoNet™ (Positive common)	Max. 16 stations
ZBN	CompoNet™ (Negative common)	

Directional Control Valves

Air Cylinders

Rotary Actuators

Air Grippers

Air Preparation Equipment

Modular F. R.

Pressure Control Equipment

Fittings & Tubing

Flow Control Equipment

Pressure Switches/Pressure Sensors

Series 10-21-VQ2000

Base Mounted Plug-in Unit

Note) For CE compliant models, DC-type only.



How to Order Manifold

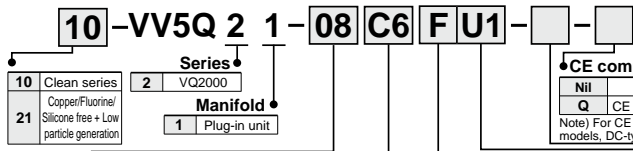

Series

10	Clean series
21	Copper/Fluorine/Silicone free + Low particle generation

The maximum and minimum number of stations are varied depending on kit. (Refer to the below table.)

Manifold

1	Plug-in unit
---	--------------

Stations

01	1 station
:	:

Cylinder port

Symbol	Port size
C4	With ø4 One-touch fitting
C6	With ø6 One-touch fitting
C8	With ø8 One-touch fitting
CM (Note 1)	Mixed sizes and with port plug
L4	Top ported elbow with ø4 One-touch fitting
L6	Top ported elbow with ø6 One-touch fitting

Note 1) Indicate "Mixed size and with port plug" by means of the manifold specification sheet.

Note 2) When selecting the mixed size for different types of piping, dual flow fitting assembly, or double check block (direct mounting), enter "MM" and give instructions on the manifold specification sheet.

Note 3) Inch-size One-touch fittings are also available. Refer to page 563 for details.

Simple specials are available with SMC Simple Specials System. Refer to the **WEB catalog** for details on applicable models.

Kit type

Symbol	Port size
L8	Top ported elbow with ø8 One-touch fitting
B4	Bottom ported elbow with ø4 One-touch fitting
B6	Bottom ported elbow with ø6 One-touch fitting
B8	Bottom ported elbow with ø8 One-touch fitting
LM (Note 1)	Elbow port, mixed sizes
MM (Note 2)	Mixed size for different types of piping, option installed

Option

Symbol	Option
Nil	None
2	200/220 VAC models (F/L kit only)
B (Note 2)	With back pressure check valve
D	DIN rail mounting
DO	With DIN rail bracket (Without DIN rail)
D□ (Note 5)	DIN rail length specified
K (Note 3)	Special wiring spec. (Except double wiring)
N	With name plate
R (Note 4)	External pilot

- Note 1) When two or more symbols are specified, indicate them alphabetically. Example: -DNR
- Note 2) Models with a suffix "-B" have check valves for prevention of back pressure at all manifold stations. When a back pressure check valve is desired, and is to be installed only in certain manifold stations, specify the mounting position by means of the manifold specification sheet.
- Note 3) Specify the wiring specifications by means of the manifold specification sheet. (Except L kit)
- Note 4) Indicate "R" for the valve with external pilot.
- Note 5) □: Station. Example: D08: The number of stations that may be displayed is longer than the manifold number of stations.

Kit type/Electrical entry/Cable length

<p>F kit (D-sub connector)</p> <p>Note 1) 25P</p> <p>Connector entry direction: Top entry, Side entry</p> <p>P. 523</p> <table border="1"> <tr> <td>U0</td> <td>S0</td> <td>Without cable</td> <td rowspan="3">Note 2) 2 to 24 stations</td> </tr> <tr> <td>F U1</td> <td>F S1</td> <td>With cable (1.5 m)</td> </tr> <tr> <td>U2</td> <td>S2</td> <td>With cable (3 m)</td> </tr> <tr> <td>U3</td> <td>S3</td> <td>With cable (5 m)</td> <td></td> </tr> </table>	U0	S0	Without cable	Note 2) 2 to 24 stations	F U1	F S1	With cable (1.5 m)	U2	S2	With cable (3 m)	U3	S3	With cable (5 m)		<p>P kit (Flat ribbon cable)</p> <p>Note 1) 26P</p> <p>Connector entry direction: Top entry, Side entry</p> <p>P. 527</p> <table border="1"> <tr> <td>U0</td> <td>S0</td> <td>Without cable</td> <td rowspan="3">Note 2) 2 to 24 stations</td> </tr> <tr> <td>P U1</td> <td>P S1</td> <td>With cable (1.5 m)</td> </tr> <tr> <td>U2</td> <td>S2</td> <td>With cable (3 m)</td> </tr> <tr> <td>U3</td> <td>S3</td> <td>With cable (5 m)</td> <td></td> </tr> </table>	U0	S0	Without cable	Note 2) 2 to 24 stations	P U1	P S1	With cable (1.5 m)	U2	S2	With cable (3 m)	U3	S3	With cable (5 m)		<p>J kit (Flat ribbon cable 20P)</p> <p>20P</p> <p>Connector entry direction: Top entry, Side entry</p> <p>P. 531</p> <table border="1"> <tr> <td>U0</td> <td>S0</td> <td>Without cable</td> <td rowspan="3">Note 2) 2 to 16 stations</td> </tr> <tr> <td>J U1</td> <td>J S1</td> <td>With cable (1.5 m)</td> </tr> <tr> <td>U2</td> <td>S2</td> <td>With cable (3 m)</td> </tr> <tr> <td>U3</td> <td>S3</td> <td>With cable (5 m)</td> <td></td> </tr> </table>	U0	S0	Without cable	Note 2) 2 to 16 stations	J U1	J S1	With cable (1.5 m)	U2	S2	With cable (3 m)	U3	S3	With cable (5 m)		<p>G kit (Flat ribbon cable with terminal block)</p> <p>The voltage used for the valve is 24 VDC.</p> <p>P. 535</p> <table border="1"> <tr> <td>U0</td> <td>Without cable</td> <td rowspan="3">Note 2) 2 to 16 stations</td> </tr> <tr> <td>U1</td> <td>With cable (1.5 m)</td> </tr> <tr> <td>U2</td> <td>With cable (3 m)</td> </tr> <tr> <td>U3</td> <td>With cable (5 m)</td> <td></td> </tr> </table>	U0	Without cable	Note 2) 2 to 16 stations	U1	With cable (1.5 m)	U2	With cable (3 m)	U3	With cable (5 m)								
U0	S0	Without cable	Note 2) 2 to 24 stations																																																											
F U1	F S1	With cable (1.5 m)																																																												
U2	S2	With cable (3 m)																																																												
U3	S3	With cable (5 m)																																																												
U0	S0	Without cable	Note 2) 2 to 24 stations																																																											
P U1	P S1	With cable (1.5 m)																																																												
U2	S2	With cable (3 m)																																																												
U3	S3	With cable (5 m)																																																												
U0	S0	Without cable	Note 2) 2 to 16 stations																																																											
J U1	J S1	With cable (1.5 m)																																																												
U2	S2	With cable (3 m)																																																												
U3	S3	With cable (5 m)																																																												
U0	Without cable	Note 2) 2 to 16 stations																																																												
U1	With cable (1.5 m)																																																													
U2	With cable (3 m)																																																													
U3	With cable (5 m)																																																													
<p>T kit (Terminal block box)</p> <p>Dust-tight/Water-jet-proof (IP65) compatible</p> <p>P. 539</p> <table border="1"> <tr> <td>T kit</td> <td>O</td> <td>Terminal block box</td> <td>2 to 20 stations</td> <td>Note 2)</td> </tr> </table>	T kit	O	Terminal block box	2 to 20 stations	Note 2)	<p>L kit (Lead wire)</p> <p>Dust-tight/Water-jet-proof (IP65) compatible</p> <p>P. 543</p> <table border="1"> <tr> <td>L kit</td> <td>0</td> <td>With cable (0.6 m)</td> <td rowspan="2">1 to 8 stations</td> </tr> <tr> <td></td> <td>1</td> <td>With cable (1.5 m)</td> </tr> <tr> <td></td> <td>2</td> <td>With cable (3 m)</td> <td></td> </tr> </table>	L kit	0	With cable (0.6 m)	1 to 8 stations		1	With cable (1.5 m)		2	With cable (3 m)		<p>S kit (Serial transmission)</p> <p>The valve is equipped with an indicator light and surge voltage suppressor, and the voltage is 24 VDC. The dusttight SI unit is available. Refer to page 551 for details. Dust-tight, Water-jet-proof (IP65) is available.</p> <p>Note 4)</p> <p>Note) Refer to "SI Unit Part No." on page 551 when ordering the CE-compliant SI unit.</p> <p>P. 551</p> <table border="1"> <tr> <td>S kit</td> <td>0</td> <td>Without SI unit</td> <td rowspan="8">Max. 8 stations</td> </tr> <tr> <td></td> <td>F1</td> <td>NKE Corp.: Fieldbus System</td> </tr> <tr> <td></td> <td>H</td> <td>NKE Corp.: Fieldbus H System</td> </tr> <tr> <td></td> <td>J1</td> <td>Parasonic Industrial Devices SUNX Co., Ltd.: S-LINK (16 outputs)</td> </tr> <tr> <td></td> <td>J2</td> <td>Parasonic Industrial Devices SUNX Co., Ltd.: S-LINK (8 outputs)</td> </tr> <tr> <td></td> <td>Q</td> <td>DeviceNet™</td> </tr> <tr> <td></td> <td>R1</td> <td>OMRON Corp.: CompoBus/S (16 outputs)</td> </tr> <tr> <td></td> <td>R2</td> <td>OMRON Corp.: CompoBus/S (8 outputs)</td> </tr> <tr> <td></td> <td>V</td> <td>CC-Link</td> <td>Max. 15 stations</td> </tr> </table>	S kit	0	Without SI unit	Max. 8 stations		F1	NKE Corp.: Fieldbus System		H	NKE Corp.: Fieldbus H System		J1	Parasonic Industrial Devices SUNX Co., Ltd.: S-LINK (16 outputs)		J2	Parasonic Industrial Devices SUNX Co., Ltd.: S-LINK (8 outputs)		Q	DeviceNet™		R1	OMRON Corp.: CompoBus/S (16 outputs)		R2	OMRON Corp.: CompoBus/S (8 outputs)		V	CC-Link	Max. 15 stations	<p>M kit (Circular-connector)</p> <p>P. 557</p> <table border="1"> <tr> <td>M kit</td> <td>0</td> <td>Without cable</td> <td rowspan="3">Note 2) 2 to 24 stations</td> </tr> <tr> <td></td> <td>1</td> <td>With cable (1.5 m)</td> </tr> <tr> <td></td> <td>2</td> <td>With cable (3 m)</td> </tr> <tr> <td></td> <td>3</td> <td>With cable (5 m)</td> <td></td> </tr> </table>	M kit	0	Without cable	Note 2) 2 to 24 stations		1	With cable (1.5 m)		2	With cable (3 m)		3	With cable (5 m)	
T kit	O	Terminal block box	2 to 20 stations	Note 2)																																																										
L kit	0	With cable (0.6 m)	1 to 8 stations																																																											
	1	With cable (1.5 m)																																																												
	2	With cable (3 m)																																																												
S kit	0	Without SI unit	Max. 8 stations																																																											
	F1	NKE Corp.: Fieldbus System																																																												
	H	NKE Corp.: Fieldbus H System																																																												
	J1	Parasonic Industrial Devices SUNX Co., Ltd.: S-LINK (16 outputs)																																																												
	J2	Parasonic Industrial Devices SUNX Co., Ltd.: S-LINK (8 outputs)																																																												
	Q	DeviceNet™																																																												
	R1	OMRON Corp.: CompoBus/S (16 outputs)																																																												
	R2	OMRON Corp.: CompoBus/S (8 outputs)																																																												
	V	CC-Link	Max. 15 stations																																																											
M kit	0	Without cable	Note 2) 2 to 24 stations																																																											
	1	With cable (1.5 m)																																																												
	2	With cable (3 m)																																																												
	3	With cable (5 m)																																																												

Note 1) Besides the above, F/P kit with different number of pins are available. Refer to page 561 for details.

Note 2) Refer to page 562 for details.

Note 3) Refer to the pages on respective kits for IP65 type. (T/L/S kit)

Note 4) Serial transmission system with IP65 enclosure applicable to input/output is also available. Refer to page 555 for details.

Note) For CE compliant models, DC-type only. **CE** [Option]

How to Order Valve

How to Order Manifold Assembly

10-VQ **2** **1** **0** **0** - **5** **1** -

Series

2	VQ2000
---	--------

10 Clean series

21	Copper/Fluorine/Silicone free + Low particle generation
----	---

Actuation type

1	2-position single (A/B)	
	2-position double (A/B)	
2	Metal	
	Rubber	
3	3-position closed center (A/B)	
	3-position exhaust center (A/B)	
4	3-position pressure center (A/B)	
	3-position pressure center (A/B)	

Seal

0	Metal seal
1	Rubber seal

CE compliant

Nil	—
Q	CE compliant

Note) For CE compliant models, DC-type only.

Enclosure

Nil	—
W (Note)	Dust-tight/water-jet-proof type (IP65)

Note) T, L, S and M kits only

Light/surge voltage suppressor

Nil	Yes
E (Note)	None

Note) Not applicable to the S kit.

Coil voltage

1	100 VAC (50/60 Hz)	—	CE compliant
2 (Note)	200 VAC (50/60 Hz)	—	—
3	110 VAC (50/60 Hz)	—	—
4 (Note)	220 VAC (50/60 Hz)	—	—
5	24 VDC	●	—
6	12 VDC	●	—

Note) 200 and 220 VAC: F/L kit only

Note) For sub-plate single unit type, refer to page 560.

Function

Symbol	Specifications	DC	AC
Nil	Standard	(0.4 W) ○	○ (Note 1)
B	High-speed response type	(0.95 W) ○	—
K (Note 2)	High-pressure type (1.0 MPa)	(0.95 W) ○	—
N (Note 3)	Negative common	○	—
R (Note 3)	External pilot	○	○

Note 1) For power consumption of AC type, refer to page 522.
 Note 2) Metal seal only
 Note 3) For external pilot and negative common specifications, refer to "Semi-standard" on pages 562 to 563.
 Note 4) When two or more symbols are specified, indicate them alphabetically. Combination of [B] and [K] is not possible.

Manual override

Nil: Non-locking push type (Tool required)	
B: Push-locking slotted type (Tool required)	
C: Locking type (Manual)	
D: Slide locking type (Manual)	

Example

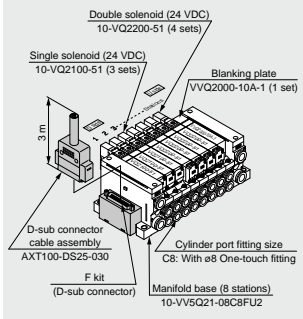

- 10-VV5Q21-08C8FU2 ... 1 set (F kit 8-station manifold base part no.)
 - *10-VQ2100-51 ... 3 sets (Single solenoid part no.)
 - *10-VQ2200-51 ... 4 sets (Double solenoid part no.)
 - *VVQ2000-10A-1 ... 1 set (Blanking plate part no.)
- The asterisk denotes the symbol for assembly. Prefix it to the part no. of the solenoid valve, etc.

Specify the part numbers for valves and options together beneath the manifold base part number. Besides, when the arrangement will be complicated, specify them by means of the manifold specification sheet.

Caution

Use the standard (DC) specification when continuously energizing for long periods of time.

- Directional Control Valves
- Air Cylinders
- Rotary Actuators
- Air Grippers
- Air Preparation Equipment
- Modular F. R.
- Pressure Control Equipment
- Fittings & Tubing
- Flow Control Equipment
- Pressure Switches/Pressure Sensors

10-**VQ1000: Manifold Options**

P. 571 to 572

Blanking plate assembly
VVQ1000-10A-1

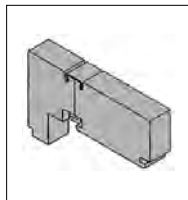

Individual SUP spacer
VVQ1000-P-1-^{C6}_{N7}

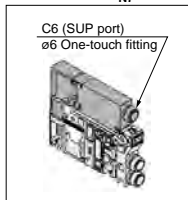

Individual EXH spacer
VVQ1000-R-1-^{C6}_{N7}

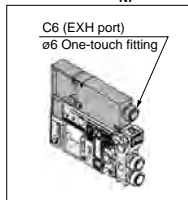

SUP block plate
VVQ1000-16A

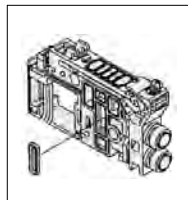

EXH block base assembly
VVQ1000-19A-^{C3, C4}_{C6, M5}
^{P1}_{N7, N3}

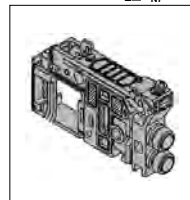

Back pressure check valve
assembly [-B]
VVQ1000-18A



Name plate [-N]
VVQ1000-N-Station
(1 to Max. stations)

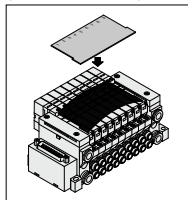

Blanking plug
KQ2P-□

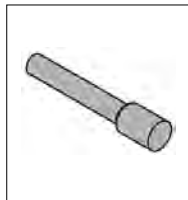

DIN rail mounting bracket
[-D/-D0/-D□]
VVQ1000-57A

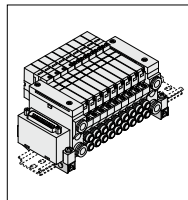

10-**VQ2000: Manifold Options**

P. 573 to 574

Blanking plate assembly
VVQ2000-10A-1

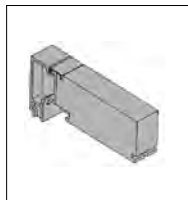

Individual SUP spacer
VVQ2000-P-1-^{C8}_{N9}

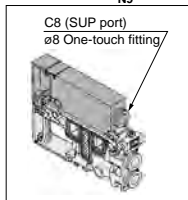

Individual EXH spacer
VVQ2000-R-1-^{C8}_{N9}

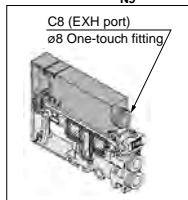

SUP block plate
VVQ2000-16A

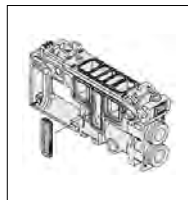

EXH block plate
VVQ2000-19A

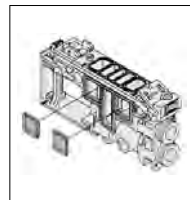

Back pressure check valve
assembly [-B]
VVQ2000-18A



Name plate [-N]
VVQ2000-N-Station
(1 to Max. stations)

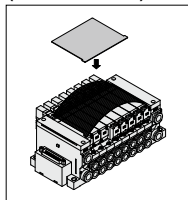

Blanking plug
KQ2P-□

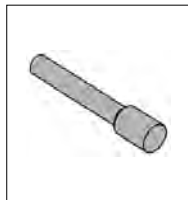

DIN rail mounting bracket
[-D/-D0/-D□]
VVQ2000-57A

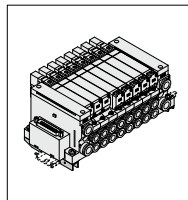

Pressure Switches/
Pressure Sensors

Flow Control
Equipment

Fittings & Tubing

Pressure Control
Equipment

Modular F. R.

Air Preparation
Equipment

Air Grippers

Rotary Actuators

Air Cylinders

Directional
Control Valves

Series ¹⁰⁻₂₁₋VQ1000/2000

Base Mounted
Plug-in Unit

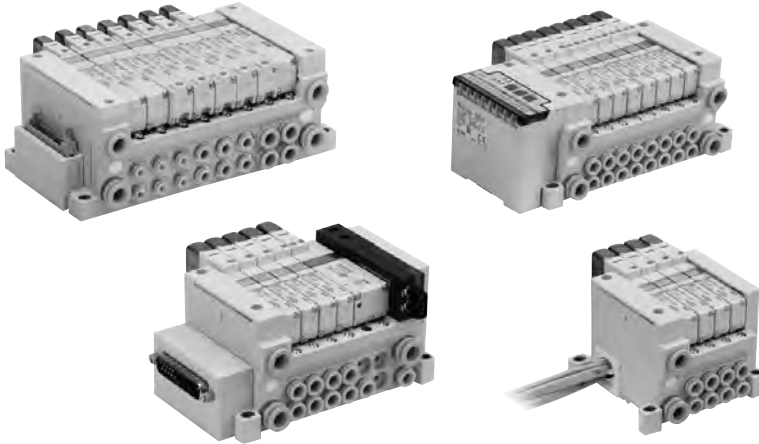

Model

Series	Actuation type	Model	Flow rate characteristics ^{Note 1)}						Response time (ms) ^{Note 2)}			Weight (g)	
			1 → 2/4 (P → A/B)			2/4 → 3/5 (A/B → R1/R2)			Standard: 0.4 W	High-speed response: 0.95 W	AC		
			C [dm ³ /(s·bar)]	b	Cv	C [dm ³ /(s·bar)]	b	Cv					
VQ1000	2-position	Single	Metal seal ¹⁰⁻ ₂₁₋ VQ1100	0.70	0.15	0.16	0.72	0.25	0.18	15 or less	12 or less	29 or less	67
			Rubber seal ¹⁰⁻ ₂₁₋ VQ1101	0.85	0.20	0.21	1.0	0.30	0.25	20 or less	15 or less	34 or less	
		Double	Metal seal ¹⁰⁻ ₂₁₋ VQ1200	0.70	0.15	0.16	0.72	0.25	0.18	13 or less	10 or less	13 or less	
			Rubber seal ¹⁰⁻ ₂₁₋ VQ1201	0.85	0.20	0.21	1.0	0.30	0.25	20 or less	15 or less	20 or less	
	3-position	Closed center	Metal seal ¹⁰⁻ ₂₁₋ VQ1300	0.68	0.15	0.16	0.72	0.25	0.18	26 or less	20 or less	40 or less	77
			Rubber seal ¹⁰⁻ ₂₁₋ VQ1301	0.70	0.20	0.16	0.65	0.42	0.18	33 or less	25 or less	47 or less	
		Exhaust center	Metal seal ¹⁰⁻ ₂₁₋ VQ1400	0.68	0.15	0.16	0.72	0.25	0.18	26 or less	20 or less	40 or less	
			Rubber seal ¹⁰⁻ ₂₁₋ VQ1401	0.70	0.20	0.16	1.0	0.30	0.25	33 or less	25 or less	47 or less	
		Pressure center	Metal seal ¹⁰⁻ ₂₁₋ VQ1500	0.70	0.15	0.16	0.72	0.25	0.18	26 or less	20 or less	40 or less	
			Rubber seal ¹⁰⁻ ₂₁₋ VQ1501	0.85	0.20	0.21	0.65	0.42	0.18	33 or less	25 or less	47 or less	
VQ2000	2-position	Single	Metal seal ¹⁰⁻ ₂₁₋ VQ2100	2.0	0.15	0.46	2.6	0.15	0.60	29 or less	22 or less	49 or less	95
			Rubber seal ¹⁰⁻ ₂₁₋ VQ2101	2.2	0.28	0.55	3.2	0.30	0.80	31 or less	24 or less	51 or less	
		Double	Metal seal ¹⁰⁻ ₂₁₋ VQ2200	2.0	0.15	0.46	2.6	0.15	0.60	20 or less	15 or less	20 or less	
			Rubber seal ¹⁰⁻ ₂₁₋ VQ2201	2.2	0.28	0.55	3.2	0.30	0.80	26 or less	20 or less	26 or less	
	3-position	Closed center	Metal seal ¹⁰⁻ ₂₁₋ VQ2300	2.0	0.15	0.46	2.0	0.18	0.46	38 or less	29 or less	58 or less	105
			Rubber seal ¹⁰⁻ ₂₁₋ VQ2301	2.0	0.28	0.49	2.2	0.31	0.60	44 or less	34 or less	64 or less	
		Exhaust center	Metal seal ¹⁰⁻ ₂₁₋ VQ2400	2.0	0.15	0.46	2.6	0.15	0.60	38 or less	29 or less	58 or less	
			Rubber seal ¹⁰⁻ ₂₁₋ VQ2401	2.0	0.28	0.49	3.2	0.30	0.80	44 or less	34 or less	64 or less	
		Pressure center	Metal seal ¹⁰⁻ ₂₁₋ VQ2500	2.4	0.17	0.57	2.0	0.18	0.46	38 or less	29 or less	58 or less	
			Rubber seal ¹⁰⁻ ₂₁₋ VQ2501	3.2	0.28	0.80	2.2	0.31	0.60	44 or less	34 or less	64 or less	

Note 1) The values are given for port size C6: (10-VQ1000), C8: (10-VQ2000) without back pressure check valve.

Note 2) As per JIS B 8375-1981 (Supply pressure 0.5 MPa; with indicator light/surge voltage suppressor; clean air

The response time is subject to the pressure and quality of the air.) The values at the time of ON are given for double types.

Standard Specifications

Symbol

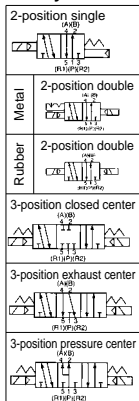

Valve specifications	Valve type	Metal seal	Rubber seal	
	Fluid	Air, Inert gas	Air, Inert gas	
	Maximum operating pressure	0.7 MPa (High-pressure type: 1.0 MPa)	0.7 MPa	
	Minimum operating pressure	Single	0.1 MPa	0.15 MPa
		Double	0.1 MPa	0.1 MPa
		3-position	0.1 MPa	0.2 MPa
		4-position	—	0.15 MPa
	Ambient and fluid temperature	-10 to 50°C (Note 1)		
	Lubrication	Not required		
	Manual override	Push type, Locking type (Tool required, Manual) semi-standard		
Impact/Vibration resistance (Note 2)	150/30 m/s ²			
Enclosure	Dust-protected; Dust-tight, Water-jet-proof (IP65) (Note 4)			
Electrical specifications	Coil rated voltage	12, 24 VDC, 100, 110, 200, 220 VAC (50/60 Hz)		
	Allowable voltage fluctuation	±10% of rated voltage		
	Coil insulation type	Equivalent to Class B		
	Power consumption (Current)	24 VDC	0.4 W DC (17 mA), 0.95 W DC (40 mA) (Note 3)	
		12 VDC	0.4 W DC (34 mA), 0.95 W DC (80 mA) (Note 3)	
		100 VAC	Inrush 0.96 VA (10 mA), Holding 0.96 VA (10 mA)	
		110 VAC	Inrush 1.0 VA (9 mA), Holding 1.0 VA (9 mA)	
		200 VAC	Inrush 1.26 VA (6 mA), Holding 1.26 VA (6 mA)	
		220 VAC	Inrush 1.38 VA (6 mA), Holding 1.38 VA (6 mA)	

Note 1) Use dry air to prevent condensation when operating at low temperatures.
 Note 2) Impact resistance ----- No malfunction occurred when it was tested in the axial direction and at right angles to the main valve and armature in both energized and de-energized states once for each condition. (Default settings)
 Vibration resistance ... No malfunction occurred in a one-sweep test between 45 and 2000 Hz. Test was energized in both energized and de-energized states in the axial direction and at right angles to the main valve and armature. (Default settings)
 Note 3) Value for high-speed response, high-voltage type (0.95 W)
 Note 4) Dust-tight, Water-jet-proof (IP65) is available on T/L/S/M kit of the VQ2000.

Manifold Specifications

Series	Base model	Connection type	Piping specifications		Applicable stations	Applicable solenoid valve	5-station weight (g)
			Piping direction	Port size (Note 1)			
10-21-VQ1000	VV5Q11-□□□	F kit—D-sub connector P kit—Flat ribbon cable J kit—Flat ribbon cable (20P) G kit—Flat ribbon cable with terminal block	Side	1(P), 3(R)	C8 (ø8)	(F/P/T kit) (2 to 24 stations) (J/G/S kit) (2 to 16 stations) (L kit) (1 to 8 stations)	643 (Single) 754 (Double, 3-position)
		T kit—Terminal block box L kit—Lead wire S kit—Serial transmission		4(A), 2(B)	C3 (ø3.2) C4 (ø4) C6 (ø6) M5 (M5 thread)		
10-21-VQ2000	VV5Q21-□□□	F kit—D-sub connector P kit—Flat ribbon cable J kit—Flat ribbon cable (20P) G kit—Flat ribbon cable with terminal block	Side	1(P), 3(R)	C10 (ø10)	(F/P kit) (2 to 24 stations) (J/G/S kit) (2 to 16 stations) (L kit) (1 to 8 stations) (T kit) (2 to 20 stations)	1076 (Single) 1119 (Double, 3-position)
		T kit—Terminal block box L kit—Lead wire S kit—Serial transmission M kit—Circular connector		4(A), 2(B)	C4 (ø4) C6 (ø6) C8 (ø8)		

Note 1) Inch-size One-touch fittings are also available. Refer to page 563 for details.
 Note 2) Refer to page 562 for details.

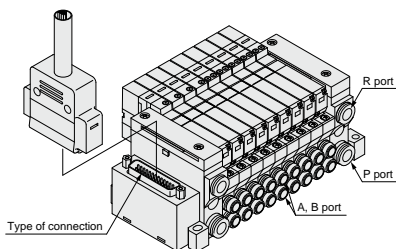

10-21-VV5Q11

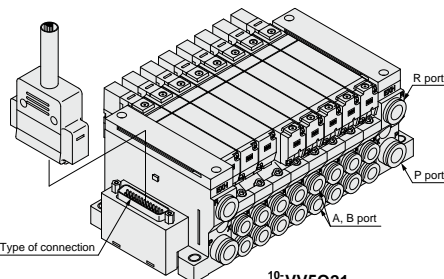

10-21-VV5Q21

Directional Control Valves

Air Cylinders

Rotary Actuators

Air Grippers

Air Preparation Equipment

Modular F. R.

Pressure Control Equipment

Fittings & Tubing

Flow Control Equipment

Pressure Switches/Pressure Sensors

F Series ¹⁰⁻₂₁₋VQ1000/2000 Kit (D-sub connector)

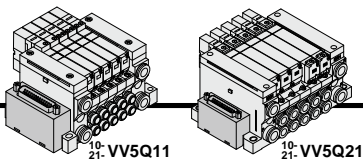

- D-sub connector reduces installation labor for electrical connections.
- Using the D-sub connector (25P), (15P as semi-standard) conforming to MIL standard permits the use of commercial connectors and gives a wide interchangeability.
- Top or side receptacle position can be selected in accordance with the available mounting space.
- Maximum stations are 24.

Manifold Specifications

Series	Piping specifications			Applicable stations
	Piping direction	Port size		
		1(P), 3(R)	4(A), 2(B)	
¹⁰⁻ ₂₁₋ VQ1000	Side	C8	C3, C4, C6, M5	Max. 24 stations
¹⁰⁻ ₂₁₋ VQ2000	Side	C10	C4, C6, C8	Max. 24 stations

D-sub Connector (25 Pins)

Cable Assembly

AXT100-DS25-⁰¹⁵₀₃₀⁰⁵⁰

(The D-sub connector cable assembly can be ordered individually or included in a specific manifold model no. Refer to "How to Order Manifold.")

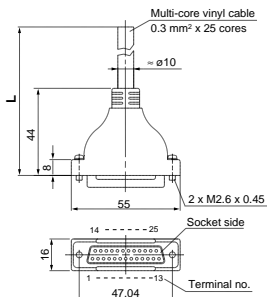

D-sub connector cable assembly

Cable length (L)	Assembly part no.	Note
1.5 m	AXT100-DS25-015	Cable 25 cores x 24AWG
3 m	AXT100-DS25-030	
5 m	AXT100-DS25-050	

● For other commercial connectors, use a 25 pins type with female connector conforming to MIL-C-24308.
● Cannot be used for transfer wiring.

Example of connector manufacturers

- Fujitsu Limited
- Japan Aviation Electronics Industry, Limited
- J.S.T. Mfg. Co., Ltd.
- HIROSE ELECTRIC CO., LTD.

Electrical characteristics

Item	Property
Conductor resistance Ω/km, 20°C	65 or less
Voltage limit V _i , 1 minute, AC	1000
Insulation resistance MΩ/km, 20°C	5 or more

Note) The minimum bending radius of the D-sub connector cable is 20 mm.

Wire color by terminal no. of D-sub connector cable assembly

Terminal no.	Lead wire color	Dot marking
1	Black	None
2	Brown	None
3	Red	None
4	Orange	None
5	Yellow	None
6	Pink	None
7	Blue	None
8	Purple	White
9	Gray	Black
10	White	Black
11	White	Red
12	Yellow	Red
13	Orange	Red
14	Yellow	Black
15	Pink	Black
16	Blue	White
17	Purple	None
18	Gray	None
19	Orange	Black
20	Red	White
21	Brown	White
22	Pink	Red
23	Gray	Red
24	Black	White
25	White	None

Note 1) Types with 15 pins are also available. Refer to page 561 for details.
Note 2) Lengths other than the above are also available. Please contact SMC for details.

How to Order Manifold

Note) For CE compliant models, DC-type only. [Option]

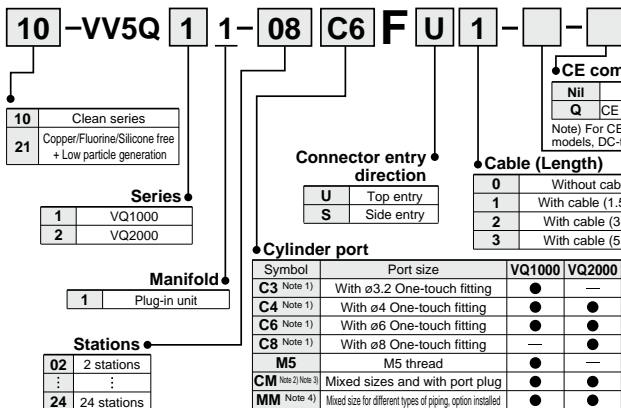

Option

Symbol	Option
Nil	None
2	200/220 VAC models (F/L kit only)
B (Note 2)	With back pressure check valve
D	DIN rail mounting
DO	With DIN rail bracket (Without DIN rail)
D□ (Note 3)	DIN rail length specified (□: Stations 02 to 24)
K (Note 4)	Special wiring specifications (Except double wiring)
N	With name plate
R (Note 5)	External pilot

Note 1) When two or more symbols are specified, indicate them alphabetically. Example) -BNR
Note 2) Models with a suffix "B" have check valves for prevention of back pressure at all manifold stations. When a back pressure check valve is desired, and is to be installed only in certain manifold stations, specify the mounting position by means of the manifold specification sheet.
Note 3) The number of stations that may be displayed is longer than the manifold number of stations.
Note 4) Specify the wiring specifications by means of the manifold specification sheet.
Note 5) Indicate "R" for the valve with external pilot.

Note) Refer to page 562 for details.

Note 1) Insert "L" (Top ported) or "B" (Bottom ported) for elbow type.
Example) B6 (Bottom ported elbow with ø6 One-touch fitting)

Note 2) Indicate "LM" for models with elbow fittings and mixed cylinder port sizes.

Note 3) Indicate "Mixed sizes and with port plug" by means of the manifold specification sheet.

Note 4) When selecting the mixed size for different types of piping, dual flow fitting assembly, or double check block (direct mounting), enter "MM" and give instructions on the manifold specification sheet.

Note 5) Inch-size One-touch fittings are available. Refer to "Semi-standard" on page 563 for details.

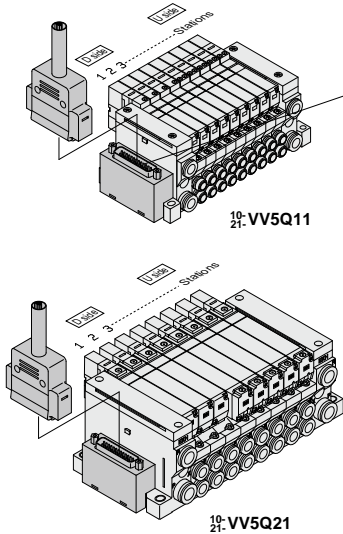

Electrical Wiring Specifications

D-sub connector

D-sub connector assembly
015
AXT100-DS25-030 Wire color
050

Terminal no.	Polarity	Lead wire color	Dot marking
SOL A 1	(-)	(+)	Black None
SOL A 2	(-)	(+)	Yellow Black
SOL A 3	(-)	(+)	Brown None
SOL B 4	(+)	(-)	Pink Black
SOL B 5	(+)	(-)	Red None
SOL B 6	(+)	(-)	Blue White
SOL A 7	(-)	(+)	Orange None
SOL B 8	(-)	(+)	Purple None
SOL A 9	(-)	(+)	Yellow None
SOL B 10	(-)	(+)	Gray None
SOL B 11	(-)	(+)	Black Black
SOL B 12	(-)	(+)	Gray Red
SOL B 13	(-)	(+)	White Red
SOL A 14	(+)	(-)	Black White
SOL A 15	(+)	(-)	Yellow Red
SOL A 16	(+)	(-)	White Red
SOL A 17	(+)	(-)	Black White
SOL A 18	(+)	(-)	Yellow Red
SOL A 19	(+)	(-)	White Red
SOL A 20	(+)	(-)	Black White
SOL A 21	(+)	(-)	Yellow Red
SOL A 22	(+)	(-)	White Red
SOL A 23	(+)	(-)	Black White
SOL A 24	(+)	(-)	Yellow Red
SOL A 25	(+)	(-)	White Red
COM.	13	(-) ^{Note 4}	Orange Red

As the standard electrical wiring specifications, double wiring (connected to SOL.A and SOL.B) is adopted for the internal wiring of each station for 12 stations or less, regardless of valve and option types. Mixed single and double wiring is available as semi-standard. Refer to page 562 for details.

Note) When using the negative common specifications, use valves for negative common. (Refer to page 562.) Refer to "Semi-standard" on page 562 for details.

The total number of stations is tabulated starting from station one on the D-side.

How to Order Valve

10-VQ 1 1 0 0 - 5 - 1 -

Series

1	VQ1000
2	VQ2000

Actuation type

1	2-position single
2	2-position double
3	3-position closed center
4	3-position exhaust center
5	3-position pressure center

Seal

0	Metal seal
1	Rubber seal

Function

Symbol	Specifications	DC	AC
Nil	Standard	(0.4 W)	○ (Note 1)
B	High-speed response type	(0.95 W)	—
K (Note 2)	High-pressure type (1.0 MPa)	(0.95 W)	—
N (Note 3)	Negative common	○	—
R (Note 3)	External pilot	○	○

Note 1) Refer to page 522 for power consumption of AC type.
 Note 2) Metal seal only
 Note 3) For external pilot and negative common specifications, refer to "Semi-standard" on pages 562 to 563.
 Note 4) When two or more symbols are specified, indicate them alphabetically. Combination of [B] and [K] is not possible.

Note) For CE compliant models, DC-type only.



How to Order Manifold Assembly

Specify the part numbers for valves and options together beneath the manifold base part number.

<Example>
 D-sub connector kit with cable (3 m)
 10-VV5Q11-09C6FU2-1 set-Manifold base part no.
 *10-VQ1100-51 2 sets-Valve part no. (Stations 1 to 2)
 *10-VQ1200-51 4 sets-Valve part no. (Stations 3 to 6)
 *10-VQ1300-51 2 sets-Valve part no. (Stations 7 to 8)
 *VVQ1000-10A-1 2 sets-Blanking plate part no. (Station 9)

Prefix the asterisk to the part no. of the solenoid valve, etc.

Write sequentially from the 1st station on the D-side. When part no. written collectively are complicated, specify them by means of the manifold specification sheet.

Manual override

Nil	Non-locking push type (Tool required)
B	Locking type (Tool required)
C	Locking type (Manual)
D	Slide locking type (Manual)

Light/surge voltage suppressor

Nil	Yes
E	None

Coil voltage

	CE compliant	
1	100 VAC (50/60 Hz)	—
2	200 VAC (50/60 Hz)	—
3	110 VAC (50/60 Hz)	—
4	220 VAC (50/60 Hz)	—
5	24 VDC	●
6	12 VDC	●

Caution

Use the standard (DC) specification when continuously energizing for long periods of time.



Directional Control Valves

Air Cylinders

Rotary Actuators

Air Grippers

Air Preparation Equipment

Modular F. R.

Pressure Control Equipment

Fittings & Tubing

Flow Control Equipment

Pressure Switches/Pressure Sensors

F Series ¹⁰⁻₂₁₋VQ1000/2000 kit (D-sub connector)

10- 21-VV5Q11

< >: AC

The dashed lines indicate the DIN rail mounting [-D] and the side entry connection [-FS].

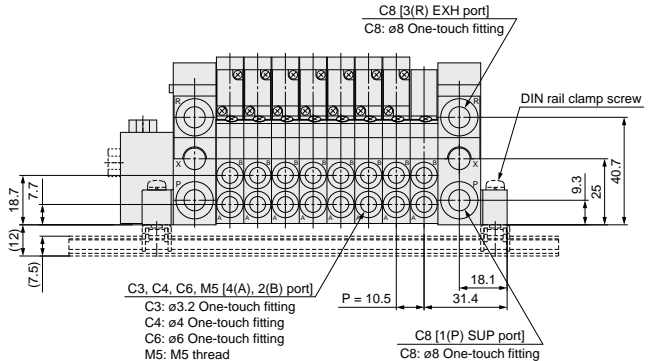
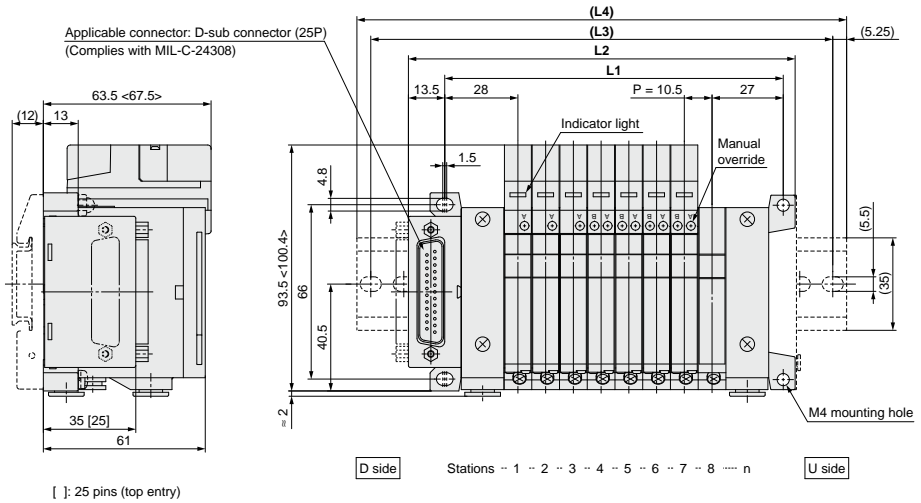

Dimensions

Formula L1 = 10.5n + 44.5, L2 = 10.5n + 62.5 n: Station (Maximum 24 stations)

L	n	2	3	4	5	6	7	8	9	10	11	12	13	14	15	16	17	18	19	20	21	22	23	24
L1		65.5	76	86.5	97	107.5	118	128.5	139	149.5	160	170.5	181	191.5	202	212.5	223	233.5	244	254.5	265	275.5	286	296.5
L2		83.5	94	104.5	115	125.5	136	146.5	157	167.5	178	188.5	199	209.5	220	230.5	241	251.5	262	272.5	283	293.5	304	314.5
(L3)		112.5	125	125	137.5	150	162.5	175	187.5	187.5	200	212.5	225	237.5	250	250	262.5	275	287.5	300	312.5	325	325	337.5
(L4)		123	135.5	135.5	148	160.5	173	185.5	198	198	210.5	223	235.5	248	260.5	260.5	273	285.5	298	310.5	323	335.5	335.5	348

With ejector unit: Formula L1 = 10.5n + 28.7 + (Number of ejector units x 26.7)
L2 = 10.5n + 46.3 + (Number of ejector units x 26.7)
L4 is L2 plus about 30.

10-21-VV5Q21

< >: AC
The dashed lines indicate the DIN rail mounting [-D] and the side entry connection [-FS].

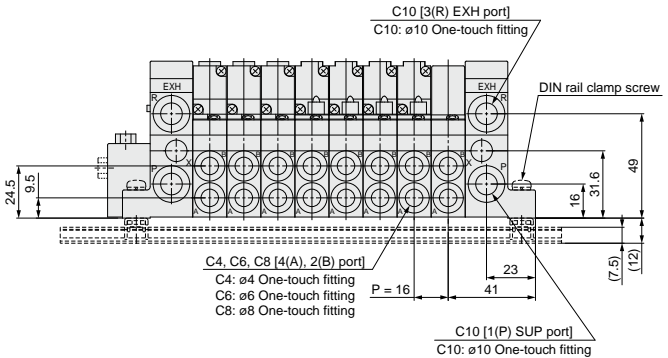
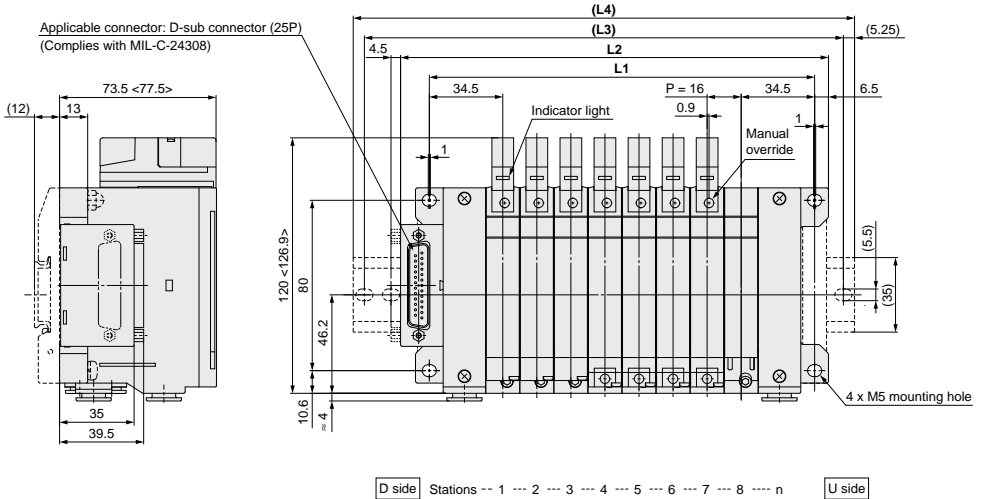

Dimensions

Formula L1 = 16n + 53, L2 = 16n + 73 n: Station (Maximum 24 stations)

L	n	2	3	4	5	6	7	8	9	10	11	12	13	14	15	16	17	18	19	20	21	22	23	24
L1	85	101	117	133	149	165	181	197	213	229	245	261	277	293	309	325	341	357	373	389	405	421	437	453
L2	105	121	137	153	169	185	201	217	233	249	265	281	297	313	329	345	361	377	393	409	425	441	457	473
(L3)	137.5	150	162.5	187.5	200	212.5	225	250	262.5	275	300	312.5	325	337.5	350	375	387.5	400	412.5	437.5	450	462.5	487.5	500
(L4)	148	160.5	173	198	210.5	223	235.5	260.5	273	285.5	310.5	323	335.5	348	360.5	385.5	398	410.5	423	448	460.5	473	498	510.5

P Series ¹⁰⁻₂₁₋VQ1000/2000 kit (Flat ribbon cable)

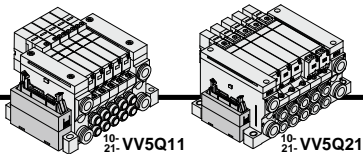

- MIL flat ribbon cable connector reduces installation labor for electrical connection.
- Using the connector for flat ribbon cable (26P) conforming to MIL standard permits the use of commercial connectors and gives a wide interchangeability.
- Top or side receptacle position can be selected in accordance with the available mounting space.
- Maximum stations are 24.

Manifold Specifications

Series	Piping specifications		Applicable stations
	Piping direction	Port size	
10-21: VQ1000	Side	C8 C3, C4, C6, M5	Max. 24 stations
10-21: VQ2000	Side	C10 C4, C6, C8	Max. 24 stations

Flat Ribbon Cable (26 Pins)

AXT100-FC26-¹₃
 (Flat ribbon cable connector assembly can be ordered individually or included in a specific manifold model no. Refer to "How to Order Manifold.")

Flat Ribbon Cable Connector Assembly

Cable length (L)	Assembly part no.	Note
1.5 m	AXT100-FC26-1	Cable 26 cores x 28AWG
3 m	AXT100-FC26-2	
5 m	AXT100-FC26-3	

* For other commercial connectors, use a 26 pins type with strain relief conforming to MIL-C-83503.
 * Cannot be used for transfer wiring.

Connector manufacturers' example

• HIROSE ELECTRIC CO., LTD.	• Fujitsu Limited	• J.S.T. Mfg. Co., Ltd.
• 3M Japan Limited	• Japan Aviation Electronics Industry, Limited	• Oki Electric Cable Co., Ltd.

Note 1) Other than the above model, 10P, 16P, 20P are also available. Refer to page 561 for details.
 Note 2) Lengths other than the above are also available. Please contact SMC for details.

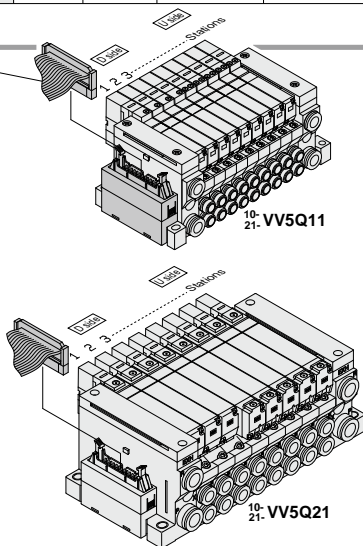

The total number of stations is tabulated starting from one on the D-side.

How to Order Manifold

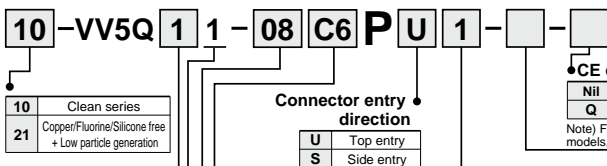

Note) For CE compliant models, DC-type only. [Option]

Option

Symbol	Option
NII	None
B	With back pressure check valve
D	DIN rail mounting
D0	With DIN rail bracket (Without DIN rail)
D□	DIN rail length specified (□: Stations 02 to 24)
K	Special wiring specifications (Except double wiring)
N	With name plate
R	External pilot

- Note 1) When two or more symbols are specified, indicate them alphabetically. Example) -BNR
- Note 2) Models with a suffix "B" have check valves for prevention of back pressure at all manifold stations. When a back pressure check valve is desired, and is to be installed only in certain manifold stations, specify the mounting position by means of the manifold specification sheet.
- Note 3) The number of stations that may be displayed is longer than the manifold number of stations.
- Note 4) Specify the wiring specifications by means of the manifold specification sheet.
- Note 5) Indicate "R" for the valve with external pilot.

Note) Refer to page 562 for details.

- Note 1) Insert "L" (Top ported) or "B" (Bottom ported) for elbow type. Example) 06 (Bottom ported elbow with ø6 One-touch fitting)
- Note 2) Indicate "LM" for models with elbow fittings and mixed cylinder port sizes.
- Note 3) Indicate "Mixed sizes and with port plug" by means of the manifold specification sheet.
- Note 4) When selecting the mixed size for different types of piping, dual flow fitting assembly, or double check block (direct mounting), enter "MM" and give instructions on the manifold specification sheet.
- Note 5) Inch-size One-touch fittings are available. Refer to "Semi-standard" on page 563 for details.

● **Electrical Wiring Specifications**

Flat ribbon cable connector

Terminal no.	Terminal no.	Polarity
SOLA 1	1	(-)
SOLB 2	2	(-)
SOLA 3	3	(-)
SOLB 4	4	(-)
SOLA 5	5	(-)
SOLB 6	6	(-)
SOLA 7	7	(-)
SOLB 8	8	(-)
SOLA 9	9	(-)
SOLB 10	10	(-)
SOLA 11	11	(-)
SOLB 12	12	(-)
SOLA 13	13	(-)
SOLB 14	14	(-)
SOLA 15	15	(-)
SOLB 16	16	(-)
SOLA 17	17	(-)
SOLB 18	18	(-)
SOLA 19	19	(-)
SOLB 20	20	(-)
SOLA 21	21	(-)
SOLB 22	22	(-)
SOLA 23	23	(-)
SOLB 24	24	(-)
COM.	25	(+)
COM.	26	(+)

Electrical wiring specifications

Positive COM spec. Negative COM spec. (Note)

As the standard electrical wiring specifications, double wiring (connected to SOLA and SOLB) is adopted for the internal wiring of each station for 12 stations or less, regardless of valve and option types. Mixed single and double wiring is available as semi-standard. Refer to page 562 for details.

Note) When using the negative common specifications, use valves for negative common. (Refer to page 562.) Refer to "Semi-standard" on page 562 for details.

How to Order Valve

Note) For CE compliant models, DC-type only. **CE** [Option]

10-VQ 1 1 0 0 - 5 - 1 -

Series

1	VQ1000
2	VQ2000

10 Clean series

21 Copper/Fluorine/Silicone free + Low particulate generation

Actuation type

1	2-position single
2	2-position double
3	3-position closed center
4	3-position exhaust center
5	3-position pressure center

Seal

0	Metal seal
1	Rubber seal

Function

Symbol	Specifications	DC	AC
Nil	Standard	(0.4 W) ○	(Note 1) ○
B	High-speed response type	(0.95 W) ○	—
K <small>Note 2)</small>	High-pressure type (1.0 MPa)	(0.95 W) ○	—
N <small>Note 3)</small>	Negative common	○	—
R <small>Note 3)</small>	External pilot	○	○

CE compliant

Nil	—
Q	CE compliant

Note) For CE compliant models, DC-type only.

Manual override

Nil	Non-locking push type (Tool required)
B	Locking type (Tool required)
C	Locking type (Manual)
D	Slide locking type (Manual)

Light/surge voltage suppressor

Nil	Yes
E	None

Coil voltage CE compliant

1	100 VAC (50/60 Hz)	—
3	110 VAC (50/60 Hz)	—
5	24 VDC	●
6	12 VDC	●

Note 1) Refer to page 522 for power consumption of AC type.
 Note 2) Metal seal only.
 Note 3) Refer to "Semi-standard" on pages 562 to 563 for external pilot and negative common specifications.
 Note 4) When two or more symbols are specified, indicate them alphabetically. Combination of [B] and [K] is not possible.

How to Order Manifold Assembly

Specify the part numbers for valves and options together beneath the manifold base part number.

<Example>
 Flat ribbon cable kit with cable (3 m)
 10-VV5Q11-09C6PU2-1 set—Manifold base part no.
 *10-VQ1100-51 2 sets—Valve part no. (Stations 1 to 2)
 *10-VQ1200-51 4 sets—Valve part no. (Stations 3 to 6)
 *10-VQ1300-51 2 sets—Valve part no. (Stations 7 to 8)
 *VVQ1000-10A-1 1 set—Blanking plate part no. (Station 9)

Prefix the asterisk to the part no. of the solenoid valve, etc.

Write sequentially from the 1st station on the D-side. When part no. written collectively are complicated, specify them by means of the manifold specification sheet.

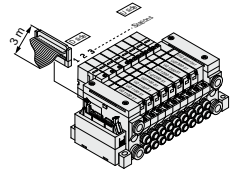

Caution
 Use the standard (DC) specification when continuously energizing for long periods of time.

P Series ¹⁰⁻21-VQ1000/2000 kit (Flat ribbon cable)

10- 21-VV5Q11

< >: AC

The dashed lines indicate the DIN rail mounting [-D] and the side entry connection [-PS].

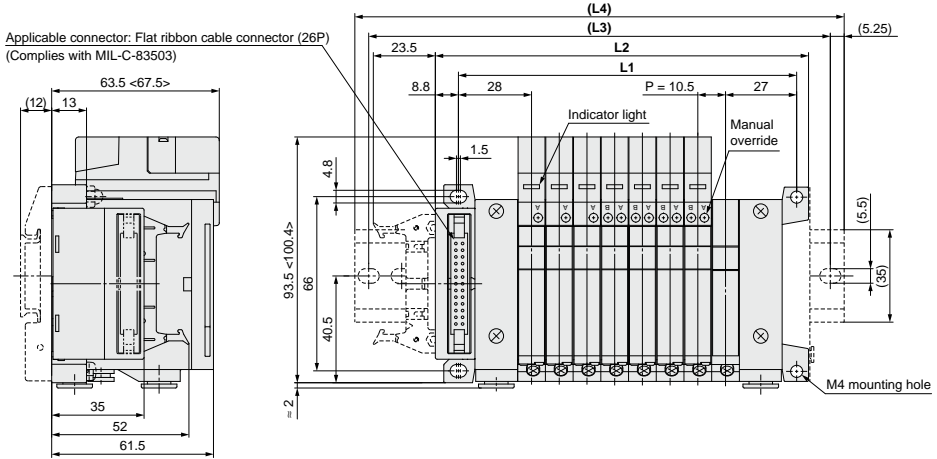

D side

Stations .. 1 .. 2 .. 3 .. 4 .. 5 .. 6 .. 7 .. 8 .. n

U side

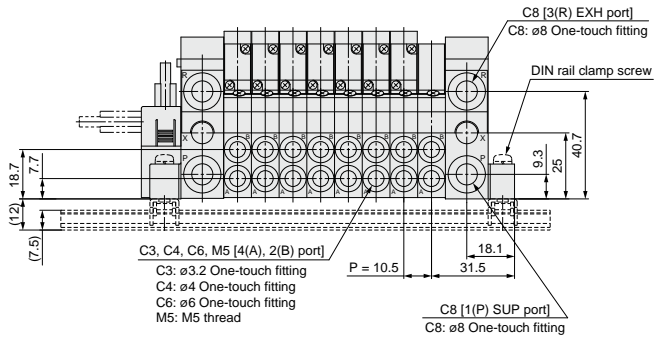

Dimensions

Formula L1 = 10.5n + 44.5, L2 = 10.5n + 57.5 n: Station (Maximum 24 stations)

L	n	2	3	4	5	6	7	8	9	10	11	12	13	14	15	16	17	18	19	20	21	22	23	24
L1		65.5	76	86.5	97	107.5	118	128.5	139	149.5	160	170.5	181	191.5	202	212.5	223	233.5	244	254.5	265	275.5	286	296.5
L2		78.5	89	99.5	110	120.5	131	141.5	152	162.5	173	183.5	194	204.5	215	225.5	236	246.5	257	267.5	278	288.5	299	309.5
(L3)		112.5	125	125	137.5	150	162.5	175	187.5	187.5	200	212.5	225	225	237.5	250	262.5	275	287.5	287.5	300	312.5	325	337.5
(L4)		123	135.5	135.5	148	160.5	173	185.5	198	198	210.5	223	235.5	235.5	248	260.5	273	285.5	298	298	310.5	323	335.5	348

With ejector unit: Formula L1 = 10.5n + 28.7 + (Number of ejector units x 26.7)

L2 = 10.5n + 41.3 + (Number of ejector units x 26.7)

L4 is L2 plus about 30.

J Series 10-21-VQ1000/2000 kit (Flat ribbon cable)

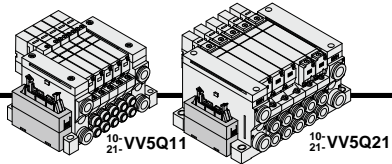

- MIL flat ribbon cable connector reduces installation labor for electrical connection.
- Using the connector for flat ribbon cable connectors (20P) conforming to MIL standard permits the use of connector put on the market and gives a wide interchangeability.
- Top or side receptacle position can be selected in accordance with the available mounting space.
- Maximum stations are 16.

Manifold Specifications

Series	Piping specifications			Applicable stations
	Piping direction	Port size		
10-21-VQ1000	Side	1 (P), 3 (R)	4 (A), 2 (B)	Max. 16 stations
10-21-VQ2000	Side	C10	C4, C6, C8	Max. 16 stations

Flat Ribbon Cable (20 Pins)

AXT100-FC20-1
 (Flat ribbon cable connector assembly can be ordered individually or included in a specific manifold model no. Refer to "How to Order Manifold.")

Flat Ribbon Cable Connector Assembly

Cable length (L)	Assembly part no.	Note
1.5 m	AXT100-FC20-1	Cable 20 cores x 28AWG
3 m	AXT100-FC20-2	
5 m	AXT100-FC20-3	

* For other commercial connectors, use a 20 pins with strain relief conforming to MIL-C-83503.
 * Cannot be used for transfer wiring.

Example of connector manufacturers

- HIROSE ELECTRIC CO., LTD.
- Japan Aviation Electronics Industry, Limited
- 3M Japan Limited
- J.S.T. Mfg. Co., Ltd.
- Fujitsu Limited
- Okl Electric Cable Co., Ltd.

(Note) Lengths other than the above are also available. Please contact SMC for details.

Cable Assembly

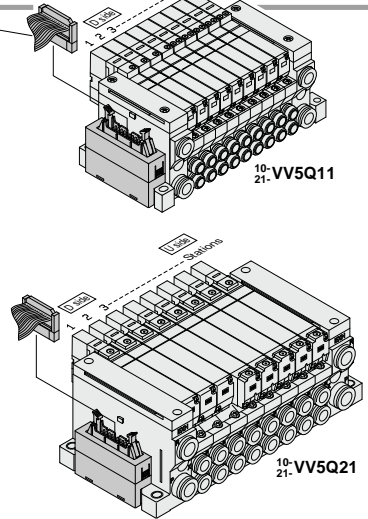

The total number of stations is tabulated starting from one on the D-side.



How to Order Manifold

10 - VV5Q 1 1 - 08 C6 J U 1 - - -

10 Clean series
21 Copper/Fluorine/Silicone free + Low particle generation

Series
1 VQ1000
2 VQ2000

Manifold
1 Plug-in unit

Stations
02 2 stations
16 16 stations

Connector entry direction
U Top entry
S Side entry

CE compliant
NII —
Q CE compliant

Cable (Length)
0 Without cable
1 With cable (1.5 m)
2 With cable (3 m)
3 With cable (5 m)

Cylinder port

Symbol	Port size	VQ1000	VQ2000
C3 (Note 1)	With ø3.2 One-touch fitting	●	—
C4 (Note 1)	With ø4 One-touch fitting	●	●
C6 (Note 1)	With ø6 One-touch fitting	—	●
C8 (Note 1)	With ø8 One-touch fitting	—	●
M5	M5 thread	●	—
CM (Note 2, Note 3)	Mixed sizes and with port plug	●	●
MM (Note 4)	Mixed size for different types of piping, option installed	●	●

Option

Symbol	Option
NII	None
B (Note 2)	With back pressure check valve
D0	DIN rail mounting
D0	With DIN rail bracket (Without DIN rail)
D□ (Note 3)	DIN rail length specified (□ Stations 02 to 16)
K (Note 4)	Special wiring specifications (Except double wiring)
N	With name plate
R (Note 5)	External pilot

- Note 1) When two or more symbols are specified, indicate them alphabetically. Example) -BNR
 Note 2) Models with a suffix "B" have check valves for prevention of back pressure at all manifold stations. When a back pressure check valve is desired, and is to be installed only in certain manifold stations, specify the mounting position by means of the manifold specification sheet.
 Note 3) The number of stations that may be displayed is longer than the manifold number of stations.
 Note 4) Specify the wiring specifications by means of the manifold specification sheet.
 Note 5) Indicate "R" for the valve with external pilot.

(Note) Refer to page 562 for details.

- Note 1) Insert "L" (Top ported) or "B" (Bottom ported) for elbow type.
 Example) B6 (Bottom ported elbow with ø6 One-touch fitting)
 Note 2) Indicate "LM" for models with elbow fittings and mixed cylinder port sizes.
 Note 3) Indicate "Mixed sizes and with port plug" by means of the manifold specification sheet.
 Note 4) When selecting the mixed size for different types of piping, dual flow fitting assembly, or double check block (direct mounting), enter "MM" and give instructions on the manifold specification sheet.
 Note 5) Inch-size One-touch fittings are available. Refer to "Semi-standard" on page 563 for details.

● Electrical Wiring Specifications

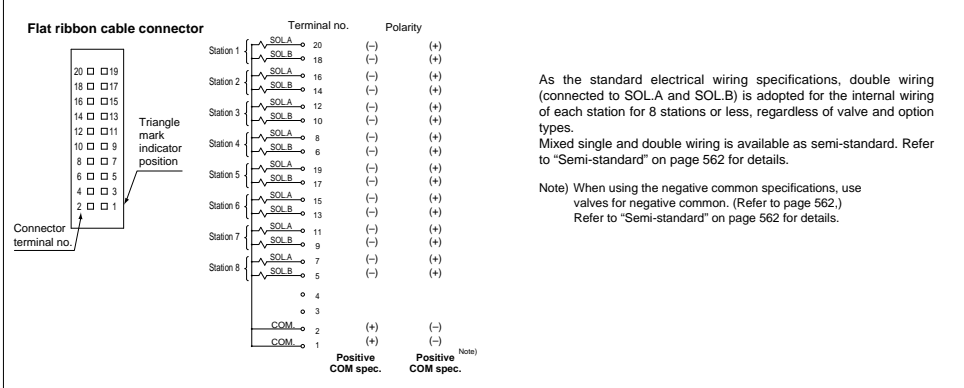

How to Order Valve

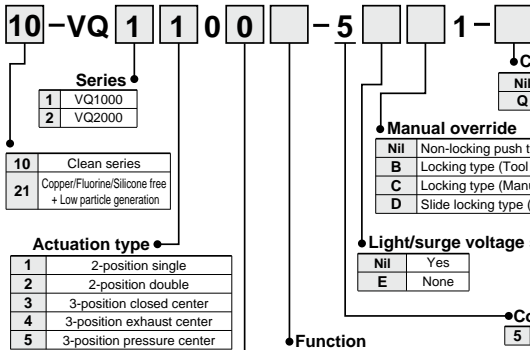

How to Order Manifold Assembly

Specify the part numbers for valves and options together beneath the manifold base part number.

<Example>
 Flat ribbon cable kit with cable (3 m)
 10-VV5Q11-08C6JU2-1 set-Manifold base part no.
 *10-VQ1100-51 2 sets-Valve part no. (Stations 1 to 2)
 *10-VQ1200-51 4 sets-Valve part no. (Stations 3 to 6)
 *10-VQ1300-51 1 set-Valve part no. (Station 7)
 *VVQ1000-10A-1 1 set-Blanking plate part no. (Station 8)

Write sequentially from the 1st station on the D-side. When part no. written collectively are complicated, specify them by means of the manifold specification sheet.

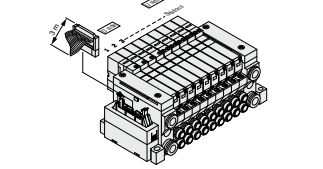



Series 10-21-VQ1000/2000 kit (Flat ribbon cable with terminal block)

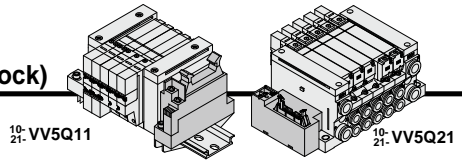

- Terminal block for power supply equipped with a 20 pins flat ribbon cable connection for rationalized connection of valves.
- Solenoid valves and power supply can be connected by the same cable to a specific output unit that requires power supply from the output section to the internal circuit.
- Maximum stations are 16.

Manifold Specifications

Series	Piping specifications			Applicable stations
	Piping direction	Port size		
10-21-VQ1000	Side	1(P), 3(R) C8	4(A), 2(B) C3, C4, C6, M5	Max. 16 stations
10-21-VQ2000	Side	C10	C4, C6, C8	Max. 16 stations

Flat Ribbon Cable (20 Pins)

Cable Assembly

AXT100-FC20-1
3

(Flat ribbon cable connector assembly can be ordered individually or included in a specific manifold model no. Refer to "How to Order Manifold.")

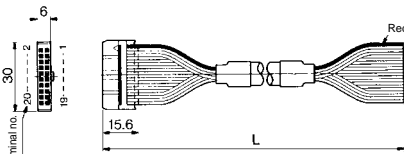

Flat Ribbon Cable Connector Assembly

Cable length (L)	Assembly part no.	Note
1.5 m	AXT100-FC20-1	Cable 20 cores x 28AWG
3 m	AXT100-FC20-2	
5 m	AXT100-FC20-3	

- * For other commercial connectors, use a 20 pins type with strain relief conforming to MIL-C-83503.
- * Cannot be used for transfer wiring.

Example of connector manufacturers

- HIROSE ELECTRIC CO., LTD.
- Japan Aviation Electronics Industry, Limited
- 3M Japan Limited
- Oki Electric Cable Co., Ltd.
- Fujitsu Limited
- J.S.T. Mfg. Co., Ltd.

Note) Lengths other than the above are also available. Please contact SMC for details.

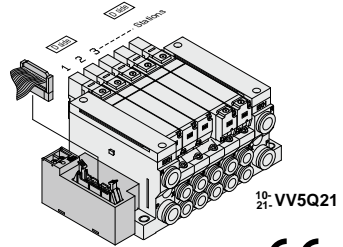
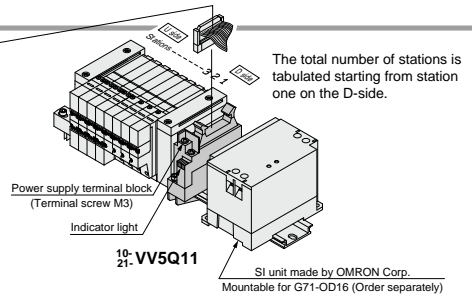

How to Order Manifold

10 - VV5Q 1 1 - 08 C6 G

Series

1	VQ1000
2	VQ2000

10 Clean series

21 Copper/Fluorine/Silicone free + Low particle generation

Manifold

1	Plug-in unit
---	--------------

Stations

02	2 stations
⋮	⋮
16 (Note)	16 stations

Note) Refer to page 562 for details.

Connector entry direction, Top entry

Nil	VQ1000
U	VQ2000

Cable (Length)

0	Without cable
1	Cable length 1.5 m
2	Cable length 3 m
3	Cable length 5 m

Cylinder port

Symbol	Port size	VQ1000/VQ2000
C3 (Note 1)	With ø3.2 One-touch fitting	● —
C4 (Note 1)	With ø4 One-touch fitting	● ●
C6 (Note 1)	With ø6 One-touch fitting	● ●
C8 (Note 1)	With ø8 One-touch fitting	— ●
M5	M5 thread	● —
CM (Note 2)	Mixed sizes and with port plug	● ●
MM (Note 3)	Mixed size for different types of piping, option installed	● ●

Note 1) Insert "L" (Top ported) or "B" (Bottom ported) for elbow type.

Example) B6 (Bottom ported elbow with ø6 One-touch fitting)

Note 2) Indicate "LM" for models with elbow fittings and mixed cylinder port sizes.

Note 3) Indicate "Mixed sizes and with port plug" by means of the manifold specification sheet.

Note 4) When selecting the mixed size for different types of piping, dual flow fitting assembly, or double check block (direct mounting), enter "MM" and give instructions on the manifold specification sheet.

Note 5) Inch-size One-touch fittings are available. Refer to "Semi-standard" on page 563 for details.

CE compliant

Nil	—
Q	CE compliant

Option

Symbol	Option
Nil	None
B (Note 2)	With back pressure check valve
D	DIN rail mounting
D0	With DIN rail bracket (Without DIN rail)
D1 (Note 3)	DIN rail length specified (□: Stations 02 to 16)
K (Note 4)	Special wiring specifications (Except double wiring)
N	With name plate
R (Note 5)	External pilot

Note 1) When two or more symbols are specified, indicate them alphabetically. Example) -BNR

Note 2) Models with a suffix "B" have check valves for prevention of back pressure at all manifold stations. When a back pressure check valve is desired, and is to be installed only in certain manifold stations, specify the mounting position by means of the manifold specification sheet.

Note 3) The number of stations that may be displayed is longer than the manifold number of stations.

Note 4) Specify the wiring specifications by means of the manifold specification sheet.

Note 5) Indicate "R" for the valve with external pilot.



Directional Control Valves

Air Cylinders

Rotary Actuators

Air Grippers

Air Preparation Equipment

Modular F. R.

Pressure Control Equipment

Fittings & Tubing

Flow Control Equipment

Pressure Switches/ Pressure Sensors

• Connector Assembly

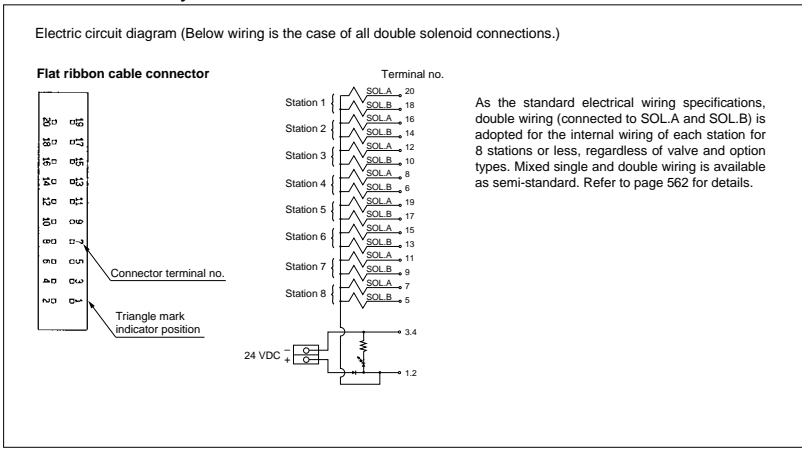

How to Order Valve

10-VQ 1 1 0 0 - 5 - 1 -

Series

1	VQ1000
2	VQ2000

Seal

0	Metal seal
1	Rubber seal

Coil voltage

5	24 VDC
---	--------

Function

Symbol	Specifications	DC
Nil	Standard	(0.4 W)
B	High-speed response type	(0.95 W)
K ^{Note 1)}	High-pressure type (1.0 MPa)	(0.95 W)
R ^{Note 2)}	External pilot	

Manual override

Nil	Non-locking push type (Tool required)
B	Locking type (Tool required)
C	Locking type (Manual)
D	Slide locking type (Manual)

Light/surge voltage suppressor

Nil	Yes
E	None

CE compliant

Nil	—
Q	CE compliant

How to Order Manifold Assembly

Specify the part numbers for valves and options together beneath the manifold base part number.

<Example>
 Flat ribbon cable kit with terminal block with cable (3 m)
 10-VV5Q11-08C62 ... 1 set—Manifold base part no.
 *10-VQ1100-51 ... 4 sets—Valve part no. (Stations 1 to 4)
 *10-VQ1200-51 ... 1 set—Valve part no. (Station 5)
 *10-VQ1300-51 ... 3 sets—Valve part no. (Stations 6 to 8)

Write sequentially from the 1st station on the D-side. When part no. written collectively are complicated, specify them by means of the manifold specification sheet.

Prefix the asterisk to the part no. of the solenoid valve, etc.

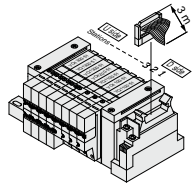



Series 10-21-VQ1000/2000 kit (Flat ribbon cable with terminal block)

10-21-VV5Q11

The dashed lines and dimensions in parentheses indicate DIN rail mounting [-D].

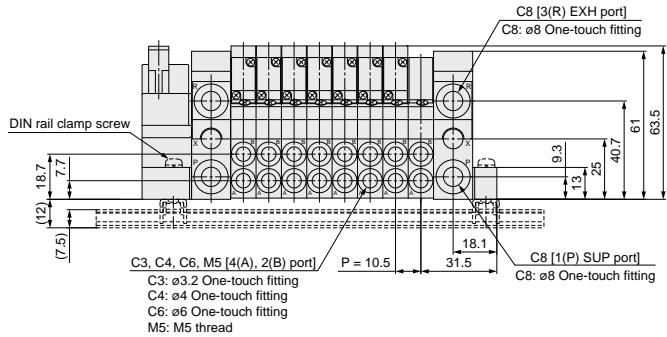
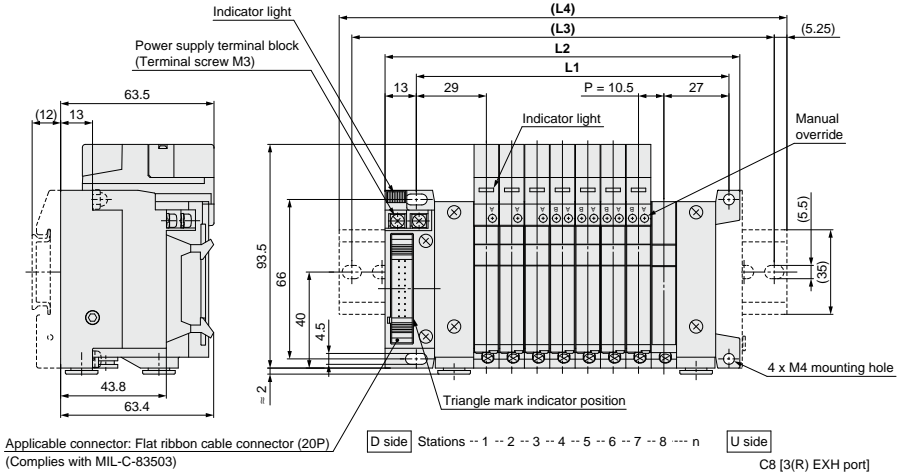

Dimensions

Formula $L1 = 10.5n + 45.5$, $L2 = 10.5n + 63$ n: Station (Maximum 16 stations)

L	n	2	3	4	5	6	7	8	9	10	11	12	13	14	15	16
L1		66.5	77	87.5	98	108.5	119	129.5	140	150.5	161	171.5	182	192.5	203	213.5
L2		84	94.5	105	115.5	126	136.5	147	157.5	168	178.5	189	199.5	210	220.5	231
(L3)		112.5	125	125	137.5	150	162.5	175	187.5	187.5	200	212.5	225	237.5	250	262.5
(L4)		123	135.5	135.5	148	160.5	173	185.5	198	198	210.5	223	235.5	248	260.5	273

With ejector unit: Formula $L1 = 10.5n + 29.7 + (\text{Number of ejector units} \times 26.7)$

$L2 = 10.5n + 46.8 + (\text{Number of ejector units} \times 26.7)$

L4 is L2 plus about 30.

T Series 10-21-VQ1000/2000 kit (Terminal block box)

IP65 compliant

- This kit has a small terminal block inside a junction box. The electrical entry port (10-21-VQ1000: G 1/2, 10-21-VQ2000: G 3/4) permits connection of conduit fittings.
- Maximum stations: 24 (10-21-VQ1000), 20 (10-21-VQ2000)
- Enclosure: Dust-tight, Water-jet-proof (IP65) compatible (Series VQ2000)

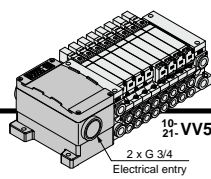
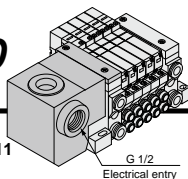

Manifold Specifications

Series	Piping direction	Piping specifications			Applicable stations
		Port size			
10-21-VQ1000	Side	C8	C3, C4, C6, M5	Max. 24 stations	
10-21-VQ2000	Side	C10	C4, C6, C8	Max. 20 stations	

Terminal Block Connection (10-21-VQ1000)

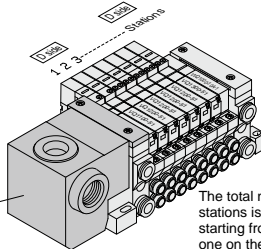

The total number of stations is tabulated starting from station one on the D-side.

Open the terminal block cover to connect the wires to the terminal block.

Step 1. Removing the terminal block cover

Loosen the screws on the terminal block cover and open it in the direction shown by the arrow. The cover can then be removed from the terminal block.

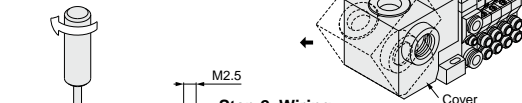

Step 2. Wiring

The diagram on the left shows the terminal block wiring schematic. All stations are provided with double solenoid wiring. Insert each lead wire into the terminal opening and tighten the screw directly above.

How to connect is inserting the lead wire into the terminal window, then tighten the screw on the top. (Tightening torque: 0.25 to 0.35 N-m)

Step 3. Mounting the terminal block cover

Hook groove (a) on shaft (b) and close the cover. Then tighten the screws.
• Drip proof plug assembly (for G 1/2): AXT100-B04A

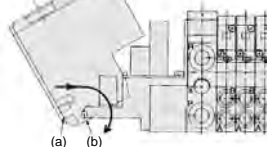

Electrical Wiring Specifications: 10-21-VQ1000

Terminal no.	Polarity
COM	COM (+)
SOLA 1A	(-)
SOLA 1B	(+)
SOLA 2A	(-)
SOLA 2B	(+)
SOLA 3A	(-)
SOLA 3B	(+)
SOLA 4A	(-)
SOLA 4B	(+)
SOLA 5A	(-)
SOLA 5B	(+)
SOLA 6A	(-)
SOLA 6B	(+)
SOLA 7A	(-)
SOLA 7B	(+)
SOLA 8A	(-)
SOLA 8B	(+)
SOLA 9A	(-)
SOLA 9B	(+)
SOLA 10A	(-)
SOLA 10B	(+)
SOLA 11A	(-)
SOLA 11B	(+)
SOLA 12A	(-)
SOLA 12B	(+)
COM	COM (+)

The quantity of terminal blocks used depends on the number of manifold stations.

Manifold	Terminal block
2 to 8 stations	2 rows
9 to 12 stations	3 rows

As the standard electrical wiring specifications, double wiring (connected to SOLA and SOLB) is adopted for the internal wiring of each station for 12 stations or less, regardless of valve and option types. Mixed single and double wiring is available as semi-standard. Refer to page 562 for details.

Note) When using the negative common specifications, use valves for negative common. Refer to "Semi-standard" on page 562 for details.

How to Order Manifold

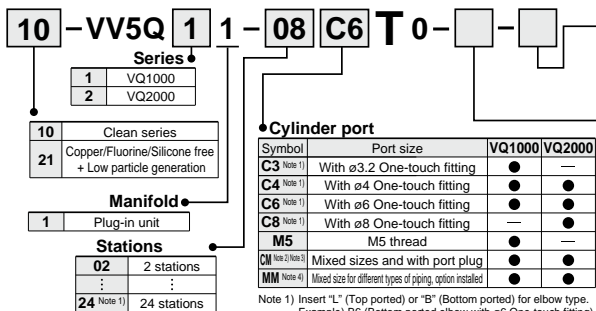

CE compliant

NH	—
Q	CE compliant

Note) For CE compliant models, DC-type only.

Option

Symbol	Option	VQ1000	VQ2000
NH	None	●	●
B (Note 2)	With back pressure check valve	●	●
D	DIN rail mounting	●	●
DO	With DIN rail bracket (Without DIN rail)	●	●
DL (Note 4)	DIN rail length specified (□: Stations 02 to 24)	●	●
K (Note 4)	Special wiring spec. (Except double wiring)	●	●
N	With name plate	●	●
R (Note 5)	External pilot	●	●
W	Enclosure: Dust-tight, Water-jet-proof (IP65)	—	●

Note 1) When two or more symbols are specified, indicate them alphabetically.

Example) BNR

Note 2) Models with a suffix "B" have check valves for prevention of back pressure at all manifold stations. When a back pressure check valve is desired, and is to be installed only in certain manifold stations, specify the mounting position by means of the manifold specification sheet.

Note 3) The number of stations that may be displayed is longer than the manifold number of stations.

Note 4) Specify the wiring specifications by means of the manifold specification sheet.

Note 5) Indicate "R" for the valve with external pilot.

Note) For CE compliant models, DC-type only. [Option]

For negative common specifications of series VQ1000, refer to "Semi-standard" on page 562.

For series VQ2000 the standard manifold can be used.

• **Terminal Block Wiring (10-21-VQ2000)**

Open the terminal block cover to connect the wires to the terminal block.

Step 1. Removing the terminal block cover

Loosen mounting screws (4 pcs.) on the terminal block cover and remove the cover.

Step 2. Wiring

Loosen screws on the terminal block, connect wiring and complete it by tightening screws. (Tightening torque: 0.5 to 0.7 N·m)

The diagram on the right shows the terminal block wiring. All stations are provided with double wiring regardless of the valves which are mounted.

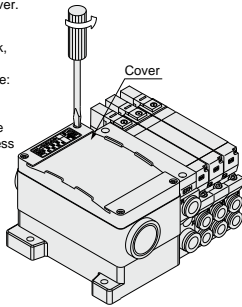
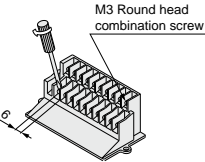

Step 3. Mounting the terminal block cover

Securely tighten the screws after confirming that the gasket is installed correctly. (Tightening torque: 0.7 to 1.2 N·m)

- Applicable crimped terminal: 1.25-3S, 1.25Y-3, 1.25Y-3N, 1.25Y-3.5
- Name plate: VVQ5000-N-T
- Drip proof plug assembly (for G 3/4): AXT100-B06A

• **Special Wiring Specifications: 10-21-VQ2000**

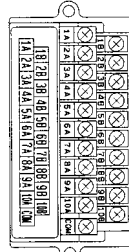

Station	Terminal no.	Polarity
Station 1	SOL A ₁ 1A	(-) (+)
	SOL B ₁ 1B	(-) (+)
Station 2	SOL A ₂ 2A	(-) (+)
	SOL B ₂ 2B	(-) (+)
Station 3	SOL A ₃ 3A	(-) (+)
	SOL B ₃ 3B	(-) (+)
Station 4	SOL A ₄ 4A	(-) (+)
	SOL B ₄ 4B	(-) (+)
Station 5	SOL A ₅ 5A	(-) (+)
	SOL B ₅ 5B	(-) (+)
Station 6	SOL A ₆ 6A	(-) (+)
	SOL B ₆ 6B	(-) (+)
Station 7	SOL A ₇ 7A	(-) (+)
	SOL B ₇ 7B	(-) (+)
Station 8	SOL A ₈ 8A	(-) (+)
	SOL B ₈ 8B	(-) (+)
Station 9	SOL A ₉ 9A	(-) (+)
	SOL B ₉ 9B	(-) (+)
Station 10	SOL A ₁₀ 10A	(-) (+)
	SOL B ₁₀ 10B	(-) (+)
	COM.	(+) (-)

As the standard electrical wiring specifications, double wiring (connected to SOL A and SOL B) is adopted for the internal wiring of each station for 10 stations or less, regardless of valve and option types. Mixed single and double wiring is available as semi-standard. Refer to page 562 for details.

Note) When using the negative common specifications, use valves for negative common.

Refer to "Semi-standard" on page 562 for details.

How to Order Valve



Series

1	VQ1000
2	VQ2000

10 Clean series

21 Copper/Fluorine/Silicone free + Low particle generation

Actuation type

1	2-position single
2	2-position double
3	3-position closed center
4	3-position exhaust center
5	3-position pressure center

Seal

0	Metal seal
1	Rubber seal

Note) For CE compliant models, DC-type only.



[Option]

CE compliant

Nil	—
Q	CE compliant

Note) For CE compliant models, DC-type only.

Enclosure

Nil	Dust-protected
W	Dust-tight, Water-jet-proof (IP65)

Note) VQ2000 only

Manual override

Nil	Non-locking push type (Tool required)
B	Locking type (Tool required)
C	Locking type (Manual)
D	Slide locking type (Manual)

Light/surge voltage suppressor

Nil	Yes
E	None

Function

Symbol	Specifications	DC	AC
Nil	Standard	(0.4 W)	(Note 1)
B	High-speed response type	(0.95 W)	—
K	High-pressure type (1.0 MPa)	(0.95 W)	—
N	Negative common	—	—
R	External pilot	—	—

Coil voltage

	CE compliant
1	100 VAC (50/60 Hz)
3	110 VAC (50/60 Hz)
5	24 VDC
6	12 VDC

- Note 1) Refer to page 522 for power consumption of AC type.
- Note 2) Metal seal only
- Note 3) Refer to "Semi-standard" on pages 562 to 563 for external pilot and negative common specifications.
- Note 4) When two or more symbols are specified, indicate them alphabetically. Combination of [B] and [K] is not possible.

Caution
Use the standard (DC) specification when continuously energizing for long periods of time.

How to Order Manifold Assembly

Specify the part numbers for valves and options together beneath the manifold base part number.

<Example>
Terminal block box kit
10-VVQ11-08C6T0-1 set—Manifold base part no.
*10-VQ1100-51 ... 2 sets—Valve part no. (Stations 1 to 2)
*10-VQ1200-51 ... 4 sets—Valve part no. (Stations 3 to 6)
*10-VQ1300-51 ... 1 set—Valve part no. (Station 7)
*VVQ1000-10A-1 ... 1 set—Blanking plate part no. (Station 8)

Prefix the asterisk to the part no. of the solenoid valve, etc.
Write sequentially from the 1st station on the D-side. When part no. written collectively are complicated, specify them by means of the manifold specification sheet.

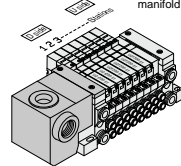

Directional Control Valves
Air Cylinders
Rotary Actuators
Air Grippers
Air Preparation Equipment
Modular F. R.
Pressure Control Equipment
Fittings & Tubing
Flow Control Equipment
Pressure Switches/Pressure Sensors

T Series ¹⁰⁻₂₁₋VQ1000/2000 kit (Terminal block box)

10-₂₁₋VV5Q11

< >: AC
The dashed lines and dimensions in parentheses indicate DIN rail mounting [-D].

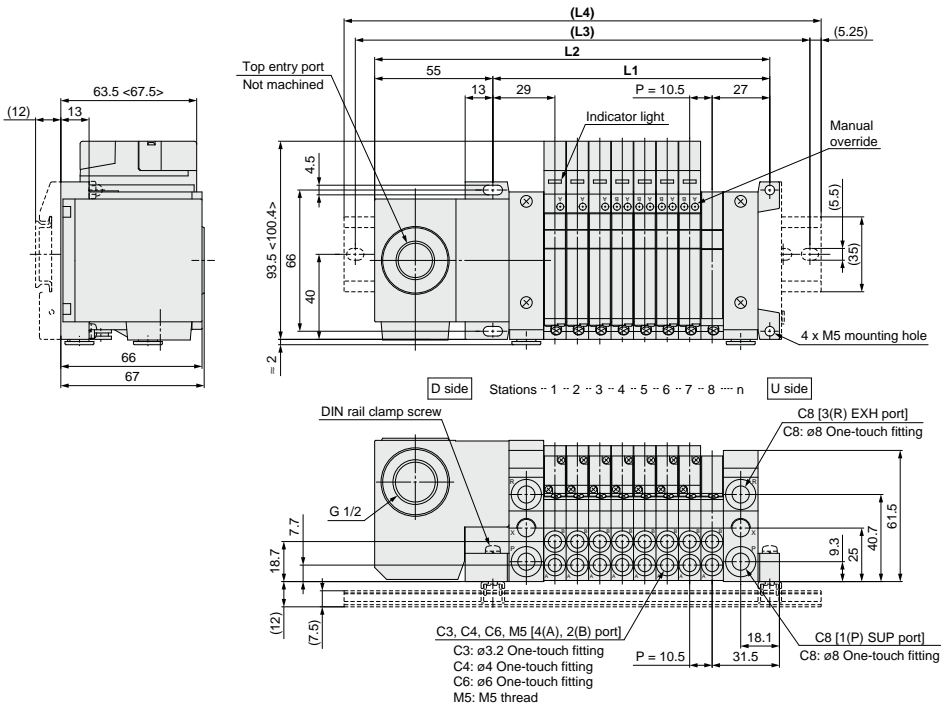

Dimensions

Formula L1 = 10.5n + 45.5, L2 = 10.5n + 105 n: Station (Maximum 24 stations)

L	n	2	3	4	5	6	7	8	9	10	11	12	13	14	15	16	17	18	19	20	21	22	23	24
L1		66.5	77	87.5	98	108.5	119	129.5	140	150.5	161	171.5	182	192.5	203	213.5	224	234.5	245	255.5	266	276.5	287	297.5
L2		126	136.5	147	157.5	168	178.5	189	199.5	210	220.5	231	241.5	252	262.5	273	283.5	294	304.5	315	325.5	336	346.5	357
(L3)		150	162.5	175	187.5	197.5	200	212.5	225	237.5	250	262.5	262.5	275	287.5	300	312.5	325	325	337.5	350	362.5	375	387.5
(L4)		160.5	173	185.5	198	198	210.5	223	235.5	248	260.5	273	273	285.5	298	310.5	323	335.5	335.5	348	360.5	373	385.5	398

With ejector unit: Formula L1 = 10.5n + 29.7 + (Number of ejector units x 26.7)
L2 = 10.5n + 88.8 + (Number of ejector units x 26.7)
L4 is L2 plus about 30.



10-21-VV5Q21

< >: AC
The dashed lines indicate DIN rail mounting [-D] (with DIN rail mounting bracket).

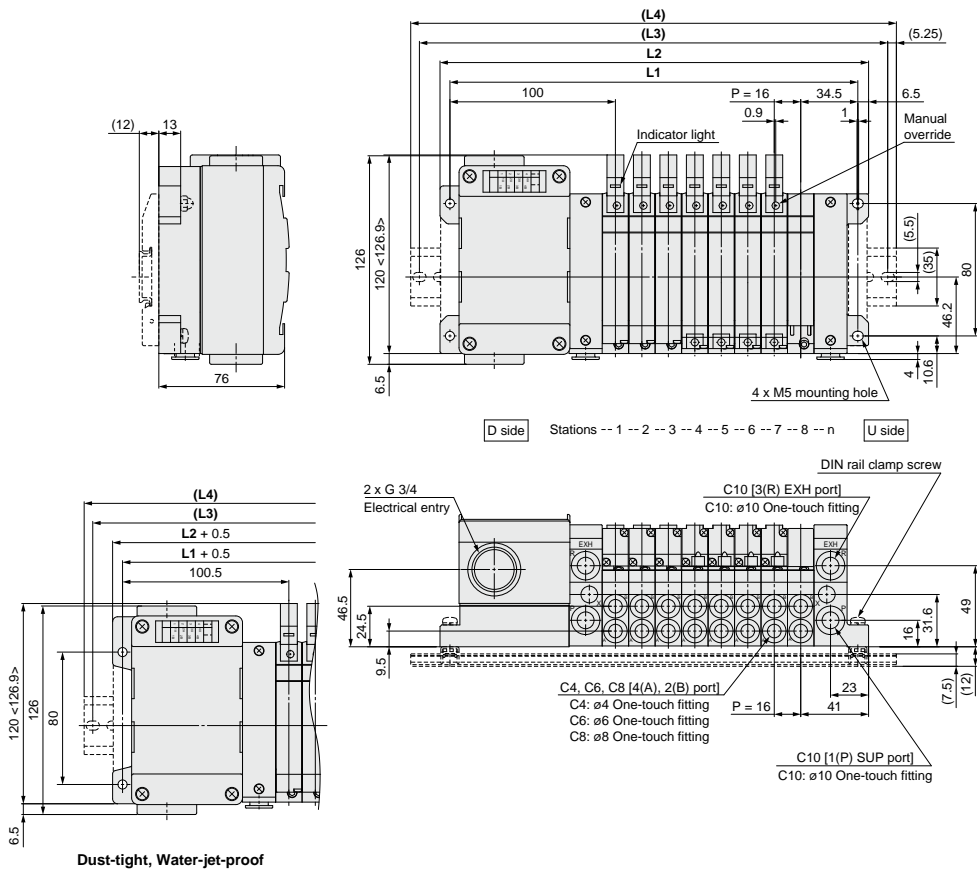

Dimensions

Formula L1 = 16n + 118.5, L2 = 16n + 131 n: Station (Maximum 20 stations)

L \ n	2	3	4	5	6	7	8	9	10	11	12	13	14	15	16	17	18	19	20
L1	150.5	166.5	182.5	198.5	214.5	230.5	246.5	262.5	278.5	294.5	310.5	326.5	342.5	358.5	374.5	390.5	406.5	422.5	438.5
L2	163	179	195	211	227	243	259	275	291	307	323	339	355	371	387	403	419	435	451
(L3)	187.5	200	225	237.5	250	262.5	287.5	300	312.5	337.5	350	362.5	375	400	412.5	425	450	462.5	475
(L4)	198	210.5	235.5	248	260.5	273	298	310.5	323	348	360.5	373	385.5	410.5	423	435.5	460.5	473	485.5

Directional Control Valves

Air Cylinders

Rotary Actuators

Air Grippers

Air Preparation Equipment

Modular F. R.

Pressure Control Equipment

Fittings & Tubing

Flow Control Equipment

Pressure Switches/ Pressure Sensors

Series 10-21-VQ1000/2000 kit (Lead wire)

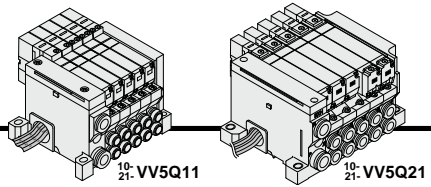

IP65 compliant

- Direct electrical entry. Models with one or more stations are available.
- SUP and EXH ports are provided on one side for further space savings.
- Maximum stations are 8.
- Enclosure: Dust-tight, Water-jet-proof (IP65) compatible (10-Series VQ2000)

Wiring Specifications: Positive COM

Three lead wires are attached to each station regardless of the type of valve which is mounted. The red wire is for COM connection.

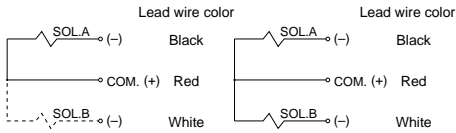

Single solenoid

Double solenoid

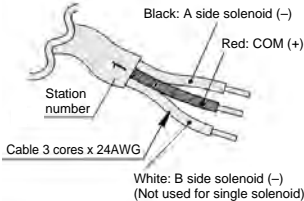

Use any of the below cable lead wire assembly to change the lead wire length:

Lead wire assembly with connector

Lead wire length	Part no.
0.6 m	VVQ1000-84A-6-*
1.5 m	VVQ1000-84A-15-*
3 m	VVQ1000-84A-30-*

* Station number 1 to 8

Manifold Specifications

Series	Piping specifications		Applicable stations
	Piping direction	Port size	
10-21: VQ1000	Side	C8 C3, C4, C6, M5	Max. 8 stations
10-21: VQ2000	Side	C10 C6, C8	Max. 8 stations

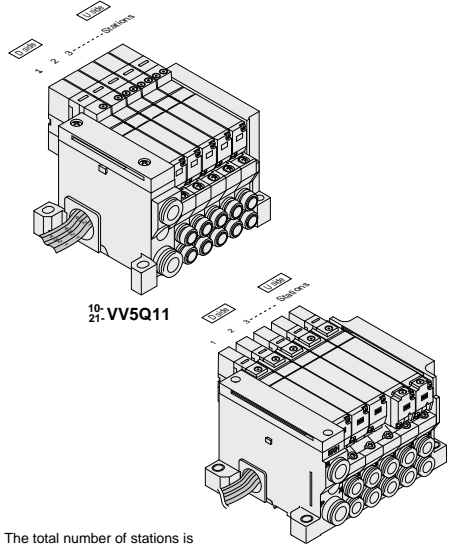

The total number of stations is tabulated on the D-side.

10-21: VV5Q21

Note) For CE compliant models, DC-type only.

How to Order Manifold

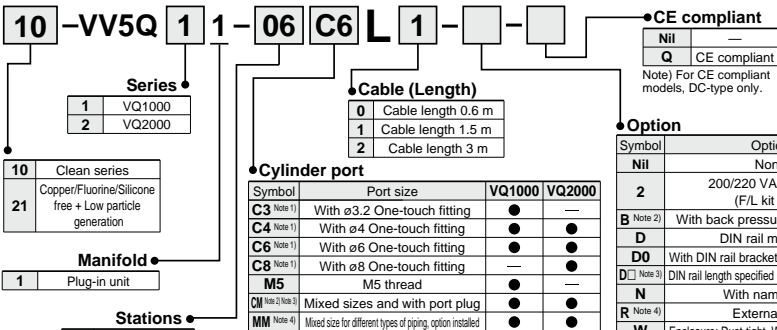

- Note 1) Insert "L" (Top ported) or "B" (Bottom ported) for elbow type. Example) B6 (Bottom ported elbow with ø6 One-touch fitting)
- Note 2) Indicate "LM" for models with elbow fittings and mixed cylinder port sizes.
- Note 3) Indicate "Mixed sizes and with port plug" by means of the manifold specification sheet.
- Note 4) When selecting the mixed size for different types of piping, dual flow fitting assembly, or double check block (direct mounting), enter "MM" and give instructions on the manifold specification sheet.
- Note 5) Inch-size One-touch fittings are available. Refer to "Semi-standard" on page 563 for details.

- Note 1) When two or more symbols are specified, indicate them alphabetically. Example) -BNR
- Note 2) Models with a suffix "-B" have check valves for prevention of back pressure at all manifold stations. When a back pressure check valve is desired, and is to be installed only in certain manifold stations, specify the mounting position by means of the manifold specification sheet.
- Note 3) The number of stations that may be displayed is longer than the manifold number of stations.
- Note 4) Indicate "R" for the valve with external pilot.

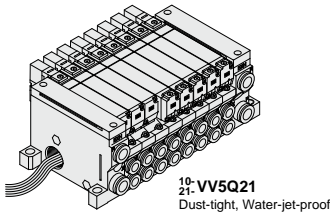

• Wiring Specifications: Negative COM (Semi-standard)

Three lead wires are attached to each station regardless of the type of valve which is mounted.
The black wire is for COM connection.

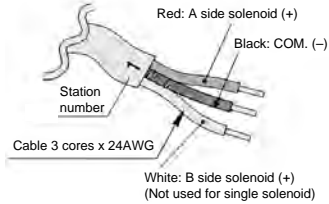
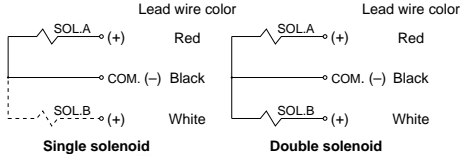

Lead wire assembly with connector

Lead wire length	Part no.
0.6 m	VVQ1000-84AN-6-*
1.5 m	VVQ1000-84AN-15-*
3 m	VVQ1000-84AN-30-*

* Station number 1 to 8

Note) When using the negative common specifications, use valves for negative common. For negative common specifications, refer to "Semi-standard" on page 562.

How to Order Valve

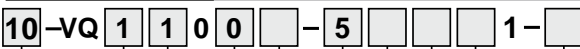

Series

1	VQ1000
2	VQ2000

Seal

0	Metal seal
1	Rubber seal

Actuation type

1	2-position single
2	2-position double
3	3-position closed center
4	3-position exhaust center
5	3-position pressure center

Clean series

10	Clean series
21	Copper/Fluorine/Silicone free + Low particle generation

Function

Symbol	Specifications	DC	AC
Nil	Standard	(0.4 W) ○ (Note 1)	○
B	High-speed response type	(0.95 W) ○	—
K (Note 2)	High-pressure type (1.0 MPa)	(0.95 W) ○	—
N (Note 3)	Negative common	○	—
R (Note 3)	External pilot	○	○

Note 1) Refer to page 522 for power consumption of AC type.
Note 2) Metal seal only.
Note 3) For external pilot and negative common specifications, refer to "Semi-standard" on pages 562 to 563.
Note 4) When two or more symbols are specified, indicate them alphabetically. Combination of [B] and [K] is not possible.

Note) For CE compliant models, DC-type only.



CE compliant

Nil	—
Q	CE compliant

Note) For CE compliant models, DC-type only.

Enclosure

Nil	Dust-protected
W (Note)	Dust-tight, Water-jet-proof (IP65)

Note) VQ2000 only

Manual override

Nil	Non-locking push type (Tool required)
B	Locking type (Tool required)
C	Locking type (Manual)
D	Slide locking type (Manual)

Light/surge voltage suppressor

Nil	Yes
E	None

Coil voltage

	CE compliant
1	100 VAC (50/60 Hz) —
2	200 VAC (50/60 Hz) —
3	110 VAC (50/60 Hz) —
4	220 VAC (50/60 Hz) —
5	24 VDC ●
6	12 VDC ●

How to Order Manifold Assembly

Specify the part numbers for valves and options together beneath the manifold base part number.

<Example>
Lead wire kit with cable (3 m)
10-VV5Q11-06C6L2-...1 set-Manifold base part no.
*10-VQ1100-51...2 sets-Valve part no. (Stations 1 to 2)
*10-VQ1200-51...2 sets-Valve part no. (Stations 3 to 4)
*10-VQ1300-51...1 set-Valve part no. (Station 5)
*VVQ1000-10A-1...1 set-Blanking plate part no. (Station 6)

Write sequentially from the 1st station on the D-side.
When part no. written collectively are complicated, specify them by means of the manifold specification sheet.

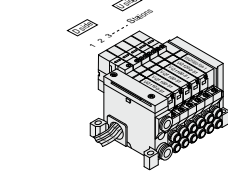

⚠ Caution

Use the standard (DC) specification when continuously energizing for long periods of time.

Directional Control Valves
Air Cylinders
Rotary Actuators
Air Grippers
Air Preparation Equipment
Modular F. R.
Pressure Control
Fittings & Tubing
Flow Control Equipment
Pressure Switches/Pressure Sensors

Series 10-21-VQ1000/2000 kit (Lead wire)

10-21-VV5Q11

< >: AC

The dashed lines indicate DIN rail mounting [-D] (with DIN rail mounting bracket).

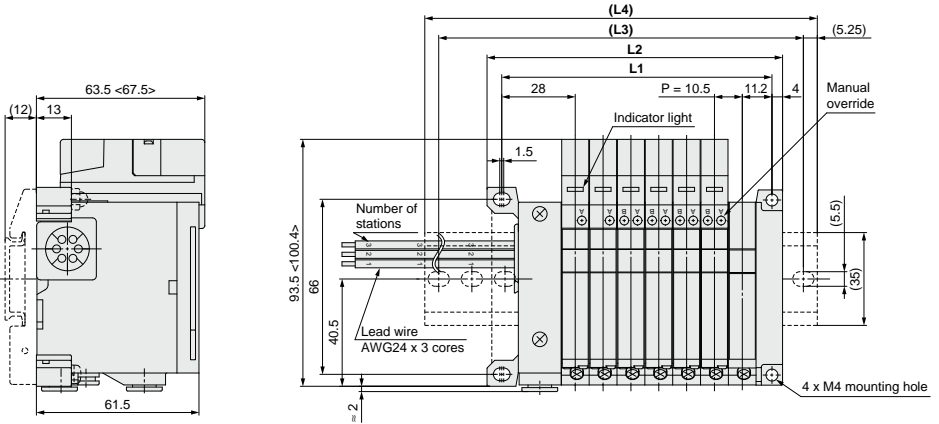

[D side] Stations -- 1 -- 2 -- 3 -- 4 -- 5 -- 6 -- 7 -- n [U side]

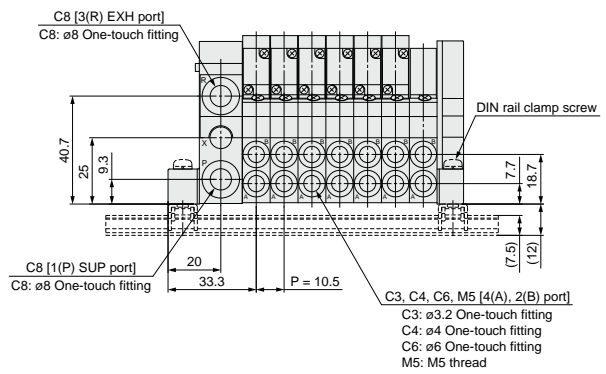

Formula L1 = 10.5n + 28.5, L2 = 10.5n + 38
n: Station (Maximum 8 stations)

Dimensions

n	1	2	3	4	5	6	7	8
L1	39	49.5	60	70.5	81	91.5	102	112.5
L2	48.5	59	69.5	80	90.5	101	111.5	122
(L3)	75	87.5	87.5	100	112.5	125	137.5	150
(L4)	85.5	98	98	110.5	123	135.5	148	160.5

With ejector unit: Formula L1 = 10.5n + 28.5 + (Number of ejector units x 26.7)
L2 = 10.5n + 38 + (Number of ejector units x 26.7)
L4 is L2 plus about 30.

10-21-VV5Q21

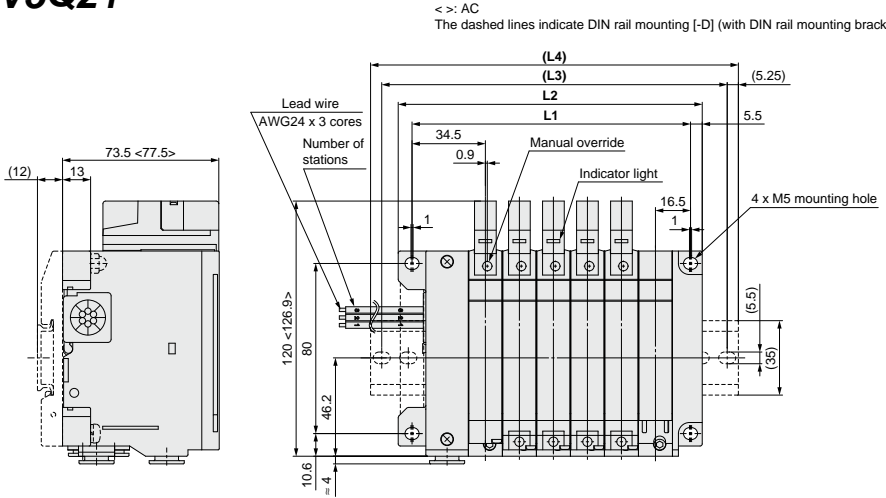

Dust-tight, Water-jet-proof

[D side] Stations --- 1 --- 2 --- 3 --- 4 --- 5 --- 6 --- n [U side]

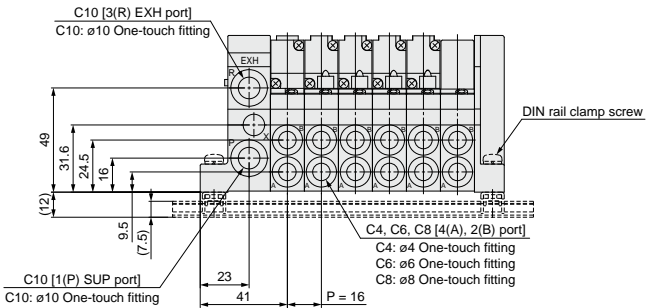

Dimensions

Formula L1 = 16n + 35, L2 = 16n + 47
n: Station (Maximum 8 stations)

L	n	1	2	3	4	5	6	7	8
L1		51	67	83	99	115	131	147	163
L2		63	79	95	111	127	143	159	175
(L3)		87.5	100	125	137.5	150	162.5	184.5	200
(L4)		98	110.5	135.5	148	160.5	173	198	210.5

Directional Control Valves
Air Cylinders
Rotary Actuators
Air Grippers
Air Preparation Equipment
Modular F. R.
Pressure Control Equipment
Fittings & Tubing
Flow Control Equipment
Pressure Switches/ Pressure Sensors

S

Series 10-21-VQ1000/2000

kit (Serial transmission) Base mounted plug-in manifold: For EX510 Gateway-type serial transmission system

How to Order Manifold

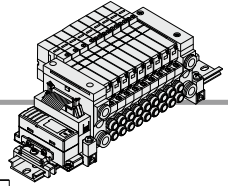

10 - VV5Q 1 1 - SB [] 08 [] - D [] - []

10	Clean series	1	VQ1000
21	Copper/Fluorine/Silicone free + Low particle generation	2	VQ2000

SI unit specifications

Nil	NPN output (+COM.)
N	PNP output (-COM.)

Valve stations

Symbol	Stations
01	1 station
⋮	⋮
08	8 stations

Note) Max. 16 stations. (Special wiring specifications)

SI unit part no.

Symbol	SI unit specifications	SI unit part no.
Nil	NPN output (+COM.)	EX510-S002A
N	PNP output (-COM.)	EX510-S102A

Cylinder port

Symbol	Port size	VQ1000	VQ2000
C3	With ø3.2 One-touch fitting	●	—
C4	With ø4 One-touch fitting	●	●
C6	With ø6 One-touch fitting	●	●
C8	With ø8 One-touch fitting	—	●
M5	M5 thread	●	—
CM ^{Note 1)}	With mixed sizes and with port plug	●	●
L3	Top ported elbow with ø3.2 One-touch fitting	●	—
L4	Top ported elbow with ø4 One-touch fitting	●	●
L6	Top ported elbow with ø6 One-touch fitting	●	●
L8	Top ported elbow with ø8 One-touch fitting	—	●
L5	Top ported elbow M5 thread	●	—
B3	Bottom ported elbow with ø3.2 One-touch fitting	●	—
B4	Bottom ported elbow with ø4 One-touch fitting	●	●
B6	Bottom ported elbow with ø6 One-touch fitting	●	●
B8	Bottom ported elbow with ø8 One-touch fitting	—	●
B5	Bottom ported elbow M5 thread	●	—
LM ^{Note 1)}	Elbow port, mixed sizes	●	●
N1	ø1/8" with One-touch fitting	●	—
N3	ø5/32" with One-touch fitting	●	●
N7	ø1/4" with One-touch fitting	●	●
N9	ø5/16" with One-touch fitting	—	●
M5T	UNF10-32 thread	●	—
NM ^{Note 1)}	With mixed sizes and with port plug	●	●
LN1	Top ported elbow with ø1/8" One-touch fitting	●	—
LN3	Top ported elbow with ø5/32" One-touch fitting	●	●
LN7	Top ported elbow with ø1/4" One-touch fitting	●	●
LN9	Top ported elbow with ø5/16" One-touch fitting	—	●
L5T	Top ported elbow UNF10-32 thread	●	—
BN1	Bottom ported elbow with ø1/8" One-touch fitting	●	—
BN3	Bottom ported elbow with ø5/32" One-touch fitting	●	●
BN7	Bottom ported elbow with ø1/4" One-touch fitting	●	●
BN9	Bottom ported elbow with ø5/16" One-touch fitting	—	●
B5T	Bottom ported elbow UNF10-32 thread	●	—
LM ^{Note 1)}	Elbow port, mixed sizes	●	●
MM ^{Note 2)}	Mixed size for different types of piping, option installed	●	●

Note 1) Indicate "Mixed sizes and with port plug" in the manifold specification sheet. Note 2) When selecting the mixed size for different types of piping, dual flow fitting assembly, or double check block (direct mounting), enter "MM" and give instructions on the manifold specification sheet.

Refer to the **WEB catalog** for details on the EX510 gateway-type serial transmission system.

CE compliant

Nil	—
Q	CE compliant

Option

Nil	None
B ^{Note 2)}	With back pressure check valve
D□ ^{Note 5)}	DIN rail length specified (□: Stations 02 to 16)
K ^{Note 3)}	Special wiring spec. (Except double wiring)
N	With name plate
R ^{Note 4)}	with external pilot

Note 1) When two or more symbols are specified, indicate them alphabetically. Example) -BNR

Note 2) Models with a suffix "-B" have check valves for prevention of back pressure at all manifold stations. When a back pressure check valve is desired, and is to be installed only in certain manifold stations, specify the mounting position by means of the manifold specification sheet.

Note 3) Specify the wiring specifications by means of the manifold specification sheet.

Note 4) Indicate "R" for the valve with external pilot.

Note 5) The number of stations that may be displayed is longer than the manifold number of stations.

DIN rail mounting

How to Order Manifold Assembly

Example

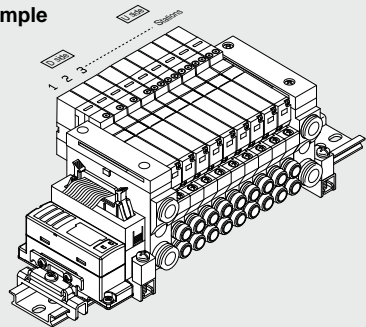

- 10-VV5011-SB08C6-D...1 set (SB kit, 8-station manifold part no.)
- *10-VQ1100-51 4 sets (Single type part no.)
- *10-VQ1200-51 3 sets (Double type part no.)
- *10-VQ1300-51 1 set (3 position type part no.)

The asterisk denotes the symbol for assembly. Prefix it to the part no. of the solenoid valve, etc.

Enter in order starting from the first station on the D-side.

Add the valve and option part numbers under the manifold base part number. For complex arrangements, specify them by means of the manifold specification sheet.



Directional Control Valves

How to Order Valve

10-VQ1100-51-

10	Clean series
21	Copper/Fluorine/Silicone free + Low particle generation

Series

1	VQ1000
2	VQ2000

CE compliant

Nil	—
Q	CE compliant

Actuation type

1	2-position single
2	Metal 2-position double
	Rubber 2-position double
3	3-position closed center
4	3-position exhaust center
5	3-position pressure center

Manual override

Nil: Non-locking push type (Tool required)



B: Locking type (Tool required)



C: Locking type (Manual)



D: Slide locking type (Manual)

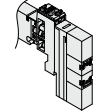

Rated voltage

5	24 VDC
---	--------

Function

Symbol	Specifications
Nil	Standard (0.4 W)
B	High-speed response type (0.95 W)
K <small>Note 1)</small>	High-pressure type (1.0 MPa) [0.95 W]
N <small>Note 2)</small>	Negative common
R <small>Note 2)</small>	External pilot

Note 1) Metal seal only
 Note 2) For external pilot and negative common specifications, refer to "Semi-standard" on pages 562 to 563.
 Note 3) When two or more symbols are specified, indicate them alphabetically. Combination of [B] and [K] is not possible.

Seal

0	Metal seal
1	Rubber seal

Air Cylinders

Rotary Actuators

Air Grippers

Air Preparation Equipment

Modular F. R.

Pressure Control Equipment

Fittings & Tubing

Flow Control Equipment

Pressure Switches/ Pressure Sensors



Series 10-21-VQ1000/2000

kit (Serial transmission) Base mounted plug-in manifold: For EX510 Gateway-type serial transmission system

10-21-VV5Q11

Applicable connector: Flat ribbon cable connector (20P)
(Complies with MIL-C-83503)

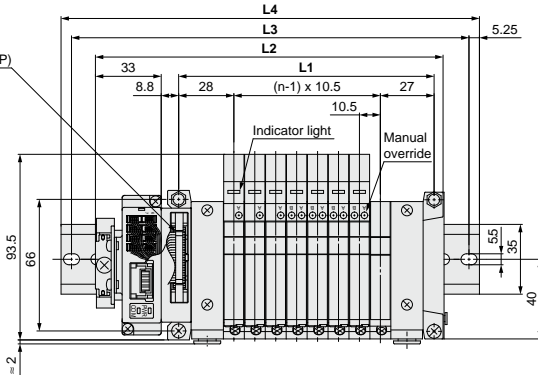
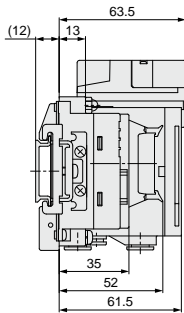

D side Stations 1 - 2 - 3 - 4 - 5 - 6 - 7 - 8 ... n U side

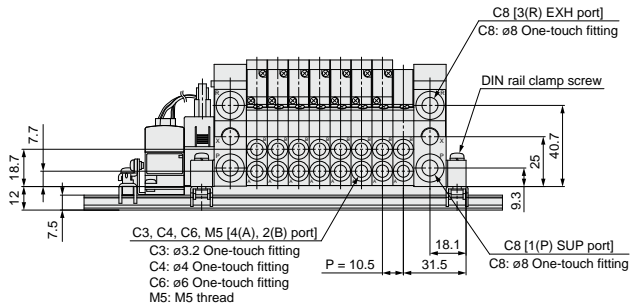

Dimensions

Formula L1 = 10.5n + 44.5, L2 = 10.5n + 91 n: Station (Maximum 16 stations)

L	n	1	2	3	4	5	6	7	8	9	10	11	12	13	14	15	16
L1		55	65.5	76	86.5	97	107.5	118	128.5	139	149.5	160	170.5	181	191.5	202	212.5
L2		101.5	112	122.5	133	143.5	154	164.5	175	185.5	196	206.5	217	227.5	238	248.5	259
L3		125	137.5	150	162.5	175	187.5	200	212.5	225	237.5	250	262.5	275	287.5		
L4		135.5	148	160.5	173	185.5	198.5	210.5	223	235.5	248	260.5	273	285.5	298		

10-21-VV5Q21

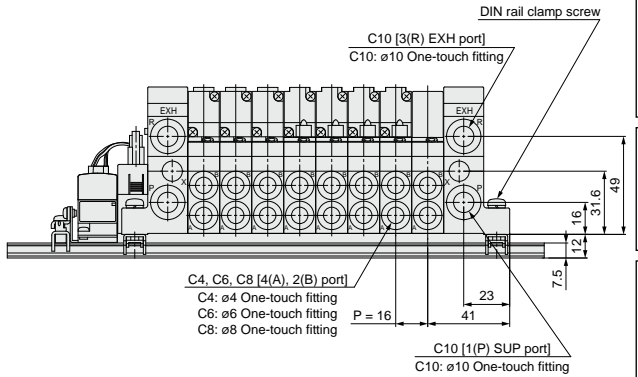
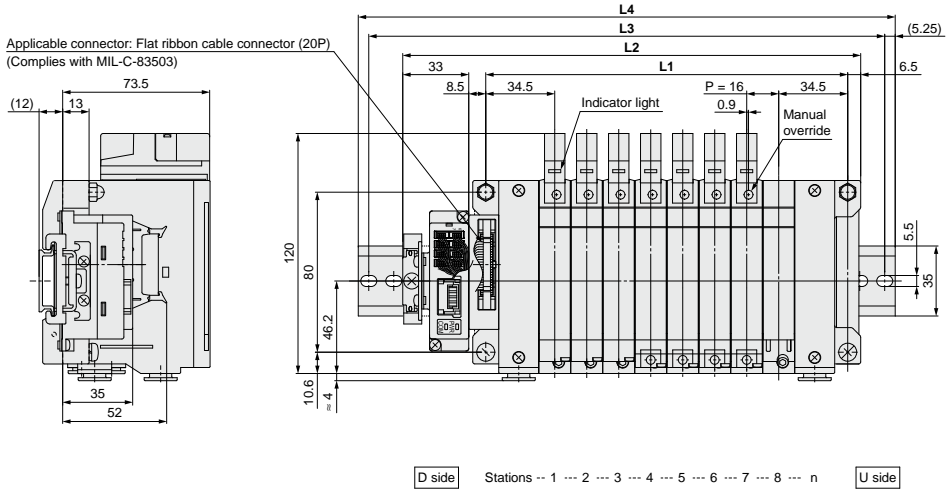

Dimensions

Formula L1 = 16n + 53, L2 = 16n + 101 n: Station (Maximum 16 stations)

L \ n	1	2	3	4	5	6	7	8	9	10	11	12	13	14	15	16
L1	69	85	101	117	133	149	165	181	197	213	229	245	261	277	293	309
L2	117	133	149	165	181	197	213	229	245	261	277	293	309	325	341	357
L3	137.5	162.5	175	187.5	212.5	225	237.5	250	275	287.5	300	312.5	337.5	350	362.5	387.5
L4	148	173	185.5	198	223	235.5	248	260.5	285.5	298	310.5	323	348	360.5	373	398

Directional Control Valves
Air Cylinders
Rotary Actuators
Air Grippers
Air Preparation Equipment
Modular F. R.
Pressure Control Equipment
Fittings & Tubing
Flow Control Equipment
Pressure Switches/ Pressure Sensors

S Series¹⁰⁻²¹-VQ1000/2000

kit (Serial transmission): For EX120/123/124 Integrated-type (Output) serial transmission system

IP65 compliant

- The serial transmission system reduces wiring work, while minimizing wiring and saving space.
- Enclosure: Dust-tight, Water-jet-proof (IP65) compatible (Series VQ2000)

Manifold Specifications

Series	Piping specifications			Applicable stations
	Piping direction	Port size		
		1(P), 3(R)	4(A), 2(B)	
¹⁰ / ₂₁ VQ1000	Side	C8	C3, C4, C6, M5	Max. 16 stations
¹⁰ / ₂₁ VQ2000	Side	C10	C4, C6, C8	Max. 16 stations

Note) Refer to "SI Unit Part No." when ordering the CE-compliant SI unit.



How to Order Manifold

10 - **VV5Q** **1** **1** - **08** **C6** **S** **V** - **XP** - **Q**

● **Clean series**
10 Copper/Fluorine/Silicone free
21 + Low particle generation

● **Series**
1 VQ1000
2 VQ2000

● **Manifold**
1 Plug-in unit

● **Stations**
02 2 stations
16 (Note) 16 stations

● **SI unit specifications**

Symbol	Protocol	Stations
0	Without SI unit	
F1	NKE Corp.: Fieldbus System	Max. 16 stations
H	NKE Corp.: Fieldbus H System	
J1	Panasonic Industrial Devices SUNX Co., Ltd.: S-LINK (16 outputs)	Max. 8 stations
J2	Panasonic Industrial Devices SUNX Co., Ltd.: S-LINK (8 outputs)	
Q	DeviceNet™	Max. 16 stations
R1	OMRON Corp.: CompoBus/S (16 outputs)	Max. 8 stations
R2	OMRON Corp.: CompoBus/S (8 outputs)	
V	CC-Link	Max. 16 stations
ZB	CompoNet™ (Positive common)	
ZBN	CompoNet™ (Negative common)	

● **Enclosure**
Nil —
XP (Note) Dust-protected

Note) Suffix "-XP" for the dust-protected type SI units (Except SI unit specification "Q")

● **CE compliant**
Nil —
Q CE compliant

Note) Refer to "SI Unit Part No." when ordering the CE-compliant SI unit.

● **Option**

Symbol	Option	VQ1000	VQ2000
Nil	None	●	●
B (Note 2)	With back pressure check valve	●	●
D	DIN rail mounting	●	●
D (Note 3)	DIN rail mounting (□: Stations 02 to 16)	●	●
K (Note 4)	Special wiring specifications (Except double wiring)	●	●
N	With name plate	●	●
R (Note 5)	With external pilot	●	●
W	Enclosure: Dust-tight, Water-jet-proof (IP65)	—	●

Note 1) Refer to page 562 for details.
 Note 2) Max. 16 stations. (Specify a model with 9 to 16 stations by means of the manifold specification sheet.)

Cylinder port

Symbol	Port size	VQ1000	VQ2000
C3 (Note 1)	With ø3.2 One-touch fitting	●	—
C4 (Note 1)	With ø4 One-touch fitting	●	●
C6 (Note 1)	With ø6 One-touch fitting	●	●
C8 (Note 1)	With ø8 One-touch fitting	—	●
M5	M5 thread	●	—
CM (Note 2/Note 3)	Mixed sizes and with port plug	●	●
MM (Note 4)	Mixed size for different types of piping, option installed	●	●

- Note 1) Insert "L" (Top ported) or "B" (Bottom ported) for elbow type.
 Example) B6 (Bottom ported elbow with ø6 One-touch fitting)
- Note 2) Indicate as "LM" for models with elbow fittings and mixed cylinder port sizes.
- Note 3) Indicate "Mixed sizes and with port plug" by means of the manifold specification sheet.
- Note 4) When selecting the mixed size for different types of piping, dual flow fitting assembly, or double check block (direct mounting), enter "MM" and give instructions on the manifold specification sheet.
- Note 5) Inch-size One-touch fittings are available. Refer to "Semi-standard" on page 563 for details.

SI Unit Part No.

(Without option W [Dust-protected (-XP) is included.])

Symbol	Protocol	SI unit part no.	CE compliant
F1	NKE Corp.: Fieldbus System	Standard: EX120-SUW1 Dust-protected: EX120-SUW1-XP	—
H	NKE Corp.: Fieldbus H System	Standard: EX120-SUH1 Dust-protected: EX120-SUH1-XP	—
J1	Panasonic Industrial Devices SUNX Co., Ltd.: S-LINK (16 outputs)	Standard: EX120-SSL1 Dust-protected: EX120-SSL1-XP	—
J2	Panasonic Industrial Devices SUNX Co., Ltd.: S-LINK (8 outputs)	Standard: EX120-SSL2 Dust-protected: EX120-SSL2-XP	—
Q	DeviceNet™	Standard: EX120-SDN1 Dust-protected: No part no.	●
R1	OMRON Corp.: CompoBus/S (16 outputs)	Standard: EX120-SCS1 Dust-protected: EX120-SCS1-XP	●
R2	OMRON Corp.: CompoBus/S (8 outputs)	Standard: EX120-SCS2 Dust-protected: EX120-SCS2-XP	●
V	CC-Link	Standard: EX120-SMJ1 Dust-protected: EX120-SMJ1-XP	●
ZB	CompoNet™ (Positive common)	Standard: EX120-SCM1 Dust-protected: No part no.	●
ZBN	CompoNet™ (Negative common)	Standard: EX120-SCM3 Dust-protected: No part no.	●

SI Unit Part No. (With option W)

Symbol	Protocol	SI unit part no.	CE compliant
F1	NKE Corp.: Fieldbus System	EX123D-SUW1	—
H	NKE Corp.: Fieldbus H System	EX123D-SUH1	—
J1	Panasonic Industrial Devices SUNX Co., Ltd.: S-LINK (16 outputs)	EX123D-SSL1	—
J2	Panasonic Industrial Devices SUNX Co., Ltd.: S-LINK (8 outputs)	EX123D-SSL2	—
Q	DeviceNet™	EX124D-SDN1	●
R1	OMRON Corp.: CompoBus/S (16 outputs)	EX124D-SCS1	●
R2	OMRON Corp.: CompoBus/S (8 outputs)	EX124D-SCS2	●
V	CC-Link	EX124D-SMJ1	●

Refer to the **WEB catalog** for details on the EX120/123/124 integrated-type (Output) serial transmission system.
 * Refer to the **WEB catalog** for details on CompoNet™.

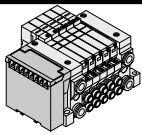

10-21: VV5Q11

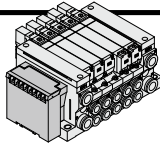

10-21: VV5Q21

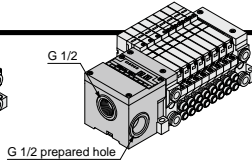

10-21: VV5Q11
Dust-protected (-XP)

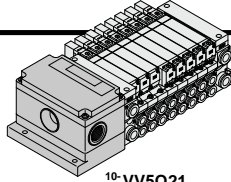

10-21: VV5Q21
Dust-tight, Water-jet-proof (-W)



[Option]

How to Order Valve

10 - VQ 1 1 0 0 - 5 - 1 -

Series

1	VQ1000
2	VQ2000

10	Clean series
21	Copper/Fluorine/Silicone free + Low particle generation

Actuation type

1	2-position single
2	2-position double
3	3-position closed center
4	3-position exhaust center
5	3-position pressure center

Seal

0	Metal seal
1	Rubber seal

CE compliant

Nil	—
Q	CE compliant

Enclosure

Nil	Dust-protected
W Note)	Dust-tight, Water-jet-proof (IP65)

Note) Ⓜ VQ2000 only

Manual override

Nil	Non-locking push type (Tool required)
B	Locking type (Tool required)
C	Locking type (Manual)
D	Slide locking type (Manual)

Coil voltage

5	24 VDC With indicator light/ surge voltage suppressor
---	---

Function

Symbol	Specifications	DC
Nil	Standard	(0.4 W) ○
B	High-speed response type	(0.95 W) ○
K Note 1)	High-pressure type (1.0 MPa)	(0.95 W) ○
N Note 2)	Negative common	○
R Note 2)	External pilot	○

Note 1) Metal seal only
 Note 2) For external pilot and negative common specifications, refer to "Semi-standard" on pages 562 to 563.
 Note 3) When two or more symbols are specified, indicate them alphabetically. Combination of [B] and [K] is not possible.

How to Order Manifold Assembly

Specify the part numbers for valves and options together beneath the manifold base part number.

<Example>

- 10-VV5Q11-08C6SV-1 set—Manifold base part no.
- *10-VQ1100-51 ... 2 sets—Valve part no. (Stations 1 to 2)
- *10-VQ1200-51 ... 4 sets—Valve part no. (Stations 3 to 6)
- *10-VQ1300-51 ... 1 set—Valve part no. (Station 7)
- *VVQ1000-10A-1 ... 1 set—Blanking plate part no. (Station 8)

Prefix the asterisk to the part no. of the solenoid valve, etc.

Write sequentially from the 1st station on the D-side. When part no. written collectively are complicated, specify them by means of the manifold specification sheet.

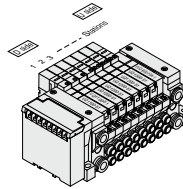

Directional Control Valves

Air Cylinders

Rotary Actuators

Air Grippers

Air Preparation Equipment

Modular F. R.

Pressure Control Equipment

Fittings & Tubing

Flow Control Equipment

Pressure Switches/ Pressure Sensors

S

Series 10-21-VQ1000/2000

kit (Serial transmission): For EX120 Integrated-type (Output) serial transmission system

10-21-VV5Q11

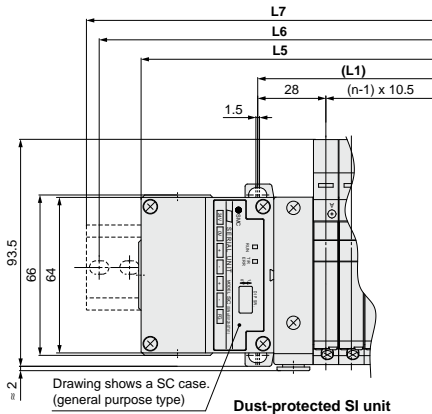

The dashed lines indicate DIN rail mounting [-D] (with DIN rail mounting bracket).

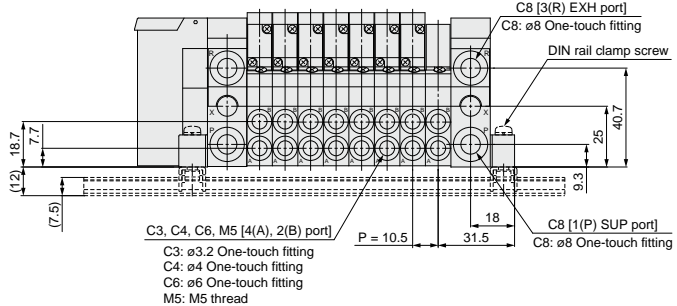
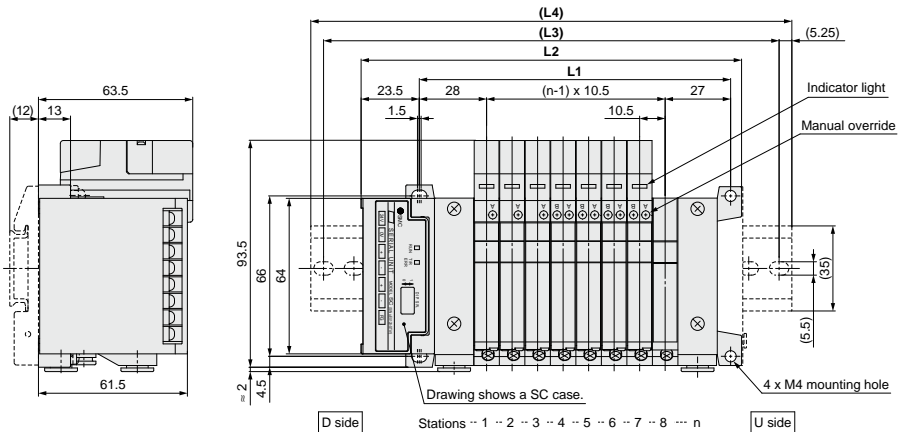

Dimensions

L	n	2	3	4	5	6	7	8	9	10	11	12	13	14	15	16
L1		65.5	76	86.5	97	107.5	118	128.5	139	149.5	160	170.5	181	191.5	202	212.5
L2		93.5	104	114.5	125	135.5	146	156.5	167	177.5	188	198.5	209	219.5	230	240.5
(L3)		125	125	137.5	150	162.5	175	187.5	200	212.5	225	237.5	250	250	262.5	
(L4)		135.5	135.5	148	160.5	173	185.5	198	198	210.5	223	235.5	248	260.5	260.5	273

Dust-protected SI unit: L5 = 10.5n + 97, L6 = L3 + 25, L7 = L4 + 25
Formula L1 = 10.5n + 44.5, L2 = 10.5n + 72.5 n: Station (Maximum 16 stations)



Series 10-21-VQ2000

kit (Serial transmission): For EX240 Integrated-type (I/O) serial transmission system

IP65 compliant

VQ2000 only

- The serial transmission system reduces wiring work, while minimizing wiring and saving space.

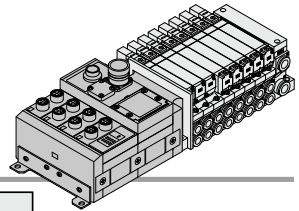

How to Order Manifold

10 - VV5Q21 - 08 C6 S D QW 1 - N W -

VQ2000 Plug-in series

10	Clean series
21	Copper/Fluorine/Silicone free + Low particle generation

Stations

01	1 station
...	...
16	16 stations

Cylinder port

Symbol	Port size
C4 <small>Note 1)</small>	With ø4 One-touch fitting
C6 <small>Note 1)</small>	With ø6 One-touch fitting
C8 <small>Note 1)</small>	With ø8 One-touch fitting
CM <small>Note 2) Note 3)</small>	Mixed sizes and with port plug
MM <small>Note 4)</small>	Mixed size for different types of piping, option installed

- Note 1) Insert "L" (Top ported) or "B" (Bottom ported) for elbow type.
 Example) B6 (Bottom ported elbow with ø6 one-touch fitting)
 Note 2) Indicate "LM" for models with elbow fittings and mixed cylinder port sizes.
 Note 3) Indicate "Mixed sizes and with port plug" by means of the manifold specification sheet.
 Note 4) When selecting the mixed size for different types of piping, dual flow fitting assembly, or double check block (direct mounting), enter "MM" and give instructions on the manifold specification sheet.
 Note 5) Inch-size One-touch fittings are available. Refer to "Semi-standard" on page 563 for details.

SI unit mounting
D: D side mounting

CE compliant

Nil	—
Q	CE compliant

Enclosure IP65 (Dust-tight, Water-jet-proof)

Option

Symbol	Option
Nil	None
B	With back pressure check valve
K	Special wiring spec. (Except double wiring)
N	With name plate
R	External pilot

Note) When two or more symbols are specified, indicate them alphabetically.
Example: -BNR

Input block type

Nil	PNP sensor input (+COM) or without SI unit/input block
N	NPN sensor input (-COM)

Number of input blocks

Nil	Without SI unit
0	Without input block
1	With 1 pc. input block
2	With 2 pcs. input blocks
3	With 3 pcs. input blocks
4	With 4 pcs. input blocks

Model

OW	Without SI unit
QW	DeviceNet™ +COM.
NWN	PROFIBUS-DP -COM.

Note) Only +COM is available for DeviceNet™.
Order a mounting valve with +COM.
Since PROFIBUS is -COM only, order -COM for valves to be mounted.

Refer to the **WEB catalog** for details on the EX240 integrated-type (I/O) serial transmission system.

How to Order Manifold

10 - VQ 2 1 0 0 - 5 W 1 -

10	Clean series
21	Copper/Fluorine/Silicone free + Low particle generation

Actuation type

1	2-position single
2	2-position double
3	3-position closed center
4	3-position exhaust center
5	3-position pressure center

Seal

0	Metal seal
1	Rubber seal

Note) For external pilot and negative common specifications, refer to "Semi-standard" on pages 562 to 563.

Enclosure IP65 (Dust-tight, Water-jet-proof)

Manual override

Nil	Non-locking push type (Tool required)
B	Locking type (Tool required)
C	Locking type (Manual)
D	Slide locking type (Manual)

CE compliant

Nil	—
Q	CE compliant

* Refer to "SI Unit Part No." when ordering the CE-compliant SI unit.

Function

Symbol	Specifications	DC
Nil	Standard	(0.4 W)
B	High-speed response type	(0.95 W)
K <small>Note 1)</small>	High-pressure type (1.0 MPa)	(0.95 W)
N <small>Note 2)</small>	Negative common	○
R <small>Note 2)</small>	External pilot	○

Coil voltage

5	24 VDC, With indicator light/surge voltage suppressor
---	---

- Note 1) Metal seal only
 Note 2) For external pilot and negative common specifications, refer to "Semi-standard" on pages 562 to 563.
 Note 3) When a valve is compatible with PROFIBUS DP, the SI unit is negative common. Select valves for negative common.
 Note 4) When two or more symbols are specified, indicate them alphabetically. Combination of [B] and [K] is not possible.

Caution

Use the standard (DC) specification when continuously energizing for long periods of time.

M Series ¹⁰⁻²¹-VQ2000 kit (Circular connector)

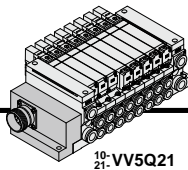

VQ2000 only

- MIL flat cable connector reduces installation labor for electrical connection.
- Manifold and connectors, both compliant with the IP65 rating (Dust-tight, Water-jet-proof), provide a high-degree of protection for the electrical parts.
- Maximum stations are 24.

Manifold Specifications

Series	Piping specifications			Applicable stations
	Piping direction	Port size		
¹⁰⁻²¹ : VQ2000	Side	1(P), 3(R)	4(A), 2(B)	Max. 24 stations

Circular Connector (26 Pins)

Cable Assembly ●

AXT100-MC26-⁰¹⁵
⁰³⁰
⁰⁵⁰

(Circular connector cable assembly included in a specific manifold model no.)
(Refer to "How to Order Manifold.")

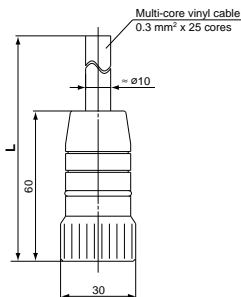

Circular connector cable assembly

Cable length (L)	Assembly part no.	Note
1.5 m	AXT100-MC26-015	Cable 25-core x 24AWG
3 m	AXT100-MC26-030	
5 m	AXT100-MC26-050	

* Cannot be used for transfer wiring.

Electrical characteristics

Item	Property
Conductor resistance Ω/km, 20°C	65 or less
Voltage limit V, 1 minute, AC	1000
Insulation resistance MΩ/km, 20°C or more	5

Note) The minimum bending radius of the circular connector cable is 20 mm.

Circular connector cable assembly terminal no.

Terminal no.	Lead wire color	Dot marking
1	Black	None
2	Brown	None
3	Red	None
4	Orange	None
5	Yellow	None
6	Pink	None
7	Blue	None
8	Purple	White
9	Gray	Black
10	White	Black
11	White	Red
12	Yellow	Red
13	Orange	Red
14	Yellow	Black
15	Pink	Black
16	Blue	White
17	Purple	None
18	Gray	None
19	Orange	Black
20	Red	White
21	Brown	White
22	Pink	Red
23	Gray	Red
24	Black	White
25	White	None
26	White	None

Note) Lengths other than the above are also available. Please contact SMC for details.

How to Order Manifold

Note) For CE compliant models, DC-type only. [Option]

10 - **VV5Q** **2** **1** - **08** **C6** **M** **1** - **N** **W** - **□**

10	Clean series
21	Copper/Fluorine/Silicone free + Low particle generation

Series
2 VQ2000

Manifold
1 Plug-in unit

Stations

02	2 stations
⋮	⋮
24	24 stations

Note) Refer to page 562 for details.

Cylinder port

Symbol	Port size
C4 (Note 1)	With ø4 One-touch fitting
C6 (Note 1)	With ø6 One-touch fitting
C8 (Note 1)	With ø8 One-touch fitting
CM (Note 2, Note 3)	Mixed sizes and with port plug
MM (Note 4)	Mixed size for different types of piping, option installed

Note 1) Insert "L" (Top ported) or "B" (Bottom ported) for elbow type. Example) B6 (Bottom ported elbow with ø6 One-touch fitting)

Note 2) Indicate "LM" for models with elbow fittings and mixed cylinder port sizes.

Note 3) Indicate "Mixed sizes and with port plug" by means of the manifold specification sheet.

Note 4) When selecting the mixed size for different types of piping, dual flow fitting assembly, or double check block (direct mounting), enter "MM" and give instructions on the manifold specification sheet.

Note 5) Inch-size One-touch fittings are available. Refer to "Semi-standard" on page 563 for details.

Cable (Length)

0	Without cable
1	With cable (1.5 m)
2	With cable (3 m)
3	With cable (5 m)

Enclosure
IP65 (Dust-tight, Water-jet-proof)

Option

Symbol	Option
Nil	None
B (Note 2)	With back pressure check valve
D	DIN rail mounting
D0	With DIN rail bracket (Without DIN rail)
D□ (Note 3)	DIN rail mounting (□: Stations 02 to 24)
K (Note 4)	Special wiring spec. (Except double wiring)
N	With name plate
R (Note 5)	External pilot

Note 1) When two or more symbols are specified, indicate them alphabetically. Example) -BKR

Note 2) Models with a suffix "-B" have check valves for prevention of back pressure at all manifold stations. When a back pressure check valve is desired, and is to be installed only in certain manifold stations, specify the mounting position by means of the manifold specification sheet.

Note 3) The number of stations that may be displayed is longer than the manifold number of stations.

Note 4) Specify the wiring specifications by means of the manifold specification sheet.

Note 5) Indicate "R" for the valve with external pilot.

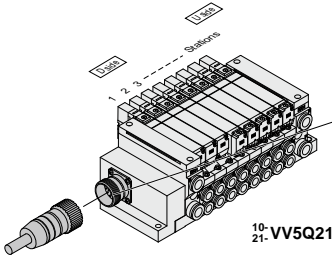

The total number of stations is tabulated starting from station one on the D-side.

Electrical Wiring Specifications

Circular connector cable assembly
AXT100-MC26-030 Wire color
015
050

Terminal no.	Polarity	Lead wire color	Dot marking
Station 1 SOL A 1	(-)	Black	None
SOL B 2	(-)	Brown	None
SOL A 3	(+)	Red	None
Station 2 SOL B 4	(-)	Orange	None
SOL A 5	(+)	Yellow	None
Station 3 SOL B 6	(-)	Pink	None
SOL A 7	(+)	Blue	None
Station 4 SOL B 8	(-)	Purple	White
SOL A 9	(+)	Gray	Black
Station 5 SOL B 10	(-)	White	Black
SOL A 11	(+)	White	Red
Station 6 SOL B 12	(-)	Yellow	Red
SOL A 13	(+)	Orange	Red
Station 7 SOL B 14	(-)	Yellow	Black
SOL A 15	(+)	Pink	White
Station 8 SOL B 16	(-)	Blue	Black
SOL A 17	(+)	Purple	None
Station 9 SOL B 18	(-)	Gray	None
SOL A 19	(+)	Orange	Black
Station 10 SOL B 20	(-)	Red	White
SOL A 21	(+)	Brown	White
Station 11 SOL B 22	(-)	Pink	Red
SOL A 23	(+)	Gray	Red
Station 12 SOL B 24	(-)	Black	White
(Max.) COM 25	(+)	Note) (-)	None
COM 26	(+)	White	None

Note) When using the negative common specifications, use valves for negative common. (Refer to page 562.)
 Refer to "Semi-standard" on page 562 for details.

How to Order Valve

10-VQ 2 1 0 0 - 5 - W 1 -

Series
 2 VQ2000

Function

Symbol	Specifications	DC	AC
Nil	Standard (0.4 W)	<input type="radio"/> Note 1)	<input type="radio"/>
B	High-speed response type (0.95 W)	<input type="radio"/>	<input type="radio"/>
K Note 2)	High-pressure type (1.0 MPa)	<input type="radio"/> (0.95 W)	<input type="radio"/>
N Note 3)	Negative common	<input type="radio"/>	<input type="radio"/>
R Note 3)	External pilot	<input type="radio"/>	<input type="radio"/>

Note 1) For power consumption of AC type, refer to page 522.
 Note 2) Metal seal only
 Note 3) For external pilot and negative common specifications, refer to "Semi-standard" on pages 562 to 563.
 Note 4) When two or more symbols are specified, indicate them alphabetically. Combination of [B] and [K] is not possible.

Actuation type

1	2-position single
2	2-position double
3	3-position closed center
4	3-position exhaust center
5	3-position pressure center

Seal

0	Metal seal
1	Rubber seal

CE compliant

Nil	—
Q	CE compliant

Note) For CE compliant models, DC-type only.

Enclosure IP65 (Dust-tight, Water-jet-proof)

Manual override

Nil	Non-locking push type (Tool required)
B	Locking type (Tool required)
C	Locking type (Manual)
D	Slide locking type (Manual)

Light/surge voltage suppressor

Nil	Yes
E	None

Coil voltage

	CE compliant
1	100 VAC (50/60 Hz)
3	110 VAC (50/60 Hz)
5	24 VDC
6	12 VDC

Note) For CE compliant models, DC-type only.

How to Order Manifold Assembly

Specify the part numbers for valves and options together beneath the manifold base part number.

<Example>
 Circular connector kit with cable (3 m)
 10-VV5Q21-09C6M2-W-1 1 set-Manifold base part no.
 *10-VQ2100-51 ... 3 sets-Valve part no. (Stations 1 to 3)
 *10-VQ2200-51 ... 3 sets-Valve part no. (Stations 4 to 6)
 *10-VQ2300-51 ... 2 sets-Valve part no. (Stations 7 to 8)
 *VVQ2000-10A-1 1 set-Blanking plate part no. (Station 9)

Prefix the asterisk to the part no. of the solenoid valve, etc.
 Write sequentially from the 1st station on the D-side. When part no. written collectively are complicated, specify them by means of the manifold specification sheet.

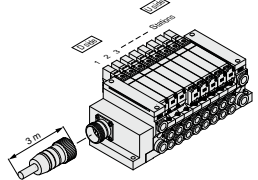

Caution
 Use the standard (DC) specification when continuously energizing for long periods of time.

Directional Control Valves

Air Cylinders

Rotary Actuators

Air Grippers

Air Preparation Equipment

Modular F. R.

Pressure Control Equipment

Fittings & Tubing

Flow Control Equipment

Pressure Switches/Pressure Sensors

M Series 10-21-VQ2000 kit (Circular connector)

10-21-VV5Q21

< >: AC

The dashed lines and dimensions in parentheses indicate DIN rail mounting [-D].

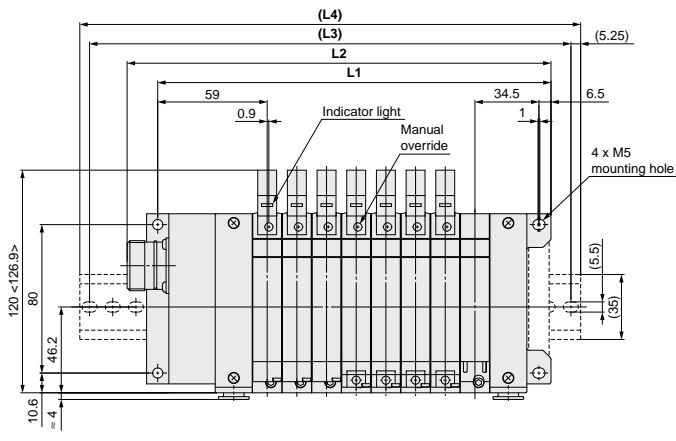
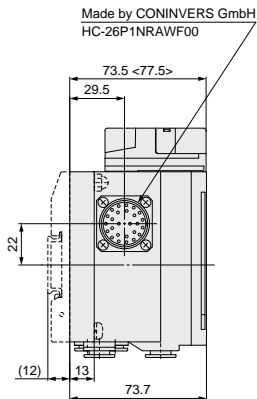

D side Stations -- 1 -- 2 -- 3 -- 4 -- 5 -- 6 -- 7 -- 8 -- n U side

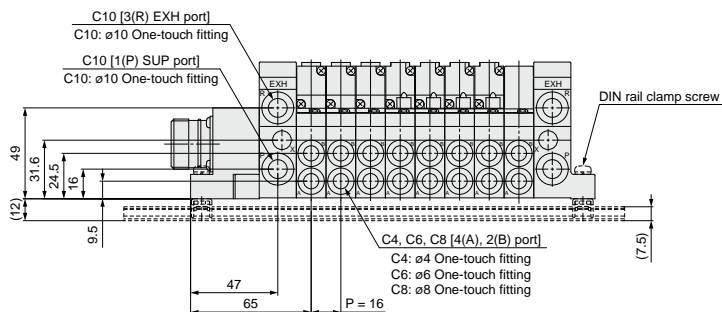

Dimensions

Formula L1 = 16n + 77.5, L2 = 16n + 100.5 n: Station (Maximum 12 stations)

L	n	2	3	4	5	6	7	8	9	10	11	12
L1		109.5	125.5	141.5	157.5	173.5	189.5	205.5	221.5	237.5	253.5	269.5
L2		132.5	148.5	164.5	180.5	196.5	212.5	228.5	244.5	260.5	276.5	292.5
(L3)		162.5	175	187.5	200	225	237.5	250	275	287.5	300	312.5
(L4)		173	185.5	198	210.5	235.5	248	260.5	285.5	298	310.5	323

Series ¹⁰⁻₂₁₋VQ2000

Sub-plate Single Unit

Note) For CE compliant models, DC-type only.



How to Order

Directional Control Valves

Air Cylinders

Rotary Actuators

Air Grippers

Air Preparation Equipment

Modular F. R.

Pressure Control Equipment

Fittings & Tubing

Flow Control Equipment

Pressure Switches/ Pressure Sensors

IP65 enclosure in standard specifications

Easy-to-use terminal block

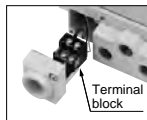

In the case of **Valve** + **Sub-plate**

10 - **VQ2** **1** **0** - **5** **W** **1** - **02** - **□**

Entry is the same as standard products.

10	Clean series
21	Copper/Fluorine/Silicone free + Low particle generation

Enclosure

Nil	Dust-protected
W <small>Note 1)</small>	IP65 (Dust-tight, Water-jet-proof)

Note 1) Valves are IP65 specifications.
Note 2) When the valve is a standard (dust-protected) specification, it is not compatible with 200 or 220 VAC.

•CE compliant

Nil	—
Q	CE compliant

Note) For CE compliant models, DC-type only.

• Thread type

Nil	Rc
N	NPT
T	NPTF
F	G

• Port size

02	1/4
-----------	-----

In the case of **Sub-plate** alone

VQ2000 - PW - 02

Dimensions

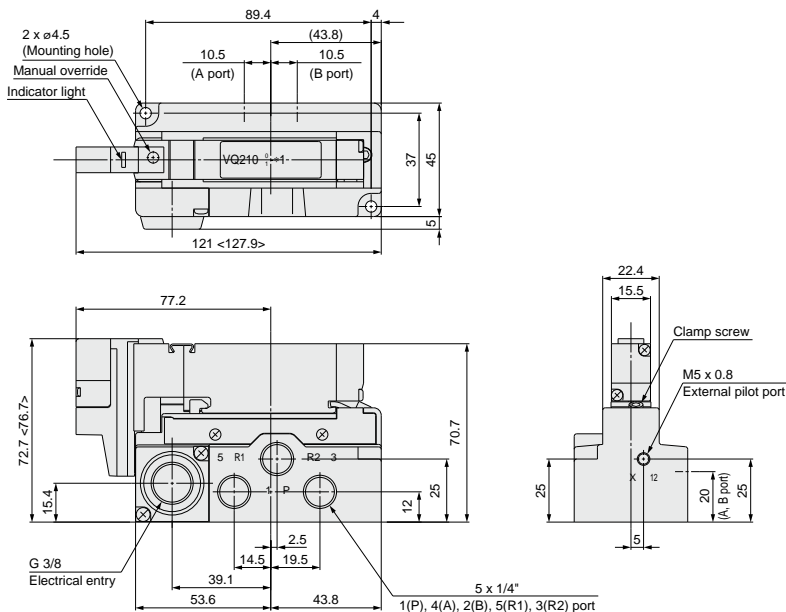

< >: AC

Note) When using this valve for IP65, mount a seal connector to the electrical entry.



Semi-standard

Different Number of Connector Pins

F and P kits with the following number of pins are available besides the standard number (F = 25P; P = 26P). Select the desired number of pins and cable length from the cable assembly list. Place an order for the cable assembly separately.

F kit (D-sub connector)
15 pins

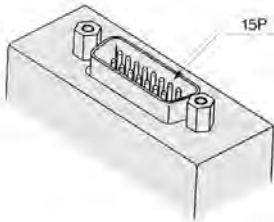

How to Order Manifold

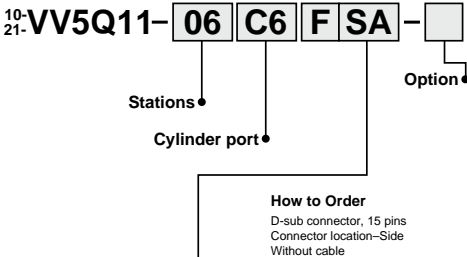

Kit type/Electrical entry

Pins	Location	Top entry	Side entry
15P (Max. 7 stations)		F kit	UA
			F kit
			SA

* In the same way as the 25-pin models (standard), the terminal no. 1 is for SOL.A at the 1st station, the terminal no. 9 for SOL.B at the 1st station, and the terminal no. 8 for COM.

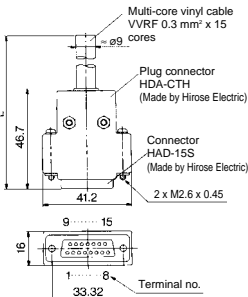

Wire Color Table by Terminal No. of D-sub Connector Cable Assembly

Terminal no.	Lead wire color	Dot marking
1	Black	None
2	Brown	None
3	Red	None
4	Orange	None
5	Yellow	None
6	Pink	None
7	Blue	None
8	Purple	White
9	Gray	Black
10	White	Black
11	White	Red
12	Yellow	Red
13	Orange	Red
14	Yellow	Black
15	Pink	Black

D-sub Connector Cable Assembly

Cable length (L)	Pins	15P
1.5 m		AXT100-DS15-1
3 m		AXT100-DS15-2
5 m		AXT100-DS15-3

* For other commercial connectors, use a type conforming to MIL-C-24308.

P kit (Flat ribbon cable)
10/16/20 pins

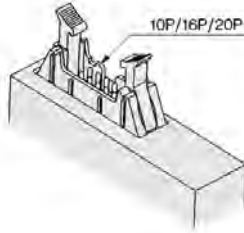

How to Order Manifold

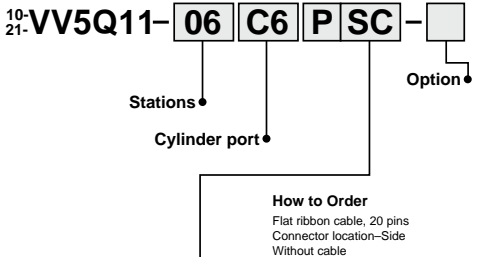

Kit type/Electrical entry

Pins	Location	Top entry	Side entry
10P (Max. 4 stations)	P kit	UA	P kit
16P (Max. 7 stations)		UB	SA
20P (Max. 9 stations)		UC	SB
			SC

* In the same way as the 26-pin models (standard), the terminal no. 1 is for SOL.A at the 1st station, the terminal no. 2 for SOL.B at the 1st station, and two pins from the max. terminal numbers are for COM.

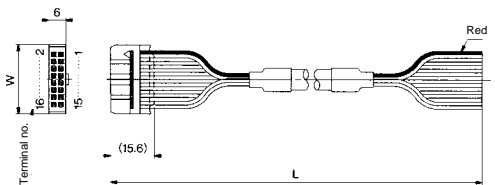

Flat Ribbon Cable Assembly

Cable length (L)	Pins	10P	16P	20P
1.5 m		AXT100-FC10-1	AXT100-FC16-1	AXT100-FC20-1
3 m		AXT100-FC10-2	AXT100-FC16-2	AXT100-FC20-2
5 m		AXT100-FC10-3	AXT100-FC16-3	AXT100-FC20-3
Connector width (W)		17.2	24.8	30

* For other commercial connectors, use a type with strain relief conforming to MIL-C-83503.

Special Wiring Specifications

In the internal wiring of F/P/J/G/T/S kit, double wiring (connected to SOLA and SOLB) is adopted for each station regardless of the valve and option types. Mixed single and double wiring is available as an option.

1. How to Order

Indicate an option symbol "K", for the manifold no. and be sure to specify the mounting position and number of stations of the single and double wiring by means of the manifold specification sheet.

¹⁰⁻VV5Q11-08C6FU1-D K S

Others, option symbols: to be indicated alphabetically.

2. Wiring specifications

With the A side solenoid of the 1st station as no.1 (meaning, to be connected to no.1 terminal), without making any terminals vacant.

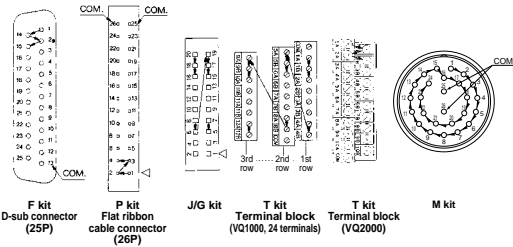

3. Max. number of stations

The maximum number of stations depends upon the number of solenoids. Assuming one for a single and two for a double, determine the number of stations so that the total number is not more than the max. number given in the following table.

Kit	F kit (D-sub connector)		P kit (Flat ribbon cable)				J kit (Flat ribbon cable)	G kit (Flat ribbon cable with terminal block)
Type	F _{25P}	F _{15P}	P _{26P}	P _{20P}	P _{16P}	P _{10P}	J _{20P}	G
Max. points	24	14	24	18	14	8	16	16

Kit	T kit (Terminal block box)		S kit (Serial transmission)	M kit (Circular connector)
Type	¹⁰⁻²¹⁻ VQ1000		S	M
	2 rows of terminal blocks			
	16			
	3 rows of terminal blocks			
	24			
Max. points	¹⁰⁻²¹⁻ VQ2000		16	24

Negative Common Specifications

Specify the valve model no. as shown below for negative common specification.

The manifold no. shown below is for the T (10-VQ1000) and L (10-VQ1000/2000) kits. For other kits the standard manifold can be used. However, negative common is not compatible with S (except EX510 gateway-type, EX240 integrated-type and EX120/121/122 integrated-type (CompoNet™)) and G kits.

How to Order Valve

¹⁰⁻VQ1100 N -51

Negative common specifications

How to Order Manifold

T kit (VQ1000):

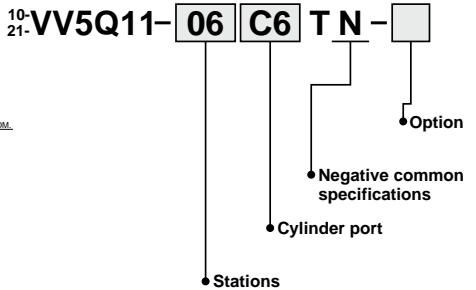

L kit (VQ1000/2000):

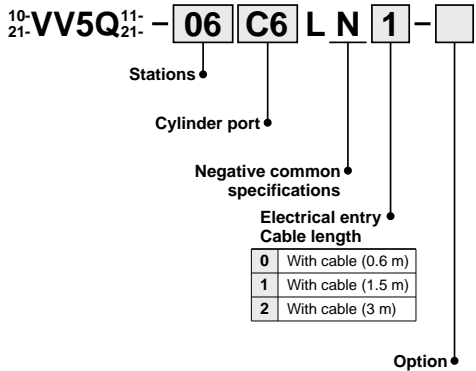

Electrical entry Cable length	
0	With cable (0.6 m)
1	With cable (1.5 m)
2	With cable (3 m)

Directional Control Valves

Air Cylinders

Rotary Actuators

Air Grippers

Air Preparation Equipment

Modular F. R.

Pressure Control Equipment

Fittings & Tubing

Flow Control Equipment

Pressure Switches/ Pressure Sensors

Semi-standard

External Pilot Specifications

When the supply air pressure is lower than the required minimum operating pressure (0.1 to 0.2 MPa) for the solenoid valve (or when the valve is used for vacuum), specify an external pilot model. Order a manifold or valve by suffixing the external pilot specification, "R". The X-port of the manifold base is equipped with One-touch fittings for external pilot.
 VQ1000: C4 (ø4 One-touch fitting)
 VQ2000: C6 (ø6 One-touch fitting)

How to Order Manifold

10-
21-VV5Q11-08C6FU1-R S

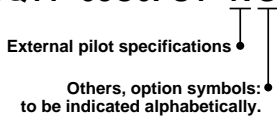

How to Order Valve

10-
21-VQ1100 R - 51



Note 1) When two or more functions are specified, indicate them alphabetically.
 Note 2) Since the pilot EXH of this valve is released from the R1 passage, it is not possible to vacuum from a part other than EXH pressure and SUP ports.

Inch-size One-touch Fittings

The valve with inch-size One-touch fittings is shown below.

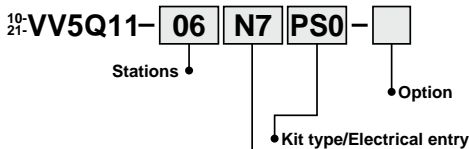

Cylinder port

Symbol	N1	N3	N7	N9	M5T	NM
Applicable tubing O.D. (Inch)	ø1/8"	ø5/32"	ø1/4"	ø5/16"	10-32UNF (MS thread)	Mixed
4(A), 2(B) port	VQ1000	●	●	—	●	●
	VQ2000	—	●	●	—	●

Note) When inch-size fittings are selected for the cylinder port, inch-size fittings are selected on 1(P), 3(R) port, too.

1(P), 3(R) port size
 VQ1000 ø5/16" (N9)
 VQ2000 ø3/8" (N11)

DIN Rail Mounting

Each manifold can be mounted on a DIN rail. Order it by indicating a DIN rail mounting option symbol, "-D". In this case, a DIN rail which is approx. 30 mm longer than the manifold with the specified number of stations is attached.

- **When DIN rail is unnecessary**
 (DIN rail mounting brackets only are attached.)
 Indicate the option symbol, -D0, for the manifold part number.

How to Order Manifold

10-
21-VV5Q11-08C6FU1-D0S

Others, option symbols: to be indicated alphabetically.

- **When using DIN rail longer than the manifold with specified number of stations**
 Clearly indicate the necessary number of stations next to the option symbol "D" for the manifold part number.

How to Order Manifold

10-
21-VV5Q11-08C6FU1-D09S

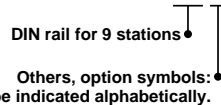

*The number of stations that may be displayed is longer than the manifold number of stations.

- **When changing to a DIN rail mounting.**
 Order brackets for mounting a DIN rail. (Refer to "Manifold Optional Parts" on pages 572 and 574.)

No. VVQ1000-57A (For VQ1000)
 VVQ2000-57A (For VQ2000)
 2 pcs. per one set.

- **When ordering DIN rail only**
 DIN rail no.: AXT100-DR-□

* As for □, specify the number from the DIN rail table. Refer to the dimensions of each kit for L dimension.

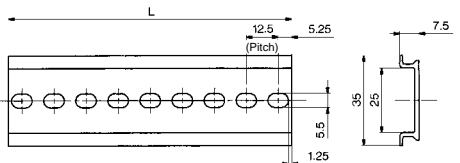

L Dimension

L = 12.5 x n + 10.5

No.	1	2	3	4	5	6	7	8	9	10
L dimension	23	35.5	48	60.5	73	85.5	98	110.5	123	135.5
No.	11	12	13	14	15	16	17	18	19	20
L dimension	148	160.5	173	185.5	198	210.5	223	235.5	248	260.5
No.	21	22	23	24	25	26	27	28	29	30
L dimension	273	285.5	298	310.5	323	335.5	348	360.5	373	385.5
No.	31	32	33	34	35	36	37	38	39	40
L dimension	398	410.5	423	435.5	448	460.5	473	485.5	498	510.5

Series 10-21-VQ1000/2000 Construction

10-21-VQ1000 Plug-in Unit: Main Parts/Replacement Parts

Metal seal

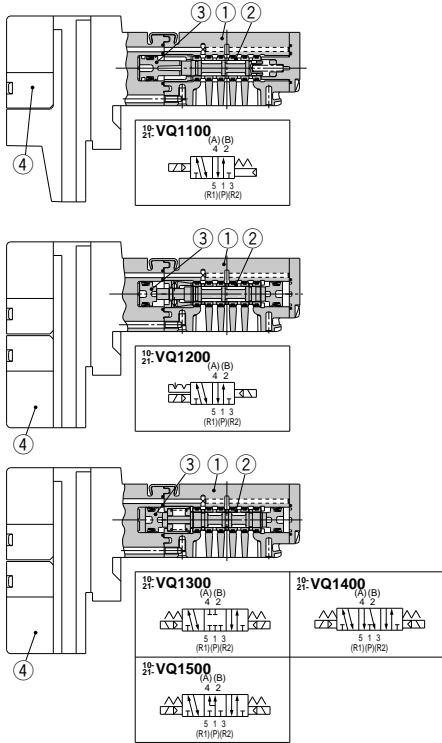

Component Parts

No.	Description	Material	Note
1	Body	Zinc die-casted	
2	Spool/Sleeve	Stainless steel	
3	Piston	Resin	
4	Pilot valve assembly	—	

Note) Refer to page 568 for "How to Order Pilot Valve Assembly".

Rubber seal

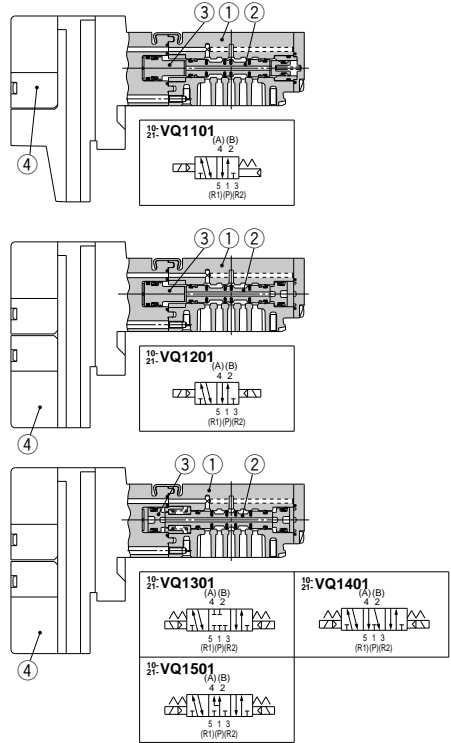

Component Parts

No.	Description	Material	Note
1	Body	Zinc die-casted	
2	Spool valve	Aluminum, HNBR	
3	Piston	Resin	
4	Pilot valve assembly	—	

Note) Refer to page 568 for "How to Order Pilot Valve Assembly".

Directional Control Valves

Air Cylinders

Rotary Actuators

Air Grippers

Air Preparation Equipment

Modular F. R.

Pressure Control Equipment

Fittings & Tubing

Flow Control Equipment

Pressure Switches/Pressure Sensors

10-21-VQ2000 Plug-in Unit: Main Parts/Replacement Parts

Metal seal

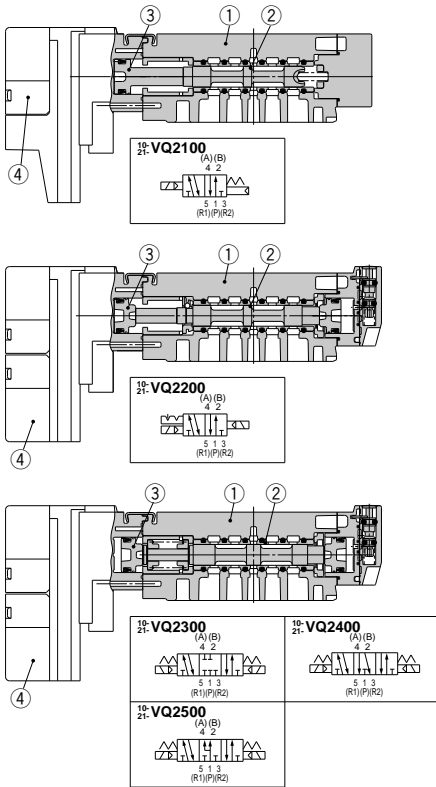

Rubber seal

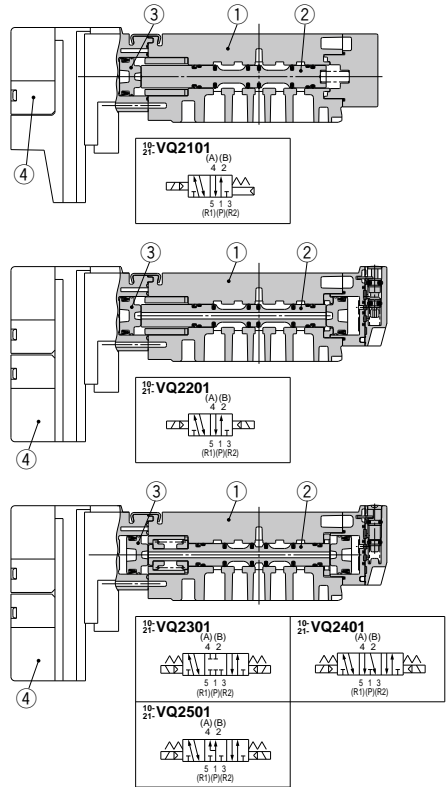

Component Parts

No.	Description	Material	Note
1	Body	Zinc die-casted	
2	Spool/Sleeve	Stainless steel	
3	Piston	Resin	
4	Pilot valve assembly	—	

Note) Refer to page 568 for "How to Order Pilot Valve Assembly".

Component Parts

No.	Description	Material	Note
1	Body	Zinc die-casted	
2	Spool valve	Aluminum, HNBR	
3	Piston	Resin	
4	Pilot valve assembly	—	

Note) Refer to page 568 for "How to Order Pilot Valve Assembly".

Exploded View of Manifold

10-
21-VQ1000 Plug-in Unit: Exploded View

(F/P/J/L/S kit)

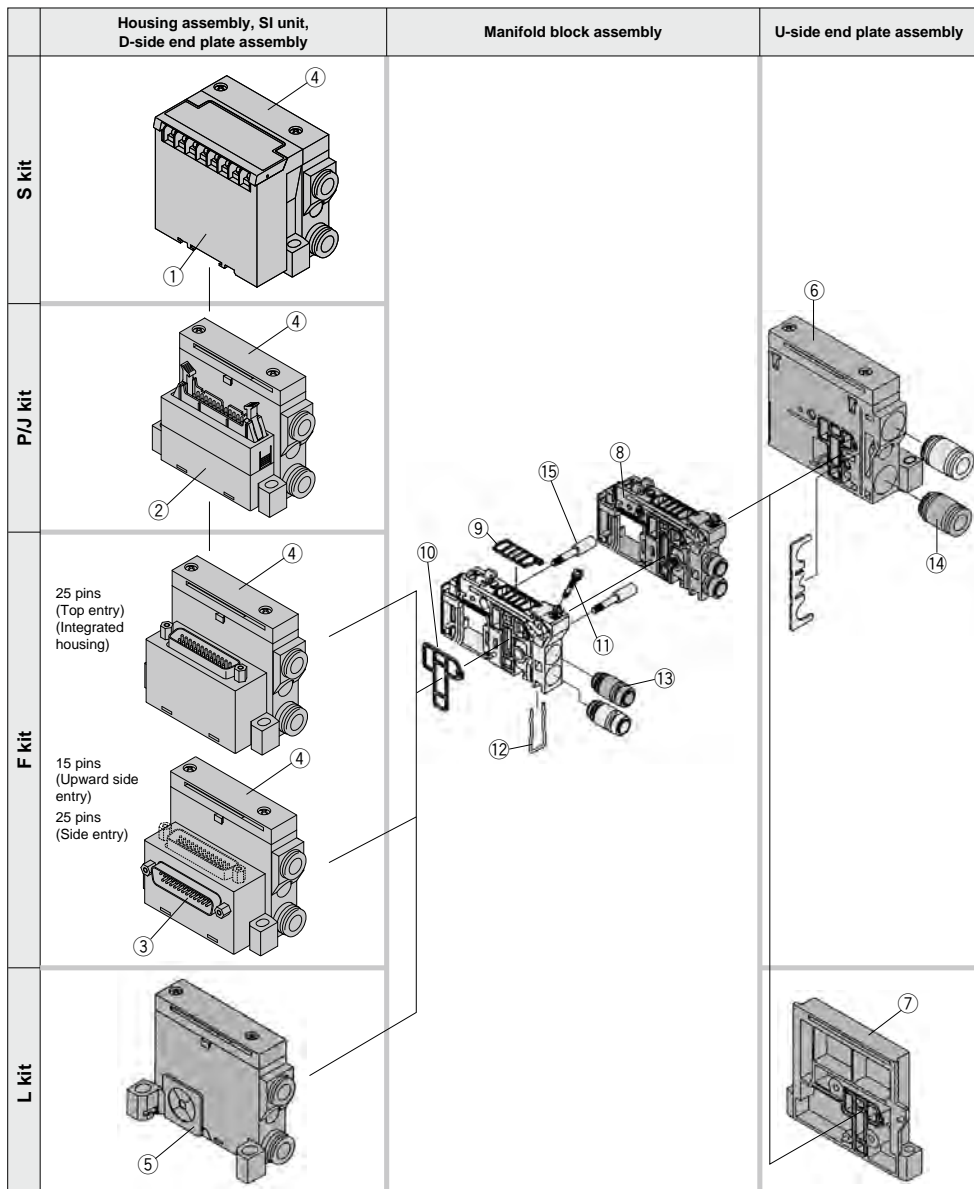

<Housing Assembly and SI Unit>

Housing assembly and SI unit no.

No.	Manifold	Part no.	Description
①	(SF1 kit)	EX120-SUW1(-XP) <small>Note 2)</small>	NKE Corp.: Fieldbus System (16 outputs)
	(SH kit)	EX120-SUH1(-XP) <small>Note 2)</small>	NKE Corp.: Fieldbus H System (16 outputs)
	(SJ1 kit)	EX120-SSL1(-XP) <small>Note 2)</small>	Panasonic Industrial Devices SUNX Co., Ltd.: S-LINK System (16 outputs)
	(SJ2 kit)	EX120-SSL2(-XP) <small>Note 2)</small>	Panasonic Industrial Devices SUNX Co., Ltd.: S-LINK System (8 outputs)
	(SQ kit)	EX120-SDN1	DeviceNet™
	(SR1 kit)	EX120-SCS1(-XP) <small>Note 2)</small>	OMRON Corp.: CompoBus/S (16 outputs)
	(SR2 kit)	EX120-SCS2(-XP) <small>Note 2)</small>	OMRON Corp.: CompoBus/S (8 outputs)
	(SV kit)	EX120-SMJ1(-XP) <small>Note 2)</small>	CC-Link
	(SZB kit)	EX120-SCM1	CompoNet™ (Positive common)
	(SZBN kit)	EX120-SCM3	CompoNet™ (Negative common)
②	P $\frac{1}{2}$ kit	AXT100-1-P $\frac{1}{2}$ <small>Note 1)</small>	Flat ribbon cable housing assembly □ = Number of pins: 26/20/16/10
	J $\frac{1}{2}$ kit	AXT100-1-J $\frac{1}{2}$ <small>Note 1)</small>	Flat ribbon cable housing assembly
③	FU kit	AXT100-1-FU15	D-sub connector housing assembly (Top entry) Number of pins: 15
	FS kit	AXT100-1-FS□	D-sub connector housing assembly (Side entry) □ = Number of pins: 25/15

Note 1) Top entry connector for PU, JU while side entry connector for PS, JS.
 Note 2) Suffix "-XP" to the end of the part number for dust-protected SI unit. (Not available for S/SQ kit)

<D-Side End Plate Assembly>

④⑤ D-side end plate assembly no.

VVQ1000-3A-1-□-□

Electrical entry ●

FU25	For F kit top entry 25 pins
F	For F kit other than above
P	For P kit
J	For J kit
L	For L kit
S	For S kit

● Option

Nil	Common EXH
R <small>Note 1)</small>	External pilot
S <small>Note 1)</small>	Direct EXH outlet with built-in silencer

Note 1) When both options are specified, indicate as RS.
 Note 2) The housing assembly and SI unit of F/P/J/S kit are not included (except FU25). Separately place an order for ①, ②, ③.

<Manifold Block Assembly>

⑧ Manifold block assembly no.

VVQ1000-1A-□-□

Tie-rod (2 pcs.) and lead wire assembly for extensions are attached.

Electrical entry ●

F0	Without lead wire
F1	F kit for 2 to 12 stations/Double wiring
F2	F kit for 13 to 24 stations/Double wiring
F3	F kit for 2 to 24 stations/Single wiring
P1	P/J/S kit for 2 to 12 stations/Double wiring
P2	P/J/S kit for 13 to 24 stations/Double wiring
P3	P/J/S kit for 2 to 24 stations/Single wiring
L0□	L0 kit □: Stations (1 to 8)
L1□	L1 kit □: Stations (1 to 8)
L2□	L2 kit □: Stations (1 to 8)

● Port size

C3	With ø3.2 One-touch fitting
C4	With ø4 One-touch fitting
C6	With ø6 One-touch fitting
M5	M5 thread
C0	Without One-touch fitting (With clip)

Note) Purchase orders are available in units of 10 pieces.

C3	Applicable tubing ø3.2
C4	Applicable tubing ø4
C6	Applicable tubing ø6
M5	M5 thread

⑫ Fitting assembly part no. (For 1(P), 3(R) port)

VVQ1000-51A-C8

● Applicable tubing ø8

Note) Purchase orders are available in units of 10 pieces.

⑬ Tie-rod assembly part no. (2 pcs./set)

VVQ1000-TR-□

Note 1) Please order when eliminating manifold stations.
 When adding stations, tie-rods are attached to the manifold block assembly. Therefore, it is not necessary to order.

Note 2) □: Stations 02 to 24
 Note 3) For S/P/J/F/L kit

Pilot valve assembly

10: VV12 □ - □ □

<Replacement Parts for Manifold Block>

Replacement Parts

No.	Part no.	Description	Material	Quantity
⑨	VVQ1000-80A-1	Gasket	HNBR	12
⑩	VVQ1000-80A-2	Seal	HNBR	12
⑪	VVQ1000-80A-3	Clamp screw	Carbon steel	12
⑫	VVQ1000-80A-4	Clip	Stainless steel	12

Note) A set of parts containing 12 pcs. each is enclosed.

● Function

Symbol	Specifications	DC (0.4 W)	AC (Note 1)
Nil	Standard	○	○
B	High-speed response type	○	—
K	High-pressure type (1.0 MPa)	○	—

● Coil voltage

	DC	AC
1	100 VAC (50/60 Hz)	—
2	200 VAC (50/60 Hz)	—
3	110 VAC (50/60 Hz)	—
4	220 VAC (50/60 Hz)	—
5	24 VDC	—
6	12 VDC	—

● Enclosure

A	Dust-tight, Water-jet-proof (IP65)
B	Dust-protected

Note 1) Refer to page 522 for power consumption of AC type.
 Note 2) Common to single solenoid and double solenoid

Directional Control Valves

Air Cylinders

Rotary Actuators

Air Grippers

Air Preparation Equipment

Modular F. R.

Pressure Control Equipment

Fittings & Tubing

Flow Control Equipment

Pressure Switches/Pressure Sensors

Exploded View of Manifold

10-21-VQ2000 Plug-in Unit: Exploded View

(F/P/J/L/G/S kit)

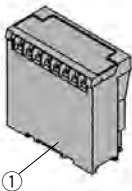
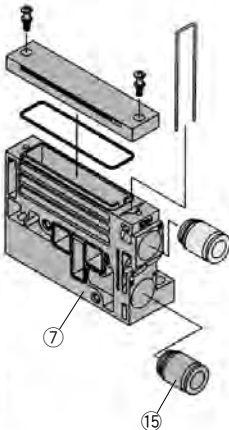
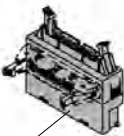
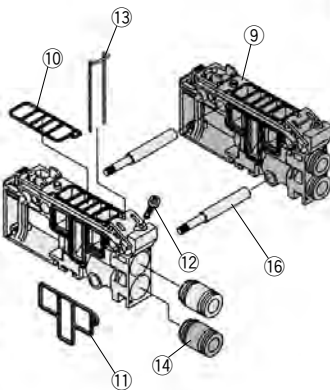
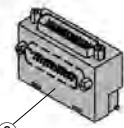
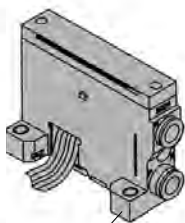
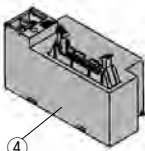
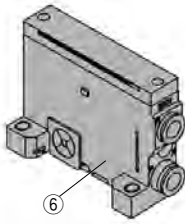
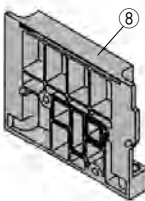
	Housing assembly and SI unit	D-side end plate assembly	Manifold block assembly	U-side end plate assembly
S kit				
P/J kit				
F kit				
G kit				
L kit				

<Housing Assembly and SI Unit>
Housing assembly and SI unit no.

No.	Manifold	Part no.	Description
①	(SF1 kit)	EX120-SUW1(-XP) ^{Note 1)} [EX123D-SUW1] ^{Note 2)}	NKE Corp.: Fieldbus System (16 outputs)
	(SH1 kit)	EX120-SUH1(-XP) ^{Note 1)} [EX123D-SUH1] ^{Note 2)}	NKE Corp.: Fieldbus H System (16 outputs)
	(SJ1 kit)	EX120-SSL1(-XP) ^{Note 1)} [EX123D-SSL1] ^{Note 2)}	Panasonic Industrial Devices SUNX Co., Ltd.: S-LINK System (16 outputs)
	(SJ2 kit)	EX120-SSL2(-XP) ^{Note 1)} [EX123D-SSL2] ^{Note 2)}	Panasonic Industrial Devices SUNX Co., Ltd.: S-LINK System (8 outputs)
	(SQ kit)	EX120-SDN1 [EX124D-SDN1] ^{Note 2)}	DeviceNet™
	(SR1 kit)	EX120-SCS1(-XP) ^{Note 1)} [EX124D-SCS1] ^{Note 2)}	OMRON Corp.: CompoBus/S (16 outputs)
	(SR2 kit)	EX120-SCS2(-XP) ^{Note 1)} [EX124D-SCS2] ^{Note 2)}	OMRON Corp.: CompoBus/S (8 outputs)
	(SV kit)	EX120-SMJ1(-XP) ^{Note 1)} [EX124D-SMJ1] ^{Note 2)}	CC-Link
	(SZB kit)	EX120-SCM1	CompoNet™ (Positive common)
	(SZBN kit)	EX120-SCM3	CompoNet™ (Negative common)
②	P _{1/2} kit	AXT100-1-P _{1/2} ^{Note 3)}	Flat ribbon cable housing assembly □: Number of pins: 26/20/16/10
	J _{1/2} kit	AXT100-1-J _{1/2} ^{Note 3)}	Flat ribbon cable housing assembly
③	F _{1/2} kit	AXT100-1-F _{1/2} ^{Note 3)}	D-sub connector housing assembly □: Number of pins: 25/15
④	G kit	AXT100-1-GU20	Flat ribbon cable housing assembly with terminal block

Note 1) Suffix "-XP" to the end of the part number for dust-protected SI unit.
 Note 2) Dust-tight, Water-jet-proof (IP65)
 Note 3) Top entry connector for FU, PU, JU while side entry connector for FS, PS, JS.

<D-Side End Plate Assembly>

⑤ ⑥ **D-side end plate assembly no.**

VVQ2000-3A-1-□-□

Electrical entry

F	For F kit
P	For P kit
J	For J kit
L	For L kit
G	For G kit
S	For S kit

Enclosure

Nil	Dust-protected
W	Dust-tight, Water-jet-proof (IP65)

Note) F/P/J/G kit are available with "Nil" only.
 M kit is available with [W] only.
 S/L/T kit are selectable depending on the manifold type.

Option

Nil	Common EXH
R	External pilot
S	Direct EXH outlet with built-in silencer

Note 1) When both options are specified, indicate as RS.
 Note 2) The housing assembly and SI unit of F/P/J/G/S kit are not included.
 Separately place an order for ①, ②, ③, ④.
 Note 3) "S" (Built-in silencer) and "W" (IP65) cannot be combined.

<Manifold Block Assembly>

⑨ **Manifold block assembly no.**

VVQ2000-1A-□-□-□

Tie-rod (2 pcs.) and lead wire assembly for extensions are attached.

Electrical entry

F0	Without lead wire
F1	F kit for 2 to 12 stations/Double wiring
F2	F kit for 13 to 24 stations/Double wiring
F3	F kit for 2 to 24 stations/Single wiring
P1	P/J/G/S kit for 2 to 12 stations/Double wiring
P2	P/J/G/S kit for 13 to 24 stations/Double wiring
P3	P/J/G/S kit for 2 to 24 stations/Single wiring
L0□	L0 kit □: Stations (1 to 8)
L1□	L1 kit □: Stations (1 to 8)
L2□	L2 kit □: Stations (1 to 8)
T1	T kit for 2 to 20 stations/Double wiring
T3	T kit for 2 to 20 stations/Single wiring
M1	M kit for 2 to 12 stations/Double wiring
M2	M kit for 13 to 24 stations/Double wiring
M3	M kit for 2 to 24 stations/Single wiring

Port size

C4	With ø4 One-touch fitting
C6	With ø6 One-touch fitting
C8	With ø8 One-touch fitting
C0	Without One-touch fitting (With clip)

Enclosure

Nil	Dust-protected
W	Dust-tight, Water-jet-proof (IP65)

Note) F/P/J/G kit are available with "Nil" only.
 M kit is available with [W] only.
 S/L/T kit are selectable depending on the manifold type.

<Replacement Parts for Manifold Block>

Replacement Parts

No.	Part no.	Description	Material	Quantity
⑩	VVQ2000-80A-1	Gasket	HNBR	12
⑪	VVQ2000-80A-2	Seal	HNBR	12
⑫	VVQ2000-80A-3	Clamp screw	Carbon steel	12
⑬	VVQ2000-80A-4	Clip	Stainless steel	12

Note) A set of parts containing 12 pcs. each is enclosed.

<U-Side End Plate Assembly>

⑦ **U-side end plate assembly no. (For F/P/J/G/T/S/M kit)**

VVQ2000-2A-1-□-□

Option

Nil	Common EXH
R	External pilot
S	Direct EXH outlet with built-in silencer

Enclosure

Nil	Dust-protected
W	Dust-tight, Water-jet-proof (IP65)

Note) F/P/J/G kit are available with "Nil" only.
 M kit is available with [W] only.
 S/T kit are selectable depending on the manifold type.

Note 1) The ⑧'s fitting assembly is included.
 Note 2) The housing assembly and SI unit of F/P/J/G/S kit are not included.
 Separately place an order for ①, ②, ③, ④.
 Note 3) "S" (Built-in silencer) and "W" (IP65) cannot be combined.

⑧ **U-side end plate assembly no. (For L kit)**

VVQ2000-2A-1-L-□

Enclosure

Nil	Dust-protected
W	Dust-tight, Water-jet-proof (IP65)

Note) Select it depending on the manifold type.

<Fitting Assembly>

⑭ **Fitting assembly part no. (For cylinder port)**

VVQ1000-51A-□

Port size

C4	Applicable tubing ø4
C6	Applicable tubing ø6
C8	Applicable tubing ø8

Note) Purchase orders are available in units of 10 pieces.

⑮ **Fitting assembly part no. (For 1(R), 3(R) port)**

VVQ2000-51A-C10

Applicable tubing ø10

Note) Purchase orders are available in units of 10 pieces.

⑯ **Tie-rod assembly part no. (2 pcs./set)**

VVQ2000-TR-□

Note 1) Please order when eliminating manifold stations.

When adding stations, tie-rods are attached to the manifold block assembly. Therefore, it is not necessary to order.

Note 2) □: Stations 02 to 24
 Note 3) For S/P/J/F/L kit

Directional Control Valves
 Air Cylinders
 Rotary Actuators
 Air Grippers
 Air Preparation Equipment
 Modular F. R.
 Pressure Control Equipment
 Fittings & Tubing
 Flow Control Equipment
 Pressure Switches/Pressure Sensors

10-
21-VQ1000: Manifold Optional Parts

Blanking plate assembly
VVQ1000-10A-1

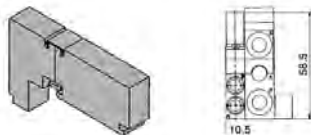

It is used by attaching on the manifold block for being prepared for removing a valve for maintenance reasons or planning to mount a spare valve, etc.

Individual SUP spacer
VVQ1000-P-1-C6
N7

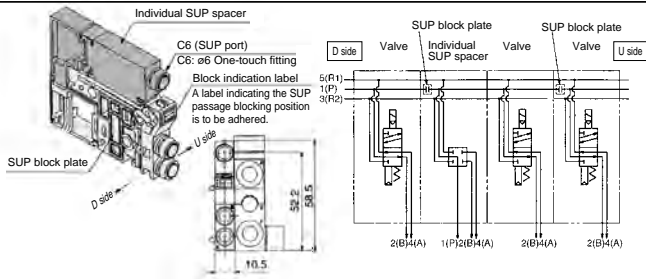

When the same manifold is to be used for different pressures, individual SUP spacers are used as SUP ports for different pressures. (One station space is occupied.) Block both sides of the station, for which the supply pressure from the individual SUP spacer is used, with SUP block plates. (Refer to the application example.)

* Specify the spacer mounting position and SUP block plate position by means of the manifold specification sheet. The block plate is used in one or two places for one set. (Two SUP block plates for blocking SUP station are attached to the individual SUP spacer.)

- * As a standard, electric wiring is connected to the position of the manifold station where the individual SUP spacer is mounted.
- * If wiring is not required for stations equipped with spacers, enter "X" in the special wiring specifications column in the manifold specification sheet.

Individual EXH spacer
VVQ1000-R-1-C6
N7

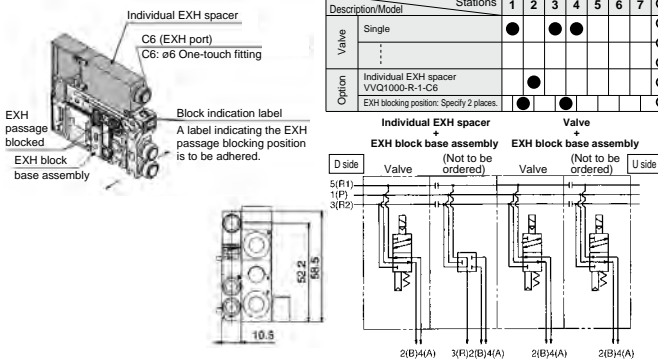

When valve exhaust affects other stations due to the circuit configuration, this spacer is used for individual valve exhaust. (One station space is occupied.) Block both sides of the individual valve EXH station. (Refer to the application example.)

- * Specify the mounting position, as well as the EXH block base or EXH block plate position by means of the manifold specification sheet. The block plate is used in one or two places for one set.

* An EXH block base assembly is used in the blocking position when ordering an EXH spacer incorporated with a manifold no. However, do not order an EXH block base assembly because it is attached to the spacer.

When separately ordering an individual EXH spacer, separately order an EXH block base assembly because it is not attached to the spacer.

- * As a standard, electric wiring is connected to the position of the manifold station where the individual EXH spacer is mounted.
- * If wiring is not required for stations equipped with spacers, enter "X" in the special wiring specifications column in the manifold specification sheet.

Description/Model		Stations						
		1	2	3	4	5	6	7
Valve	Single		●	●	●			
	Individual EXH spacer VVQ1000-R-1-C6							
Option	EXH blocking position: Specify 2 places.		●					
				●				

SUP block plate
VVQ1000-16A



When different pressures are supplied to a manifold, a SUP block plate is used to block the stations under different pressures.

- * Specify the mounting position by means of the manifold specification sheet.

<Block indication label>

Indication labels to confirm the blocking position are attached (Each for SUP passage and SUP/EXH passage blocking positions).

- * When ordering a block plate incorporated with a manifold, a block indication label is attached to the manifold.



SUP passage blocked



SUP/EXH passage blocked

EXH block base assembly VVQ1000-19A- (C3/C4/C6/M5/N1/N3/N7)

Manifold block assembly Electrical entry

F0	Without lead wire
F1	For F kit (2 to 12 stations)/Double wiring
F2	For F kit (13 to 24 stations)/Double wiring
F3	For F kit (2 to 24 stations)/Single wiring
P1	For P, G, T, S kit (2 to 12 stations)/Double wiring
P2	For P, G, T, S kit (13 to 24 stations)/Double wiring
P3	For P, G, T, S kit (2 to 24 stations)/Single wiring
L0*	L0 kit
L1*	L1 kit * 1 to 8 stations
L2*	L2 kit

The manifold block assembly is used between stations for which exhaust is desired to be divided when valve exhaust affects other stations due to the circuit configuration. The EXH passage on the D-side is blocked in the EXH block base assembly. It is also used in combination with an individual EXH spacer for individual exhaust.

<Block indication label>

Indication labels to confirm the blocking position are attached. (Each for EXH passage and SUP/EXH passage blocking positions)

* When ordering a EXH block base incorporated with a manifold, a block indication label is attached to the manifold.

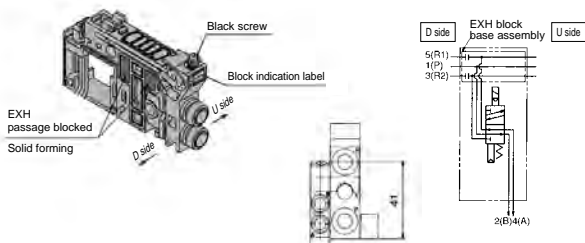

* Specify the mounting station by means of the manifold specification sheet.

* When ordering this option incorporated with a manifold, specify the EXH block base assembly part number with "*" in front of it beneath the manifold part number.



EXH passage blocked



SUP/EXH passage blocked

Back pressure check valve assembly [-B] VVQ1000-18A

It prevents cylinder malfunction caused by other valve exhaust entry. Insert it into R (EXH) port on the manifold side of a valve which is affected. It is effective when a single-acting cylinder is used or an exhaust center type solenoid valve is used.

* When ordering it being mounted on all manifold stations, suffix "B" to the end of the manifold part number.

Note) When a back pressure check valve is desired, and is to be installed only in certain manifold stations, clearly indicate the part number and specify the mounting station by means of the manifold specification sheet.



(Precautions)

1. The back pressure check valve assembly is the parts with a check valve structure. However, since the valve has slight air leakage, take precautions for the exhaust air not to be restricted at the exhaust port.
2. When a back pressure check valve is mounted, the effective area of the valve will decrease by about 20%.

Name plate [-N] VVQ1000--N-Station (1 to Max. stations)

It is a transparent resin plate for placing a label that indicates solenoid valve function, etc. Insert it into the groove on the side of the end plate and bend it as shown in the figure.

* When the blanking plate with connector is mounted, it automatically will be "VVQ1000-NC-1"

* When ordering this option incorporated with a manifold, suffix "-N" to the end of the manifold part number.

N: Standard
NC: For mounting blanking plate with connector

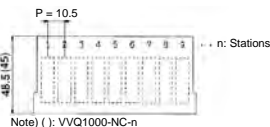
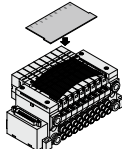

Blanking plug (For One-touch fittings) KQ2P-

It is inserted into an unused cylinder port and SUP/EXH ports. Purchase orders are available in units of 10 pieces.

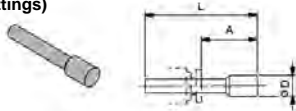

Dimensions

Applicable fitting size ød	Model	A	L	D	Applicable fitting size ød	Model	A	L	D
3.2	KQ2P-23	16	31.5	3.2	1/8"	KQ2P-01	16	31.5	5
4	KQ2P-04	16	32	6	5/32"	KQ2P-03	16	32	6
6	KQ2P-06	18	35	8	1/4"	KQ2P-07	18	35	8.5
8	KQ2P-08	20.5	39	10	5/16"	KQ2P-09	20.5	39	10

Port plug VVQ0000-58A

The plug is used to block the cylinder port.

* When ordering this option incorporated with a manifold, indicate "CM" for the port size of the manifold part number, as well as, the mounting station and cylinder port mounting positions 4(A) and 2(B) by means of the manifold specification sheet.

* Gently screw an M3 screw in the port plug hole and pull it for removal.

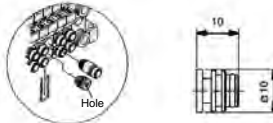

DIN rail mounting bracket [-D,-D0,-D□] VVQ1000-57A

This bracket is used for mounting the manifold on the DIN rail.

* When ordering this option incorporated with a manifold, suffix "-D" to the end of the manifold part number.

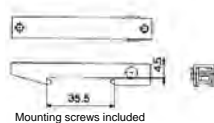
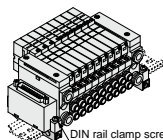

1 set of DIN rail mounting brackets for 1 manifold includes 2 brackets.

Directional Control Valves

Air Cylinders

Rotary Actuators

Air Grippers

Air Preparation Equipment

Modular F. R.

Pressure Control Equipment

Fittings & Tubing

Flow Control Equipment

Pressure Switches/ Pressure Sensors

10-21-VQ2000

10-21-VQ2000: Manifold Optional Parts

Blanking plate assembly VVQ2000-10A-1

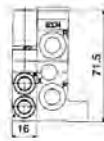
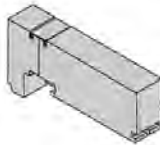

It is used by attaching on the manifold block for being prepared for removing a valve for maintenance reasons or planning to mount a spare valve, etc.

Individual SUP spacer VVQ2000-P-1-C8-N9

When the same manifold is to be used for different pressures, individual SUP spacers are used as SUP ports for different pressures. (One station space is occupied.)

Block both sides of the station, for which the supply pressure from the individual SUP spacer is used, with SUP block plates. (Refer to the application example.)

* Specify the spacer mounting position and SUP block plate position by means of the manifold specification sheet. The block plate is used in one or two places for one set. (Two SUP block plates for blocking SUP station are attached to the individual SUP spacer.)

* As a standard, electric wiring is connected to the position of the manifold station where the individual SUP spacer is mounted.

* If wiring is not required for stations equipped with spacers, enter "X" in the special wiring specifications column in the manifold specification sheet.

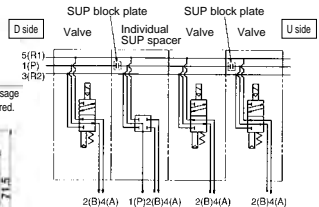
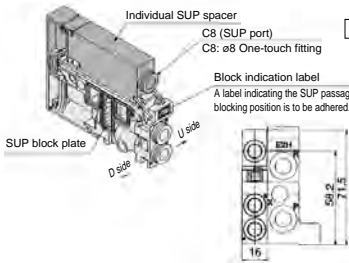

Individual EXH spacer VVQ2000-R-1-C8-N9

When valve exhaust affects other stations due to the circuit configuration, this spacer is used for individual valve exhaust. (One station space is occupied.)

Block both sides of the individual valve EXH station. (Refer to the application example.)

* Specify the mounting position, as well as the EXH block base or EXH block plate position by means of the manifold specification sheet.

The block plate is used in one or two places for one set. (Two EXH block plates for blocking EXH station are attached to the individual EXH spacer.)

* As a standard, electric wiring is connected to the position of the manifold station where the individual EXH spacer is mounted.

* If wiring is not required for stations equipped with spacers, enter "X" in the special wiring specifications column in the manifold specification sheet.

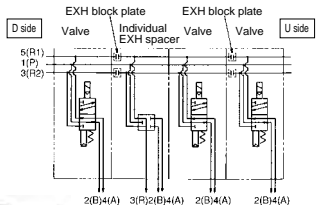
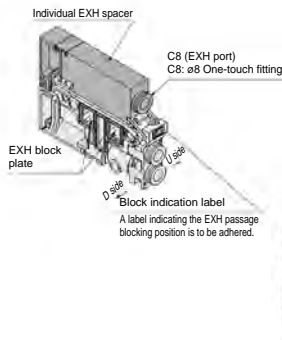

SUP block plate VVQ2000-16A

When different pressures are supplied to a manifold, a SUP block plate is used to block the stations under different pressures.

* Specify the mounting position by means of the manifold specification sheet.

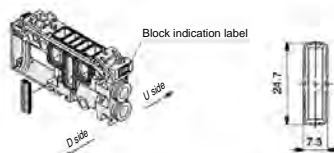

<Block indication label>

Indication labels to confirm the blocking position are attached. (Each for SUP passage and SUP/EXH passage blocking positions)



SUP passage blocked



SUP/EXH passage blocked

* When ordering a block plate incorporated with a manifold, a block indication label is attached to the manifold.

EXH block plate VVQ2000-19A

The EXH block plate is used between stations for which exhaust is desired to be divided when valve exhaust affects other stations configuration. It is also used in combination with an individual EXH spacer for individual exhaust.

* Specify the mounting position by means of the manifold specification sheet.

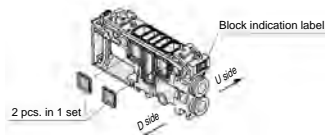

<Block indication label>

Indication labels to confirm the blocking position are attached. (Each for EXH passage and SUP/EXH passage blocking positions)



EXH passage blocked



SUP/EXH passage blocked

* When ordering a block plate incorporated with a manifold, a block indication label is attached to the manifold.

**Back pressure check valve assembly [-B]
VVQ2000-18A**

It prevents cylinder malfunction caused by other valve exhaust entry. Insert it into R (EXH) port on the manifold side of a valve which is affected. It is effective when a single-acting cylinder is used or an exhaust center type solenoid valve is used.
 * When ordering assemblies incorporated with a manifold, add suffix "-B" to the end of the manifold part number.
 Note) When a check valve for back pressure prevention is desired and is to be installed only in certain manifold stations, clearly indicate the part number and specify the mounting position by means of the manifold specification sheet.

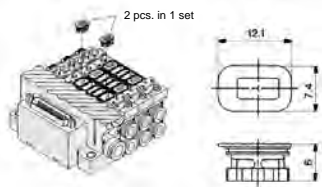

(Precautions)

1. The back pressure check valve assembly is assembly parts with a check valve structure. However, since the valve has slight air leakage, take precautions for the exhaust air not to be restricted at the exhaust port.
2. When a back pressure check valve is mounted, the effective area of the valve will decrease by about 20%.

**Name plate [-N]
VVQ2000-N-Station (1 to Max. stations)**

It is a transparent resin plate for placing a label that indicates solenoid valve function, etc. Insert it into the groove on the side of the end plate and bend it as shown in the figure.
 * When ordering this option incorporated with a manifold, suffix "-N" to the end of the manifold part number.

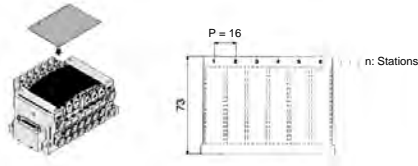

**Blanking plug (For One-touch fittings)
KQ2P-□**

It is inserted into an unused cylinder port and SUP/EXH ports. Purchase orders are available in units of 10 pieces.

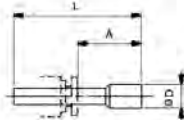

Dimensions

Applicable fitting size ød	Model	A	L	D	Applicable fitting size ød	Model	A	L	D
4	KQ2P-04	16	32	6	5/32"	KQ2P-03	16	32	6
6	KQ2P-06	18	35	8	1/4"	KQ2P-07	18	35	8.5
8	KQ2P-08	20.5	39	10	5/16"	KQ2P-09	20.5	39	10
10	KQ2P-10	22	43	12	3/8"	KQ2P-11	22	43	11.5

**DIN rail mounting bracket [-D,-D0,-D□]
VVQ2000-57A**

This bracket is used for mounting the manifold on the DIN rail.
 * When ordering this option incorporated with a manifold, suffix "-D" to the end of the manifold part number.

1 set of DIN rail mounting brackets for 1 manifold includes 2 brackets.

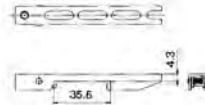
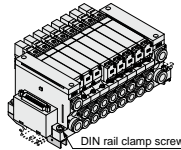

Directional Control Valves

Air Cylinders

Rotary Actuators

Air Grippers

Air Preparation Equipment

Modular F. R.

Pressure Control Equipment

Fittings & Tubing

Flow Control Equipment

Pressure Switches/ Pressure Sensors



Series 10-21-VQ1000/2000

Specific Product Precautions 1

Be sure to read this before handling.

Refer to page 1382 for Safety Instructions and pages 677 to 683 for 3/4/5 Port Solenoid Valve Precautions.

Light/Surge Voltage Suppressor

⚠ Caution

The lighting positions are concentrated on one side for both single solenoid type and double solenoid type. In the double solenoid type, A side and B side energization are indicated by two colors which match the colors of the manual overrides.

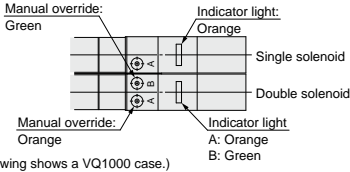

DC circuit diagram

Single solenoid

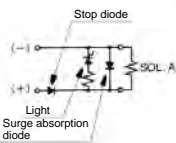

Double solenoid

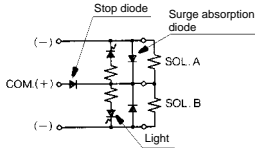

Note) A-side energization:
A light (Orange) illuminates.
B-side energization:
B light (Green) illuminates.

With wrong wiring prevention (stop diode) mechanism
With a surge absorption (surge absorption diode) mechanism

Manual Override

⚠ Warning

Without an electric signal for the solenoid valve the manual override is used for switching the main valve. Push type is standard. (Tool required) Locking type is semi-standard. (Tool required/Manual)

■ Push type (Tool required)

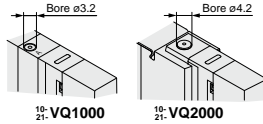

Push down on the manual override with a small screwdriver, etc. until it stops. Release the screwdriver and the manual override will return.

■ Locking type (Tool required) <Semi-standard>

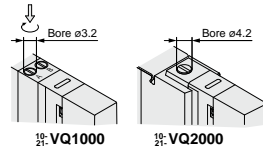

Push down on the manual override with a flat head screwdriver until it stops. Turn it clockwise by 90° to lock it. Turn it counterclockwise to release it.

■ Locking type (Manual) <Semi-standard>

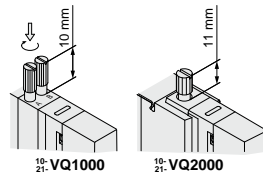

Push down on the manual override with a small flat head screwdriver or with your fingers until it stops. Turn it clockwise by 90° to lock it. Turn it counterclockwise to release it.

⚠ Caution

Do not apply excessive torque when turning the locking type manual override. (0.1 N·m or less)



Series 10-21-VQ1000/2000

Specific Product Precautions 2

Be sure to read this before handling.

Refer to page 1382 for Safety Instructions and pages 677 to 683 for 3/4/5 Port Solenoid Valve Precautions.

Manual Override

Warning

Slide locking type (Manual) <Semi-standard>

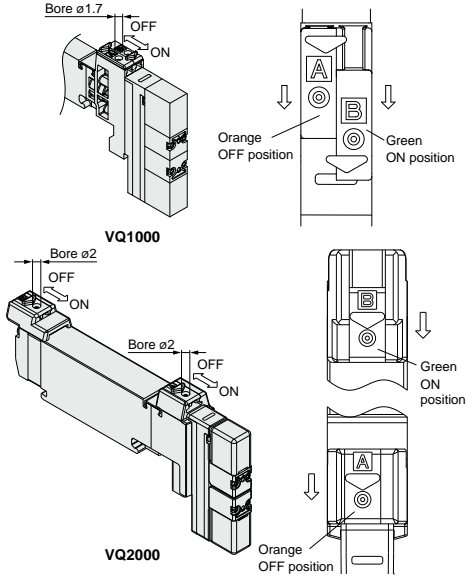

The manual override is locked by sliding it all the way to the pilot valve side (ON side) with a small flat head screwdriver or finger. Slide it to the fitting side (OFF side) to release it. In addition, it can also be used as a push type by using a screwdriver, etc., of $\phi 1.7$ or less. ($\phi 2$ or less for VQ2000).

How to Mount/Remove Solenoid Valves

Caution

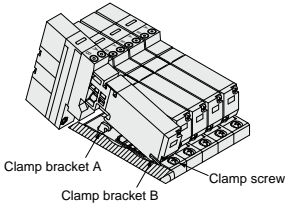

Removing

- Loosen the clamp screw until it turns freely. (The screw is captive.)
- Lift the coil side of the valve body while pressing down slightly on the screw head and remove it from the clamp bracket B. When the screw head cannot be pressed easily, gently press the area near the manual override of the valve.

How to Mount/Remove Solenoid Valves

Caution

Mounting

- Press down on the clamp screw. Clamp bracket A opens. Diagonally insert the hook on the valve end plate side into clamp B.
- Press the valve body downward. (When the screw is released, it will be locked by clamp bracket A.)
- Tighten the clamp screw. (Proper tightening torque: VQ1000, 0.25 to 0.35 N·m; VQ2000, 0.5 to 0.7 N·m.)

Caution

Dust on the sealing surface of the gasket or solenoid valve can cause air leakage.

Replacement of Cylinder Port Fittings

Caution

The cylinder port fittings are a cassette for easy replacement. The fittings are blocked by a clip. Take out the clip with a flat head screwdriver, etc., then replace the fittings.

For mounting, insert the fitting assembly until it strikes against the inside wall and then insert the clip to the specified position.

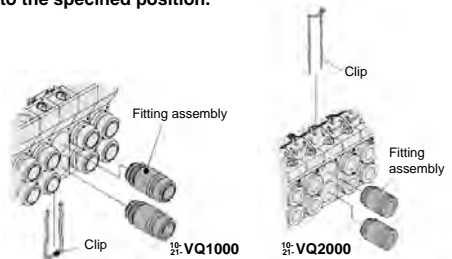

Applicable tubing O.D.	Fitting assembly part no.	
	10: VQ1000	21: VQ2000
Applicable tubing $\phi 3.2$	VVQ1000-50A-C3	—
Applicable tubing $\phi 4$	VVQ1000-50A-C4	VVQ1000-51A-C4
Applicable tubing $\phi 6$	VVQ1000-50A-C6	VVQ1000-51A-C6
Applicable tubing $\phi 8$	—	VVQ1000-51A-C8
M5	VVQ1000-50A-M5	—
Applicable tubing $\phi 1/8"$	VVQ1000-50A-N1	—
Applicable tubing $\phi 5/32"$	VVQ1000-50A-N3	VVQ1000-51A-N3
Applicable tubing $\phi 1/4"$	VVQ1000-50A-N7	VVQ1000-51A-N7
Applicable tubing $\phi 5/16"$	—	VVQ1000-51A-N9

* Refer to "Manifold Optional Parts" on pages 572 for other types of fittings.

Caution

- Use caution that O-rings must be free from scratches and dust. Otherwise, air leakage may result.
- After screwing in the fittings, mount the M5 fitting assembly on the manifold base. (Tightening torque: 0.8 to 1.2 N·m)
- Purchase orders are available in units of 10 pieces.



Series ¹⁰⁻21-VQ1000/2000

Specific Product Precautions 3

Be sure to read this before handling.

Refer to page 1382 for Safety Instructions and pages 677 to 683 for 3/4/5 Port Solenoid Valve Precautions.

How to Mount/Remove DIN Rail

Caution

Removing

1. Loosen the clamp screw on side (a) of the end plate on both sides.
2. Lift side (a) of the manifold base and slide the end plate in the direction of (2) shown in the figure to remove.

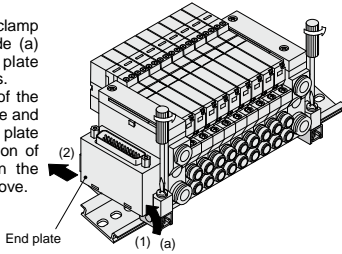

Mounting

1. Hook side (b) of the manifold base on the DIN rail.
2. Press down side (a) and mount the end plate on the DIN rail. Tighten the clamp screw on side (a) of the end plate. The proper tightening torque for screws is 0.4 to 0.6 N·m.

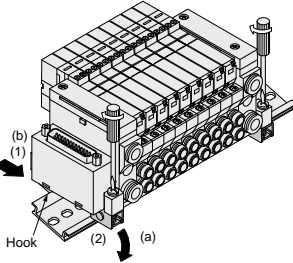

IP65 Enclosure

Caution

Wiring connection for models conforming to IP65 should also have enclosures equivalent to or of stricter than IP65.

How to Calculate Flow Rate

Refer to the **WEB catalog** for obtaining the flow rate.

Series 10-SQ1000

5 Port Solenoid Valve
Plug-in Unit



How to Order Manifold

10-SS5Q13-08 FD2-D □ - □ - □

• Clean series

• Stations

01	1 station
⋮	⋮
24 ^{Note 1)}	24 stations

Note 1) The maximum number of stations depends on the type of electrical entries.

• CE-compliant

Nil	—
Q	CE-compliant

• 1(P), 3(R) port size

Nil	1(P), 3(R) port ø8 One-touch fittings
00T	1(P), 3(R) port ø5/16" One-touch fittings

• Option

Nil	None
02 to 24 ^{Note 1)}	DIN rail length specified
B ^{Note 2)}	Back pressure check valve
K ^{Note 3)}	Special wiring specifications (Except double wiring)
N	With name plate (Side ported only)

• Manifold mounting

D	DIN rail mounting
E	Direct mounting

Note 1) Specify DIN rail length with □ at the end. (Enter the number of stations inside □.) The number of stations that may be displayed is longer than the manifold number of stations. Example: -D09

Note 2) When "-B" is selected, a back pressure check valve is included in all stations of the manifold. If the back pressure check valve is used only for the station that need it, then specify the station location in the manifold specification. ("B" is not necessary)

Note 3) Specify "-K" for wiring specification for cases below. (Except L kit)

All single wiring

- Single and double mixed wiring.

- When there are stations which do not require wiring (e.g. individual SUP spacer), specify the wiring specification in the manifold specification so that the number of solenoids is the maximum number of solenoids or less. (Standard wiring specification is double wiring)

Note 4) For specifying two or more options, enter them alphabetically. Example: -BKN

• Electrical entry

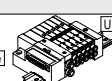
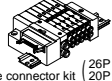
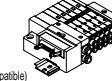
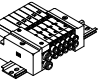
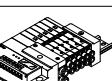
Kit type	Lead wire connector location	Cable/SI unit specifications	Station (Double wiring)	Max. number of solenoids for special wiring specifications ^{Note 2)}	CE-compliant	
F kit  D-sub connector kit	D side	FD0	D-sub connector (25P) kit, without cable	1 to 12 stations	●	
		FD1	D-sub connector (25P) kit, with 1.5 m cable			
		FD2	D-sub connector (25P) kit, with 3.0 m cable			
		FD3	D-sub connector (25P) kit, with 5.0 m cable			
P kit  Flat ribbon cable connector kit (26P/20P)	D side ^{Note 1)}	PD0	Flat ribbon cable (26P) kit, without cable	1 to 12 stations	●	
		PD1	Flat ribbon cable (26P) kit, with 1.5 m cable			
		PD2	Flat ribbon cable (26P) kit, with 3.0 m cable			
		PD3	Flat ribbon cable (26P) kit, with 5.0 m cable			
		PDC	Flat ribbon cable (20P) kit, without cable			1 to 9 stations
J kit  Flat ribbon cable (20P) (PC wiring system compatible)	D side	JD0	Flat ribbon cable (20P) PC wiring system compatible	1 to 8 stations	16	●
L kit  Lead wire kit Note 3)	D side	LD0 (N)	Lead wire kit with 0.6 m cable	1 to 12 stations	—	●
	LD1 (N)	D side				
	LD1 (N)	D side	Lead wire kit with 1.5 m cable			
	LD1 (N)	U side				
	LD2 (N)	D side	Lead wire kit with 3.0 m cable			
	LD2 (N)	U side				
S kit  Serial transmission kit EX140 Integrated-type (For Output) Serial Transmission System	D side	SDF	NKE Corp.: Fieldbus System	1 to 8 stations	16	—
		SDH	NKE Corp.: Fieldbus H System			
		SDJ1	Panasonic Industrial Devices SUNX Co., Ltd.: S-LINK (16 output points)			
		SDJ2	Panasonic Industrial Devices SUNX Co., Ltd.: S-LINK (8 output points)	1 to 4 stations	8	
		SDQ	DeviceNet™	1 to 8 stations	16	
		SDR1	OMRON Corp.: CompoBus/S (16 output points)	1 to 8 stations	16	
		SDR2	OMRON Corp.: CompoBus/S (8 output points)	1 to 4 stations	8	
		SDV	CE-Link	1 to 8 stations	16	

Note 1) Separately order the 20P type cable assembly for the P kit.

Note 2) Specify the wiring so that the maximum number of solenoids is not exceeded. (The number of solenoids are counted as: 1 for single solenoids and 2 for type 3P double solenoids.)

Note 3) When specifying the negative common specifications of the L kit, suffix "N" to the kit symbol.

Directional Control Valves

Air Cylinders

Rotary Actuators

Air Grippers

Air Preparation Equipment

Modular F. R.

Pressure Control Equipment

Fittings & Tubing

Flow Control Equipment

Pressure Switches/Pressure Sensors

How to Order Valve



10-SQ1 **1** **31** **1** **5** **1** **C6** **1** **1** **1**

• Clean series

• CE-compliant

Nil	—
Q	CE-compliant

• Seal

1	Rubber seal
----------	-------------

• Actuation type

1	2 position single (A)4 2(B) (R1)5 1 3(R2) (P)
2	2 position double (Double solenoid) (Note) (A)4 2(B) (R1)5 1 3(R2) (P) Rubber seal
3	3 position closed center (A)4 2(B) (R1)5 1 3(R2) (P)
4	3 position exhaust center (A)4 2(B) (R1)5 1 3(R2) (P)
5	3 position pressure center (A)4 2(B) (R1)5 1 3(R2) (P)

Note) For double solenoid specification, the function symbol below is "D".

• Function

Symbol	Specifications
Nil	Standard type (0.4 W)
B	Quick response type (0.95 W)
D (Note 1)	2 position double (Double solenoid specifications)
N (Note 2)	Negative common

Note 1) "D" is specified for 2 position double.

Note 2) For L kit, when the manifold specifies negative common, the valve common should also be negative. The combination of negative common of the valve cannot be specified with S kit (EX140).

Note 3) When two or more symbols are specified, indicate them alphabetically.

• Manifold block

Nil	M	MB
Without manifold block 	With manifold block 	With manifold block, built-in back pressure check valve
• When ordering with manifolds • When only valves are required.	* Lead wire is not included. * Lead wire is not included.	
For adding stations		

• Port plug mounting port

Nil	None
A	Port 4(A)
B	Port 2(B)

• Cylinder port

Symbol	Port size	Port location	
C3	With ø3.2 One-touch fittings	Side ported	
C4	With ø4 One-touch fittings		
C6	With ø6 One-touch fittings		
M5	M5 thread	Top ported (Note)	
L3	With ø3.2 One-touch fittings		
L4	With ø4 One-touch fittings		
L6	With ø6 One-touch fittings		
L5	M5 thread		

Note) Can be changed to side ported configuration.

• Manual override

Nil	B
Non-locking push type (Tool required)	Locking type (Tool required)

• Rated voltage

5	24 VDC
6	12 VDC

Note 1) Light/surge voltage suppressor is built-in.

Note 2) S kit: 24 VDC only

How to Order Manifold Assembly (Example)

Example) D-sub connector kit, with cable (3 m)

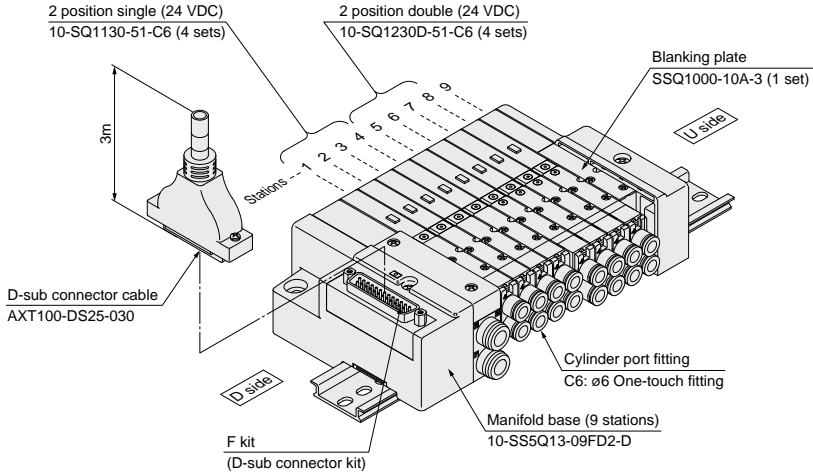

- 10-SS5Q13-09FD2-D 1 set (F kit 9-station manifold base)
- * 10-SQ1130-51-C6 4 sets (2 position single)
- * 10-SQ1230D-51-C6 4 sets (2 position double)
- * SSQ1000-10A-3 1 set (Blanking plate)

→ The asterisk denotes the symbol for assembly. Prefix it to the part no. of the solenoid valve, etc.

Add the valve and option part numbers in order starting from the first station on the D side.
When entry of part numbers becomes complicated, indicate on the manifold specification sheet.

Directional Control Valves

Air Cylinders

Rotary Actuators

Air Grippers

Air Preparation Equipment

Modular F. R.

Pressure Control Equipment

Fittings & Tubing

Flow Control Equipment

Pressure Switches/ Pressure Sensors

5 Port Solenoid Valve/Plug-in Unit **10-SQ1000**

Model

Series	Actuation type	Seal	Model	Flow rate characteristics Note 1)						Response time (ms) Note 2)		Weight (g)	
				1 → 4/2 (P → A/B)			4 → 5 (A → R1)			Standard (0.4 W)	Quick response (0.95 W)		
				C [dm ³ /(s·bar)]	b	Cv	C [dm ³ /(s·bar)]	b	Cv				
SQ1000	2 position	Single	Rubber seal	10-SQ1131	0.79	0.20	0.19	0.80	0.20	0.19	24 or less	15 or less	80
		Double	Rubber seal	10-SQ1231D	0.79	0.20	0.19	0.80	0.20	0.19	20 or less	15 or less	95
	3 position	Closed center	Rubber seal	10-SQ1331	0.64	0.20	0.15	0.58	0.26	0.16	39 or less	25 or less	100
		Exhaust center	Rubber seal	10-SQ1431	0.64	0.20	0.15	0.80	0.20	0.19	39 or less	25 or less	100
		Pressure center	Rubber seal	10-SQ1531	0.79	0.21	0.19	0.59	0.20	0.14	39 or less	25 or less	100

Note 1) Values for the cylinder port size of C6, CYL → Values of EXH. Flow rate characteristics of 2 → 3 (B → R2) declines about 30% of 4 → 5 (A → R1).
 Note 2) Based on JIS B 8375-1981. (Values with a supply pressure of 0.5 MPa and light/surge voltage suppressor. Values fluctuate depending on the pressure and air quality.)

Specifications



Valve specifications	Valve construction	Rubber seal	
	Fluid	Air/Inert gas	
	Maximum operating pressure	0.7 MPa	
	Min. operating pressure	Single	0.15 MPa
		Double (Double solenoid)	0.1 MPa
		3 position	0.2 MPa
	Ambient and fluid temp.	-10 to 50°C Note 1)	
	Lubrication	Not required	
	Pilot valve manual override	Push type/Locking type (Tool required)	
	Vibration/Impact resistance Note 2)	30/150 m/s ²	
Protection structure	Dust tight		
Solenoid specifications	Coil rated voltage	12 VDC, 24 VDC	
	Allowable voltage fluctuation	±10% of rated voltage	
	Coil insulation type	Equivalent to class B	
	Power consumption (Current)	24 VDC	0.4 W DC (17 mA), 0.95 W DC (40 mA) Note 3)
		12 VDC	0.4 W DC (34 mA), 0.95 W DC (80 mA) Note 3)

Note 1) Use dry air to prevent condensation when operating at low temperatures.
 Note 2) Vibration resistance: No malfunction occurred in a one-sweep test between 45 and 2000 Hz. Test was performed in both energized and de-energized states in the axial direction and at right angles to the main valve and armature. (Default settings)
 Impact resistance: No malfunction occurred when it was tested with a drop tester in the axial direction and at right angles to the main valve and armature in both energized and deenergized states once for each condition.
 Note 3) Value for quick response type

Symbol

2 position single (A)4 2(B) (R1)5 13(R2) (P)	2 position double (Double solenoid) (A)4 2(B) (R1)5 13(R2) (P)	3 position closed center (A)4 2(B) (R1)5 13(R2) (P)	3 position exhaust center (A)4 2(B) (R1)5 13(R2) (P)	3 position pressure center (A)4 2(B) (R1)5 13(R2) (P)
---	---	--	---	--

Manifold Specifications

Base model	Piping specifications		Applicable solenoid valve	Connection type	Applicable stations Note 3)	5 station weight (g) Note 4)	1 station weight (g) Note 4)	
	Port size Note 1)							
	P, R	A, B						
10-SSQ13-□□□□	C8 (For ø8)	Side	10-SQ1□31	F kit: D-sub connector	1 to 12 stations	420	20	
		Top Note 2)		C3 (For ø3.2) C4 (For ø4) C6 (For ø6) M5 (M5 thread)	P kit: Flat ribbon cable	26P 20P	1 to 12 stations 1 to 9 stations	420
	C8 (For ø8)				Side	J kit: Flat ribbon cable PC wiring system compatible	1 to 8 stations	420
		Top Note 2)		L3 (For ø3.2) L4 (For ø4) L6 (For ø6) L5 (M5 thread)		L kit: Lead wire	1 to 12 stations	460
C8 (For ø8)	Side		S kit: Serial transmission		1 to 8 stations	475	20	

Note 1) One-touch fittings in inch sizes are also available.
 Note 2) Can be changed to side ported configuration.
 Note 3) An optional specification for special wiring is available to increase the maximum number of stations.
 Note 4) Except valves.

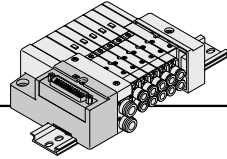

F Kit (D-sub connector)

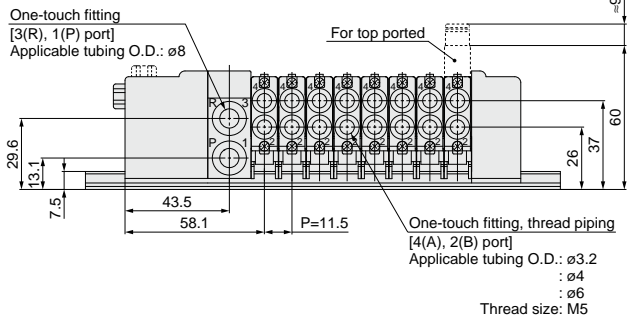
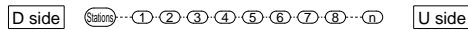
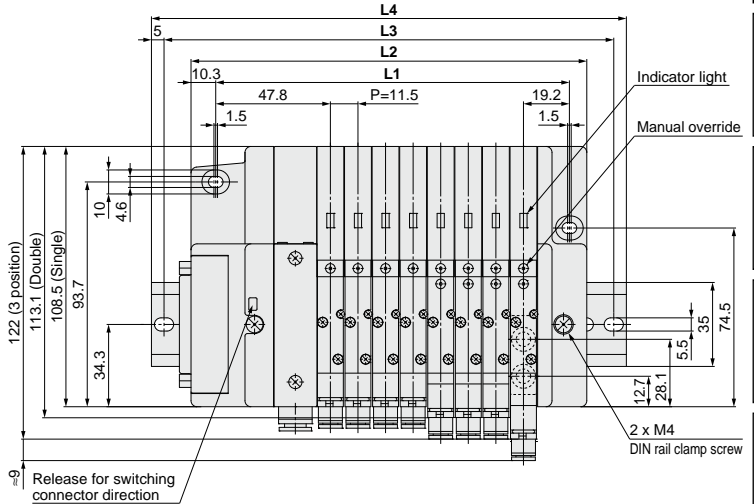
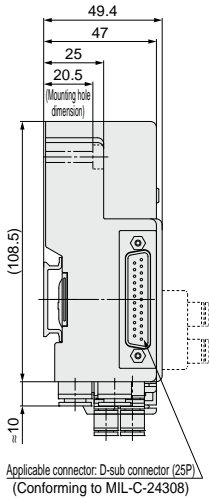

Dimensions

Formula $L1 = 11.5n + 55.5$ $L2 = 11.5n + 73$ n : Stations (Max. 24 stations)

L	n	1	2	3	4	5	6	7	8	9	10	11	12	13	14	15	16	17	18	19	20	21	22	23	24
L1		67	78.5	90	101.5	113	124.5	136	147.5	159	170.5	182	193.5	205	216.5	228	239.5	251	262.5	274	285.5	297	308.5	320	331.5
L2		84.5	96	107.5	119	130.5	142	153.5	165	176.5	188	199.5	211	222.5	234	245.5	257	268.5	280	291.5	303	314.5	326	337.5	349
L3		112.5	125	137.5	150	150	162.5	175	187.5	200	212.5	225	237.5	250	262.5	275	287.5	300	300	312.5	325	337.5	350	362.5	375
L4		123	135.5	148	160.5	160.5	173	185.5	198	210.5	223	235.5	248	260.5	273	285.5	298	310.5	310.5	323	335.5	348	360.5	373	385.5

Directional Control Valves

Air Cylinders

Rotary Actuators

Air Grippers

Air Preparation Equipment

Modular F. R.

Pressure Control Equipment

Fittings & Tubing

Flow Control Equipment

Pressure Switches/Pressure Sensors

P Kit (Flat ribbon cable connector)

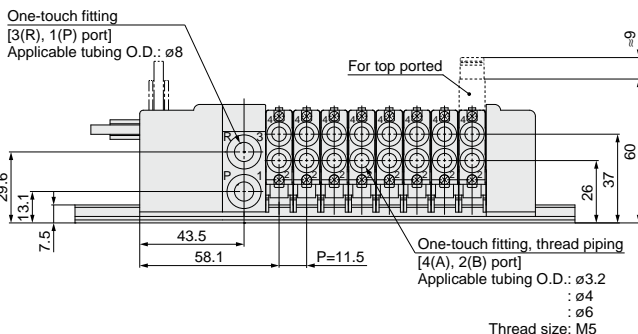
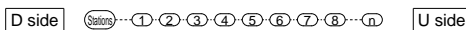
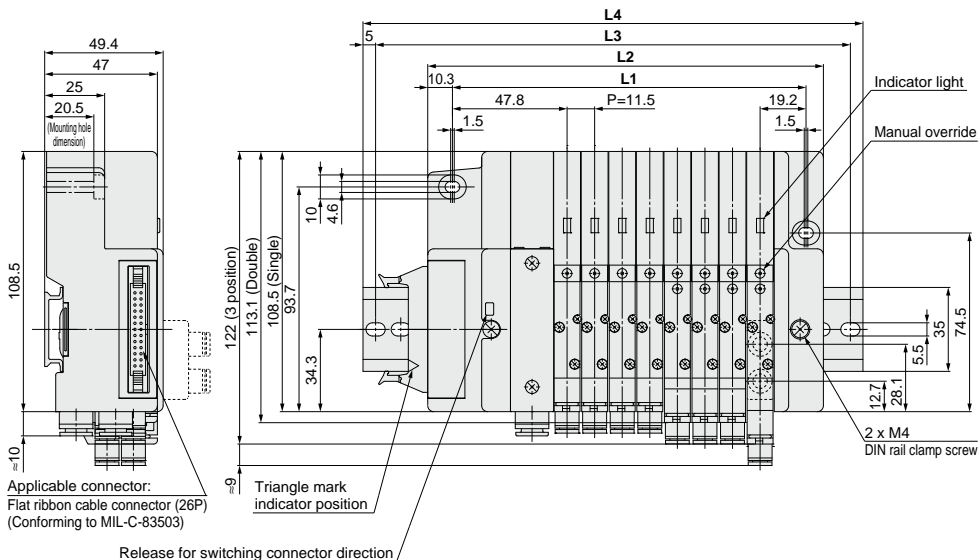
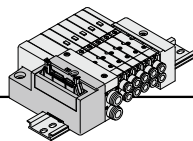

Dimensions

Formula $L1 = 11.5n + 55.5$ $L2 = 11.5n + 73$ n : Stations (Max. 24 stations)

L	n	1	2	3	4	5	6	7	8	9	10	11	12	13	14	15	16	17	18	19	20	21	22	23	24
L1		67	78.5	90	101.5	113	124.5	136	147.5	159	170.5	182	193.5	205	216.5	228	239.5	251	262.5	274	285.5	297	308.5	320	331.5
L2		84.5	96	107.5	119	130.5	142	153.5	165	176.5	188	199.5	211	222.5	234	245.5	257	268.5	280	291.5	303	314.5	326	337.5	349
L3		112.5	125	137.5	150	162.5	175	187.5	200	212.5	225	237.5	250	262.5	275	287.5	300	300	312.5	325	337.5	350	362.5	375	
L4		123	135.5	148	160.5	173	185.5	198	210.5	223	235.5	248	260.5	273	285.5	298	310.5	310.5	323	335.5	348	360.5	373	385.5	

L Kit (Lead wire cable)

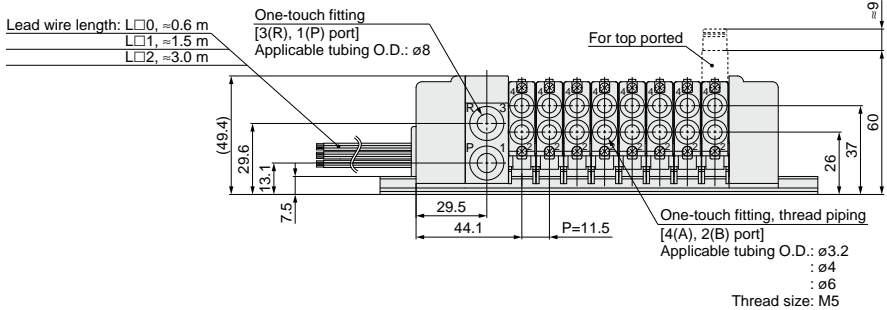
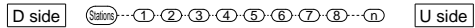
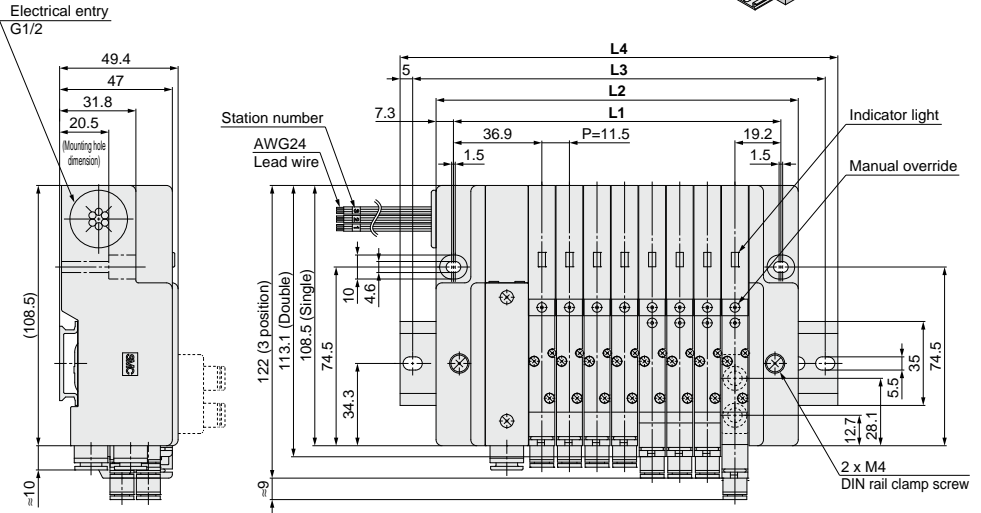
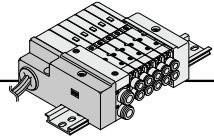

Dimensions Formula L1 = 11.5n + 44.5 L2 = 11.5n + 59 n: Stations (Max. 12 stations)

L	n	1	2	3	4	5	6	7	8	9	10	11	12
L1	n	56	67.5	79	90.5	102	113.5	125	136.5	148	159.5	171	182.5
L2	n	70.5	82	93.5	105	116.5	128	139.5	151	162.5	174	185.5	197
L3	n	100	112.5	125	125	137.5	150	162.5	175	187.5	200	212.5	225
L4	n	110.5	123	135.5	135.5	148	160.5	173	185.5	198	210.5	223	235.5

S Kit (Serial transmission unit)

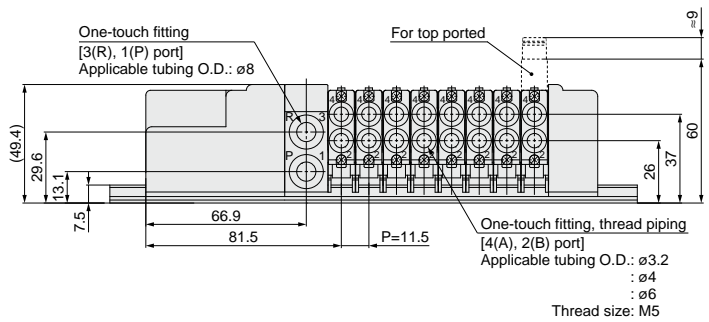
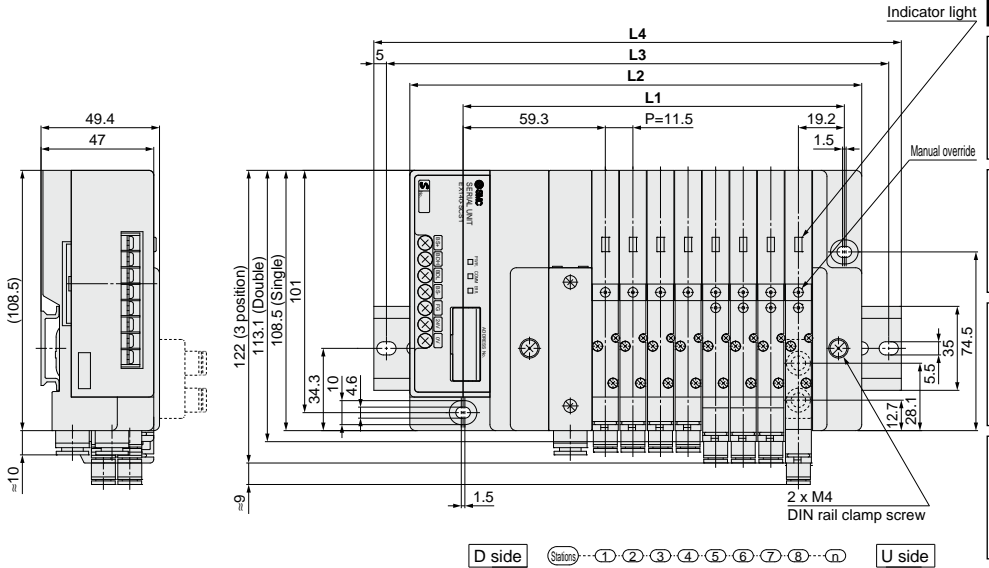
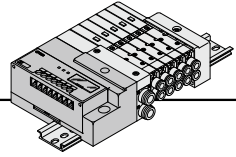

Dimensions

Formula L1 = 11.5n + 67 L2 = 11.5n + 96.5 n: Stations (Max. 16 stations)

L \ n	1	2	3	4	5	6	7	8	9	10	11	12	13	14	15	16
L1	78.5	90	101.5	113	124.5	136	147.5	159	170.5	182	193.5	205	216.5	228	239.5	251
L2	108	119.5	131	142.5	154	165.5	177	188.5	200	211.5	223	234.5	246	257.5	269	280.5
L3	137.5	150	162.5	175	187.5	200	212.5	225	237.5	250	262.5	275	287.5	300	300	
L4	148	160.5	173	185.5	198	210.5	223	235.5	248	260.5	273	285.5	298	310.5	310.5	

- Directional Control Valves
- Air Cylinders
- Rotary Actuators
- Air Grippers
- Air Preparation Equipment
- Modular F. R.
- Pressure Control Equipment
- Fittings & Tubing
- Flow Control Equipment
- Pressure Switches/Pressure Sensors

Series 10-SQ2000

5 Port Solenoid Valve
Plug-in Unit



How to Order Manifold

10-SS5Q23-08 FD2-D

• Clean series

• Stations •

01	1 station
⋮	⋮
16 (Note)	16 stations

(Note) The maximum number of stations depends on the type of electrical entries.

• CE-compliant

Nil	—
Q	CE-compliant

• 1(P), 3(R) port size

Nil	1(P), 3(R) port ø10 One-touch fittings
00T	1(P), 3(R) port ø3/8" One-touch fittings

• Option

Nil	None
02 to 16 (Note 1)	DIN rail length specified
B (Note 2)	Back pressure check valve
K (Note 3)	Special wiring specifications (Except double wiring)
N	With name plate (Side ported only)

Note 1) Specify DIN rail length with □ at the end. (Enter the number of stations inside □).
The number of stations that may be displayed is longer than the manifold number of stations.
Example: -D09

Note 2) When "-B" is selected, a back pressure check valve is included in all stations of the manifold.
If the back pressure check valve is used only for the station that need it, then specify the station location in the manifold specification. ("-B" is not necessary)

Note 3) Specify "K" for wiring specification for cases below. (Except L kit)

- All single wiring

- Single and double mixed wiring.

- When there are stations which do not require wiring (e.g. individual SUP spacer),

specify the wiring specification in the manifold specification so that the number of solenoids is the maximum number of solenoids or less. (Standard wiring specification is double wiring)

Note 4) For specifying two or more options, enter them alphabetically. Example: -BKN

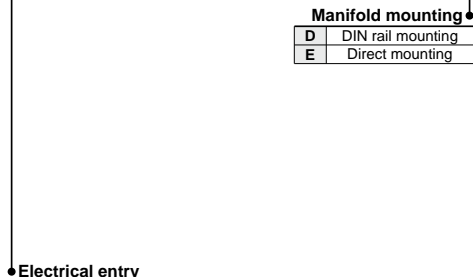

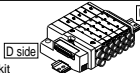
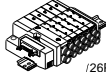
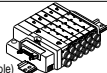
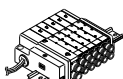
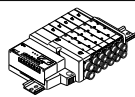
Kit type	Lead wire connector location	Cable/SI unit specifications	Station (Double wiring)	Max. number of stations for special wiring specifications	Max. number of solenoids for special wiring specifications (Note 2)	CE-compliant	
F kit  D-sub connector kit	FD0 FD1 FD2 FD3	D side	D-sub connector (25P) kit, without cable	1 to 12 stations	16 stations	●	
		D side	D-sub connector (25P) kit, with 1.5 m cable				
		D side	D-sub connector (25P) kit, with 3.0 m cable				
		D side	D-sub connector (25P) kit, with 5.0 m cable				
P kit  Flat ribbon cable connector kit (26P)	PD0 PD1 PD2 PD3 PDC	D side	Flat ribbon cable (26P) kit, without cable	1 to 12 stations	16 stations	●	
		D side (Note 1)	Flat ribbon cable (26P) kit, with 1.5 m cable				
		D side	Flat ribbon cable (26P) kit, with 3.0 m cable				
		D side	Flat ribbon cable (26P) kit, with 5.0 m cable				
J kit  Flat ribbon cable (20P) (PC Wiring System compatible)	JD0	D side	Flat ribbon cable (20P) PC wiring system compatible	1 to 8 stations	16 stations	●	
		D side	Terminal block box kit	1 to 10 stations	16 stations	16	●
L kit Note 3)  Lead wire kit	LD0 (N) D side LD0 (N) U side LD1 (N) D side LD1 (N) U side LD2 (N) D side LD2 (N) U side	D side	Lead wire kit with 0.6 m cable	1 to 12 stations	—	●	
		U side	Lead wire kit with 1.5 m cable				
		D side	Lead wire kit with 3.0 m cable				
		U side	Lead wire kit with 3.0 m cable				
S kit  Serial transmission kit EX140 Integrated-type (For Output) Serial Transmission System	SDF SDH SDJ1 SDJ2 SDQ SDR1 SDR2 SDV	D side	NKE Corp.: Fieldbus System	1 to 8 stations	16 stations	—	
		D side	NKE Corp.: Fieldbus H System				
		D side	Panasonic Industrial Devices SUNX Co., Ltd.: S-LINK (16 outputs)	1 to 4 stations	8 stations	8	
		D side	Panasonic Industrial Devices SUNX Co., Ltd.: S-LINK (8 outputs)				
		D side	DeviceNet™	1 to 8 stations	16 stations	16	●
		D side	OMRON Corp.: CompoBus/S (16 outputs)	1 to 4 stations	8 stations	8	
		D side	OMRON Corp.: CompoBus/S (8 outputs)	1 to 4 stations	8 stations	8	
		D side	CC-Link	1 to 8 stations	16 stations	16	

Note 1) Separately order the 20P type cable assembly for the P kit.

Note 2) Specify the number of the solenoid so that the maximum station number is not exceeded. (The number of solenoids are counted as: 1 for single solenoids and 2 for type 3P double solenoids.)

Note 3) When specifying the negative common specifications of the L kit, suffix "N" to the kit symbol. For details, refer to the WEB catalog.

How to Order Valve



10-SQ2 1 3 1 - 5 1 - C6 - - -

• Clean series

• Seal

1	Rubber seal
---	-------------

• CE-compliant

Nil	—
Q	CE-compliant

• Actuation type

1	2 position single (A)4 2(B) (R)1 5 1 3 (R)2 (P)
2	2 position double (Double solenoid) Note (A)4 2(B) (R)1 5 1 3 (R)2 (P) Rubber seal
3	3 position closed center (A)4 2(B) (R)1 5 1 3 (R)2 (P)
4	3 position exhaust center (A)4 2(B) (R)1 5 1 3 (R)2 (P)
5	3 position pressure center (A)4 2(B) (R)1 5 1 3 (R)2 (P)

Note) For double solenoid specification, the function symbol below is "D".

• Function

Symbol	Specifications
Nil	Standard type (0.4 W)
B	Quick response type (0.95 W)
D Note 1)	2 position double (Double solenoid specifications)
N Note 2)	Negative common

Note 1) "D" is specified for 2 position double.
 Note 2) For L kit, when the manifold specifies negative common, the valve common should also be negative.
 The combination of negative common of the valve cannot be specified with S kit (EX140).
 Note 3) When two or more symbols are specified, indicate them alphabetically.

• Manifold block

Nil	M	MB
Without manifold block	With manifold block	With manifold block, built-in back pressure check valve
	* Lead wire is not included.	* Lead wire is not included.
• When ordering with manifolds	For adding stations	
• When only valves are required.		

• Port plug mounting port

Nil	None
A	Port 4(A)
B	Port 2(B)

• Cylinder port

Symbol	Port size	Port location	
C4	With ø4 One-touch fittings	Side ported	
C6	With ø6 One-touch fittings		
C8	With ø8 One-touch fittings		
L4	With ø4 One-touch fittings	Top ported Note)	
L6	With ø6 One-touch fittings		
L8	With ø8 One-touch fittings		

Note) Can be changed to side ported configuration.

• Manual override

Nil	B	D
Non-locking push type (Tool required)	Locking type (Tool required)	Slide locking type (Manual type) * Only side ported applicable

• Rated voltage

5	24 VDC
6	12 VDC

Note 1) Light/surge voltage suppressor is built-in.
 Note 2) S kit: 24 VDC only

Directional Control Valves

Air Cylinders

Rotary Actuators

Air Grippers

Air Preparation Equipment

Modular F. R.

Pressure Control Equipment

Fittings & Tubing

Flow Control Equipment

Pressure Switches/ Pressure Sensors

How to Order Manifold Assembly (Example)

Example) D-sub connector kit, with cable (3 m)

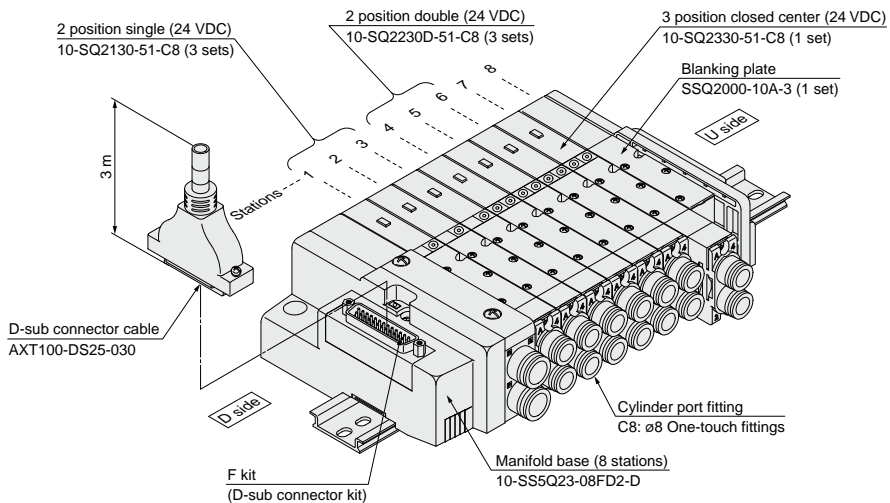

10-SS5Q23-08FD2-D ... 1 set (F kit 8-station manifold base)

*** 10-SQ2130-51-C8 3 sets (2 position single)**

*** 10-SQ2230D-51-C8 ... 3 sets (2 position double)**

*** 10-SQ2330-51-C8 1 set (3 position closed center)**

*** SSQ2000-10A-3 1 set (Blanking plate)**

↳ The asterisk denotes the symbol for assembly. Prefix it to the part no. of the solenoid valve, etc.

Add the valve and option part numbers in order starting from the first station on the D side.
When entry of part numbers becomes complicated, indicate on the manifold specification sheet.

Model

Series	Actuation type	Seal	Model	Flow rate characteristics Note 1)						Response time (ms) Note 2)		Weight (g)	
				1→4/2 (P→A/B)			4/2→5/3 (A/B→R1/R2)			Standard (0.4 W)	Quick response (0.95 W)		
				C [dm³/(s·bar)]	b	Cv	C [dm³/(s·bar)]	b	Cv				
SQ2000	3 position 2 position	Single	Rubber seal	10-SQ2131	2.3	0.17	0.51	3.1	0.18	0.71	31 or less	24 or less	140
		Double	Rubber seal	10-SQ2231D	2.3	0.17	0.51	3.1	0.18	0.71	26 or less	20 or less	155
	3 position	Closed center	Rubber seal	10-SQ2331	1.9	0.17	0.46	1.8	0.29	0.47	44 or less	34 or less	175
		Exhaust center	Rubber seal	10-SQ2431	1.9	0.17	0.46	3.1	0.14	0.65	44 or less	34 or less	175
		Pressure center	Rubber seal	10-SQ2531	2.5	0.17	0.56	1.8	0.30	0.47	44 or less	34 or less	175

Note 1) Values for the top ported cylinder port size of C8. CYL → Values of EXH. The side ported type will be about 10% less.
 Note 2) Based on JIS B 8375-1981. (Values with a supply pressure of 0.5 MPa and light/surge voltage suppressor. Values fluctuate depending on the pressure and air quality.)

Specifications



Valve specifications	Valve construction	Rubber seal		
	Fluid	Air/Inert gas		
	Maximum operating pressure	0.7 MPa		
	Min. operating pressure	Single	0.15 MPa	
		Double (Double solenoid)	0.1 MPa	
		3 position	0.2 MPa	
	Ambient fluid temperature	-10 to 50°C Note 1)		
	Lubrication	Not required		
	Pilot valve manual override	Push type (Tool required)/Locking type (Tool required)/Slide locking type (Manual)		
	Vibration/Impact resistance Note 2)	30/150 m/s ²		
Protection structure	Dust tight			
Solenoid specifications	Coil rated voltage	12 VDC, 24 VDC		
	Allowable voltage fluctuation	±10% of rated voltage		
	Coil insulation type	Equivalent to class B		
	Power consumption (Current)	24 VDC	0.4 W DC (17 mA), 0.95 W DC (40 mA) Note 3)	
		12 VDC	0.4 W DC (34 mA), 0.95 W DC (80 mA) Note 3)	

Note 1) Use dry air to prevent condensation when operating at low temperatures.
 Note 2) Vibration resistance: No malfunction occurred in a one-sweep test between 45 and 2000 Hz. Test was performed in both energized and de-energized states in the axial direction and at right angles to the main valve and armature. (Default settings)
 Impact resistance: No malfunction occurred when it was tested with a drop tester in the axial direction and at right angles to the main valve and armature in both energized and de-energized states once for each condition.
 Note 3) Value for quick response type.

Symbol

2 position single (A)4 2(B) 	2 position double (Double solenoid) (A)4 2(B) 	3 position closed center (A)4 2(B) 	3 position exhaust center (A)4 2(B) 	3 position pressure center (A)4 2(B)
(R)1 5 1 3 (R)2 (P)	(R)1 5 1 3 (R)2 (P)	(R)1 5 1 3 (R)2 (P)	(R)1 5 1 3 (R)2 (P)	(R)1 5 1 3 (R)2 (P)

Manifold Specifications

Base model	Piping specifications		Applicable solenoid valve	Connection type	Applicable stations Note 3)	5 stations weight (g) Note 4)	1 station weight (g) Note 4)
	Port size Note 1)						
	P, R	A, B					
Series 10-SQ2000	Side	C4 (For ø4) C6 (For ø6) C8 (For ø8)	10-SQ2□31	F kit: D-sub connector	1 to 12 stations	580	35
		C10 (For ø10)		Note 2) Top	P kit: Flat ribbon cable	26P	1 to 12 stations
20P	1 to 9 stations						
J kit: Flat ribbon cable PC wiring system compatible	1 to 8 stations		580		35		
10-SS5Q23-□□□□	Note 2) Top	C4 (For ø4) C6 (For ø6) C8 (For ø8)	10-SQ2□31	L Kit: Lead wire	1 to 12 stations	620	50
				S Kit: Serial transmission	1 to 8 stations	650	35

Note 1) One-touch fittings in inch sizes are also available.
 Note 2) Can be changed to side ported configuration.
 Note 3) An optional specification for special wiring is available to increase the maximum number of stations.
 Note 4) Except valves.

F Kit (D-sub connector)

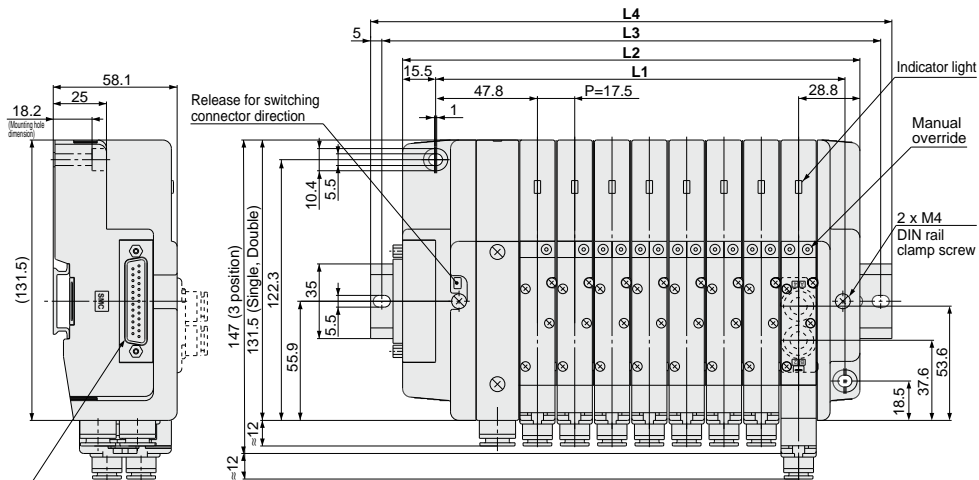
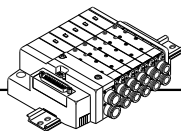

Applicable connector: D-sub connector (25P)
(Conforming to MIL-C-24308)

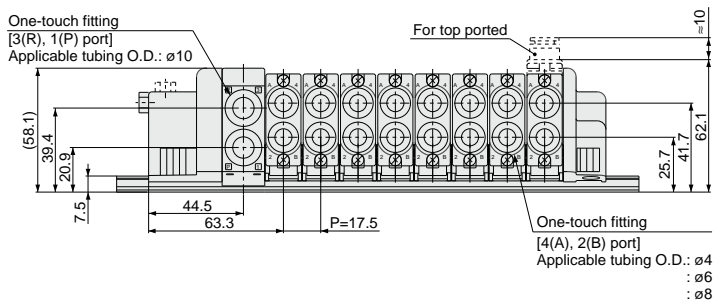
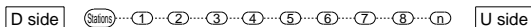

Dimensions

Formula: L1 = 17.5n + 52, L2 = 17.5n + 74.5 n: Stations (Max. 16 stations)

L	n	1	2	3	4	5	6	7	8	9	10	11	12	13	14	15	16
L1		69.5	87	104.5	122	139.5	157	174.5	192	209.5	227	244.5	262	279.5	297	314.5	332
L2		92	109.5	127	144.5	162	179.5	197	214.5	232	249.5	267	284.5	302	319.5	337	354.5
L3		112.5	137.5	150	175	187.5	200	225	237.5	262.5	275	287.5	312.5	325	350	362.5	375
L4		123	148	160.5	185.5	198	210.5	235.5	248	273	285.5	298	323	335.5	360.5	373	385.5

J

Kit (PC wiring system compatible flat ribbon cable)

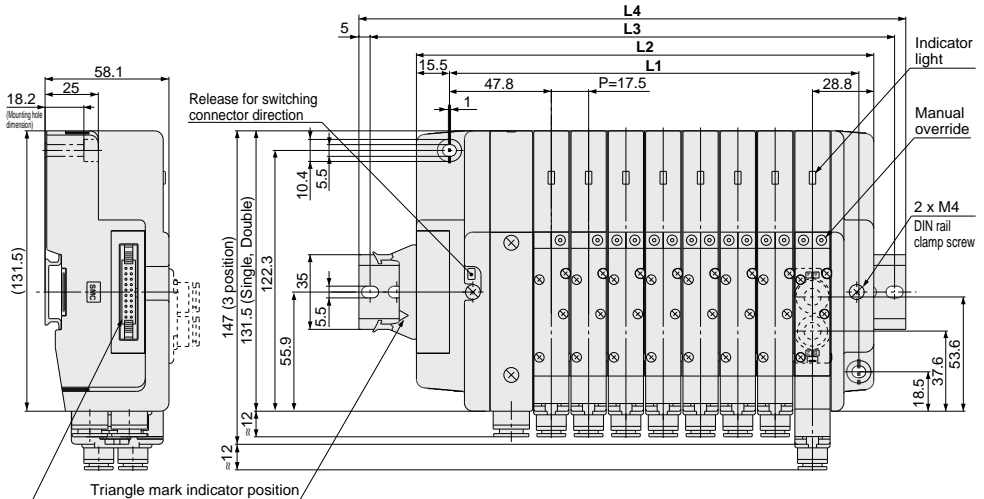
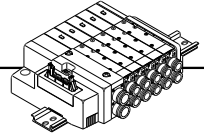

Applicable connector:
Flat ribbon cable connector (20P)
(Conforming to MIL-C-83503)

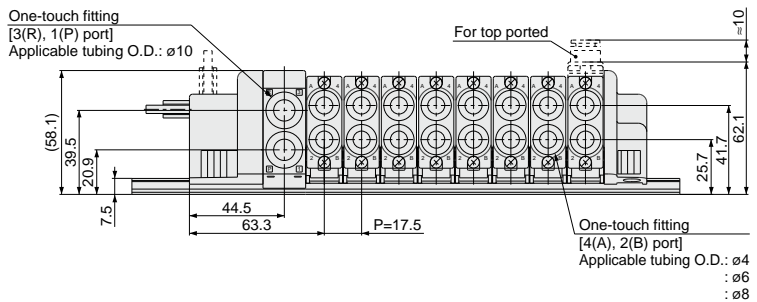
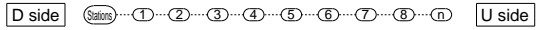

Dimensions

Formula: $L1 = 17.5n + 52$, $L2 = 17.5n + 74.5$ n: Stations (Max. 16 stations)

L	n	1	2	3	4	5	6	7	8	9	10	11	12	13	14	15	16
L1		69.5	87	104.5	122	139.5	157	174.5	192	209.5	227	244.5	262	279.5	297	314.5	332
L2		92	109.5	127	144.5	162	179.5	197	214.5	232	249.5	267	284.5	302	319.5	337	354.5
L3		112.5	137.5	150	175	187.5	200	225	237.5	262.5	275	287.5	312.5	325	350	362.5	375
L4		123	148	160.5	185.5	198	210.5	235.5	248	273	285.5	298	323	335.5	360.5	373	385.5

T Kit (Terminal block box)

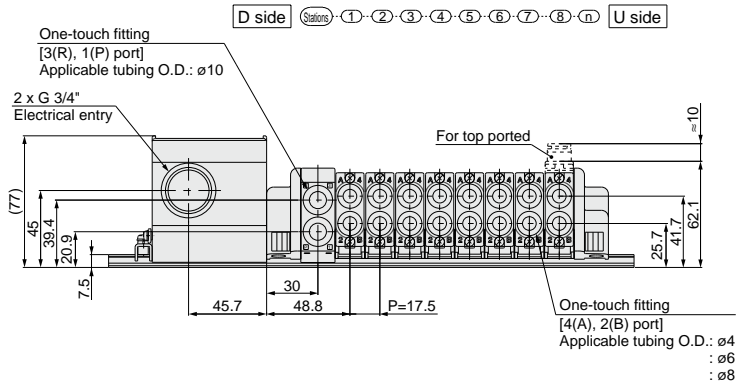
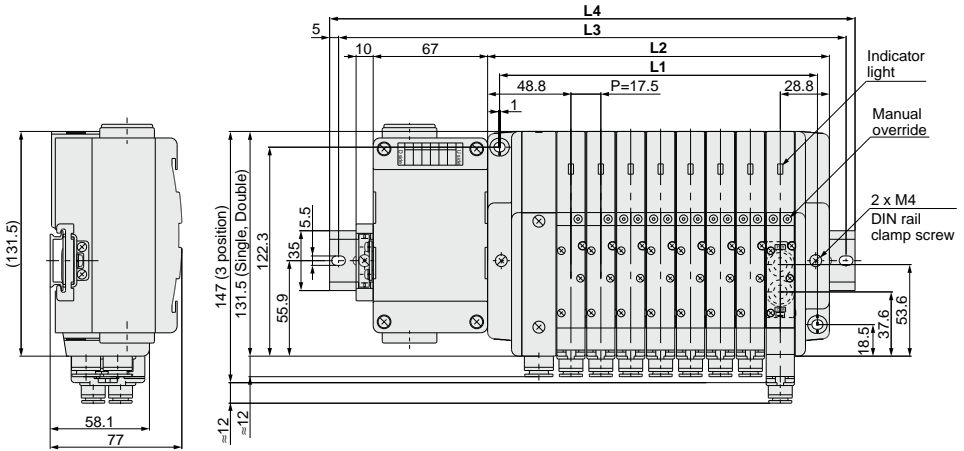
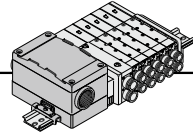

Dimensions

Formula: $L1 = 17.5n + 46$, $L2 = 17.5n + 60$ n: Stations (Maximum 16 stations)

L	n	1	2	3	4	5	6	7	8	9	10	11	12	13	14	15	16
L1		63.5	81	98.5	116	133.5	151	168.5	186	203.5	221	238.5	256	273.5	291	308.5	326
L2		77.5	95	112.5	130	147.5	165	182.5	200	217.5	235	252.5	270	287.5	305	322.5	340
L3		175	200	212.5	237.5	250	262.5	287.5	300	325	337.5	350	375	387.5	412.5	425	437.5
L4	DIN rail mounting	185.5	210.5	223	248	260.5	273	298	310.5	335.5	348	360.5	385.5	398	423	435.5	448
	Direct mounting	160.5	173.0	198.0	210.5	235.5	248.0	260.5	285.5	298.0	323.0	335.5	348.0	373.0	385.5	410.5	423.0

Directional Control Valves

Air Cylinders

Rotary Actuators

Air Grippers

Air Preparation Equipment

Modular F. R.

Pressure Control Equipment

Fittings & Tubing

Flow Control Equipment

Pressure Switches/ Pressure Sensors

L Kit (Lead wire)

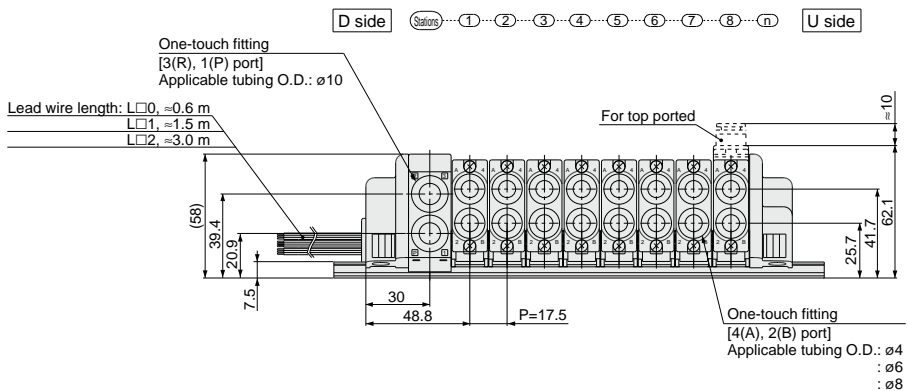
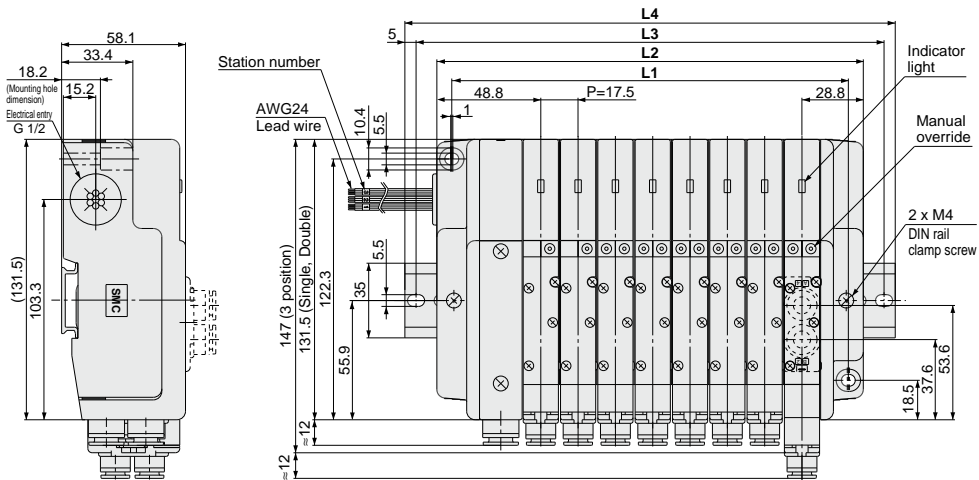
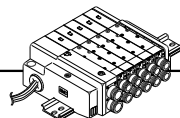

Dimensions Formula: $L1 = 17.5n + 46$, $L2 = 17.5n + 60$ n: Stations (Max. 12 stations)

L \ n	1	2	3	4	5	6	7	8	9	10	11	12
L1	63.5	81	98.5	116	133.5	151	168.5	186	203.5	221	238.5	256
L2	77.5	95	112.5	130	147.5	165	182.5	200	217.5	235	252.5	270
L3	100	125	137.5	150	175	187.5	212.5	225	237.5	262.5	275	300
L4	110.5	135.5	148	160.5	185.5	198	223	235.5	248	273	285.5	310.5

S Kit (Serial transmission)

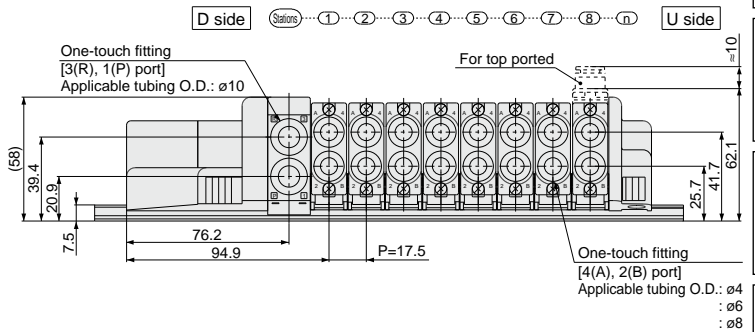
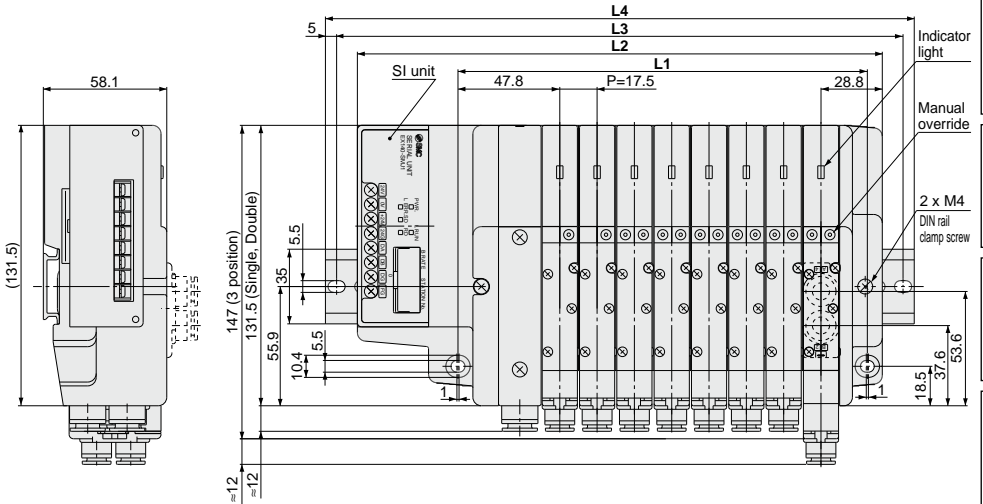
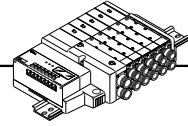

Dimensions

Formula: $L1 = 17.5n + 52$, $L2 = 17.5n + 106$ n: Stations (Max. 16 stations)

n	1	2	3	4	5	6	7	8	9	10	11	12	13	14	15	16
L1	69.5	87	104.5	122	139.5	157	174.5	192	209.5	227	244.5	262	279.5	297	314.5	332
L2	123.5	141	158.5	176	193.5	211	228.5	246	263.5	281	298.5	316	333.5	351	368.5	386
L3	150	162.5	187.5	200	225	237.5	250	275	287.5	312.5	325	337.5	362.5	375	400	412.5
L4	160.5	173	198	210.5	235.5	248	260.5	285.5	298	323	335.5	348	373	385.5	410.5	423

Directional Control Valves
Air Cylinders
Rotary Actuators
Air Grippers
Air Preparation Equipment
Modular F. R.
Pressure Control Equipment
Fittings & Tubing
Flow Control Equipment
Pressure Switches/ Pressure Sensors

Series 10-VQD1000

4 Port Direct Operated Poppet Solenoid Valve

How to Order Valve

Clean series





Body type
 2 — Body ported (Single unit)
 3 — Body ported (Manifold)
 5 — Base mounted

Valve option
 Nil — Standard (2 W)
 V — Vacuum (2 W)
 * U — For large flow (3.2 W)
 * W — For large flow, Vacuum (3.2 W)
 * Energy saving type

Rated voltage
 5 — 24 VDC
 6 — 12 VDC

10 - VQD11 5 1 U - 5 L - M5 -

Electrical entry

L: Plug lead type L plug connector, With lead wire With light/surge voltage suppressor	
LO: Plug lead type L plug connector, Without connector With light/surge voltage suppressor	
M: Plug lead type M plug connector, With lead wire With light/surge voltage suppressor	
MO: Plug lead type M plug connector, Without connector With light/surge voltage suppressor	

CE-compliant
 Nil — None
 Q — CE-compliant

Port size
 Body ported — M5 x 0.8 thread
 Base mounted — M5 x 0.8 (with sub-plate)
 (Note) No "Nil" for body ported type (VQD1131).

(Note) When you expect to energize the unit for extended periods of time, refer to the 3/4/5 Port Solenoid Valves Precautions for details.

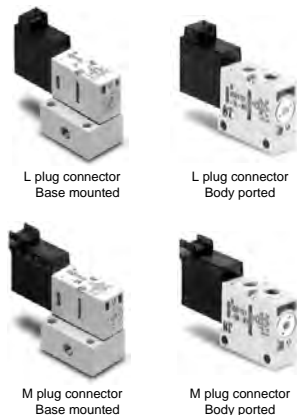

Standard Specifications

Items	Type	Standard type (2 W)	Large flow type (3.2 W / Energy saving type)	
Valve specifications	Valve construction	4 port direct operated poppet valve		
	Fluid	Air/Inert gas		
	Maximum operating pressure	0.7 MPa		
	Minimum operating pressure / Vacuum	0 MPa—101.2 kPa		
	Response time ^{Note 1)}	ON: 4 ms ±1, OFF: 2 ms ±1		
	Ambient and fluid temperature	-10 to 50°C ^{Note 2)}		
	Lubrication	Not required		
	Manual override	Non-locking push type		
	Impact / Vibration resistance ^{Note 3)}	150/30 m/s ²		
	Mounting orientation	Unrestricted		
Electrical specification	Enclosure	Dust tight		
	Weight	34 g (without sub-plate)		
	Coil rated voltage	DC	24 V, 12 V	
	Allowable voltage fluctuation	±10% of rated voltage		
	Coil insulation type	Equivalent to class B		
	Power consumption	DC	2 W	3.2 W (Energy saving type) ^{Note 4)} (Inrush 3.2 W, Holding 1.0 W)
	Electrical entry	L plug connector, M plug connector With light/surge voltage suppressor		

Note 1) Based on dynamic performance test, JIS B 8374-1981. (Coil temperature: 20°C, pressure: 0.5 MPa, at rated voltage, with light and surge suppressor, value at operation excluding restart period) The period immediately after a restart may be delayed for about 1 msec depending on operating conditions.

Note 2) Use dry air to prevent condensation when operating at low temperatures.

Note 3) Impact resistance: No malfunction occurred when it was tested with a drop tester in the axial direction and at right angles to the main valve and armature in both energized and de-energized states once for each condition. (Default settings)

Vibration resistance: No malfunction occurred in a one-sweep between 8.3 and 2000 Hz. Test was performed in the axial direction and at right angles to the main valve and armature in both energized and de-energized states. (Default settings)

Note 4) For the start-up time, refer to the energy saving type's electrical power waveform shown in "Wiring Specifications" of Series VQD1000/Specific Product Precautions.

Symbol

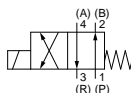

Flow Rate Characteristics

Valve model	Port size	Flow rate characteristics					
		1→4/2(P→A/B)			4/2→5/3(A/B→E/A/EB)		
		C [dm ³ /(s·bar)]	b	Cv	C [dm ³ /(s·bar)]	b	Cv
Body ported	10-VQD1121(V)-□-M5	0.22	0.16	0.05	0.19	0.31	0.05
		0.27	0.24	0.07	0.28	0.28	0.07
Base mounted (With sub-plate)	10-VQD1151(V)-□-M5	0.22	0.10	0.05	0.22	0.31	0.06
		0.27	0.25	0.07	0.27	0.28	0.07

Dimensions

L plug connector: 10-VQD1121□-□L-M5

M plug connector: 10-VQD1121□-□M-M5

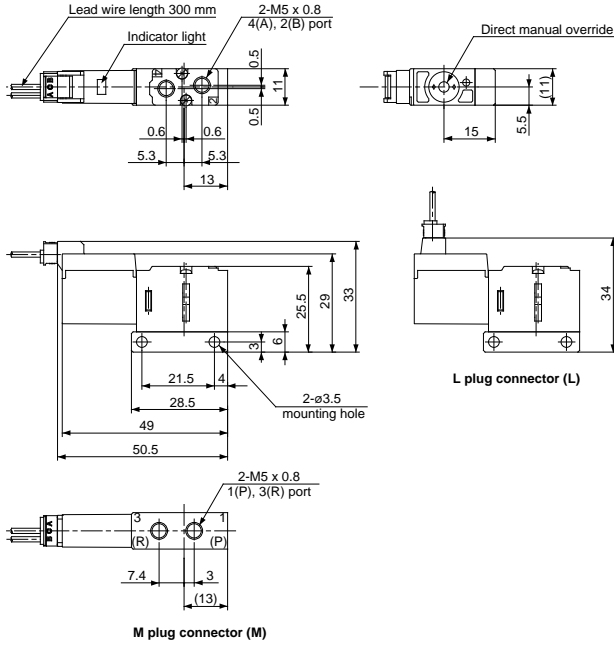

L plug connector: 10-VQD1151□-□L-M5

M plug connector: 10-VQD1151□-□M-M5

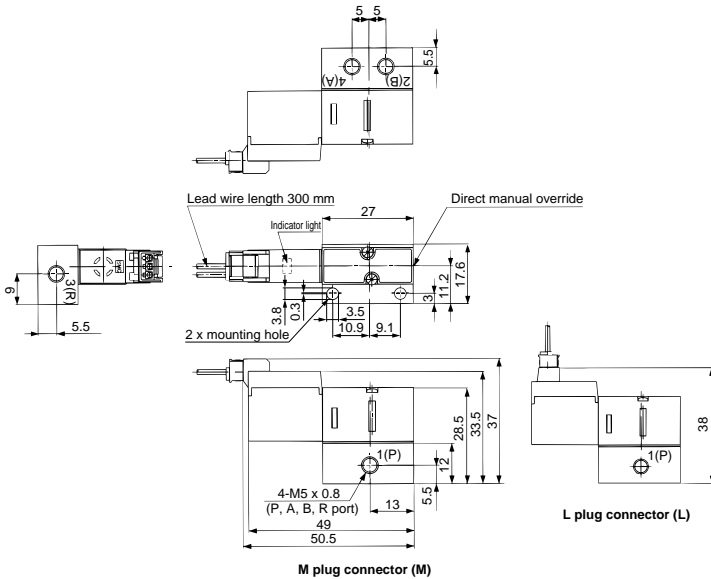

Directional Control Valves
Air Cylinders
Rotary Actuators
Air Grippers
Air Preparation Equipment
Modular F. R.
Pressure Control Equipment
Fittings & Tubing
Flow Control Equipment
Pressure Switches/ Pressure Sensors

Manifold Specifications



How to Order

10 - **VV4QD1** **5** - - -

Clean series

Manifold type
 2 — Body ported
 5 — Base mounted

Valve stations
 02 — 2 stations
 20 — 20 stations (Maximum)

CE-compliant
 Nil — None
 Q — CE-compliant

Port size
 Nil — Body ported — M5 thread
 M5 — Base mounted — M5 thread
 C4 — Base mounted — ø4 One-touch fitting



How to Order Valve

10 - **VQD11** **5** **1** - **5** **L** - **M5** -

Clean series

Body type
 3 — Body ported
 5 — Base mounted

Valve option
 Nil — Standard (2 W)
 V — Vacuum (2 W)
 U^{Note)} — For large flow (3.2 W)
 W^{Note)} — For large flow, Vacuum (3.2 W)
 Note) Energy saving type

Rated voltage
 5 — 24 VDC
 6 — 12 VDC

Electrical entry	
L: Plug lead type L plug connector, With lead wire With light/surge voltage suppresser	
LO: Plug lead type L plug connector, Without connector With light/surge voltage suppresser	
M: Plug lead type M plug connector, With lead wire With light/surge voltage suppresser	
MO: Plug lead type M plug connector, Without connector With light/surge voltage suppresser	

Port size
 Nil — Base mounted
 M5 — Body ported — M5 thread

CE-compliant
 Nil — None
 Q — CE-compliant

Dimensions

Plug lead unit manifold: 10-VV4QD12-□

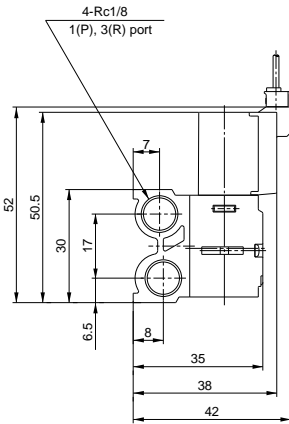

M plug connector (M)

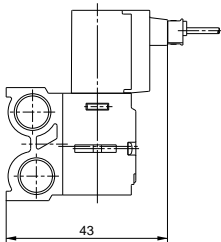
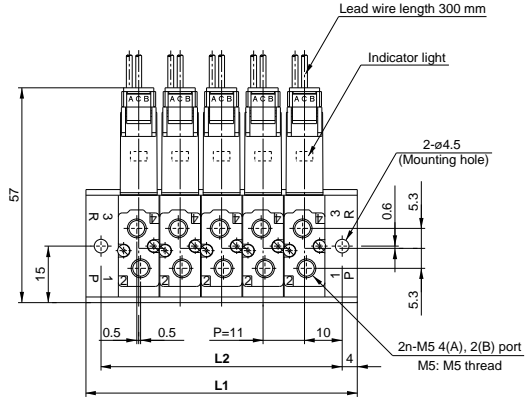

L plug connector (L)

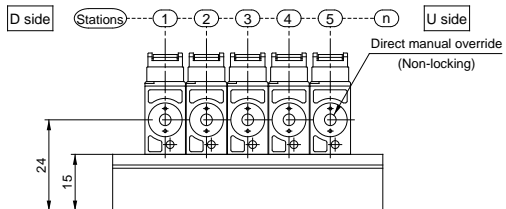

Dimensions

	n: Stations																			
□	1	2	3	4	5	6	7	8	9	10	11	12	13	14	15	16	17	18	19	20
L1	28	39	50	61	72	83	94	105	116	127	138	149	160	171	182	193	204	215	226	237
L2	20	31	42	53	64	75	86	97	108	119	130	141	152	163	174	185	196	207	218	229

Directional Control Valves

Air Cylinders

Rotary Actuators

Air Grippers

Air Preparation Equipment

Modular F. R.

Pressure Control Equipment

Fittings & Tubing

Flow Control Equipment

Pressure Switches/ Pressure Sensors

4 Port Direct Operated Poppet Solenoid Valve 10-VQD1000

Dimensions

Plug lead unit manifold: 10-VV4QD15-□□

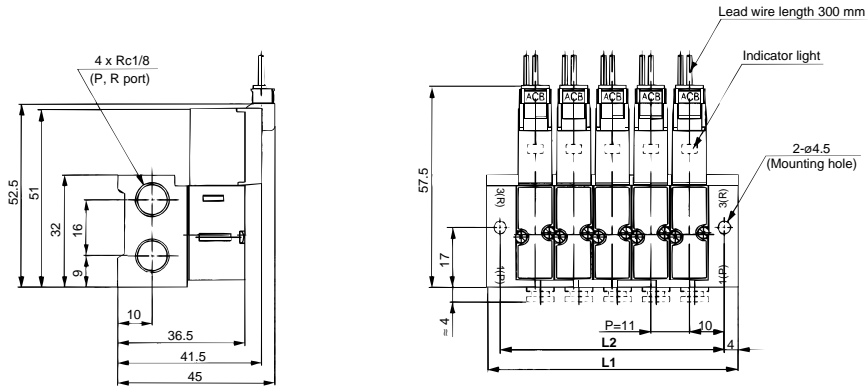

M plug connector (M)

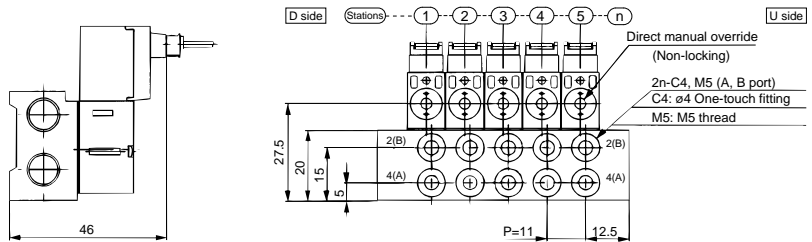

L plug connector (L)

Dimensions









n: Stations

n	2	3	4	5	6	7	8	9	10	11	12	13	14	15	16	17	18	19	20
L1	39	50	61	72	83	94	105	116	127	138	149	160	171	182	193	204	215	226	237
L2	31	42	53	64	75	86	97	108	119	130	141	152	163	174	185	196	207	218	229

Series 10-SYJ300/500/700

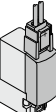
Rubber Seal
3 Port Solenoid Valve

Variations

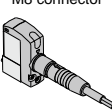
	Series	Port size	Sonic conductance C [dm ³ /(s·bar)]	Actuation type	Voltage	Electrical entry	Option	Manual override			
							Light/Surge voltage suppressor				
Body ported	10-SYJ300  P.604	M3 x 0.5	[Effective area] 0.9 mm ² { 2→3 } {(A→R)}	● N.C. ● N.O.	For DC ■ 24 VDC 12 VDC 6 VDC 5 VDC 3 VDC	Grommet 	For DC ■ With surge voltage suppressor ■ With light/surge voltage suppressor	■ Non-locking push type			
	10-SYJ500  P.615	M5 x 0.8	0.66 { 2→3 } {(A→R)}						L plug connector 		
	10-SYJ700  P.627	1/8	2.5 { 2→3 } {(A→R)}							M plug connector 	
Base mounted	10-SYJ300  P.604	M5 x 0.8	0.36 { 2→3 } {(A→R)}			For AC ■ 100 VAC $\frac{50}{60}$ Hz 110 VAC $\frac{50}{60}$ Hz 200 VAC $\frac{50}{60}$ Hz 220 VAC $\frac{50}{60}$ Hz			For AC  (SYJ500, 700 only)		For AC (Note) ■ With light/surge voltage suppressor
	10-SYJ500  P.615	1/8	1.2 { 2→3 } {(A→R)}								
	10-SYJ700  P.627	1/8, 1/4	2.7 { 2→3 } {(A→R)}							M8 connector 	

Note) All AC voltage models have built-in surge voltage suppressor.

Directional Control Valves
 Air Cylinders
 Rotary Actuators
 Air Grippers
 Air Preparation Equipment
 Modular F. R.
 Pressure Control Equipment
 Fittings & Tubing
 Flow Control Equipment
 Pressure Switches/ Pressure Sensors

Manifold Variations

	Valve series	A port location	P, R ports size	A port size							
				M3	M5	1/8	With One-touch fitting				
							Applicable tubing O.D.				
				ø4	ø6	ø8	N3	N7	N9		
Body ported	10-SYJ300 P.609	Top	M5 x 0.8	Note)	—	—	—	—	—	—	
	10-SYJ500 P.620	Top	1/8	—	●	—	—	—	—	—	
	10-SYJ700 P.632	Top	1/8	—	—	Note)	—	—	—	—	—
1/4			—	—	●	—	—	—	—	—	
Base mounted	10-SYJ300 P.609	Side	M5 x 0.8	Note)	—	—	—	—	—	—	
			1/8	—	●	—	●	—	●	—	
	10-SYJ500 P.620	Bottom	1/8	—	●	●	—	—	—	—	
		Side		—	●	●	●	●	—	●	
	10-SYJ700 P.632	Bottom	1/8	—	—	Note)	—	—	—	—	
			1/4	—	—	●	—	—	—	—	
	Side	1/4	—	—	●	—	●	●	—	●	

Note) Only for internal pilot

Base mounted

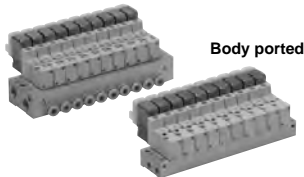

Series 10-SYJ300

Base mounted

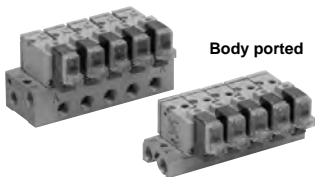

Series 10-SYJ500

Base mounted

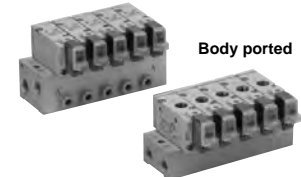

Series 10-SYJ700

Series 10-SYJ300

Rubber Seal
3 Port Pilot Solenoid Valve



Specifications

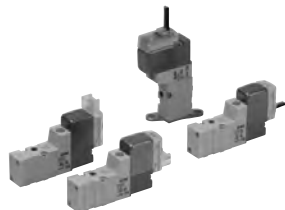

Body ported



Base mounted

Symbol

Internal pilot

10-SYJ31²M

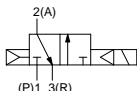

10-SYJ32²M

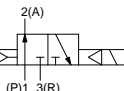

Made to Order
(For details, refer to page 640.)

Fluid		Air
Operating pressure range (MPa)	Internal pilot	0.15 to 0.7
Ambient and fluid temperature (°C)		-10 to 50 (No freezing.)
Response time ms (at 0.5 MPa) ^{Note 1)}		15 or less
Max. operating frequency (Hz)		10
Manual override (Manual operation)		Non-locking push type, push-turn locking slotted type, push-turn locking lever type
Pilot exhaust method		Main/Pilot valve common exhaust
Lubrication		Not required
Mounting orientation		Unrestricted
Impact/Vibration resistance (m/s ²) ^{Note 2)}		150/30
Enclosure		Dust proof (* M8 connector conforms to IP65.)

* Based on IEC60529

Note 1) Based on dynamic performance test, JIS B 8374-1981. (Coil temperature: 20°C, at rated voltage, without surge voltage suppressor.)

Note 2) Impact resistance: No malfunction occurred when it was tested in the axial direction and at right angles to the main valve and armature in both energized and de-energized states once for each condition. (Default settings)

Vibration resistance: No malfunction occurred in a one-sweep test between 45 and 2000 Hz. Test was performed in both energized and de-energized states in the axial direction and at right angles to the main valve and armature. (Default settings)

Solenoid Specifications

Electrical entry		Grommet (G), (H), L plug connector (L), M plug connector (M), M8 connector (W)	
Coil rated voltage (V)	DC	24, 12, 6, 5, 3	
	AC ^{50/60} Hz	100, 110, 200, 220	
Allowable voltage fluctuation		±10% of rated voltage *	
Power consumption (W)	DC	Standard	0.35 (With light: 0.4)
		With power saving circuit	0.1 (With light only) * [Starting 0.4, Holding 0.1]
Apparent power (VA) *	AC	100 V	0.78 (With light: 0.81)
		110 V	0.86 (With light: 0.89)
		[115 V]	[0.94 (With light: 0.97)]
		200 V	1.18 (With light: 1.22)
		220 V	1.30 (With light: 1.34)
		[230 V]	[1.42 (With light: 1.46)]
Surge voltage suppressor		Diode (Varistor when non-polar types)	
Indicator light		LED	

* Common between 110 VAC and 115 VAC, and between 220 VAC and 230 VAC.

* For 115 VAC and 230 VAC, the allowable voltage is -15% to +5% of rated voltage.

* For details, refer to page 643.

Flow Rate Characteristics/Weight

Valve model	Actuation type	Port size	Flow rate characteristics						Effective area (mm ²)	Weight (g) ^{Note)}		
			1→2 (P→A)			2→3 (A→R)				Grommet	L/M plug connector	M8 connector
			C [dm ³ /s bar]	b	Cv	C [dm ³ /s bar]	b	Cv				
Body ported	10-SYJ312M	N.C.	M3 x 0.5	—	—	—	—	—	0.9	32	33	37
	10-SYJ322M	N.O.		—	—	—	—	—				
Base mounted (with sub-plate)	10-SYJ314M	N.C.	M5 x 0.8	0.41	0.18	0.086	0.35	0.33	—	53 (32)	54 (33)	58 (37)
	10-SYJ324M	N.O.		0.36	0.31	0.089	0.36	0.31				

Note) Value for DC. Add 1 g for AC. (): Without sub-plate.



Note) CE-compliant:
For DC only.

[Option]

How to Order

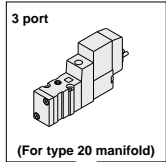

Body ported

Base mounted

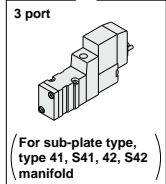

Body option

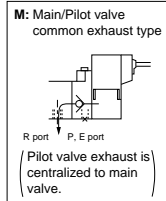

Rated voltage

DC		CE-compliant
5	24 VDC	●
6	12 VDC	●
V	6 VDC	●
S	5 VDC	●
R	3 VDC	●

AC (50/60 Hz)		CE-compliant
1	100 VAC	—
2	200 VAC	—
3	110 VAC [115 VAC]	—
4	220 VAC [230 VAC]	—

* For type W□, only DC voltage is available.
Note) CE-compliant: For DC only.

Actuation type

1	Normally closed
2	Normally open

Light/Surge voltage suppressor

Nil	Without light/surge voltage suppressor
S	With surge voltage suppressor
Z	With light/surge voltage suppressor
R	With surge voltage suppressor (Non-polar type)
U	With light/surge voltage suppressor (Non-polar type)

* For AC voltage valves there is no "S" option. It is already built into the rectifier circuit.
* For type R, U, only DC voltage is available.
* Power saving circuit is only available for the "Z" type.

Bracket

Nil: Without bracket
F : With bracket

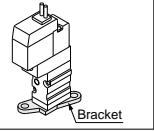

* Bracket is mounted.
* Brackets cannot be retrofitted.
* External pilot type is not available.

10-SYJ3 1 2 M □ - 5 M □ □ □ - M3 - □ □

10-SYJ3 1 4 M □ - 5 M □ □ □ - □ □ □ □

Clean series

Coil type

Nil	Standard
T	With power saving circuit (24, 12 VDC only)

* Power saving circuit is not available for W□ type.

Port size

Nil: Without sub-plate M5: M5 port
With sub-plate

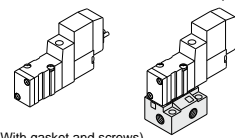

Nil	—
Q	CE-compliant

Note) CE-compliant:
For DC only.

Electrical entry

24, 12, 6, 5, 3 VDC/100, 110, 200, 220 VAC				24, 12, 6, 5, 3 VDC	
Grommet	L plug connector	M plug connector		M8 connector	
G: Lead wire length 300 mm	L: With lead wire (Length 300 mm)	M: With lead wire (Length 300 mm)	MN: Without lead wire	WO: Without connector cable	
H: Lead wire length 600 mm	LN: Without lead wire	LO: Without connector	MO: Without connector	W□: With connector cable (Note 1)	

* LN, MN type: With 2 sockets.
* Refer to page 642 for the lead wire length of L and M plug connectors.
* Refer to page 645 for the connector assembly with cover for L and M plug connectors.
* For connector cable of M8 connector, refer to page 646.
* M8 connector conforming to IEC60947-5-2 is also available. Refer to page 640 for details.
Note 1) Enter the cable length symbols in □. Please be sure to fill in the blank referring to page 646.

Manual override

Nil: Non-locking push type

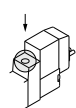

D: Push-turn locking slotted type

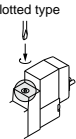

E: Push-turn locking lever type

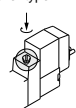

Note) When placing an order for body ported solenoid valves as a single unit, the mounting screws for the manifold and gasket are not attached. Order them separately, if necessary. (For details, refer to page 610.)

Construction

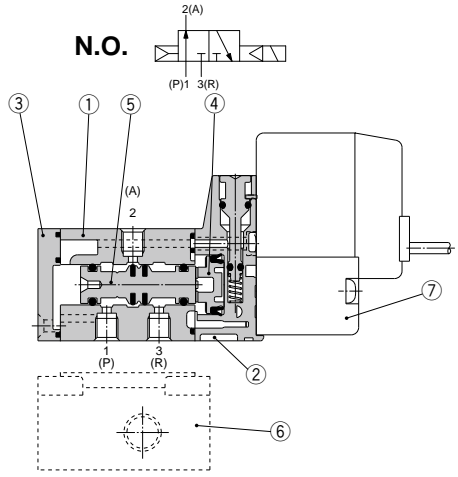
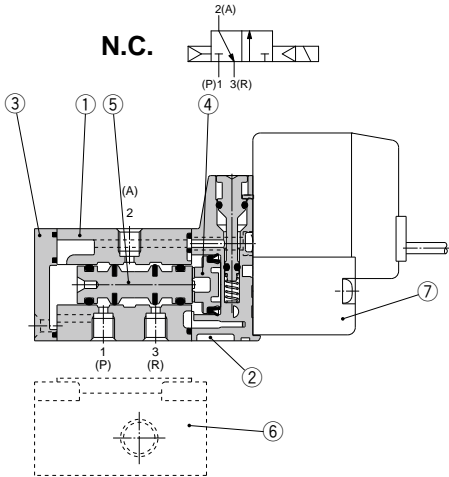

Component Parts

No.	Description	Material	Note
1	Body	Zinc die-casted	White
2	Piston plate	Resin	White
3	End cover	Resin	White
4	Piston	Resin	—
5	Spool valve assembly	Aluminum, H-NBR	—

Replacement Parts

No.	Description	Part no.	Note
6	Sub-plate ^{Note)}	SYJ300-9-1-(Q)	Zinc die-casted
7	Pilot valve	V111(T)-□□□□	—

(Note) Add suffix “-Q” for the CE-compliant product.

How to Order Pilot Valve Assembly

V111 □ — 5 G □ □

Coil type

Nil	Standard
T	With power saving circuit (24, 12 VDC only)

* Power saving circuit is not available for W□ type.

Rated voltage

5	24 VDC
6	12 VDC
V	6 VDC
S	5 VDC
R	3 VDC
1	100 VAC 50/60 Hz
2	200 VAC 50/60 Hz
3	110 VAC 50/60 Hz [115 VAC 50/60 Hz]
4	220 VAC 50/60 Hz [230 VAC 50/60 Hz]

* For type W□, only DC voltage is available.
* CE-compliant: For DC only.

Light/Surge voltage suppressor

Nil	Without light/surge voltage suppressor
S	With surge voltage suppressor
Z	With light/surge voltage suppressor
R	With surge voltage suppressor (Non-polar type)
U	With light/surge voltage suppressor (Non-polar type)

* For AC voltage valves there is no “S” option. It is already built into the rectifier circuit.
* For “R” and “U”, only DC voltage is available.
* Power saving circuit is only available for the “Z” type.

Electrical entry

G	Grommet, 300 mm lead wire
H	Grommet, 600 mm lead wire
L	With lead wire
LN	L plug connector Without lead wire
LO	Without connector
M	With lead wire
MN	M plug connector Without lead wire
MO	Without connector
WO	M8 Without connector cable
W□	With connector cable ^{Note 1)}

* For connector cable of M8 connector, refer to page 646.
Note 1) Enter the cable length symbols in □. Please be sure to fill in the blank referring to page 646.

(Note) Since V111 is CE-compliant as standard, the suffix “-Q” is not necessary.

Body Ported

Grommet (G), (H): 10-SYJ3□2M-□^G□□-M3

With bracket:

10-SYJ3□2M-□^G□□-M3-F

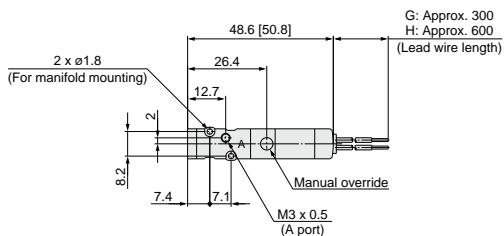

G: Approx. 300
H: Approx. 600
(Lead wire length)

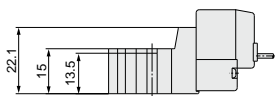
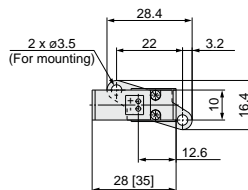

(Light/surge voltage suppressor)

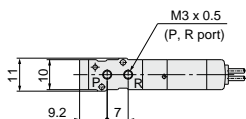
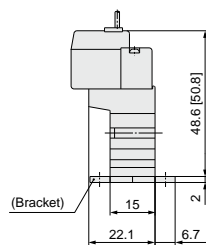
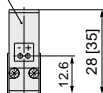

L plug connector (L):
10-SYJ3□2M-□L□□-M3

M plug connector (M):
10-SYJ3□2M-□M□□-M3

M8 connector (WO):
10-SYJ3□2M-□WO□□-M3

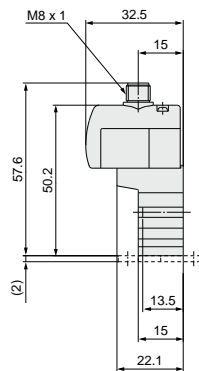
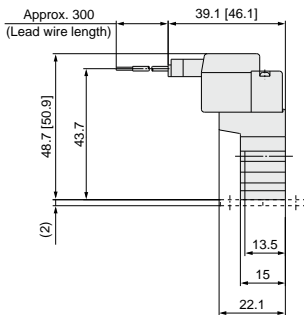
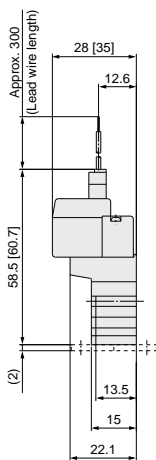

* Refer to page 646 for dimensions with connector cable.

Base Mounted (With Sub-plate)

* [] for AC

Grommet (G), (H): 10-SYJ3□4M-□^G□□-M5

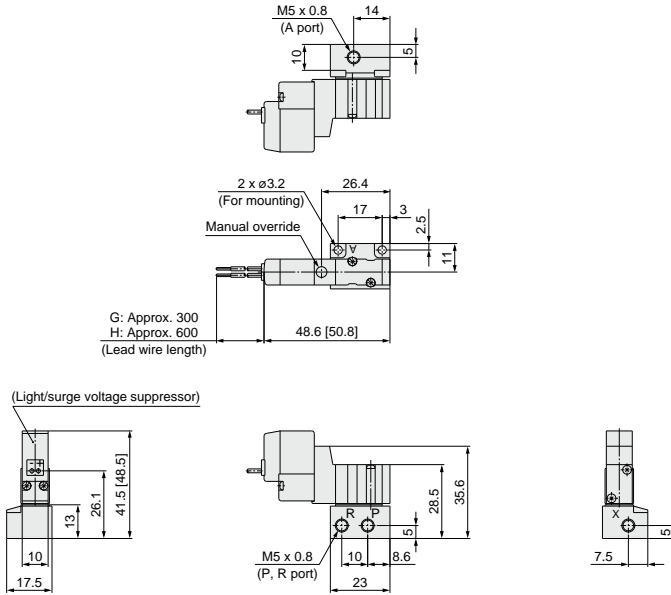

L plug connector (L):
10-SYJ3□4M-□L□□-M5

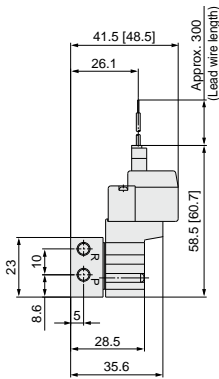

M plug connector (M):
10-SYJ3□4M-□M□□-M5

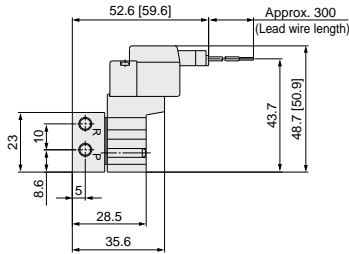

M8 connector (WO):
10-SYJ3□4M-□WO□□-M5

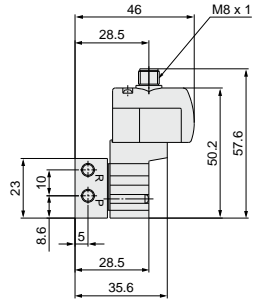

* Refer to page 646 for dimensions with connector cable.

Series 10-SYJ300 Manifold Specifications

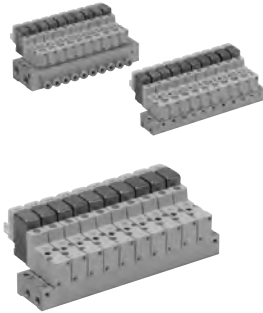

Manifold Specifications

Model	For internal pilot	Type 20	Type 41, S41	Type 42, S42
Manifold type		Single base/B mount		
P (SUP), R (EXH)		Common SUP/Common EXH		
Valve stations		2 to 20 stations		
A port Porting specifications	Location	Valve		Base
	Direction	Top		Side
Port size	P, R port	M5 x 0.8	M5 x 0.8	1/8
	A port	M3 x 0.5	M3 x 0.5	M5 x 0.8 C4 (ø4 One-touch fitting)

Flow Rate Characteristics

Manifold			Port size		Flow rate characteristics						Effective area (mm ²)
					1→2 (P→A)			2→3 (A→R)			
					C [dm ³ /(s·bar)]	b	Cv	C [dm ³ /(s·bar)]	b	Cv	
Body ported for internal pilot	Type 10-SS3YJ3-20	10-SYJ3□2M	M5 x 0.8	M3 x 0.5	—	—	—	—	—	—	0.9
	Type 10-SS3YJ3-41 S41	10-SYJ3□4M	M5 x 0.8	M3 x 0.5	—	—	—	—	—	—	1.5
Base mounted for internal pilot	Type 10-SS3YJ3-42-M5	10-SYJ3□4M	1/8	M5 x 0.8	0.31	0.17	0.075	0.32	0.11	0.072	—
	Type 10-SS3YJ3-42-C4			C4	0.33	0.36	0.086	0.33	0.2	0.082	—
	Type 10-SS3YJ3-S42-M5	10-SYJ3□4M	1/8	M5 x 0.8	0.32	0.3	0.079	0.33	0.35	0.086	—
	Type 10-SS3YJ3-S42-C4			C4	0.35	0.17	0.082	0.35	0.26	0.086	—

Note) The values are for individually operated 2 position type manifold bases.

How to Order Manifold (Example)

Instruct by specifying the valves and blanking plate assembly to be mounted on the manifold along with the manifold base model no.

(Example)

10-SS3YJ3-20-03 1 set (manifold base) 10-SS3YJ3-42-03-C4 1 set (manifold base)

* 10-SYJ312M-5LZ-M3 2 sets (valve) * 10-SYJ314M-5G 2 sets (valve)

* SYJ300-10-7A 1 set (blanking plate assembly) * SYJ300-10-7A 1 set (blanking plate assembly)

↳ The asterisk denotes the symbol for assembly. Prefix it to the part no. of the solenoid valve, etc.

Combinations of Solenoid Valve, Manifold Gasket and Manifold Base

Body ported (Type 10-SYJ3□2M(-Q))

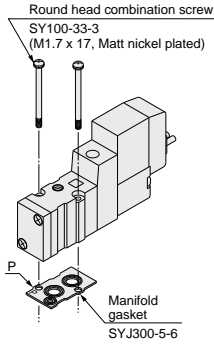

Applicable base
10-SS3YJ3-20(-Q)
Manifold base

Base mounted (Type 10-SYJ3□4M(-Q))

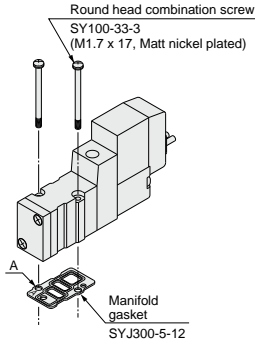

Applicable base
Sub-plate
10-SS3YJ3-41(-Q)
10-SS3YJ3-S41(-Q)
10-SS3YJ3-42(-Q)
10-SS3YJ3-S42(-Q) } Manifold base

Blanking Plate Assembly

Part no.: SYJ300-10-7A(-Q)

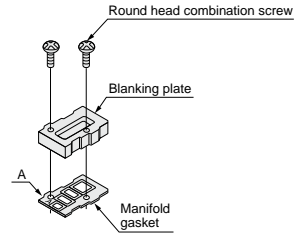

Applicable base
Sub-plate
10-SS3YJ3-20(-Q)
10-SS3YJ3-41(-Q)
10-SS3YJ3-S41(-Q)
10-SS3YJ3-42(-Q)
10-SS3YJ3-S42(-Q) } Manifold base

Note) Add suffix "Q" for the CE-compliant product.

Caution

Mounting screw tightening torque

M1.7: 0.12 N·m

Use caution to the assembly orientation for solenoid valves, gasket and optional parts.

Directional Control Valves

Air Cylinders

Rotary Actuators

Air Grippers

Air Preparation Equipment

Modular F. R.

Pressure Control Equipment

Fittings & Tubing

Flow Control Equipment

Pressure Switches/ Pressure Sensors



Note) CE-compliant:
For DC only. [Option]

Manifold for Internal Pilot Type

Type 20

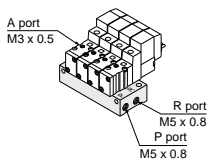

How to Order

10 - SS3YJ3 - 20 - 05 - [] - []

Clean series

Stations	
02	2 stations
:	:
20	20 stations

Bracket

Nil	Without bracket
F	With bracket

CE-compliant

Nil	—
Q	CE-compliant

Applicable solenoid valve
10-SYJ312M-□□□□-M3(-Q)
10-SYJ322M-□□□□-M3(-Q)

Applicable blanking
plate assembly

Refer to page 610.

Note) For more than 10 stations, supply air to both sides of P port and exhaust air from both sides of R port.

Type 41

Type 41

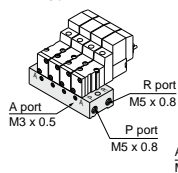

Type S41

(Pilot valve is on the A port side.)

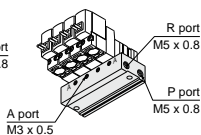

How to Order

10 - SS3YJ3 - [] 41 - 05 - M3 - []

Clean series

Valve mounting direction	
Nil	Pilot valve is opposite the A port side.
S	Pilot valve is on the A port side.

Stations	
02	2 stations
:	:
20	20 stations

CE-compliant

Nil	—
Q	CE-compliant

Applicable solenoid valve
10-SYJ314M-□□□□(-Q)
10-SYJ324M-□□□□(-Q)

Applicable blanking
plate assembly

Refer to page 610.

Note) For more than 10 stations, supply air to both sides of P port and exhaust air from both sides of R port.

Type 42

Type 42

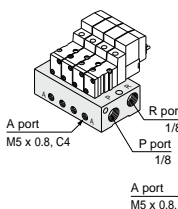

Type S42

(Pilot valve is on the A port side.)

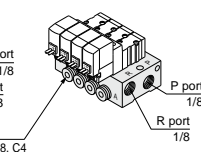

How to Order

10 - SS3YJ3 - [] 42 - 05 - M5 [] - []

Clean series

Valve mounting direction	
Nil	Pilot valve is opposite the A port side.
S	Pilot valve is on the A port side.

Stations	
02	2 stations
:	:
20	20 stations

CE-compliant

Nil	—
Q	CE-compliant

P, R port thread type	
Nil	Rc
F	G
N	NPT
T	NPTF

A port size	
M5	M5 x 0.8
C4	ø4 One-touch fitting
N3	ø5/32" One-touch fitting

Applicable solenoid valve
10-SYJ314M-□□□□(-Q)
10-SYJ324M-□□□□(-Q)

Applicable blanking
plate assembly

Refer to page 610.

Note) For more than 8 stations, supply/exhaust air to/from both sides of P port and R port.

Type 20 Manifold: Top Ported/10-SS3YJ3-20-**Stations** -00□ (-F)

* [] for AC

Grommet (G)

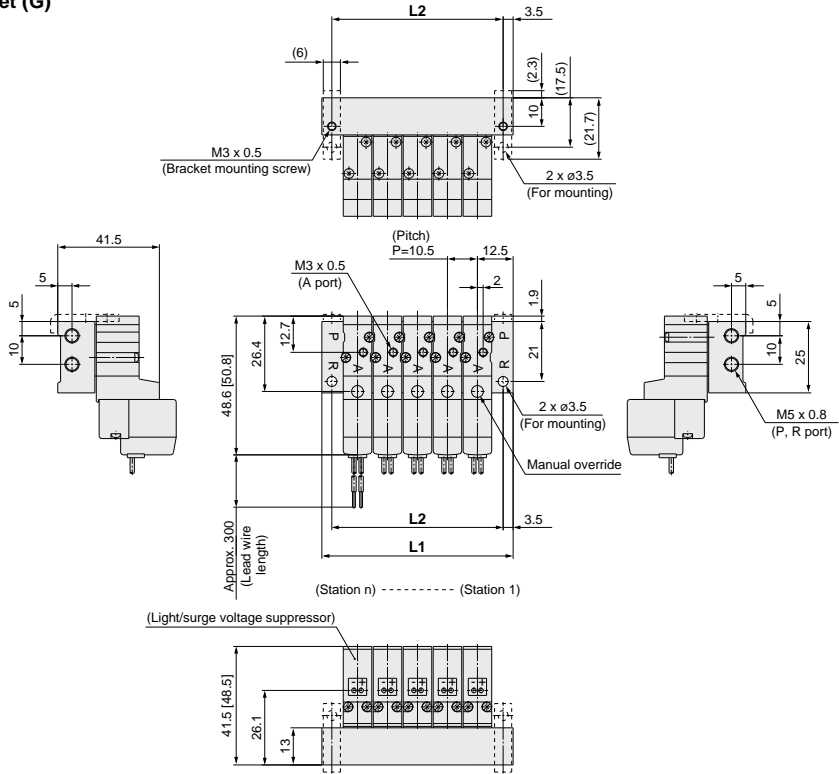

L plug connector (L)

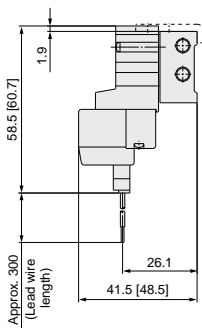

M plug connector (M)

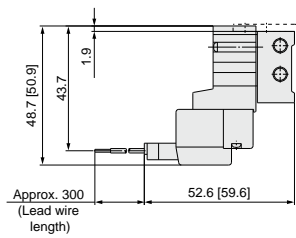

M8 connector (WO)

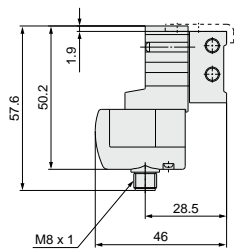

* Refer to page 646 for dimensions with connector cable.

Station	2	3	4	5	6	7	8	9	10	11	12	13	14	15	16	17	18	19	20
L1	35.5	46	56.5	67	77.5	88	98.5	109	119.5	130	140.5	151	161.5	172	182.5	193	203.5	214	224.5
L2	28.5	39	49.5	60	70.5	81	91.5	102	112.5	123	133.5	144	154.5	165	175.5	186	196.5	207	217.5

Type 41 Manifold: Side Ported/10-SS3YJ3-41-**Stations**-M3

* [] for AC

Grommet (G)

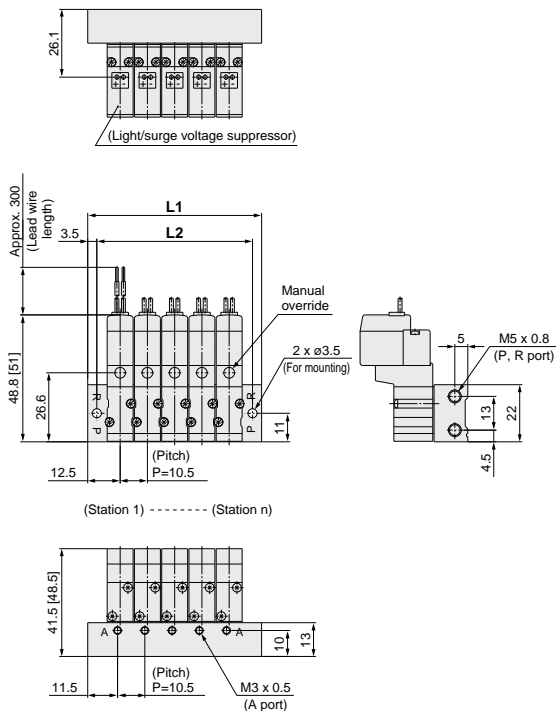

Type S41 Manifold: Side Ported

(Pilot valve is on the A port side)

10-SS3YJ3-S41-**Stations**-M3

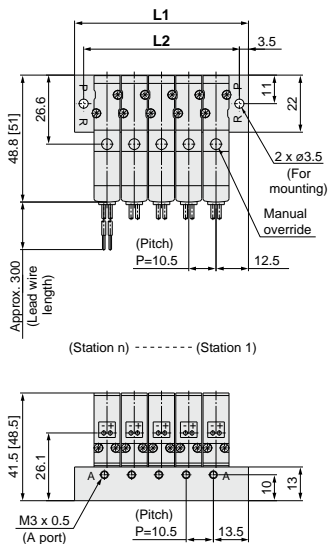

L plug connector (L)

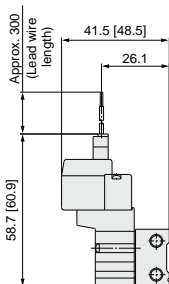

M plug connector (M)

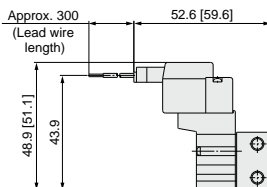

M8 connector (WO)

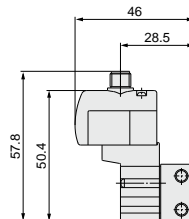

* Refer to page 646 for dimensions with connector cable.

Station	Station 2	3	4	5	6	7	8	9	10	11	12	13	14	15	16	17	18	19	Station 20
L1	35.5	46	56.5	67	77.5	88	98.5	109	119.5	130	140.5	151	161.5	172	182.5	193	203.5	214	224.5
L2	28.5	39	49.5	60	70.5	81	91.5	102	112.5	123	133.5	144	154.5	165	175.5	186	196.5	207	217.5

Type 42 Manifold: Side Ported/10-SS3YJ3-42- Stations -M5, C4 N3 □

* [] for AC

Grommet (G)
For M5

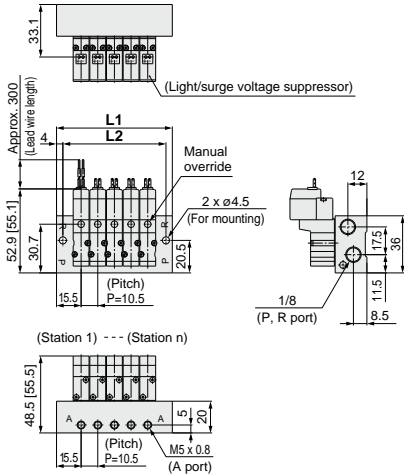

For C4 N3 □ (Built-in One-touch fitting)

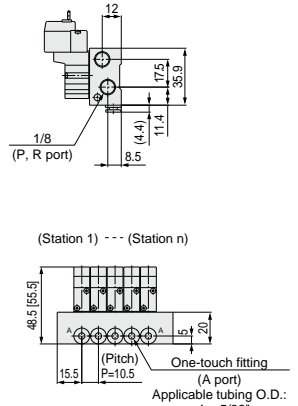

L plug connector (L)

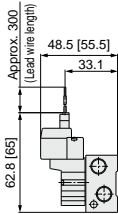

M plug connector (M)

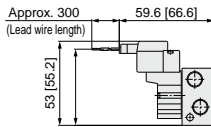

M8 connector (WO)

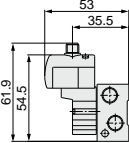

* Refer to page 646 for dimensions with connector cable.

Type S42 Manifold: Side Ported (Pilot valve is on the A port side) /10-SS3YJ3-S42- Stations -M5, C4 N3 □

Grommet (G)
For M5

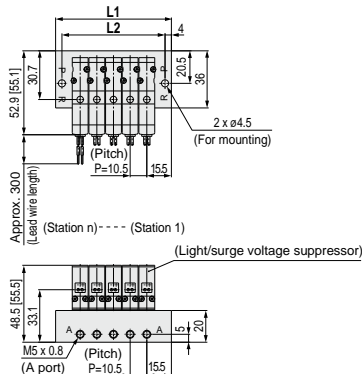

For C4 N3 □ (Built-in One-touch fitting)

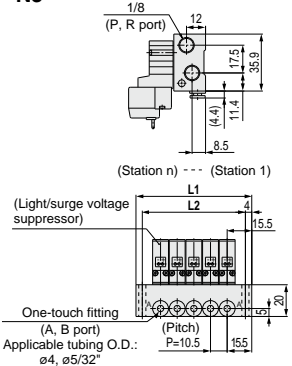

Station	Station 2	3	4	5	6	7	8	9	10	11	12	13	14	15	16	17	18	19	Station 20
L1	41.5	52	62.5	73	83.5	94	104.5	115	125.5	136	146.5	157	167.5	178	188.5	199	209.5	220	230.5
L2	33.5	44	54.5	65	75.5	86	96.5	107	117.5	128	138.5	149	159.5	170	180.5	191	201.5	212	222.5

Directional Control Valves
 Air Cylinders
 Rotary Actuators
 Air Grippers
 Air Preparation Equipment
 Modular F. R.
 Pressure Control Equipment
 Fittings & Tubing
 Flow Control Equipment
 Pressure Switches/ Pressure Sensors

Series 10-SYJ500

Rubber Seal
3 Port Pilot Solenoid Valve



Specifications

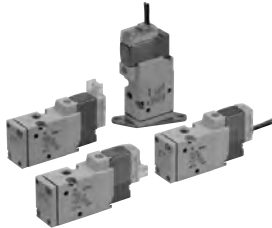

Body ported

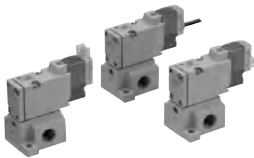

Base mounted

Fluid		Air
Operating pressure range (MPa)	Internal pilot	0.15 to 0.7
Ambient and fluid temperature (°C)		-10 to 50 (No freezing.)
Response time ms (at 0.5 MPa) ^{Note 1)}		25 or less
Max. operating frequency (Hz)		5
Manual override (Manual operation)		Non-locking push type, push-turn locking slotted type, push-turn locking lever type
Pilot exhaust method		Main/Pilot valve common exhaust
Lubrication		Not required
Mounting orientation		Unrestricted
Impact/Vibration resistance (m/s ²) ^{Note 2)}		150/30
Enclosure		Dust proof (* DIN terminal, M8 connector conforms to IP65.)

* Based on IEC60529

Note 1) Based on dynamic performance test, JIS B 8374-1981. (Coil temperature: 20°C, at rated voltage, without surge voltage suppressor.)

Note 2) Impact resistance: No malfunction occurred when it was tested in the axial direction and at right angles to the main valve and armature in both energized and de-energized states once for each condition. (Default settings)

Vibration resistance: No malfunction occurred in a one-sweep test between 45 and 2000 Hz. Test was performed in both energized and de-energized states in the axial direction and at right angles to the main valve and armature. (Default settings)

Solenoid Specifications

Symbol

Internal pilot

10-SYJ51²M

10-SYJ52²M

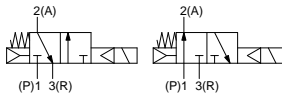

Made to Order
(For details, refer to page 640.)

Electrical entry		Grommet (G), (H), L plug connector (L), M plug connector (M), DIN terminal (D), (Y), M8 connector (W)	
		G, H, L, M, W	D, Y
Coil rated voltage (V)	DC	24, 12, 6, 5, 3	24, 12
	AC ^{50/60} Hz	100, 110, 200, 220	
Allowable voltage fluctuation		±10% of rated voltage *	
Power consumption (W)	DC	Standard	0.35 (With light: 0.4 (DIN terminal with light: 0.45))
		With power saving circuit	0.1 (With light only) * [Starting 0.4, Holding 0.1]
Apparent power (VA) *	AC	100 V	0.78 (With light: 0.81) 0.78 (With light: 0.87)
		110 V [115 V]	0.86 (With light: 0.89) 0.86 (With light: 0.97) [0.94 (With light: 1.07)]
		200 V	1.18 (With light: 1.22) 1.15 (With light: 1.30)
		220 V [230 V]	1.30 (With light: 1.34) 1.27 (With light: 1.46) [1.42 (With light: 1.46)]
Surge voltage suppressor		Diode (DIN terminal, varistor when non-polar types)	
Indicator light		LED (Neon light when AC with DIN terminal)	

* Common between 110 VAC and 115 VAC, and between 220 VAC and 230 VAC.

* For 115 VAC and 230 VAC, the allowable voltage is -15% to +5% of rated voltage.

* For details, refer to page 643.

Flow Rate Characteristics/Weight

Valve model	Actuation type	Port size	Flow rate characteristics						Weight (g) ^{Note)}			
			1→2 (P→A)			2→3 (A→R)			Grommet	L/M plug connector	DIN terminal	M8 connector
			C [dm ³ /(s·bar)]	b	Cv	C [dm ³ /(s·bar)]	b	Cv				
Body ported	10-SYJ512M	N.C.	0.53	0.45	0.14	0.47	0.39	0.12	46	47	68	51
	10-SYJ522M	N.O.	0.66	0.45	0.18	0.66	0.45	0.18				
Base mounted (with sub-plate)	10-SYJ514M	N.C.	1.2	0.41	0.32	1.1	0.46	0.32	60 (46)	61 (47)	82 (68)	65 (51)
	10-SYJ524M	N.O.	1.3	0.37	0.33	1.2	0.48	0.34				

Note) Value for DC. Add 3 g for AC. (): Without sub-plate.



Note) AC-type models that are CE-compliant have DIN terminals only. [Option]

How to Order

Rated voltage

DC	
5	24 VDC
6	12 VDC
V	6 VDC
S	5 VDC
R	3 VDC

* DC specifications of type D, Y, DO and YO are only available with 12 and 24 VDC.

AC (50/60 Hz)

1	100 VAC
2	200 VAC
3	110 VAC [115 VAC]
4	220 VAC [230 VAC]

* For type W□, only DC voltage is available. Note) AC-type models that are CE-compliant have DIN terminals only.

Actuation type

1	Normally closed
2	Normally open

Light/Surge voltage suppressor

Electrical entry for G, H, L, M and W

Nil	Without light/surge voltage suppressor
S	With surge voltage suppressor
Z	With light/surge voltage suppressor
R	With surge voltage suppressor (Non-polar type)
U	With light/surge voltage suppressor (Non-polar type)

* For AC voltage valves there is no "S" option. It is already built into the rectifier circuit.
* For type "R" and "U", only DC voltage is available.
* Power saving circuit is only available for the "Z" type.

Electrical entry for D, Y

Nil	Without light/surge voltage suppressor
S	With surge voltage suppressor (Non-polar type)
Z	With light/surge voltage suppressor (Non-polar type)

* DOZ and YOZ are not available.
* For AC voltage valves there is no "S" option. It is already built into the rectifier circuit.

Bracket

Nil	Without bracket
F	With bracket

* Bracket is not mounted.

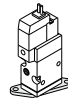

3 port



(For type 20 manifold)

Body ported

Base mounted

3 port



(For sub-plate type, type 40, 41 manifold)

Body option

M: Main/Pilot valve common exhaust type



Clean series

Coil type

Nil	Standard
T	With power saving circuit (24, 12 VDC only)

* Power saving circuit is not available for D, Y, DO, YO or W□ types.

Manual override

Nil: Non-locking push type



D: Push-turn locking slotted type

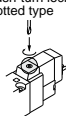

Port size

Nil: Without sub-plate 01: 1/8 port With sub-plate

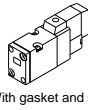

(With gasket and screws)

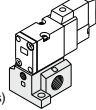

Thread type

Nil	Rc
F	G
N	NPT
T	NPTF

CE-compliant	
Nil	—
Q	CE-compliant

Note) AC-type models that are CE-compliant have DIN terminals only.

Electrical entry

24, 12, 6, 5, 3 VDC/100, 110, 200, 220 VAC			24, 12 VDC/100, 110, 200, 220 VAC		24, 12, 6, 5, 3 VDC	
Grommet	L plug connector	M plug connector	DIN terminal		M8 connector	
G: Lead wire length 300 mm 	L: With lead wire (Length 300 mm) 	M: Without lead wire (Length 300 mm) 	MM: Without lead wire 	D: With connector 	Y: With connector 	WO: Without connector cable
H: Lead wire length 600 mm 	LN: Without lead wire 	LO: Without connector 	MO: Without connector 	DO: Without connector 	YO: Without connector 	WI: With connector cable Note 1)
CE-compliant	DC	●	●	●	●	●
	AC	—	—	—	—	—

Note) When placing an order for body ported solenoid valves as a single unit, the mounting screws for the manifold and gasket are not attached. Order them separately, if necessary. (For details, refer to page 621.)

- * LN, MN type: With 2 sockets.
- * Refer to page 642 for the lead wire length of L and M plug connectors.
- * Refer to page 645 for the connector assembly with cover for L and M plug connectors.

* DIN terminal type "Y" which conforms to EN-175301-803C (former DIN43650C) is also available. For details, refer to page 644.

* For connector cable of M8 connector, refer to page 646.
* M8 connector conforming to IEC60947-5-2 is also available. Refer to page 640 for details.

Note 1) Enter the cable length symbols in □. Please be sure to fill in the blank referring to page 646.

Directional Control Valves
Air Cylinders
Rotary Actuators
Air Grippers
Air Preparation Equipment
Modular F. R.
Pressure Control Equipment
Fittings & Tubing
Flow Control Equipment
Pressure Switches/Pressure Sensors

Construction

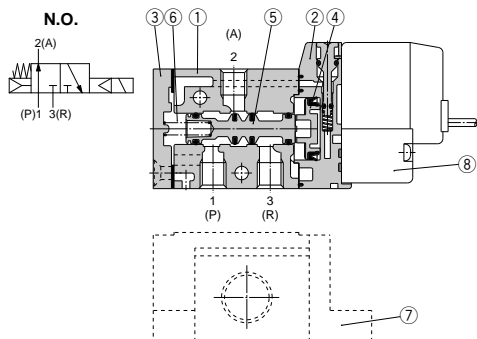
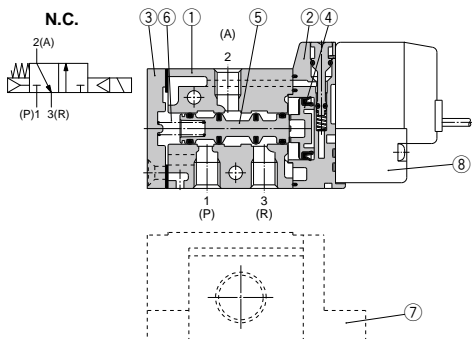

Component Parts

No.	Description	Material	Note
1	Body	Aluminum die-cast	White
2	Piston plate	Resin	White
3	End cover	Aluminum die-cast	White
4	Piston	Resin	—
5	Spool valve assembly	—	—
6	Spool spring	Stainless steel	—

Replacement Parts

No.	Description	Part no.	Note
7	Sub-plate ^(Note)	SYJ500-9-1(-Q)	Aluminum die-cast
8	Pilot valve	V111(T)□□□□	
—	Bracket assembly	SYJ5000-13-3A	

(Note) Add suffix "-Q" for the CE-compliant product.

How to Order Pilot Valve Assembly

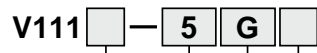

Coil type

Nil	Standard
T	With power saving circuit (24, 12 VDC only)

* Power saving circuit is not available for W□ type.

Rated voltage

5	24 VDC
6	12 VDC
V	6 VDC
S	5 VDC
R	3 VDC
1	100 VAC 50/60 Hz
2	200 VAC 50/60 Hz
3	110 VAC 50/60 Hz [115 VAC 50/60 Hz]
4	220 VAC 50/60 Hz [230 VAC 50/60 Hz]

* For type W□, only DC voltage is available.
* CE-compliant: For DC only.

Light/Surge voltage suppressor

Nil	Without light/surge voltage suppressor
S	With surge voltage suppressor
Z	With light/surge voltage suppressor
R	With surge voltage suppressor (Non-polar type)
U	With light/surge voltage suppressor (Non-polar type)

* For AC voltage valves there is no "S" option. It is already built into the rectifier circuit.

* For "R" and "U", only DC voltage is available.

* Power saving circuit is only available for the "Z" type.

Electrical entry

G	Grommet, 300 mm lead wire
H	Grommet, 600 mm lead wire
L	With lead wire
LN	Without lead wire
LO	Without connector
M	With lead wire
MN	M plug connector
MO	Without connector
WO	M8 Without connector cable
W□	connector With connector cable ^(Note 1)

* For connector cable of M8 connector, refer to page 646.

Note 1) Enter the cable length symbols in □. Please be sure to fill in the blank referring to page 646.

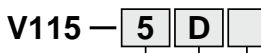

Light/Surge voltage suppressor

Nil	Without light/surge voltage suppressor
S	With surge voltage suppressor (Non-polar type)
Z	With light/surge voltage suppressor (Non-polar type)

* DOZ and YOZ are not available.

* For AC voltage valves there is no "S" option. It is already built into the rectifier circuit.

Electrical entry

D	DIN terminal	With connector
DO	(Type D)	Without connector
Y	DIN terminal	With connector
YO	(Type Y)	Without connector

* Do not replace V111 (G, H, L, M, W) with V115 (DIN terminal) and vice versa when replacing pilot valve assembly only.

Rated voltage

5	24 VDC
6	12 VDC
1	100 VAC 50/60 Hz
2	200 VAC 50/60 Hz
3	110 VAC 50/60 Hz [115 VAC 50/60 Hz]
4	220 VAC 50/60 Hz [230 VAC 50/60 Hz]

* DC specifications of type D and DO are only available with 12 and 24 VDC.

* Power saving circuit is not available for D or DO types.

Note) Since V111 and V115 are CE-compliant as standard, the suffix "-Q" is not necessary.

Body Ported

* [] for AC

Grommet (G), (H): 10-SYJ5□2M-□^G_H□□-M5

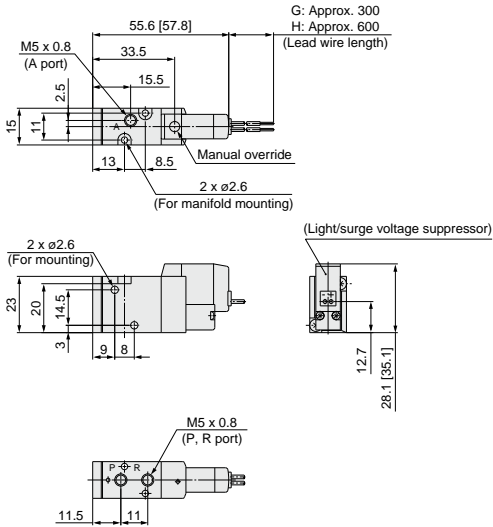

With bracket:
10-SYJ5□2M-□^G_H□□-M5-F

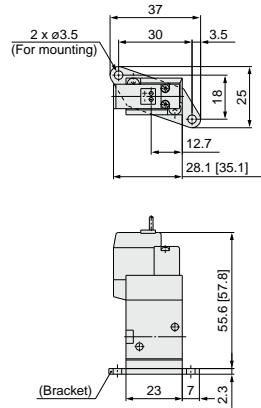

L plug connector (L):
10-SYJ5□2M-□L□□-M5 (-F)

M plug connector (M):
10-SYJ5□2M-□M□□-M5 (-F)

DIN terminal (D,Y):
10-SYJ5□2M-□D□□-M5 (-F)

M8 connector (WO):
10-SYJ5□2M-□WO□□-M5 (-F)

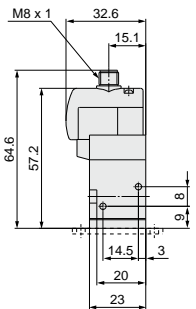
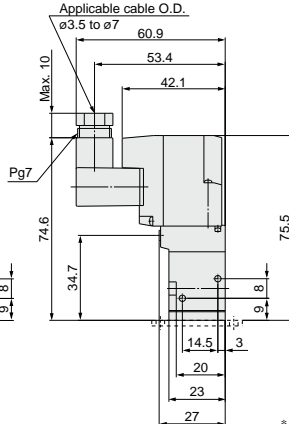
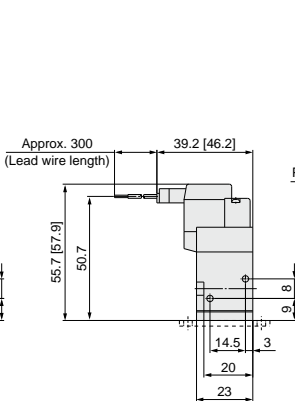
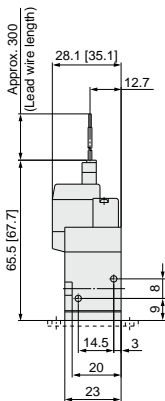

* Refer to page 646 for dimensions with connector cable.

Directional Control Valves

Air Cylinders

Rotary Actuators

Air Grippers

Air Preparation Equipment

Modular F. R.

Pressure Control Equipment

Fittings & Tubing

Flow Control Equipment

Pressure Switches/ Pressure Sensors

Base Mounted (With Sub-plate)

* [] for AC

Grommet (G), (H): 10-SYJ5□4M-□^G□□-01□

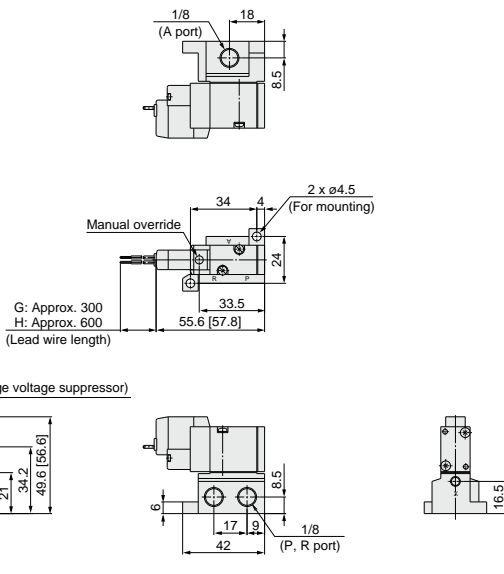

L plug connector (L):
10-SYJ5□4M-□□□-01□

M plug connector (M):
10-SYJ5□4M-□M□□-01□

DIN terminal (D, Y):
10-SYJ5□4M-□_Y□□-01□

M8 connector (WO):
10-SYJ5□4M-□WO□□-01□

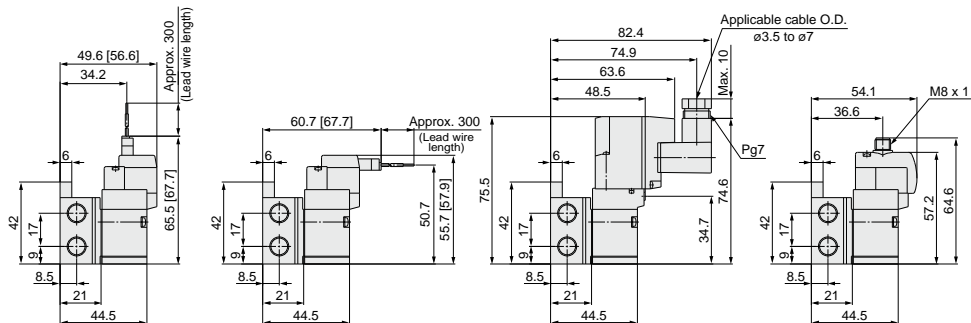

* Refer to page 646 for dimensions with connector cable.

Combinations of Solenoid Valve, Manifold Gasket and Manifold Base

Body ported (Type 10-SYJ5□2M(-Q))

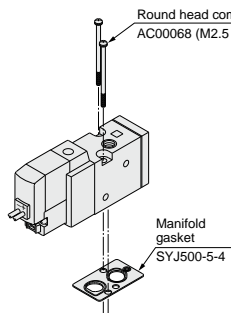

Applicable base
Type 10-SS3YJ5-20(-Q)
Manifold base

Base mounted (Type 10-SYJ5□4M(-Q))

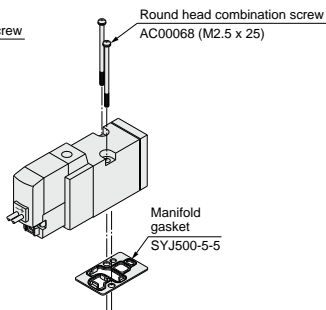

Applicable base Sub-plate
Type 10-SS3YJ5-40(-Q) } Manifold
Type 10-SS3YJ5-41(-Q) } base

Blanking Plate Assembly

Part no.: SYJ500-10-3A(-Q)

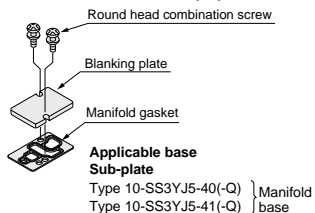

Applicable base Sub-plate
Type 10-SS3YJ5-40(-Q) } Manifold
Type 10-SS3YJ5-41(-Q) } base

Part no.: SYJ500-10-1A(-Q)

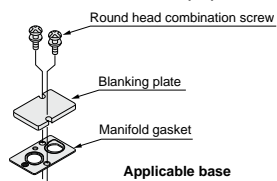

Applicable base
Type 10-SS3YJ5-20(-Q)

⚠ Caution

Mounting screw tightening torque

M2.5: 0.45 N·m

Use caution to the assembly orientation for solenoid valves (blanking plate) and manifold gasket.

(Note) Add suffix "-Q" for the CE-compliant product.



Note) AC-type models that are CE-compliant have DIN terminals only. [Option]

Manifold for Internal Pilot Type

Type 20

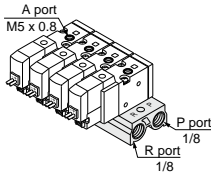

How to Order

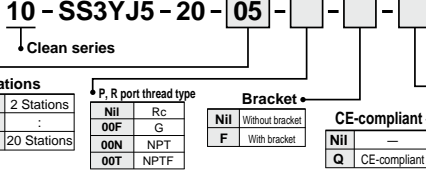

Applicable solenoid valve
10-SYJ512M-□□□□-M5(-Q)
10-SYJ522M-□□□□-M5(-Q)

Applicable blanking plate assembly
Refer to page 621.

Note) For more than 6 stations, supply air to both sides of P port and exhaust air from both sides of R port.

Type 40

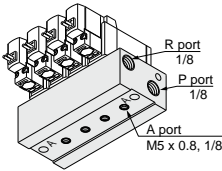

How to Order

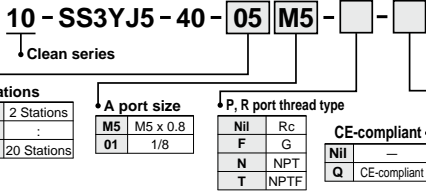

Applicable solenoid valve
10-SYJ514M-□□□□(-Q)
10-SYJ524M-□□□□(-Q)

Applicable blanking plate assembly
Refer to page 621.

Note) For more than 9 stations, supply air to both sides of P port and exhaust air from both sides of R port.

Type 41

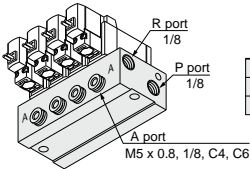

How to Order

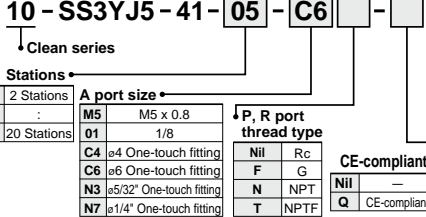

Applicable solenoid valve
10-SYJ514M-□□□□(-Q)
10-SYJ524M-□□□□(-Q)

Applicable blanking plate assembly
Refer to page 621.

Note) For more than 9 stations, supply air to both sides of P port and exhaust air from both sides of R port.

Directional Control Valves

Air Cylinders

Rotary Actuators

Air Grippers

Air Preparation Equipment

Modular F. R.

Pressure Control Equipment

Fittings & Tubing

Flow Control Equipment

Pressure Switches/ Pressure Sensors

Type 20 Manifold: Top Ported/10-SS3YJ5-20-Stations -00 □ (-F)

* [] for AC

Grommet (G)

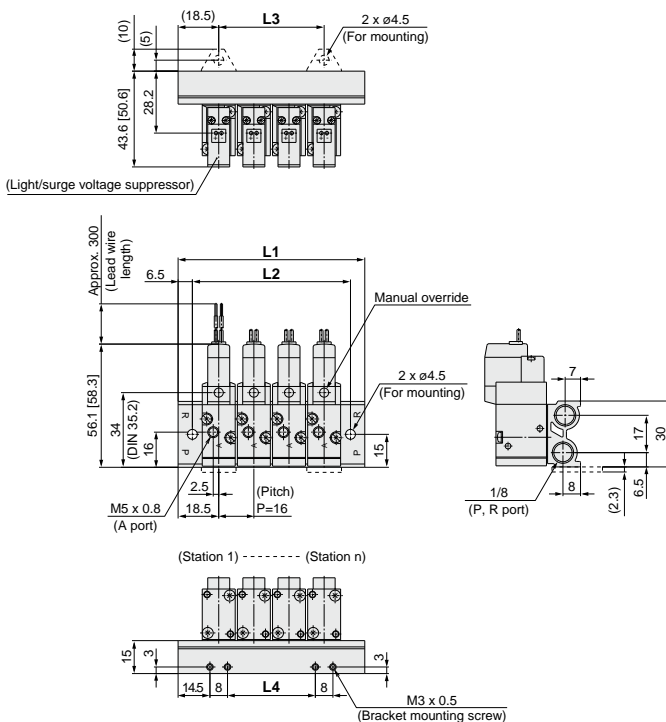

L plug connector (L)

M plug connector (M)

DIN terminal (D, Y)

M8 connector (WO)

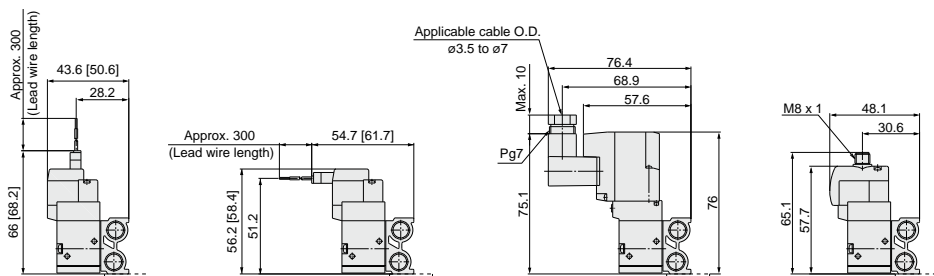

* Refer to page 646 for dimensions with connector cable.

Station	Station 2	3	4	5	6	7	8	9	10	11	12	13	14	15	16	17	18	19	Station 20
L1	53	69	85	101	117	133	149	165	181	197	213	229	245	261	277	293	309	325	341
L2	40	56	72	88	104	120	136	152	168	184	200	216	232	248	264	280	296	312	328
L3	16	32	48	64	80	96	112	128	144	160	176	192	208	224	240	256	272	288	304
L4	8	24	40	56	72	88	104	120	136	152	168	184	200	216	232	248	264	280	296

Type 40 Manifold: Bottom Ported/10-SS3YJ5-40-**Stations**-M5, 01□

* [] for AC

Grommet (G)

For 1/8

For M5

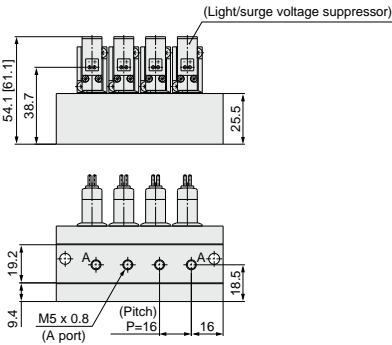
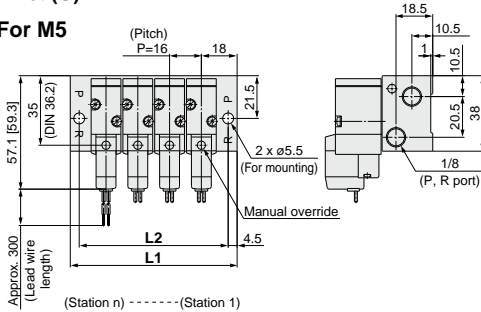

For 1/8

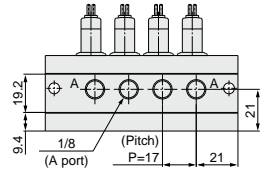
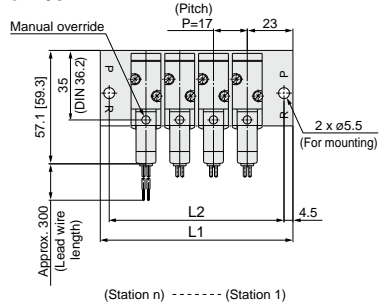

L plug connector (L)

M plug connector (M)

DIN terminal (D, Y)

M8 connector (WO)

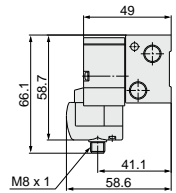
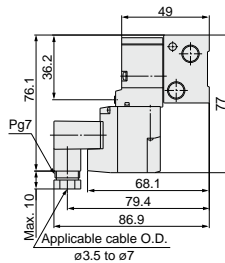
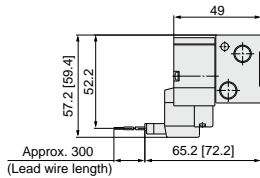
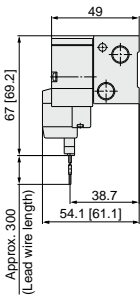

* Refer to page 646 for dimensions with connector cable.

Port size	Station	Station 2	3	4	5	6	7	8	9	10	11	12	13	14	15	16	17	18	19	Station 20
M5	L1	52	68	84	100	116	132	148	164	180	196	212	228	244	260	276	292	308	324	340
	L2	43	59	75	91	107	123	139	155	171	187	203	219	235	251	267	283	299	315	331
1/8	L1	63	80	97	114	131	148	165	182	199	216	233	250	267	284	301	318	335	352	369
	L2	54	71	88	105	122	139	156	173	190	207	224	241	258	275	292	309	326	343	360

Directional Control Valves
 Air Cylinders
 Rotary Actuators
 Air Grippers
 Air Preparation Equipment
 Modular F. R.
 Pressure Control Equipment
 Fittings & Tubing
 Flow Control Equipment
 Pressure Switches/ Pressure Sensors

Type 41 Manifold: Side Ported/10-SS3YJ5-41-Stations C4, N3
 C6, N7

* [] for AC

Grommet (G)

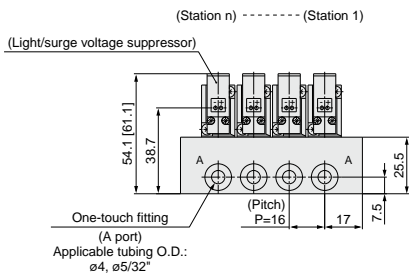
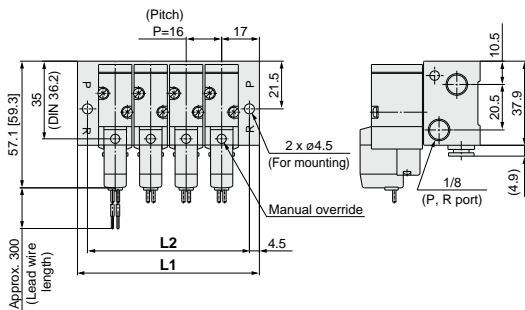

L plug connector (L)

M plug connector (M)

DIN terminal (D, Y)

M8 connector (WO)

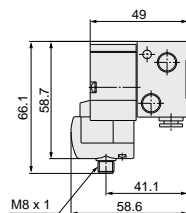
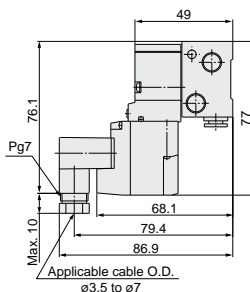
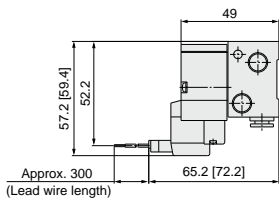
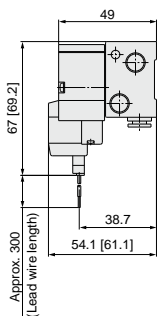

* Refer to page 646 for dimensions with connector cable.

Port size	Station	Station 2	3	4	5	6	7	8	9	10	11	12	13	14	15	16	17	18	19	Station 20
One-touch fitting	L1	50	66	82	98	114	130	146	162	178	194	210	226	242	258	274	290	306	322	338
	L2	41	57	73	89	105	121	137	153	169	185	201	217	233	249	265	281	297	313	329

Type 41 Manifold: Side Ported/10-SS3YJ5-41- Stations -M5, 01 □

* [] for AC

Grommet (G)
For M5

For 1/8

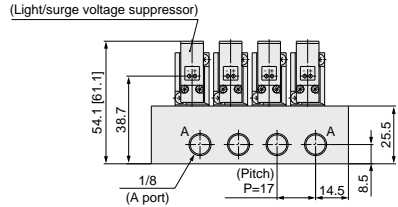
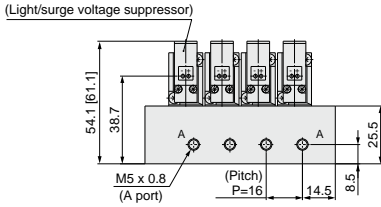
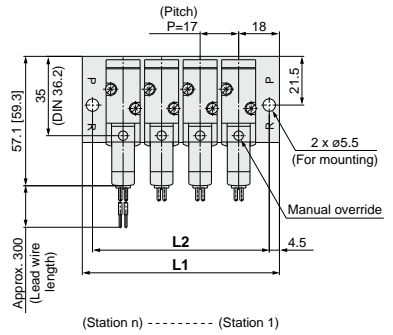
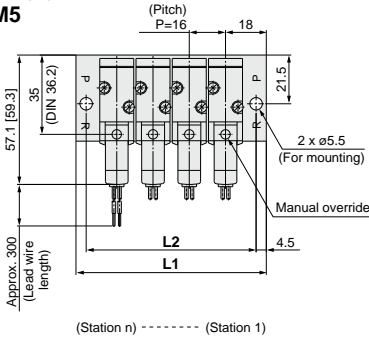

Port size	Station	Station 2	3	4	5	6	7	8	9	10	11	12	13	14	15	16	17	18	19	Station 20
		M5	L1	52	68	84	100	116	132	148	164	180	196	212	228	244	260	276	292	308
	L2	43	59	75	91	107	123	139	155	171	187	203	219	235	251	267	283	299	315	331
1/8	L1	53	70	87	104	121	138	155	172	189	206	223	240	257	274	291	308	325	342	359
	L2	44	61	78	95	112	129	146	163	180	197	214	231	248	265	282	299	316	333	350

Directional Control Valves

Air Cylinders

Rotary Actuators

Air Grippers

Air Preparation Equipment

Modular F. R.

Pressure Control Equipment

Fittings & Tubing

Flow Control Equipment

Pressure Switches/ Pressure Sensors

Series 10-SYJ700

Rubber Seal
3 Port Pilot Solenoid Valve



Specifications

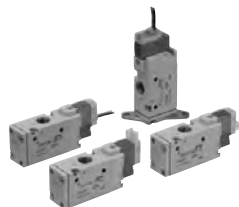

Body ported

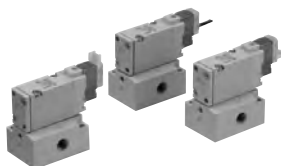

Base mounted

Fluid		Air
Operating pressure range (MPa)	Internal pilot	0.15 to 0.7
Ambient and fluid temperature (°C)		-10 to 50 (No freezing.)
Response time ms (at 0.5 MPa) ^{Note 1)}		30 or less
Max. operating frequency (Hz)		5
Manual override (Manual operation)		Non-locking push type, push-turn locking slotted type, push-turn locking lever type
Pilot exhaust method		Main/Pilot valve common exhaust
Lubrication		Not required
Mounting orientation		Unrestricted
Impact/Vibration resistance (m/s²) ^{Note 2)}		150/30
Enclosure		Dust proof (* DIN terminal, M8 connector: IP65)

* Based on IEC60529

Note 1) Based on dynamic performance test, JIS B 8374-1981. (Coil temperature: 20°C, at rated voltage, without surge voltage suppressor.)

Note 2) Impact resistance: No malfunction occurred when it was tested in the axial direction and at right angles to the main valve and armature in both energized and de-energized states once for each condition. (Default settings)

Vibration resistance: No malfunction occurred in a one-sweep test between 45 and 2000 Hz. Test was performed in both energized and de-energized states in the axial direction and at right angles to the main valve and armature. (Default settings)

Symbol

Internal pilot

10-SYJ71²M

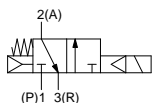

10-SYJ72²M

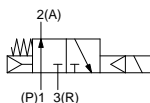

Made to Order

(For details, refer to page 640.)

Solenoid Specifications

Electrical entry		Grommet (G), (H), L plug connector (L), M plug connector (M), DIN terminal (D), (Y), M8 connector (W)	
		G, H, L, M, W	D, Y
Coil rated voltage (V)	DC	24, 12, 6, 5, 3	
	AC ^{50/60} Hz	100, 110, 200, 220	
Allowable voltage fluctuation		±10% of rated voltage *	
Power consumption (W)	DC	Standard 0.35 (With light: 0.4 (DIN terminal with light: 0.45)) With power saving circuit 0.1 (With light only) * [Starting 0.4, Holding 0.1]	
	AC	100 V	0.78 (With light: 0.81) 0.78 (With light: 0.87)
Apparent power (VA) *		110 V	0.86 (With light: 0.89) 0.86 (With light: 0.97)
		[115 V]	[0.94 (With light: 0.97)] [0.94 (With light: 1.07)]
		200 V	1.18 (With light: 1.22) 1.15 (With light: 1.30)
		220 V	1.30 (With light: 1.34) 1.27 (With light: 1.46)
		[230 V]	[1.42 (With light: 1.46)] [1.39 (With light: 1.60)]
Surge voltage suppressor		Diode (DIN terminal, varistor when non-polar types)	
Indicator light		LED (Neon light when AC with DIN terminal)	

* Common between 110 VAC and 115 VAC, and between 220 VAC and 230 VAC.

* For 115 VAC and 230 VAC, the allowable voltage is -15% to +5% of rated voltage.

* For details, refer to page 643.

Flow Rate Characteristics/Weight

Valve model	Type of actuation	Port size	Flow rate characteristics						Weight (g) ^{Note)}			
			1→2 (P→A)			2→3 (A→R)			Grommet	L/M plug connector	DIN terminal	M8 connector
			C [dm ³ /(s·bar)]	b	Cv	C [dm ³ /(s·bar)]	b	Cv				
Body ported	10-SYJ712M	N.C.	2.8	0.43	0.77	2.5	0.51	0.76	75	76	97	80
			2.7	0.38	0.72	2.4	0.42	0.69				
			2.9	0.32	0.71	2.7	0.34	0.69				
Base mounted (with sub-plate)	10-SYJ714M	N.C.	2.8	0.21	0.70	2.3	0.45	0.63	135 (75)	136 (76)	157 (97)	140 (80)
			3.0	0.31	0.74	2.6	0.33	0.66				
			2.7	0.31	0.68	2.3	0.48	0.64				

Note) Value for DC. Add 3 g for AC. (): Without sub-plate.

Note) AC-type models that are CE-compliant have DIN terminals only. [Option]



How to Order

Rated voltage

DC	
5	24 VDC
6	12 VDC
V	6 VDC
S	5 VDC
R	3 VDC

* DC specifications of type D, Y, DO and YO are only available with 12 and 24 VDC.

AC (50/60 Hz)

1	100 VAC
2	200 VAC
3	110 VAC [115 VAC]
4	220 VAC [230 VAC]

* For type W□, only DC voltage is available.
Note) AC-type models that are CE-compliant have DIN terminals only.

Light/Surge voltage suppressor

Nil	Without light/surge voltage suppressor
S	With surge voltage suppressor
Z	With light/surge voltage suppressor
R	With surge voltage suppressor (Non-polar type)
U	With light/surge voltage suppressor (Non-polar type)

* For AC voltage valves there is no "S" option. It is already built into the rectifier circuit.
* For type "R" and "U", only DC voltage is available.
* Power saving circuit is only available for the "Z" type.

Electrical entry for D, Y

Nil	Without light/surge voltage suppressor
S	With surge voltage suppressor (Non-polar type)
Z	With light/surge voltage suppressor (Non-polar type)

* DO2 and YO2 are not available.
* For AC voltage valves there is no "S" option. It is already built into the rectifier circuit.

Actuation type

1	Normally closed
2	Normally open

3 port

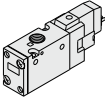

(For type 20 manifold)

Thread type

Nil	Rc
F	G
N	NPT
T	NPTF

Bracket

Nil	Without bracket
F	With bracket

* Bracket is not mounted.

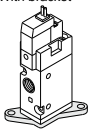

Body option

M: Main/Pilot valve common exhaust type

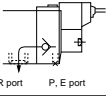

R, port P, E port

Body ported

10-SYJ7 1 2 M □ - 5 M □ - 01 □ - □ - □

Base mounted

10-SYJ7 1 4 M □ - 5 M □ - 01 □ - □ - □

Clean series

Coil type

Nil	Standard
T	With power saving circuit (24, 12 VDC only)

* Power saving circuit is not available for D, Y, DO, YO or W□ types.

Manual override

Nil: Non-locking push type



D: Push-turn locking slotted type



E: Push-turn locking lever type



Thread type

Nil	Rc
F	G
N	NPT
T	NPTF

Body option

M: Main/Pilot valve common exhaust type

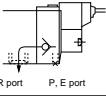

R, port P, E port

Port size

Nil: Without sub-plate

01: 1/8 port With sub-plate

02: 1/4 port With sub-plate

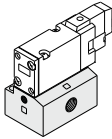
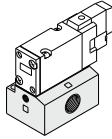
(With gasket and screws)

Electrical entry

CE-compliant	24, 12, 6, 5, 3 VDC/100, 110, 200, 220 VAC				24, 12 VDC/100, 110, 200, 220 VAC		24, 12, 6, 5, 3 VDC	
	Grommet	L plug connector	M plug connector	DIN terminal	M8 connector	M8 connector	M8 connector	
	G: Lead wire length 300 mm	L: With lead wire (Length 300 mm)	M: With lead wire (Length 300 mm)	MN: Without lead wire	D: With connector	Y: With connector	WO: Without connector cable	
	H: Lead wire length 600 mm	LN: Without lead wire	MO: Without connector	DO: Without connector	YO: Without connector	WI: With connector cable (Note 1)		
		LO: Without connector						

Note) When placing an order for body ported solenoid valves as a single unit, the mounting screws for the manifold and gasket are not attached. Order them separately, if necessary. (For details, refer to page 633.)

* LN, MN type: With 2 sockets.
* Refer to page 642 for the lead wire length of L and M plug connectors.
* Refer to page 645 for the connector assembly with cover for L and M plug connectors.

* DIN terminal type "Y" which conforms to EN-175301-803C (former DIN4365C) is also available. For details, refer to page 644.
* For connector cable of M8 connector, refer to page 646.
* M8 connector conforming to IEC60947-5-2 is also available. Refer to page 640 for details.
Note 1) Enter the cable length symbols in □. Please be sure to fill in the blank referring to page 646.

Directional Control Valves
 Air Cylinders
 Rotary Actuators
 Air Grippers
 Air Preparation Equipment
 Modular F. R.
 Pressure Control Equipment
 Fittings & Tubing
 Flow Control Equipment
 Pressure Switches/ Pressure Sensors

Construction

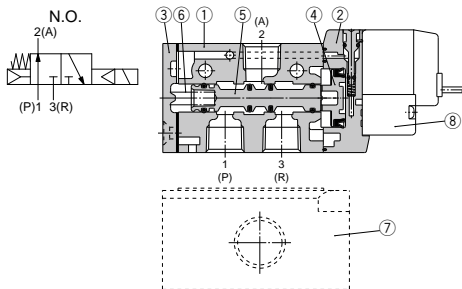
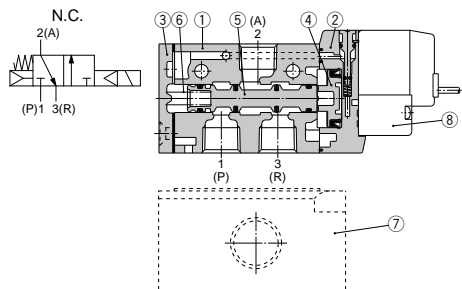

Component Parts

No.	Description	Material	Note
1	Body	Aluminum die-casted	White
2	Piston plate	Resin	White
3	End cover	Aluminum die-casted	White
4	Piston	Resin	—
5	Spool valve assembly	—	—
6	Spool spring	Stainless steel	—

Replacement Parts

No.	Description	Part no.	Note
7	Sub-plate ^(Note)	SYJ700-9-1(-Q)	1/8 Aluminum die-casted
		SYJ700-9-2(-Q)	1/4 Aluminum die-casted
8	Pilot valve	V111(T)-□□□□	
—	Bracket assembly	SYJ700-19-1A	

Note) Add suffix "-Q" for the CE-compliant product.

How to Order Pilot Valve Assembly

V111 □ — 5 G □

Coil type

Nll	Standard
T	With power saving circuit (24, 12 VDC only)

* Power saving circuit is not available for W□ type.

Rated voltage

5	24 VDC
6	12 VDC
V	6 VDC
S	5 VDC
R	3 VDC
1	100 VAC 50/60 Hz
2	200 VAC 50/60 Hz
3	110 VAC 50/60 Hz [115 VAC 50/60 Hz]
4	220 VAC 50/60 Hz [230 VAC 50/60 Hz]

* For type W□, only DC voltage is available.
* CE-compliant: For DC only.

Light/Surge voltage suppressor

Nll	Without light/surge voltage suppressor
S	With surge voltage suppressor
Z	With light/surge voltage suppressor
R	With surge voltage suppressor (Non-polar type)
U	With light/surge voltage suppressor (Non-polar type)

* For AC voltage valves there is no "S" option. It is already built into the rectifier circuit.

* For "R" and "U", only DC voltage is available.

* Power saving circuit is only available for the "Z" type.

Electrical entry

G	Grommet, 300 mm lead wire
H	Grommet, 600 mm lead wire
L	With lead wire
LN	With lead wire
LO	Without lead wire
M	Without connector
M	With lead wire
MN	Without lead wire
MO	Without connector
WO	With connector cable
W□	Without connector cable (Note 1)

* For connector cable of M8 connector, refer to page 646.

Note 1) Enter the cable length symbols in □. Please be sure to fill in the blank referring to page 646.

V115 — 5 D □

Rated voltage

5	24 VDC
6	12 VDC
1	100 VAC 50/60 Hz
2	200 VAC 50/60 Hz
3	110 VAC 50/60 Hz [115 VAC 50/60 Hz]
4	220 VAC 50/60 Hz [230 VAC 50/60 Hz]

* DC specifications of type D and DO are only available with 12 and 24 VDC.

* Power saving circuit is not available for D, Y, DO and YO types.

Light/Surge voltage suppressor

Nll	Without light/surge voltage suppressor
S	With surge voltage suppressor (Non-polar type)
Z	With light/surge voltage suppressor (Non-polar type)

* DOZ and YOZ are not available.

* For AC voltage valves there is no "S" option. It is already built into the rectifier circuit.

Electrical entry

D	DIN terminal	With connector
DO	(Type D)	Without connector
Y	DIN terminal	With connector
YO	(Type Y)	Without connector

* Do not replace V111 (G, H, L, M, W) with V115 (DIN terminal) and vice versa when replacing pilot valve assembly only.

Note) Since V111 and V115 are CE-compliant as standard, the suffix "-Q" is not necessary.

Body Ported

* [] for AC

Grommet (G), (H): 10-SYJ7□2M-□^G□□-01□

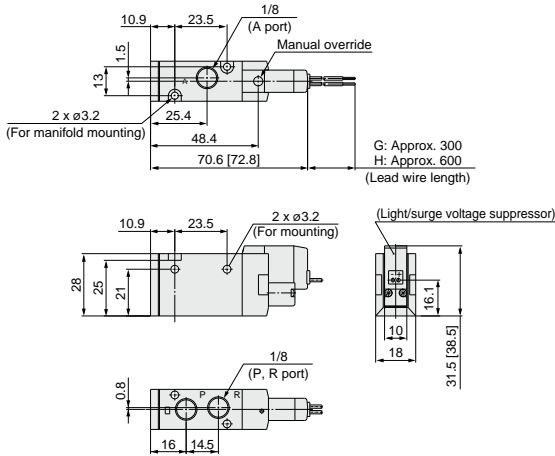

With bracket:
10-SYJ7□2M-□^G□□-01□-F

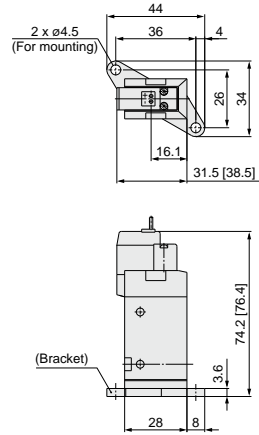

L plug connector (L):
10-SYJ7□2M-□L□□-01□ (-F)

M plug connector (M):
10-SYJ7□2M-□M□□-01□ (-F)

DIN terminal (D, Y):
10-SYJ7□2M-□D□□-01□ (-F)

M8 connector (WO):
10-SYJ7□2M-□WO□□-01□ (-F)

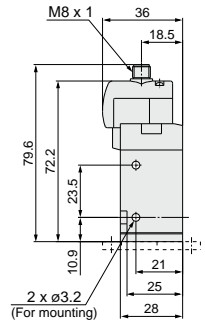
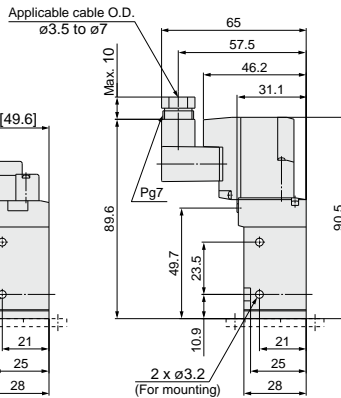
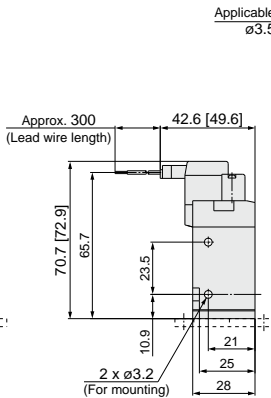
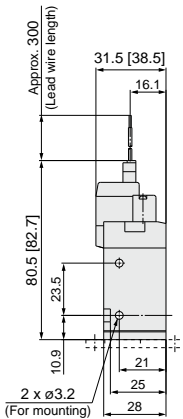

* Refer to page 646 for dimensions with connector cable.

Base Mounted (With Sub-plate)

* [] for AC

Grommet (G), (H): 10-SYJ7□4M-□□□□^G□□□□⁰¹□□⁰²

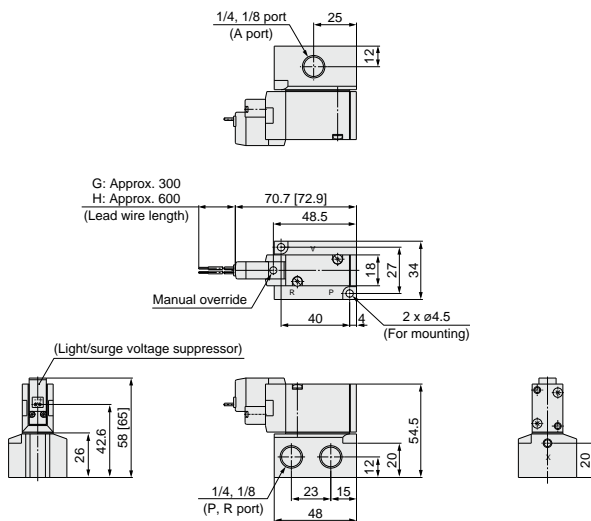

L plug connector (L):
10-SYJ7□4M-□□□□^L□□□□⁰¹□□⁰²

M plug connector (M):
10-SYJ7□4M-□□□□^M□□□□⁰¹□□⁰²

DIN terminal (D, Y):
10-SYJ7□4M-□□□□^D□□□□⁰¹□□⁰²

M8 connector (WO):
10-SYJ7□4M-□□□□^{WO}□□□□⁰¹□□⁰²

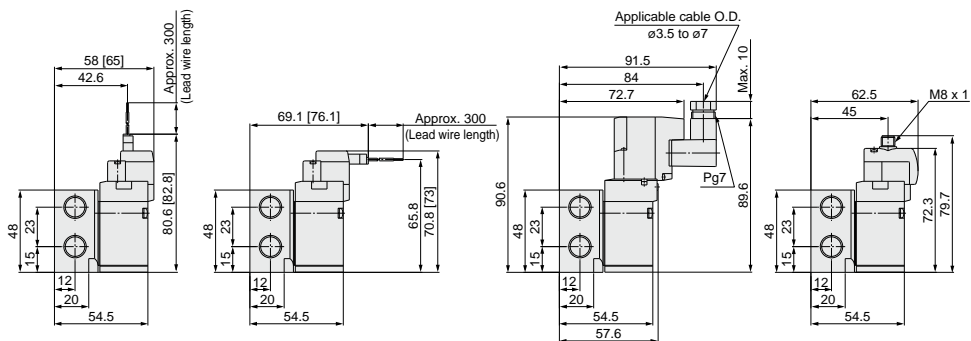

* Refer to page 646 for dimensions with connector cable.

Series 10-SYJ700 Manifold Specifications



Manifold Specifications

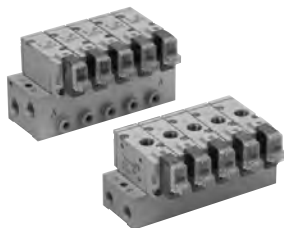

Model	For internal pilot	Type 20	Type 21	Type 40	Type 41	Type 42
Manifold type		Single base/B mount				
P (SUP), R (EXH)		Common SUP, common EXH				
Valve stations		2 to 20 stations				
A port Porting specifications	Location	Valve	Valve	Base	Base	Base
	Direction	Top	Top	Bottom	Bottom	Side
Port size	P, R port	1/8	1/4	1/8	1/4	1/4
	A port	1/8	1/8	1/8	1/8	1/8 C6 (ø8 One-touch fitting) C8 (ø8 One-touch fitting)

Flow Rate Characteristics

Manifold			Port size		Flow rate characteristics					
			1(P), 3(R) port	2(A) port	1→2 (P→A)			2→3 (A→R)		
					C [dm ³ /(sbar)]	b	Cv	C [dm ³ /(sbar)]	b	Cv
Body ported for internal pilot	Type 10-SS3YJ7-20	10-SYJ□2M	1/8	1/8	2.2	0.34	0.55	2.3	0.27	0.59
	Type 10-SS3YJ7-21		1/4	1/8	2.2	0.39	0.59	2.4	0.32	0.62
	Type 10-SS3YJ7-40		1/8	1/8	2.1	0.35	0.59	2.3	0.27	0.54
Base mounted for internal pilot	Type 10-SS3YJ7-41	10-SYJ□4M	1/4	1/8	2.2	0.35	0.59	2.4	0.36	0.66
	Type 10-SS3YJ7-42-01		1/4	1/8	2.0	0.27	0.47	2.2	0.32	0.56
	Type 10-SS3YJ7-42-C6		1/4	C6	1.6	0.32	0.39	2.2	0.27	0.54
	Type 10-SS3YJ7-42-C8		1/4	C8	2.1	0.24	0.51	2.3	0.31	0.59

Note) The values are for individually operated 2 position type manifold bases.

How to Order Manifold (Example)

Instruct by specifying the valves and blanking plate assembly to be mounted on the manifold along with the manifold base model no.

(Example)

10-SS3YJ7-20-03 1 set (manifold base) 10-SS3YJ7-42-03-01 1 set (manifold base)
 * 10-SYJ712M-5LZ-01 2 sets (valve) * 10-SYJ714M-5G 2 sets (valve)
 * SYJ700-10-1A 1 set (blanking plate assembly) * SYJ700-10-2A 1 set (blanking plate assembly)

↳ The asterisk denotes the symbol for assembly. Prefix it to the part no. of the solenoid valve, etc.

Combinations of Solenoid Valve, Manifold Gasket and Manifold Base

Body ported (Type 10-SYJ7□2M(-Q)) Base mounted (Type 10-SYJ7□4M(-Q))

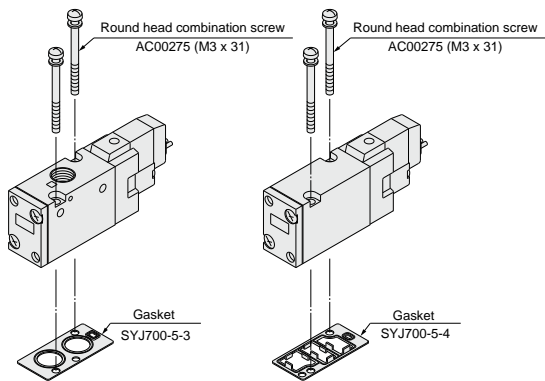

Applicable base
 Type 10-SS3YJ7-20(-Q) } Manifold
 Type 10-SS3YJ7-21(-Q) } base

Applicable base
Sub-plate
 Type 10-SS3YJ7-40(-Q) } Manifold
 Type 10-SS3YJ7-41(-Q) } base
 Type 10-SS3YJ7-42(-Q) }

Caution

Mounting screw tightening torque

M3: 0.8 N-m

Use caution to the assembly orientation for solenoid valves, gasket and optional parts.

Blanking Plate Assembly

<Standard>

Part no.: SYJ700-10-1A

- For body ported
- For base mounted

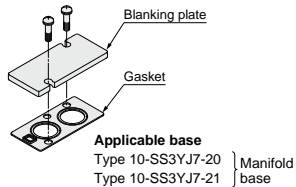

Part no.: SYJ700-10-2A

- For base mounted

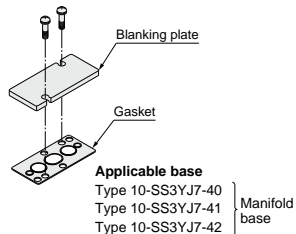

Note) It can be mounted on a body ported manifold base. However, when mounting a blanking part to a valve, place an order for a separate gasket (SYJ700-5-3) when placing an order for the valve.

When using the SYJ700-10-1A, a gasket for this blanking plate assembly can be used as a gasket for the valve as well.

<CE-compliant>

Part no.: SYJ700-10-2A-1-Q

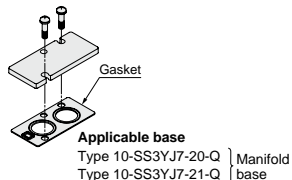

Part no.: SYJ700-10-2A-2-Q

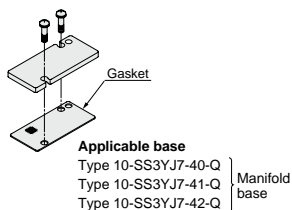

Note) AC-type models that are CE-compliant have DIN terminals only. [Option]



Manifold for Internal Pilot Type

Type 20/Type 21

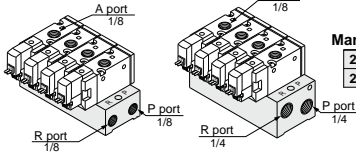

How to Order

10 - SS3YJ7 - 20 - 05 - [] - []

↓ Clean series

Manifold type

20	Type 20
21	Type 21

Stations

02	2 stations
:	:
20	20 stations

P, R port thread type

Nil	Rc
00F	G
00N	NPT
00T	NPTF

CE-compliant

Nil	—
Q	CE-compliant

Applicable solenoid valve
10-SYJ712M-□□□□-01(-Q)
10-SYJ722M-□□□□-01(-Q)

Applicable blanking plate assembly
Refer to page 633.

Note) If there are more than 6 stations for type 20, or more than 9 stations for type 21, supply air to both sides of P port and exhaust air from both sides of R port.

Type 40/Type 41

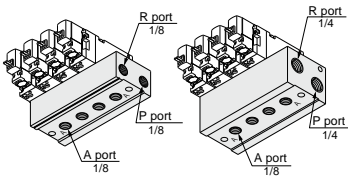

How to Order

10 - SS3YJ7 - 40 - 05 - 01 - [] - []

↓ Clean series

Manifold type

40	Type 40
41	Type 41

A port size

01	1/8
----	-----

Stations

02	2 stations
:	:
20	20 stations

P, R port thread type

Nil	Rc
F	G
N	NPT
T	NPTF

CE-compliant

Nil	—
Q	CE-compliant

Applicable solenoid valve
10-SYJ714M-□□□□(-Q)
10-SYJ724M-□□□□(-Q)

Applicable blanking plate assembly
Refer to page 633.

Note) If there are more than 6 stations for type 40, or more than 9 stations for type 41, supply air to both sides of P port and exhaust air from both sides of R port.

Type 42

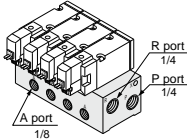

How to Order

10 - SS3YJ7 - 42 - 05 - C6 - [] - []

↓ Clean series

Stations

02	2 stations
:	:
20	20 stations

A port size

01	1/8
----	-----

P, R port thread type

Nil	Rc
F	G
N	NPT
T	NPTF

CE-compliant

Nil	—
Q	CE-compliant

Applicable solenoid valve
10-SYJ714M-□□□□(-Q)
10-SYJ724M-□□□□(-Q)

Applicable blanking plate assembly
Refer to page 633.

Note) For more than 9 stations, supply air to both sides of P port and exhaust air from both sides of R port.

Directional Control Valves

Air Cylinders

Rotary Actuators

Air Grippers

Air Preparation Equipment

Modular F. R.

Pressure Control Equipment

Fittings & Tubing

Flow Control Equipment

Pressure Switches/ Pressure Sensors

Type 20 Manifold: Top Ported/10-SS3YJ7-20-Stations (-00□)

* [] for AC

Grommet (G)

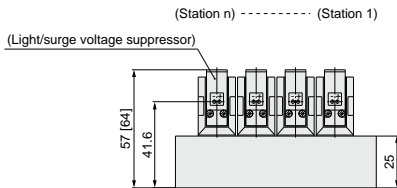
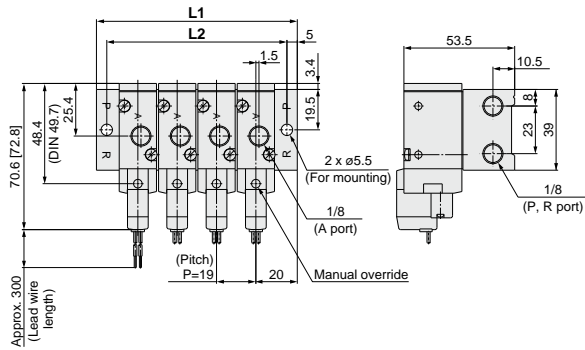

L plug connector (L)

M plug connector (M)

DIN terminal (D, Y)

M8 connector (WO)

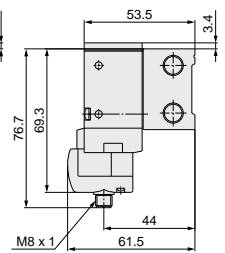
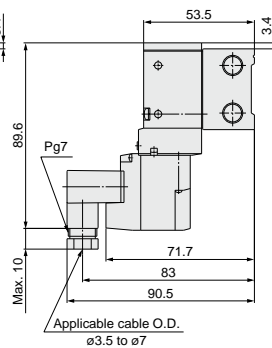
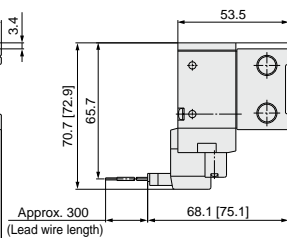
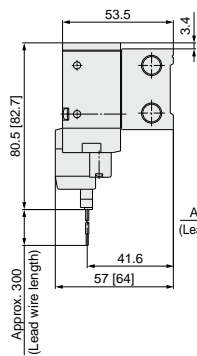

* Refer to page 646 for dimensions with connector cable.

Station	Station 2	3	4	5	6	7	8	9	10	11	12	13	14	15	16	17	18	19	Station 20
L1	59	78	97	116	135	154	173	192	211	230	249	268	287	306	325	344	363	382	401
L2	49	68	87	106	125	144	163	182	201	220	239	258	277	296	315	334	353	372	391

Type 21 Manifold: Top Ported/10-SS3YJ7-21-**Stations** (-00□)

* [] for AC

Grommet (G)

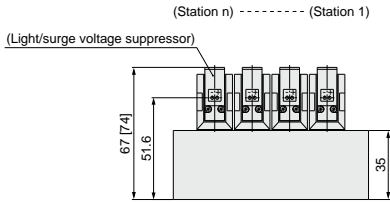
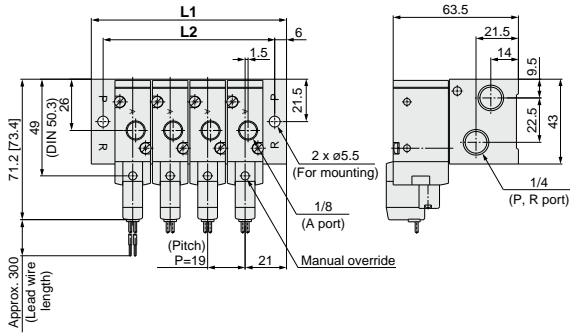

L plug connector (L)

M plug connector (M)

DIN terminal (D, Y)

M8 connector (WO)

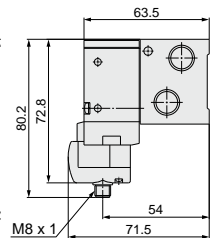
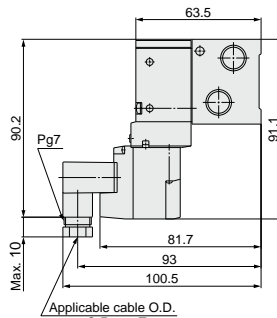
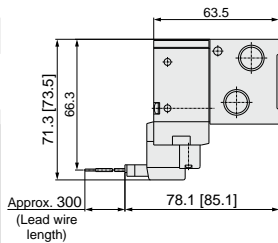
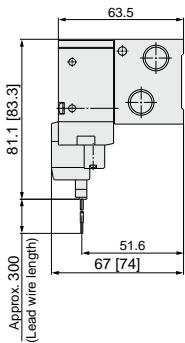

* Refer to page 646 for dimensions with connector cable.

Station	Station 2	3	4	5	6	7	8	9	10	11	12	13	14	15	16	17	18	19	Station 20
L1	61	80	99	118	137	156	175	194	213	232	251	270	289	308	327	346	365	384	403
L2	49	68	87	106	125	144	163	182	201	220	239	258	277	296	315	334	353	372	391

Type 40 Manifold: Bottom Ported/10-SS3YJ7-40-**Stations**-01□

* [] for AC

Grommet (G)

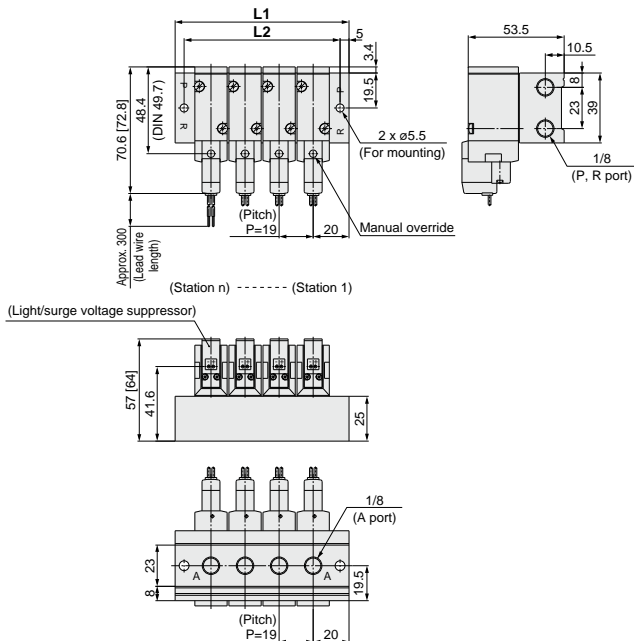

L plug connector (L)

M plug connector (M)

DIN terminal (D, Y)

M8 connector (WO)

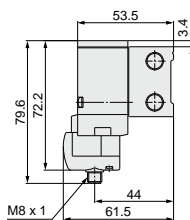
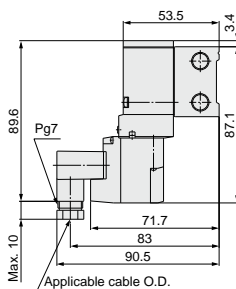
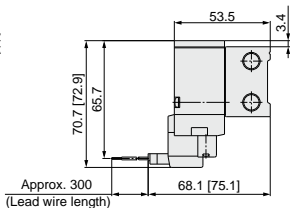
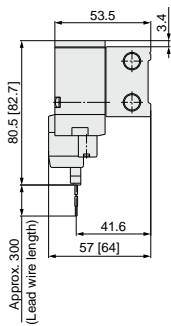

* Refer to page 646 for dimensions with connector cable.

Station	Station 2	3	4	5	6	7	8	9	10	11	12	13	14	15	16	17	18	19	Station 20
L1	59	78	97	116	135	154	173	192	211	230	249	268	287	306	325	344	363	382	401
L2	49	68	87	106	125	144	163	182	201	220	239	258	277	296	315	334	353	372	391

Type 42 Manifold: Side Ported/10-SS3YJ7-42- Stations -01, C6, N7, C8, N9

* [] for AC

Grommet (G)

For C6, N7, C8, N9 (Built-in One-touch fitting)

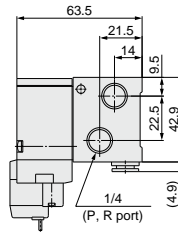
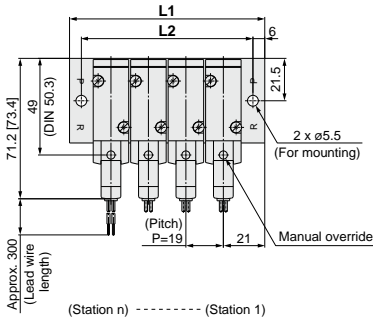

For 1/8

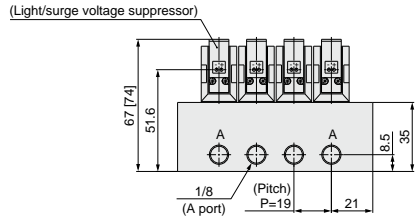
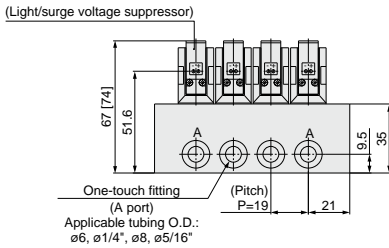

L plug connector (L)

M plug connector (M)

DIN terminal (D, Y)

M8 connector (WO)

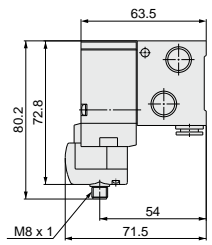
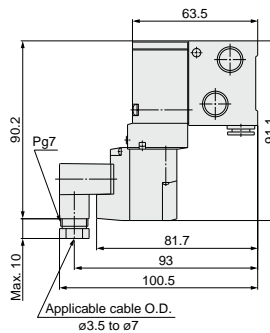
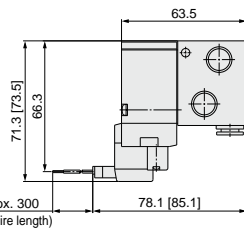
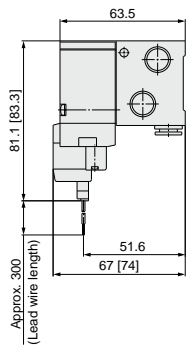

* Refer to page 646 for dimensions with connector cable.

Station	Station 2	3	4	5	6	7	8	9	10	11	12	13	14	15	16	17	18	19	Station 20
L1	61	80	99	118	137	156	175	194	213	232	251	270	289	308	327	346	365	384	403
L2	49	68	87	106	125	144	163	182	201	220	239	258	277	296	315	334	353	372	391

Directional Control Valves
Air Cylinders
Rotary Actuators
Air Grippers
Air Preparation Equipment
Modular F. R.
Pressure Control Equipment
Fittings & Tubing
Flow Control Equipment
Pressure Switches/ Pressure Sensors

Type 41 Manifold: Bottom Ported/10-SS3YJ7-41-Stations-01 □

* [] for AC

Grommet (G)

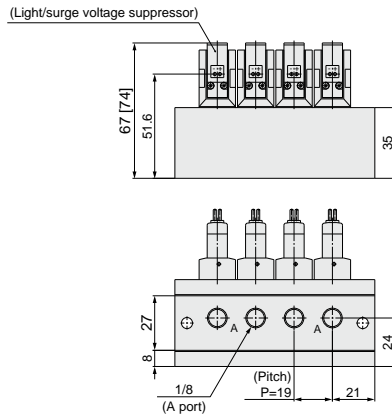

* Other dimensions are the same as type 42.
For dimensions, refer to page 638.

M8 Connector Conforming to IEC60947-5-2

Series 10-SYJ300/500/700

Made to Order



How to Order Valve

Actuation type

1	Normally closed
2	Normally open

Series

3	10-SYJ300
5	10-SYJ500
7	10-SYJ700

Rated voltage DC

5	24 VDC
6	12 VDC
V	6 VDC
S	5 VDC
R	3 VDC

Light/Surge voltage suppressor

Nil	Without light/surge voltage suppressor
S	With surge voltage suppressor
Z	With light/surge voltage suppressor
R	With surge voltage suppressor (Non-polar type)
U	With light/surge voltage suppressor (Non-polar type)

Port size

M5	M5 x 0.8
01	1/8 (10-SYJ700 only)

Bracket

Nil	Without bracket
F	With bracket

Body option

M	Main/Pilot valve common exhaust type
---	--------------------------------------

Electrical entry

WAO: Without connector cable
WA□: With connector cable^{Note}

CE-compliant

Nil	—
Q	CE-compliant

Thread type

Nil	Rc
F	G
N	NPT
T	NPTF

Port size

Nil	Without sub-plate	
M5	M5 port	10-SYJ300
	With sub-plate	10-SYJ500
01	1/8 port	10-SYJ700
	With sub-plate	10-SYJ700
02	1/4 port	10-SYJ700
	With sub-plate	10-SYJ700

Manual override

Nil	Non-locking push type
D	Push-turn locking slotted type
E	Push-turn locking lever type

Body ported
3 port (Type 20, 21 manifold)

Base mounted
3 port (Sub-plate type, type 40, 41, S41, 42, S42 manifold)

Clean series

Ordering Examples:
 Body ported: 10-SYJ 5 1 2 M - 5 WAO □ □ □ □ - M5 - □ - □
 Base mounted: 10-SYJ 5 1 4 M - 5 WAO □ □ □ □ - 01 □ - □

Note: Enter the cable length symbols in □. Please be sure to fill in the blank referring to page 646.

How to Order Pilot Valve Assembly

V111- 5 WAO □ □

Rated voltage DC

5	24 VDC
6	12 VDC
V	6 VDC
S	5 VDC
R	3 VDC

Light/Surge voltage suppressor

Nil	Without light/surge voltage suppressor
S	With surge voltage suppressor
Z	With light/surge voltage suppressor
R	With surge voltage suppressor (Non-polar type)
U	With light/surge voltage suppressor (Non-polar type)

Electrical entry

WAO	M8 connector	Without connector cable
WA□		With connector cable ^{Note}

Note: Enter the cable length symbols in □. Please be sure to fill in the blank referring to page 646.

Note) Since V111 is CE-compliant as standard, the suffix "Q" is not necessary.

Directional Control Valves
 Air Cylinders
 Rotary Actuators
 Air Grippers
 Air Preparation Equipment
 Modular F. R.
 Pressure Control Equipment
 Fittings & Tubing
 Flow Control Equipment
 Pressure Switches/ Pressure Sensors



Series 10-SYJ300/500/700 Specific Product Precautions 1

Be sure to read this before handling.

Refer to page 1382 for Safety Instructions and pages 677 to 683 for 3/4/5 Port Solenoid Valve Precautions.

Manual Override Operation

Warning

When the manual override is operated, connected equipment will be actuated. Confirm safety before operating.

■ Non-locking push type [Standard]

Press in the direction of the arrow.



■ Push-turn slotted locking type [Type D]

While pressing the lock down, turn it in the direction of the arrow. If it does not turn, it can be operated the same way as the non-locking type.



Locked position



Caution

When operating the locking type D with a screw driver, turn it gently using a watchmakers screw driver. [Torque: Less than 0.1 N·m]

■ Push-turn locking lever type [Type E]

While pressing the lever down, turn it in the direction of the arrow. If it does not turn, it can be operated the same way as the non-locking type.



Locked position

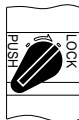

Caution

When locking the manual override on the push-turn locking types (D, E), be sure to push the lock down before turning it. Turning without first pushing it down can cause damage to the manual override and trouble such as air leakage, etc.

Solenoid Valve for 200, 220 VAC Specifications

Warning

Solenoid valves with grommet and L/M type plug connector AC specifications have a built-in rectifier circuit in the pilot section to operate the DC coil.

With 200, 220 VAC specification pilot valves, this built-in rectifier generates heat when energized. The surface may become hot depending on the energization state; therefore, do not touch the solenoid valves.

Main/Pilot Valve Common Exhaust Type

Caution

Pilot air is exhausted through the main valve body rather than directly to atmosphere.

- Suitable for applications where exhausting the pilot valve to atmosphere would be detrimental to the surrounding working environment.
- For use in extremely dirty environments where there is the possibility that dust could enter the pilot exhaust and damage the valve.

Ensure that the piping of exhaust air is not too restrictive.

Bracket

Caution

For bracket attached type of the 10-SYJ300 series, do not use it without bracket.



Series 10-SYJ300/500/700 Specific Product Precautions 2

Be sure to read this before handling.
Refer to page 1382 for Safety Instructions and pages 677 to 683 for 3/4/5 Port Solenoid Valve Precautions.

How to Use Plug Connector

⚠ Caution

1. Attaching and detaching connectors

- To attach a connector, hold the lever and connector unit between your fingers and insert straight onto the pins of the solenoid valve so that the lever's pawl is pushed into the groove and locks.
- To detach a connector, remove the pawl from the groove by pushing the lever downward with your thumb, and pull the connector straight out.

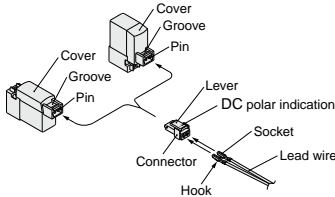

2. Crimping connection of lead wire and socket

Strip 3.2 to 3.7 mm at the end of the lead wires, insert the end of the core wires evenly into the sockets, and then crimp it with a crimping tool. When this is done, take care that the coverings of the lead wires do not enter the core wire crimping area.

Use an exclusive crimping tool for crimping.
(Please contact SMC for the dedicated crimping tools.)

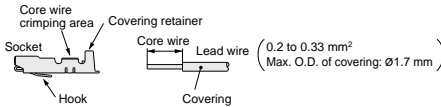

3. Attaching and detaching sockets with lead wires

• Attaching

Insert the sockets into the square holes of the connector (+, - indication), and continue to push the sockets all the way in until they lock by hooking into the seats in the connector. (When they are pushed in, the hooks open and they are locked automatically.) Then confirm that they are locked by pulling lightly on the lead wires.

• Detaching

To detach a socket from a connector, pull out the lead wire while pressing the socket's hook with a thin tipped stick (approx. 1 mm). If the socket is to be used again, first spread the hook outward.

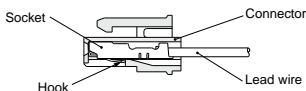

Plug Connector Lead Wire Length

⚠ Caution

Standard length is 300 mm, but the following lengths are also available.

How to Order Connector Assembly

For DC: **SY100-30-4A**

For 100 VAC: **SY100-30-1A**

For 200 VAC: **SY100-30-2A**

For other voltages of AC: **SY100-30-3A**

Without lead wire: **SY100-30-A**
(with connector and 2 of sockets only)

Lead wire length	
Nil	300 mm
6	600 mm
10	1000 mm
15	1500 mm
20	2000 mm
25	2500 mm
30	3000 mm
50	5000 mm

How to Order

Include the connector assembly part number together with the part number for the plug connector's solenoid valve without connector.

Example) Lead wire length 2000 mm

For DC

10-SYJ312-5LO-M3
SY100-30-4A-20

For AC

10-SYJ312-1LO-M3
SY100-30-1A-20

Directional Control Valves

Air Cylinders

Rotary Actuators

Air Grippers

Air Preparation Equipment

Modular F. R.

Pressure Control Equipment

Fittings & Tubing

Flow Control Equipment

Pressure Switches/ Pressure Sensors



Series 10-SYJ300/500/700 Specific Product Precautions 3

Be sure to read this before handling.
Refer to page 1382 for Safety Instructions and pages 677 to 683 for 3/4/5 Port Solenoid Valve Precautions.

Surge Voltage Suppressor

Caution

<For DC>
Grommet, L/M Plug Connector



■ Polar type (Standard)

With surge voltage suppressor (□S)

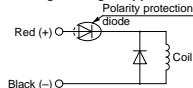

With light/surge voltage suppressor (□Z)

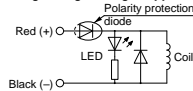

■ Non-polar type

With surge voltage suppressor (□R)

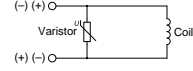

With light/surge voltage suppressor (□U)

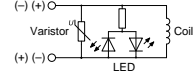

- Connect the polar type in accordance with the +, - polarity indication. (The non-polar type can be used with the connections made either way.)
- Since voltage specifications other than polar type 24 and 12 VDC do not have diodes for polarity protection, be careful not to make errors in the polarity.
- When wiring is done at the factory, positive (+) is red and negative (-) is black.

■ With power saving circuit

Power consumption is decreased by 1/4 by reducing the wattage required to hold the valve in an energized state. (Effective energizing time is over 62 ms at 24 VDC.)

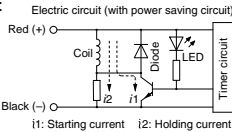

Operating Principle

With the above circuit, the current consumption when holding is reduced to save energy. Please refer to the electric wave data to the right.
• Please be careful not to reverse the polarity, since a diode to prevent the reversed current is not provided for the power saving circuit.

(The electric wave form of the energy saving SVJ□□□□)

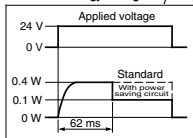

DIN Terminal



With surge voltage suppressor (DS)

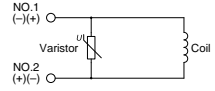

With light/surge voltage suppressor (DZ)

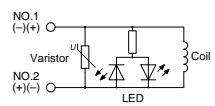

DIN terminal has no polarity.

M8 Connector

■ Polar type (Standard)

With surge voltage suppressor (□S)

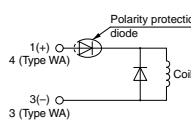

With light/surge voltage suppressor (□Z)

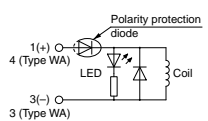

■ Non-polar type

With surge voltage suppressor (□R)

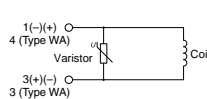

With light/surge voltage suppressor (□U)

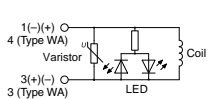

Solenoid valve side pin wiring diagram

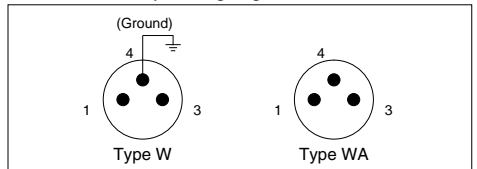

- For wiring of the polar type, connect + to 1 and - to 3 for type W, and + to 4 and - to 3 for type WA.
- Please be careful not to reverse the polarity, since a diode to prevent the reversed current is not provided for DC voltages other than 24 and 12 VDC.
- The WA-type valve cannot be grounded.



Series 10-SYJ300/500/700 Specific Product Precautions 4

Be sure to read this before handling.
Refer to page 1382 for Safety Instructions and pages 677 to 683 for 3/4/5 Port Solenoid Valve Precautions.

Surge Voltage Suppressor

<For AC>
(There is no "S" option, because the generation of surge voltage is prevented by a rectifier.)

Caution

Grommet, L/M Plug Connector

With light (□Z)

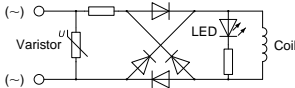

DIN Terminal

With light (DZ)

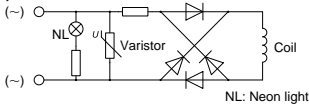

NL: Neon light

Note) The surge voltage suppressor of the varistor has residual voltage corresponding to the protective element and rated voltage. Therefore, protect the controller side from the surge voltage. The residual voltage of the diode is approximately 1 V.

DIN Terminal Type Y

DIN connector type Y is a DIN connector that conforms to the DIN pitch 8-mm standard.

Caution

- Since a type D DIN connector has a 9.4-mm pitch between DIN terminals, it is not interchangeable.
- Type D DIN connectors have the "N" indication at the end of rated voltage symbol. (For DIN connectors without lights, "N" is not indicated. Please refer to the name plate to distinguish models.)
- Dimensions are the same as type D DIN connector.
- When replacing only the pilot valve assembly, V115-□D is interchangeable with V115-□Y. Do not replace V111 (G, H, L, M, W) with V115-□Y (DIN terminal), and vice versa.

How to Use DIN Terminal

Caution Connection

1. Loosen the holding screw and pull the connector out of the solenoid valve terminal block.
2. After removing the holding screw, insert a flat head screwdriver, or similar object into the notch on the bottom of the terminal block and pry it open, separating the terminal block and the housing.
3. Loosen the terminal screws (slotted screws) on the terminal block, insert the cores of the lead wires into the terminals according to the connection method, and fasten them securely with the terminal screws.

How to Use DIN Terminal

Caution

4. Secure the cord by fastening the ground nut.

Caution

When making connections, take note that using other than the supported size ($\phi 3.5$ to $\phi 7$) heavy duty cord will not satisfy IP65 (enclosure) standards. Also, be sure to tighten the ground nut and holding screw within their specified torque ranges.

Changing the entry direction

After separating the terminal block and housing, the cord entry can be changed by attaching the housing in the desired direction (4 directions at 90° intervals).

* If equipped with a light, be careful not to damage the light with the cord's lead wires.

Precautions

Plug in and pull out the connector vertically without tilting to one side.

Compatible cables

Cord O.D.: $\phi 3.5$ to $\phi 7$

(Reference) 0.5 mm², 2-core or 3-core, equivalent to JIS C 3306

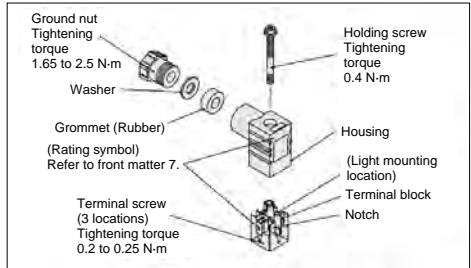

Solenoid Valve Mounting

Caution

Mount so that there is no slippage or deformation in gaskets, and tighten with the tightening torque as shown below.

Model	Thread size	Tightening torque
10-SYJ300	M1.7	0.12 N·m
10-SYJ500	M2.5	0.45 N·m
10-SYJ700	M3	0.8 N·m



Series 10-SYJ300/500/700 Specific Product Precautions 5

Be sure to read this before handling.

Refer to page 1382 for Safety Instructions and pages 677 to 683 for 3/4/5 Port Solenoid Valve Precautions.

DIN Connector Part No.

⚠ Caution

<Type D>

Without light	SY100-61-1
---------------	------------

With light

Rated voltage	Voltage symbol	Part no.
24 VDC	24 V	SY100-61-3-05
12 VDC	12 V	SY100-61-3-06
100 VAC	100 V	SY100-61-2-01
200 VAC	200 V	SY100-61-2-02
110 VAC	110 V	SY100-61-2-03
220 VAC	220 V	SY100-61-2-04

<Type Y>

Without light	SY100-82-1
---------------	------------

With light

Rated voltage	Voltage symbol	Part no.
24 VDC	24 VN	SY100-82-3-05
12 VDC	12 VN	SY100-82-3-06
100 VAC	100 VN	SY100-82-2-01
200 VAC	200 VN	SY100-82-2-02
110 VAC (115 VAC)	110 VN	SY100-82-2-03
220 VAC (230 VAC)	220 VN	SY100-82-2-04

Circuit Diagram with Light

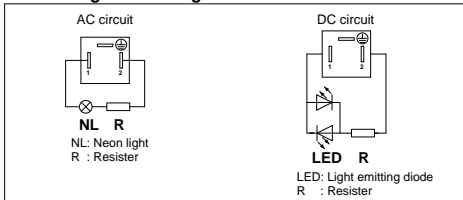

Connector Assembly with Cover

⚠ Caution

Connector assembly with dust proof protective cover.

- Effective to prevention of short circuit failure due to the entry of foreign matter into the connector.
- Chloroprene rubber for electrical use, which provides outstanding weather resistance and electrical insulation, is used for the cover material. However, do not allow contact with cutting oil, etc.
- Simple and unencumbered appearance by adopting round-shaped cord.

How to Order

SY100-68-A-

Lead wire length

Nil	300 mm
6	600 mm
10	1000 mm
15	1500 mm
20	2000 mm
25	2500 mm
30	3000 mm
50	5000 mm

Connector Assembly with Cover: Dimensions

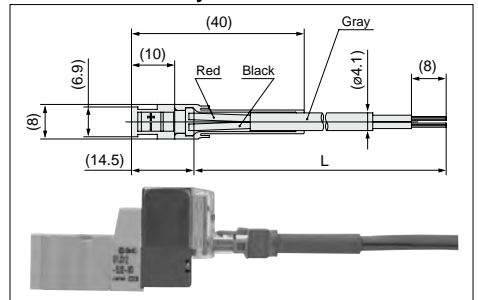

How to Order

Enter the part number for a plug connector solenoid valve without connector together with the part number for a connector assembly with cover.

Example 1) Lead wire length of 2000 mm
10-SYJ312-5LOZ-M3
SY100-68-A-20

Example 2) Lead wire length of 300 mm (standard)
10-SYJ312-5LPZ-M3

Symbol for connector assembly with cover

* In this case, the part number for the connector assembly with cover is not required.



Series 10-SYJ300/500/700 Specific Product Precautions 6

Be sure to read this before handling.
Refer to page 1382 for Safety Instructions and pages 677 to 683 for 3/4/5 Port Solenoid Valve Precautions.

M8 Connector

⚠ Caution

- M8 connectors have an IP65 (enclosure) rating, offering protection from dust and water. However please note that these products are not intended for use in water. Select a SMC connector cable (V100-49-1-□) or a FA sensor type connector, with M8 threaded 3 pin specifications conforming to Nippon Electric Control Equipment Industries Association Standard, NECA4202 (IEC60947-5-2). Make sure the connector O.D. is 10.5 mm or less when used with the 10-SYJ300 series manifold. If more than 10.5 mm, it cannot be mounted due to the size.
- Do not use a tool to mount the connector, as this may cause damage. Only tighten by hand. (0.4 to 0.6 N-m)
- Excessive stress on the cable connector will cause a loss of the IP65 rating. Please use caution and do not apply a stress of 30 N or greater.

⚠ Caution

Failure to meet IP65 performance may result if using alternative connectors than those shown above, or when insufficiently tightened.

• Connector cable mounting

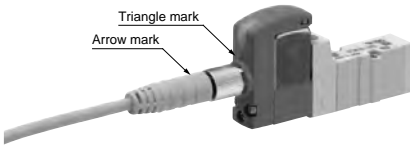

Note) Connector cable should be mounted in the correct direction. Make sure that the arrow symbol on the connector is facing the triangle symbol on the valve when using a SMC connector cable (V100-49-1-□). Be careful not to squeeze it in the wrong direction, as problems such as pin damage may occur.

■ Connector cable

- Connector cable for M8 can be ordered as follows:

How to Order

- To order a solenoid valve and connector cable at the same time.

(Connector cable will be included in the shipment of the solenoid valve.)

10-SYJ $\frac{3}{5}$ $\frac{7}{7}$ □ □ □ - □ □ □ □ - □ □ □

Electrical entry

- W1, WA1: Cable length 300 mm
- W2, WA2: Cable length 500 mm
- W3, WA3: Cable length 1000 mm
- W4, WA4: Cable length 2000 mm
- W7, WA7: Cable length 5000 mm

Example 1) Cable length: 300 mm
10-SYJ312-5W1ZE-M3

↳ Symbol for electrical entry

- To order connector cable only

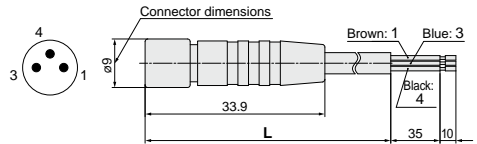

Cable length (L)	Part no.
300 mm	V100-49-1-1
500 mm	V100-49-1-2
1000 mm	V100-49-1-3
2000 mm	V100-49-1-4
5000 mm	V100-49-1-7

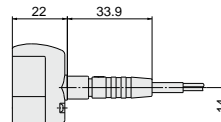

Directional Control Valves

Air Cylinders

Rotary Actuators

Air Grippers

Air Preparation Equipment

Modular F. R.

Pressure Control Equipment

Fittings & Tubing

Flow Control Equipment

Pressure Switches/ Pressure Sensors



Series 10-SYJ300/500/700 Specific Product Precautions 7

Be sure to read this before handling.

Refer to page 1382 for Safety Instructions and pages 677 to 683 for 3/4/5 Port Solenoid Valve Precautions.

Replacement of Pilot Valve

Caution

Pilot valves in this series are improved to provide excellent energy saving results. However following this improvement, these new valves are no longer compatible with the existing pilot valve used at the interface. Consult with SMC if you need to exchange these pilot valves, for manual override (marked in orange) of the adapter plate.

New valve

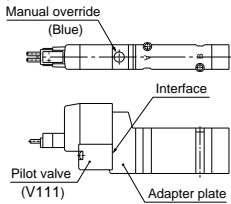

Existing valve

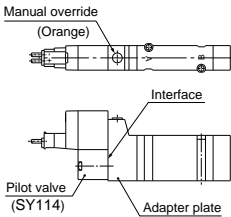

Series 10-SY100

Rubber Seal
3 Port/Direct Operated



Specifications

Fluid	Air
Ambient and fluid temperature (°C)	-10 to 50 (With no freezing. Refer to page 680.)
Response time (ms) ^{Note 1)}	10 or less
Max. operating frequency (Hz)	20
Manual override	Non-locking push type, Locking slotted type Push-turn locking slotted type Push-turn locking lever type {SY1:4 and SY1:4A only}
Lubrication	Not required
Mounting orientation	Unrestricted
Impact/Vibration resistance (m/s ²) ^{Note 2)}	150/30
Enclosure	Dust tight

Note 1) Based on dynamic performance test, JIS B 8374-1981 (Coil temperature: 20°C, at rated voltage, without surge voltage suppressor)

Note 2) Impact resistance: No malfunction occurred when it was tested in the axial direction and at right angles to the armature in both energized and de-energized states once for each condition. (Default settings)
Vibration resistance: No malfunction occurred in a one-sweep between 45 and 2000 Hz. Test was performed in the axial direction and at right angles to the armature in both energized and de-energized states. (Default settings)



Body ported



Base mounted

Symbol

10-SY11 $\frac{3}{4}$ (A)

10-SY12 $\frac{3}{4}$ (A)

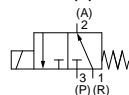
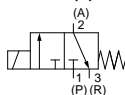

Solenoid Specifications

Series		10-SY1 $\frac{13}{24}$	10-SY1 $\frac{13}{24}$ A
Electrical entry		Grommet (G)/(H), L plug connector (L) M plug connector (M)	
Coil rated voltage (V)	DC	24, 12, 6, 5, 3	
	AC ^{50/60} Hz	100, 110, 200, 220	—
Allowable voltage fluctuation		-10 to +10%	
Power consumption (W)	DC	0.5 (With indicator light: 0.55) 0.75 (With indicator light: 0.8)	
	AC	—	
Apparent power (VA)	AC	100 V	0.9 (With indicator light: 1.0)
		110 V [115 V]	1.0 (With indicator light: 1.1) [1.1 (with indicator light: 1.2)]
		200 V	1.8 (With indicator light: 1.9)
		220 V	1.9 (With indicator light: 2.0)
		[230 V]	[2.2 (with indicator light: 2.3)]
Surge voltage suppressor		Diode	
Indicator light		LED	

* Common between 110 VAC and 115 VAC, and between 220 VAC and 230 VAC.

* [Energy saving type [0.22 W] is also available. Consult SMC for details.]

* [Low wattage [0.45 W] is also available. Consult SMC for details.]

Model

Actuation type	Valve model	Type	Operating pressure range (MPa)	Vacuum specifications (MPa)		Port size		Effective area (mm ²)	Weight (g) ^{Note 2)}	
				1(P) port	3(R) port	1(P), 3(R) port	2(A) port		Grommet	L/M plug connector
N.C.	10-SY11 $\frac{3}{4}$	Standard	0 to 0.7	-100 kPa to 0.6	-100 kPa to 0	M3 x 0.5	M3 x 0.5	0.14	10-SY1□3(A): 13 10-SY1□4(A): 24 (12)	10-SY1□3(A): 15 10-SY1□4(A): 26 (14)
N.C.	10-SY11 $\frac{3}{4}$ A	Large flow	0 to 0.7	-100 kPa to 0.6	-100 kPa to 0	M3 x 0.5	M3 x 0.5	0.22		
N.O.	10-SY12 $\frac{3}{4}$	Standard	0 to 0.7	-100 kPa to 0	-100 kPa to 0.6	M3 x 0.5	M3 x 0.5	0.14		
N.O.	10-SY12 $\frac{3}{4}$ A	Large flow	0 to 0.7	-100 kPa to 0	-100 kPa to 0.6	M3 x 0.5	M3 x 0.5	0.22		

Note 1) For 10-SY12 $\frac{3}{4}$ and 10-SY12 $\frac{3}{4}$ A, supply pressure to port 1 (R) and exhaust from port 3 (P).

Note 2) Value for DC. Add 1g for AC. (): Without sub-plate.

Directional Control Valves

Air Cylinders

Rotary Actuators

Air Grippers

Air Preparation Equipment

Modular F. R.

Pressure Control Equipment

Fittings & Tubing

Flow Control Equipment

Pressure Switches/Pressure Sensors

How to Order

Standard type
(Cv0.008)

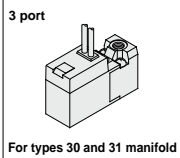

Actuation type

1	Normally closed
2	Normally open

Light/Surge voltage suppressor

Nil	Without light/surge voltage suppressor
S	With surge voltage suppressor
Z	With light/surge voltage suppressor
R	With surge voltage suppressor (Non-polar type)
U	With light/surge voltage suppressor (Non-polar type)

* For AC voltage valves, there is no "S" option. It is already built into the rectifier circuit.
* For "R" and "U", only DC voltage is available.

Porting specifications

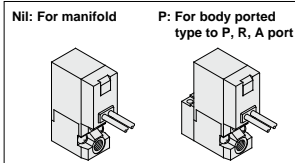

Bracket

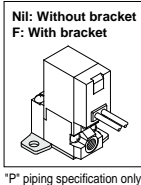

Standard: Body ported
(Cv: 0.008)

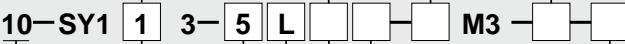

Standard: Base mounted
(Cv: 0.008)

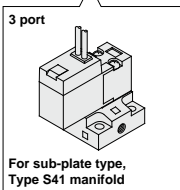
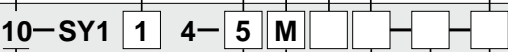

Clean series

Rated voltage

For DC		CE-compliant
5	24 VDC	●
6	12 VDC	●
V	6 VDC	●
S	5 VDC	●
R	3 VDC	●
For AC (50/60Hz)		CE-compliant
1	100 VAC	—
2	200 VAC	—
3	110 VAC [115 VAC]	—
4	220 VAC [230 VAC]	—

CE-compliant

Nil	—
Q	CE-compliant

* When selecting "Q", select the CE-compliant rated voltage.

Port size

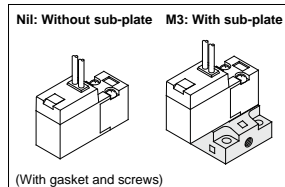

Electrical entry

24, 12, 6, 5, 3 VDC / 100, 110, 200, 220 VAC			
Grommet	L plug connector	M plug connector	
G: Lead wire Length 300 mm	L: With lead wire (Length 300 mm)	M: With lead wire (Length 300 mm)	MN: Without lead wire
H: Lead wire Length 600 mm	LN: Without lead wire	LO: Without connector	MO: Without connector

* "LN", "MN" type: With 2 sockets.

Manual override

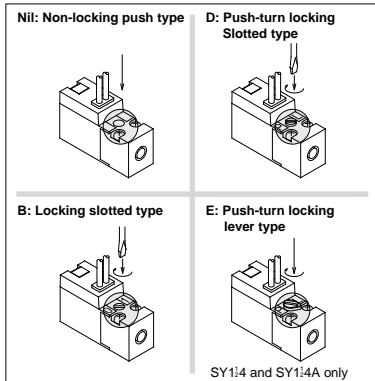

How to Order



Large flow type
(Cv0.012)

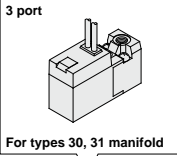

Actuation type

1	Normally closed
2	Normally open

Light/surge voltage suppressor

Nil	Without light/surge voltage suppressor
S	With surge voltage suppressor
Z	With light/surge voltage suppressor
R	With surge suppressor (Non-polar type)
U	With light/surge voltage suppressor (Non-polar type)

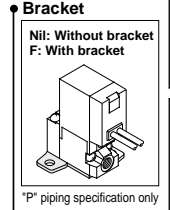
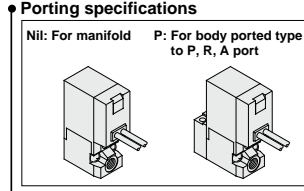

Large flow type (Cv: 0.012) : Body ported

10-SY1 1 3 A 5 L M3

Large flow type (Cv: 0.012) : Base mounted

10-SY1 1 4 A 5 M

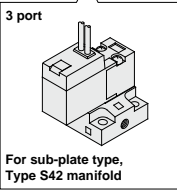

Clean series
Large flow type

Rated voltage

		CE-compliant
5	24 VDC	●
6	12 VDC	●
V	6 VDC	●
S	5 VDC	●
R	3 VDC	●

CE-compliant

Nil	-
Q	CE-compliant

* When selecting "Q", select the CE-compliant rated voltage.

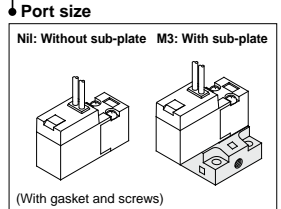

Electrical entry

24, 12, 6, 5, 3 VDC			
Grommet	L plug connector	M plug connector	
G: Lead wire Length 300 mm	L: With lead wire (Length 300 mm)	M: With lead wire (Length 300 mm)	MN: Without lead wire
H: Lead wire Length 600 mm	LN: Without lead wire	LO: Without connector	MO: Without connector

* "LN", "MN" types: With 2 sockets.

Manual override

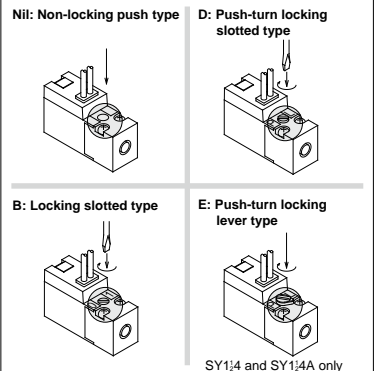

Directional Control Valves
Air Cylinders
Rotary Actuators
Air Grippers
Air Preparation Equipment
Modular F. R.
Pressure Control Equipment
Fittings & Tubing
Flow Control Equipment
Pressure Switches/Pressure Sensors

3 Port/Direct Operated 10-SY100

Body ported

Grommet (G)/(H): 10-SY1 $\frac{1}{2}$ 3(A)-□_G□□-PM3(-F)

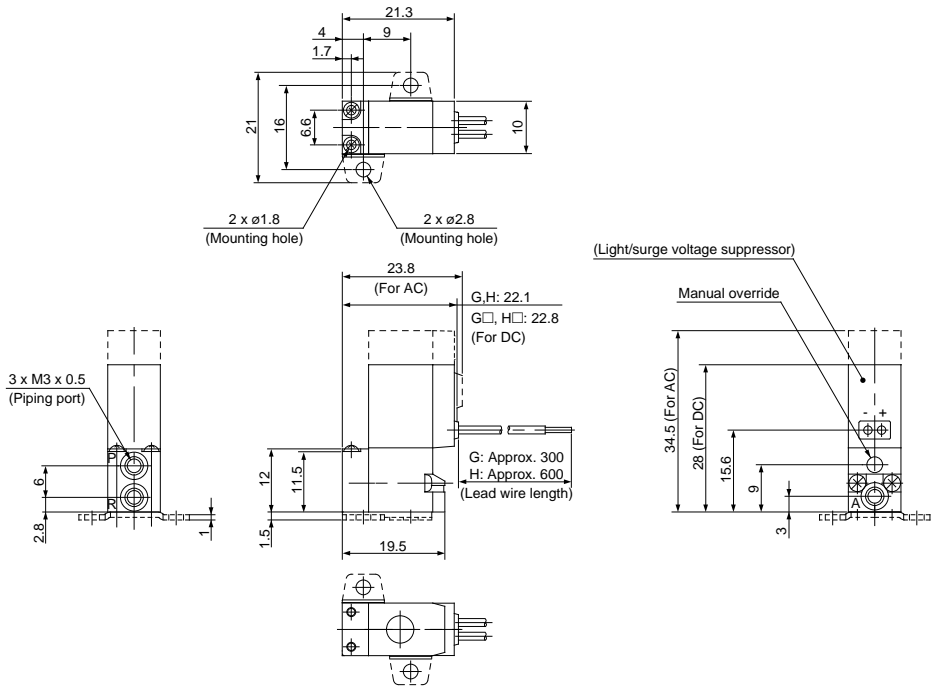

L plug connector (L): 10-SY1 $\frac{1}{2}$ 3(A)-□L□□-PM3(-F)

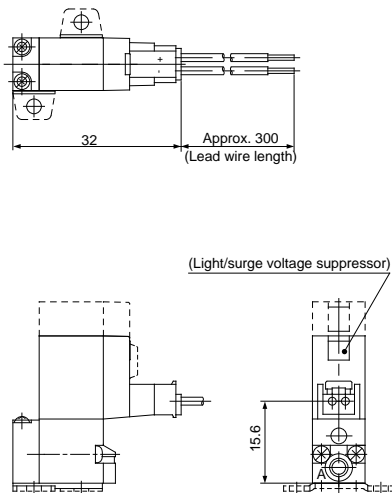

* Other dimensions are the same as the grommet type.

M plug connector (M): 10-SY1 $\frac{1}{2}$ 3(A)-□M□□-PM3(-F)

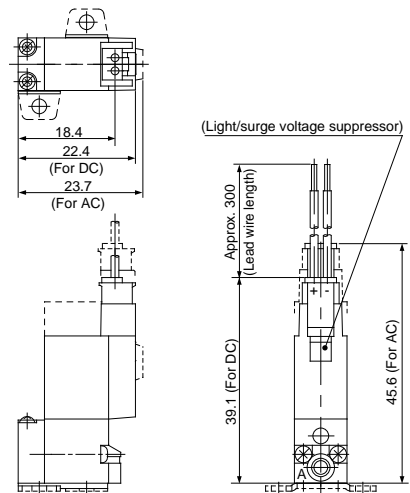

* Other dimensions are the same as the grommet type.

Base mounted (With sub-plate)

Grommet (G)/(H): 10-SY1₂4(A)-□_H□□-M3

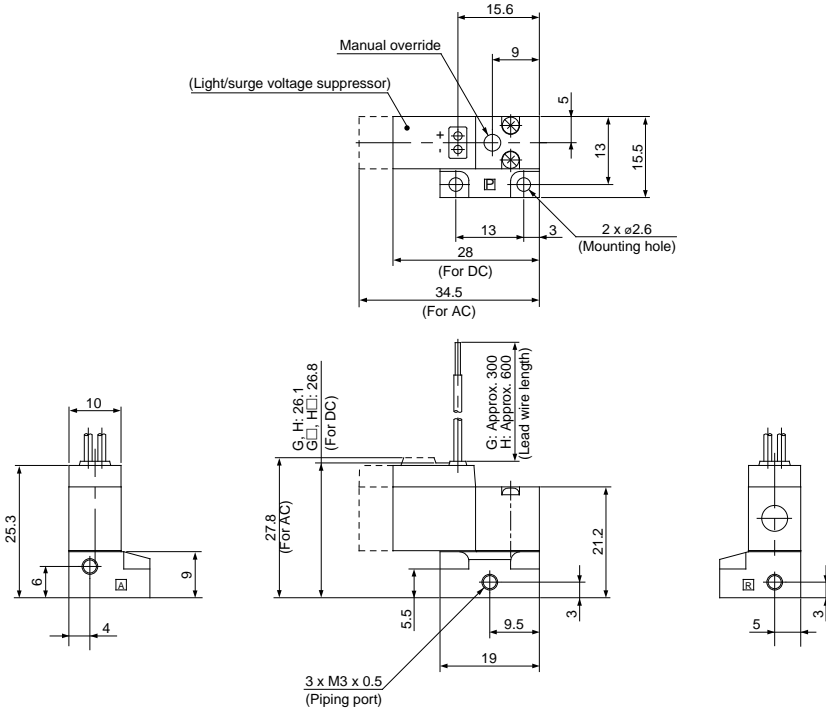

L plug connector (L): 10-SY1₂4(A)-□L□□-M3

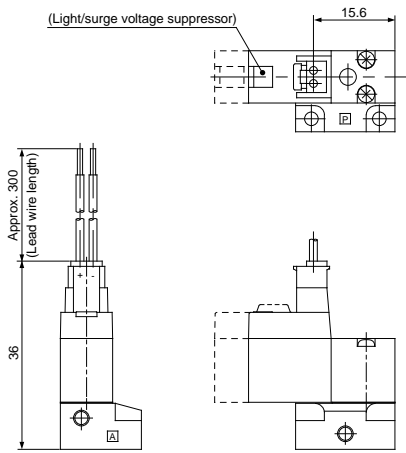

* Other dimensions are the same as the grommet type.

M plug connector (M): 10-SY1₂4(A)-□M□□-M3

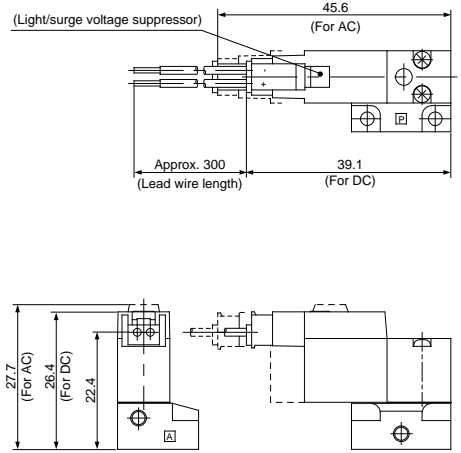

* Other dimensions are the same as the grommet type.

- Directional Control Valves
- Air Cylinders
- Rotary Actuators
- Air Grippers
- Air Preparation Equipment
- Modular F. R.
- Pressure Control Equipment
- Fittings & Tubing
- Flow Control Equipment
- Pressure Switches/ Pressure Sensors

Series 10-SY100 Manifold Specifications



Manifold Specifications

Model	Type 30 <small>Note 3)</small>	Type 31	Type S41
Manifold	Single base / B mount		
P(SUP) / R(EXH)	Common SUP / Common EXH		
Stations	2 to 10 stations	2 to 20 stations	
A port piping specifications	Location	Valve	Base
	Direction	Top	Side
Port size	P, R ports	M5 x 0.8	
	A port	M3 x 0.5	M3 x 0.5, M5 x 0.8

Note 1) 10-SY114 (A) and 10-SY124 (A) cannot be mounted on the same manifold.

Note 2) For 10-SY124 (A), supply pressure to R port and exhaust from P port.

Note 3) Type 30 is dedicated to SY113 and SY113A. Additionally, the piping cannot be connected to the exhaust port.

Note 4) CE-compliant: For DC only.

Flow Rate Characteristics

Manifold		Port size		Effective area (mm ²)
		1(P), 3(R) port	2(A) port	
Type 10-SS3Y1-30	10-SY1□3	M5 x 0.8	M3 x 0.5	0.14
	10-SY1□3A			0.21
Type 10-SS3Y1-31	10-SY1□3	M5 x 0.8	M3 x 0.5	0.14
	10-SY1□3A			0.21
Type 10-SS3Y1-S41	10-SY1□4	M5 x 0.8	M3 x 0.5	0.14
	10-SY1□4A			0.21
	10-SY1□4	M5 x 0.8	M5 x 0.8	0.14
	10-SY1□4A			0.21

Note) The values are for manifold bases.

How to Order Manifold Assembly (Example)

Ordering example

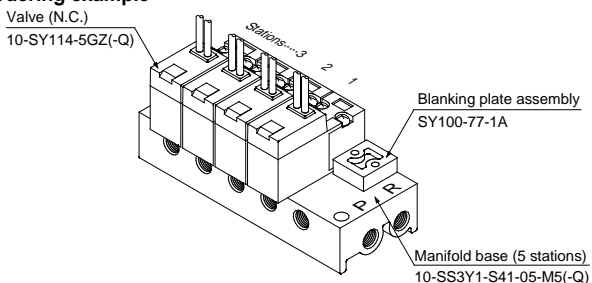

10-SS3Y1-S41-05-M5(-Q).....1 set (Type S41 5 station manifold part no.)

* SY100-77-1A.....1 set (Blanking plate assembly part no.)

* 10-SY114-5GZ(-Q).....4 sets (Valve)

↳ The asterisk denotes the symbol for assembly. Prefix it to the part no. of the solenoid valve, etc.

Indicate the part numbers of the valve and option beneath the part number of manifold.

Common SUP / Common EXH

Type 30

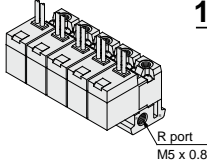

How to Order

10 - SS3Y1 - 30 - 05 - F - []

• Clean series

Stations	
02	2 stations
:	:
20	20 stations

• CE-compliant	
Nil	—
Q	CE-compliant

Applicable solenoid valve
 10-SY113-□□□□-M3(-Q)
 10-SY113A-□□□□-M3(-Q)
 Applicable blanking plate assembly
 SY100-77-1A

Note) The piping cannot be connected to the exhaust port.

Type 31

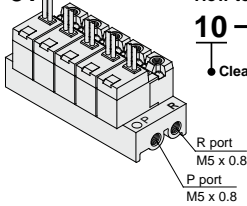

How to Order

10 - SS3Y1 - 31 - 05 - []

• Clean series

Stations	
02	2 stations
:	:
20	20 stations

• CE-compliant	
Nil	—
Q	CE-compliant

Applicable solenoid valve ^{Note)}
 10-SY113-□□□□-M3(-Q)
 10-SY113A-□□□□-M3(-Q)
 10-SY123-□□□□-M3(-Q)
 10-SY123A-□□□□-M3(-Q)
 Applicable blanking plate assembly
 SY100-77-1A

Note) 10-SY113(A) and 10-SY123(A) cannot be mounted on the same manifold.

Type S41

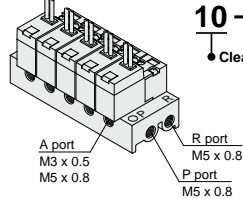

How to Order

10 - SS3Y1 - S41 - 05 - M3 - []

• Clean series

Stations	
02	2 stations
:	:
20	20 stations

• A port size	
M3	M3 x 0.5
M5	M5 x 0.8

• CE-compliant	
Nil	—
Q	CE-compliant

Applicable solenoid valve ^{Note)}
 10-SY114-□□□□(-Q)
 10-SY114A-□□□□(-Q)
 10-SY124-□□□□(-Q)
 10-SY124A-□□□□(-Q)
 Applicable blanking plate assembly
 SY100-77-1A

Note) 10-SY114(A) and 10-SY124(A) cannot be mounted on the same manifold.

Combinations of Solenoid Valve, Gasket Manifold

Body ported

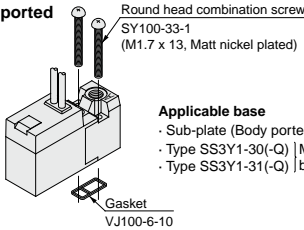

Applicable base
 • Sub-plate (Body ported)
 • Type SS3Y1-30(-Q) | Manifold
 • Type SS3Y1-31(-Q) | base

Base mounted

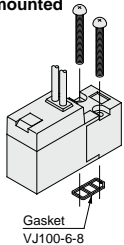

Applicable base
 • Sub-plate
 • Type SS3Y1-S41(-Q) | Manifold base
 Sub-plate part no.
 Standard: SY100-74-1
 CE-compliant: SY100-74-1-Q
 * The standard and CE-compliant sub-plate part numbers are different from each other.

(Manifold option)

How to Order Connector Assembly

For DC: SY100 - 30 - 4A - []

For 100 VAC: SY100 - 30 - 1A - []

For 200 VAC: SY100 - 30 - 2A - []

For other voltages of AC: SY100 - 30 - 3A - []

Without lead wire: SY100 - 30 - A

Lead wire length

Nil	300 mm
6	600 mm
10	1000 mm
15	1500 mm
20	2000 mm
25	2500 mm
30	3000 mm
50	5000 mm

Blanking plate assembly

Part no: SY100-77-1A

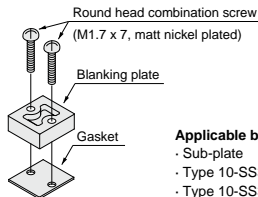

Applicable base
 • Sub-plate
 • Type 10-SS3Y1-31 | Manifold
 • Type 10-SS3Y1-S41 | base

Caution

Mounting Screw Tightening Torque M1.7: 0.12 N·m

Directional Control Valves
 Air Cylinders
 Rotary Actuators
 Air Grippers
 Air Preparation Equipment
 Modular F. R.
 Pressure Control Equipment
 Fittings & Tubing
 Flow Control Equipment
 Pressure Switches/ Pressure Sensors

Type 31 Manifold: Top Ported / 10-SS3Y1-31- Stations

Grommet (G), (H)

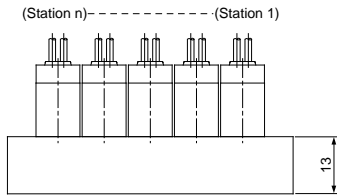
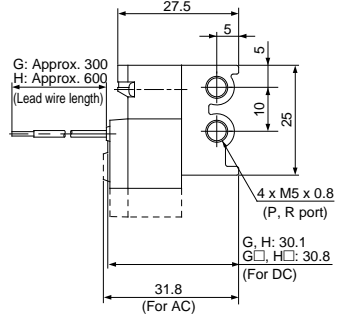
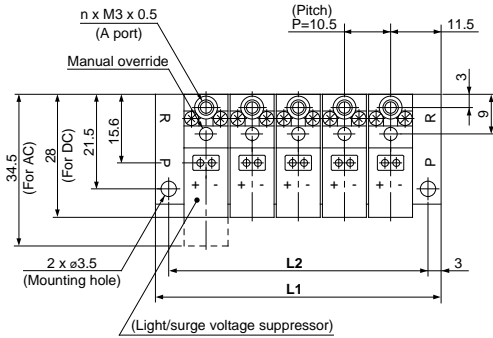

L plug connector (L)

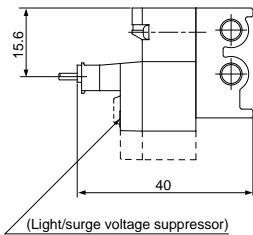

* Other dimensions are the same as the grommet type.

M plug connector (M)

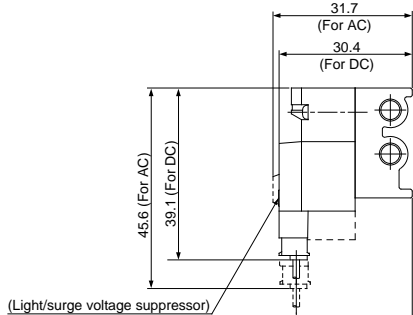

* Other dimensions are the same as the grommet type.

Stations	2 stations	3	4	5	6	7	8	9	10	11	12	13	14	15	16	17	18	19	20 stations
L1	33.5	44	54.5	65	75.5	86	96.5	107	117.5	128	138.5	149	159.5	170	180.5	191	201.5	212	222.5
L2	27.5	38	48.5	59	69.5	80	90.5	101	111.5	122	132.5	143	153.5	164	174.5	185	195.5	206	216.5

Directional Control Valves

Air Cylinders

Rotary Actuators

Air Grippers

Air Preparation Equipment

Modular F. R.

Pressure Control Equipment

Fittings & Tubing

Flow Control Equipment

Pressure Switches/ Pressure Sensors

Type S41 Manifold: Side Ported / 10-SS3Y1-S41- Stations -M3/M5

Grommet (G), (H)

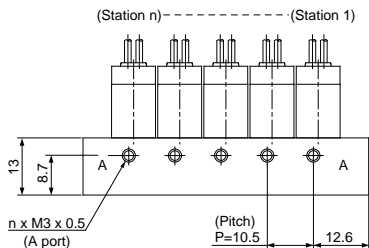
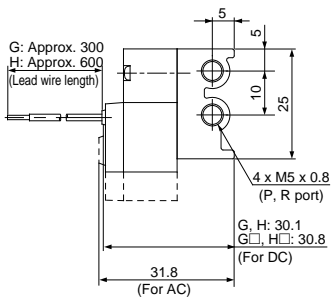
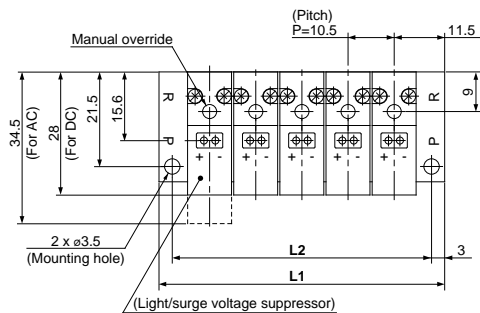

For M3

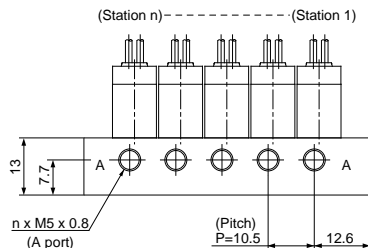

With M5

L plug connector (L)

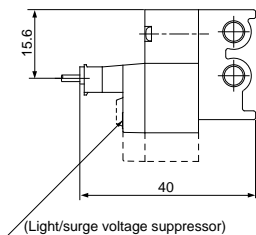

M plug connector (M)

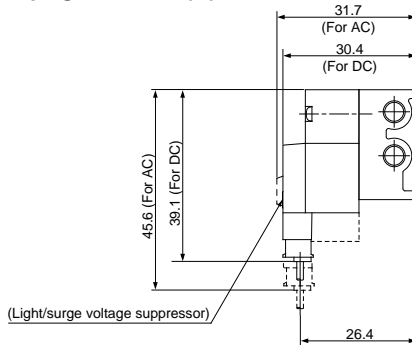

* Other dimensions are the same as the grommet type.

* Other dimensions are the same as the grommet type.

Stations	2 stations	3	4	5	6	7	8	9	10	11	12	13	14	15	16	17	18	19	20 stations
L1	33.5	44	54.5	65	75.5	86	96.5	107	117.5	128	138.5	149	159.5	170	180.5	191	201.5	212	222.5
L2	27.5	38	48.5	59	69.5	80	90.5	101	111.5	122	132.5	143	153.5	164	174.5	185	195.5	206	216.5

Series 10-S070 Compact Direct Operated 3 Port Solenoid Valve



How to Order Valve

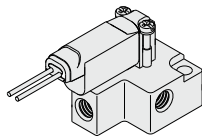

Base mounted

Body ported

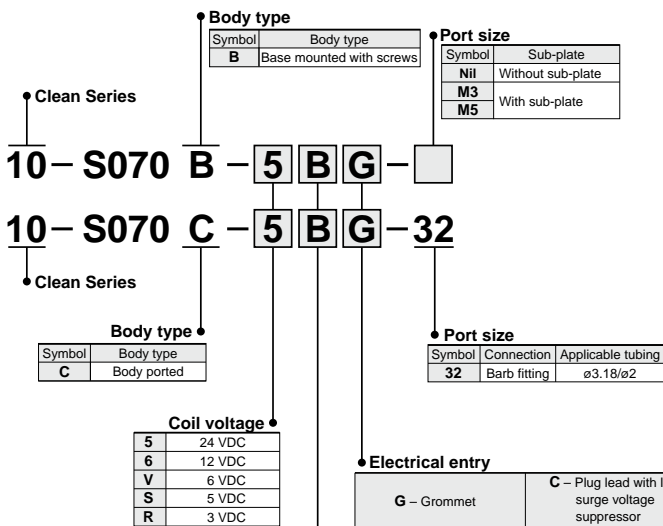
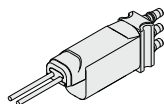

Power consumption – Pressure specification – Flow rate

Symbol	Power consumption (W)	Maximum operating pressure (MPa)	Cv factor
A	0.35	0.1	0.016
B		0.3	0.011
C	0.5	0.3	0.016
D		0.5	0.011
E (Note)	0.1 (With power saving circuit)	0.1	0.011
F (Note)		0.3	0.006

Note) An option only applicable to 24 VDC plug lead type.



Made to Order
(Refer to page 670 for details.)

Symbol	Specifications
X26	Grommet type, Special lead wire length
X50	Universal type
X62	Normally open type

Directional Control Valves

Air Cylinders

Rotary Actuators

Air Grippers

Air Preparation Equipment

Modular F. R.

Pressure Control Equipment

Fittings & Tubing

Flow Control Equipment

Pressure Switches/ Pressure Sensors

Compact Direct Operated 3 Port Solenoid Valve 10-S070

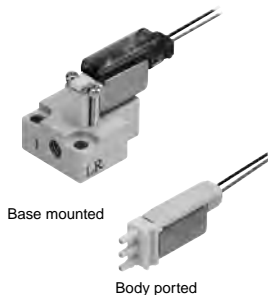

Symbol

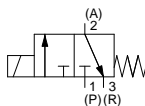

Specifications

Valve construction	Poppet
Fluid	Air/Inert gas/Low vacuum (1.33×10^2 Pa)
Maximum operating pressure	0.3 MPa (0.35 W, 0.1 W), 0.5 MPa (0.5 W)
Proof pressure	1 MPa
Ambient and fluid temperature ^{Note 1)}	-10 to 50°C
Lubrication	Not required
Impact/Vibration resistance ^{Note 2)}	30/150 m/s ²
Enclosure	IP40
Weight	5 g (Single unit valve)
Mounting orientation	Free

Note 1) Use dry air and prevent condensation at low temperatures.

Note 2) Vibration resistance: No malfunction occurred in a one-sweep test between 45 and 2000 Hz. Test was performed in both energized and de-energized states in the axial direction and at right angles to the armature.

Impact resistance: No malfunction occurred when it was tested with a drop tester in the axial direction and at right angles to the armature in both energized and de-energized states once for each condition.

Note 3) With the low vacuum specification, the operating pressure range is 1.33×10^2 Pa to the maximum operating pressure.

Solenoid Specifications

Power consumption ^{Note 1)}	0.35 W (Standard), 0.5 W (High voltage), 0.1 W (Holding)
Rated coil voltage	3, 5, 6, 12, 24 VDC
Allowable voltage fluctuation	±10% of the rated voltage
Coil insulation type	Equivalent to class B

Note 1) With a light/surge voltage suppressor and power saving circuit, the light consumes a power equivalent to 2 mA.

Flow Rate Characteristics/Response Time

Power consumption	Maximum operating pressure	Flow rate characteristics			Response time ms ^{Note 2, 3)}	
		C[dm ³ /(s·bar)]	b	Cv	ON	OFF
0.5 W	0.5 MPa	0.042	0.27	0.011	3 or less	3 or less
	0.3 MPa	0.060	0.28	0.016	5 or less	3 or less
0.35 W	0.3 MPa	0.042	0.27	0.011	3 or less	3 or less
	0.1 MPa	0.060	0.28	0.016	5 or less	3 or less
0.1 W (at holding) with power saving circuit ^{Note 1)}	0.3 MPa	0.021	0.27	0.006	3 or less	6 or less
	0.1 MPa	0.042	0.28	0.011	5 or less	6 or less

Note 1) 0.35 W at inrush (100 ms) and 0.1 W at holding.

Note 2) The response time is the value at the rated voltage, maximum operating pressure, ambient and fluid temperature (approx. 25°C).

Note 3) If the product is used in the following conditions or environment, switching of the valve may be significantly delayed compared to the above values.

1. The first response time when the valve is not used for a long period of time
2. When using at low supply pressure (0.1 MPa or less)
3. When using in an environment where the ambient and fluid temperature is low (10°C or less)

Construction

Component Parts

Number	Description	Material
1	Solenoid coil	—
2	Body	Resin
3	Core	Stainless steel
4	Armature assembly	Stainless steel, resin
5	Return spring	Stainless steel
6	Poppet	FKM
7	Interface gasket	HNBR
8	Mounting screw	Carbon steel
9	Sub-plate	Aluminum

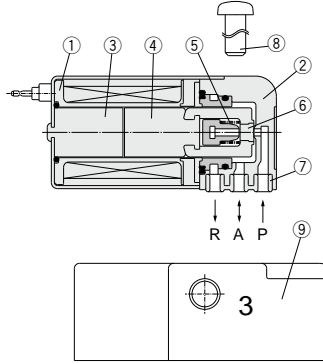

* The above figure is an example of 10-S070B-□□G base piping type (mounted with screws).

Replacement Parts

Plug connector assembly (for plug lead)

S070-14A-

● Lead wire length

Nil	150 mm
3	300 mm
6	600 mm
10	1000 mm



9 Sub-plate

S070-S- M3

● Port size

M3	M3 female thread
M5	M5 female thread

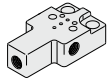

7 Interface gasket

Valve model	Gasket no.
S070A	S070A-80A-1
S070B	S070B-80A-1
S070M	S070M-80A-1



Note) Order is accepted in 10 units.

8 Mounting screw

Valve model	Mounting screw no.
S070B	AXT632-106A-1
S070C	AXT632-106A-2



Note) The above part number consists of 10 units.
Each unit has two screws.
Order is accepted in 10 units.

Bracket (S070B)

Valve model	Bracket no.	Note
S070B, SS073B	S070B-80A-2	For sub-plates and manifolds (more than 3 stations)
SS073B	S070B-80A-3	For manifolds (2 stations only)

Note) Order is accepted in 10 units.

* This is used when mounting a valve on the sub-plate and manifold.

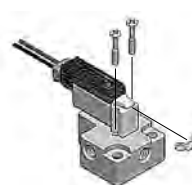

Single unit (base mounted)

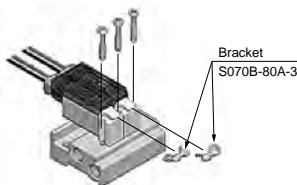

Manifold with 2 stations

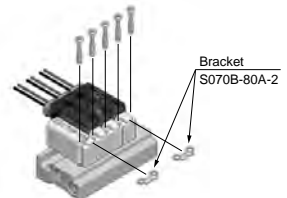

Manifold with more than 3 stations

Dimensions

Base mounted with screws

10-S070B-□□G-M3

Grommet type

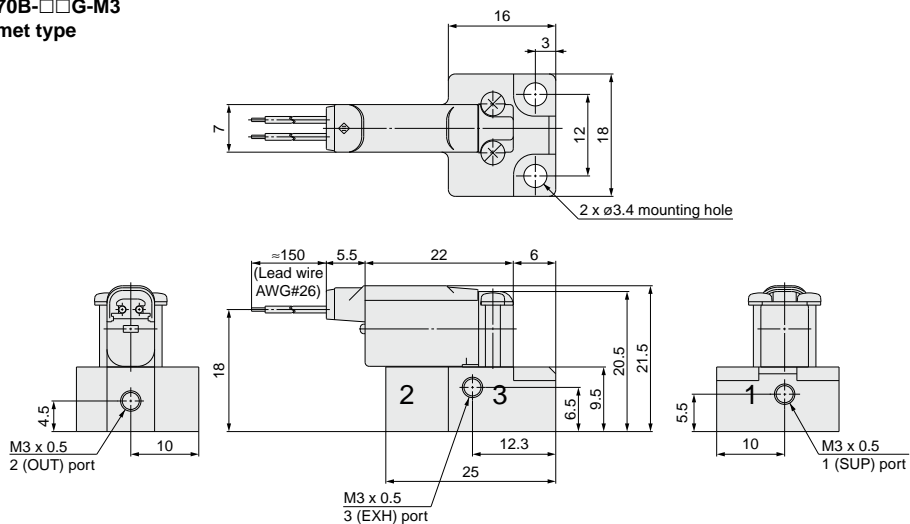

10-S070B-□□C-M3

Plug lead type

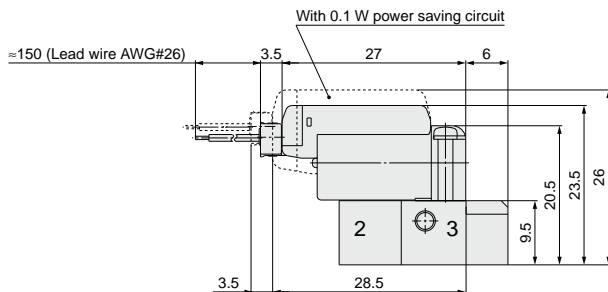

Dimensions

Body ported

10-S070C-□□G-32

Grommet type

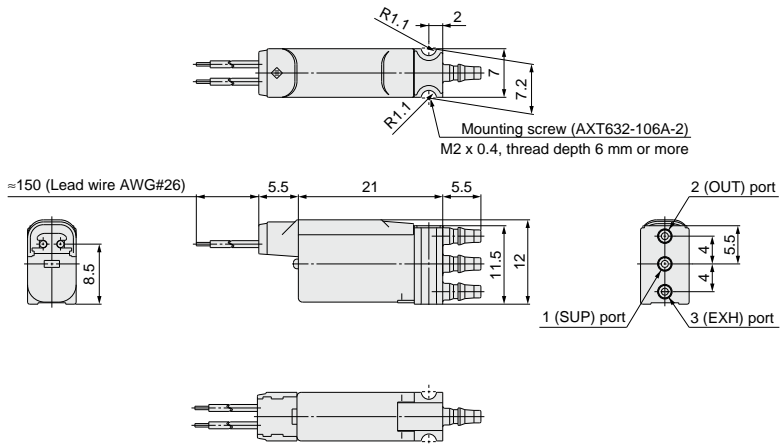

10-S070C-□□C-32

Plug lead type

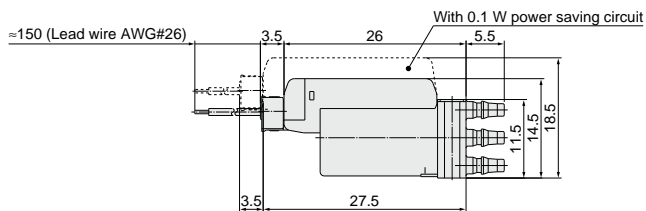

3 Port Solenoid Valve

Series 10-S070/Base Mounted Manifold

Separable Base Type

How to Order Manifold

Base mounted manifold separable base

10-SS07 3 A01-08 C

Clean Series

Ports

3 3 port

Port size

Symbol	SUP/EXH port (Applicable tubing)	OUT port	
		Applicable tubing	
A01	Barb fittings (ø6/ø4)	Barb fittings	ø3.18/ø2
A02			ø4/ø2.5
A03			ø2/ø1.2

Note) The outside and inside diameters of the applicable tubing are indicated for the barb fitting.



Stations

02	2 stations
03	3 stations
...	...
20	20 stations

Note) Maximum of 20 stations

Electrical entry

C Grommet/Plug lead

How to Order Manifold Assembly

Enter the part numbers of the valves and options to be mounted below the manifold base part number.

<Example>
10-SS073A01-04C 1 set Manifold base no.
***10-S070A-5BG** 3 sets Valve no.
****SS070A-10A** 1 set Blanking plate assembly no.

Prefix the symbol "*" to the solenoid valve part number.

Write sequentially from the 1st station on the D side.

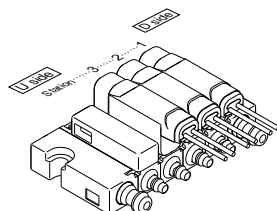

How to Order Valve

10-S070 A-5 B G

Clean Series

Body type

Symbol	Body type
A	Base mounted with clips

Coil voltage

5	24 VDC
6	12 VDC
V	6 VDC
S	5 VDC
R	3 VDC

Electrical entry

G	Grommet
C	Plug lead with light/surge voltage suppressor
CO	Plug lead without connector and with light/surge voltage suppressor

Power consumption – Pressure specification – Flow rate

Symbol	Power consumption (W)	Maximum operating pressure (MPa)	Cv factor
A	0.35	0.1	0.016
B		0.3	0.011
C	0.5	0.3	0.016
D		0.5	0.011
E (Note)	0.1	0.1	0.011
F (Note)	(With power saving circuit)	0.3	0.006

Note) An option only applicable to 24 VDC plug lead type.

Dimensions

Base mounted manifold/Separable base

10-SS073A⁰¹₀₂ Stations **C**

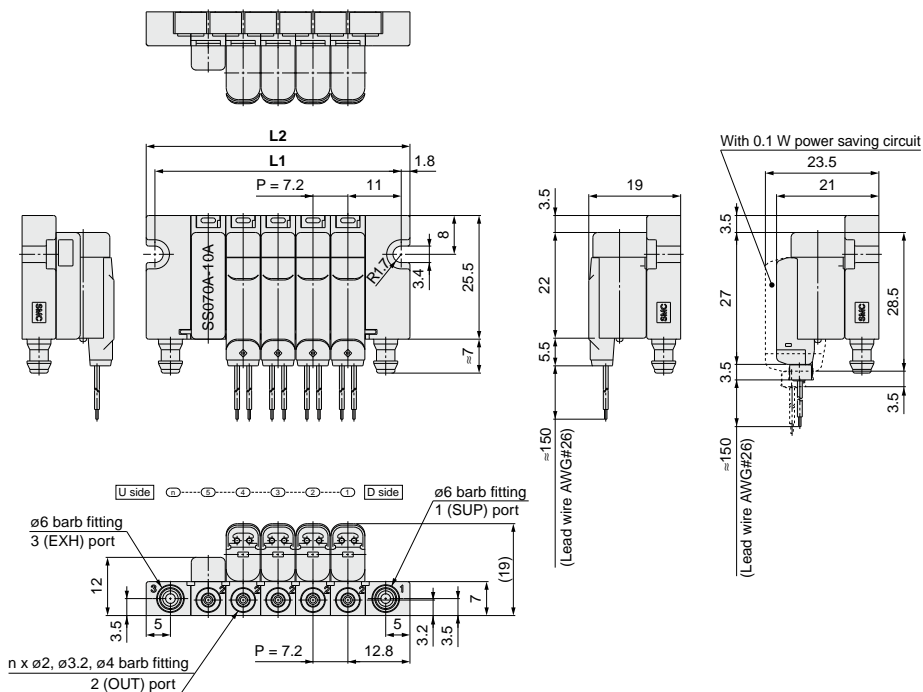

Dimensions

Formulas: $L1 = n \times 7.2 + 14.8$, $L2 = n \times 7.2 + 18.4$, n: Stations (maximum 20 stations)

n	2	3	4	5	6	7	8	9	10	11	12	13	14	15	16	17	18	19	20
L1	29.2	36.4	43.6	50.8	58	65.2	72.4	79.6	86.8	94	101.2	108.4	115.6	122.8	130	137.2	144.4	151.6	158.8
L2	32.8	40	47.2	54.4	61.6	68.8	76	83.2	90.4	97.6	104.8	112	119.2	126.4	133.6	140.8	148	155.2	162.4

3 Port Solenoid Valve

Series 10-S070/Base Mounted Manifold

Bar Base Specifications

How to Order Manifold

Base mounted manifold bar base

10-SS07 3 B01-08 C

Clean Series

Ports
3 3 port

Port size

Symbol	SUP/EXH port (Applicable tubing)	OUT port (Applicable tubing)
B01	M5 female thread	M3 female thread



Stations

02	2 stations
03	3 stations
⋮	⋮
20	20 stations
(Note) Maximum of 20 stations	

Electrical entry

C Grommet/Plug lead

How to Order Manifold Assembly

Enter the part numbers of the valves and options to be mounted below the manifold base part number.

<Example>
10-SS073B01-04C 1 set Manifold base no.
*10-S070B-5BG 3 sets Valve no.

**SS070B-10A 1 set Blanking plate assembly no.

→ Prefix the symbol "*" to the solenoid valve part number.

Write sequentially from the 1st station on the D side.

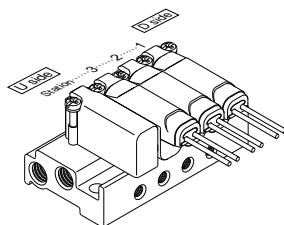

How to Order Valve

10-S070 B-5 B G

Clean Series

Body type

Symbol	Body type
B	Base mounted with screws

Electrical entry

G	Grommet
C	Plug lead with light/surge voltage suppressor
CO	Plug lead without connector and with light/surge voltage suppressor

Coil voltage

5	24 VDC
6	12 VDC
V	6 VDC
S	5 VDC
R	3 VDC

Power consumption – Pressure specification – Flow rate

Symbol	Power consumption (W)	Maximum operating pressure (MPa)	Cv factor
A	0.35	0.1	0.016
B		0.3	0.011
C	0.5	0.3	0.016
D		0.5	0.011
E (Note)		0.1	0.011
F (Note)	(With power saving circuit)	0.3	0.006

(Note) An option only applicable to 24 VDC plug lead type.

Dimensions

Base mounted manifold/Bar base

10-SS073B01-**Stations**C

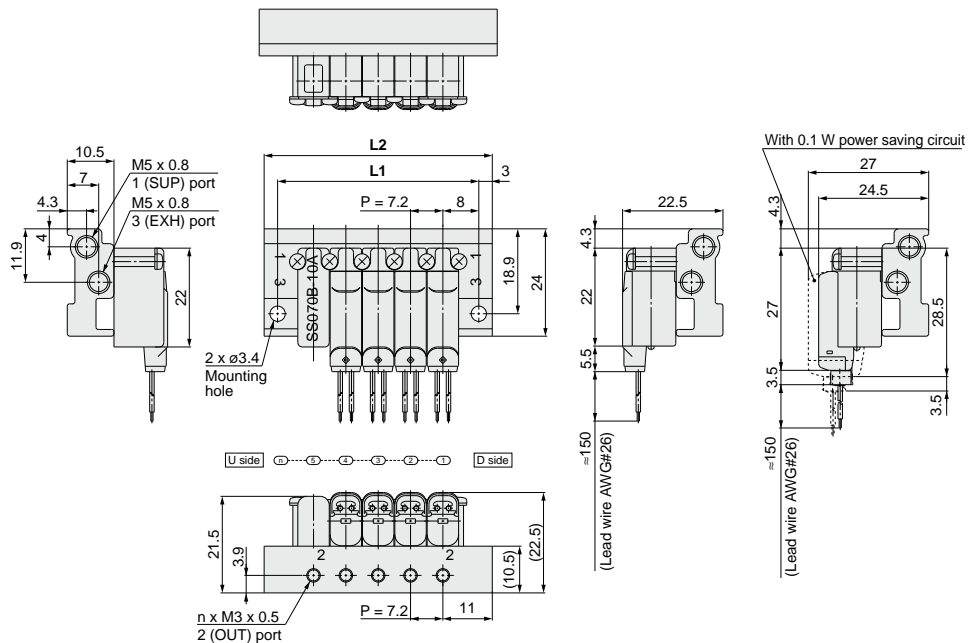

Dimensions

Formulas: $L1 = n \times 7.2 + 8.8$, $L2 = n \times 7.2 + 14.8$, n: Stations (maximum 20 stations)

L	n	2	3	4	5	6	7	8	9	10	11	12	13	14	15	16	17	18	19	20
L1		23.2	30.4	37.6	44.8	52	59.2	66.4	73.6	80.8	88	95.2	102.4	109.6	116.8	124	131.2	138.4	145.6	152.8
L2		29.2	36.4	43.6	50.8	58	65.2	72.4	79.6	86.8	94	101.2	108.4	115.6	122.8	130	137.2	144.4	151.6	158.8

3 Port Solenoid Valve

Series 10-S070/Base Mounted Manifold

Stacking Type Specifications

How to Order Manifold

Body ported manifold stacking type

10-SS07 3 M01-08 C

Clean Series

Ports

3	3 port
---	--------

Port size

Symbol	SUP/EXH port (Applicable tubing)		OUT port Applicable tubing	
	Barb fittings (ø6/ø4)		Barb fittings	
M01			ø3.18/ø2	
M02			ø4/ø2.5	

Note) The outside and inside diameters of the applicable tubing are indicated for the barb fitting.

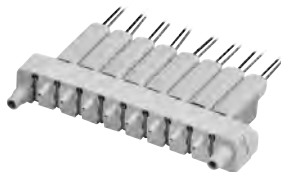

Stations

02	2 stations
03	3 stations
...	...
20	20 stations

Note) Maximum of 20 stations

Electrical entry

C	Grommet/Plug lead
---	-------------------

How to Order Manifold Assembly

Enter the part numbers of the valves and options to be mounted below the manifold base part number.

<Example>
10-SS073M01-04C ... 1 set — Manifold base no.
 ***10-S070M-5BG-32** ... 4 sets — Valve no.

Prefix the symbol "*" to the solenoid valve part number.

Write sequentially from the 1st station on the D side.

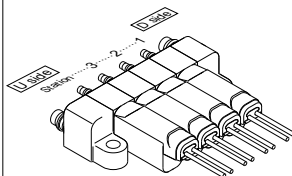

How to Order Valve

10-S070 M-5 B G-32

Clean Series

Body type

Symbol	Body type
M	Body ported stacking type manifold

Coil voltage

5	24 VDC
6	12 VDC
V	6 VDC
S	5 VDC
R	3 VDC

Port size

Symbol	Connection	Applicable tubing
32	Barb fitting	ø3.18/ø2
40		ø4/ø2.5

Electrical entry

G	Grommet
C	Plug lead with light/surge voltage suppressor
CO	Plug lead without connector and with light/surge voltage suppressor

Power consumption – Pressure specification – Flow rate

Symbol	Power consumption (W)	Maximum operating pressure (MPa)	Cv factor
A	0.35	0.1	0.016
B		0.3	0.011
C		0.3	0.016
D	0.5	0.5	0.011
E Note)		0.1	0.011
F Note)	(With power saving circuit)	0.3	0.006

Note) An option only applicable to 24 VDC plug lead type.

Dimensions

Body ported stacking type manifold

10-SS073M⁰¹/₀₂ - Stations **C**

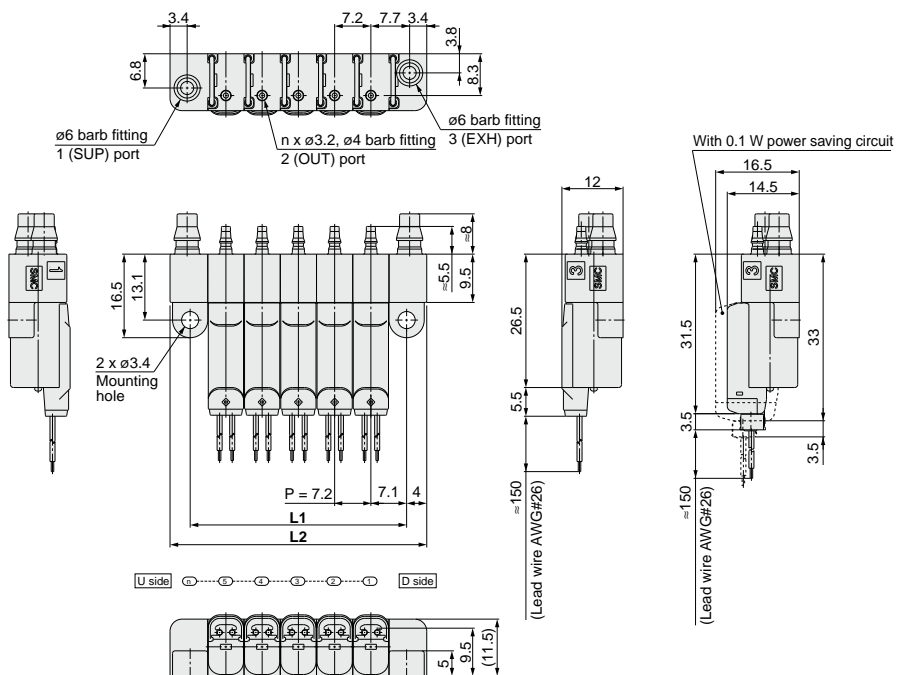

Dimensions

Formulas: $L1 = n \times 7.2 + 7$, $L2 = n \times 7.2 + 15$, n: Stations (maximum 20 stations)

L	n	2	3	4	5	6	7	8	9	10	11	12	13	14	15	16	17	18	19	20
L1		21.4	28.6	35.8	43	50.2	57.4	64.6	71.8	79	86.2	93.4	100.6	107.8	115	122.2	129.4	136.6	143.8	151
L2		29.4	36.6	43.8	51	58.2	65.4	72.6	79.8	87	94.2	101.4	108.6	115.8	123	130.2	137.4	144.6	151.8	159



1 Grommet Type: Special Lead Wire Length

X26

10-S070 **B** - [] - [] **G** - [] - X26 - []

- Clean Series
- Coil voltage
- Body type
- Grommet type
- Power consumption – Pressure specifications – Flow rate
- Body ported: Port size
No symbol is used for the base mounted type.
- Lead wire length (L)

Symbol	Length (L)
3	300 mm
6	600 mm
10	1000 mm

Symbol	Body type
A	Base mounted/Clipped
B	Base mounted/Screwed
C	Body ported/Single unit
M	Body ported/Stacking type manifold

2 Universal Specifications

X50

10-S070 **B** - [] - [] **G** - [] - X50

- Clean Series
- Body type
- Coil voltage
- Electrical entry
- Body ported: Port size
No symbol is used for the base mounted type.
- Power consumption – Pressure specifications – Flow rate

Symbol

Symbol	Power consumption	Operating pressure range	Flow rate characteristics		
			C (dm ³ /(s·bar))	b	CV
A	0.35 WDC	0 to 0.1 MPa	0.042	0.27	0.011
B		0 to 0.3 MPa	0.021	0.27	0.006
C	0.5 WDC	0 to 0.3 MPa	0.042	0.27	0.011
D		0 to 0.5 MPa	0.021	0.27	0.006

3 Normally Open Specifications

X62

10-S070 **B** - [] - [] **G** - [] - X62

- Clean Series
- Body type
- Coil voltage
- Electrical entry
- Body ported: Port size
No symbol is used for the base mounted type.
- Power consumption – Pressure specifications – Flow rate

Symbol

Symbol	Power consumption	Max. operating pressure (3 port pressure)	Flow rate characteristics		
			C (dm ³ /(s·bar))	b	CV
A	0.35 WDC	0 to 0.1 MPa	0.042	0.27	0.011
B		0 to 0.3 MPa	0.021	0.27	0.006
C	0.5 WDC	0 to 0.3 MPa	0.042	0.27	0.011
D		0 to 0.5 MPa	0.021	0.27	0.006

Note) When used in the vacuum release, use 1-port for vacuum, and 3-port for vacuum release pressure.

Directional Control Valves
 Air Cylinders
 Rotary Actuators
 Air Grippers
 Air Preparation Equipment
 Modular F. R.
 Pressure Control Equipment
 Fittings & Tubing
 Flow Control Equipment
 Pressure Switches/Pressure Sensors

Manifold Options

Blanking plate assembly (for SS073A)

SS070A-10A (for separable base)

This assembly is mounted on a manifold block where the valve is removed for maintenance or a replacement valve is going to be mounted.

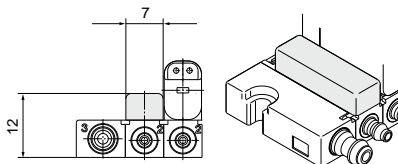

Blanking plate assembly (for SS073B)

SS070B-10A (for bar base)

This assembly is mounted on a manifold block where the valve is removed for maintenance or a replacement valve is going to be mounted.

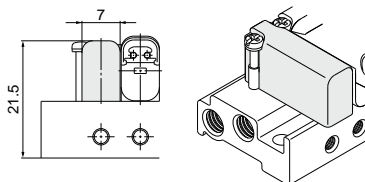

Intermediate block assembly (for SS073A)

SS070A-B (for separable base)

This assembly is used to secure the manifold when a large number of stations are manifolded. (Accommodated as one station.)
 * In the manifold specification sheet, specify the position where the block assembly is mounted.

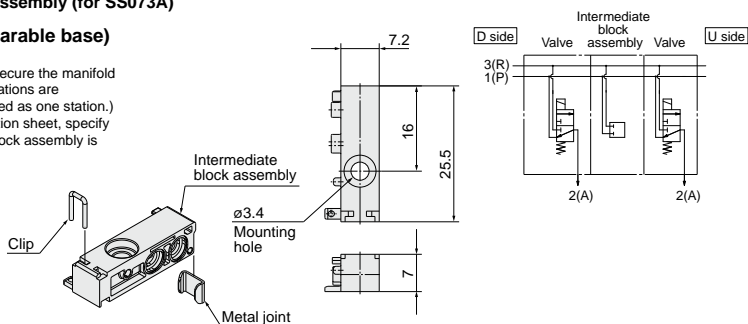

Intermediate block assembly (for SS073M)

SS070M-B (for stacking type)

This assembly is used to secure the manifold when 20 or more stations are manifolded. (Accommodated as one station.)
 * In the manifold specification sheet, specify the position where the block assembly is mounted.

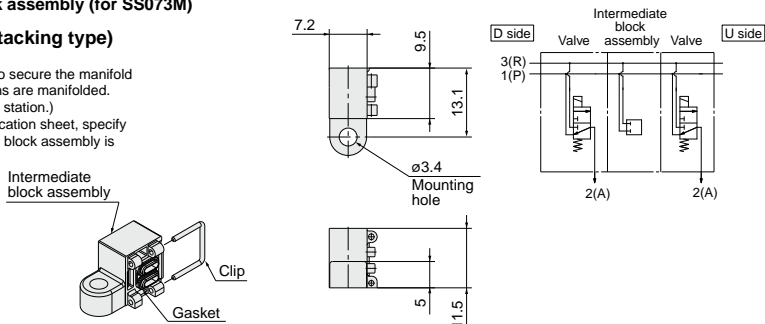

Series 10-S070

Exploded View of Stacking Type

Body Ported Type/SS073M01-□C Exploded View of Stacking Type

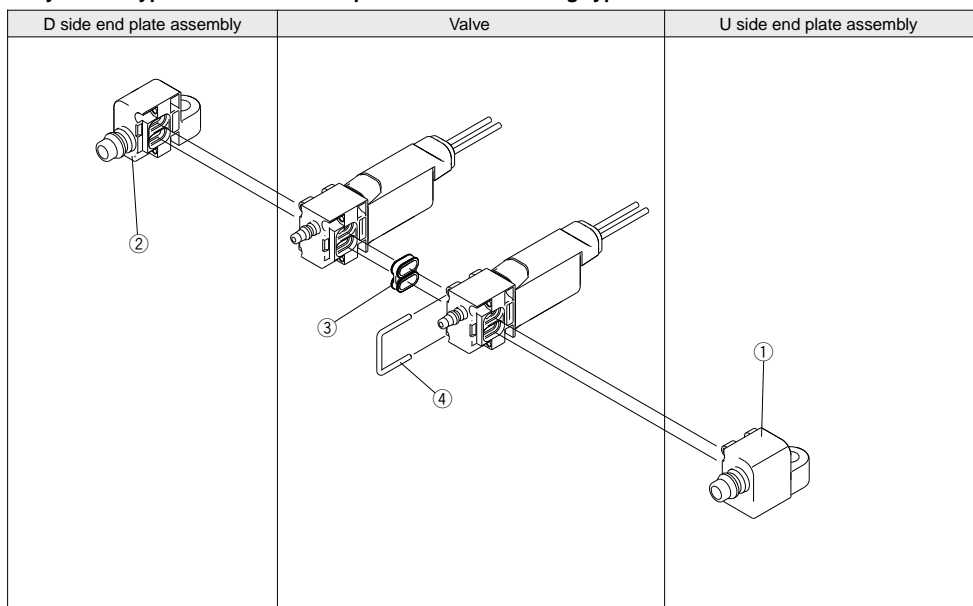

< U Side End Plate Assembly >

① U side end plate assembly no.

SS070M01-2A

< D Side End Plate Assembly >

② D side end plate assembly no.

SS070M01-3A

Replacement Parts

No.	Part no.	Description	Material	Qty.
③	S070M-80A-1	Gasket	FKM	10
④	SS070M-80A-2	Clip	Stainless steel	10

Directional
Control Valves

Air Cylinders

Rotary Actuators

Air Grippers

Air Preparation
Equipment

Modular F. R.

Pressure Control
Equipment

Fittings & Tubing

Flow Control
Equipment

Pressure Switches/
Pressure Sensors

Series 10-S070

Exploded View of Separable Base

Base mounted/SS073A□-□C Exploded View of Separable Base

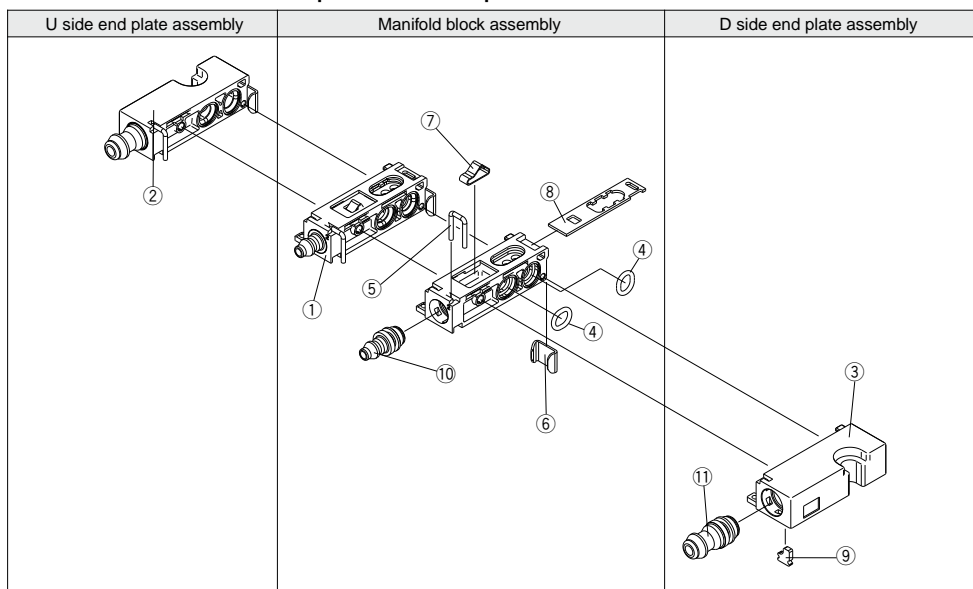

< Manifold Block Assembly >

① Manifold block assembly no.

SS070A 01 -1A

Port size

01	With $\phi 3.18/\phi 2$ barb fitting
02	With $\phi 4/\phi 2.5$ barb fitting

< U Side End Plate Assembly >

② U side end plate assembly no.

SS070A01-2A

< D Side End Plate Assembly >

③ D side end plate assembly no.

SS070A01-3A

< Replacement Parts for Manifold Block >

Replacement Parts

No.	Part no.	Description	Material	Qty.
④	SS070A-80A-1	O-ring	FKM	10
⑤	SS070A-80A-2	Clip	Stainless steel	10
⑥	SS070A-80A-3	Metal joint	Stainless steel	10
⑦	SS070A-80A-4	Leaf spring	Stainless steel	10
⑧	SS070A-80A-5	Mounting bracket	Stainless steel	10

< Replacement Parts for U/D Side End Plate >

Replacement Parts

No.	Part no.	Description	Material	Qty.
⑨	SS070A-80A-6	Stopper plate	Stainless steel	10

< Barb Fitting Assembly >

⑩ Barb fitting assembly (for cylinder port)

SS070-50A-32

Port size

20	Applicable tubing $\phi 2/\phi 1.2$
32	Applicable tubing $\phi 3.18/\phi 2$
40	Applicable tubing $\phi 4/\phi 2.5$

Note) Order is accepted in 10 units.

① Barb fitting assembly (for 1(P), 3(R) ports)

SS070-51A-60

Applicable tubing $\phi 6/\phi 4$

Note) Order is accepted in 10 units.



Series 10-S070

Specific Product Precautions 1

Be sure to read this before handling.

Refer to page 1382 for Safety Instructions and pages 677 to 683 for 3/4/5 Port Solenoid Valve Precautions.

Caution

Valve Mounting/Removal

1) Base mounted with screws

With the base mounted type fixed with screws, confirm the installation of the gasket mounted on the body interface and fasten the dedicated mounting screws (AXT632-106-1) at an appropriate torque (0.10 to 0.14 N·m). (Fasten equally so that the valve will not tilt.)



2) Base mounted with clips

① Hook a flat head watchmakers' screwdriver into the hole of the mounting bracket and pull it approximately 1 mm in the direction indicated by the arrow. ② Insert the solenoid valve from above. After confirming that the bottom surface of the solenoid valve contacts the top surface of the manifold, detach the flat head screwdriver from the mounting bracket while holding the solenoid valve body. (Before mounting, confirm the installation of the interface gasket on the solenoid valve body.)

The built-in leaf spring returns the mounting bracket to its original position. (Then confirm that the end of the mounting bracket is aligned with the side of the manifold block. Refer to the figure below.)

Similarly, to remove the valve, pull the mounting bracket and pull up the solenoid valve vertically. Use caution so that no excessive force is applied to the lead wire in mounting and removal.

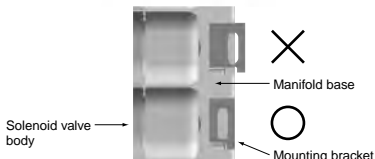
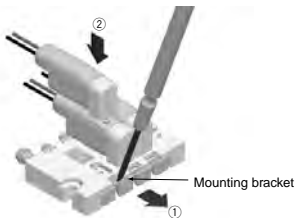

Caution

Screwing in M5/M3 Thread

After tightening by hand, tighten an additional 1/4 turn for M3 and 1/6 turn for M5. Overtightening may cause bending of the thread or air leakage due to deformation of the gasket. Insufficient screwing may cause loosening of the thread or air leakage.

Applicable Tubing Size

Stacking manifold

Port	Applicable tubing	Recommended tubing
1 (SUP), 3 (EXH)	$\phi 6/\phi 4$	TS0604/TU0604
	$\phi 4/\phi 2.5$	TS0425/TU0425
2 (OUT)	$\phi 3.18/\phi 2$	TIUB01

Note) In case of a body ported single unit valve, the applicable tubing size is $\phi 3.18/\phi 2$ for all 1 (SUP), 2 (OUT), and 3 (EXH) ports.

If fittings of a brand other than SMC are used, follow the specifications of the fittings to be mounted.

Tubing Installation (With barb fitting)

- Using tube cutters TK-1, 2, or 3, cut the tubing perpendicularly to the tubing axis while allowing for sufficient margin to the required length.
- Insert the tubing and push it all the way to the barb end. If the tubing is not installed securely to the end, problems such as leakage or disconnection of the tubing can occur.
- When the tubing is inserted into the barb fitting, push it in the direction of the tubing axis to prevent excessive lateral loads being applied to the barb fitting.

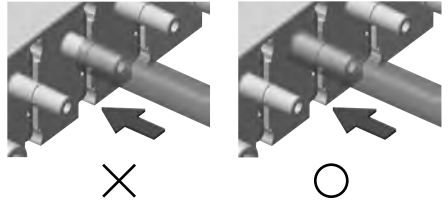

- To remove the tubing from the barb fitting, use caution so that no excessive lateral load will be applied to the barb fitting. When using a cutter to remove the tubing, sufficient care should be taken so as not to make any flaws on the barb fitting.
- After tubing installation, avoid excessive loads, such as tensile, compressive, or bending strength, being applied to the tubing.

Directional Control Valves

Air Cylinders

Rotary Actuators

Air Grippers

Air Preparation Equipment

Modular F. R.

Pressure Control Equipment

Fittings & Tubing

Flow Control Equipment

Pressure Switches/ Pressure Sensors



Series 10-S070

Specific Product Precautions 2

Be sure to read this before handling.

Refer to page 1382 for Safety Instructions and pages 677 to 683 for 3/4/5 Port Solenoid Valve Precautions.

Caution Mounting

1) Solenoid valve fixing procedure (body ported single unit)

When mounting a body ported type single unit valve, tighten the dedicated mounting screw (AXT632-106A-2) at an appropriate torque (0.05 to 0.07 N-m) to firmly secure the valve body. (Tighten equally so that the valve will not tilt.) If the coil is fixed, the coil joint may break due to application of an excessive load to the tubing body, for example, when the tubing is inserted. With a base mounted type solenoid valve also, use caution to avoid excessive loads on the coil and lead wire.

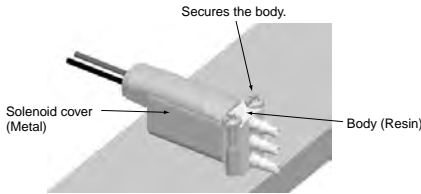

Caution Adding and Removing Manifold Stations

1) Base mounted stacking type

- 1) Remove the clip and metal joint from the position where the new station is to be mounted by pulling them in the directions indicated by the arrows.
- 2) Place the additional manifold block assembly and mount the metal joint and clip by reversing the assembly order. Securely insert the clip and the metal joint so that they will not protrude from the top and bottom surfaces respectively.

The clip is commonly used to secure the manifold block and fittings.

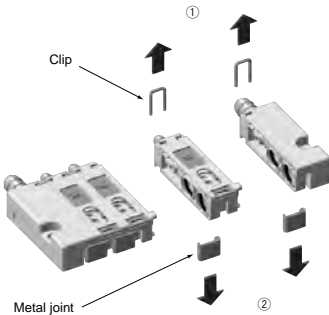

To remove the station, follow the same procedure for assembly and disassembly.

2) Body ported manifold type

- 1) Remove the clip on the position where the station is to be added by pulling it in the direction indicated by the arrow. (Insert a flat head screwdriver in the recess indicated in the figure to remove the clip.)
 - 2) Place the additional solenoid valve into the separation and insert the clip.
- Insert the clip until it fits in the groove on the body side.

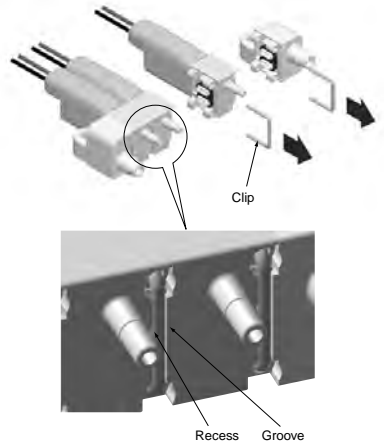

Caution Vacuum Application

An N.C. type valve pressurized at 1 (SUP) port can be used within the maximum operating pressure differential specified for the product. If the valve is to be used in the following applications, however, care should be taken about the piping ports, maximum operating pressure differential and allowable leakage.

1) Vacuum release application

Use 3 (R) port for vacuum pressure and 1 (P) port for vacuum release pressure. The pressure differential between 3 (R) and 1 (P) is the maximum operating pressure differential for each type.

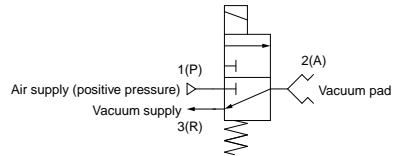

2) Vacuum retention

Please consult SMC if the allowable leakage is limited when the valve is used for vacuum retention of a vessel, even within the low vacuum range (1.33 x 10² Pa or above).



Series 10-S070

Specific Product Precautions 3

Be sure to read this before handling.

Refer to page 1382 for Safety Instructions and pages 677 to 683 for 3/4/5 Port Solenoid Valve Precautions.

Caution Wiring

1) Internal wiring

- Grommet
(This solenoid valve has no polarity.)



- With light/surge voltage suppressor
(This solenoid valve has no polarity.)

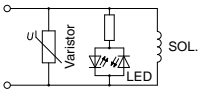

- With 0.1 W power saving circuit

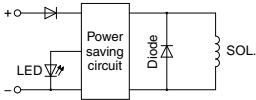

2) Electrical circuit

- (1) Adopt an electrical circuit with no chattering generated at the contact.
- (2) Keep the voltage within the $\pm 10\%$ range of the rated voltage.
Care should be taken about the voltage drop when the rated voltage is 6 VDC or less or when the response speed is important.
- (3) When using a C-R element (surge voltage suppressor) for protection of the switching element, please keep in mind that leakage voltage will increase due to leakage current flowing through the C-R element.

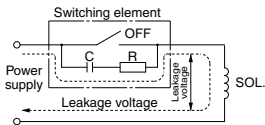

Keep the residual leakage voltage with 2% of the rated voltage.

- (4) Be sure to confirm the applied voltage. If a wrong voltage is applied, it can lead to malfunction or coil burning.
- (5) In wiring, use caution to avoid application of excessive force to the lead wire. It can cause malfunction or break the coil.

Caution Power Saving Circuit of 0.1 W (At holding)

- 1) The power consumption is 0.35 W at inrush (100 ms) and 0.1 W at holding.

Directional Control Valves

Air Cylinders

Rotary Actuators

Air Grippers

Air Preparation Equipment

Modular F. R.

Pressure Control Equipment

Fittings & Tubing

Flow Control Equipment

Pressure Switches/ Pressure Sensors



3/4/5 Port Solenoid Valves Precautions 1

Be sure to read this before handling.

Design/Selection

Warning

1. Confirm the specifications.

Products represented in this catalog are designed only for use in compressed air systems (including vacuum). Do not operate at pressures or temperatures, etc., beyond the range of specifications, as this can cause damage or malfunction. (Refer to the specifications.)

Please contact SMC when using a fluid other than compressed air (including vacuum).

We do not guarantee against any damage if the product is used outside of the specification range.

2. Actuator drive

When an actuator, such as a cylinder, is to be driven using a valve, take appropriate measures (cover installation or approach prohibition) to prevent potential danger caused by actuator operation.

3. Intermediate stops

For 3-position closed center or double check valve type, it is difficult to make a piston stop at the required position accurately due to the compressibility of air.

Furthermore, since valves and cylinders are not guaranteed for zero air leakage, it may not be possible to hold a stopped position for an extended period of time.

Please contact SMC if it is necessary to hold a stopped position for an extended period of time.

4. Effect of back pressure when using a manifold

Use caution when valves are used on a manifold, because an actuator may malfunction due to back-pressure.

For 3-position exhaust center valve or single acting cylinder, take appropriate measures to prevent malfunction by using it with an individual EXH spacer assembly, a back pressure check valve or an individual exhaust manifold.

Also, since the SQ1000 4-position dual 3 port valves is 4 port valve specification (R1 and R2 are common), one back pressure check valve can be installed. As a result, back pressure from valves in other stations can be prevented, but back pressure inside this valve cannot be prevented.

5. Holding pressure (including vacuum)

Since the valves are subject to air leakage, they cannot be used for applications such as holding pressure (including vacuum) in a pressure vessel.

6. Not suitable for use as an emergency shut-off valve, etc.

The valves listed in this catalog are not designed for safety applications such as an emergency shutoff valve. If the valves are used for the mentioned applications, additional safety measures should be adopted.

7. Release of residual pressure

For maintenance purposes install a system for releasing residual pressure. Especially for 3-position closed center valve or double check valve type, ensure that the residual pressure between the valve and the cylinder is released.

8. Operation in a vacuum condition

When a valve is used for switching a vacuum, take measures to install a suction filter or similar to prevent external dust or other foreign matter from entering inside the valve.

In addition, at the time of vacuum adsorption, be sure to vacuum at all times. Failure to do so may result in foreign matter sticking to the adsorption pad, or air leakage causing the workpiece to drop.

9. Regarding a vacuum switch valve and a vacuum release valve

If a non-vacuum valve is installed in the middle of piping system having a vacuum, the vacuum condition will not be maintained. Use a valve designed for use under vacuum condition.

10. Double solenoid type

When using the double solenoid type for the first time, actuators may travel in an unexpected direction depending on the switching position of the valve. Implement measures to prevent any danger from occurring when operating the actuator.

11. Ventilation

Provide ventilation when using a valve in a confined area, such as in a closed control panel. For example, install a ventilation opening, etc. in order to prevent pressure from increasing inside of the confined area and to release the heat generated by the valve.

12. Extended periods of continuous energization

- If a valve will be continuously energized for an extended period of time, the temperature of the valve will increase due to the heat generated by the coil. This will likely adversely affect the performance of the solenoid valve and any nearby peripheral equipment. Therefore, when it is continuously energized for an extended period of time or when the energized period per day is longer than the de-energized period, use the SY series DC specifications or power saving circuit type. As a valve not mentioned above can also be used depending on the operating conditions (in particular, DC specification valves), please contact SMC for further information. Additionally, use of a valve with the N.O. (normally open) specifications makes it possible to shorten the energized time.

- For applications such as mounting a valve on a control panel, incorporate measure to limit the heat radiation so that it is within the operating temperature range. Do not touch the valves by bare hand during or after energization. For example, the temperature will be high when a 3 station manifold or larger is put next to other valves and continuously energized or the long and continuous energization on both the A and B sides (simultaneous) of the SY, SJ, SZ, SV, VQ, SQ series dual 3 port valves.

13. Do not disassemble the product or make any modifications, including additional machining.

It may cause human injury and/or an accident.



3/4/5 Port Solenoid Valves Precautions 2

Be sure to read this before handling.

Design/Selection

Warning

Latching Type [VQ/SQ series double (latching) type]

The latching solenoid is equipped with a self-holding mechanism, which permits a movable iron core in the solenoid to hold the Set position or Reset position during momentary energization (20 ms or longer), there is no need for continuous energization. Depending on conditions, continuous energization may cause a rise in the coil temperature resulting in malfunction.

<Special precaution to be taken with the latching type>

- Do not continuously energize the latching type.
When it is necessary to energize it continuously, keep the energized period to 10 minutes or less, and then leave a deenergized period (on both the A side and B side) lasting longer than the energized period, before operating it again. The duty ratio should be 50% or less.

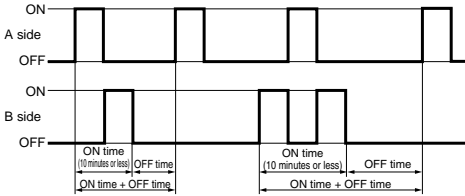

- Maximum ON time is 10 minutes.
- Duty ratio $\leq 50\%$ (Duty ratio = $\frac{\text{ON time}}{\text{ON time} + \text{OFF time}}$)

Example: When energization lasts for five minutes, it should be followed by five or more minutes of deenergization. Because the latching type has only one solenoid, both the A side and B side should be off for five minutes or more.

However, a minimum energization time of 20 msec is recommended. [Ambient temperature]

The product should be installed in an environment with an ambient temperature of -10° to 50°C . Especially in environments with poor heat dissipation, such as installing in a panel, the heat of the coil can cause the ambient temperature to rise, so please exercise caution.

- Use a circuit in which the Set and Reset signals will not be energized at the same time.
- The minimum energization time for self-holding is 20 ms.
- Even when there is no problem with normal operations and locations, please consult with SMC before using in locations with a vibration of 30 m/s^2 or more, or a strong magnetic field.
- Even though this valve is held on to reset position (passage: A \rightarrow R), it may switch to the Set position during transportation, or due to impact when mounting valves, etc. Therefore, check the initial position by means of power supply or manual override prior to use.

Latching	Passage	Indicator light	Single	Passage	Indicator light
A-C ON (set)	P \rightarrow A	Orange	A-C ON	P \rightarrow A	Orange
B-C ON (reset)	A \rightarrow R	Green	OFF	A \rightarrow R	—

Caution

1. Precautions on 2-position double solenoid valve

If a double solenoid valve is operated with momentary energization, it should be energized for at least 0.1 second. However, depending on the piping conditions, the cylinder may malfunction even when the double solenoid valve is energized for 0.1 second or longer. In this case, energize the double solenoid valve until the cylinder is exhausted completely.

2. Leakage voltage

Take note that the leakage voltage will increase when a resistor is used in parallel with switching element or a C-R circuit (surge voltage suppressor) is used for protecting a switching device because of the passing leakage voltage through the C-R circuit. The suppressor residual leakage voltage should be as follows.

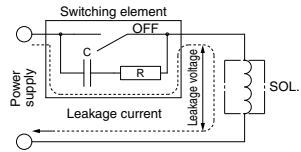

DC coil

- SV, SY, SYJ, SX, SZ, SJ, VV061 (V060), VQ (V100), VQC (V100), SQ (V100), VQZ, VF, VFR, VFS, VP7, VS7, VP300, VP500, VP700, VT307, VG342 } 3% or less of rated voltage
- VQD, VZ, VZS, VK, VT317, VT325 } 2% or less of rated voltage
- VT301, VT315, VP31□5, VP4□50, VP4□70 } 5% or less of rated voltage

AC coil

- VK, VFR, VFS, VP7, VS7, VT317 } 20% or less of rated voltage
- VZ, VZS, VT307, VG342, VT301, VT315, VT325, VP31□5, VT4□50, VP4□70 } 15% or less of rated voltage
- SY, SYJ, VQZ, VF, VP300, VP500, VP700, VQ (V100) } 8% or less of rated voltage

Directional Control Valves

Air Cylinders

Rotary Actuators

Air Grippers

Air Preparation Equipment

Modular F. R.

Pressure Control Equipment

Fittings & Tubing

Flow Control Equipment

Pressure Switches/ Pressure Sensors



3/4/5 Port Solenoid Valves Precautions 3

Be sure to read this before handling.

Design/Selection

⚠ Caution

3. Solenoid valve drive for AC with a solid state output (SSR, TRIAC output, etc.)

- 1) Current leakage
When using a snubber circuit (C-R element) for surge protection of the output, a very small amount of electrical current will continue to flow even during the OFF state. This results in the valve not returning. In a situation where the tolerance is exceeded, as in the above case, take measures to install a bleeder resistor.
 - 2) Minimum allowable load amount (Min. load current)
When the consumption current of a valve is less than the output's minimum allowable load volume or the margin is small, the output may not switch normally. Please contact SMC.
 - 3) Solenoid valve with full wave rectifier circuit
When the solenoid valve built-in full wave rectifier circuit with the AC specifications is used, the solenoid valve return failure may occur depending on the kind of the triac output circuit. Carefully check this point when selecting a SSR or sequencer.
- For details, contact the SSR or sequencer manufacturer.

4. Surge voltage suppressor

- 1) A surge voltage suppressor built into the valve is intended to protect the output contacts so that the surge generated inside valve does not adversely affect the output contacts. Therefore, if an overvoltage or overcurrent is received from an external peripheral device, the surge voltage protection element inside the valve is overloaded, causing the element to break. In the worst case, the electric circuit enters the short-circuit status by the breakage. If the energizing continues in this status, a large current flows. This may cause secondary damage to the output circuit, external peripheral device, or valve, and may also cause fire accident. So, take appropriate protective measures, such as installation of an overcurrent protection circuit in the power supply or drive circuit to maintain the sufficient safety.
 - 2) If a surge protection circuit contains non-standard diodes, such as Zener diodes or varistor, a residual voltage that is in proportion to the protective circuit and the rated voltage will remain. Therefore, take into consideration the surge voltage protection of the controller.
- For diodes, the residual voltage is approximately 1 V.

5. Surge voltage intrusion

Applicable series (non-polar type solenoid valves)

VQ100 and 3/4/5 port solenoid valves VQ(C), VQZ, VQD (2 W type) series

SY100, V100, and 3/4/5 port solenoid valves SY, SYJ, SX, SZ, SV, SJ, VF, VP series

With non-polar type solenoid valves, at times of sudden interruption of the loading power supply, such as emergency shutdown, surge voltage intrusion may be generated from loading equipment with a large capacity (power consumption), and the solenoid valve in a deenergized state may switch over (see Fig.1).

When installing a breaker circuit for the loading power supply, consider using a solenoid valve with polarity (with polarity protection diode), or install a surge absorption diode between the loading equipment COM line and the output equipment COM line (see Fig.2).

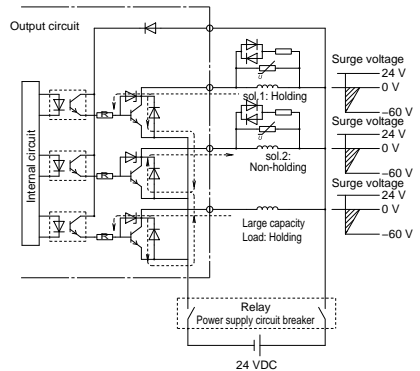

Fig.1 Surge intrusion circuit example (NPN outlet example)

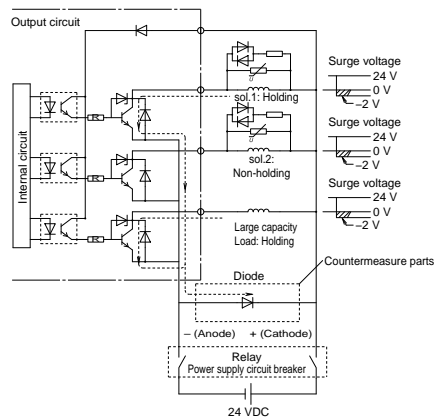

Fig.2 Surge intrusion countermeasure example (NPN outlet example)



3/4/5 Port Solenoid Valves Precautions 4

Be sure to read this before handling.

Design/Selection

⚠ Caution

6. Operation in a low temperature condition

It is possible to operate a valve in extreme temperature, as low as -10°C . Take appropriate measures to avoid freezing of drainage, moisture etc. in low temperature.

7. Operation for air blowing

When using a solenoid valve for air blowing, use an external pilot type.

Use caution because the pressure drop caused by the air blowing can have an effect on the internal pilot type valve when the internal pilot type valves and external pilot type valves are used on the same manifold.

Additionally, when compressed air within the pressure range of the established specifications is supplied to the external pilot type valve's port, and a double solenoid valve is used for air blowing, the solenoids should normally be energized when air is being blown.

8. Mounting orientation

Rubber seal: Refer to the specifications of each series. Please consult with SMC for models not indicated in the specification column.

Metal seal: Mounting orientation of a single solenoid is universal. No specific orientation is necessary. When installing a double solenoid or a 3-position configuration, mount the valve so that spool valve is horizontal.

9. Initial lubrication of main valve

The following initial lubricant has already been applied to the main valve.

- **Rubber seal, spool valve: Grease**
Please consult with SMC, as there are some standard valve products that use fluorine grease for food processing equipment (NSF H-1).
- **Metal seal, spool valve: Turbine oil**
Turbine oil is applied to the spool valve of a metal seal type. Therefore, turbine oil may seep out when a new product is delivered, or while the valve is stored.

Mounting

⚠ Warning

1. Operation manual

Install the products and operate them only after reading the operation manual carefully and understanding its contents. Also, keep the manual where it can be referred to as necessary.

2. Ensure sufficient space for maintenance activities.

When installing the products, allow access for maintenance.

3. Tighten threads with the proper tightening torque.

When installing the products, follow the listed torque specifications.

4. If air leakage increases or equipment does not operate properly, stop operation.

Check mounting conditions when air and power supplies are connected. Initial function and leakage tests should be performed after installation.

5. Painting and coating

Warnings or specifications printed or affixed to the product should not be erased, removed or covered up.

Please consult with SMC before applying paint to resinous parts, as this may have an adverse effect due to the solvent in the paint.

Piping

⚠ Caution

1. Refer to the Fittings and Tubing Precautions (pages 1237 to 1240) for handling One-touch fittings.

2. Preparation before piping

Before piping is connected, it should be thoroughly flushed out with air or washed to remove chips, cutting oil and other debris from inside the pipe.

3. Winding of sealant tape

When screwing piping or fittings into ports, ensure that chips from the pipe threads or sealing material do not enter the piping. Also, if sealant tape is used, leave 1 thread ridge exposed at the end of the threads.

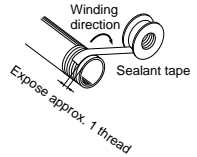

4. Closed center and double check valve types

For closed center or double check valve types, check the piping to prevent air leakage from the piping between the valve and the cylinder.

5. Connection of pipings and fittings

When screwing the piping or fitting into the valve, tighten it as follows.

1) When using SMC's M3, M5, M6, or 10-32UNF fitting, follow the procedures below to tighten it.

● Connection thread: M3

First, tighten by hand, then use a wrench appropriate for the hexagon flats of the body to tighten an additional 1/4 turn.

A reference value for the tightening torque is 0.4 to 0.5 N·m.

● Connection thread: M5 and 10-32UNF

First, tighten by hand, then use a wrench appropriate for the hexagon flats of the body to tighten an additional 1/6 to 1/4 turn.

A reference value for the tightening torque is 1 to 1.5 N·m.

● M6

First, tighten by hand, then use a wrench appropriate for the hexagon flats of the body to tighten an additional 1/6 to 1/4 turn.

Note) Excessive tightening may damage the thread portion or deform the gasket and cause air leakage.

Insufficient tightening may loosen the threads, or cause air leakage.

● When using a fitting other than SMC fitting, follow the instructions given by relevant fitting manufacturer.

2) For the fitting with sealant R or NPT, first, tighten it by hand, then use a wrench appropriate for the hexagon flats of the body to tighten it a further two or three turns. For a tightening torque guide, refer to the table below.

Connection thread size (R, NPT)	Proper tightening torque (N·m)
1/8	3 to 5
1/4	8 to 12
3/8	15 to 20
1/2	20 to 25
3/4	28 to 30
1	36 to 38
1 1/4	40 to 42
1 1/2	48 to 50
2	48 to 50

Directional Control Valves

Air Cylinders

Rotary Actuators

Air Grippers

Air Preparation Equipment

Modular F. R.

Pressure Control Equipment

Fittings & Tubing

Flow Control Equipment

Pressure Switches/Pressure Sensors



3/4/5 Port Solenoid Valves Precautions 5

Be sure to read this before handling.

Piping

⚠ Caution

- 3) If the fitting is tightened with excessive torque, a large amount of sealant will seep out. Remove the excess sealant.
- 4) Insufficient tightening may cause seal failure, or loosen the threads.
- 5) Reuse
 - (1) Normally, fittings with a sealant can be reused 2 to 3 times.
 - (2) To prevent air leakage through the sealant, remove any loose sealant stuck to the fitting by blowing air over the threaded portion.
 - (3) If the sealant no longer provides effective sealing, wind sealing tape over the sealant before reusing. Do not use the sealant in any form other than a tape type.
 - (4) Once the fitting has been tightened, backing it out to its original position often causes the sealant to become defective. Air leakage will occur.

6. Uni thread fittings

- 1) First, tighten the threaded portion by hand, then use a proper wrench, which could be suitable for the width across flats of the hexagon body, to tighten it further at a wrench tightening angle shown below. As a reference value for the tightening torque, refer to the table below.

Connection Female Thread: Rc, NPT, NPTF

Uni thread size	Wrench tightening angle after tightened by hand (deg)	Tightening torque (N·m)
1/8	30 to 60	3 to 5
1/4	30 to 60	8 to 12
3/8	15 to 45	14 to 16
1/2	15 to 30	20 to 22

Connection Female Thread: G

Uni thread size	Wrench tightening angle after tightened by hand (deg)	Tightening torque (N·m)
1/8	30 to 45	3 to 4
1/4	15 to 30	4 to 5
3/8	15 to 30	8 to 9
1/2	15 to 30	14 to 15

- 2) The gasket can be recycled up to 6 to 10 times. It can be replaced easily when it has sustained damage. A broken gasket can be removed by holding it and then turning it in the same direction as loosening the thread. If gasket is difficult to remove, cut it with nippers, etc. In such a case, use caution not to scratch the seat face because the seat face of 45° gasket of fitting is the sealing face.

7. Piping to products

When piping to a product, refer to the operation manual to avoid mistakes regarding the supply port, etc.



3/4/5 Port Solenoid Valves Precautions 6

Be sure to read this before handling.

Wiring

⚠ Warning

1. The solenoid valve is an electrical product. For safety, install an appropriate fuse and circuit breaker before use.

⚠ Caution

1. Polarity

When connecting power to a solenoid valve with a DC specification and equipped with a light or surge voltage suppressor, check for polarity.

If there is polarity, take note of the following.

No diode to protect polarity:

If a mistake is made regarding the polarity, damage may occur to the diode in the valve, the switching element in a control device or power supply equipment, etc.

With diode to protect polarity:

If polarity connection is wrong, the valve does not operate.

2. Applied voltage

When electric power is connected to a solenoid valve, be careful to apply the proper voltage. Improper voltage may cause malfunction or coil damage.

3. Check the connections.

Check if the connections are correct after completing all wiring.

4. External force applied to lead wire

If an excessive force is applied to the lead wire, this may cause faulty wiring. Take appropriate measures so that a force of 30 N or more is not applied to the lead wire.

When instructions are given to the Specific Product Precautions, follow these specifications.

Lubrication

⚠ Warning

1. Lubrication

[Rubber seal]

- 1) All valves except those listed below have been lubricated for life by the manufacturer and therefore, do not require lubrication while in service.

Valves to be lubricated
VP4□50, VP4□70, VP31□5, VPA4□50, VPA4□70, VPA31□5;

- 2) If a lubricant is used in the system, use class 1 turbine oil (no additive), ISO VG32. For details about lubricant manufacturers' brands, refer to the SMC website. Additionally, please contact SMC for details about class 2 turbine oil (with additives) ISO VG32.

Once lubricant is utilized within the system, since the original lubricant applied within the product during manufacturing will be washed away, please continue to supply lubrication to the system. Without continued lubrication, malfunctions could occur.

If turbine oil is used, refer to the corresponding Material Safety Data Sheet (MSDS).

[Metal seal]

- 1) These valves can be used without lubrication.
- 2) If a lubricant is used in the system, use class 1 turbine oil (no additive), ISO VG32. For details about lubricant manufacturers' brands, refer to the SMC website. Additionally, please contact SMC for details about class 2 turbine oil (with additives) ISO VG32.

Lubrication

⚠ Warning

2. Lubrication amount

If the lubrication amount is excessive, the oil may accumulate inside the pilot valve, causing malfunction or response delay. So, do not apply a large amount of oil. When a large amount of oil needs to be applied, use an external pilot type to put the supply air on the pilot valve side in the non-lube state. This prevents accumulation of oil inside the pilot valve.

Air Supply

⚠ Warning

1. Type of fluids

Please consult with SMC when using the product in applications other than compressed air.

2. When there is a large amount of drainage.

Compressed air containing a large amount of drainage can cause malfunction of pneumatic equipment. An air dryer or water separator should be installed upstream from filters.

3. Drain flushing

If condensation in the drain bowl is not emptied on a regular basis, the bowl will overflow and This may cause malfunction of pneumatic equipment.

If the drain bowl is difficult to check and remove, installation of a drain bowl with an auto drain option is recommended.

For compressed air quality, refer to SMC Best Pneumatics catalog.

4. Use clean air.

Do not use compressed air that contains chemicals, synthetic oils including organic solvents, salt or corrosive gases, etc., as it can cause damage or malfunction.

⚠ Caution

1. When extremely dry air is used as the fluid, degradation of the lubrication properties inside the equipment may occur, resulting in reduced reliability (or reduced service life) of the equipment. Please consult with SMC.

2. Install an air filter.

Install an air filter upstream near the valve. Select an air filter with a filtration size of 5 μm or smaller.

3. Take measures to ensure air quality, such as by installing an aftercooler, air dryer, or water separator.

Compressed air that contains a large amount of drainage can cause malfunction of pneumatic equipment such as valves. Therefore, take appropriate measures to ensure air quality, such as by providing an aftercooler, air dryer, or water separator.

4. If excessive carbon powder is seen, install a mist separator on the upstream side of the valve.

If excessive carbon dust is generated by the compressor, it may adhere to the inside of a valve and cause it to malfunction. For compressed air quality, refer to SMC Best Pneumatics catalog.

Directional Control Valves

Air Cylinders

Rotary Actuators

Air Grippers

Air Preparation Equipment

Modular F. R.

Pressure Control Equipment

Fittings & Tubing

Flow Control Equipment

Pressure Switches/Pressure Sensors



3/4/5 Port Solenoid Valves Precautions 7

Be sure to read this before handling.

Operating Environment

Warning

1. Do not use in an atmosphere having corrosive gases, chemicals, sea water, water, water steam, or where there is direct contact with any of these.
2. Products with IP65 and IP67 enclosures (based on IEC60529) are protected against dust and water, however, these products cannot be used in water.
3. Products compliant to IP65 and IP67 satisfy the specifications through mounting. Be sure to read the Precautions for each product.
4. Do not use in an environment where flammable gas or explosive gas exists. Usage may cause a fire or explosion. The products do not have an explosion proof construction.
5. Do not use in a place subject to heavy vibration and/or impact.
6. The valve should not be exposed to prolonged sunlight. Use a protective cover. Note that the valve is not for outdoor use.
7. Remove any sources of excessive heat.
8. If it is used in an environment where there is possible contact with oil, weld spatter, etc., exercise preventive measures.
9. When the solenoid valve is mounted in a control panel or its energized for a long time, make sure ambient temperature is within the specifications of the valve.

Caution

1. **Temperature of ambient environment**
Use the valve within the range of the ambient temperature specifications of each valve. In addition, pay attention when using the valve in environments where the temperature changes drastically.
2. **Humidity of ambient environment**
 - When using the valve in environments with low humidity, take measures to prevent static.
 - If the humidity rises, take measures to prevent the adhesion of water droplets on the valve.

Maintenance

Warning

1. **Perform maintenance inspection according to the procedures indicated in the operation manual.**
If handled improperly, malfunction and damage of machinery or equipment may occur.
2. **Removal of equipment, and supply/exhaust of compressed air**
When components are removed, first confirm that measures are in place to prevent workpieces from dropping, run-away equipment, etc. Then, cut off the supply air and electric power, and exhaust all air pressure from the system using the residual pressure release function.
For 3-position closed center or double check valve type, exhaust the residual pressure between the valve and the cylinder.
When the equipment is operated after remounting or replacement, first confirm that measures are in place to prevent lurching of actuators, etc. Then, confirm that the equipment is operating normally.
In particular, when a 2-position double solenoid valve is used, releasing residual pressure rapidly may cause the spool valve malfunction depending on the piping conditions, and the connected actuator may operate.
3. **Low frequency operation**
Valves should be operated at least once every 30 days to prevent malfunction. (Use caution regarding the air supply.)
4. **Manual override**
When the manual override is operated, connected equipment will be actuated.
Operate after safety is confirmed.
5. **If the volume of air leakage increases or the valve does not operate normally, do not use the valve.**
Perform periodic maintenance of the valve to confirm the operating condition, and if there is any air leakage.

Caution

1. **Drain flushing**
Remove drainage from the air filters regularly. (Refer to the specifications.)
2. **Lubrication**
For rubber seals, once lubrication has been started, it must be continued.
Use class 1 turbine oil (with no additive), VG32. If other lubricant oil is used, it may cause malfunction. Please contact SMC for suggested class 2 turbine oil (with additive), VG32.
3. **Manual override operation**
When switching a double solenoid valve by the manual override operation, instantaneous operation may cause a malfunction of the cylinder. It is recommended that the manual override be held until the cylinder reaches the stroke end position.

For Clean Room

Air Cylinders

Contents	Series	Page
Air Cylinder Standard	10-/11- 21-/22- CJ2-Z	P.685
Air Cylinder Standard	10-/11- 21-/22- CJ2 * ø6: Current model	P.686
Air Cylinder Double Rod	10-/11- 21-/22- CJ2W-Z	P.695
Air Cylinder Direct Mount	10-/11- 21-/22- CJ2RA-Z	P.698
Air Cylinder Standard	10-/11- 21-/22- CM2-Z	P.700
Air Cylinder Double Rod	10-/11- 21-/22- CM2W-Z	P.709
Air Cylinder Direct Mount	10-/11- 21-/22- CM2R-Z	P.713
Air Cylinder With End Lock	10-/11- 21-/22- CBM2	P.716
Air Cylinder Standard	10-/11- 21-/22- CG1-Z	P.722
Air Cylinder Double Rod	10- 11- CG1W-Z	P.729
Air Cylinder Direct Mount	10- 11- CG1R-Z	P.733
Air Cylinder Standard	10-/11- 21-/22- CA2	P.736
Mini Free Mount Cylinder	10- 11- CUJ	P.740
Free Mount Cylinder	10-/11- 21-/22- CDU	P.746
Compact Cylinder/Compact Type	10-/11- 21-/22- CQS	P.749
Compact Cylinder	10-/11- 21-/22- CQ2-Z	P.758
Magnetically Coupled Rodless Cylinder/Basic Type	12-CY3B	P.767
Magnetically Coupled Rodless Cylinder/Direct Mount Type	12-CY3R	P.769
Clean Rodless Cylinder	CYP	P.773
Air Slide Table	13- 22- MXS	P.778
Air Slide Table	13- 22- MXQ	P.799
Air Slide Table	11- 22- MXJ	P.825
Air Slide Table	11- 22- MXP	P.831
Air Slide Table	11- 22- MXPJ6	P.831
Compact Guide Cylinder	12- 13- MGPL-Z	P.839
Guide Table	10-MGF	P.844
Dual Rod Cylinder/Compact Type	11-/12- 21-/22- CXSJ	P.848
Dual Rod Cylinder	10-/11-/12- 21-/22- CXS	P.852
Sine Rodless Cylinder	12-REA	P.861
Sine Cylinder	10- 11- REC	P.864
Low Speed Cylinder	10- 11- CM2X-Z	P.868
Low Speed Cylinder	10- 11- CQSX	P.870
Low Speed Cylinder	10- 11- CQ2X	P.872
Actuators Precautions		P.874
Auto Switches Precautions		P.879
Applicable Auto Switch List		P.889

Directional
Control Valves

Air Cylinders

Rotary Actuators

Air Grippers

Air Preparation
Equipment

Modular F. R.

Pressure Control
Equipment

Fittings & Tubing

Flow Control
Equipment

Pressure Switches/
Pressure Sensors

Series 10-/11-21-/22-CJ2-Z ϕ 10, ϕ 16 Air Cylinder



How to Order



Clean series

10	Relief type
11	Vacuum suction type

Cushion

Nil	Rubber bumper (Standard)
A	Air cushion

Built-in magnet

Nil	No
D	With auto switch (Built-in magnet)

* For a cylinder with "D", "-B" is suffixed to the end of the part number.

Mounting

B	Basic
E	Double-side bossed
L	Single foot
M	Double foot
F	Rod flange
G	Head flange

* Foot/Flange brackets are shipped together with the product, but not assembled.

Head cover port location

Nil	Perpendicular to axis
R	Axial

* For double-side bossed, the product is perpendicular to the cylinder axis.

Number of auto switches

Nil	2 pcs.
S	1 pc.
n	n pcs.

Auto switch

Nil	Without auto switch
-----	---------------------

* For applicable auto switches, refer to the Applicable Auto Switch.

Auto switch mounting type

Nil	None
B	Band mounting

* Only for With auto switch (Built-in magnet).
* Auto switch mounting method is band mounting only.

Cylinder stroke (mm)

Bore size (mm)

Copper, fluorine and silicone-free + Low particle generation

21	Relief type
22	Vacuum suction type

Model

10 - C D J 2 L 16 - 60 A R Z - M9BW - B

21 - C D J 2 L 16 - 60 R Z - M9BW - B

Model

Model	Bore size (mm)	Port size	Lubrication	Action	Standard stroke (mm)	Auto switch mounting	Cushion	
							Rubber	Air
Relief type 10-/21-CJ2□10	10	M5 x 0.8	Non-lube	Double acting, Single rod	15, 30, 45, 60, 75, 100, 125, 150	Band mounting only	Standard	○
	16				15, 30, 45, 60, 75, 100, 125, 150, 175, 200			
Vacuum suction type 10-/22-CJ2□10	10				15, 30, 45, 60, 75, 100, 125, 150			
	16				15, 30, 45, 60, 75, 100, 125, 150, 175, 200			

* Air cushion is not available for 21-/22-.

Specifications

Item	Bore size (mm)
Item	10/16
Proof pressure	1 MPa
Maximum operating pressure	0.7 MPa
Minimum operating pressure	0.08 MPa (Air cushion 0.1 MPa)
Ambient and fluid temperature	Without auto switch: -10°C to 70°C With auto switch: -10°C to 60°C (No freezing)
Piston speed	50 to 400 mm/s
Stroke length tolerance	$^{+1.0}$ ₀
Mounting	Basic/Double-side bossed/Single foot/Double foot/Rod flange/Head flange
Grease	10-/11-: Fluorine grease, 21-/22-: Lithium soap based grease
Cleanliness class (ISO class)	10-/21-: Class 4, 11-/22-: Class 3

Suction Flow Rate of Vacuum Suction Type (Reference values)

Size	Suction flow rate L/min (ANR)
10/16	1

Mounting Bracket Part No.

Mounting bracket	Bore size (mm)	
	10	16
Foot	CJ-L016C	CJK-L016C
Flange	CJ-F016C	CJK-F016C

Series 10-/11- 21-/22-CJ2

ø6 Air Cylinder

RoHS

How to Order

● Clean series

10	Relief type
11	Vacuum suction type

10 - C D J 2 L 6 - 60 R - M9BW - C

21 - C D J 2 L 6 - 60 R - M9BW - C

● Copper, fluorine and silicone-free + low particle generation

21	Relief type
22	Vacuum suction type

● Built-in magnet

Nil	No
D	With auto switch (Built-in magnet)

● Mounting

B	Basic
L	Axial foot
F	Rod flange

* Foot/Flange brackets are shipped together with the product, but not assembled.

● Cylinder stroke (mm)

● Head cover port location

R	Axial
---	-------

● Number of auto switches

Nil	2 pcs.
S	1 pc.
n	n pcs.

● Auto switch

Nil	Without auto switch
-----	---------------------

* For applicable auto switches, refer to the Applicable Auto Switch.
* The minimum stroke for auto switch mounting, operating range and auto switch mounting brackets/part no. are the same as standard products.
* Band mounting only.

● Auto switch mounting bracket ^{Note)}

Note) This symbol is indicated when the D-A9□ or M9□ type auto switch is specified. This mounting bracket does not apply to other auto switches (D-C7□ and H7□, etc.) (Nil)



Model

Model	Bore size (mm)	Port size	Lubrication	Action	Standard stroke (mm)	Auto switch mounting	Cushion Rubber
Relief type 10-/21-CJ2□6	6	M5 x 0.8	Non-lube	Double acting Single rod	15, 30, 45, 60	○	○
Vacuum suction type 11-/22-CJ2□6	6						

Specifications

Bore size (mm)		6
Item		
Proof pressure		1.05 MPa
Maximum operating pressure		0.7 MPa
Minimum operating pressure		0.14 MPa
Ambient and fluid temperature	Without auto switch: -10°C to 70°C, With auto switch: -10°C to 60°C (No freezing)	
Piston speed		50 to 400 mm/s
Stroke length tolerance		+1.0 0
Mounting		Basic/Axial foot/Rod flange
Grease	10-/11-: Fluorine grease, 21-/22-: Lithium soap based grease	
Cleanliness class (ISO class)	10-/21-: Class 4, 11-/22-: Class 3	

Suction Flow Rate of Vacuum Suction Type (Reference values)

Size	Suction flow rate L/min (ANR)
6	1

Mounting Bracket Part No.

Mounting bracket	Bore size (mm)
Foot	CJ-L010B
Flange	CJ-F010B

Directional Control Valves

Air Cylinders

Rotary Actuators

Air Grippers

Air Preparation Equipment

Modular F. R.

Pressure Control Equipment

Fittings & Tubing

Flow Control Equipment

Pressure Switches/Pressure Sensors

Applicable Auto Switch (Refer to the **WEB catalog** for detailed specifications and auto switches not in the following table.)

Type	Electrical entry	Indicator light	Wiring (Output)	Load voltage			Auto switch model	Lead wire length (m)				Applicable load	
				DC	5 V	12 V		AC	0.5 (Nil)	1 (M)	3 (L)		5 (Z)
Solid state auto switch	Grommet	Yes	2-wire	24 V	5 V	12 V	—	M9B	●	●	●	○	Relay, PLC
								M9BW	●	●	●	○	
Reed auto switch	Grommet	Yes	2-wire	24 V	12 V	100 V	A93	●	—	●	●		

Note 1) Lead wire length symbols: 0.5 m.....Nil M9BW
 1 m.....M M9BWM
 3 m.....L M9BWL
 5 m.....Z M9BWZ

Note 2) Auto switches marked with "○" are produced upon receipt of order.
 Note 3) PLC: Programmable Logic Controller

* Auto switch mounting type is band mounting only
 Refer to page 889 for the applicable auto switch list.

Auto Switch Proper Mounting Position (Detection at Stroke End)

D-M9□
D-M9□W

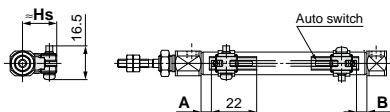

A and B are the dimensions from the end of the head cover/rod cover to the end of the auto switch.

D-A9□

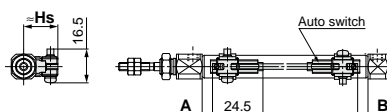

A and B are the dimensions from the end of the head cover/rod cover to the end of the auto switch.

Auto Switch Proper Mounting Position (mm)

Auto switch model	D-M9□ D-M9□W		D-A9□	
	A	B	A	B
Bore size 6	(4.5) 5.5	(4.5) 5.5	(0.5) 1.5	(0.5) 1.5
10	(5) 6	(5) 6	(1) 2	(1) 2
16	(5.5) 6.5	(5.5) 6.5	(1.5) 2.5	(1.5) 2.5

* The values in () are measured from the end of the auto switch mounting bracket.
 Note) The above-mentioned value is a guide for auto switch mounting positions for stroke end detection. When actually mounting the auto switch, adjust the position after confirming the operating state of the auto switch.

Auto Switch Mounting Height (mm)

Auto switch model	D-M9□ D-M9□W D-A9□
Bore size	Hs
6	15
10	17
16	20.5

Specific Product Precautions

Be sure to read this before handling.

Mounting

Caution

- During installation, secure the rod cover and tighten by applying an appropriate tightening torque to the retaining nut or to the rod cover.
 If the head cover is secured or the head cover is tightened, the cover could rotate, leading to a deviation.
- Tighten the retaining screws with an appropriate tightening torque within the range given below.
 ø6: 5.9 to 6.4 N·m
 ø10: 10.8 to 11.8 N·m
 ø16: 20.0 to 21.0 N·m

Basic (B): ¹⁰⁻CJ2B, ²¹⁻CJ2B

Rubber bumper

ø6

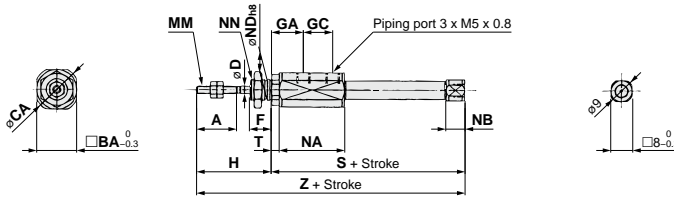

ø10, ø16

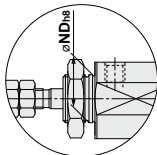

Section Y detail

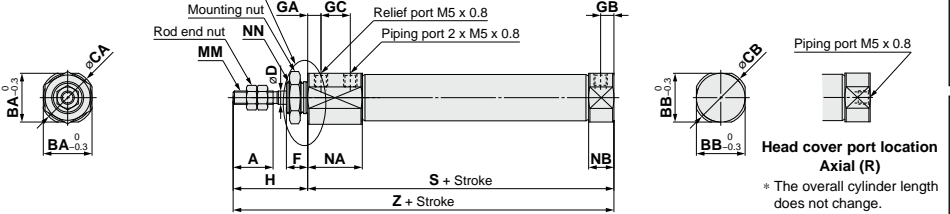

Bore size	A	BA	BB	CA	CB	D	F	GA	GB	GC	H	MM	NA	NB	ND _{h8}	NN	S	T	Z
6	15	15	—	17	—	3	8	12	—	11	28	M3 x 0.5	24.5	7	8- ⁰ / _{0.022}	M8 x 1.0	57.5	3	85.5
10	15	15	12	17	14	4	8	5	5	11	28	M4 x 0.7	20.5	9.5	10- ⁰ / _{0.022}	M10 x 1.0	54	—	82
16	15	18.3	18.3	20	20	5	8	5	5	11	28	M5 x 0.8	20.5	9.5	12- ⁰ / _{0.027}	M12 x 1.0	55	—	83

With air cushion

Air cushion type is not available for 21-/22-CJ2.

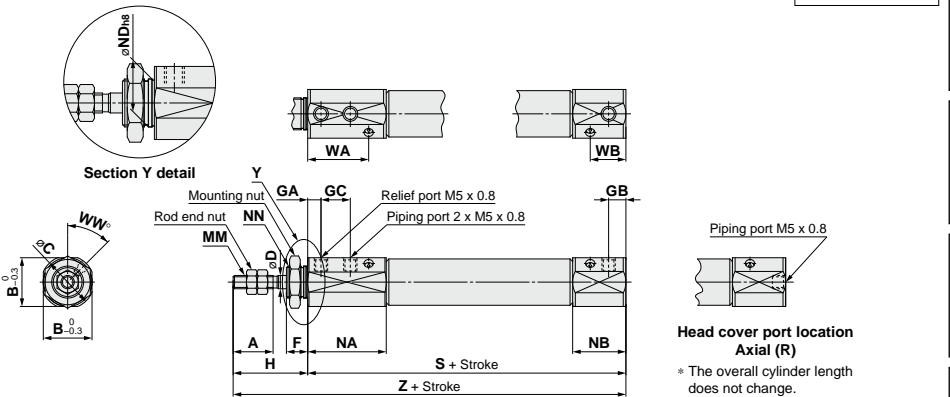

Bore size	A	B	C	D	F	GA	GB	GC	H	MM	NA	NB	ND _{h8}	NN	S	WA	WB	WW	Z
10	15	15	17	4	8	5	6.5	11	28	M4 x 0.7	29.5	20	10- ⁰ / _{0.022}	M10 x 1.0	73.5	22.9	13.4	45	101.5
16	15	18.3	20	5	8	5	6.5	11	28	M5 x 0.8	29.5	20	12- ⁰ / _{0.027}	M12 x 1.0	74.5	22.9	13.4	45	102.5

Single Foot (L): ¹⁰⁻**CJ2L**, ²¹⁻**CJ2L**

Rubber bumper

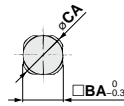
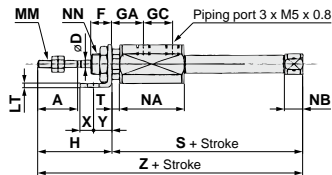
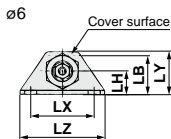

Rod cover side



Head cover side

ø10, ø16

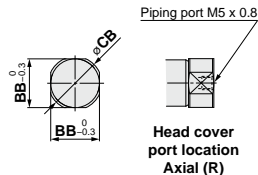
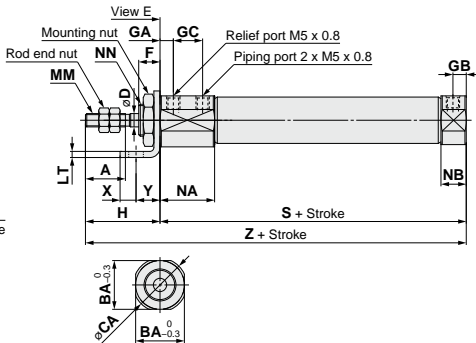
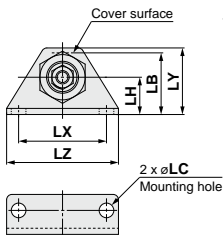

Head cover port location Axial (R)

* The overall cylinder length does not change.

Drawing of view E

Bore size	A	BA	BB	CA	CB	D	F	GA	GB	GC	H	LB	LC	LH	LT	LX	LY	LZ	MM	NA	NB	NN	S	T	X	Y	Z
6	15	15	—	17	—	3	8	12	—	11	28	16.5	4.5	9	1.6	24	16.5	32	M3 x 0.5	24.5	7	M8 x 1.0	57.5	3	5	7	85.5
10	15	15	12	17	14	4	8	5	11	28	21.5	5.5	14	2.3	33	25	42	M4 x 0.7	20.5	9.5	M10 x 1.0	54	—	6	9	82	
16	15	18.3	18.3	20	20	5	8	5	11	28	23	5.5	14	2.3	33	25	42	M5 x 0.8	20.5	9.5	M12 x 1.0	55	—	6	9	83	

With air cushion

Air cushion type is not available for 21-/22-CJ2.

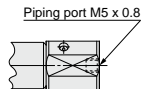
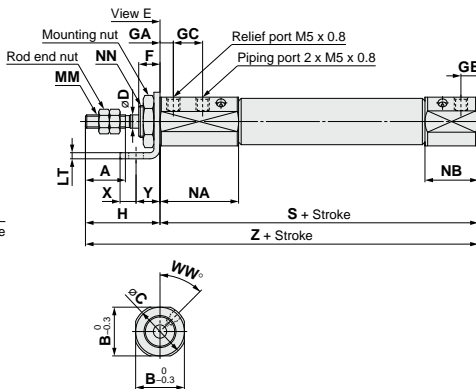
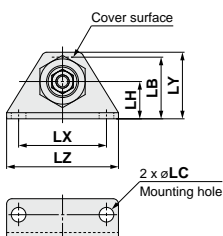
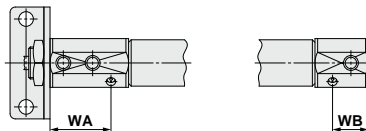

Head cover port location Axial (R)

* The overall cylinder length does not change.

Drawing of view E

Bore size	A	B	C	D	F	GA	GB	GC	H	LB	LC	LH	LT	LX	LY	LZ	MM	NA	NB	NN	S	WA	WB	WW	X	Y	Z
10	15	15	17	4	8	5	6.5	11	28	21.5	5.5	14	2.3	33	25	42	M4 x 0.7	29.5	20	M10 x 1.0	73.5	22.9	13.4	45	6	9	101.5
16	15	18.3	20	5	8	5	6.5	11	28	23	5.5	14	2.3	33	25	42	M5 x 0.8	29.5	20	M12 x 1.0	74.5	22.9	13.4	45	6	9	102.5

Double Foot (M): 10-**CJ2M**, 21-**CJ2M**

Rubber bumper

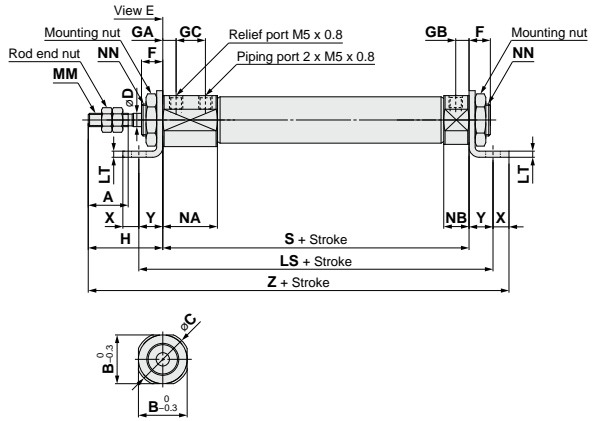
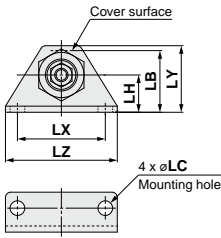

Drawing of view E

Bore size	A	B	C	D	F	GA	GB	GC	H	LB	LC	LH	LS	LT	LX	LY	LZ	MM	NA	NB	NN	S	X	Y	Z
10	15	15	17	4	8	5	5	11	28	21.5	5.5	14	72	2.3	33	25	42	M4 x 0.7	20.5	9.5	M10 x 1.0	54	6	9	97
16	15	18.3	20	5	8	5	5	11	28	23	5.5	14	73	2.3	33	25	42	M5 x 0.8	20.5	9.5	M12 x 1.0	55	6	9	98

With air cushion

Air cushion type is not available for 21-/22-CJ2.

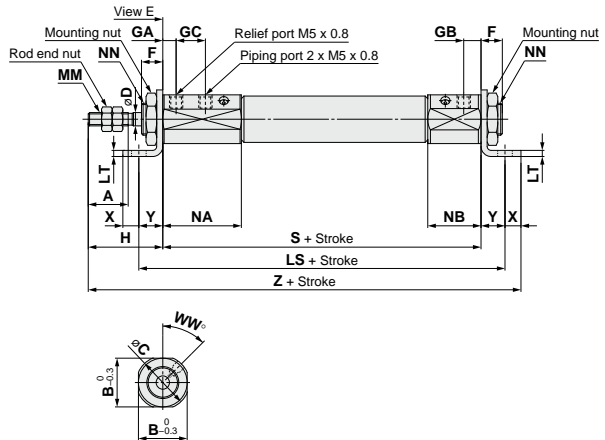
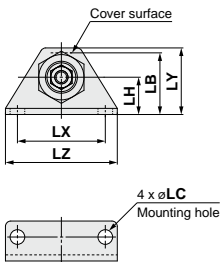

Drawing of view E

Bore size	A	B	C	D	F	GA	GB	GC	H	LB	LC	LH	LS	LT	LX	LY	LZ	MM	NA	NB	NN	WA	WB	WW	S	X	Y	Z
10	15	15	17	4	8	5	6.5	11	28	21.5	5.5	14	91.5	2.3	33	25	42	M4 x 0.7	29.5	20	M10 x 1.0	22.9	13.4	45	73.5	6	9	116.5
16	15	18.3	20	5	8	5	6.5	11	28	23	5.5	14	92.5	2.3	33	25	42	M5 x 0.8	29.5	20	M12 x 1.0	22.9	13.4	45	74.5	6	9	117.5

Directional Control Valves
Air Cylinders
Rotary Actuators
Air Grippers
Air Preparation Equipment
Modular F. R.
Pressure Control Equipment
Fittings & Tubing
Flow Control Equipment
Pressure Switches/Pressure Sensors

Rod Flange (F): ¹⁰:CJ2F, ²¹:CJ2F

Rubber bumper

ø6

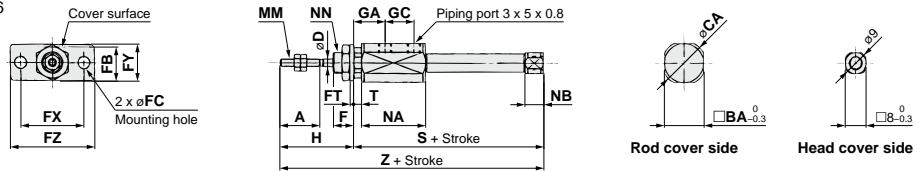

ø10, ø16

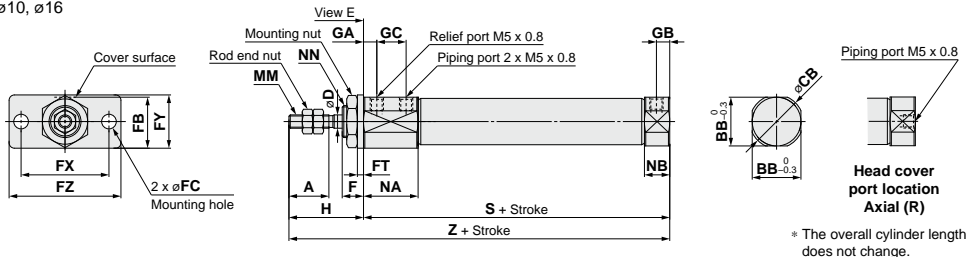

Drawing of view E

(mm)

Bore size	A	BA	BB	CA	CB	D	F	FB	FC	FT	FX	FY	FZ	GA	GB	GC	H	MM	NA	NB	NN	S	T	Z
6	15	15	—	17	—	3	8	14.5	4.5	1.6	24	14	32	12	—	11	28	M3 x 0.5	24.5	7	M8 x 1.0	57.5	3	85.5
10	15	15	12	17	14	4	8	17.5	5.5	2.3	33	20	42	5	5	11	28	M4 x 0.7	20.5	9.5	M10 x 1.0	54	—	82
16	15	18.3	18.3	20	20	5	8	19	5.5	2.3	33	20	42	5	5	11	28	M5 x 0.8	20.5	9.5	M12 x 1.0	55	—	83

With air cushion

Air cushion type is not available for 21-/22-CJ2.

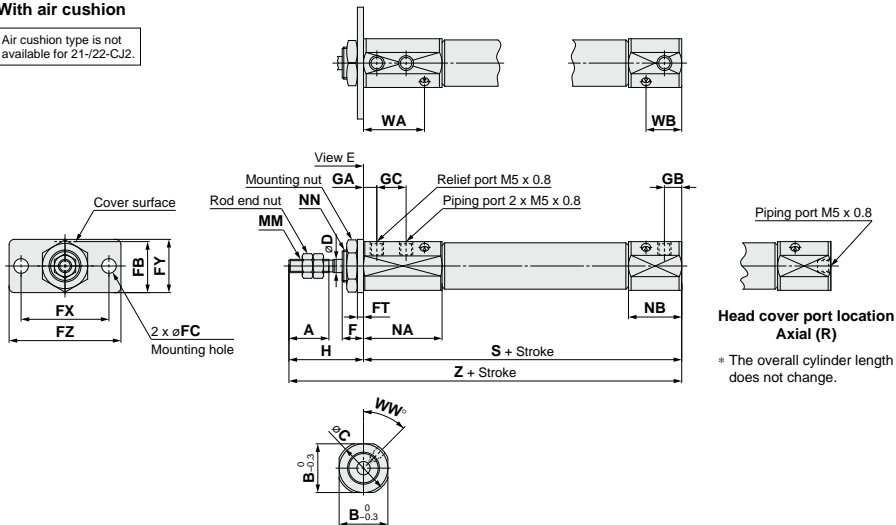

Drawing of view E

(mm)

Bore size	A	B	C	D	F	FB	FC	FT	FX	FY	FZ	GA	GB	GC	H	MM	NA	NB	NN	S	WA	WB	WW	Z
10	15	15	17	4	8	17.5	5.5	2.3	33	20	42	5	6.5	11	28	M4 x 0.7	29.5	20	M10 x 1.0	73.5	22.9	13.4	45	101.5
16	15	18.3	20	5	8	19	5.5	2.3	33	20	42	5	6.5	11	28	M5 x 0.8	29.5	20	M12 x 1.0	74.5	22.9	13.4	45	102.5

Head Flange (G): 10- CJ2G, 21- CJ2G

Rubber bumper

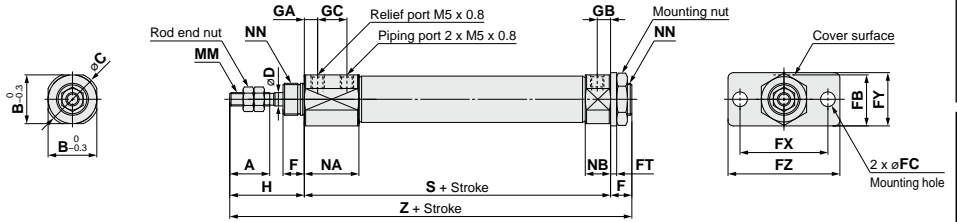

Bore size	A	B	C	D	F	FB	FC	FT	FX	FY	FZ	GA	GB	GC	H	MM	NA	NB	NN	S	Z
10	15	15	17	4	8	17.5	5.5	2.3	33	20	42	5	5	11	28	M4 x 0.7	20.5	9.5	M10 x 1.0	54	90
16	15	18.3	20	5	8	19	5.5	2.3	33	20	42	5	5	11	28	M5 x 0.8	20.5	9.5	M12 x 1.0	55	91

With air cushion

Air cushion type is not available for 21-/22-CJ2.

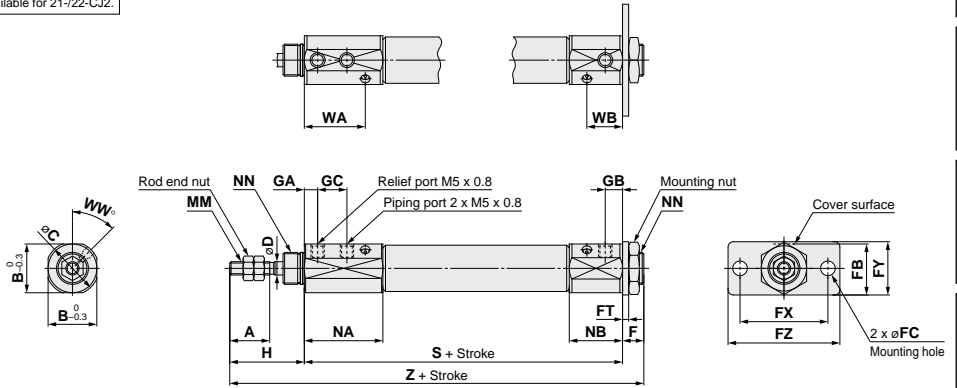

Bore size	A	B	C	D	F	FB	FC	FT	FX	FY	FZ	GA	GB	GC	H	MM	NA	NB	NN	WA	WB	WW	S	Z
10	15	15	17	4	8	17.5	5.5	2.3	33	20	42	5	6.5	11	28	M4 x 0.7	29.5	20	M10 x 1.0	22.9	13.4	45	73.5	109.5
16	15	18.3	20	5	8	19	5.5	2.3	33	20	42	5	6.5	11	28	M5 x 0.8	29.5	20	M12 x 1.0	22.9	13.4	45	74.5	110.5

Directional Control Valves
Air Cylinders
Rotary Actuators
Air Grippers
Air Preparation Equipment
Modular F. R.
Pressure Control Equipment
Fittings & Tubing
Flow Control Equipment
Pressure Switches/ Pressure Sensors

Double-side Bossed (E): 1⁰: **CJ2E**, 2¹: **CJ2E**

Rubber bumper

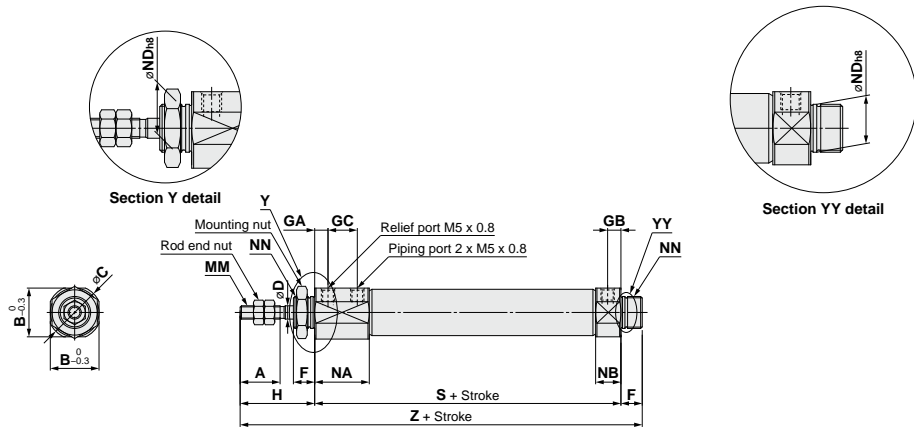

Bore size	A	B	C	D	F	GA	GB	GC	H	MM	NA	NB	ND _{h8}	NN	S	Z
10	15	15	17	4	8	5	5	11	28	M4 x 0.7	20.5	9.5	10 ⁰ _{-0.022}	M10 x 1.0	54	90
16	15	18.3	20	5	8	5	5	11	28	M5 x 0.8	20.5	9.5	12 ⁰ _{-0.027}	M12 x 1.0	55	91

With air cushion

Air cushion type is not available for 21-/22-CJ2.

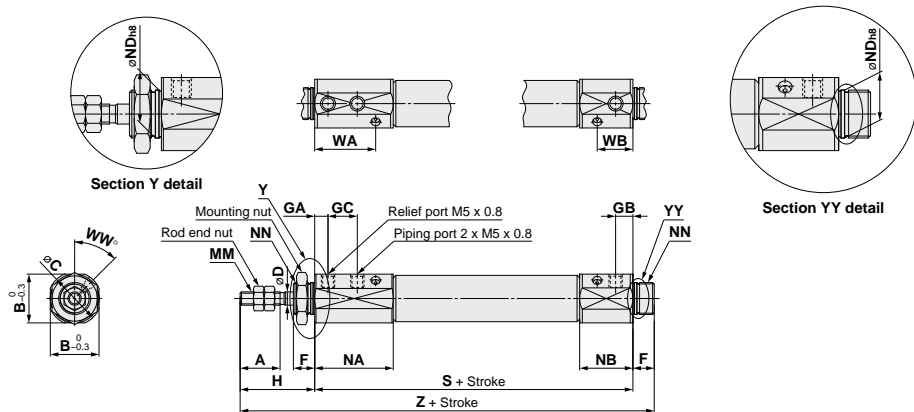

Bore size	A	B	C	D	F	GA	GB	GC	H	MM	NA	NB	ND _{h8}	NN	WA	WB	WW	S	Z
10	15	15	17	4	8	5	6.5	11	28	M4 x 0.7	29.5	20	10 ⁰ _{-0.022}	M10 x 1.0	22.9	13.4	45	73.5	109.5
16	15	18.3	20	5	8	5	6.5	11	28	M5 x 0.8	29.5	20	12 ⁰ _{-0.027}	M12 x 1.0	22.9	13.4	45	74.5	110.5

Mounting Nut

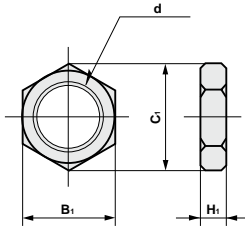

Material: Carbon steel (mm)

Part no.	Applicable bore size	B_1	C_1	d	H_1
SNJ-010B	6	11	12.7	M8 x 1.0	4
SNJ-016C	10	14	16.2	M10 x 1.0	4
SNKJ-016C	16	17	19.6	M12 x 1.0	4

* The applicable mounting nuts are different from those for standard cylinders.

Rod End Nut

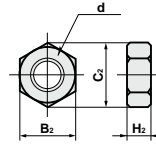

Material: Carbon steel (mm)

Part no.	Applicable bore size	B_2	C_2	d	H_2
NTJ-006A	6	5.5	6.4	M3 x 0.5	2.4
NTJ-010C	10	7	8.1	M4 x 0.7	3.2
NTJ-015C	16	8	9.2	M5 x 0.8	4

Directional Control Valves

Air Cylinders

Rotary Actuators

Air Grippers

Air Preparation Equipment

Modular F. R.

Pressure Control Equipment

Fittings & Tubing

Flow Control Equipment

Pressure Switches/ Pressure Sensors

Series 10-/11-21-/22-CJ2W-Z $\varnothing 10, \varnothing 16$ Double Rod Cylinder



How to Order

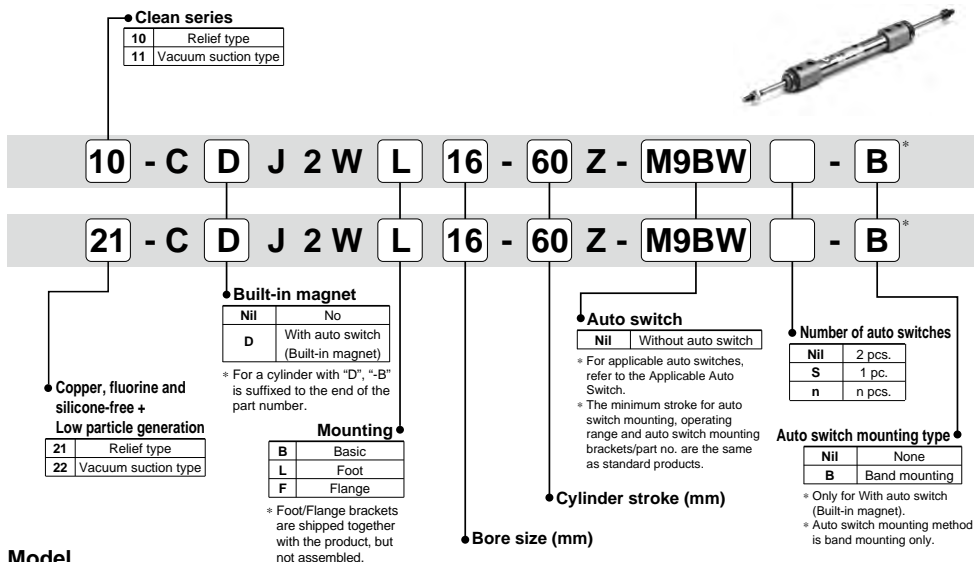

Model

	Model	Bore size (mm)	Port size	Lubrication	Action	Standard stroke (mm)	Auto switch mounting	Cushion	
								Rubber	Air
Relief type	10-/21-CJ2W□10	10	M5 x 0.8	Non-lube	Double acting, Double rod	15, 30, 45, 60, 75, 100, 125, 150	Band mounting only	Standard	-
	10-/21-CJ2W□16	16				15, 30, 45, 60, 75, 100, 125, 150, 175, 200			
Vacuum suction type	11-/22-CJ2W□10	10				15, 30, 45, 60, 75, 100, 125, 150			
	11-/22-CJ2W□16	16				15, 30, 45, 60, 75, 100, 125, 150, 175, 200			

Specifications

	Bore size (mm)
Item	10/16
Proof pressure	1 MPa
Maximum operating pressure	0.7 MPa
Minimum operating pressure	0.1 MPa
Ambient and fluid temperature	Without auto switch: -10°C to 70°C With auto switch: -10°C to 60°C (No freezing)
Piston speed	50 to 400 mm/s
Stroke length tolerance	$^{+1.0}_0$
Mounting	Basic/Foot/Flange
Grease	10-/11-: Fluorine grease, 21-/22-: Lithium soap based grease
Cleanliness class (ISO class)	10-/21-: Class 4
	11-/22-: Class 3

Suction Flow Rate of Vacuum Suction Type (Reference values)

Size	Suction flow rate L/min (ANR)
10/16	1

Mounting Bracket Part No.

Mounting bracket	Bore size (mm)	
	10	16
Foot	CJ-L016C	CJK-L016C
Flange	CJ-F016C	CJK-F016C

Auto Switch

Auto switch specifications and the proper mounting positions for stroke end detection are the same as those for double acting, single rod type.

Refer to page 889 for the applicable auto switch list.

Basic (B): 10-**CJ2WB**, 21-**CJ2WB**

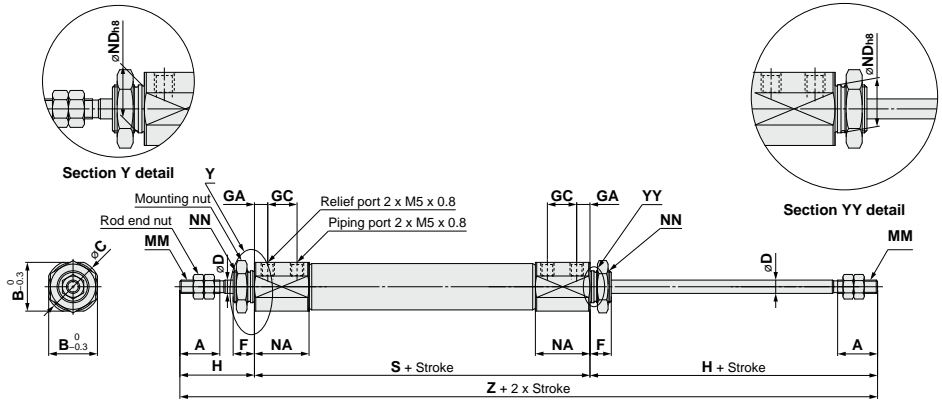

Bore size	A	B	C	D	F	GA	GC	H	MM	NA	ND _{h8}	NN	S	Z
10	15	15	17	4	8	5	11	28	M4 x 0.7	20.5	10 ^{0.022}	M10 x 1.0	65	121
16	15	18.3	20	5	8	5	11	28	M5 x 0.8	20.5	12 ^{0.027}	M12 x 1.0	66	122

Foot (L): 10-**CJ2WL**, 21-**CJ2WL**

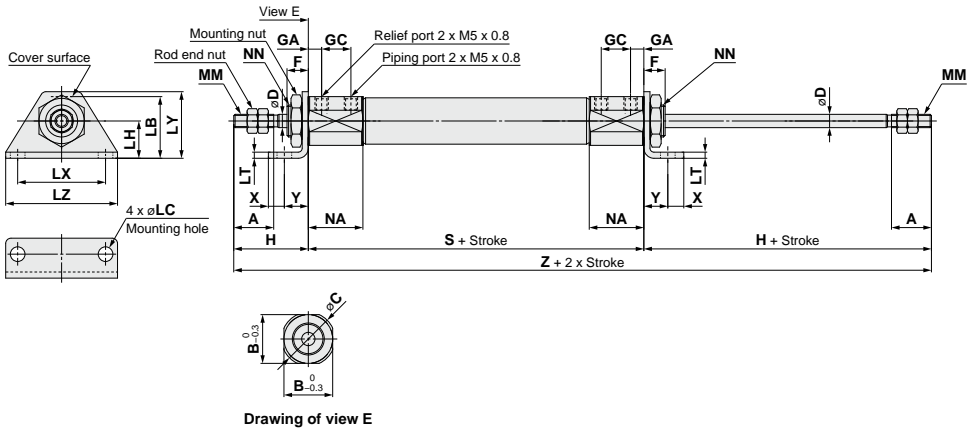

Bore size	A	B	C	D	F	GA	GC	H	LB	LC	LH	LT	LX	LY	LZ	MM	NA	NN	S	X	Y	Z
10	15	15	17	4	8	5	11	28	21.5	5.5	14	2.3	33	25	42	M4 x 0.7	20.5	M10 x 1.0	65	6	9	121
16	15	18.3	20	5	8	5	11	28	23	5.5	14	2.3	33	25	42	M5 x 0.8	20.5	M12 x 1.0	66	6	9	122

Directional Control Valves

Air Cylinders

Rotary Actuators

Air Grippers

Air Preparation Equipment

Modular F. R.

Pressure Control Equipment

Fittings & Tubing

Flow Control Equipment

Pressure Switches/ Pressure Sensors

Flange (F): 10-11-**CJ2WF**, 21-22-**CJ2WF**

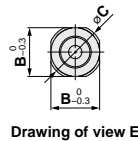
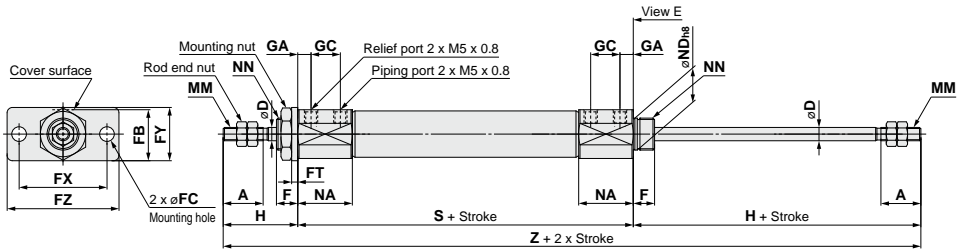

Drawing of view E

Bore size	A	B	C	D	F	FB	FC	FT	FX	FY	FZ	GA	GC	H	MM	NA	ND _{h8}	NN	S	Z
10	15	15	17	4	8	17.5	5.5	2.3	33	20	42	5	11	28	M4 x 0.7	20.5	10 ^{0.022}	M10 x 1.0	65	121
16	15	18.3	20	5	8	19	5.5	2.3	33	20	42	5	11	28	M5 x 0.8	20.5	12 ^{0.027}	M12 x 1.0	66	122

! Specific Product Precautions

Be sure to read this before handling.

Mounting

! Caution

1. During installation, secure the rod cover on the mounting side and tighten by applying an appropriate tightening torque to the retaining nut or to the rod cover on the mounting side. If the rod cover on the opposite side is secured or the rod cover on the opposite side is tightened, the cover could rotate, leading to a deviation.
2. Tighten the retaining screws with an appropriate tightening torque within the range given below.
 ø10: 10.8 to 11.8 N·m
 ø16: 20.0 to 21.0 N·m

Series ^{10-/11-}21-/22-**CJ2RA-Z** $\varnothing 10, \varnothing 16$ Direct Mount Cylinder



How to Order

● Clean series

10	Relief type
11	Vacuum suction type

10 - C D J 2 R A 16 - 60 R Z - M9BW - B*

21 - C D J 2 R A 16 - 60 R Z - M9BW - B*

● Bore size (mm)

● Cylinder stroke (mm)

● Built-in magnet

Nil	No
D	With auto switch (Built-in magnet)

* For a cylinder with "D", "-B" is suffixed to the end of the part number.

● Copper, fluorine and silicone-free + Low particle generation

21	Relief type
22	Vacuum suction type

● Auto switch

Nil	Without auto switch
S	1 pc.
n	n pcs.

* For applicable auto switches, refer to the Applicable Auto Switch.

* The minimum stroke for auto switch mounting, operating range and auto switch mounting brackets/part no. are the same as standard products.

● Number of auto switches

Nil	2 pcs.
S	1 pc.
n	n pcs.

● Auto switch mounting type

Nil	None
B	Band mounting

* Only for With auto switch (Built-in magnet).

* Auto switch mounting method is band mounting only.

● Head cover port location

Nil	Perpendicular to axis	
R	Axial	

* For double-side bossed type, the product is perpendicular to the cylinder axis.

Model

Relief type	Model	Bore size (mm)	Port size	Lubrication	Action	Standard stroke (mm)	Auto switch mounting	Cushion	
								Rubber	Air
Vacuum suction type	10-/21-CJ2RA10	10	M5 x 0.8	Non-lube	Double acting, Single rod	15, 30, 45, 60, 75, 100, 125, 150	Band mounting only	Standard	-
	10-/21-CJ2RA16	16				15, 30, 45, 60, 75, 100, 125, 150, 175, 200			
	11-/22-CJ2RA10	10				15, 30, 45, 60, 75, 100, 125, 150			
	11-/22-CJ2RA16	16				15, 30, 45, 60, 75, 100, 125, 150, 175, 200			

Specifications

Item	Bore size (mm)
Item	10/16
Proof pressure	1 MPa
Maximum operating pressure	0.7 MPa
Minimum operating pressure	0.08 MPa
Ambient and fluid temperature	Without auto switch: -10°C to 70°C With auto switch: -10°C to 60°C (No freezing)
Piston speed	50 to 400 mm/s
Stroke length tolerance	$^{+1}_0$
Mounting	Bottom mounting
Grease	10-/11-: Fluorine grease, 21-/22-: Lithium soap based grease
Cleanliness class (ISO class)	10-/21-: Class 4
	11-/22-: Class 3

Suction Flow Rate of Vacuum Suction Type (Reference values)

Size	Suction flow rate L/min (ANR)
10/16	1

Directional Control Valves
 Air Cylinders
 Rotary Actuators
 Air Grippers
 Air Preparation Equipment
 Modular F. R.
 Pressure Control Equipment
 Fittings & Tubing
 Flow Control Equipment
 Pressure Switches/ Pressure Sensors

Auto Switch

Auto switch specifications and the proper mounting positions for stroke end detection are the same as those for double acting, single rod type.

Refer to page 889 for the applicable auto switch list.

Bottom Mounting: ¹⁰⁻~~11-~~**CJ2RA**, ²¹⁻~~22-~~**CJ2RA**

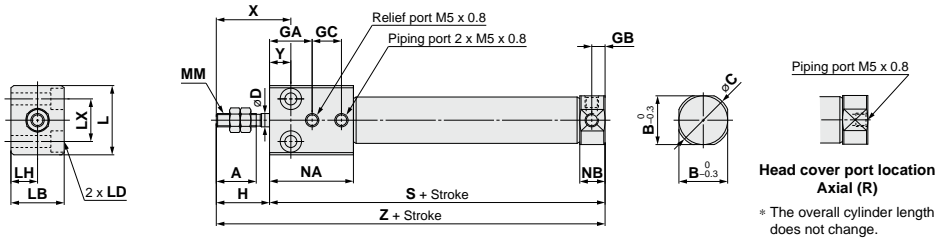

Bore size	A	B	C	D	GA	GB	GC	H	L	LB	LD	LH	LX	MM	NA	NB	S	X	Y	Z
10	15	12	14	4	16	5	11	20	23	16	ø3.5 through, ø6.5 depth of counterbore 4	8	12	M4 x 0.7	31.5	9.5	65	28	8	85
16	15	18.3	20	5	16	5	11	20	26	20	ø4.5 through, ø8 depth of counterbore 5	10	16	M5 x 0.8	31.5	9.5	66	28	8	86

⚠ Specific Product Precautions

Be sure to read this before handling.

Mounting

⚠ Caution

- During installation, secure the rod cover on the mounting side and tighten by applying an appropriate tightening torque to the retaining nut or to the rod cover on the mounting side. If the rod cover on the opposite side is secured or the rod cover on the opposite side is tightened, the cover could rotate, leading to a deviation.

Series 10-/11-21-/22-CM2-Z $\varnothing 20, \varnothing 25, \varnothing 32, \varnothing 40$ Air Cylinder

RoHS

How to Order



Clean series

10	Relief type
11	Vacuum suction type

Built-in magnet

Nil	No
D	With auto switch (Built-in magnet)

Mounting

B	Basic (Double-side bossed)
L	Axial foot
F	Rod flange
G	Head flange
BZ	Boss-cut, Basic
FZ	Boss-cut, Rod flange

Auto switch

Solid state	M9B, M9BW
Reed switch	A93

Rod end thread

Nil	Male rod end
F	Female rod end

Cushion

Nil	Rubber bumper
A	Air cushion

Number of auto switches

Nil	2 pcs.
S	1 pc.
n	n pcs.

Copper, fluorine and silicone-free + Low particle generation

21	Relief type
22	Vacuum suction type

Port thread type

Nil	Rc
TN	NPT*
TF	G*

* Rubber bumper only

Model

10 - C D M 2 L 40 - 150 A F Z - M9BW

21 - C D M 2 L 40 - 150 A Z - M9BW

Bore size (mm)

Cylinder stroke (mm)

Model

Relief type	Model	Bore size (mm)	Port size	Lubrication	Action	Standard stroke (mm)	Auto switch mounting	Cushion	
								Rubber	Air
Vacuum suction type	10-/21-CM2□20	20	1/8	Non-lube	Double acting, Single rod	25, 50, 75, 100, 125, 150, 200, 250, 300	○	○	○
	10-/21-CM2□25	25							
	10-/21-CM2□32	32							
	10-/21-CM2□40	40							
Relief type	11-/22-CM2□20	20	1/8	Non-lube	Double acting, Single rod	25, 50, 75, 100, 125, 150, 200, 250, 300	○	○	○
	11-/22-CM2□25	25							
	11-/22-CM2□32	32							
Relief type	11-/22-CM2□40	40	1/4	Non-lube	Double acting, Single rod	25, 50, 75, 100, 125, 150, 200, 250, 300	○	○	○
	11-/22-CM2□20	20							

Specifications

Item	Bore size (mm)	20/25/32/40
Proof pressure		1.5 MPa
Maximum operating pressure		1.0 MPa
Minimum operating pressure		0.05 MPa
Ambient and fluid temperature		Without auto switch: -10°C to 70°C With auto switch: -10°C to 60°C (No freezing)
Piston speed	10-/11-: 30 to 400 mm/s, 21-/22-: 50 to 400 mm/s	
Stroke length tolerance		$^{+1.4}_0$
Mounting		Basic/Axial foot/Rod flange/Head flange
Grease		10-/11-: Fluorine grease 21-/22-: Lithium soap based grease
Cleanliness class (ISO class)		10-: Class 4, 21-: Class 5 11-/22-: Class 3

Suction Flow Rate of Vacuum Suction Type (Reference values)

Bore size	Suction flow rate L/min (ANR)
20/25/32/40	2

Auto Switch Specifications (Refer to the **WEB catalog** for detailed specifications and auto switches not in the following table.)

Type	Electrical entry	Indicator light	Wiring (Output)	Load voltage			Auto switch model	Lead wire length (m)				Applicable load	
				DC	5 V 12 V	AC		Band mounting	0.5 (Nil)	1 (M)	3 (L)		
Solid state auto switch	Grommet	Yes	2-wire	24 V	5 V 12 V	—	M9B	●	●	●	○	—	Relay, PLC
							M9BW	●	●	●	○		
Reed auto switch	Grommet	Yes	2-wire	24 V	12 V	100 V	A93	●	—	●	●		

Note 1) Lead wire length symbols: 0.5 m.....Nil M9BW
 1 m.....M M9BWM
 3 m.....L M9BWL
 5 m.....Z M9BWZ

Note 2) Auto switches marked with "○" are produced upon receipt of order.
 Note 3) PLC: Programmable Logic Controller

Refer to page 889 for the applicable auto switch list.

Auto Switch Proper Mounting Position (Detection at Stroke End)

Solid state auto switch

D-M9□
 D-M9□W

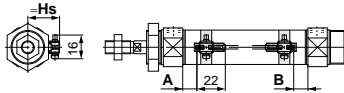

A and B are the dimensions from the end of the head cover/
 rod cover to the end of the auto switch.

Reed auto switch

D-A9□

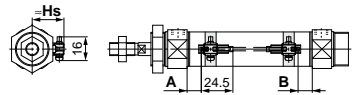

A and B are the dimensions from the end of the head cover/
 rod cover to the end of the auto switch.

Auto Switch Proper Mounting Position (mm)

Auto switch model	D-M9□ D-M9□W		D-A9□	
	A	B	A	B
Bore size 20	11	9.5	7	5.5
25	10	10	6	6
32	11.5	10.5	7.5	6.5
40	17.5	15.5	13.5	11.5

Note) The above-mentioned value is a guide for auto switch mounting positions for stroke end detection. When actually mounting the auto switch, adjust the position after confirming the operating state of the auto switch.

Auto Switch Mounting Height (mm)

Auto switch model	D-M9□ D-M9□W D-A9□
Bore size	Hs
20	22.5
25	25
32	28.5
40	32.5

Basic (Double-side Bossed) (B): ¹⁰⁻11:CM2B, ²¹⁻22:CM2B

With rubber bumper

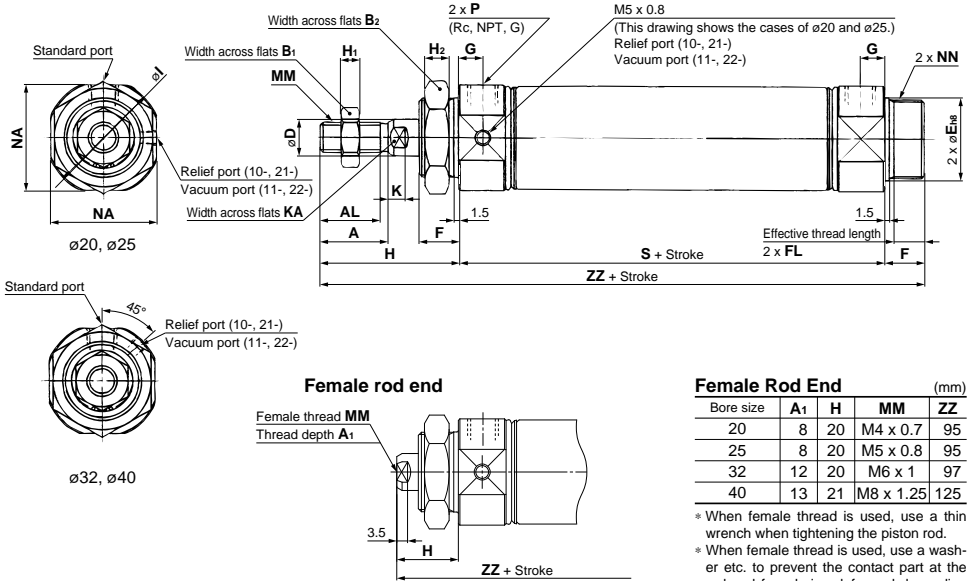

Female Rod End (mm)

Bore size	A ₁	H	MM	ZZ
20	8	20	M4 x 0.7	95
25	8	20	M5 x 0.8	95
32	12	20	M6 x 1	97
40	13	21	M8 x 1.25	125

- * When female thread is used, use a thin wrench when tightening the piston rod.
- * When female thread is used, use a washer etc. to prevent the contact part at the rod end from being deformed depending on the material of the workpiece.

Bore size	(mm)																				
	A	AL	B ₁	B ₂	D	E	F	FL	G	H	H ₁	H ₂	I	K	KA	MM	NA	NN	P	S	ZZ
20	18	15.5	13	26	8	20 ^{-0.033}	13	10.5	8	41	5	8	28	5	6	M8 x 1.25	24	M20 x 1.5	1/8	62	116
25	22	19.5	17	32	10	26 ^{-0.033}	13	10.5	8	45	6	8	33.5	5.5	8	M10 x 1.25	30	M26 x 1.5	1/8	62	120
32	22	19.5	17	32	12	26 ^{-0.033}	13	10.5	8	45	6	8	37.5	5.5	10	M10 x 1.25	34.5	M26 x 1.5	1/8	64	122
40	24	21	22	41	14	32 ^{-0.039}	16	13.5	11	50	8	10	46.5	7	12	M14 x 1.5	42.5	M32 x 2	1/4	88	154

Basic (Double-side Bossed) (B): 10-**CM2B**, 21-**CM2B**

With air cushion

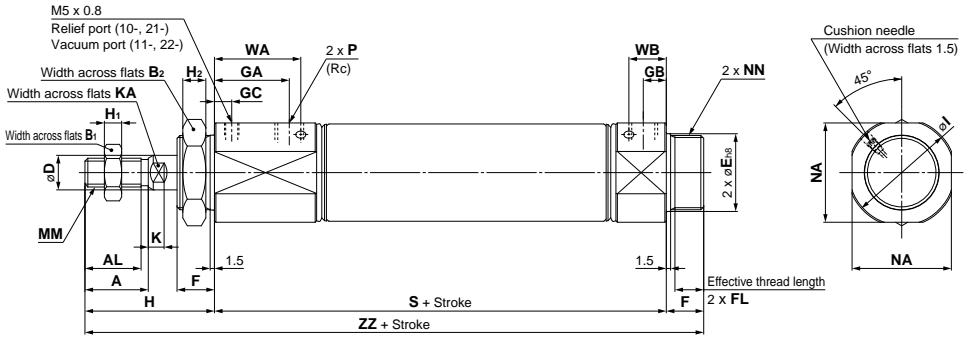

Female rod end

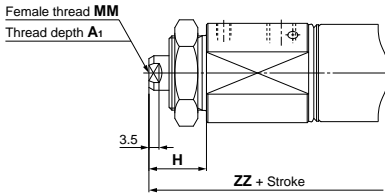

Female Rod End (mm)

Bore size	A ₁	H	MM	ZZ
20	8	20	M4 x 0.7	113
25	8	20	M5 x 0.8	113
32	12	20	M6 x 1	115
40	13	21	M8 x 1.25	145

* When female thread is used, use a thin wrench when tightening the piston rod.
 * When female thread is used, use a washer etc. to prevent the contact part at the rod end from being deformed depending on the material of the workpiece.

Bore size	A	AL	B ₁	B ₂	D	E	F	FL	GA	GB	GC	H	H ₁	H ₂	I	K	KA	MM	NA	NN	P	S	WA	WB	ZZ
20	18	15.5	13	26	8	20 ⁰ _{-0.033}	13	10.5	26	8	6	41	5	8	28	5	6	M8 x 1.25	24	M20 x 1.5	1/8	80	31	13	134
25	22	19.5	17	32	10	26 ⁰ _{-0.033}	13	10.5	26	8	6	45	6	8	33.5	5.5	8	M10 x 1.25	30	M26 x 1.5	1/8	80	31	13	138
32	22	19.5	17	32	12	26 ⁰ _{-0.033}	13	10.5	26	8	6	45	6	8	37.5	5.5	10	M10 x 1.25	34.5	M26 x 1.5	1/8	82	31	13	140
40	24	21	22	41	14	32 ⁰ _{-0.039}	16	13.5	31	11	6	50	8	10	46.5	7	12	M14 x 1.5	42.5	M32 x 2	1/4	108	36	16	174

Boss-cut, Basic (BZ): 10-11:CM2BZ, 21-22:CM2BZ

With rubber bumper

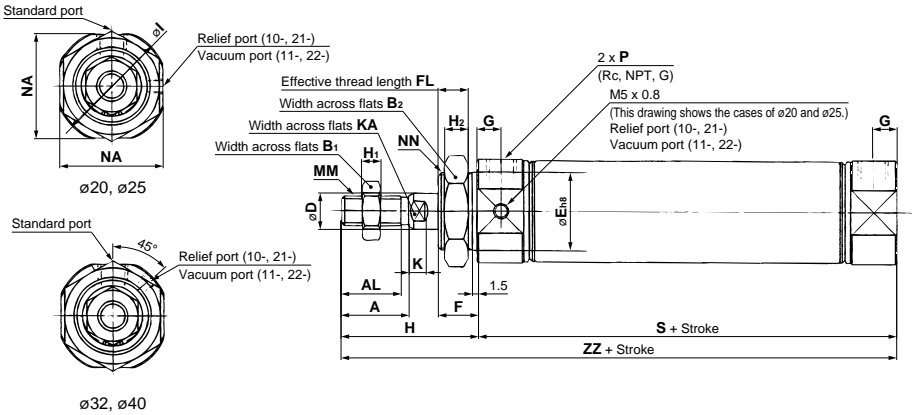

																		(mm)			
Bore size	A	AL	B ₁	B ₂	D	E	F	FL	G	H	H ₁	H ₂	I	K	KA	MM	NA	NN	P	S	ZZ
20	18	15.5	13	26	8	20 ⁰ _{-0.033}	13	10.5	8	41	5	8	28	5	6	M8 x 1.25	24	M20 x 1.5	1/8	62	103
25	22	19.5	17	32	10	26 ⁰ _{-0.033}	13	10.5	8	45	6	8	33.5	5.5	8	M10 x 1.25	30	M26 x 1.5	1/8	62	107
32	22	19.5	17	32	12	26 ⁰ _{-0.033}	13	10.5	8	45	6	8	37.5	5.5	10	M10 x 1.25	34.5	M26 x 1.5	1/8	64	109
40	24	21	22	41	14	32 ⁰ _{-0.039}	16	13.5	11	50	8	10	46.5	7	12	M14 x 1.5	42.5	M32 x 2	1/4	88	138

* Refer to page 702 for female thread dimensions.

With air cushion

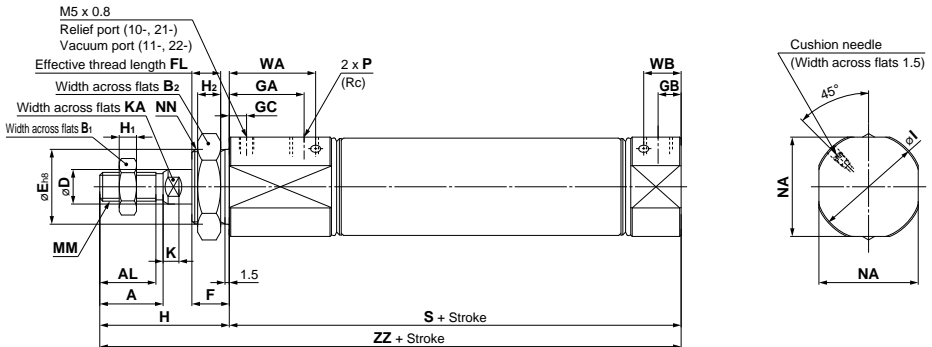

																						(mm)			
Bore size	A	AL	B ₁	B ₂	D	E	F	FL	GA	GB	GC	H	H ₁	H ₂	I	K	KA	MM	NA	NN	P	S	WA	WB	ZZ
20	18	15.5	13	26	8	20 ⁰ _{-0.033}	13	10.5	26	8	6	41	5	8	28	5	6	M8 x 1.25	24	M20 x 1.5	1/8	80	31	13	121
25	22	19.5	17	32	10	26 ⁰ _{-0.033}	13	10.5	26	8	6	45	6	8	33.5	5.5	8	M10 x 1.25	30	M26 x 1.5	1/8	80	31	13	125
32	22	19.5	17	32	12	26 ⁰ _{-0.033}	13	10.5	26	8	6	45	6	8	37.5	5.5	10	M10 x 1.25	34.5	M26 x 1.5	1/8	82	31	13	127
40	24	21	22	41	14	32 ⁰ _{-0.039}	16	13.5	31	11	6	50	8	10	46.5	7	12	M14 x 1.5	42.5	M32 x 2	1/4	108	36	16	158

* Refer to page 703 for female thread dimensions.

Directional Control Valves
 Air Cylinders
 Rotary Actuators
 Air Grippers
 Air Preparation Equipment
 Modular F. R.
 Pressure Control Equipment
 Fittings & Tubing
 Flow Control Equipment
 Pressure Switches/ Pressure Sensors

Axial Foot (L): 10-11:CM2L, 21-22:CM2L

With rubber bumper

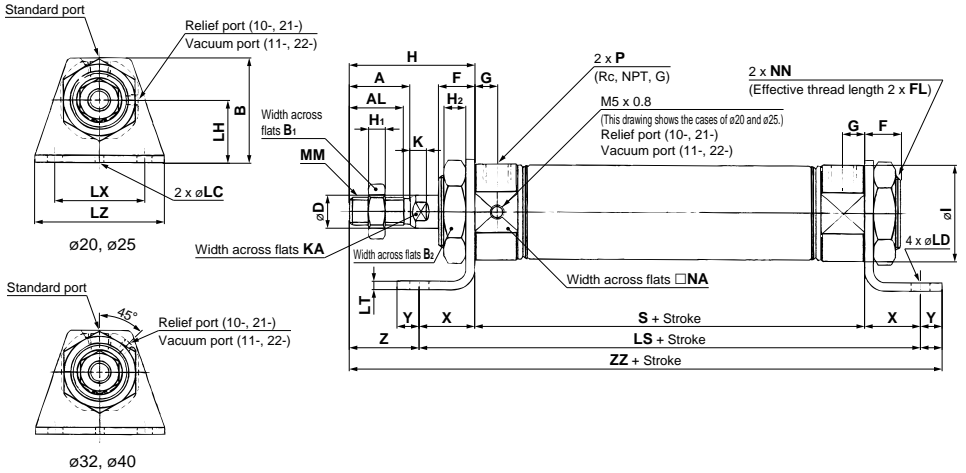

(mm)

Bore size	A	AL	B	B ₁	B ₂	D	F	FL	G	H	H ₁	H ₂	I	K	KA	LC	LD	LH	LS	LT	LX	LZ	MM	NA	NN	P	S	X	Y	Z	ZZ
20	18	15.5	40	13	26	8	13	10.5	8	41	5	8	28	5	6	4	6.8	25	102	3.2	40	55	M8 x 1.25	24	M20 x 1.5	1/8	62	20	8	21	131
25	22	19.5	47	17	32	10	13	10.5	8	45	6	8	33.5	5.5	8	4	6.8	28	102	3.2	40	55	M10 x 1.25	30	M26 x 1.5	1/8	62	20	8	25	135
32	22	19.5	47	17	32	12	13	10.5	8	45	6	8	37.5	5.5	10	4	6.8	28	104	3.2	40	55	M10 x 1.25	34.5	M26 x 1.5	1/8	64	20	8	25	137
40	24	21	54	22	41	14	16	13.5	11	50	8	10	46.5	7	12	4	7	30	134	3.2	55	75	M14 x 1.5	42.5	M32 x 2	1/4	88	23	10	27	171

* The bracket is shipped together. * Refer to page 702 for female thread dimensions.

With air cushion

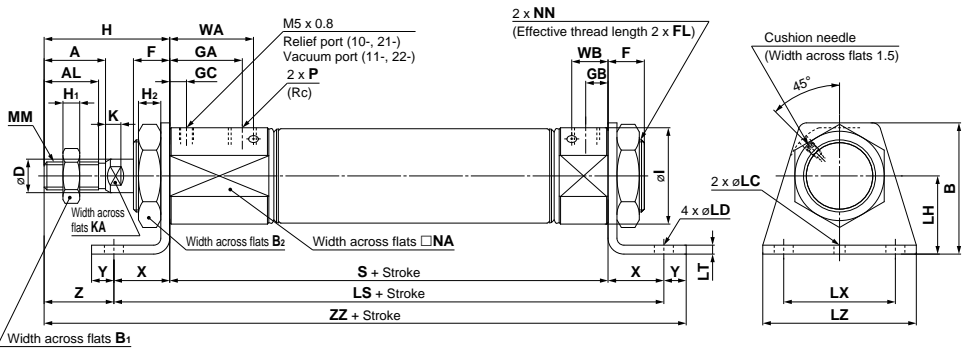

(mm)

Bore size	A	AL	B	B ₁	B ₂	D	F	FL	GA	GB	GC	H	H ₁	H ₂	I	K	KA	LC	LD	LH	LS	LT	LX	LZ	MM	NA	NN	P	S	WA	WB	X	Y	Z	ZZ
20	18	15.5	40	13	26	8	13	10.5	26	8	6	41	5	8	28	5	6	4	6.8	25	120	3.2	40	55	M8 x 1.25	24	M20 x 1.5	1/8	80	31	13	20	8	21	149
25	22	19.5	47	17	32	10	13	10.5	26	8	6	45	6	8	33.5	5.5	8	4	6.8	28	120	3.2	40	55	M10 x 1.25	30	M26 x 1.5	1/8	80	31	13	20	8	25	153
32	22	19.5	47	17	32	12	13	10.5	26	8	6	45	6	8	37.5	5.5	10	4	6.8	28	122	3.2	40	55	M10 x 1.25	34.5	M26 x 1.5	1/8	82	31	13	20	8	25	155
40	24	21	54	22	41	14	16	13.5	31	11	6	50	8	10	46.5	7	12	4	7	30	154	3.2	55	75	M14 x 1.5	42.5	M32 x 2	1/4	108	36	16	23	10	27	191

* The bracket is shipped together. * Refer to page 703 for female thread dimensions.

Rod Flange (F): 10-11:CM2F, 21-22:CM2F

With rubber bumper

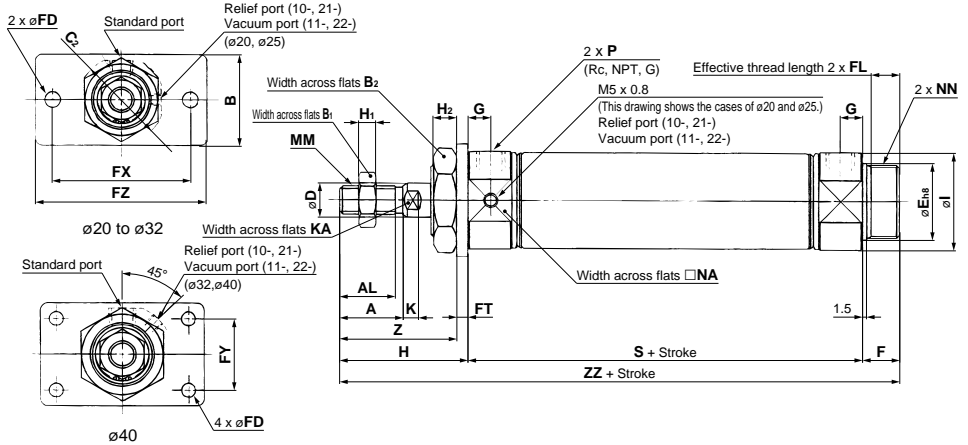

Bore size	A	AL	B	B ₁	B ₂	C ₂	D	E	F	FL	FD	FT	FX	FY	FZ	G	H	H ₁	H ₂	I	K	KA	MM	NA	NN	P	S	Z	ZZ
20	18	15.5	34	13	26	30	8	20 ⁰ _{-0.033}	13	10.5	7	4	60	—	75	8	41	5	8	28	5	6	M8 x 1.25	24	M20 x 1.5	1/8	62	37	116
25	22	19.5	40	17	32	37	10	26 ⁰ _{-0.033}	13	10.5	7	4	60	—	75	8	45	6	8	33.5	5.5	8	M10 x 1.25	30	M26 x 1.5	1/8	62	41	120
32	22	19.5	40	17	32	37	12	26 ⁰ _{-0.033}	13	10.5	7	4	60	—	75	8	45	6	8	37.5	5.5	10	M10 x 1.25	34.5	M26 x 1.5	1/8	64	41	122
40	24	21	52	22	41	47.3	14	32 ⁰ _{-0.039}	16	13.5	7	5	66	36	82	11	50	8	10	46.5	7	12	M14 x 1.5	42.5	M32 x 2	1/4	88	45	154

* The bracket is shipped together. * Refer to page 702 for female thread dimensions.

With air cushion

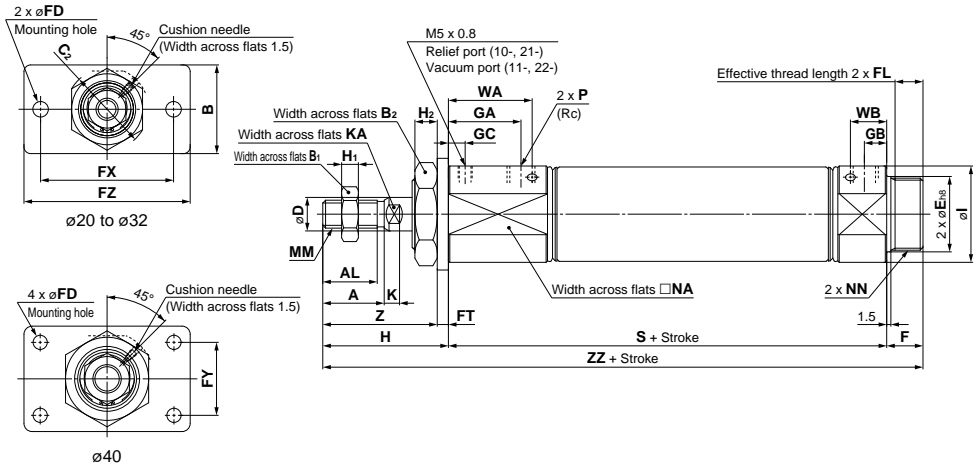

Bore size	A	AL	B	B ₁	B ₂	C ₂	D	E	F	FL	FD	FT	FX	FY	FZ	GA	GB	GC	H	H ₁	H ₂	I	K	KA	MM	NA	NN	P	S	WA	WB	ZZ
20	18	15.5	34	13	26	30	8	20 ⁰ _{-0.033}	13	10.5	4	60	—	75	26	8	6	41	5	8	28	5	6	M8 x 1.25	24	M20 x 1.5	1/8	80	31	13	37	134
25	22	19.5	40	17	32	37	10	26 ⁰ _{-0.033}	13	10.5	4	60	—	75	26	8	6	45	6	8	33.5	5.5	8	M10 x 1.25	30	M26 x 1.5	1/8	80	31	13	41	138
32	22	19.5	40	17	32	37	12	26 ⁰ _{-0.033}	13	10.5	4	60	—	75	26	8	6	45	6	8	37.5	5.5	10	M10 x 1.25	34.5	M26 x 1.5	1/8	82	31	13	41	140
40	24	21	52	22	41	47.3	14	32 ⁰ _{-0.039}	16	13.5	5	66	36	82	31	11	6	50	8	10	46.5	7	12	M14 x 1.5	42.5	M32 x 2	1/4	108	36	16	45	174

* The bracket is shipped together. * Refer to page 703 for female thread dimensions.

Directional Control Valves
Air Cylinders
Rotary Actuators
Air Grippers
Air Preparation Equipment
Modular F. R.
Pressure Control Equipment
Fittings & Tubing
Flow Control Equipment
Pressure Switches/Pressure Sensors

Head Flange (G): 10:CM2G, 21:CM2G

With rubber bumper

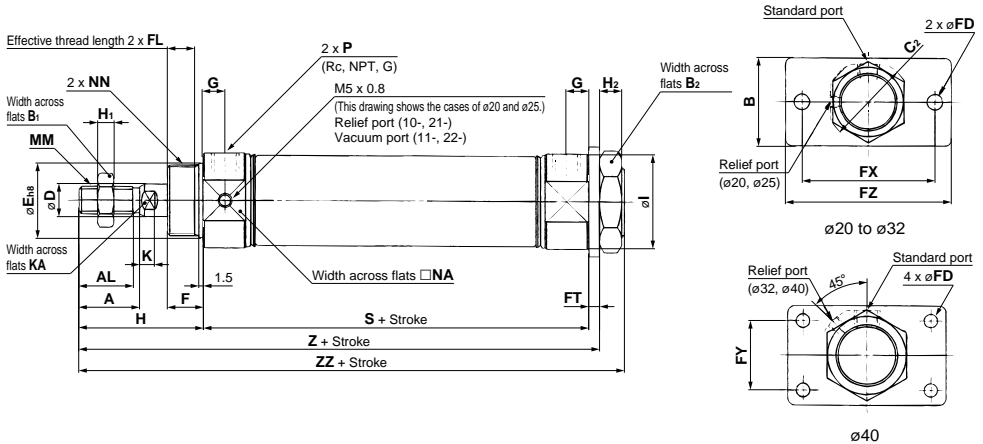

Bore size	A	AL	B	B ₁	B ₂	C ₂	D	E	F	FL	FD	FT	FX	FY	FZ	G	H	H ₁	H ₂	I	K	KA	MM	NA	NN	P	S	Z	ZZ
20	18	15.5	34	13	26	30	8	20 ⁰ _{-0.033}	13	10.5	7	4	60	—	75	8	41	5	8	28	5	6	M8 x 1.25	24	M20 x 1.5	1/8	62	107	116
25	22	19.5	40	17	32	37	10	26 ⁰ _{-0.033}	13	10.5	7	4	60	—	75	8	45	6	8	33.5	5.5	8	M10 x 1.25	30	M26 x 1.5	1/8	62	111	120
32	22	19.5	40	17	32	37	12	26 ⁰ _{-0.033}	13	10.5	7	4	60	—	75	8	45	6	8	37.5	5.5	10	M10 x 1.25	34.5	M26 x 1.5	1/8	64	113	122
40	24	21	52	22	41	47.3	14	32 ⁰ _{-0.039}	16	13.5	7	5	66	36	82	11	50	8	10	46.5	7	12	M14 x 1.5	42.5	M32 x 2	1/4	88	143	154

* The bracket is shipped together. * Refer to page 702 for female thread dimensions.

With air cushion

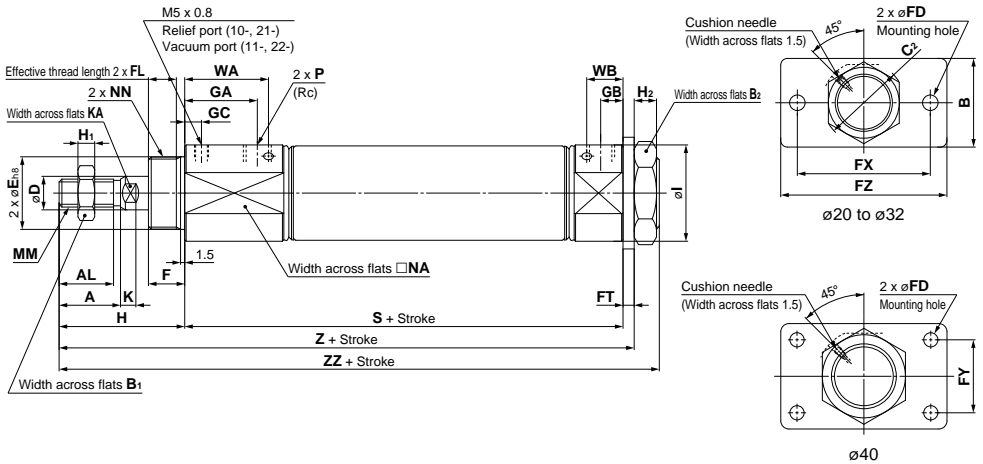

Bore size	A	AL	B	B ₁	B ₂	C ₂	D	E	F	FL	FD	FT	FX	FY	FZ	GA	GB	GC	H	H ₁	H ₂	I	K	KA	MM	NA	NN	P	S	WA	WB	Z	ZZ
20	18	15.5	34	13	26	30	8	20 ⁰ _{-0.033}	13	7	10.5	4	60	—	75	26	8	6	41	5	8	28	5	6	M8 x 1.25	24	M20 x 1.5	1/8	80	31	13	125	134
25	22	19.5	40	17	32	37	10	26 ⁰ _{-0.033}	13	7	10.5	4	60	—	75	26	8	6	45	6	8	33.5	5.5	8	M10 x 1.25	30	M26 x 1.5	1/8	80	31	13	129	138
32	22	19.5	40	17	32	37	12	26 ⁰ _{-0.033}	13	7	10.5	4	60	—	75	26	8	6	45	6	8	37.5	5.5	10	M10 x 1.25	34.5	M26 x 1.5	1/8	82	31	13	131	140
40	24	21	52	22	41	47.3	14	32 ⁰ _{-0.039}	16	7	13.5	5	66	36	82	31	11	6	50	8	10	46.5	7	12	M14 x 1.5	42.5	M32 x 2	1/4	108	36	16	163	174

* The bracket is shipped together. * Refer to page 703 for female thread dimensions.

Specific Product Precautions

Be sure to read this before handling.

Handling

Warning

1. Do not rotate the cover.

If a cover is rotated when installing a cylinder or screwing a fitting into the port, it is likely to damage the junction part with cover.

2. When female rod end is used, use a washer etc. to prevent the contact part at the rod end from being deformed depending on the material of the workpiece.

3. Do not apply excessive lateral load to the piston rod.

Easy checking method

Minimum operating pressure after the cylinder is mounted to the equipment (MPa) = Minimum operating pressure of cylinder (MPa) + {Load mass (kg) × Friction coefficient of guide/Sectional area of cylinder (mm²)}

If smooth operation is confirmed within the above value, the load on the cylinder is the resistance of the thrust only and it can be judged as having no lateral load.

Caution

1. Not able to disassemble.

Cover and cylinder tube are connected to each other by caulking method, thus making it impossible to disassemble. Therefore, internal parts of a cylinder other than rod seal are not replaceable.

2. Use caution to the popping of a retaining ring.

When replacing rod seals and removing and mounting a retaining ring, use a proper tool (Retaining ring plier: Tool for installing a type C retaining ring). Even if a proper tool is used, it is likely to inflict damage to a human body or peripheral equipment, as a retaining ring may be flown out of the tip of a plier. Be much careful with the popping of a retaining ring. Besides, be certain that a retaining ring is placed firmly into the groove of rod cover before supplying air at the time of installation.

3. Do not touch the cylinder during operation.

Use caution when handling a cylinder, which is running at a high speed and a high frequency, because the surface of a cylinder tube could get so hot enough as to cause you get burned.

4. Do not use an air cylinder as an air-hydro cylinder.

If it uses turbine oil in place of fluids for cylinder, it may result in oil leakage.

5. The oil stuck to the cylinder is grease.

6. The base oil of grease may seep out.

The base oil of grease in the cylinder may seep out of the tube, cover, crimped part or rod bushing depending on the operating conditions (ambient temperature 40°C or more, pressurized condition, low frequency operation).

7. When rod end female thread is used, use a thin wrench when tightening the piston rod.

Directional
Control Valves

Air Cylinders

Rotary Actuators

Air Grippers

Air Preparation
Equipment

Modular F. R.

Pressure Control
Equipment

Fittings & Tubing

Flow Control
EquipmentPressure Switches/
Pressure Sensors

Series 10-/11-21-/22-CM2W-Z

∅20, ∅25, ∅32, ∅40
Double Rod Cylinder

RoHS

How to Order



• Clean series

10	Relief type
11	Vacuum suction type

10 - C D M 2 W L 40 - 150 F Z - M9BW

21 - C D M 2 W L 40 - 150 F Z - M9BW

• Built-in magnet

Nil	No
D	With auto switch (Built-in magnet)

• Cylinder stroke (mm)

• Port thread type

Nil	Rc
TN	NPT
TF	G

• Number of auto switches

Nil	2 pcs.
S	1 pc.
n	n pcs.

• Copper, fluorine and silicone-free + Low particle generation

21	Relief type
22	Vacuum suction type

• Bore size (mm)

• Mounting

B	Basic
L	Axial foot
F	Flange

• Rod end thread

Nil	Male rod end
F	Female rod end

• Auto switch

Nil	Without auto switch
-----	---------------------

* For applicable auto switches, refer to the Applicable Auto Switch.

* The minimum stroke for auto switch mounting, operating range and auto switch mounting brackets/part no. are the same as standard products.

Model

Relief type	Model	Bore size (mm)	Port size	Lubrication	Action	Standard stroke (mm)	Auto switch mounting	Cushion	
								Rubber	Air
Vacuum suction type	10-/21-CM2W□20	20	1/8	Non-lube	Double acting Double rod	25, 50, 75, 100, 125 150, 200, 250, 300	○	○	—
	10-/21-CM2W□25	25							
	10-/21-CM2W□32	32							
Relief type	10-/21-CM2W□40	40	1/4	Non-lube	Double acting Double rod	25, 50, 75, 100, 125 150, 200, 250, 300	○	○	—
	11-/22-CM2W□20	20							
	11-/22-CM2W□25	25							
	11-/22-CM2W□32	32							
Vacuum suction type	11-/22-CM2W□40	40	1/4	Non-lube	Double acting Double rod	25, 50, 75, 100, 125 150, 200, 250, 300	○	○	—
	11-/22-CM2W□40	40							

Specifications

Item	Bore size (mm)
	20/25/32/40
Proof pressure	1.5 MPa
Maximum operating pressure	1.0 MPa
Minimum operating pressure	0.08 MPa
Ambient and fluid temperature	Without auto switch: -10°C to 70°C With auto switch: -10°C to 60°C (No freezing)
Piston speed	10-/11-: 30 to 400 mm/s, 21-/22-: 50 to 400 mm/s
Stroke length tolerance	$^{+1.4}$ ₀
Mounting	Basic/Axial foot/Flange
Grease	10-/11-: Fluorine grease 21-/22-: Lithium soap based grease
Cleanliness class (ISO class)	10-: Class 4, 21-: Class 5 11-/22-: Class 3

Suction Flow Rate of Vacuum Suction Type (Reference values)

Bore size	Suction flow rate L/min (ANR)
20/25/32/40	2

Auto Switch

Auto switch specifications and the proper mounting positions for stroke end detection are the same as those for double acting, single rod type.

Refer to page 889 for the applicable auto switch list.

Air Cylinder ¹⁰⁻**CM2W-Z** / ²¹⁻**CM2W-Z**

Flange (F): ¹⁰⁻**CM2WF**, ²¹⁻**CM2WF**

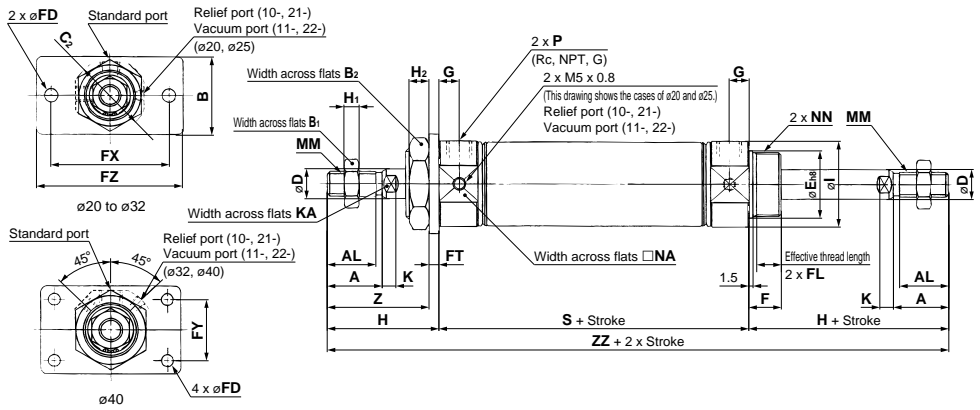

(mm)

Bore size	A	AL	B	B ₁	B ₂	C ₂	D	E	F	FL	FD	FT	FX	FY	FZ	G	H	H ₁	H ₂	I	K	KA	MM	NA	NN	P	S	Z	ZZ
20	18	15.5	34	13	26	30	8	20 ^{±0.033}	13	10.5	7	4	60	—	75	8	41	5	8	28	5	6	M8 x 1.25	24	M20 x 1.5	1/8	62	37	144
25	22	19.5	40	17	32	37	12	26 ^{±0.033}	13	10.5	7	4	60	—	75	8	45	6	8	33.5	5.5	8	M10 x 1.25	30	M26 x 1.5	1/8	62	41	152
32	22	19.5	40	17	32	37	12	26 ^{±0.033}	13	10.5	7	4	60	—	75	8	45	6	8	37.5	5.5	10	M10 x 1.25	34.5	M26 x 1.5	1/8	64	41	154
40	24	21	52	22	41	47.3	14	32 ^{±0.039}	16	13.5	7	5	66	36	82	11	50	8	10	46.5	7	12	M14 x 1.5	42.5	M32 x 2	1/4	88	45	188

* The bracket is shipped together. * Refer to page 710 for female thread dimensions.

⚠ Specific Product Precautions

Be sure to read this before handling.

Handling

⚠ Warning

1. Do not rotate the cover.

If a cover is rotated when installing a cylinder or screwing a fitting into the port, it is likely to damage the junction part with cover.

2. When female rod end is used, use a washer etc. to prevent the contact part at the rod end from being deformed depending on the material of the workpiece.

3. Do not apply excessive lateral load to the piston rod.

Easy checking method

Minimum operating pressure after the cylinder is mounted to the equipment (MPa) = Minimum operating pressure of cylinder (MPa) + {Load mass (kg) × Friction coefficient of guide/Sectional area of cylinder (mm²)}

If smooth operation is confirmed within the above value, the load on the cylinder is the resistance of the thrust only and it can be judged as having no lateral load.

⚠ Caution

1. Not able to disassemble.

Cover and cylinder tube are connected to each other by caulking method, thus making it impossible to disassemble. Therefore, internal parts of a cylinder other than rod seal are not replaceable.

2. Use caution to the popping of a retaining ring.

When replacing rod seals and removing and mounting a retaining ring, use a proper tool (Retaining ring plier: Tool for installing a type C retaining ring). Even if a proper tool is used, it is likely to inflict damage to a human body or peripheral equipment, as a retaining ring may be flown out of the tip of a plier. Be much careful with the popping of a retaining ring. Besides, be certain that a retaining ring is placed firmly into the groove of rod cover before supplying air at the time of installation.

3. Do not touch the cylinder during operation.

Use caution when handling a cylinder, which is running at a high speed and a high frequency, because the surface of a cylinder tube could get so hot enough as to cause you get burned.

4. Do not use an air cylinder as an air-hydro cylinder.

If it uses turbine oil in place of fluids for cylinder, it may result in oil leakage.

5. The oil stuck to the cylinder is grease.

6. The base oil of grease may seep out.

The base oil of grease in the cylinder may seep out of the tube, cover, crimped part or rod bushing depending on the operating conditions (ambient temperature 40°C or more, pressurized condition, low frequency operation).

7. When rod end female thread is used, use a thin wrench when tightening the piston rod.

Directional Control Valves

Air Cylinders

Rotary Actuators

Air Grippers

Air Preparation Equipment

Modular F. R.

Pressure Control Equipment

Fittings & Tubing

Flow Control Equipment

Pressure Switches/ Pressure Sensors

Series 10-/11- 21-/22-**CM2R-Z**

ø20, ø25, ø32, ø40
Direct Mount Cylinder

RoHS

How to Order

● Clean series

10	Relief type
11	Vacuum suction type



10 - C D M 2 R A 40 - 150 F Z - M9BW

21 - C D M 2 R A 40 - 150 F Z - M9BW

● Copper, fluorine and silicone-free + Low particle generation

21	Relief type
22	Vacuum suction type

● Mounting

A	Bottom
B	Front

● Bore size (mm)

● Port thread type

Nil	Rc
TN	NPT
TF	G

● Rod end thread

Nil	Male rod end
F	Female rod end

● Built-in magnet

Nil	No
D	With auto switch (Built-in magnet)

● Cylinder stroke (mm)

● Number of auto switches

Nil	2 pcs.
S	1 pc.
n	n pcs.

● Auto switch

Nil	Without auto switch
-----	---------------------

* For applicable auto switches, refer to the Applicable Auto Switch.
* The minimum stroke for auto switch mounting, operating range and auto switch mounting brackets/part no. are the same as standard products.

Model

Model	Bore size (mm)	Port size	Lubrication	Action	Standard stroke (mm)	Auto switch mounting	Cushion	
							Rubber	Air
Relief type 10-/21-CM2R□20 10-/21-CM2R□25 10-/21-CM2R□32 10-/21-CM2R□40	20	1/8	Non-lube	Double acting, Single rod	25, 50, 75, 100, 125, 150	○	○	—
	25				25, 50, 75, 100, 125, 150, 200			
	32				25, 50, 75, 100, 125, 150, 200, 250, 300			
Vacuum suction type 11-/22-CM2R□20 11-/22-CM2R□25 11-/22-CM2R□32 11-/22-CM2R□40	20	1/8	Non-lube	Double acting, Single rod	25, 50, 75, 100, 125, 150, 200, 250, 300	○	○	—
	25				25, 50, 75, 100, 125, 150, 200			
	32				25, 50, 75, 100, 125, 150, 200			
	40	1/4			25, 50, 75, 100, 125, 150, 200, 250, 300			

Specifications

Item	Bore size (mm)	
	20/25/32/40	
Proof pressure		1.5 MPa
Maximum operating pressure		1.0 MPa
Minimum operating pressure		0.05 MPa
Ambient and fluid temperature		Without auto switch: -10°C to 70°C With auto switch: -10°C to 60°C (No freezing)
Piston speed		10-/11-: 30 to 400 mm/s, 21-/22-: 50 to 400 mm/s
Stroke length tolerance		$^{+1.4}_0$
Mounting		Bottom/Front
Grease		10-/11-: Fluorine grease 21-/22-: Lithium soap based grease
Cleanliness class (ISO class)		10-: Class 4, 21-: Class 5 11-/22-: Class 3

Suction Flow Rate of Vacuum Suction Type (Reference values)

Bore size	Suction flow rate L/min (ANR)
20/25/32/40	2

Auto Switch

Auto switch specifications and the proper mounting positions for stroke end detection are the same as those for double acting, single rod type.

Refer to page 889 for the applicable auto switch list.

⚠ Specific Product Precautions

Refer to page 708.

Bottom Mounting: ¹⁰⁻11-**CM2RA**, ²¹⁻22-**CM2RA**

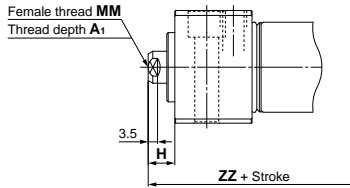
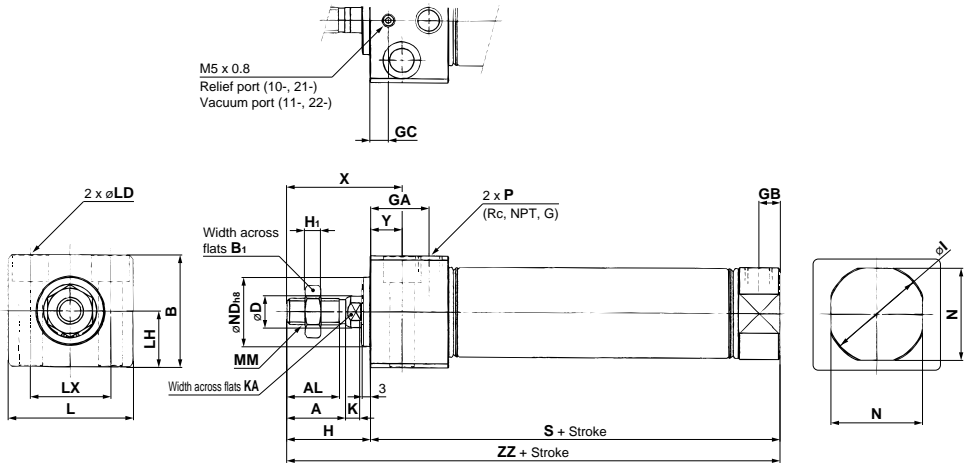

Female Rod End (mm)

Bore size	A ₁	H	MM	ZZ
20	8	10	M4 x 0.7	86
25	8	10	M5 x 0.8	86
32	12	10	M6 x 1	88
40	13	10	M8 x 1.25	114

* When female thread is used, use a thin wrench when tightening the piston rod.

* When female thread is used, use a washer etc. to prevent the contact part at the rod end from being deformed depending on the material of the workpiece.

Bore size	(mm)													(mm)											
	A	AL	B	B ₁	D	GA	GB	GC	H	H _i	I	K	KA	L	LD	LH	LX	MM	N	ND	P	S	X	Y	ZZ
20	18	15.5	30.3	13	8	22	8	6	27	5	28	5	6	33.5	ϕ 5.5, ϕ 9.5 counterbore depth 6.5	15	21	M8 x 1.25	24	20 ^{-0.033}	1/8	76	39	12	103
25	22	19.5	36.3	17	10	22	8	6	31	6	33.5	5.5	8	39	ϕ 6.6, ϕ 11 counterbore depth 7.5	18	25	M10 x 1.25	30	26 ^{-0.033}	1/8	76	43	12	107
32	22	19.5	42.3	17	12	22	8	7	31	6	37.5	5.5	10	47	ϕ 9, ϕ 14 counterbore depth 10	21	30	M10 x 1.25	34.5	26 ^{-0.033}	1/8	78	43	12	109
40	24	21	52.3	22	14	27	11	9	34	8	46.5	7	12	58.5	ϕ 11, ϕ 17.5 counterbore depth 12.5	26	38	M14 x 1.5	42.5	32 ^{-0.039}	1/4	104	49	15	138

Air Cylinder 10-11-**CM2R-Z** / 21-22-**CM2R-Z**

Front Mounting: 10-11-**CM2RB**, 21-22-**CM2RB**

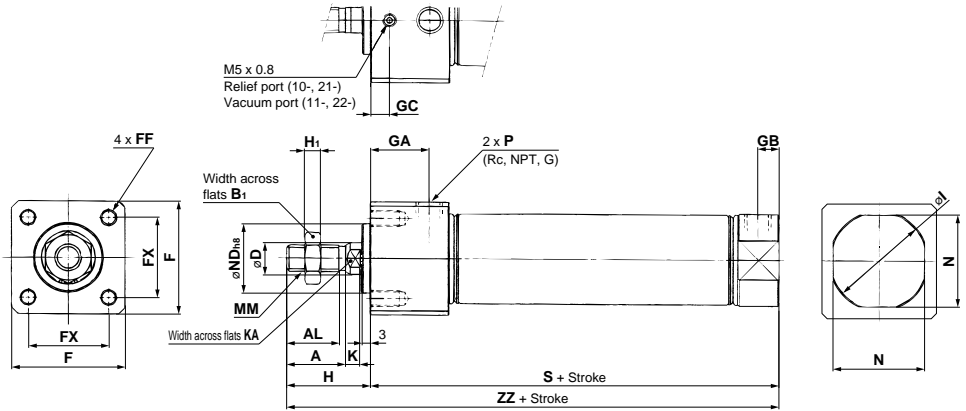

(mm)

Bore size	A	AL	B ₁	D	F	FF	FX	GA	GB	GC	H	H ₁	I	K	KA	MM	N	ND	P	S	ZZ
20	18	15.5	13	8	30.4	M5 x 0.8 thread depth 9	22	22	8	6	27	5	28	5	6	M8 x 1.25	24	20 ⁰ _{-0.033}	1/8	76	103
25	22	19.5	17	10	36.4	M6 x 1 thread depth 11	26	22	8	6	31	6	33.5	5.5	8	M10 x 1.25	30	26 ⁰ _{-0.033}	1/8	76	107
32	22	19.5	17	12	42.4	M6 x 1 thread depth 11	30	22	8	7	31	6	37.5	5.5	10	M10 x 1.25	34.5	26 ⁰ _{-0.033}	1/8	78	109
40	24	21	22	14	52.4	M8 x 1.25 thread depth 14	36	27	11	9	34	8	46.5	7	12	M14 x 1.5	42.5	32 ⁰ _{-0.039}	1/4	104	138

* Refer to page 714 for female thread dimensions.

Series 10-/11-21-/22-CBM2

ø20, ø25, ø32, ø40
Cylinder with End Lock (Head End Lock)

How to Order

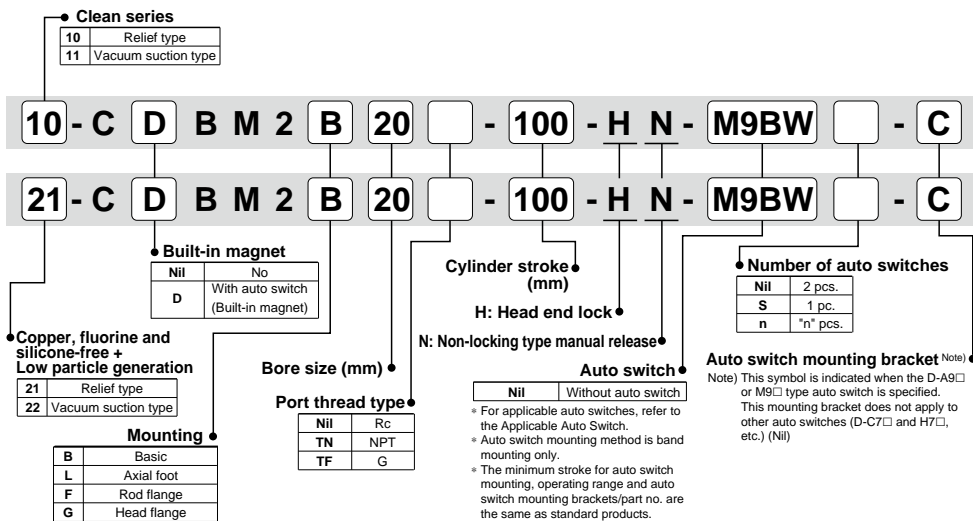

Model

Model	Bore size (mm)	Port size	Lubrication	Action	Standard stroke (mm)	Auto switch mounting	Cushion		
							Rubber	Air	
Vacuum suction type	10-/21-CBM2□20	20	Non-lube	Double acting, single rod	25, 50, 75, 100, 125, 150, 200, 250, 300	Available	Available	Not available	
	10-/21-CBM2□25	25							
	10-/21-CBM2□32	32							
Relief type	10-/21-CBM2□40	40							1/4
	11-/22-CBM2□20	20							
	11-/22-CBM2□25	25							
	11-/22-CBM2□32	32							
11-/22-CBM2□40	40	1/4							

Specifications

Item	Bore size (mm)	
		20/25/32/40
Proof pressure		1.5 MPa
Maximum operating pressure		1.0 MPa
Minimum operating pressure		0.15 MPa *
Ambient and fluid temperature		Without auto switch: -10°C to 70°C, With auto switch: -10°C to 60°C (No freezing)
Piston speed		10-/11-: 30 to 400 mm/s, 21-/22-: 50 to 400 mm/s
Stroke length tolerance		^{+0.4}
Mounting		Basic/Axial foot/Rod flange/Head flange
Grease		10-/11-: Fluorine grease 21-/22-: Lithium soap based grease
Cleanliness class (ISO class)		10-: Class 4, 21-: Class 5 11-/22-: Class 3

* 0.05 MPa for parts other than the lock unit

Lock Specifications

Lock position	Head end			
	ø20	ø25	ø32	ø40
Holding force (Max.) N	215	330	550	860
Backlash	1 mm or less			
Manual release	Non-locking type			

Suction Flow Rate of Vacuum Suction Type (Reference values)

Bore size	Suction flow rate L/min (ANR)
20/25/32/40	2

Directional Control Valves

Air Cylinders

Rotary Actuators

Air Grippers

Air Preparation Equipment

Modular F. R.

Pressure Control Equipment

Fittings & Tubing

Flow Control Equipment

Pressure Switches/Pressure Sensors

Auto Switch Specifications (Refer to the **WEB catalog** for detailed specifications and auto switches not in the following table.)

Type	Electrical entry	Indicator light	Wiring (Output)	Load voltage			Auto switch model	Lead wire length (m)				Applicable load	
				DC	5 V 12 V	AC		Band mounting	0.5 (Nil)	1 (M)	3 (L)		
Solid state auto switch	Grommet	Yes	2-wire	24 V	5 V 12 V	—	M9B	●	●	●	○	—	Relay, PLC
							M9BW	●	●	●	○		
Reed auto switch	Grommet	Yes	2-wire	24 V	12 V	100 V	A93	●	—	●	●		

Note 1) Lead wire length symbols: 0.5 m.....Nil M9BW
 1 m.....M M9BWM
 3 m.....L M9BWL
 5 m.....Z M9BWZ

Note 2) Auto switches marked with "○" are produced upon receipt of order.
 Note 3) PLC: Programmable Logic Controller

Refer to page 889 for the applicable auto switch list.

Auto Switch Proper Mounting Position (Detection at Stroke End)

Solid state auto switch

D-M9□
 D-M9□W

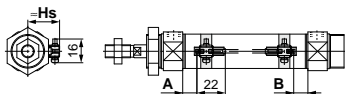

A and B are the dimensions from the end of the head cover/
rod cover to the end of the auto switch.

Reed auto switch

D-A9□

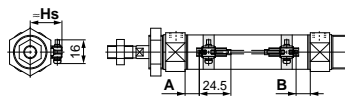

A and B are the dimensions from the end of the head cover/
rod cover to the end of the auto switch.

Auto Switch Proper Mounting Position (mm)

Auto switch model	D-M9□ D-M9□W		D-A9□	
	A	B	A	B
Bore size 20	10.5	9.5	6.5	5.5
25	10.5	9.5	6.5	5.5
32	11.5	10.5	7.5	6.5
40	17.5	15.5	13.5	11.5

Note) The above-mentioned value is a guide for auto switch mounting positions for stroke end detection. When actually mounting the auto switch, adjust the position after confirming the operating state of the auto switch.

Auto Switch Mounting Height (mm)

Auto switch model	D-M9□ D-M9□W D-A9□
Bore size	Hs
20	22.5
25	25
32	28.5
40	32.5

Basic (B): ¹⁰⁻₁₁₋CBM2B, ²¹⁻₂₂₋CBM2B

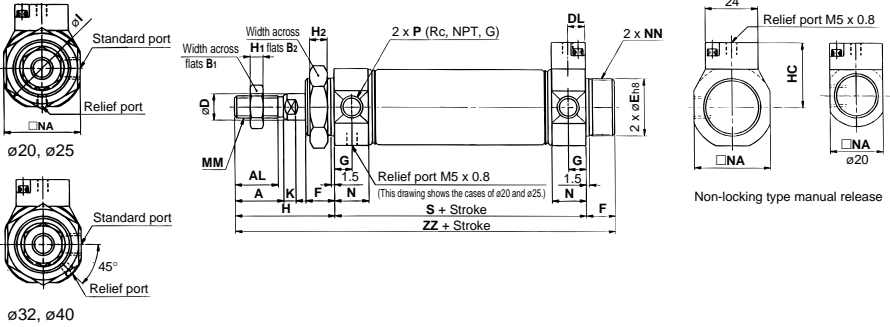

Bore size	A	AL	B ₁	B ₂	D	DL	E	F	G	H	H ₁	H ₂	HC	I	K	MM	N	NA	NN	P	S	ZZ
20	18	15.5	13	26	8	7.5	20 ⁰ _{-0.033}	13	8	41	5	8	24	28	5	M8 x 1.25	15	24	M20 x 1.5	1/8	62	116
25	22	19.5	17	32	10	7.5	26 ⁰ _{-0.033}	13	8	45	6	8	27	33.5	5.5	M10 x 1.25	15	30	M26 x 1.5	1/8	62	120
32	22	19.5	17	32	12	7.5	26 ⁰ _{-0.033}	13	8	45	6	8	29.3	37.5	5.5	M10 x 1.25	15	34.5	M26 x 1.5	1/8	64	122
40	24	21	22	41	14	10.7	32 ⁰ _{-0.039}	16	11	50	8	10	33.3	46.5	7	M14 x 1.5	21.5	42.5	M32 x 2	1/4	88	154

Axial Foot (L): ¹⁰⁻₁₁₋CBM2L, ²¹⁻₂₂₋CBM2L

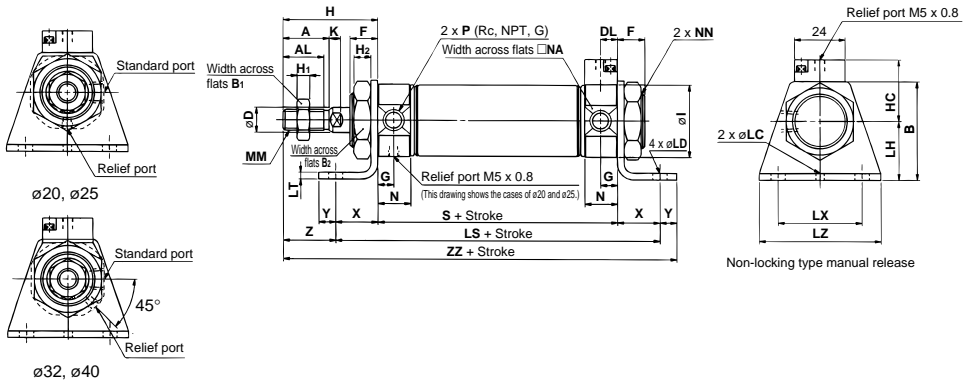

Bore size	A	AL	B	B ₁	B ₂	D	DL	F	G	H	H ₁	H ₂	HC	I	K	LC	LD	LH	LS	LT	LX	LZ	MM
20	18	15.5	40	13	26	8	7.5	13	8	41	5	8	24	28	5	4	6.8	25	102	3.2	40	55	M8 x 1.25
25	22	19.5	47	17	32	10	7.5	13	8	45	6	8	27	33.5	5.5	4	6.8	28	102	3.2	40	55	M10 x 1.25
32	22	19.5	47	17	32	12	7.5	13	8	45	6	8	29.3	37.5	5.5	4	6.8	28	104	3.2	40	55	M10 x 1.25
40	24	21	54	22	41	14	10.5	16	11	50	8	10	33.3	46.5	7	4	7	30	134	3.2	55	75	M14 x 1.5

Bore size	N	NA	NN	P	S	X	Y	Z	ZZ
20	15	24	M20 x 1.5	1/8	62	20	8	21	131
25	15	30	M26 x 1.5	1/8	62	20	8	25	135
32	15	34.5	M26 x 1.5	1/8	64	20	8	25	137
40	21.5	42.5	M32 x 2	1/4	88	23	10	27	171

Rod Flange (F): 10-**CBM2F**, 21-**CBM2F**

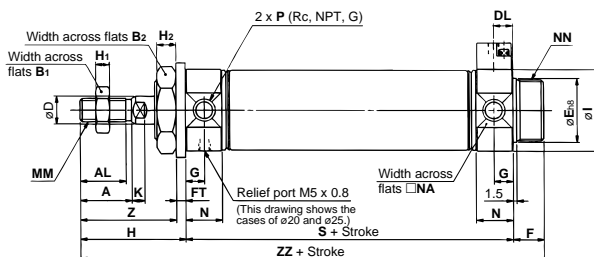
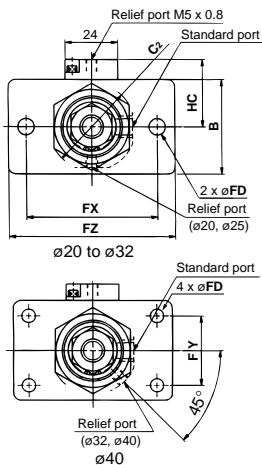

(mm)

Bore size	A	AL	B	B ₁	B ₂	C ₂	D	DL	E	F	FD	FT	FX	FY	FZ	G	H	H ₁	H ₂	HC	I	K	MM
20	18	15.5	34	13	26	30	8	7.5	20 ^{0.033}	13	7	4	60	—	75	8	41	5	8	24	28	5	M8 x 1.25
25	22	19.5	40	17	32	37	10	7.5	26 ^{0.033}	13	7	4	60	—	75	8	45	6	8	27	33.5	5.5	M10 x 1.25
32	22	19.5	40	17	32	37	12	7.5	26 ^{0.033}	13	7	4	60	—	75	8	45	6	8	29.3	37.5	5.5	M10 x 1.25
40	24	21	52	22	41	47.3	14	10.5	32 ^{0.039}	16	7	5	66	36	82	11	50	8	10	33.3	46.5	7	M14 x 1.5

(mm)

Bore size	N	NA	NN	P	S	Z	ZZ
20	15	24	M20 x 1.5	1/8	62	37	116
25	15	30	M26 x 1.5	1/8	62	41	120
32	15	34.5	M26 x 1.5	1/8	64	41	122
40	21.5	42.5	M32 x 2	1/4	88	45	154

Head Flange (G): ¹⁰⁻**CBM2G**, ²¹⁻**CBM2G**

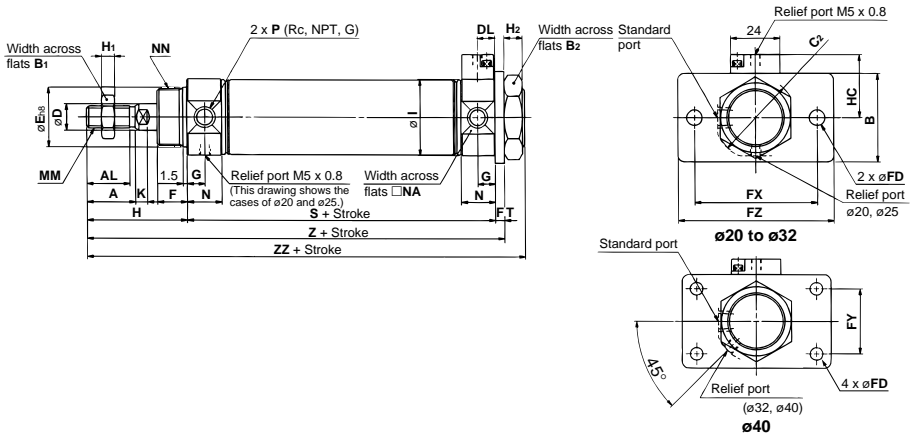

(mm)

Bore size	A	AL	B	B ₁	B ₂	C ₂	D	DL	E	F	FD	FT	FX	FY	FZ	G	H	H ₁	H ₂	HC	I	K	MM
20	18	15.5	34	13	26	30	8	7.5	20 ⁰ _{-0.033}	13	7	4	60	—	75	8	41	5	8	24	28	5	M8 x 1.25
25	22	19.5	40	17	32	37	10	7.5	26 ⁰ _{-0.033}	13	7	4	60	—	75	8	45	6	8	27	33.5	5.5	M10 x 1.25
32	22	19.5	40	17	32	37	12	7.5	26 ⁰ _{-0.033}	13	7	4	60	—	75	8	45	6	8	29.3	37.5	5.5	M10 x 1.25
40	24	21	52	22	41	47.3	14	10.7	32 ⁰ _{-0.039}	16	7	5	66	36	82	11	50	8	10	33.3	46.5	7	M14 x 1.5

(mm)

Bore size	N	NA	NN	P	S	Z	ZZ
20	15	24	M20 x 1.5	1/8	62	107	116
25	15	30	M26 x 1.5	1/8	62	111	120
32	15	34.5	M26 x 1.5	1/8	64	113	122
40	21.5	42.5	M32 x 2	1/4	88	143	154

Directional Control Valves

Air Cylinders

Rotary Actuators

Air Grippers

Air Preparation Equipment

Modular F. R.

Pressure Control Equipment

Fittings & Tubing

Flow Control Equipment

Pressure Switches/ Pressure Sensors

⚠ Specific Product Precautions

Be sure to read this before handling.

Use the recommended pneumatic circuit.

⚠ Caution

1. This is necessary for proper operation and release of the lock.

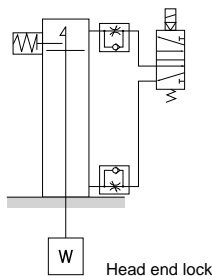

Handling

⚠ Caution

1. **Do not use 3 position solenoid valves.**

Avoid use in combination with 3 position solenoid valves (especially closed center metal seal types). If pressure is trapped in the port on the lock mechanism side, the cylinder cannot be locked.

Furthermore, even after being locked, the lock may be released after some time, due to air leaking from the solenoid valve and entering the cylinder.

2. **Back pressure is required to release end lock.**

Be sure air is supplied to the side of the cylinder without a lock mechanism, before starting up, as in the above figures. Otherwise, the lock may not be released. (Refer to "Releasing the Lock".)

3. **Release the lock when mounting or adjusting the cylinder.**

If mounting or other work is performed when the cylinder is locked, the lock unit may be damaged.

4. **Operate with a load ratio of 50% or less.**

If the load ratio exceeds 50%, this may cause problems such as failure of the lock to release, or damage to the lock unit.

5. **Do not operate multiple cylinders in synchronization.**

Avoid applications in which two or more end lock cylinders are synchronized to move one workpiece, as one of the cylinder locks may not be able to release when required.

6. **Use a speed controller with meter-out control.**

Lock cannot be released occasionally by meter-in control.

7. **Be sure to operate completely to the cylinder stroke end on the side with the lock.**

If the cylinder piston does not reach the end of the stroke, locking might not work or locking might not be released.

Operating Pressure

⚠ Caution

1. Supply air pressure of 0.15 MPa or higher to the port on the lock mechanism side, as it is necessary for releasing the lock.

Exhaust Speed

⚠ Caution

1. Locking will occur automatically if the pressure applied to the port on the lock mechanism side falls to 0.05 MPa or less. In cases where the piping on the lock mechanism side is long and thin, or the speed controller is separated at some distance from the cylinder port, the exhaust speed will be reduced. Take note that some time may be required for the lock to engage. In addition, clogging of a silencer mounted on the solenoid valve exhaust port can produce the same effect.

Releasing the Lock

⚠ Warning

1. Before releasing the lock, be sure to supply air to the side without the lock mechanism, so that there is no load applied to the lock mechanism when it is released. (Refer to the recommended pneumatic circuits.) If the lock is released when the port on the other side is in an exhaust state, and with a load applied to the lock unit, the lock unit may be subjected to an excessive force and be damaged. Furthermore, sudden movement of the piston rod is very dangerous.

Manual Release

⚠ Caution

1. Insert the accessory bolt from the top of the rubber cap, and after screwing it into the lock piston, pull it to release the lock. If you stop pulling the bolt, the lock will return to an operating state. Bolt sizes, pulling forces and strokes are as shown below.

Bore size (mm)	Bolt size	Pulling force	Stroke (mm)
ø20, ø25, ø32	M2.5 x 0.45 x 25 L or more	4.9 N	2
ø40	M3 x 0.5 x 30 L or more	10 N	3

Remove the bolt for normal operation.

It can cause lock malfunction or faulty release.

Series 10-/11-21-/22-CG1-Z

ø20, ø25, ø32, ø40, ø50, ø63, ø80, ø100
Air Cylinder: Double acting, Single rod



How to Order

Clean series

10	Relief type
11	Vacuum suction type

Built-in magnet

Nil	No
D	With auto switch (Built-in magnet)

Type

N	Rubber bumper, ø20 to ø100
A	Air cushion, ø40 to ø63*

* Clean series 10-/11- only

Bore size (mm)

Mounting

B*	Basic
L	Axial foot
F	Rod flange
G	Head flange

* No trunnion mounting female thread is provided for clean series.

Auto switch

Solid state	M9B, M9BW, K59, K59W
Reed switch	A93, B54

Number of auto switches

Nil	2 pcs.
S	1 pc.
n	n pcs.

Rod end thread

Nil	Male rod end
F	Female rod end

Cylinder stroke (mm)

Model

10 - C D G 1 B N 40 - 150 Z - M9BW

21 - C D G 1 B N 40 - 150 Z - M9BW



Model

Model	Bore size (mm)	Port size	Lubrication	Action	Standard stroke ^{Note 2)} (mm)	Long stroke (mm) ^{Note 1) Note 2)}	Auto switch mounting	Cushion	
								Rubber	Air
Relief type	10-/21-CG1□20	20	Non-lube	Double acting, Single rod	25, 50, 75, 100, 125, 150, 200	Up to 1500	○	○	○ ^{Note 3)} (ø40 to ø63)
	10-/21-CG1□25	25							
	10-/21-CG1□32	32							
	10-/21-CG1□40	40							
	10-/21-CG1□50	50							
	10-/21-CG1□63	63							
Vacuum suction type	10-/21-CG1□80	80	Non-lube	Double acting, Single rod	25, 50, 75, 100, 125, 150, 200	Up to 1500	○	○	○ ^{Note 3)} (ø40 to ø63)
	10-/21-CG1□100	100							
	11-/22-CG1□20	20							
	11-/22-CG1□25	25							
	11-/22-CG1□32	32							
	11-/22-CG1□40	40							
11-/22-CG1□50	50								
11-/22-CG1□63	63								
11-/22-CG1□80	80								
11-/22-CG1□100	100								

Note 1) When exceeding the standard strokes above, the particle generation class may not be satisfied.
 Note 2) Intermediate strokes and long strokes not listed above are produced upon receipt of order.
 Note 3) Available only for clean series 10-/11-

Specifications

Item	Bore size (mm)									
	20	25	32	40	50	63	80	100		
Proof pressure	1.5 MPa									
Maximum operating pressure	1.0 MPa									
Minimum operating pressure	0.05 MPa									
Ambient and fluid temperature	Without auto switch: -10°C to 70°C With auto switch: -10°C to 60°C (No freezing)									
Piston speed	10-/11-: 30 to 400 mm/s, 21-/22-: 50 to 400 mm/s									
Stroke length tolerance	Up to 1000 ^{+1.4} mm, Up to 1500 ^{+1.8} mm									
Mounting	Basic/Axial foot Rod flange/Head flange									
Grease	10-/11-: Fluorine grease 21-/22-: Lithium soap based grease									
Cleanliness class (ISO class)	10-: Class 4, 21-: Class 5 11-/22-: Class 3									
Allowable kinetic energy (J)	Rubber bumper	Male rod end	0.28	0.41	0.66	1.20	2.00	3.40	5.90	9.90
		Female rod end	0.11	0.18	0.29	0.52	0.91	1.54	2.71	4.54
	Air cushion	Male rod end	—	—	—	1.80	3.40	4.90	—	—
		Female rod end	—	—	—	0.52	0.91	1.54	—	—

Note) Operate the cylinder within the allowable kinetic energy.

Suction Flow Rate of Vacuum Suction Type (Reference values)

Bore size	Suction flow rate L/min (ANR)
20/25/32/40	10
50/63/80/100	20

Applicable Auto Switches (Refer to the WEB catalog for auto switches not in the following table.)

Type	Special function	Electrical entry	Indicator/light	Wiring (Output)	Load voltage		Auto switch model		Lead wire length (mm) ²				Applicable load		
					DC	AC	Applicable bore size	0.5 (Nil)	1 (M)	3 (L)	5 (Z)	Pre-wired connector			
Solid state auto switch	—	Grommet	Yes	3-wire (NPN)	5 V, 12 V	—	M9N	●	●	●	○	○	IC circuit	Relay, PLC	
				—			G59	●	—	●	○	○			
				3-wire (PNP)	M9P		—	●	—	○	○	○			
				—	G5P		●	—	●	○	○	○			
				2-wire	M9B		—	●	—	●	○	○			○
	Diagnostic indication (2-color indication)	Grommet	Yes	3-wire (NPN)	12 V		M9NW	—	●	—	●	○	○		IC circuit
				—	G59W		—	●	—	●	○	○			
				3-wire (PNP)	5 V, 12 V		M9PW	—	●	—	●	○	○		
				—	G5PW		—	●	—	●	○	○			
				2-wire	M9BW		—	●	—	●	○	○	○		
Reed auto switch	—	Grommet	No	2-wire	24 V	100 V	A93	—	●	—	●	—	IC circuit	Relay, PLC	
						100 V or less	A90	—	●	—	●	—			
						100 V, 200 V	B54	—	●	—	●	—			
						200 V or less	B64	—	●	—	●	—			

* Lead wire length symbols: 0.5 m.....Nil (Example) M9NW
 1 m..... M (Example) M9NWM
 3 m..... L (Example) M9NWL
 5 m..... Z (Example) M9NWZ

* Solid state auto switches marked with "○" are produced upon receipt of order. PLC: Programmable Logic Controller

* For applicable auto switches other than listed above, refer to the table in the dashed line on the last page of the auto switch mounting section of the standard cylinder series in the WEB catalog.

Refer to page 889 for the applicable auto switch list.

Auto Switch Proper Mounting Position (Detection at Stroke End) and Its Mounting Height

Solid state auto switch

D-M9□, M9□W
 ø20 to ø63

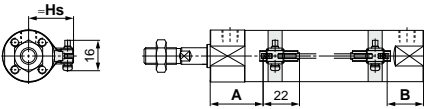

A and B are the dimensions from the end of the head cover/rod cover to the end of the auto switch.

D-G5, K5, G5□W
D-K59W
 ø20 to ø100

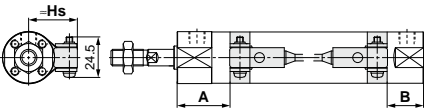

Reed auto switch

D-A9□
 ø20 to ø63

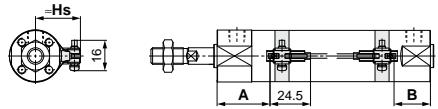

A and B are the dimensions from the end of the head cover/rod cover to the end of the auto switch.

D-B5, B6
 ø20 to ø100

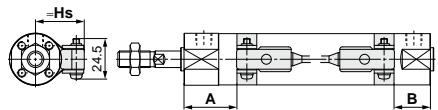

Auto Switch Proper Mounting Position (Detection at Stroke End) (mm) Auto Switch Mounting Height (mm)

Auto switch model	D-M9□ D-M9□W		D-A9□		D-G5□/K59 D-G5□W/K59W		D-B5□ D-B64		Auto switch model	D-M9□ D-M9□W D-A9□		D-G5/K5 D-G5□W D-K59W D-B5/B6	
	A	B	A	B	A	B	A	B		Bore size	Hs	Hs	Hs
Bore size	20	41	24 (32)	37	20 (28)	33	16 (24)	31.5	14.5 (22.5)	20	24.5	27.5	27.5
	25	40.5	24.5 (32.5)	36.5	20.5 (28.5)	32.5	16.5 (24.5)	31	15 (23)	25	27	30	30
	32	42	25 (33)	38	21 (29)	34	17 (25)	32.5	15.5 (23.5)	32	30.5	33.5	33.5
	40	39	27 (36)	35	23 (32)	31	19 (28)	29.5	17.5 (26.5)	40	35	38	38
	50	46	32 (44)	42	28 (40)	38	24 (36)	36.5	22.5 (34.5)	50	40.5	43.5	43.5
	63	44.5	33.5 (45.5)	40.5	29.5 (41.5)	36.5	25.5 (37.5)	35	24 (36)	63	47.5	50.5	50.5
	80	—	—	—	—	49.5	30.5 (44.5)	48	29 (43)	80	—	59	59
	100	—	—	—	—	48.5	31.5 (45.5)	47	30 (44)	100	—	69.5	69.5

Note 1) Values in parentheses are for the long stroke type.
 Note 2) Adjust the auto switch after confirming the operating state in the actual setting.

Auto Switch Mounting Brackets/Part no.

Auto switch model	Bore size (mm)							
	20	25	32	40	50	63	80	100
D-M9□ D-M9□W D-A9□	BMA3-020 (A set of a, b, c, d)	BMA3-025 (A set of a, b, c, d)	BMA3-032 (A set of a, b, c, d)	BMA3-040 (A set of a, b, c, d)	BMA3-050 (A set of a, b, c, d)	BMA3-063 (A set of a, b, c, d)	—	—
<p>* Band (c) is mounted so that the projected part is on the internal side (contact side with the tube).</p>								
D-B5□/B64 D-G5□/K59 D-G5□W/K59W	BA-01 (A set of band and screw)	BA-02 (A set of band and screw)	BA-32 (A set of band and screw)	BA-04 (A set of band and screw)	BA-05 (A set of band and screw)	BA-06 (A set of band and screw)	BA-08 (A set of band and screw)	BA-10 (A set of band and screw)

Note) Since the switch bracket (made from nylon) are affected in an environment where alcohol, chloroform, methylamines, hydrochloric acid or sulfuric acid is splashed over, so it cannot be used.
Please contact SMC regarding other chemicals.

Directional Control Valves
Air Cylinders
Rotary Actuators
Air Grippers
Air Preparation Equipment
Modular F. R.
Pressure Control Equipment
Fittings & Tubing
Flow Control Equipment
Pressure Switches/ Pressure Sensors

Air Cylinder 10-11-CG1-Z/21-22-CG1-Z

Basic (B): 10-CG1B, 21-CG1B

With rubber bumper

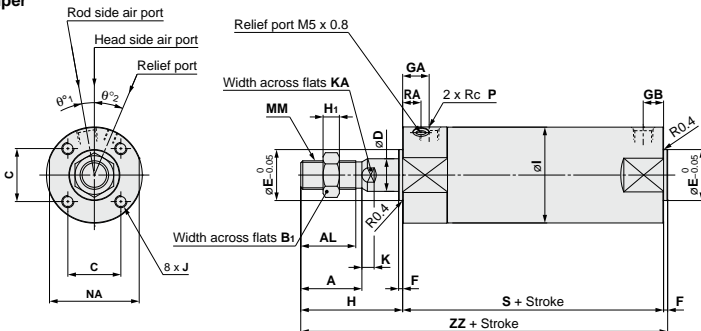

Female rod end

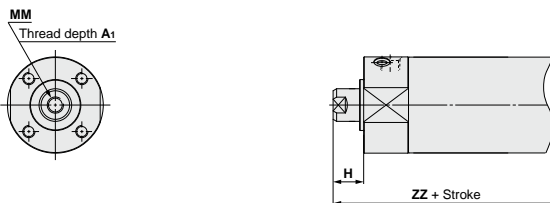

With air cushion

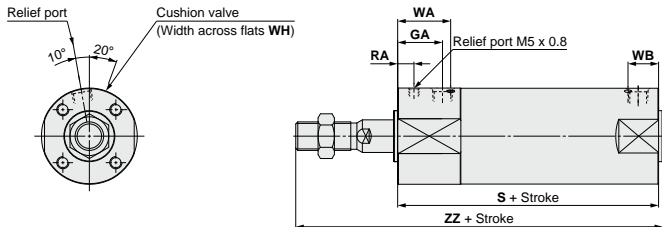

Bore size	Stroke range		A	AL	B ₁	C	D	E	F	GA	GB	H	H ₁	I	J	K	KA	MM	NA	P	RA	S	θ ¹	θ ²	ZZ
	Standard	Long																							
20	Up to 200	201 to 1500	18	15.5	13	14	8	12	2	20	10 (12)	35	5	26	M4 x 0.7 depth 7	5	6	M8 x 1.25	24	1/8	7	77 (85)	0	0	114 (122)
25			22	19.5	17	16.5	10	14	2	20	10 (12)	40	6	31	M5 x 0.8 depth 7.5	5.5	8	M10 x 1.25	29	1/8	7	77 (85)	0	0	119 (127)
32			22	19.5	17	20	12	18	2	20	10 (12)	40	6	38	M5 x 0.8 depth 8	5.5	10	M10 x 1.25	35.5	1/8	7	79 (87)	0	0	121 (129)
40			30	27	19	26	16	25	2	13	10 (13)	50	8	47	M6 x 1 depth 12	6	14	M14 x 1.5	44	1/8	9	78 (87)	10	23	130 (139)
50	Up to 300	301 to 1500	35	32	27	32	20	30	2	14	12 (14)	58	11	58	M8 x 1.25 depth 16	7	18	M18 x 1.5	55	1/4	10	90 (102)	10	23	150 (162)
63			35	32	27	38	20	32	2	14	12 (14)	58	11	72	M10 x 1.5 depth 16	7	18	M18 x 1.5	69	1/4	10	90 (102)	10	20	150 (162)
80			40	37	32	50	25	40	3	20	16 (20)	71	13	89	M10 x 1.5 depth 22	10	22	M22 x 1.5	86	3/8	10	108 (122)	10	20	182 (196)
100			40	37	41	60	30	50	3	20	16 (20)	71	16	110	M12 x 1.75 depth 22	10	26	M26 x 1.5	106	1/2	10	108 (122)	10	20	182 (196)

* No trunnion mounting female thread is provided for clean series.
() : Denotes the dimensions for long stroke.

Female rod end (mm)

Bore size	A ₁	H	MM	ZZ	
				Rubber	Air
20	8	13	M4 x 0.7	92 (100)	—
25	8	14	M5 x 0.8	93 (101)	—
32	12	14	M6 x 1.0	95 (103)	—
40	13	15	M8 x 1.25	95 (104)	104 (113)
50	18	16	M10 x 1.5	108 (120)	120 (132)
63	18	16	M10 x 1.5	108 (120)	120 (132)
80	21	19	M14 x 1.5	130 (144)	—
100	25	22	M16 x 1.5	133 (147)	—

With air cushion (mm)

Bore size	GA	S	RA	WA	WB	WH	ZZ
40	22	87 (96)	8	26	15 (17)	1.5	139 (148)
50	26	102 (114)	9	30	16 (18)	3	162 (174)
63	26	102 (114)	9	30	17 (18)	3	162 (174)

Axial Foot (L): ¹⁰⁻CG1L, ²¹⁻CG1L

With rubber bumper

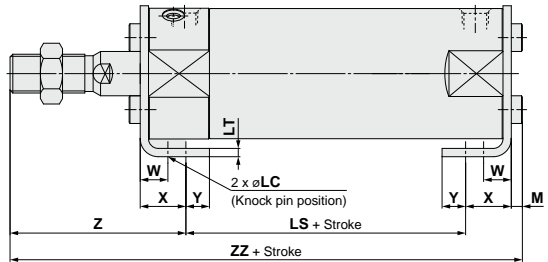
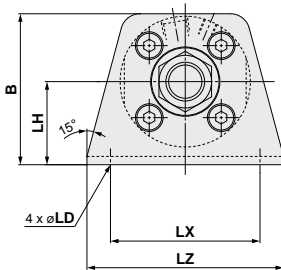

(mm)

Bore size	B	LC	LD	LH	LS	LT	LX	LZ	M	W	X	Y	Z	ZZ
20	34	4	6	20	53 (61)	3	32	44	3	10	15	7	47	118 (126)
25	38.5	4	6	22	53 (61)	3	36	49	3.5	10	15	7	52	123.5 (131.5)
32	45	4	7	25	53 (61)	3	44	58	3.5	10	16	8	53	125.5 (133.5)
40	54.5	4	7	30	51 (60)	3	54	71	4	10	16.5	8.5	63.5	135 (144)
50	70.5	5	10	40	55 (67)	4.5	66	86	5	17.5	22	11	75.5	157.5 (169.5)
63	82.5	5	12	45	55 (67)	4.5	82	106	5	17.5	22	13	75.5	157.5 (169.5)
80	101	6	11	55	60 (74)	4.5	100	125	5	20	28.5	14	95	188.5 (202.5)
100	121	6	14	65	60 (74)	6	120	150	7	20	30	16	95	192 (206)

* Other dimensions are the same as basic type.

* For female rod end, since the wrench flap (K and KA portions) will be inside of the bracket when the piston rod is retracted at the stroke end, extend the piston rod to tighten the nut using a tool, and mount a workpiece on the rod end.

* Refer to the basic type for the female rod end.
Note () : Denotes the dimensions for long stroke.

With air cushion

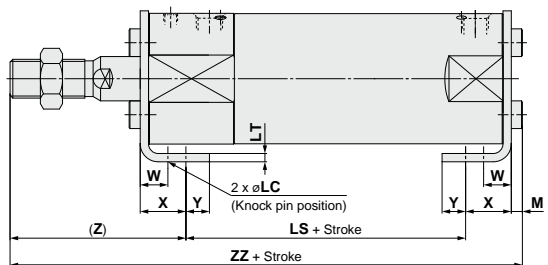
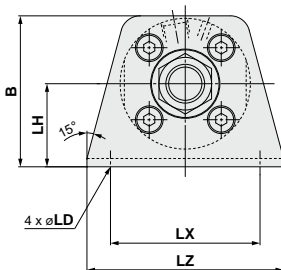

(mm)

Bore size	B	LC	LD	LH	LS	LT	LX	LZ	M	W	X	Y	Z	ZZ
40	54.5	4	7	30	60 (69)	3	54	71	4	10	16.5	8.5	63.5	144 (153)
50	70.5	5	10	40	67 (79)	4.5	66	86	5	17.5	22	11	75.5	169.5 (181.5)
63	82.5	5	12	45	67 (79)	4.5	82	106	5	17.5	22	13	75.5	169.5 (181.5)

* Other dimensions are the same as basic type.

* For female rod end, since the wrench flap (K and KA portions) will be inside of the bracket when the piston rod is retracted at the stroke end, extend the piston rod to tighten the nut using a tool, and mount a workpiece on the rod end.

* Refer to the basic type for the female rod end.
Note () : Denotes the dimensions for long stroke.

Directional Control Valves
 Air Cylinders
 Rotary Actuators
 Air Grippers
 Air Preparation Equipment
 Modular F. R.
 Pressure Control Equipment
 Fittings & Tubing
 Flow Control Equipment
 Pressure Switches/ Pressure Sensors

Rod Flange (F): 10-11:CG1F, 21-22:CG1F

With rubber bumper

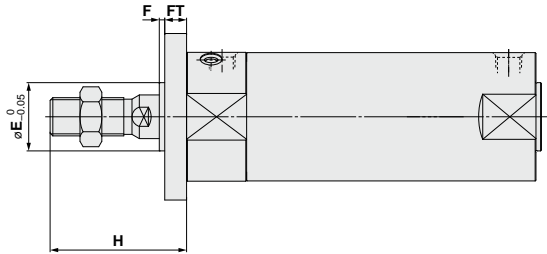
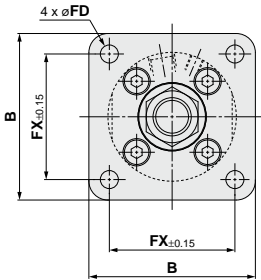

(mm)

Bore size	B	E	F	FX	FD	FT
20	40	12	2	28	5.5	6
25	44	14	2	32	5.5	7
32	53	18	2	38	6.6	7
40	61	25	2	46	6.6	8
50	76	30	2	58	9	9
63	92	32	2	70	11	9
80	104	40	3	82	11	11
100	128	50	3	100	14	14

Note) End boss is machined on the flange for øE.
 * Other dimensions are the same as basic type.
 * Refer to the basic type for the female rod end.

With air cushion

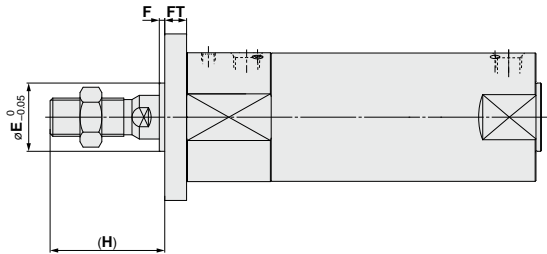
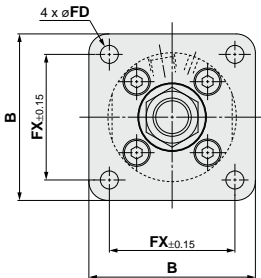

(mm)

Bore size	B	E	F	FX	FD	FT
40	61	25	2	46	6.6	8
50	76	30	2	58	9	9
63	92	32	2	70	11	9

Note) End boss is machined on the flange for øE.
 * Other dimensions are the same as basic type.
 * Refer to the basic type for the female rod end.

Head Flange (G): ¹⁰⁻CG1G, ²¹⁻CG1G

With rubber bumper

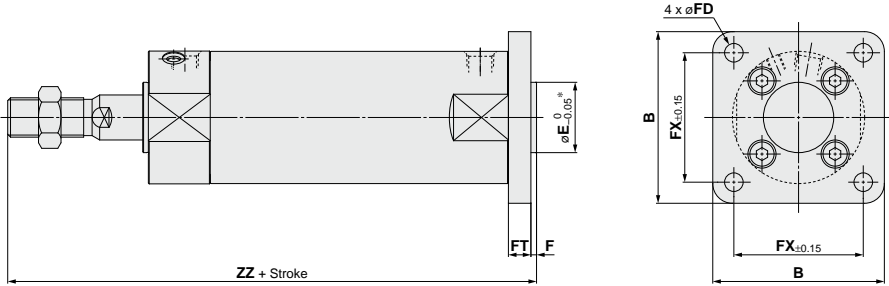

(mm)

Bore size	B	E	F	FX	FD	FT	ZZ
20	40	12	2	28	5.5	6	120 (128)
25	44	14	2	32	5.5	7	126 (134)
32	53	18	2	38	6.6	7	128 (136)
40	61	25	2	46	6.6	8	138 (147)
50	76	30	2	58	9	9	159 (171)
63	92	32	2	70	11	9	159 (171)
80	104	40	3	82	11	11	193 (207)
100	128	50	3	100	14	14	196 (210)

Note) End boss is machined on the flange for øE.
 * Other dimensions are the same as basic type.
 * Refer to the basic type for the female rod end.
 Note) () : Denotes the dimensions for long stroke.

With air cushion

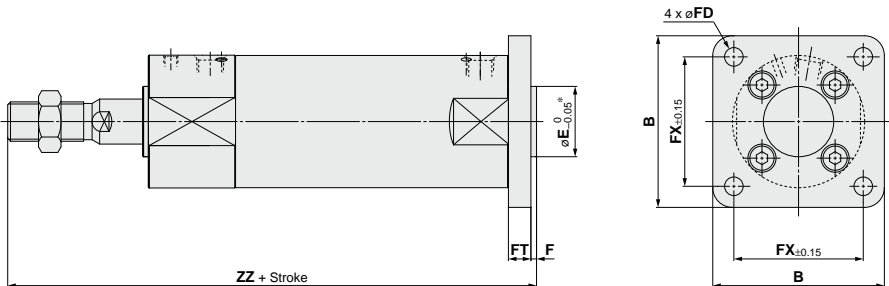

(mm)

Bore size	B	E	F	FX	FD	FT	ZZ
40	61	25	2	46	6.6	8	147 (156)
50	76	30	2	58	9	9	171 (183)
63	92	32	2	70	11	9	171 (183)

Note) End boss is machined on the flange for øE.
 * Other dimensions are the same as basic type.
 * Refer to the basic type for the female rod end.
 Note) () : Denotes the dimensions for long stroke.

Directional Control Valves
 Air Cylinders
 Rotary Actuators
 Air Grippers
 Air Preparation Equipment
 Modular F. R.
 Pressure Control Equipment
 Fittings & Tubing
 Flow Control Equipment
 Pressure Switches/ Pressure Sensors

Series 10-11-CG1W-Z ø20, ø25, ø32, ø40, ø50, ø63, ø80, ø100 Double Rod Cylinder

How to Order

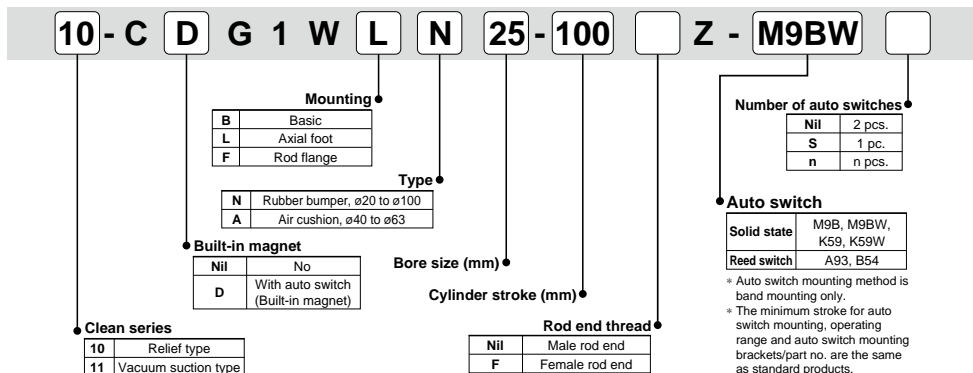

Model

	Model	Bore size (mm)	Port size	Lubrication	Action	Standard stroke (mm)	Auto switch mounting	Cushion		
								Rubber	Air	
Relief type	10-CG1W□20	20	1/8	Non-lube	Double acting, Double rod	25, 50, 75, 100, 125, 150, 200	○	○	○ (ø40 to ø63)	
	10-CG1W□25	25								
	10-CG1W□32	32								
	10-CG1W□40	40								
	10-CG1W□50	50								
	10-CG1W□63	63								
Vacuum suction type	10-CG1W□80	80	3/8		Non-lube	Double acting, Double rod	25, 50, 75, 100, 125, 150, 200	○	○	○ (ø40 to ø63)
	10-CG1W□100	100								
	11-CG1W□20	20								
	11-CG1W□25	25								
	11-CG1W□32	32								
	11-CG1W□40	40								
	11-CG1W□50	50								
	11-CG1W□63	63								
	11-CG1W□80	80								
	11-CG1W□100	100								

Specifications

Item	Bore size (mm)									
	20	25	32	40	50	63	80	100		
Proof pressure	1.5 MPa									
Maximum operating pressure	1.0 MPa									
Minimum operating pressure	0.05 MPa									
Ambient and fluid temperature	Without auto switch: -10°C to 70°C, With auto switch: -10°C to 60°C (No freezing)									
Piston speed	10-/11-: 30 to 400 mm/s									
Stroke length tolerance	Up to 300st ^{+1.4} mm									
Mounting	Basic/Axial foot/Rod flange									
Grease	10-/11-: Fluorine grease									
Cleanliness class (ISO class)	10-: Class 4									
	11-: Class 3									
Allowable kinetic energy (J)	Rubber bumper	Male rod end	0.28	0.41	0.66	1.20	2.00	3.40	5.90	9.90
		Female rod end	0.11	0.18	0.29	0.52	0.91	1.54	2.71	4.54

Suction Flow Rate of Vacuum Suction Type (Reference values)

Size	Suction flow rate L/min (ANR)
20/25/32/40	10
50/63/80/100	20

Air Cylinder $\frac{10}{11}$ -CG1W-Z

Axial Foot (L): $\frac{10}{11}$ -CG1WL

With rubber bumper

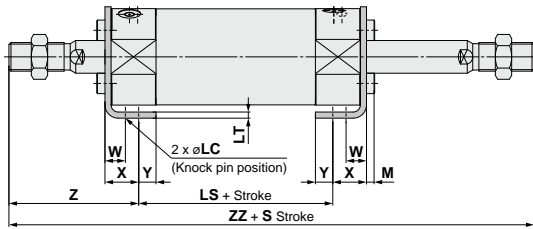
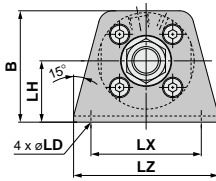

(mm)

Bore size	B	LC	LD	LH	LS	LT	LX	LZ	M	W	X	Y	Z	ZZ
20	34	4	6	20	69	3	32	44	3	10	15	7	47	163
25	38.5	4	6	22	69	3	36	49	3.5	10	15	7	52	173
32	45	4	7	25	69	3	44	58	3.5	10	16	8	53	175
40	54.5	4	7	30	60	3	54	71	4	10	16.5	8.5	63.5	187
50	70.5	5	10	40	67	4.5	66	86	5	17.5	22	11	75.5	218
63	82.5	5	12	45	67	4.5	82	106	5	17.5	22	13	75.5	218
80	101	6	11	55	74	4.5	100	125	5	20	28.5	14	95	264
100	121	6	14	65	74	6	120	150	7	20	30	16	95	264

* Other dimensions are the same as basic type.

* For female rod end, since the wrench flap (K and KA portions) will be inside of the bracket when the piston rod is retracted at the stroke end, extend the piston rod to tighten the nut using a tool, and mount a workpiece on the rod end.

* Refer to the basic type for the female rod end.

With air cushion

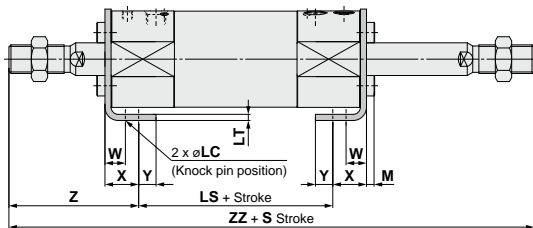
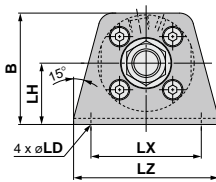

(mm)

Bore size	B	LC	LD	LH	LS	LT	LX	LZ	M	W	X	Y	Z	ZZ
40	54.5	4	7	30	78	3	54	71	4	10	16.5	8.5	63.5	205
50	70.5	5	10	40	91	4.5	66	86	5	17.5	22	11	75.5	242
63	82.5	5	12	45	91	4.5	82	106	5	17.5	22	13	75.5	242

* Other dimensions are the same as basic type.

* For female rod end, since the wrench flap (K and KA portions) will be inside of the bracket when the piston rod is retracted at the stroke end, extend the piston rod to tighten the nut using a tool, and mount a workpiece on the rod end.

* Refer to the basic type for the female rod end.

Rod Flange (F): ¹⁰⁻₁₁₋CG1WF

With rubber bumper

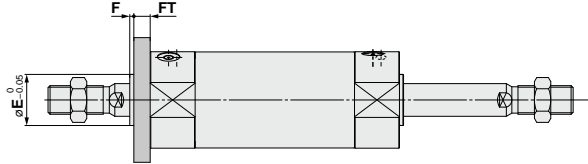
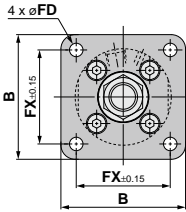

(mm)

Bore size	B	E	F	FX	FD	FT
20	40	12	2	28	5.5	6
25	44	14	2	32	5.5	7
32	53	18	2	38	6.6	7
40	61	25	2	46	6.6	8
50	76	30	2	58	9	9
63	92	32	2	70	11	9
80	104	40	3	82	11	11
100	128	50	3	100	14	14

Note) End boss is machined on the flange for øE.
 * Other dimensions are the same as basic type.
 * Refer to the basic type for the female rod end.

With air cushion

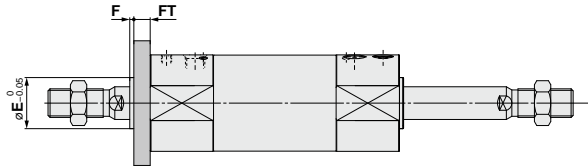
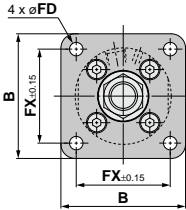

(mm)

Bore size	B	E	F	FX	FD	FT
40	61	25	2	46	6.6	8
50	76	30	2	58	9	9
63	92	32	2	70	11	9

Note) End boss is machined on the flange for øE.
 * Other dimensions are the same as basic type.
 * Refer to the basic type for the female rod end.

Directional Control Valves

Air Cylinders

Rotary Actuators

Air Grippers

Air Preparation Equipment

Modular F. R.

Pressure Control Equipment

Fittings & Tubing

Flow Control Equipment

Pressure Switches/ Pressure Sensors

Series 10-11-CG1R-Z $\phi 20, \phi 25, \phi 32, \phi 40, \phi 50, \phi 63$ Direct Mount Cylinder

How to Order

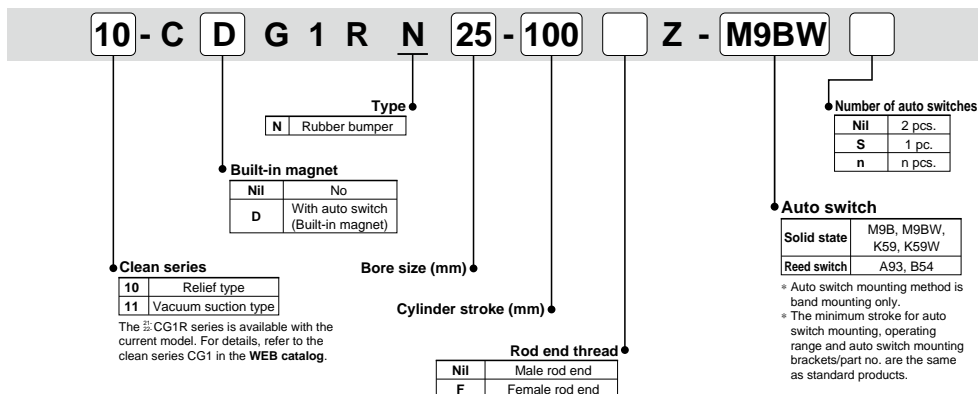

Model

Model		Bore size (mm)	Port size	Lubrication	Action	Standard stroke (mm)	Auto switch mounting	Cushion						
								Rubber	Air					
Relief type	10-CG1RN20	20	1/8	Non-lube	Double acting,	25, 50, 75, 100, 125, 150	○	○	—					
	10-CG1RN25	25				25, 50, 75, 100, 125, 150, 200								
	10-CG1RN32	32				25, 50, 75, 100, 125, 150, 200, 250, 300								
	10-CG1RN40	40												
	10-CG1RN50	50												
10-CG1RN63	63	1/4												
Vacuum suction type	11-CG1RN20	20	1/8			Non-lube				Single rod	25, 50, 75, 100, 125, 150	○	○	—
	11-CG1RN25	25									25, 50, 75, 100, 125, 150, 200			
	11-CG1RN32	32									25, 50, 75, 100, 125, 150, 200, 250, 300			
	11-CG1RN40	40												
	11-CG1RN50	50												
	11-CG1RN63	63		1/4										

Specifications

Item	Bore size (mm)							
	20	25	32	40	50	63		
Proof pressure	1.5 MPa							
Maximum operating pressure	1.0 MPa							
Minimum operating pressure	0.05 MPa							
Ambient and fluid temperature	Without auto switch: -10°C to 70°C , With auto switch: -10°C to 60°C (No freezing)							
Piston speed	10-11: 30 to 400 mm/s							
Stroke length tolerance	UP to $300^{+1.4}_0$ mm							
Grease	10-11: Fluorine grease							
Cleanliness class (ISO class)	10: Class 4							
	11: Class 3							
Allowable kinetic energy (J)	Rubber bumper	Male rod end	0.28	0.41	0.66	1.20	2.00	3.40
		Female rod end	0.11	0.18	0.29	0.52	0.91	1.54

Suction Flow Rate of Vacuum Suction Type (Reference values)

Size	Suction flow rate L/min (ANR)
20/25/32/40	10
50/63	20

Applicable Switch Specifications (Refer to the WEB catalog for auto switches not in the following table.)

Type	Special function	Electrical entry	Indicator/light	Wiring (Output)	Load voltage		Auto switch model Applicable bore size ø20 to ø63	Lead wire length (m) [*]				Pre-wired connector	Applicable load					
					DC	AC		0.5 (Nil)	1 (M)	3 (L)	5 (Z)		IC circuit	Relay, PLC				
Solid state auto switch	—	Grommet	Yes	3-wire (NPN)	5 V, 12 V	—	M9N	●	●	●	○	○			IC circuit	Relay, PLC		
				3-wire (PNP)			—	●	—	●	○	○						
				2-wire	12 V		M9B	●	●	●	○	○						
	Diagnostic indication (2-color indication)			Grommet	Yes		3-wire (NPN)	24 V	—	M9NW	●	●	●	○	○		IC circuit	Relay, PLC
							3-wire (PNP)			—	●	—	●	○	○			
							2-wire	5 V, 12 V		M9PW	●	●	●	○	○			
										12 V	M9BW	●	●	●	○		○	
Reed auto switch	—	Grommet	2-wire	24 V	12 V	100 V	A93	●	—		●	—	IC circuit	Relay, PLC				
						100 V or less	A90	●	—	●	—							
						100 V, 200 V	B54	●	—	●	—							
						200 V or less	B64	●	—	●	—							

* Lead wire length symbols: 0.5 m..... Nil (Example) M9NW
 1 m..... M (Example) M9NWM
 3 m..... L (Example) M9NWL
 5 m..... Z (Example) M9NWZ

* Solid state auto switches marked with "○" are produced upon receipt of order.
 PLC: Programmable Logic Controller

Refer to page 889 for the applicable auto switch list.

* For applicable auto switches other than listed above, refer to the table in the dashed line on the last page of the auto switch mounting section of the standard cylinder series in the WEB catalog.

Auto Switch Proper Mounting Position (Detection at Stroke End)

D-M9□, M9□W

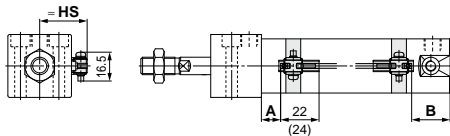

A and B are the dimensions from the end of the head cover/rod cover to the end of the auto switch.

D-A9□

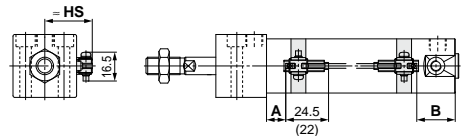

A and B are the dimensions from the end of the head cover/rod cover to the end of the auto switch.

Auto Switch Proper Mounting Position (Detection at Stroke End) (mm)

Auto switch model	D-M9□ D-M9□W D-M9□A		D-A9□	
	A	B	A	B
Bore size 20	12	24	8	20
25	11.5	24.5	7.5	20.5
32	13	25	9	21
40	18	27	14	23
50	20	32	16	28
63	18.5	33.5	14.5	29.5

Note) Adjust the auto switch after confirming the operating state in the actual setting.

Auto Switch Mounting Height (mm)

Auto switch model	D-M9□ D-M9□W D-M9□A D-A9□
Bore size	Hs
20	24.5
25	27
32	30.5
40	35
50	40.5
63	47.5

Air Cylinder 10-11-**CG1R-Z**

Basic: 19-11-**CG1RN**

Male thread type

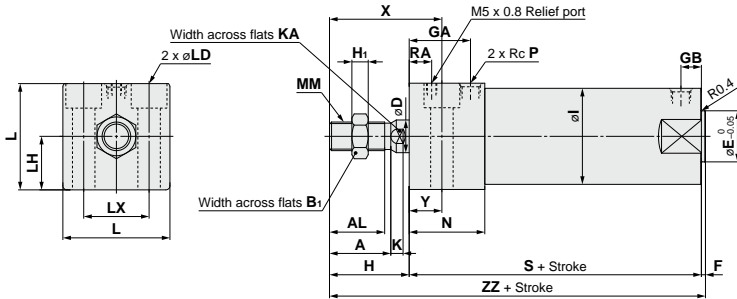

Female thread type

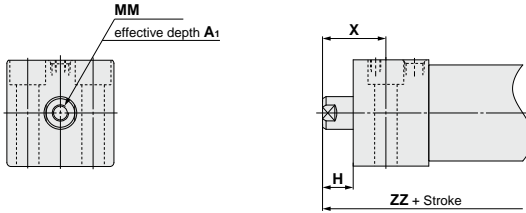

Bore size	Stroke range	A	AL	B ₁	D	E	F	GA	GB	H	H ₁	I	K	KA	L	LD	LH	LX	MM	N	P	RA	S	X	Y	ZZ
20	Up to 150	18	15.5	13	8	12	2	20	10	27	5	26	5	6	30.4	ø5.5, ø9.5 counterbore depth 6	15	18	M8 x 1.25	27	1/8	8	75	38	11	104
25	Up to 200	22	19.5	17	10	14	2	22	10	32	6	31	5.5	8	36.4	ø6.6, ø11 counterbore depth 7	18	22	M10 x 1.25	29	1/8	9	77	44	12	111
32	Up to 200	22	19.5	17	12	18	2	26	10	32	6	38	5.5	10	42.4	ø9, ø14 counterbore depth 9	21	24	M10 x 1.25	33	1/8	9	83	45	13	117
40	Up to 300	30	27	19	16	25	2	30	10	39	8	47	6	14	52.4	ø11, ø17.5 counterbore depth 12	26	32	M14 x 1.5	37	1/8	11	94	55	16	135
50	Up to 300	35	32	27	20	30	2	33	12	45	11	58	7	18	64.5	ø14, ø20 counterbore depth 14	32	41	M18 x 1.5	44	1/4	12	108	62	17	155
63	Up to 300	35	32	27	20	32	2	39	12	45	11	72	7	18	76.6	ø18, ø26 counterbore depth 18	38	46	M18 x 1.5	50	1/4	12	114	64	19	161

Female rod end (mm)

Bore size	A ₁	H	MM	X	ZZ
20	8	13	M4 x 0.7	24	90
25	8	14	M5 x 0.8	26	93
32	12	14	M6 x 1.0	27	99
40	13	15	M8 x 1.25	31	111
50	18	16	M10 x 1.5	33	126
63	18	16	M10 x 1.5	35	132

Series 10-/11- 21-/22-CA2

ø40, ø50, ø63 Air Cylinder

RoHS

How to Order

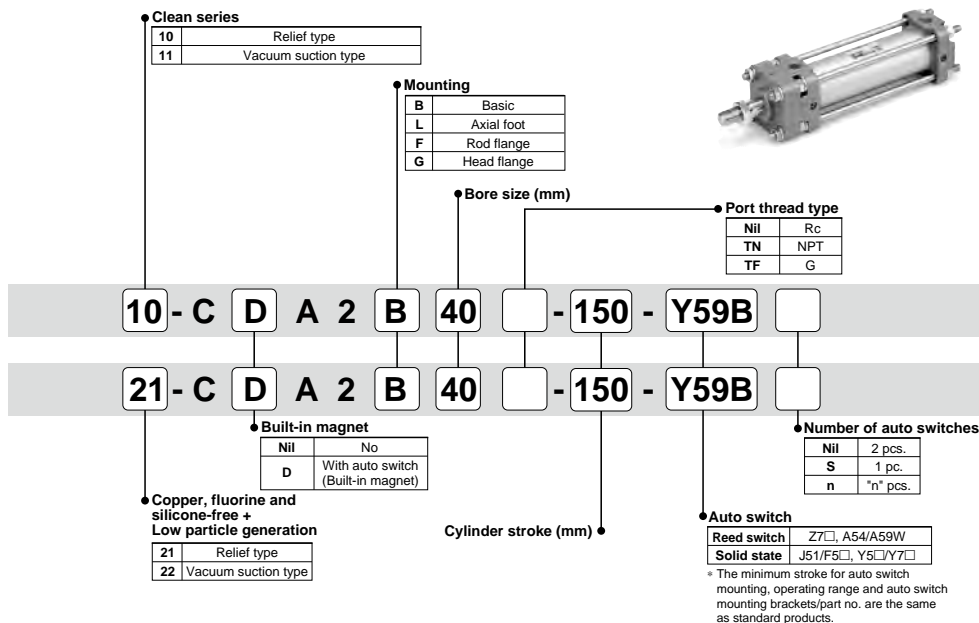

Clean series

10	Relief type
11	Vacuum suction type

Mounting

B	Basic
L	Axial foot
F	Rod flange
G	Head flange

Bore size (mm)

Port thread type

Nil	Rc
TN	NPT
TF	G

10 - C D A 2 B 40 [] - 150 - Y59B []

21 - C D A 2 B 40 [] - 150 - Y59B []

Built-in magnet

Nil	No
D	With auto switch (Built-in magnet)

Copper, fluorine and silicone-free + Low particle generation

21	Relief type
22	Vacuum suction type

Cylinder stroke (mm)

Auto switch

Reed switch	Z7□, A54/A59W
Solid state	J51/F5□, Y5□/Y7□

Number of auto switches

Nil	2 pcs.
S	1 pc.
n	"n" pcs.

* The minimum stroke for auto switch mounting, operating range and auto switch mounting brackets/part no. are the same as standard products.

Model

Model	Bore size (mm)	Port size	Lubrication	Action	Standard stroke (mm)	Auto switch mounting	Cushion	
Relief type	10-/21-CA2□40	40	Non-lube	Double acting, single rod	50, 75, 100, 125,	Available	Air cushion	
	10-/21-CA2□50	50						150, 200, 250, 300,
	10-/21-CA2□63	63						
Vacuum suction type	11-/22-CA2□40	40			3/8			
	11-/22-CA2□50	50						
	11-/22-CA2□63	63						

Note) Consult with SMC for long stroke.

Specifications

Item	Bore size (mm)
	40/50/63
Proof pressure	1.5 MPa
Maximum operating pressure	1.0 MPa
Minimum operating pressure	0.05 MPa
Ambient and fluid temperature	Without auto switch: -10°C to 70°C With auto switch: -10°C to 60°C (No freezing)
Piston speed	50 to 400 mm/s
Stroke length tolerance	Up to 250 ^{+1.0} mm, 251 to 1000 ^{+1.4} mm
Mounting	Basic/Axial foot/Rod flange/Head flange
Grease	10-/11-: Fluorine grease 21-/22-: Lithium soap based grease
Cleanliness class (ISO class)	10-: Class 4, 21-: Class 5
	11-/22-: Class 3

Suction Flow Rate of Vacuum Suction Type (Reference values)

Bore size	Suction flow rate L/min (ANR)
40	10
50/63	20

Applicable Auto Switch (Refer to the WEB catalog for further information on auto switches.)

Type	Special function	Electrical entry	Indicator light	Wiring (Output)	Load voltage		Auto switch model	Lead wire length (m) [*]			Pre-wire connector	Applicable load			
					DC	AC		0.5 (Nil)	3 (L)	5 (Z)		IC circuit			
Reed auto switch	—	Grommet	Yes	3-wire (NPN equivalent)	—	5 V	—	Z76	●	●	—	—	IC circuit	—	
				2-wire	24 V	12 V	100 V, 200 V	Z73	●	●	●	—	—	Relay, PLC	
		Diagnostic indication (2-color indication)	Grommet	—	—	A59W	●	●	—	—					
Solid state auto switch	—	Grommet	Yes	3-wire (NPN)	24 V	5 V, 12 V	—	Y59A	●	●	○	○	IC circuit	Relay, PLC	
				3-wire (PNP)				Y7P	●	●	○	○	IC circuit		
				2-wire				Y51	●	●	○	○	—		
	Diagnostic indication (2-color indication)	Grommet	—	—	24 V	5 V, 12 V	100 V, 200 V	Y59B	●	●	○	○	—		
								3-wire (NPN)	Y7NW	●	●	○	○		IC circuit
								3-wire (PNP)	Y7PW	●	●	○	○		IC circuit
	Water resistant (2-color indication)	Grommet	—	—	24 V	12 V	—	Y7BW	●	●	○	○	—		
								2-wire	Y7BA	●	●	○	○		—
	With diagnostic output (2-color indication)	Grommet	—	—	4-wire (NPN)	5 V, 12 V	—	F59F	●	●	○	○	IC circuit		

* Lead wire length symbols: 0.5 m.....Nil (Example) A54
 3 m.....L (Example) A54L
 5 m.....Z (Example) A54Z

* Solid state switches marked with "○" are produced upon receipt of order.

Refer to page 889 for the applicable auto switch list.

Proper Auto Switch Mounting Position (Detection at Stroke End) and Its Mounting Height

D-Z7□
 D-Y59□/Y69□/Y7P/Y7PV
 D-Y7□W/Y7□WV
 D-Y7BAL

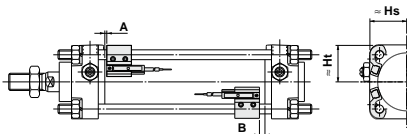

D-A5□
 D-A59W

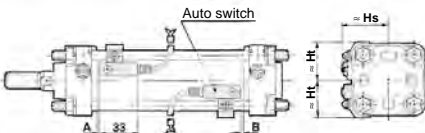

D-F5□/J5□

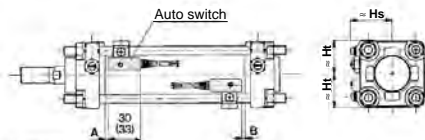

Values inside () are for D-F5LF.

Proper Auto Switch Mounting Position (mm)

Auto switch model	D-Z7□ D-Y59□ D-Y7P D-Y7□W D-Y7BAL		D-A54		D-A59W		D-J51 D-F59F	
	A	B	A	B	A	B	A	B
Bore size (mm) 40	3.5	1.5	0	0	4	2	7	4
50	3.5	1.5	0	0	4	2	6.5	4.5
63	6	5	2.5	1.5	6.5	5.5	12.5	8

Auto Switch Mounting Height (mm)

Auto switch model	D-Z7□ D-Y59□ D-Y7P D-Y7BAL D-Y7□W		D-A54 D-A59W		D-J51 D-F59F	
	Hs	Ht	Hs	Ht	Hs	Ht
Bore size (mm) 40	30	30	38.5	31.5	38	31.5
50	34	34	42	35.5	42	35.5
63	41	41	46.5	43	47	43

Note) The above values should be used as a guide for detection at stroke end. When actually mounting the auto switch, adjust the position after confirming the operating conditions of the auto switch.

Basic (B): 10-CA2B, 21-CA2B

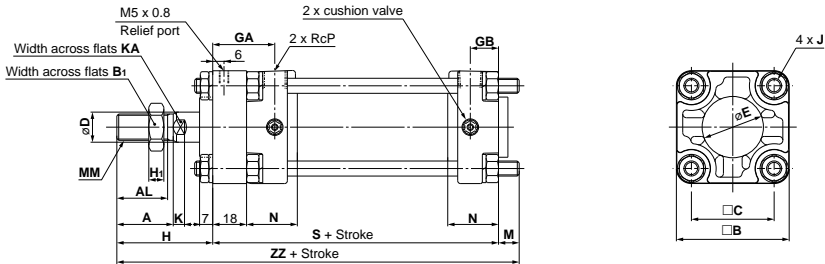

Symbol	Stroke range	A	AL	B	B ₁	C	D	E	GA	GB	H	H ₁	J	K	KA	M	MM	N	P	S	ZZ
40	Up to 1000	30	27	60	22	44	16	32	33	15	51	8	M8 x 1.25	6	14	11	M14 x 1.5	27	1/4	102	164
50	Up to 1000	35	32	70	27	52	20	40	35	17	58	11	M8 x 1.25	7	18	11	M18 x 1.5	30	3/8	108	177
63	Up to 1000	35	32	85	27	64	20	40	35	17	58	11	M10 x 1.25	7	18	14	M18 x 1.5	31	3/8	116	188

Axial Foot (L): 10-CA2L, 21-CA2L

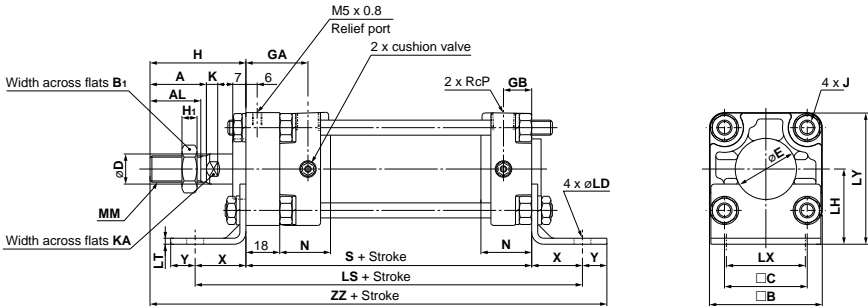

Symbol	Stroke range	A	AL	B	B ₁	C	D	E	GA	GB	H	H ₁	J	K	KA	LD	LH	LS	LT	LX	LY	MM	N	P	S	X	Y	ZZ
40	Up to 1000	30	27	60	22	44	16	32	33	15	51	8	M8 x 1.25	6	14	9	40	156	3.2	42	70	M14 x 1.5	27	1/4	102	27	13	193
50	Up to 1000	35	32	70	27	52	20	40	35	17	58	11	M8 x 1.25	7	18	9	45	162	3.2	50	80	M18 x 1.5	30	3/8	108	27	13	206
63	Up to 1000	35	32	85	27	64	20	40	35	17	58	11	M10 x 1.25	7	18	11.5	50	184	3.2	59	93	M18 x 1.5	31	3/8	116	34	16	224

Directional Control Valves
Air Cylinders
Rotary Actuators
Air Grippers
Air Preparation Equipment
Modular F. R.
Pressure Control Equipment
Fittings & Tubing
Flow Control Equipment
Pressure Switches/Pressure Sensors

Rod Flange (F): 10-11:CA2F, 21-22:CA2F

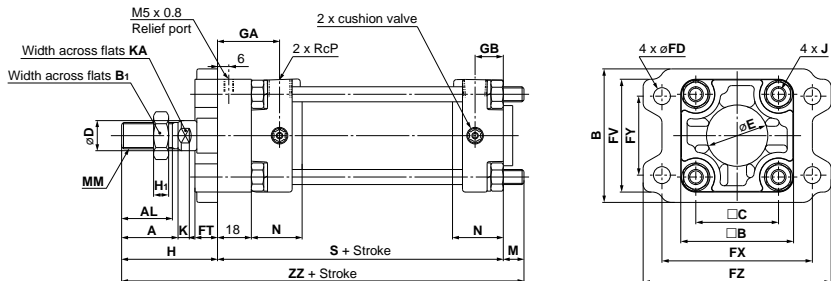

Symbol Bore size	Stroke range	A	AL	B	B1	C	D	E	FV	FD	FT	FX	FY	FZ	G	G	H	H1	J	K	KA	M	MM	N	P	S	ZZ	
40	Up to 1000	30	27	71	60	22	44	16	32	60	9	12	80	42	100	33	15	51	8	M8 x 1.25	6	14	11	M14 x 1.5	27	1/4	102	164
50	Up to 1000	35	32	81	70	27	52	20	40	70	9	12	90	50	110	35	17	58	11	M8 x 1.25	7	18	11	M18 x 1.5	30	3/8	108	177
63	Up to 1000	35	32	101	85	27	64	20	40	86	11.5	15	105	59	130	35	17	58	11	M10 x 1.25	7	18	14	M18 x 1.5	31	3/8	116	188

Head Flange (G): 10-11:CA2G, 21-22:CA2G

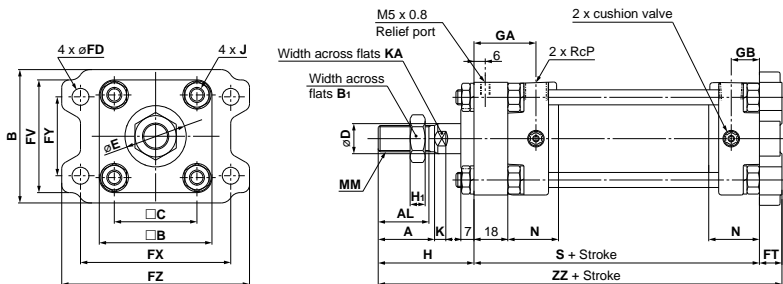

Symbol Bore size	Stroke range	A	AL	B	B1	C	D	E	FV	FD	FT	FX	FY	FZ	G	G	H	H1	J	K	KA	M	MM	N	P	S	ZZ	
40	Up to 1000	30	27	71	60	22	44	16	32	60	9	12	80	42	100	33	15	51	8	M8 x 1.25	6	14	11	M14 x 1.5	27	1/4	102	165
50	Up to 1000	35	32	81	70	27	52	20	40	70	9	12	90	50	110	35	17	58	11	M8 x 1.25	7	18	11	M18 x 1.5	30	3/8	108	178
63	Up to 1000	35	32	101	85	27	64	20	40	86	11.5	15	105	59	130	35	17	58	11	M10 x 1.25	7	18	14	M18 x 1.5	31	3/8	116	189

Series 10-11-CUJ

ø6, ø8, ø10, ø12, ø16, ø20
Mini Free Mount Cylinder

How to Order

10 - C D UJ B 6 8 D [] F8N []

Clean series

10	Relief type
11	Vacuum suction type

Built-in magnet

Nil	No
D	Yes (Built-in)

Mounting direction

B Lateral mounting
Counterbore

S* Axial mounting
Counterbore

Bore size

6	6 mm
8	8 mm
10	10 mm
12	12 mm
16	16 mm
20	20 mm

Stroke
Refer to the table below.

Double acting

Number of auto switches

Nil	2 pcs.
S	1 pc.

* M9□ includes one auto switch.

Auto switch

Nil	Without auto switch
M	Rod end male thread

* For the applicable auto switch model, refer to next page.

Rod end thread

Nil	Rod end female thread
M	Rod end male thread

* The minimum stroke for auto switch mounting and operating range are the same as standard products.



Model

* Bore sizes 12, 16, 20 only

Relief type	Model	Bore size (mm)	Port size	Lubrication	Action	Standard stroke (mm)	Auto switch mounting	Cushion		
	Non-lube	10-CUJ□6	6	M3 x 0.5	Non-lube	Double acting, Single rod	4, 6, 8, 10, 15	○	None	
10-CUJ□8		8	M3 x 0.5	4, 6, 8, 10, 15, 20						
10-CUJ□10		10	M3 x 0.5	4, 6, 8, 10, 15, 20						
10-CUJ□12		12	M3 x 0.5	5, 10, 15, 20, 25, 30						
10-CUJ□16		16	M3 x 0.5	5, 10, 15, 20, 25, 30						
10-CUJ□20	20	M5 x 0.8	5, 10, 15, 20, 25, 30, 35, 40, 45, 50	Rubber bumper						
Vacuum suction type	11-CUJ□6	6	M3 x 0.5				4, 6, 8, 10, 15		○	None
	11-CUJ□8	8	M3 x 0.5				4, 6, 8, 10, 15, 20			
	11-CUJ□10	10	M3 x 0.5				4, 6, 8, 10, 15, 20			
	11-CUJ□12	12	M3 x 0.5				5, 10, 15, 20, 25, 30			Rubber bumper
	11-CUJ□16	16	M3 x 0.5	5, 10, 15, 20, 25, 30						
	11-CUJ□20	20	M5 x 0.8	5, 10, 15, 20, 25, 30, 35, 40, 45, 50						

Specifications

Bore size (mm)	6	8	10	12	16	20
Action	Double acting					
Fluid	Air					
Proof pressure	1.05 MPa					
Minimum operating pressure Double acting	0.15 MPa	0.1 MPa	0.07 MPa	0.05 MPa		
Maximum operating pressure	0.7 MPa					
Ambient and fluid temperature	Without auto switch: -10°C to 70°C (No freezing). With auto switch: -10°C to 60°C (No freezing)					
Cushion	None			Rubber bumper		
Lubrication	Non-lube					
Piston speed	50 to 400 mm/s					
Stroke length tolerance	+0.5 0			+1.0 0		
Mounting	Through-hole			CUJB: Through-hole (Lateral, axial direction: 2 locations each) CUJS: Through-hole (Axial direction: 2 locations)		
Grease	Fluorine grease					
Cleanliness class (ISO class)	10-: Class 4, 11-: Class 3					

Suction Flow Rate of Vacuum Suction Type (Reference values)

Bore size	Suction flow rate L/min (ANR)
6/8	2
10	3
12	4
16	6
20	8

Auto Switch Specifications (Refer to the **WEB catalog** for detailed specifications and auto switches not in the following table.)

Type	Special function	Electrical entry	Indicator light	Wiring (Output)	Load voltage		Auto switch model		Lead wire length (m)*			Applicable load		
					DC	AC	Electrical entry direction		0.5 (Nil)	3 (L)	5 (Z)			
							Perpendicular	In-line						
Solid state auto switch	—	Grommet	Yes	3-wire (NPN)	24 V	5 V, 12 V	—	—	M9N	●	●	○	—	Relay, PLC
								F8N	—	●	●	○		
				—	M9B	●	●	○						
				F8B	—	●	●	○						
				2-wire		12 V								

* Lead wire length symbols: 0.5 m.....Nil (Example) F8N * Auto switches marked with "○" are produced upon receipt of order.
 3 m.....L (Example) F8NL

Refer to page 889 for the applicable auto switch list.

Auto switch Proper Mounting Position (Detection at Stroke End)

D-F8□

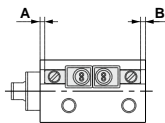

D-M9□/M9□W/M9□A

· When detecting extended stroke end

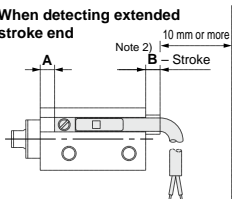

· When detecting retracted stroke end

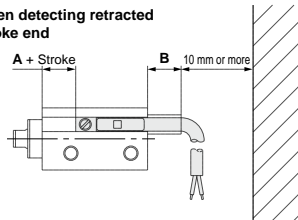

Bore size (mm)	D-F8□				D-M9□/M9□W D-M9□A			
	Double acting		Single acting		Double acting		Single acting	
	A	B	A	B	A	B	A	B
6								
8	1	1	1	1	3	7	3	7
10								
12	2	1	3.5	1	4	7	5.5	7
16	3	1	3	1	5	6.5	5	6.5
20	5	2	5	2	7	6	7	6

Note 1) Solid state auto switch D-M9□/M9□W/M9□A: With 1 pc.
 Note 2) Provide a clearance of 10 mm or more in addition to the above dimensions to prevent the lead wire interference.
 Note 3) Adjust the mounting position after confirming the auto switch operation.

Dimensions $\varnothing 6$ to $\varnothing 10$

$\frac{10}{11}$ -C(D)UJB

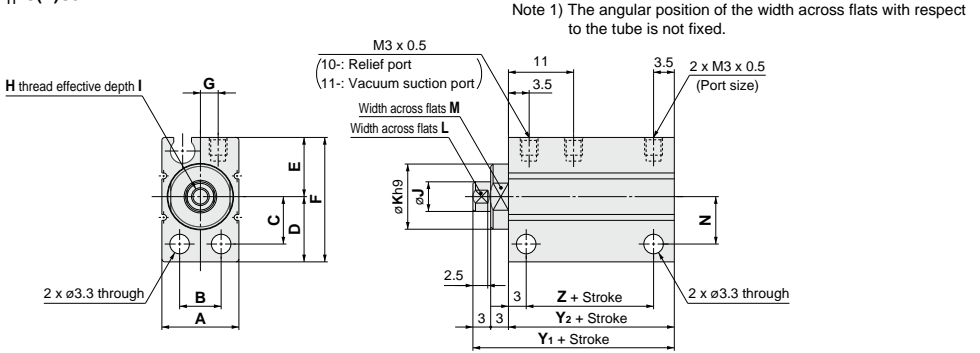

Rod end male thread

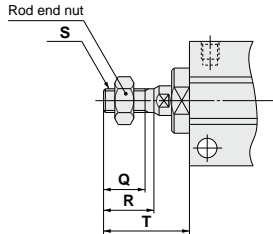

Rod end nut (Accessory)

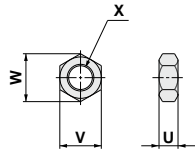

Rod end male thread (mm)

Bore size	Q	R	S	T
6	5.5	6.5	M3 x 0.5	12.5
8	7	8.5	M4 x 0.7	14.5
10	9	10.5	M5 x 0.8	16.5

(mm)

Part no.	Applicable bore size	U	V	W	X
NTJ-006A	6	2.4	5.5	6.4	M3 x 0.5
NTJ-010A	8	3.2	7	8.1	M4 x 0.7
NTJ-015A	10	4	8	9.2	M5 x 0.8

Standard

Bore size	A	B	C	D	E	F	G	H	I	J	K	L	M	N
6	13	7	7	10	9	19	3	M2.5 x 0.45	5	4	9	3.5	8	7
8	13	7	8	11	10	21	3	M3 x 0.5	6	5	11	4.5	10	8
10	13.5	7	8.5	11.5	10.5	22	3.2	M3 x 0.5	6	6	12	5	11	8.5

Bore size	Without magnet			Built-in magnet		
	Y ₁	Y ₂	Z	Y ₁	Y ₂	Z
6	24	18	11.5	29	23	16.5
8	24	18	11.5	29	23	16.5
10	24	18	11.5	29	23	16.5

Directional Control Valves
Air Cylinders
Rotary Actuators
Air Grippers
Air Preparation Equipment
Modular F. R.
Pressure Control Equipment
Fittings & Tubing
Flow Control Equipment
Pressure Switches/ Pressure Sensors

Dimensions $\varnothing 12$ to $\varnothing 20$

$\frac{10}{11}$ -C(D)UJB

Lateral mounting

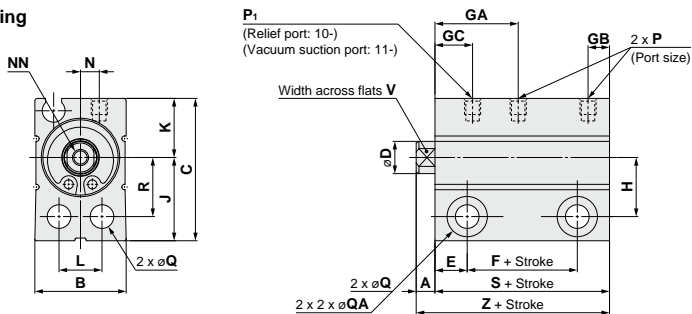

Axial mounting

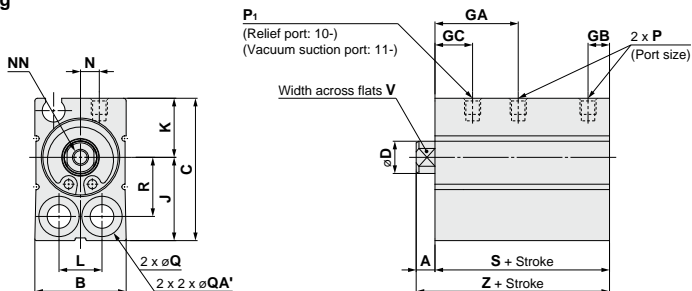

Rod end male thread

Rod end nut

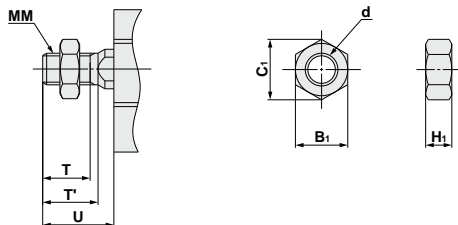

(mm)					
Part no.	Bore size (mm)	d	H ₁	B ₁	C ₁
NTJ-015A	12	M5 x 0.8	4	8	9.2
NT-015A	16	M6 x 1	5	10	11.5
NT-02	20	M8 x 1.25	5	13	15

(mm)																
Bore size (mm)	A	B	C	D	E	GB	GC	H	J	K	L	MM	NN	N	P ₁	P
12	3.5	17	26.5	6	6	4	7	11	15.5	11	8	M5 x 0.8	M3 x 0.5 effective depth of thread 6	3.5	M3 x 0.5	M3 x 0.5
16	3.5	21	29.5	8	6	4	8.5	12.5	17	12.5	11.5	M6 x 1	M4 x 0.7 effective depth of thread 8	5.5	M3 x 0.5	M3 x 0.5
20	4.5	25	36	10	7	5.5	8.5	15.5	21	15	13.5	M8 x 1.25	M5 x 0.8 effective depth of thread 7	7	M5 x 0.8	M5 x 0.8

Bore size (mm)	Q	QA	QA'	R	T	T'	U	V	Without magnet				Built-in magnet			
									F	GA	S	Z	F	GA	S	Z
									12	4.4 through	Counterbore diameter 7.5, depth 7	Counterbore diameter 7.5, depth 5.5	11	9	10.5	14
16	4.4 through	Counterbore diameter 7.5, depth 7	Counterbore diameter 7.5, depth 5.5	12.5	10	12	15.5	6	13.5	17.5	25.5	29	18	18	30	33.5
20	5.5 through	Counterbore diameter 9.5, depth 9	Counterbore diameter 9.5, depth 6.5	15.5	12	14	18.5	8	15.5	18.5	29.5	34	19.5	18.5	33.5	38

⚠ Specific Product Precautions

Be sure to read this before handling.

Design

⚠ Warning

Do not use an exhaust center. If its use cannot be avoided, use an lurching prevention circuit, or consult with SMC.

Mounting

⚠ Caution

1. When mounting a mini free mount cylinder, tighten the bolts with the proper tightening torque.

Applicable bore size (mm)	Bolt	Proper tightening torque (N·m)*
6	M3 x 0.5	1.06±20% (0.848 to 1.272)
8		
10		
12	M4 x 0.7	3.27±20% (2.61 to 3.92)
16		
20	M5 x 0.8	6.6±20% (5.28 to 7.92)

* Torque coefficient: 0.2

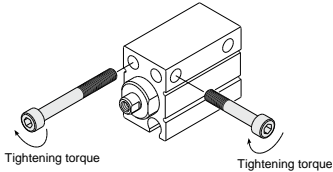

2. Mounting the bolt from the rod side with a $\phi 12$ to $\phi 20$ lateral mounting body may result in interference with the workpiece. Use an axial mounting body.

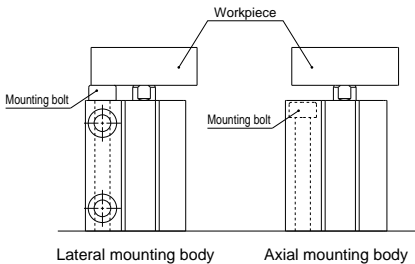

3. Use caution especially when multiple cylinders are used in parallel such as stacking because the dimensions of the body's width have plus tolerances. Contact SMC for information on a product with body width dimensions having different tolerances. ($\phi 6$, $\phi 8$, $\phi 10$ only)

4. If the cylinder's mounting surface is not sufficiently flat, it may result in malfunction. We recommend that the cylinder's mounting surface flatness should be 1/100 mm or less.

Allowable Kinetic Energy

⚠ Caution

When driving an inertial load, operate a cylinder with kinetic energy within the allowable value. The range in the chart below that is delineated by bold solid lines indicates the relationship between load mass and maximum driving speeds.

Bore size (mm)	6	8	10	12	16	20
Piston speed (m/s)	0.05 to 0.5					
Allowable kinetic energy (J)	6.25×10^{-3}	9.35×10^{-3}	12.5×10^{-3}	0.030	0.053	0.077

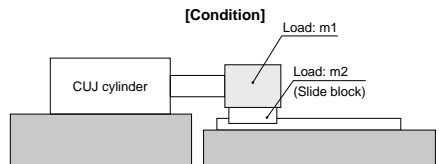
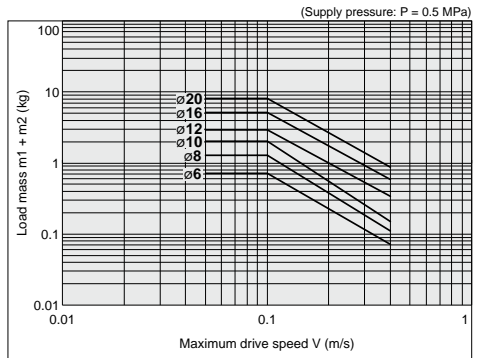

Directional Control Valves
 Air Cylinders
 Rotary Actuators
 Air Grippers
 Air Preparation Equipment
 Modular F. R.
 Pressure Control Equipment
 Fittings & Tubing
 Flow Control Equipment
 Pressure Switches/ Pressure Sensors

⚠ Specific Product Precautions

Be sure to read this before handling.

Selection

Strictly observe the limiting range of lateral load on a piston rod. (Refer to the graphs below.) If this product is used beyond the limits, it may shorten the machine life or cause damage.

Double acting, Female thread, Without magnet
(Without auto switch)

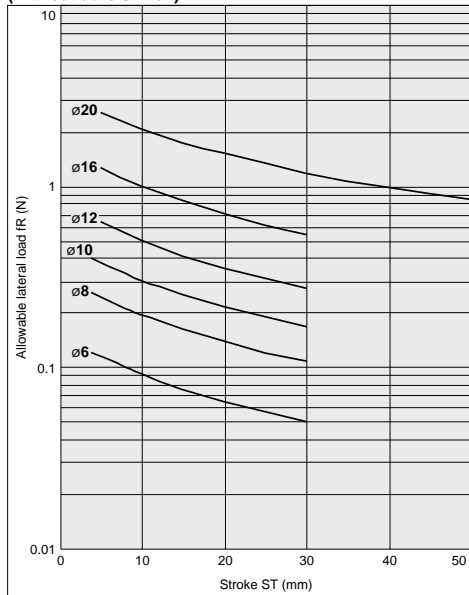

Double acting, Female thread, With magnet
(With auto switch)

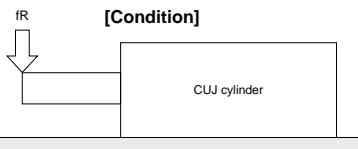
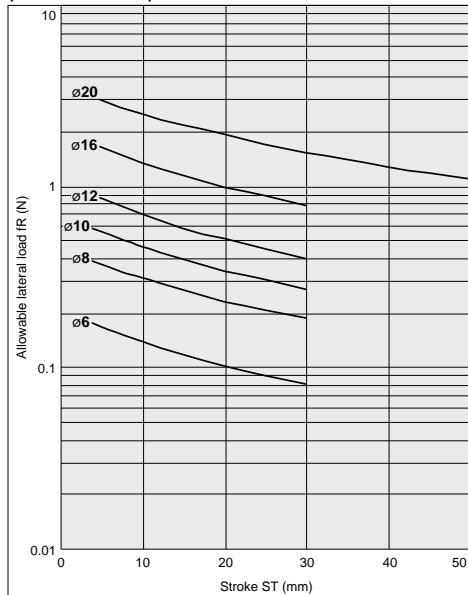

⚠ Caution

Adjust the cylinder drive speed by installing a speed controller, beginning at a low speed and gradually adjusting to the specified speed.

Series 10-/11- 21-/22-CDU

ø6, ø10, ø16, ø20, ø25 Free Mount Cylinder

How to Order

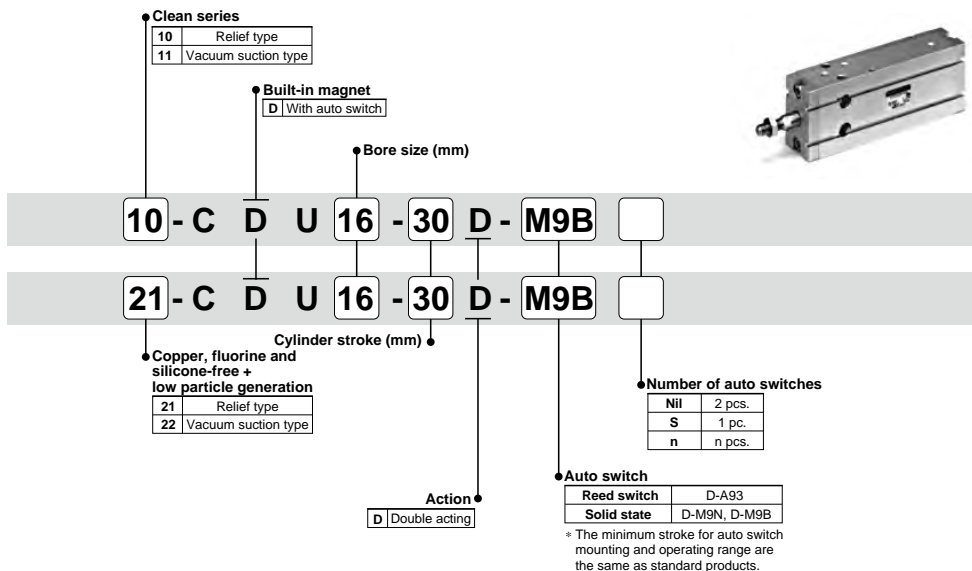

Clean series

10	Relief type
11	Vacuum suction type

Built-in magnet

D	With auto switch
---	------------------

Bore size (mm)

10 - C D U 16 - 30 D - M9B

21 - C D U 16 - 30 D - M9B

Cylinder stroke (mm)

Copper, fluorine and silicone-free + low particle generation

21	Relief type
22	Vacuum suction type

Number of auto switches

NII	2 pcs.
S	1 pc.
n	n pcs.

Auto switch

Reed switch	D-A93
Solid state	D-M9N, D-M9B

Action

D	Double acting
---	---------------

* The minimum stroke for auto switch mounting and operating range are the same as standard products.

Model

Model	Bore size (mm)	Port size	Lubrication	Action	Standard stroke (mm)	Auto switch mounting	Cushion	
							Rubber	Air
10-/21-CDU6	6	M5 x 0.8	Non-lube	Double acting Single rod	5, 10, 15, 20, 25, 30	○	○	—
10-/21-CDU10	10							
10-/21-CDU16	16							
10-/21-CDU20	20							
10-/21-CDU25	25							
11-/22-CDU6	6				5, 10, 15, 20, 25, 30, 40, 50			
11-/22-CDU10	10							
11-/22-CDU16	16				5, 10, 15, 20, 25, 30			
11-/22-CDU20	20							
11-/22-CDU25	25				5, 10, 15, 20, 25, 30, 40, 50			

Specifications

Item	Bore size (mm)		
	6	10/16	20/25
Proof pressure	1.05 MPa		
Maximum operating pressure	0.7 MPa		
Minimum operating pressure	0.12 MPa	0.06 MPa	0.05 MPa
Ambient and fluid temperature	Without auto switch : -10°C to 70°C With auto switch : -10°C to 60°C (No freezing)		
Piston speed	50 to 400mm/s		
Stroke length tolerance	+1.0 0		
Grease	10-/11-: Fluorine grease 21-/22-: Lithium soap based grease		
Cleanliness class (ISO class)	10-: Class 4, 21-: Class 5 11-/22-: Class 3		

Suction Flow Rate of Vacuum Suction Type (Reference values)

Size	Suction flow rate L/min (ANR)
6	6
10	10
16/20/25	12

Auto Switch Specifications (Refer to the **WEB catalog** for detailed specifications and auto switches not in the following table.)

Type	Auto switch part no.	Load voltage	Load current range	Indicator light	Application
Reed auto switch	D-A93	24 VDC	5 to 40mA (24 VDC)	○	Relay, PLC
Solid state auto switch	D-M9B	28 VDC or less	40mA or less	○	IC circuit, Relay, PLC
	D-M9N	24 VDC (10 to 28 VDC)	5 to 40mA	○	24 VDC Relay, PLC

Refer to page 889 for the applicable auto switch list.

PLC: Programmable Logic Controller

Auto Switch Proper Mounting Position (Detection at Stroke End)

D-A9□
D-M9□

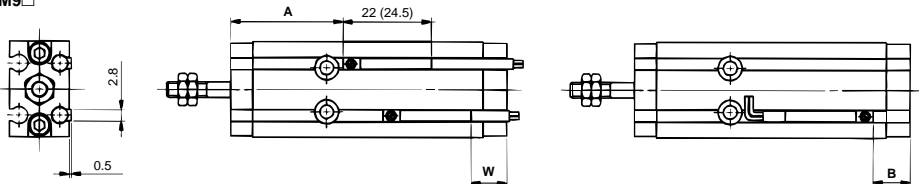

(): Dimensions for D-A93

Bore size (mm)	D-A9□			D-M9□		
	A	B	W	A	B	W
6	29.5	5.5	-3.5 (-1)	33.5	9.5	0.5
10	29.5	9.5	-7.5 (-5)	33.5	13.5	-3.5
16	36	11.5	-9.5 (-7)	40	15.5	-5.5
20	41	15	-13 (-10.5)	45	19	-9
25	40.5	16.5	-14.5 (-12)	45.5	20.5	-10.5

Note) The above mentioned values are indicated as a guide for auto switch mounting positions for stroke end detection. When actually mounting an auto switch, adjust the position after confirming the operating state of the auto switch.

Note 2) The negative values in the table indicate that the auto switch is mounted inside the cylinder body in case of W and outside in case of B.

Note 3) In case of 5 mm stroke (with 1 pc.) or 10 mm stroke (2 pcs.), the switch(es) may not go off or more than one switch may turn on simultaneously. Set them at 1 to 4 mm out of the values in the above table.

Note 4) (): Dimensions for D-A93.

⚠ Specific Product Precautions

Be sure to read this before handling.

Mounting

⚠ Caution

1. Observe the proper tightening torque in the right table in mounting.

Appropriate tightening torque

Bore size (mm)	Hexagon socket head cap screw size (mm)	Appropriate tightening torque (N·m)
ø6, ø10	M3	1.08 ±10%
ø16	M4	2.45 ±10%
ø20, ø25	M5	5.10 ±10%

10-CDU6 to 25, 21-CDU6 to 25

ø6/ø10

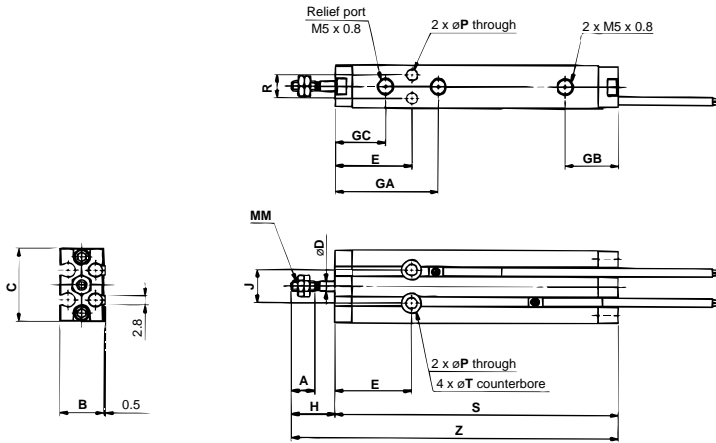

Bore size	A	B	C	D	E	GA	GB	GC	H	J	MM	P	R	T	S										Z									
															S										Z									
															5	10	15	20	25	30	5	10	15	20	25	30								
6	7	13	22	3	23	31	16	15	13	10	M3 x 0.5	3.2	7	6 depth 4.8	60	65	70	75	80	85	73	78	83	88	93	98								
10	10	15	24	4	24	33.5	16	15.5	16	11	M4 x 0.7	3.2	9	6 depth 5	64	69	74	79	84	89	80	85	90	95	100	105								

ø16 to ø25

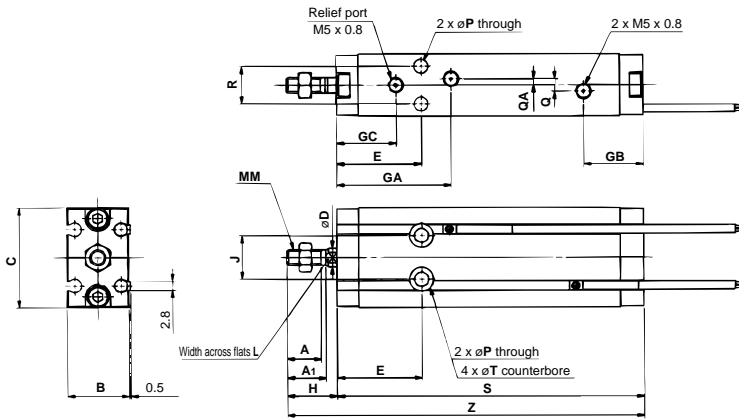

Bore size	A	A ₁	B	C	D	E	GA	GB	GC	H	J	L	MM	P	Q	QA	R	T	S										Z									
																			S										Z									
																			5	10	15	20	25	30	40	50	5	10	15	20	25	30	40	50				
16	11	12.5	20	32	6	27	36.5	19	19	16	14	5	M5 x 0.8	4.5	4	2	12	17.6 depth 6.5	72.5	77.5	82.5	87.5	92.5	97.5	—	—	88.5	93.5	98.5	103.5	108.5	113.5	—	—				
20	12	14	26	40	8	30	40	21.5	22	19	16	6	M6 x 1.0	5.5	9	4.5	16	9.5 depth 8	81	86	91	96	101	106	116	126	100	105	110	115	120	125	135	145				
25	15.5	18	32	50	10	29	40.5	22	22	23	20	8	M8 x 1.25	5.5	9	4.5	20	9.5 depth 9	83	88	93	98	103	108	118	128	106	111	116	121	126	131	141	151				

Directional Control Valves
Air Cylinders
Rotary Actuators
Air Grippers
Air Preparation Equipment
Modular F. R.
Pressure Control Equipment
Fittings & Tubing
Flow Control Equipment
Pressure Switches/Pressure Sensors

Series 10-/21-**CQS** 11-/22-**CQS**

ø12, ø16, ø20, ø25 Compact Cylinder

How to Order

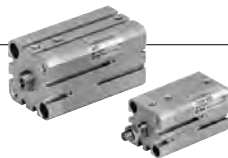

Mounting
B Through-hole, Both ends tapped (Standard)

Bore size (mm)
12 - 5

Clean series
10 Relief type
11 Vacuum suction type

Cylinder stroke (mm)
* Refer to the table below for standard strokes.
5

Number of auto switches
Nil 2 pcs.
S 1 pc.
n n pcs.

With auto switch
Nil No
D With auto switch (Built-in magnet)

Copper, fluorine and silicone-free + Low particulate generation
21 Relief type
22 Vacuum suction type

Action
D Double acting

Auto switch (With auto switch)
Nil Without auto switch (Built-in magnet cylinder)

* For auto switch part numbers, refer to the next page.
* The minimum stroke for auto switch mounting and operating range are the same as standard products.
* Auto switch is packaged together (not assembled).

Rod end thread
Nil Standard (Rod end female thread)
M Rod end male thread

Model examples:
10 - C D Q S B 12 - 5 D - M9B
21 - C D Q S B 12 - 5 D - M9B

Model

	Model	Bore size (mm)	Port size	Relief port	Action	Standard stroke (mm)
Relief type	10-/21-CQSB12	12	M5 x 0.8	M5 x 0.8	Double acting Single rod	5, 10, 15, 20, 25, 30
	10-/21-CQSB16	16				5, 10, 15, 20, 25, 30, 35, 40, 45, 50
	10-/21-CQSB20	20				5, 10, 15, 20, 25, 30
	10-/21-CQSB25	25				5, 10, 15, 20, 25, 30
Vacuum suction type	11-/22-CQSB12	12	M5 x 0.8	M5 x 0.8	Double acting Single rod	5, 10, 15, 20, 25, 30, 35, 40, 45, 50
	11-/22-CQSB16	16				5, 10, 15, 20, 25, 30, 35, 40, 45, 50
	11-/22-CQSB20	20				5, 10, 15, 20, 25, 30, 35, 40, 45, 50
	11-/22-CQSB25	25				5, 10, 15, 20, 25, 30, 35, 40, 45, 50

Specifications

Item	Bore size (mm)
	12/16/20/25
Proof pressure	1.5 MPa
Maximum operating pressure	1.0 MPa
Minimum operating pressure	ø12, ø16: 0.07 MPa, ø20, ø25: 0.05 MPa
Ambient and fluid temperature	Without auto switch : -10°C to 70°C With auto switch : -10°C to 60°C (No freezing)
Cushion	None
Piston speed	30 to 400 mm/s
Stroke length tolerance	+1.0 -0.3
Mounting	Through-hole, Both ends tapped
Grease	10-/11-: Fluorine grease 21-/22-: Lithium soap based grease
Cleanliness class (ISO class)	10-/21-: Class 4, 11-/22-: Class 3

Suction Flow Rate of Vacuum Suction Type (Reference values)

Size	Suction flow rate L/min (ANR)
12/16/20/25	5

Auto Switch Specifications (Refer to the **WEB catalog** for detailed specifications and auto switches not in the following table.)

Type	Auto switch part no.	Load voltage	Load current range	Indicator light	Application
Reed auto switch	D-A93	24 VDC, 100 VAC	5 to 40 mA, 5 to 20 mA	○	Relay, PLC
Solid state auto switch	2-wire D-M9B	24 VDC (10 to 28 VDC)	2.5 to 40 mA	○	24 VDC Relay, PLC
	3-wire D-M9N, D-M9P	28 VDC or less	40 mA or less	○	IC circuit, Relay, PLC

Refer to page 889 for the applicable auto switch list.

PLC: Programmable Logic Controller

Auto Switch Proper Mounting Position (Detection at Stroke End)

D-A93

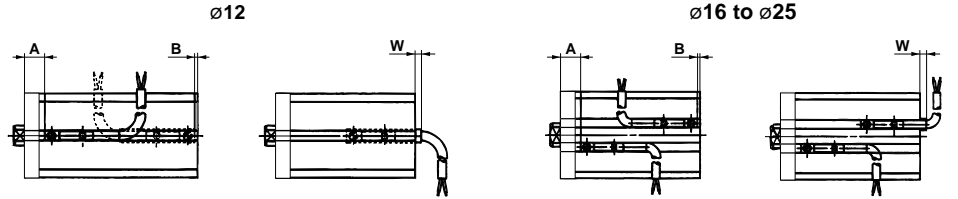

D-M9B/M9N

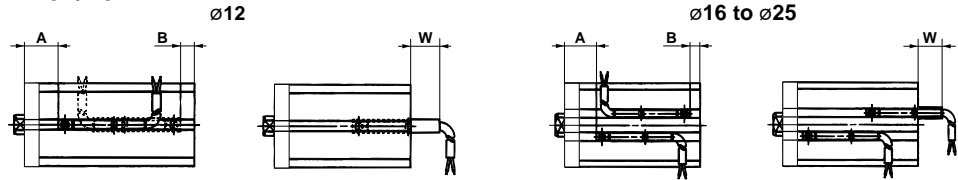

Bore size (mm)	D-A93			D-M9B/M9N/M9P		
	A	B	W	A	B	W
12	11.5	0.5	4	15.5	4.5	5.5
16	12	0	4.5	16	4	6
20	16	3.5	1	20	7.5	2.5
25	17	5.5	-1	21	9.5	0.5

⚠ Specific Product Precautions

Be sure to read this before handling.

Mounting

⚠ Caution

- When a magnetic object comes in close proximity with the cylinder as shown in the right figures (including proximity on one side only), the auto switch operation may become unstable. Consult with SMC in such cases.

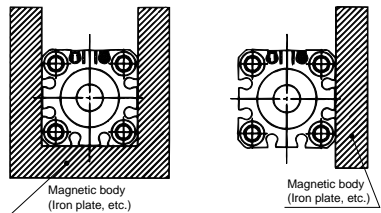

Directional Control Valves

Air Cylinders

Rotary Actuators

Air Grippers

Air Preparation Equipment

Modular F. R.

Pressure Control Equipment

Fittings & Tubing

Flow Control Equipment

Pressure Switches/ Pressure Sensors

Standard: $\frac{10}{11}$:CQSB12 to 25, $\frac{21}{22}$:CQSB12 to 25

$\varnothing 12$

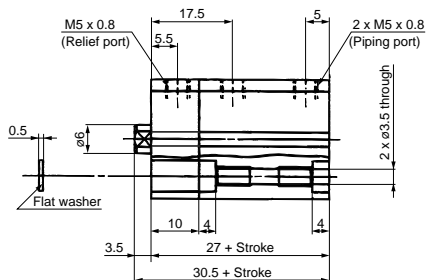
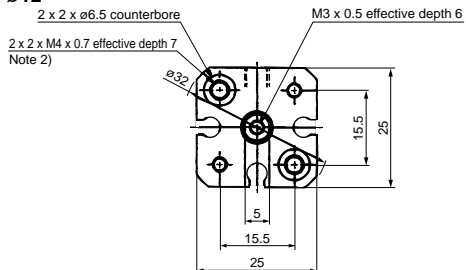

$\varnothing 16$

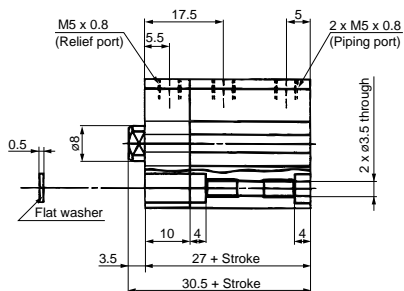
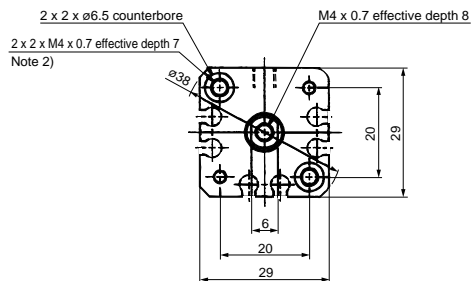

$\varnothing 20$

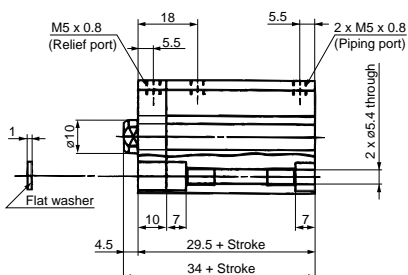
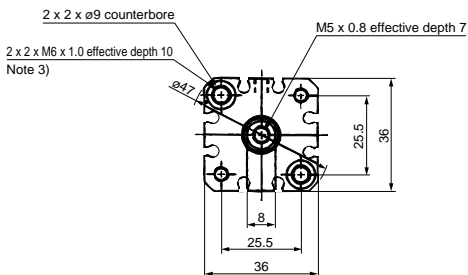

$\varnothing 25$

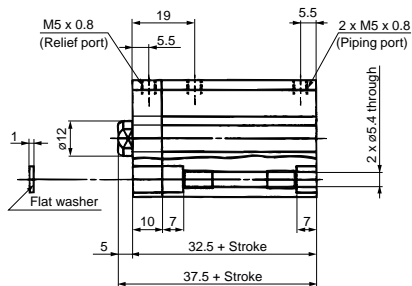
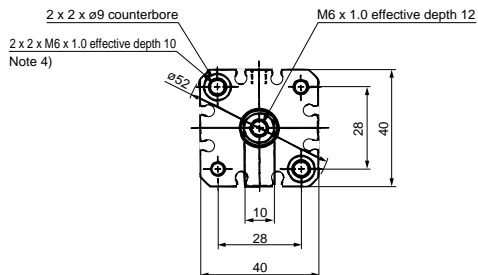

Note 1) Standard strokes available in 5 mm increments.

Note 2) Through-hole in case of 5 mm stroke.

Note 3) Through-hole in case of 5 to 15 mm stroke.

Note 4) Through-hole in case of 5 or 10 mm stroke.

Rod End Male Thread: ¹⁰/₁₁: CQSB12 to 25, ²¹/₂₂: CQSB12 to 25

Ø12

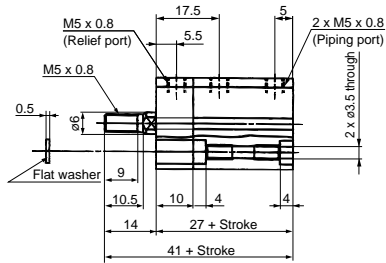
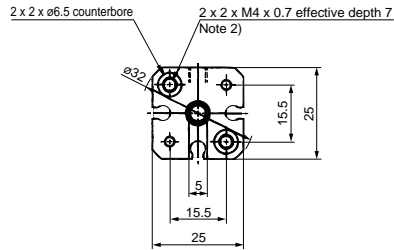

Rod end nut

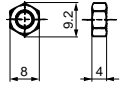

Ø16

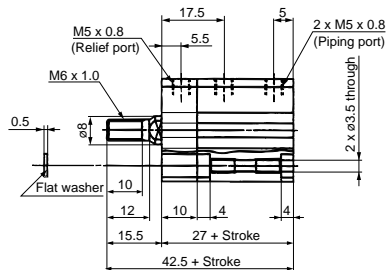
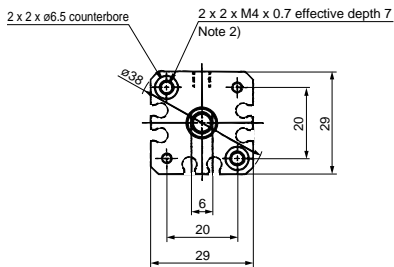

Rod end nut

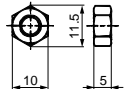

Ø20

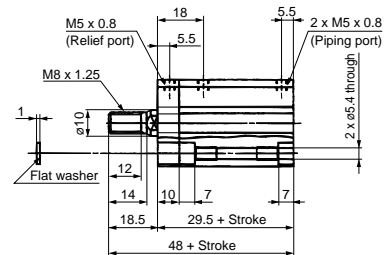
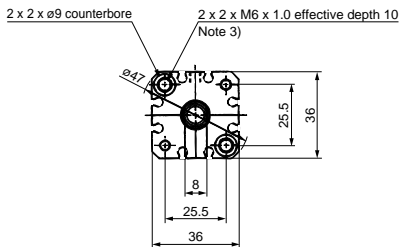

Rod end nut

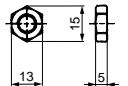

Ø25

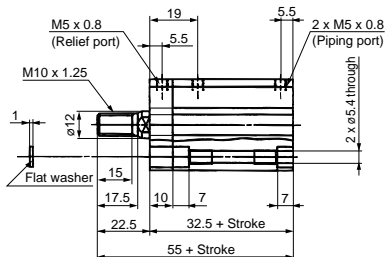
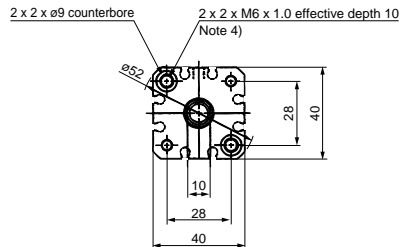

Rod end nut

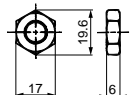

Note 1) Standard strokes available in 5 mm increments.
 Note 2) Through-hole in case of 5 mm stroke.
 Note 3) Through-hole in case of 5 to 15 mm stroke.
 Note 4) Through-hole in case of 5 or 10 mm stroke.

Directional Control Valves
 Air Cylinders
 Rotary Actuators
 Air Grippers
 Air Preparation Equipment
 Modular F. R.
 Pressure Control Equipment
 Fittings & Tubing
 Flow Control Equipment
 Pressure Switches/ Pressure Sensors

Compact Cylinder 10-11-**CQS**/21-**CQS**

With Auto Switch: 10-11-**CDQSB12 to 25**, 21-22-**CDQSB12 to 25**

Ø12

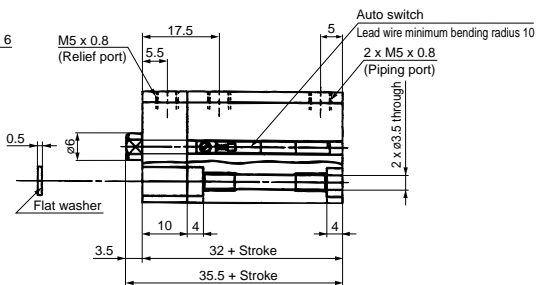
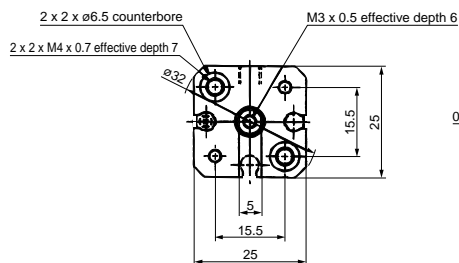

Ø16

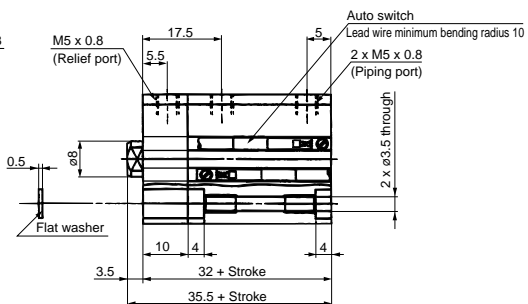
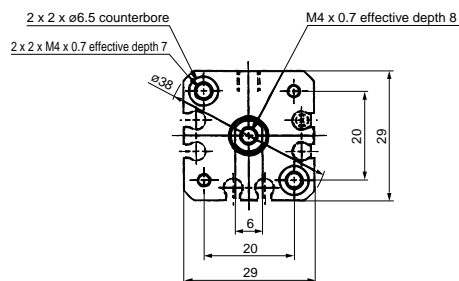

Ø20

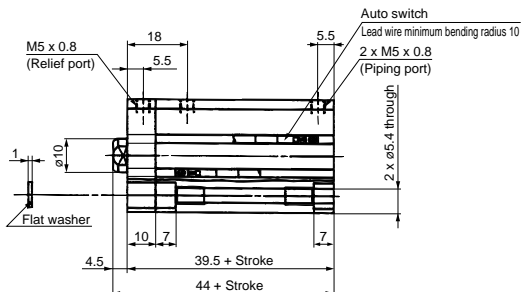
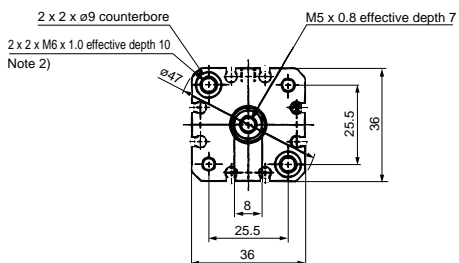

Ø25

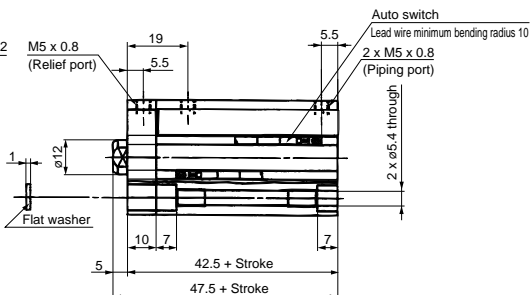
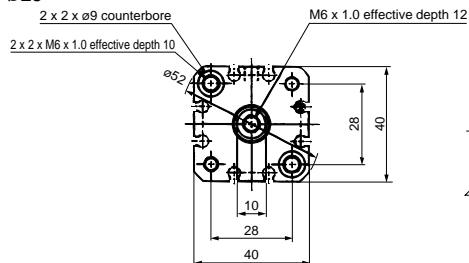

Note 1) Standard strokes available in 5 mm increments.
 Note 2) Through-hole in case of 5 mm stroke.

Rod End Male Thread with Auto Switch: 10-CDQSB12 to 25, 21-CDQSB12 to 25

Ø12

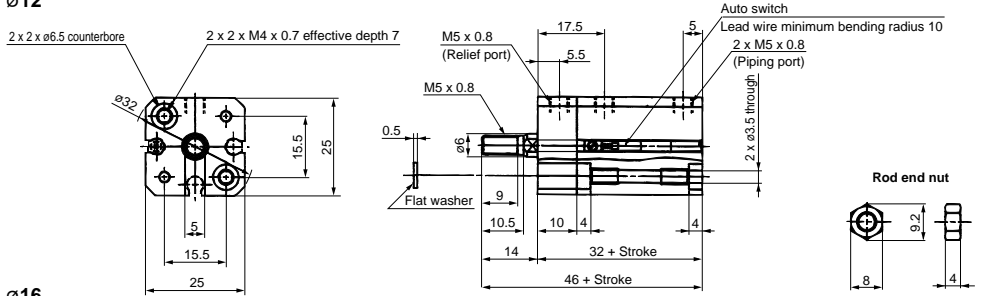

Ø16

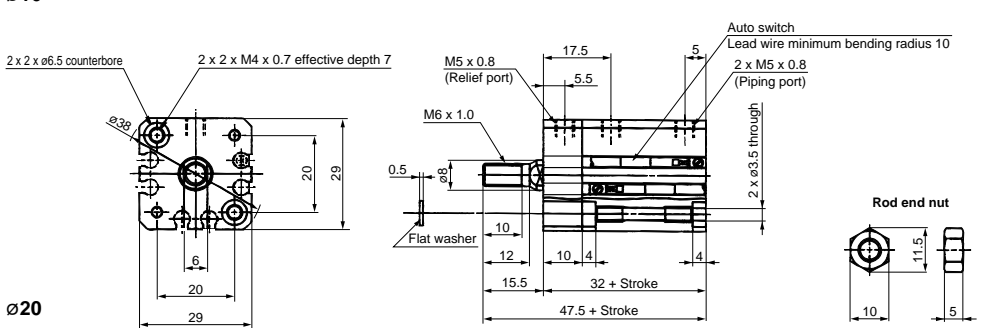

Ø20

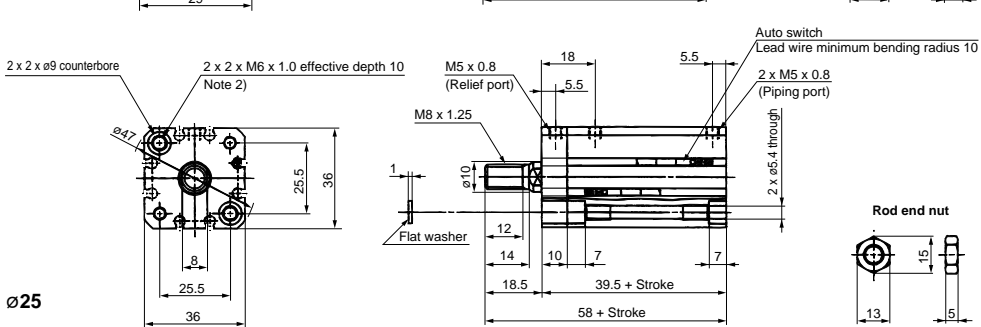

Ø25

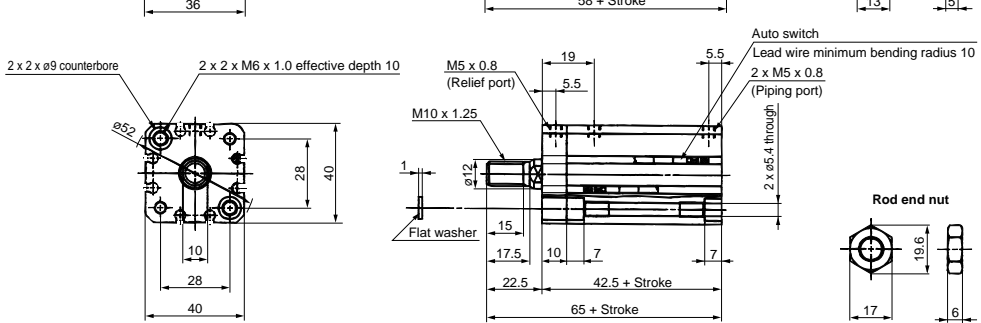

Note 1) Standard strokes available in 5 mm increments.
 Note 2) Through-hole in case of 5 mm stroke.

- Directional Control Valves
- Air Cylinders
- Rotary Actuators
- Air Grippers
- Air Preparation Equipment
- Modular F. R.
- Pressure Control Equipment
- Fittings & Tubing
- Flow Control Equipment
- Pressure Switches/ Pressure Sensors

Mounting Bolt for CQS

Mounting method: Mounting bolt for through-hole mounting of the CQSB is available as an option.

Refer to the following for ordering procedures.

Order the actual number of bolts that will be used.

Example) CQ-M3 x 35L 2 pcs.

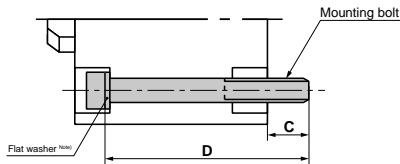

Note) Be sure to use the attached flat washer when mounting a cylinder with through-holes.

Rod side mounting/Without auto switch

Model		C	D	Mounting bolt
10-21-	11-22-	6.5	CQSB12-5D	35 CQ-M3 x 35L
			-10D	40 x 40L
			-15D	45 x 45L
			-20D	50 x 50L
			-25D	55 x 55L
			-30D	60 x 60L
10-21-	11-22-	6.5	CQSB16-5D	35 CQ-M3 x 35L
			-10D	40 x 40L
			-15D	45 x 45L
			-20D	50 x 50L
			-25D	55 x 55L
			-30D	60 x 60L
10-21-	11-22-	6.5	CQSB20-5D	35 CQ-M5 x 35L
			-10D	40 x 40L
			-15D	45 x 45L
			-20D	50 x 50L
			-25D	55 x 55L
			-30D	60 x 60L
			-35D	65 x 65L
			-40D	70 x 70L
			-45D	75 x 75L
			-50D	80 x 80L
10-21-	11-22-	8.5	CQSB25-5D	40 CQ-M5 x 40L
			-10D	45 x 45L
			-15D	50 x 50L
			-20D	55 x 55L
			-25D	60 x 60L
			-30D	65 x 65L
			-35D	70 x 70L
			-40D	75 x 75L
			-45D	80 x 80L
			-50D	85 x 85L

Head side mounting/Without auto switch

Model		C	D	Mounting bolt
10-21-	11-22-	6.5	CQSB12-5D	25 CQ-M3 x 25L
			-10D	30 x 30L
			-15D	35 x 35L
			-20D	40 x 40L
			-25D	45 x 45L
			-30D	50 x 50L
10-21-	11-22-	6.5	CQSB16-5D	25 CQ-M3 x 25L
			-10D	30 x 30L
			-15D	35 x 35L
			-20D	40 x 40L
			-25D	45 x 45L
			-30D	50 x 50L
10-21-	11-22-	6.5	CQSB20-5D	25 CQ-M5 x 25L
			-10D	30 x 30L
			-15D	35 x 35L
			-20D	40 x 40L
			-25D	45 x 45L
			-30D	50 x 50L
			-35D	55 x 55L
			-40D	60 x 60L
			-45D	65 x 65L
			-50D	70 x 70L
10-21-	11-22-	8.5	CQSB25-5D	30 CQ-M5 x 30L
			-10D	35 x 35L
			-15D	40 x 40L
			-20D	45 x 45L
			-25D	50 x 50L
			-30D	55 x 55L
			-35D	60 x 60L
			-40D	65 x 65L
			-45D	70 x 70L
			-50D	75 x 75L

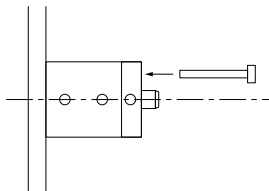
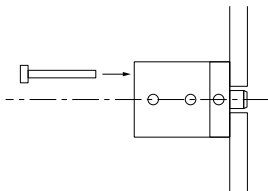

Mounting Bolt for CDQS

Mounting method: Mounting bolt for through-hole mounting of the CDQSB is available as an option.
 Refer to the following for ordering procedures.
 Order the actual number of bolts that will be used.
Example) CQ-M3 x 40L 2 pcs.

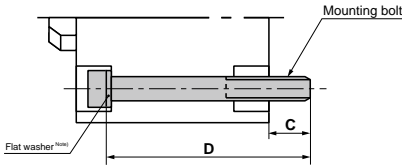

Note) Be sure to use the attached flat washer when mounting a cylinder with through-holes.

Rod side mounting/With auto switch

Model		C	D	Mounting bolt
10-21-	11-22-	6.5	CDQSB12-5D	40 CQ-M3 x 40L
			-10D	45 x 45L
			-15D	50 x 50L
			-20D	55 x 55L
			-25D	60 x 60L
			-30D	65 x 65L
10-21-	11-22-	6.5	CDQSB16-5D	40 CQ-M3 x 40L
			-10D	45 x 45L
			-15D	50 x 50L
			-20D	55 x 55L
			-25D	60 x 60L
			-30D	65 x 65L
10-21-	11-22-	6.5	CDQSB20-5D	45 CQ-M5 x 45L
			-10D	50 x 50L
			-15D	55 x 55L
			-20D	60 x 60L
			-25D	65 x 65L
			-30D	70 x 70L
			-35D	75 x 75L
			-40D	80 x 80L
			-45D	85 x 85L
			-50D	90 x 90L
10-21-	11-22-	8.5	CDQSB25-5D	50 CQ-M5 x 50L
			-10D	55 x 55L
			-15D	60 x 60L
			-20D	65 x 65L
			-25D	70 x 70L
			-30D	75 x 75L
			-35D	80 x 80L
			-40D	85 x 85L
			-45D	90 x 90L
			-50D	95 x 95L

Head side mounting/With auto switch

Model		C	D	Mounting bolt
10-21-	11-22-	6.5	CDQSB12-5D	30 CQ-M3 x 30L
			-10D	35 x 35L
			-15D	40 x 40L
			-20D	45 x 45L
			-25D	50 x 50L
			-30D	55 x 55L
10-21-	11-22-	6.5	CDQSB16-5D	30 CQ-M3 x 30L
			-10D	35 x 35L
			-15D	40 x 40L
			-20D	45 x 45L
			-25D	50 x 50L
			-30D	55 x 55L
10-21-	11-22-	6.5	CDQSB20-5D	35 CQ-M5 x 35L
			-10D	40 x 40L
			-15D	45 x 45L
			-20D	50 x 50L
			-25D	55 x 55L
			-30D	60 x 60L
			-35D	65 x 65L
			-40D	70 x 70L
			-45D	75 x 75L
			-50D	80 x 80L
10-21-	11-22-	8.5	CDQSB25-5D	40 CQ-M5 x 40L
			-10D	45 x 45L
			-15D	50 x 50L
			-20D	55 x 55L
			-25D	60 x 60L
			-30D	65 x 65L
			-35D	70 x 70L
			-40D	75 x 75L
			-45D	80 x 80L
			-50D	85 x 85L

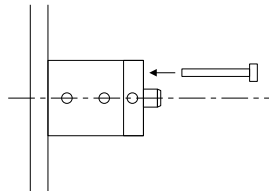
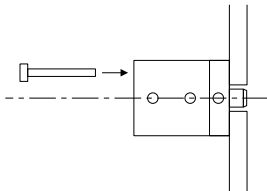

Series 10-/21-11-/22-CQ2

ø12, ø16, ø20, ø25, ø32, ø40, ø50, ø63, ø80, ø100
Compact Cylinder

How to Order



Clear series

10	Relief type
11	Vacuum suction type

Mounting

B	Through-hole (Standard)
---	-------------------------

Port thread type

Nil	M thread	ø12 to ø25
Rc		
TN	NPT	ø32 to ø100
TF	G	

* For the cylinders without an auto switch, M threads are compatible only for ø32 with 5 mm stroke.

Auto switch mounting groove

Z	ø12 to ø25	2 sides
	ø32 to ø100	4 sides

Number of auto switches

Nil	2 pcs.
S	1 pc.
n	n pcs.

Without auto switch ø12 to ø25
10 - C Q 2 B 20 - 10 D

ø12 to ø100
10 - C D Q 2 B 32 - 10 D Z - M9B

With auto switch

Nil	No	ø32 to ø100
D	With auto switch (Built-in magnet)	ø12 to ø100

Without auto switch ø12 to ø25
21 - C Q 2 B 20 - 10 D

ø12 to ø100
21 - C D Q 2 B 32 - 10 D Z - M9B

Copper, fluorine and silicone-free + Low particle generation

21	Relief type
22	Vacuum suction type

With auto switch

Nil	No	ø32 to ø100
D	With auto switch (Built-in magnet)	ø12 to ø100

Cylinder stroke (mm)

* For standard stroke, refer to the table below.

Action

D	Double acting
---	---------------

Type of auto switch (With auto switch)

Nil	Without auto switch (Built-in magnet cylinder)
-----	--

Rod end thread

Nil	Standard (Rod end female thread)
M	Rod end male thread
C	With rubber bumper

* Bore size ø12 cylinder with a switch comes with a rubber bumper as standard.

* For applicable auto switch part numbers, refer to the next page.
* The minimum stroke for auto switch mounting and operating range are the same as standard products.
* Auto switch is shipped together, (not assembled).

Model

	Model	Bore size (mm)	Port size	Relief port	Action	Standard stroke (mm)
Relief type	10-/21-C(D)Q2B12	12	M5 x 0.8	M5 x 0.8	Double acting Single rod	5, 10, 15, 20, 25, 30
	10-/21-C(D)Q2B16	16				5, 10, 15, 20, 25, 30
	10-/21-C(D)Q2B20	20				35, 40, 45, 50
	10-/21-C(D)Q2B25	25				5, 10, 15, 20, 25, 30
	10-/21-C(D)Q2B32	32				35, 40, 45, 50, 75, 100
	10-/21-C(D)Q2B40	40				
	10-/21-C(D)Q2B50	50				
	10-/21-C(D)Q2B63	63				
	10-/21-C(D)Q2B80	80				
	10-/21-C(D)Q2B100	100				
Vacuum suction type	11-/22-C(D)Q2B12	12	M5 x 0.8	M5 x 0.8	Double acting Single rod	5, 10, 15, 20, 25, 30
	11-/22-C(D)Q2B16	16				5, 10, 15, 20, 25, 30
	11-/22-C(D)Q2B20	20				35, 40, 45, 50
	11-/22-C(D)Q2B25	25				5, 10, 15, 20, 25, 30
	11-/22-C(D)Q2B32	32				35, 40, 45, 50, 75, 100
	11-/22-C(D)Q2B40	40				
	11-/22-C(D)Q2B50	50				
	11-/22-C(D)Q2B63	63				
	11-/22-C(D)Q2B80	80				
	11-/22-C(D)Q2B100	100				

(Note) Only 5 mm stroke comes with M5 x 0.8 for no auto switch on ø32.

Specifications

Item	Bore size (mm)	
	12, 16, 20, 25	80, 100
	32, 40, 50, 63	
Proof pressure		1.5 MPa
Maximum operating pressure		1.0 MPa
Minimum operating pressure		0.1 MPa
Ambient and fluid temperature	Without auto switch : -10°C to 70°C With auto switch : -10°C to 60°C (No freezing)	
Cushion	None	
Piston speed	30 to 400 mm/s	30 to 300 mm/s
Stroke length tolerance	+ ^{0.1} 0 (Note)	
Mounting	Through-hole	
Grease	10-/11-: Fluorine grease 21-/22-: Lithium soap based grease	
Cleanliness class (ISO class)	10-/21-: Class 4, 11-/22-: Class 3	

(Note) Stroke length tolerance does not include the amount of bumper change.

Suction Flow Rate of Vacuum Suction Type (Reference values)

Size	Suction flow rate L/min (ANR)
12 to 40	5
50, 63	10
80, 100	20

Auto Switch Specifications (Refer to the **WEB catalog** for detailed specifications and auto switches not in the following table.)

Type	Auto switch part no.	Load voltage	Load current range	Indicator light	Application	
Solid state auto switch	2-wire	D-M9B	24 VDC (10 to 28 VDC)	2.5 to 40 mA	○	24 VDC Relay, PLC
	3-wire	D-M9N, D-M9P	28 VDC or less	40 mA or less	○	IC circuit, Relay, PLC
Reed auto switch	D-A93, D-A96	24 VDC, 100 VAC	5 to 40 mA, 5 to 20 mA	○	Relay, PLC	

Refer to page 889 for the applicable auto switch list.

PLC: Programmable Logic Controller

Auto Switch Proper Mounting Position (Detection at Stroke End)

D-M9N/M9B/M9P
D-A93/A96

∅12 to ∅25

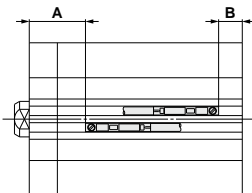
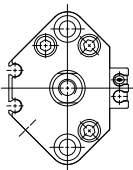

D-M9N/M9B/M9P
D-A93/A96

∅32 to ∅100

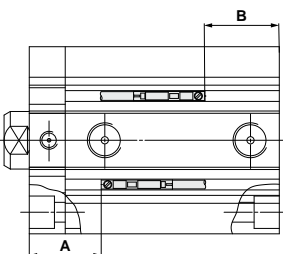
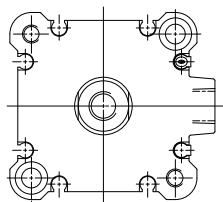

Bore size	D-M9□		D-A9□	
	A	B	A	B
12	16	7	12	3
16	19	6.5	15	2.5
20	19	7.5	15	3.5
25	19.5	8	15.5	4
32	22	9	18	5
40	26	11.5	22	7.5
50	24	14.5	20	10.5
63	26.5	17.5	22.5	13.5
80	34.5	22	30.5	18
100	39	27	35	23

⚠ Specific Product Precautions

Be sure to read this before handling.

Retaining Ring Installation/Removal (∅50 to ∅100)

⚠ Caution

- For installation and removal, use an appropriate pair of pliers (tool for installing a type C retaining ring).
- Even if a proper plier (tool for installing a type C retaining ring) is used, it is likely to inflict damage to a human body or peripheral equipment, as a retaining ring may be flown out of the tip of a plier (tool for installing a type C retaining ring). Be much careful with the popping of a retaining ring. Besides, be certain that a retaining ring is placed firmly into the groove of rod cover before supplying air at the time of installation.

Handling

⚠ Caution

- Load to piston rod must always be in an axial direction.
 - When installing a cylinder, centering should be required accurately.
 - When using it as a stopper, install a guide or take some other measures to prevent lateral load from being directly applied to the piston rod.
- Do not loosen or remove the hexagon socket head cap screw securing the rod cover. It may cause the rod cover to be detached, resulting in human injury or damage to peripheral equipment.

10-C(D)Q2B12 to 25, 21-C(D)Q2B12 to 25

Without auto switch
Rod end female thread

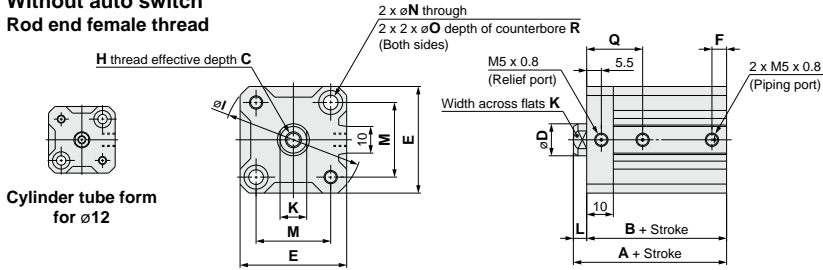

Rod end male thread

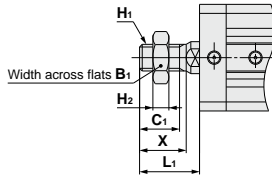

Rod end male thread (mm)

Bore size	B ₁	C ₁	H ₁	H ₂	L ₁	X
12	8	9	M5 x 0.8	4	14	10.5
16	10	10	M6 x 1.0	5	15.5	12
20	13	12	M8 x 1.25	5	18.5	14
25	17	15	M10 x 1.25	6	22.5	17.5

Standard

Bore size	Symbol	A	B	C	D	E	F	H	I	K	L	M	N	O	Q	R	Standard stroke	
		(mm)																
12		30.5	27	6	6	25	5	M3 x 0.5	32	5	3.5	15.5	3.5	6.5	17.5	3.5	5, 10, 15	
16		32	28.5	8	8	29	5.5	M4 x 0.7	38	6	3.5	20	3.5	6.5	18	3.5	20, 25, 30	
20		34	29.5	7	10	36	5.5	M5 x 0.8	47	8	4.5	25.5	5.5	9	18	7	5, 10, 15, 20, 25	
25		37.5	32.5	12	12	40	5.5	M6 x 1.0	52	10	5	28	5.5	9	19	7	30, 35, 40, 45, 50	

With auto switch

Rod end female thread

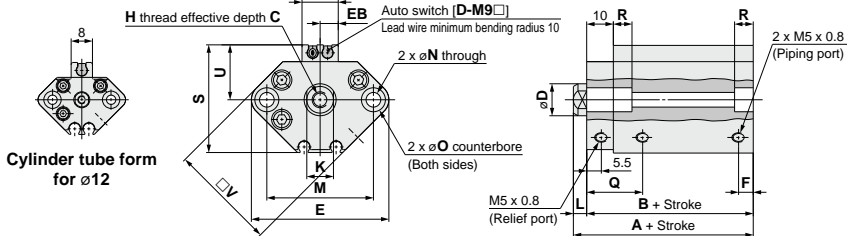

Rod end male thread

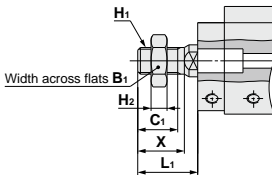

Rod end male thread (mm)

Bore size	B ₁	C ₁	H ₁	H ₂	L ₁	X
12	8	9	M5 x 0.8	4	14	10.5
16	10	10	M6 x 1.0	5	15.5	12
20	13	12	M8 x 1.25	5	18.5	14
25	17	15	M10 x 1.25	6	22.5	17.5

Standard

Bore size	Symbol	A	B	C	D	E	EA	EB	F	H	K	L	M	N	O	Q	R	S	U	V	Standard stroke	
		(mm)																				
12		41.5	38	6	6	33	—	—	6.5	M3	5	3.5	22	3.5	6.5	21	3.5	27.5	14	25	5, 10, 15	
16		44	40.5	8	8	37	13.2	6.6	5.5	M4	6	3.5	28	3.5	6.5	20	3.5	29.5	15	29	20, 25, 30	
20		46	41.5	7	10	47	13.6	6.8	5.5	M5	8	4.5	36	5.5	9	18	7	35.5	18	36	5, 10, 15, 20, 25	
25		47.5	42.5	12	12	52	13.6	6.8	5.5	M6	10	5	40	5.5	9	19	7	40.5	21	40	30, 35, 40, 45, 50	

Directional Control Valves
Air Cylinders
Rotary Actuators
Air Grippers
Air Preparation Equipment
Modular F. R.
Pressure Control Equipment
Fittings & Tubing
Flow Control Equipment
Pressure Switches/Pressure Sensors

Compact Cylinder 10-11-CQ2/21-22-CQ2

10-11-C(D)Q2B32 to 50, 21-22-C(D)Q2B32 to 50 (For without auto switches, the A, B, F, P and Q dimensions will be only changed. Please refer to the dimension table.)

Rod end female thread

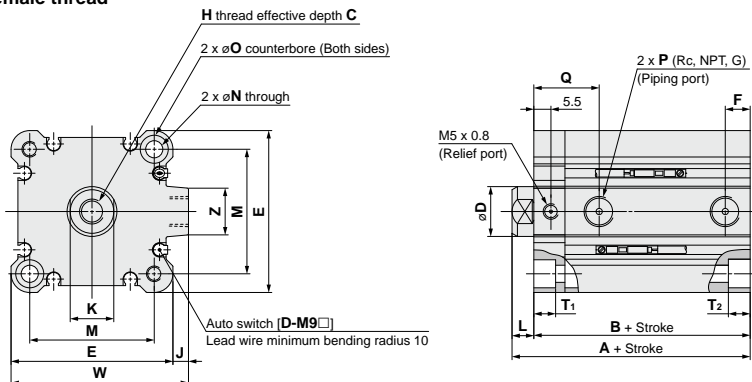

Rod end male thread

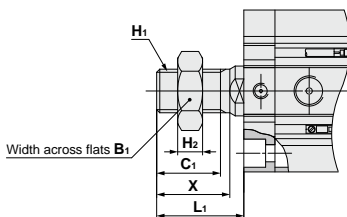

Rod end male thread (mm)

Bore size	B_1	C_1	H_1	H_2	L_1	X
32	22	20.5	M14 x 1.5	8	28.5	23.5
40	22	20.5	M14 x 1.5	8	28.5	23.5
50	27	26	M18 x 1.5	11	33.5	28.5

Standard

Bore size	Stroke range ^{Note)}	Without auto switch					With auto switch					C	D	E	H	J	K
		A	B	F	P	Q	A	B	F	P	Q						
32	5	40	33	5.5	M5 x 0.8	20	50	43	7.5	1/8	20	13	16	45	M8 x 1.25	4.5	14
	10 to 50			7.5	1/8												
	75, 100	50	43														
40	5 to 50	46.5	39.5	7.5	1/8	22.5	56.5	49.5	7.5	1/8	22.5	13	16	52	M8 x 1.25	5	14
	75, 100	56.5	49.5														
	10 to 50	48.5	40.5														
50	75, 100	58.5	50.5	10.5	1/4	20.5	58.5	50.5	10.5	1/4	20.5	15	20	64	M10 x 1.5	7	17

Bore size	Stroke range ^{Note)}	L	M	N	O	T_1	T_2	W	Z
32	5	7	34	5.5	9	7	7	49.5	14
	10 to 50								
	75, 100								
40	5 to 50	7	40	5.5	9	6	7	57	15
	75, 100								
	10 to 50	8	50	6.6	11	18	8	71	19
75, 100									

Note) A spacer of 20, 15, 10 or 5 mm is attached to 75 or 100 mm stroke to make an intermediate stroke (55, 60, 65, 70 and 80, 85, 90, 95). Therefore, the same dimensions as the 75 or 100 mm stroke can be obtained.

10-11-C(D)Q2B63 to 100, 21-22-C(D)Q2B63 to 100 (For without auto switches, the A and B dimensions will be only changed. Please refer to the dimension table.)

Rod end female thread

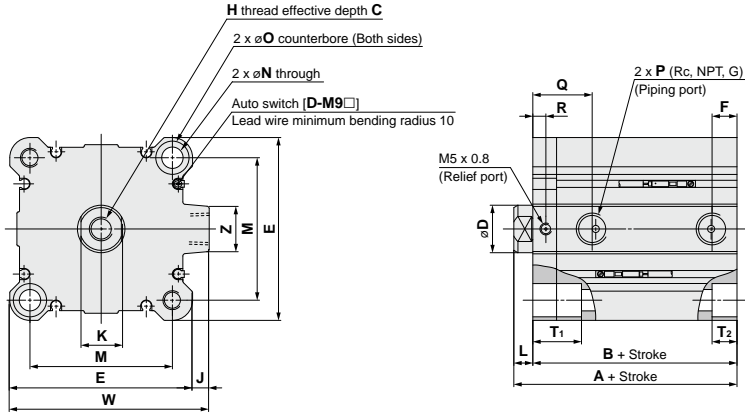

Rod end male thread

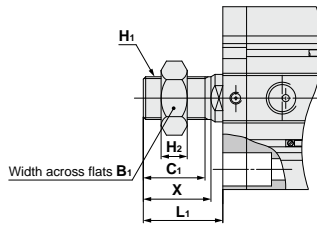

Rod end male thread (mm)

Bore size	B ₁	C ₁	H ₁	H ₂	L ₁	X
63	27	26	M18 x 1.5	11	33.5	28.5
80	32	32.5	M22 x 1.5	13	43.5	35.5
100	41	32.5	M26 x 1.5	16	43.5	35.5

Standard

Bore size	Stroke range ^{Note)}	Without auto switch		With auto switch		C	D	E	F	H	J	K	L	M	N	O	P	Q
		A	B	A	B													
		(mm)																
63	10 to 50	54	46	64	56	15	20	77	10.5	M10 x 1.5	7	17	8	60	9	14	1/4	25
	75, 100	64	56															
80	10 to 50	68.5	58.5	78.5	68.5	21	25	98	12.5	M16 x 2.0	6	22	10	77	11	17.5	3/8	31
	75, 100	78.5	68.5															
100	10 to 50	80	68	90	78	27	30	117	13	M20 x 2.5	6.5	27	12	94	11	17.5	3/8	38
	75, 100	90	78															

Bore size	Stroke range ^{Note)}	R	T ₁	T ₂	W	Z
63	10 to 50	5.5	20.5	10.5	84	19
	75, 100					
80	10 to 50	10	28.5	13.5	104	25
	75, 100					
100	10 to 50	10	28.5	13.5	123.5	25
	75, 100					

Note) A spacer of 20, 15, 10 or 5 mm is attached to 75 or 100 mm stroke to make an intermediate stroke (55, 60, 65, 70 and 80, 85, 90, 95). Therefore, the same dimensions as the 75 or 100 mm stroke can be obtained.

Directional Control Valves
Air Cylinders
Rotary Actuators
Air Grippers
Air Preparation Equipment
Modular F. R.
Pressure Control Equipment
Fittings & Tubing
Flow Control Equipment
Pressure Switches/ Pressure Sensors

Mounting Bolt for CQ2

Mounting method: Mounting bolt for through-hole mounting of the CQ2B is available as an option.

Refer to the following for ordering procedures.

Order the actual number of bolts that will be used.

Example) CQ-M5 x 40L 2 pcs.

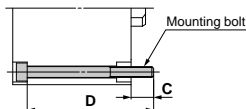
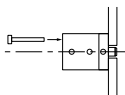

Rod side mounting/Without auto switch

Model		C	D	Mounting bolt
10-	11-	6.5	CQ2B12-5D	35 CQ-M3 x 35L
			-10D	40 x 40L
			-15D	45 x 45L
			-20D	50 x 50L
			-25D	55 x 55L
			-30D	60 x 60L
10-	11-	5	CQ2B16-5D	35 CQ-M3 x 35L
			-10D	40 x 40L
			-15D	45 x 45L
			-20D	50 x 50L
			-25D	55 x 55L
			-30D	60 x 60L
10-	11-	7.5	CQ2B20-5D	35 CQ-M5 x 35L
			-10D	40 x 40L
			-15D	45 x 45L
			-20D	50 x 50L
			-25D	55 x 55L
			-30D	60 x 60L
			-35D	65 x 65L
			-40D	70 x 70L
			-45D	75 x 75L
			-50D	80 x 80L
10-	11-	9.5	CQ2B25-5D	40 CQ-M5 x 40L
			-10D	45 x 45L
			-15D	50 x 50L
			-20D	55 x 55L
			-25D	60 x 60L
			-30D	65 x 65L
			-35D	70 x 70L
			-40D	75 x 75L
			-45D	80 x 80L
			-50D	85 x 85L
10-21-	11-22-	9	CQ2B32-5DZ	40 CQ-M5 x 40L
			-10DZ	45 x 45L
			-15DZ	50 x 50L
			-20DZ	55 x 55L
			-25DZ	60 x 60L
			-30DZ	65 x 65L
			-35DZ	70 x 70L
			-40DZ	75 x 75L
			-45DZ	80 x 80L
			-50DZ	85 x 85L
-75DZ	120 x 120L			
-100DZ	145 x 145L			
10-21-	11-22-	7.5	CQ2B40-5DZ	45 CQ-M5 x 45L
			-10DZ	50 x 50L
			-15DZ	55 x 55L
			-20DZ	60 x 60L
			-25DZ	65 x 65L
			-30DZ	70 x 70L
			-35DZ	75 x 75L
			-40DZ	80 x 80L
			-45DZ	85 x 85L
			-50DZ	90 x 90L
-75DZ	125 x 125L			
-100DZ	150 x 150L			

Model		C	D	Mounting bolt
10-21-	11-22-	12.5	CQ2B50-10DZ	55 CQ-M6 x 55L
			-15DZ	60 x 60L
			-20DZ	65 x 65L
			-25DZ	70 x 70L
			-30DZ	75 x 75L
			-35DZ	80 x 80L
			-40DZ	85 x 85L
			-45DZ	90 x 90L
			-50DZ	95 x 95L
			-75DZ	130 x 130L
-100DZ	155 x 155L			
10-21-	11-22-	14.5	CQ2B63-10DZ	60 CQ-M8 x 60L
			-15DZ	65 x 65L
			-20DZ	70 x 70L
			-25DZ	75 x 75L
			-30DZ	80 x 80L
			-35DZ	85 x 85L
			-40DZ	90 x 90L
			-45DZ	95 x 95L
			-50DZ	100 x 100L
			-75DZ	135 x 135L
-100DZ	160 x 160L			
10-21-	11-22-	15	CQ2B80-10DZ	70 CQ-M10 x 70L
			-15DZ	75 x 75L
			-20DZ	80 x 80L
			-25DZ	85 x 85L
			-30DZ	90 x 90L
			-35DZ	95 x 95L
			-40DZ	100 x 100L
			-45DZ	105 x 105L
			-50DZ	110 x 110L
			-75DZ	145 x 145L
-100DZ	170 x 170L			
10-21-	11-22-	15.5	CQ2B100-10DZ	80 CQ-M10 x 80L
			-15DZ	85 x 85L
			-20DZ	90 x 90L
			-25DZ	95 x 95L
			-30DZ	100 x 100L
			-35DZ	105 x 105L
			-40DZ	110 x 110L
			-45DZ	115 x 115L
			-50DZ	120 x 120L
			-75DZ	155 x 155L
-100DZ	180 x 180L			

Mounting Bolt for CQ2

Mounting method: Mounting bolt for through-hole mounting of the CQ2B is available as an option.

Refer to the following for ordering procedures.
Order the actual number of bolts that will be used.

Example) CQ-M5 x 40L 2 pcs.

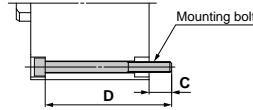
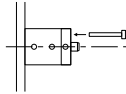

Head side mounting/Without auto switch

Model		C	D	Mounting bolt	
10-	11-	6.5	35	CQ-M3 x 35L	
				-10D	x 40L
				-15D	x 45L
				-20D	x 50L
				-25D	x 55L
				-30D	x 60L
10-	11-	5	35	CQ-M3 x 35L	
				-10D	x 40L
				-15D	x 45L
				-20D	x 50L
				-25D	x 55L
				-30D	x 60L
10-	11-	7.5	35	CQ-M5 x 35L	
				-10D	x 40L
				-15D	x 45L
				-20D	x 50L
				-25D	x 55L
				-30D	x 60L
				-35D	x 65L
				-40D	x 70L
				-45D	x 75L
				-50D	x 80L
10-	11-	9.5	40	CQ-M5 x 40L	
				-10D	x 45L
				-15D	x 50L
				-20D	x 55L
				-25D	x 60L
				-30D	x 65L
				-35D	x 70L
				-40D	x 75L
				-45D	x 80L
				-50D	x 85L
10-21-	11-22-	9	40	CQ-M5 x 40L	
				-10DZ	x 45L
				-15DZ	x 50L
				-20DZ	x 55L
				-25DZ	x 60L
				-30DZ	x 65L
				-35DZ	x 70L
				-40DZ	x 75L
				-45DZ	x 80L
				-50DZ	x 85L
10-21-	11-22-	11.5	50	CQ-M5 x 50L	
				-10DZ	x 55L
				-15DZ	x 60L
				-20DZ	x 65L
				-25DZ	x 70L
				-30DZ	x 75L
				-35DZ	x 80L
				-40DZ	x 85L
				-45DZ	x 90L
				-50DZ	x 95L
			130	x 130L	
			155	x 155L	

Model		C	D	Mounting bolt	
10-21-	11-22-	12.5	45	CQ-M6 x 45L	
				-15DZ	x 50L
				-20DZ	x 55L
				-25DZ	x 60L
				-30DZ	x 65L
				-35DZ	x 70L
				-40DZ	x 75L
				-45DZ	x 80L
				-50DZ	x 85L
				-75DZ	x 120L
			145	x 145L	
10-21-	11-22-	14.5	55	CQ-M8 x 50L	
				-15DZ	x 55L
				-20DZ	x 60L
				-25DZ	x 65L
				-30DZ	x 70L
				-35DZ	x 75L
				-40DZ	x 80L
				-45DZ	x 85L
				-50DZ	x 90L
				-75DZ	x 125L
			150	x 150L	
10-21-	11-22-	15	55	CQ-M10 x 55L	
				-15DZ	x 60L
				-20DZ	x 65L
				-25DZ	x 70L
				-30DZ	x 75L
				-35DZ	x 80L
				-40DZ	x 85L
				-45DZ	x 90L
				-50DZ	x 95L
				-75DZ	x 130L
			155	x 155L	
10-21-	11-22-	15.5	65	CQ-M10 x 65L	
				-15DZ	x 70L
				-20DZ	x 75L
				-25DZ	x 80L
				-30DZ	x 85L
				-35DZ	x 90L
				-40DZ	x 95L
				-45DZ	x 100L
				-50DZ	x 105L
				-75DZ	x 140L
			160	x 165L	

- Directional Control Valves
- Air Cylinders
- Rotary Actuators
- Air Grippers
- Air Preparation Equipment
- Modular F. R.
- Pressure Control Equipment
- Fittings & Tubing
- Flow Control Equipment
- Pressure Switches/ Pressure Sensors

Mounting Bolt for CDQ2

Mounting method: Mounting bolt for through-hole mounting of the CDQ2B is available as an option.

Refer to the following for ordering procedures.

Order the actual number of bolts that will be used.

Example) CQ-M5 x 50L 2 pcs.

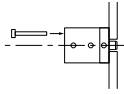
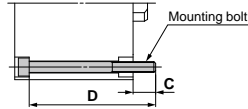

Rod side mounting/With auto switch

Model		C	D	Mounting bolt	
10-	11-	5.5	45	CQ-M3 x 45L	
				-10DCZ	50 x 50L
				-15DCZ	55 x 55L
				-20DCZ	60 x 60L
				-25DCZ	65 x 65L
				-30DCZ	70 x 70L
10-	11-	8	50	CQ-M3 x 50L	
				-10DZ	55 x 55L
				-15DZ	60 x 60L
				-20DZ	65 x 65L
				-25DZ	70 x 70L
				-30DZ	75 x 75L
10-	11-	10.5	50	CQ-M5 x 50L	
				-10DZ	55 x 55L
				-15DZ	60 x 60L
				-20DZ	65 x 65L
				-25DZ	70 x 70L
				-30DZ	75 x 75L
				-35DZ	80 x 80L
				-40DZ	85 x 85L
				-45DZ	90 x 90L
				-50DZ	95 x 95L
10-	11-	9.5	50	CQ-M5 x 50L	
				-10DZ	55 x 55L
				-15DZ	60 x 60L
				-20DZ	65 x 65L
				-25DZ	70 x 70L
				-30DZ	75 x 75L
				-35DZ	80 x 80L
				-40DZ	85 x 85L
				-45DZ	90 x 90L
				-50DZ	95 x 95L
10-21-	11-22-	9	50	CQ-M5 x 50L	
				-10DZ	55 x 55L
				-15DZ	60 x 60L
				-20DZ	65 x 65L
				-25DZ	70 x 70L
				-30DZ	75 x 75L
				-35DZ	80 x 80L
				-40DZ	85 x 85L
				-45DZ	90 x 90L
				-50DZ	95 x 95L
10-21-	11-22-	7.5	55	CQ-M5 x 55L	
				-10DZ	60 x 60L
				-15DZ	65 x 65L
				-20DZ	70 x 70L
				-25DZ	75 x 75L
				-30DZ	80 x 80L
				-35DZ	85 x 85L
				-40DZ	90 x 90L
				-45DZ	95 x 95L
				-50DZ	100 x 100L
-75DZ	125 x 125L				
-100DZ	150 x 150L				

Model		C	D	Mounting bolt	
10-21-	11-22-	12.5	65	CQ-M6 x 65L	
				-15DZ	70 x 70L
				-20DZ	75 x 75L
				-25DZ	80 x 80L
				-30DZ	85 x 85L
				-35DZ	90 x 90L
				-40DZ	95 x 95L
				-45DZ	100 x 100L
				-50DZ	105 x 105L
				-75DZ	130 x 130L
-100DZ	155 x 155L				
10-21-	11-22-	14.5	70	CQ-M8 x 70L	
				-15DZ	75 x 75L
				-20DZ	80 x 80L
				-25DZ	85 x 85L
				-30DZ	90 x 90L
				-35DZ	95 x 95L
				-40DZ	100 x 100L
				-45DZ	105 x 105L
				-50DZ	110 x 110L
				-75DZ	135 x 135L
-100DZ	160 x 160L				
10-21-	11-22-	15	80	CQ-M10 x 80L	
				-15DZ	85 x 85L
				-20DZ	90 x 90L
				-25DZ	95 x 95L
				-30DZ	100 x 100L
				-35DZ	105 x 105L
				-40DZ	110 x 110L
				-45DZ	115 x 115L
				-50DZ	120 x 120L
				-75DZ	145 x 145L
-100DZ	170 x 170L				
10-21-	11-22-	15.5	90	CQ-M10 x 90L	
				-15DZ	95 x 95L
				-20DZ	100 x 100L
				-25DZ	105 x 105L
				-30DZ	110 x 110L
				-35DZ	115 x 115L
				-40DZ	120 x 120L
				-45DZ	125 x 125L
				-50DZ	130 x 130L
				-75DZ	155 x 155L
-100DZ	180 x 180L				

Mounting Bolt for CDQ2

Mounting method: Mounting bolt for through-hole mounting of the CDQ2B is available as an option.

Refer to the following for ordering procedures.
Order the actual number of bolts that will be used.

Example) CQ-M5 x 50L 2 pcs.

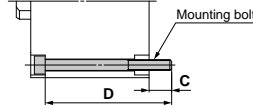
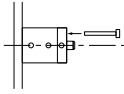

Head side mounting/With auto switch

Model		C	D	Mounting bolt
10-	11-	5.5	CDQ2B12-5DCZ	35 CQ-M3 x 35L
			-10DCZ	40 x 40L
			-15DCZ	45 x 45L
			-20DCZ	50 x 50L
			-25DCZ	55 x 55L
			-30DCZ	60 x 60L
10-	11-	8	CDQ2B16-5DZ	40 CQ-M3 x 40L
			-10DZ	45 x 45L
			-15DZ	50 x 50L
			-20DZ	55 x 55L
			-25DZ	60 x 60L
			-30DZ	65 x 65L
10-	11-	10.5	CDQ2B20-5DZ	40 CQ-M5 x 40L
			-10DZ	45 x 45L
			-15DZ	50 x 50L
			-20DZ	55 x 55L
			-25DZ	60 x 60L
			-30DZ	65 x 65L
			-35DZ	70 x 70L
			-40DZ	75 x 75L
			-45DZ	80 x 80L
			-50DZ	85 x 85L
10-	11-	9.5	CDQ2B25-5DZ	40 CQ-M5 x 40L
			-10DZ	45 x 45L
			-15DZ	50 x 50L
			-20DZ	55 x 55L
			-25DZ	60 x 60L
			-30DZ	65 x 65L
			-35DZ	70 x 70L
			-40DZ	75 x 75L
			-45DZ	80 x 80L
			-50DZ	85 x 85L
10-21-	11-22-	9	CDQ2B32-5DZ	50 CQ-M5 x 50L
			-10DZ	55 x 55L
			-15DZ	60 x 60L
			-20DZ	65 x 65L
			-25DZ	70 x 70L
			-30DZ	75 x 75L
			-35DZ	80 x 80L
			-40DZ	85 x 85L
			-45DZ	90 x 90L
			-50DZ	95 x 95L
10-21-	11-22-	11.5	CDQ2B40-5DZ	60 CQ-M5 x 60L
			-10DZ	65 x 65L
			-15DZ	70 x 70L
			-20DZ	75 x 75L
			-25DZ	80 x 80L
			-30DZ	85 x 85L
			-35DZ	90 x 90L
			-40DZ	95 x 95L
			-45DZ	100 x 100L
			-50DZ	105 x 105L
-75DZ	130 x 130L			
-100DZ	155 x 155L			

Model		C	D	Mounting bolt
10-21-	11-22-	12.5	CDQ2B50-10DZ	55 CQ-M6 x 55L
			-15DZ	60 x 60L
			-20DZ	65 x 65L
			-25DZ	70 x 70L
			-30DZ	75 x 75L
			-35DZ	80 x 80L
			-40DZ	85 x 85L
			-45DZ	90 x 90L
			-50DZ	95 x 95L
			-75DZ	120 x 120L
-100DZ	145 x 145L			
10-21-	11-22-	14.5	CDQ2B63-10DZ	60 CQ-M8 x 60L
			-15DZ	65 x 65L
			-20DZ	70 x 70L
			-25DZ	75 x 75L
			-30DZ	80 x 80L
			-35DZ	85 x 85L
			-40DZ	90 x 90L
			-45DZ	95 x 95L
			-50DZ	100 x 100L
			-75DZ	125 x 125L
-100DZ	150 x 150L			
10-21-	11-22-	15	CDQ2B80-10DZ	65 CQ-M10 x 65L
			-15DZ	70 x 70L
			-20DZ	75 x 75L
			-25DZ	80 x 80L
			-30DZ	85 x 85L
			-35DZ	90 x 90L
			-40DZ	95 x 95L
			-45DZ	100 x 100L
			-50DZ	105 x 105L
			-75DZ	130 x 130L
-100DZ	155 x 155L			
10-21-	11-22-	15.5	CDQ2B100-10DZ	75 CQ-M10 x 75L
			-15DZ	80 x 80L
			-20DZ	85 x 85L
			-25DZ	90 x 90L
			-30DZ	95 x 95L
			-35DZ	100 x 100L
			-40DZ	105 x 105L
			-45DZ	110 x 110L
			-50DZ	115 x 115L
			-75DZ	140 x 140L
-100DZ	165 x 165L			

Directional Control Valves

Air Cylinders

Rotary Actuators

Air Grippers

Air Preparation Equipment

Modular F. R.

Pressure Control Equipment

Fittings & Tubing

Flow Control Equipment

Pressure Switches/ Pressure Sensors

Series 12-CY3B $\phi 6, \phi 10, \phi 15, \phi 20, \phi 25, \phi 32, \phi 40, \phi 50, \phi 63$ Magnetically Coupled Rodless Cylinder

How to Order



● Clean series
 12 — Special treatment on sliding part

● Bore size (mm)

12 - CY3B 15 - 300

● Cylinder stroke (mm)

● Port thread type

Symbol	Type	Bore size
Nil	M3 x 0.5	6
	M5 x 0.8	10, 15
	Rc	20, 25, 32, 40
TN	NPT	
TF	G	50, 63

Model

Model	Bore size (mm)	Port size	Lubrication	Standard stroke (mm)	Maximum manufacturable stroke	Cushion		
						Rubber	Air	
12-CY3B6	6	M3 x 0.5	Non-lube	50, 100, 150, 200	300	○ (Both sides)	—	
12-CY3B10	10	M5 x 0.8		50, 100, 150, 200, 250, 300	500			
12-CY3B15	15			50, 100, 150, 200, 250, 300, 350, 400, 450, 500	1000			
12-CY3B20	20	Rc1/8		100, 150, 200, 250, 300, 350,	1300			
12-CY3B25	25	NPT1/8		400, 450, 500, 600, 700, 800				
12-CY3B32	32	G1/8		100, 150, 200, 250, 300, 350, 400,				
12-CY3B40	40	Rc1/4		100, 150, 200, 250, 300, 350, 400,	1300			
12-CY3B50	50	NPT1/4						450, 500, 600, 700, 800, 900, 1000
12-CY3B63	63	G1/4						

Note 1) Stroke exceeding the standard stroke but below the maximum manufacturable stroke is available as special order.

Note 2) Intermediate strokes are available in 1 mm increments.

Note 3) Please contact SMC if the maximum manufacturable stroke is exceeded.

Specifications

Item	Bore size (mm)									
	6	10	15	20	25	32	40	50	63	
Proof pressure	1.05 MPa									
Maximum operating pressure	0.7 MPa									
Minimum operating pressure	0.16 MPa		0.15 MPa		0.14 MPa		0.12 MPa			
Ambient and fluid temperature	-10°C to 60°C (No freezing)									
Piston speed	50 to 400 mm/s									
Stroke length tolerance	0 to 250 st: $^{+1.0}_0$, 251 to 1000 st: $^{+1.4}_0$, Over 1001 st: $^{+1.8}_0$									
Mounting bracket	2 mounting nuts (Standard)									
Grease	Fluorine grease									
Cleanliness class (ISO class)	Class 5									

Magnetic Holding Force (N)

Bore size (mm)	6	10	15	20	25	32	40	50	63
Holding force	19.6	53.9	137	231	363	588	922	1471	2256

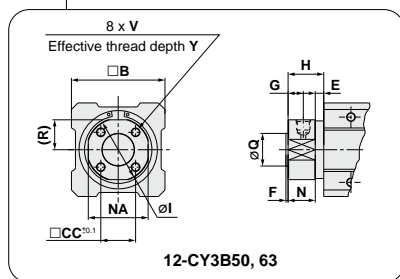
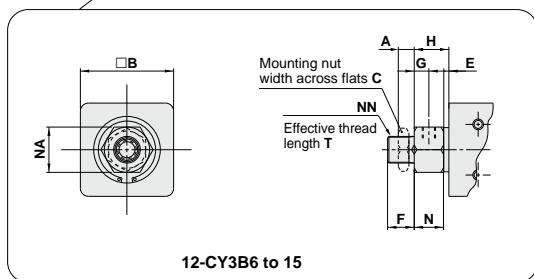
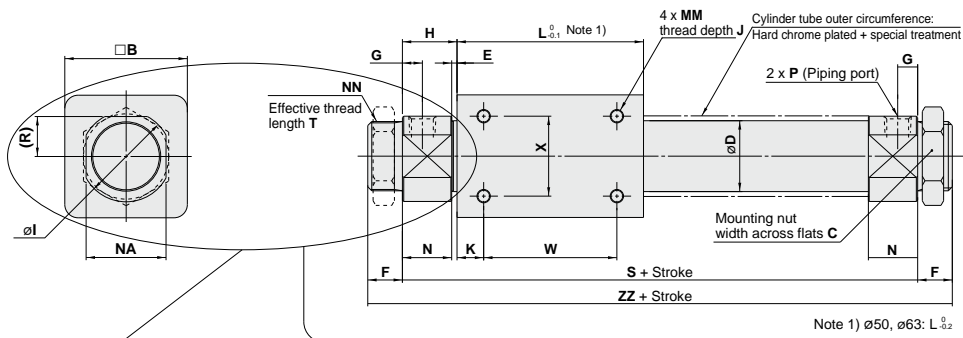
Dimensions
12-CY3B6 to 63

Model	A	B	C	CC	D	E	F	G	H	I	J	K	L	MM	N	NA	NN	Q	R	S	T	V
12-CY3B6	4	17	8*	—	7.6	4	8*	5	13.5*	—	4.5	5	35	M3 x 0.5	9.5*	10*	M6 x 1*	—	—	62 ³	6.5	—
12-CY3B10	4	25	14	—	12	1.5	9	5	12.5	—	4.5	4	38	M3 x 0.5	11	14	M10 x 1	—	—	63	7.5	—
12-CY3B15	4	35	14	—	16.6*	2	10	5.5	13	—	6	11	57	M4 x 0.7	11	17	M10 x 1	—	—	83	8	—
12-CY3B20	8	36	26	—	21.6*	2*	13	7.5*	20	28	6	8	66	M4 x 0.7	18*	24	M20 x 1.5	—	12*	106	10	—
12-CY3B25	8	46	32	—	26.4*	2*	13	7.5*	20.5	34	8	10	70	M5 x 0.8	18.5*	30	M26 x 1.5	—	15*	111	10	—
12-CY3B32	8	60	32	—	33.6*	2*	16	8*	22	40	8	15	80	M6 x 1	20*	36	M26 x 1.5	—	18*	124	13	—
12-CY3B40	10	70	41	—	41.6*	3*	16	11	29	50	10	16	92	M6 x 1	26*	46	M32 x 2	—	23*	150	13	—
12-CY3B50	—	86	—	32	52.4*	8	2	14	33	58*	12	25	110	M8 x 1.25	25	55	—	30 ^{-0.007}	27.5*	176	—	M8 x 1.25
12-CY3B63	—	100	—	38	65.4*	8	2	14	33	72*	12	26	122	M8 x 1.25	25	69	—	32 ^{-0.043}	34.5*	188	—	M10 x 1.5

Model	W	X	Y	ZZ	P (Piping port)		
					NII	TN*	TF*
12-CY3B6	25	10	—	78*	M3 x 0.5*	—	—
12-CY3B10	30	16	—	81	M5 x 0.8	—	—
12-CY3B15	35	19	—	103	M5 x 0.8	—	—
12-CY3B20	50	25	—	132	Rc 1/8	NPT 1/8	G 1/8
12-CY3B25	50	30	—	137	Rc 1/8	NPT 1/8	G 1/8
12-CY3B32	50	40	—	156	Rc 1/8	NPT 1/8	G 1/8
12-CY3B40	60	40	—	182	Rc 1/4	NPT 1/4	G 1/4
12-CY3B50	60	60	16	180	Rc 1/4	NPT 1/4	G 1/4
12-CY3B63	70	70	16	192	Rc 1/4	NPT 1/4	G 1/4

Note 2) The asterisk denotes the dimensions which are different from the 12-CY1B series.

Note 3) Mounting nuts can be screwed on only for the effective thread length of the head cover (T dimension). When mounting a cylinder, consider the thickness of flange, etc.

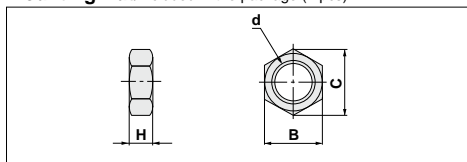
Mounting Nut/Included in the package (2 pcs).

Part no.	Applicable bore size (mm)	d	H	B	C
SNJ-006B	6	M6 x 1.0	4	8	9.2
SNJ-016B	10, 15	M10 x 1.0	4	14	16.2
SN-020B	20	M20 x 1.5	8	26	30
SN-032B	25, 32	M26 x 1.5	8	32	37
SN-040B	40	M32 x 2.0	10	41	47.3

Note) Mounting nuts are not available for $\phi 50$ and $\phi 63$.

Series 12-CY3R $\phi 6, \phi 10, \phi 15, \phi 20, \phi 25, \phi 32, \phi 40, \phi 50, \phi 63$

Magnetically Coupled Rodless Cylinder (Direct Mount)

How to Order

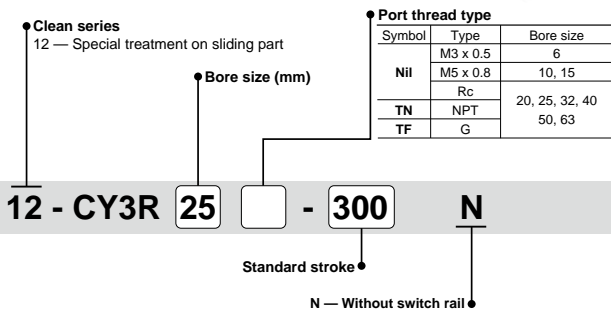

* Switch rail is not available for 12-series.

Model

Model	Bore size (mm)	Port size	Lubrication	Standard stroke (mm)	Maximum manufacturable stroke (mm)	Cushion	
						Rubber	Air
12-CY3R6	6	M3 x 0.5	Non-lube	50, 100, 150, 200	300	○ (Both sides)	—
12-CY3R10	10	M5 x 0.8		50, 100, 150, 200, 250, 300	500		
12-CY3R15	15			50, 100, 150, 200, 250, 300, 350, 400, 450, 500	1000		
12-CY3R20	20	Rc1/8		100, 150, 200, 250, 300, 350, 400, 450, 500, 600, 700, 800	1300		
12-CY3R25	25	NPT1/8					
12-CY3R32	32	G1/8					
12-CY3R40	40	Rc1/4					
12-CY3R50	50	NPT1/4		100, 150, 200, 250, 300, 350, 400, 450, 500, 600, 700, 800, 900, 1000			
12-CY3R63	63	G1/4					

Note 1) Stroke exceeding the standard stroke but below the maximum manufacturable stroke is available as special order.

Note 2) Intermediate strokes are available in 1 mm increments.

Note 3) Please contact SMC if the maximum manufacturable stroke is exceeded.

Specifications

Item	Bore size (mm)									
	6	10	15	20	25	32	40	50	63	
Proof pressure	1.05 MPa									
Maximum operating pressure	0.7 MPa									
Minimum operating pressure	0.16 MPa				0.15 MPa		0.14 MPa		0.12 MPa	
Ambient and fluid temperature	-10°C to 60°C (No freezing)									
Piston speed	50 to 400 mm/s									
Stroke length tolerance	0 to 250 st: $^{+1}_0$, 251 to 1000 st: $^{+1}_0$, Over 1001 st: $^{+1.8}_0$									
Mounting	Direct mount									
Grease	Fluorine grease									
Cleanliness class (ISO class)	Class 5									

Magnetic Holding Force (N)

Bore size (mm)	6	10	15	20	25	32	40	50	63
Holding force	19.6	53.9	137	231	363	588	922	1471	2256

Dimensions

12-CY3R6 to 63

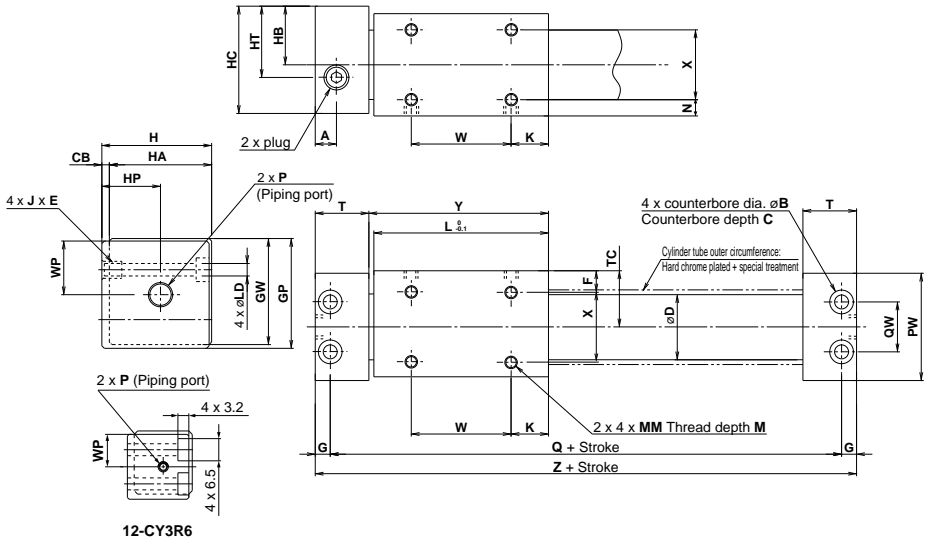

12-CY3R6

(mm)

Model	A	B	C	CB	D	F	G	GP	GW	H	HA	HB	HC	HP	HT	J x E	K
12-CY3R6	7*	—*	—*	2	7.6	5.5	3*	20	18.5	19	17	10.5	18	10.5*	10.5*	M4 x 0.7 x 6	7
12-CY3R10	9	6.5	3.2	2	12	6.5	4	27	25.5	26	24	14	25	14	14	M4 x 0.7 x 6	9
12-CY3R15	10.5	8	4.2	2	16.6*	8	5	33	31.5	32	30	17	31	17	17	M5 x 0.8 x 7	14
12-CY3R20	9	9.5	5.2	3	21.6*	9	6	39	37.5	39	36	21	38	24	24	M6 x 1 x 8	11
12-CY3R25	8.5	9.5	5.2	3	26.4*	8.5	6	44	42.5	44	41	23.5	43	23.5	23.5	M6 x 1 x 8	15
12-CY3R32	10.5	11	6.5	3	33.6*	10.5	7	55	53.5	55	52	29	54	29	29	M8 x 1.25 x 10	13
12-CY3R40	10	11	6.5	5	41.6*	13	7	65	63.5	67	62	36	66	36	36	M8 x 1.25 x 10	15
12-CY3R50	14	14	8.2	5	52.4*	17	8.5	83	81.5	85	80	45	84	45	45	M10 x 1.5 x 15	25
12-CY3R63	15	14	8.2	5	65.4*	18	8.5	95	93.5	97	92	51	96	51	51	M10 x 1.5 x 15	24

Model	L	LD	M	MM	N	PW	Q	QW	T	TC	W	WP	X	Y	Z
12-CY3R6	34	3.5	3.5	M3 x 0.5	3.5	19	60*	10	14.5*	10.5	20	9.5	10	35.5	66*
12-CY3R10	38	3.5	4	M3 x 0.5	4.5	26	68	14	17.5	14	20	13	15	39.5	76
12-CY3R15	53	4.3	5	M4 x 0.7	6	32	84	18	19	17	25	16	18	54.5	94
12-CY3R20	62	5.4	5	M4 x 0.7	7	38	95	17	20.5	20	40	19	22	64	107
12-CY3R25	70	5.4	6	M5 x 0.8	6.5	43	105	20	21.5	22.5	40	21.5	28	72	117
12-CY3R32	76	7	7	M6 x 1	8.5	54	116	26	24	28	50	27	35	79	130
12-CY3R40	90	7	8	M6 x 1	11	64	134	34	26	33	60	32	40	93	148
12-CY3R50	110	8.6	10	M8 x 1.25	15	82	159	48	30	42	60	41	50	113	176
12-CY3R63	118	8.6	10	M8 x 1.25	16	94	171	60	32	48	70	47	60	121	188

Model	P (Piping port)		
	NH	TN*	TF*
12-CY3R6	M3 x 0.5*	—	—
12-CY3R10	M5 x 0.8	—	—
12-CY3R15	M5 x 0.8	—	—
12-CY3R20	Rc 1/8	NPT 1/8	G 1/8
12-CY3R25	Rc 1/8	NPT 1/8	G 1/8
12-CY3R32	Rc 1/8	NPT 1/8	G 1/8
12-CY3R40	Rc 1/4	NPT 1/4	G 1/4
12-CY3R50	Rc 1/4	NPT 1/4	G 1/4
12-CY3R63	Rc 1/4	NPT 1/4	G 1/4

Note) The asterisk denotes the dimensions which are different from the 12-CY1R series.

Directional Control Valves
 Air Cylinders
 Rotary Actuators
 Air Grippers
 Air Preparation Equipment
 Modular F. R.
 Pressure Control Equipment
 Fittings & Tubing
 Flow Control Equipment
 Pressure Switches/ Pressure Sensors

⚠ Specific Product Precautions

Be sure to read this before handling.

12-CY3B/3R Common Precautions

⚠ Caution

- 1. Use caution to the rotation of the external slider.**
Rotation should be controlled by connecting the external slider to another shaft (linear guide, etc.).
- 2. Do not operate with the magnetic coupling out of position.**
If the magnetic coupling is out of position, push the external slider by hand (or the position slider with air pressure) back to the proper position at the stroke end.
- 3. Do not apply a lateral load to the external slider.**
When a load is mounted directly to the cylinder, variations in the alignment of each shaft center cannot be offset, which results in the generation of a lateral load that can cause malfunction. The cylinder should be operated using a connection method which allows for shaft alignment variations and deflection due to the cylinder's own weight. A drawing of a recommended mounting method is shown in Fig. 1.

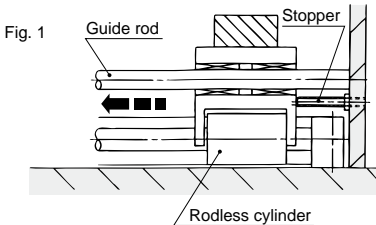

- 4. When used vertically for applications, use caution regarding allowable load.**
When used vertically for applications, use caution as there is a possibility of dropping due to separation of the magnetic coupling if a load greater than the allowable value is added. Please contact SMC for the operating conditions (pressure, load, speed, stroke, frequency, etc.) before use.
Refer to the WEB catalog (CY3 series model selection method) for details.
- 5. Do not scratch or gouge the external surface of the cylinder.**
It can damage the wear ring, increase particle generation and cause malfunction.
- 6. Do not use the cylinder with its body fixed.**
Be sure to secure both head covers (or end covers in case of CY3R) before using the cylinder. Operation of the cylinder with its body fixed will damage the wear ring, resulting in increase of particle generation or malfunction.

12-CY3R

⚠ Caution

- 1. Use caution to the cylinder mounting surface.**
If there is any clearance between the end covers on both ends and the mounting surfaces, adjust the shim with a spacer for secure installation.

Disassembly and Maintenance

12-CY3B

12-CY3R

⚠ Warning

1. Use caution as the attractive power of the magnets is very strong.

When removing the external slider and piston slider from the cylinder tube for maintenance, etc., handle with caution, since the magnets installed in each slider have a very strong attractive force.

⚠ Caution

1. Use caution when taking off the external slider, as the piston slider will be directly attracted to it.

When removing the external slider or piston slider from the cylinder tube, first force the sliders out of their magnetically coupled positions, and then remove them individually when there is no longer any holding force. If they are removed while still magnetically coupled, they will be directly attracted to one another and will not come apart.

2. Use caution to the direction of the external slider and the piston slider.

Since the external slider and piston slider are directional for $\phi 6$, $\phi 10$, refer to the figures below when performing disassembly or maintenance. Put the external slider and piston slider together, and insert the piston slider into the cylinder tube so that they will have the correct positional relationship as shown in Fig. 2. If they align as shown in Fig. 3, insert the piston slider after turning it around 180° .

If the direction is not correct, it will be impossible to obtain the specified holding force.



Fig. 2 Correct positioning

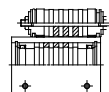

Fig. 3 Positioning in incorrect direction

3. Do not disassemble the magnetic components (piston slider and external slider).

This can cause a loss of holding force and malfunction.

4. When disassembling to replace the seals and wear ring, refer to the separate disassembly instructions.

⚠ Caution

5. Apply additional tightening when remounting the head cover after disassembly.

When disassembling, hold the wrench flat section of one head cover with a vise, and remove the other cover using a spanner or adjustable angle wrench on its wrench flat section. When retightening, first coat with Loctite (No. 542 red) and retighten 3° to 5° past the original position prior to removal.

5. Special tools are necessary for disassembly.

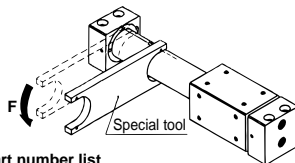

Special tool part number list

Part no.	Applicable bore size (mm)
CYRZ-V	6, 10, 15, 20
CYRZ-W	25, 32, 40
CYRZ-X	50
CYRZ-Y	63

Directional Control Valves

Air Cylinders

Rotary Actuators

Air Grippers

Air Preparation Equipment

Modular F. R.

Pressure Control Equipment

Fittings & Tubing

Flow Control Equipment

Pressure Switches/ Pressure Sensors

Series CYP ø15, ø32 Clean Rodless Cylinder

How to Order

CYP 15 200 Y59B

Clean rodless cylinder

Cylinder bore size

15	15 mm
32	32 mm

Standard stroke

Bore size (mm)	Standard stroke (mm)
15/32	100, 150, 200, 250, 300, 350 400, 450, 500, 600, 700

Note 1) Contact SMC if the maximum stroke is exceeded.
Note 2) Intermediate strokes are available as special orders.

Number of auto switches

Nil	2 pcs.
S	1 pc.
n	n pcs.

Auto switch

Nil	Without auto switch
-----	---------------------

For auto switch model numbers, refer to the table below.
* The minimum stroke for auto switch mounting and operating range are the same as standard products.

Piping port location

Nil	a	Operating direction: Right
	b	Operating direction: Left
L	c	Operating direction: Right
	d	Operating direction: Left
R	e	Operating direction: Right
	f	Operating direction: Left
S	g	Operating direction: Right
	h	Operating direction: Left



Piping port location

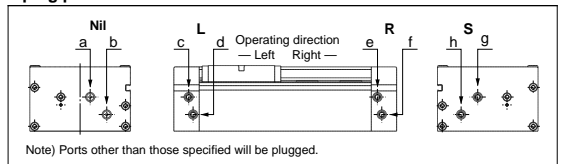

Auto Switch Specifications (Refer to the WEB catalog for detailed specifications and auto switches not in the following table.)

Type	Special function	Electrical entry	Indicator light	Wiring (Output)	Load voltage			Auto switch model	Lead wire length (m)*			Applicable load	
					DC	AC	In-line		0.5 Nil	3 (L)	5 (Z)		
								2-wire	5V, 12V	—	●		●
Reed auto switch	—	Grommet	Yes	2-wire	24 V	12 V	100 V	Z73	●	●	●	—	Relay, PLC
Solid state auto switch	—	Grommet	Yes	3-wire (NPN)	24 V	12 V	—	Y59A	●	●	○	IC circuit	Relay, PLC
				2-wire				Y59B	●	●	○	—	

* Lead wire symbol 0.5 m.....Nil (Example) Y59B

3 m.....L Y59BL
5 m.....Z Y59BZ

** Solid state auto switches marked with ○ are produced upon receipt of order.

Refer to page 889 for the applicable auto switch list.

PLC: Programmable Logic Controller

Specifications

Bore size (mm)	15	32
Fluid	Air and inert gas	
Action	Double acting	
Proof pressure	0.5 MPa	
Operating pressure range	0.05 to 0.3 MPa	
Ambient and fluid temperature	-10 to 60°C (No freezing)	
Piston speed	50 to 300 mm/s	
Lubrication	Non-lube	
Stroke adjustable range	±1 mm on each side (total ±2 mm)	
Cushion	Sine cushion (Air cushion)	
Piping port size	M5 x 0.8	Rc1/8
Grease	Fluorine grease	
Cleanliness class (ISO class)	Class 4	

Auto Switch Proper Mounting Position (Detection at Stroke End)

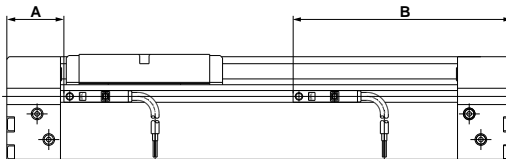

Auto Switch Proper Mounting Position

Auto switch model / Cylinder model	A		B	
	D-Z73	D-Y5□	D-Z73	D-Y5□
CYP15	24.5			93.5
CYP32	33			122

Note) The above mentioned values are indicated as a guide for auto switch mounting positions for stroke end detection. When actually mounting an auto switch, adjust the position after confirming the operating state of the auto switch.

Directional Control Valves
Air Cylinders
Rotary Actuators
Air Grippers
Air Preparation Equipment
Modular F. R.
Pressure Control Equipment
Fittings & Tubing
Flow Control Equipment
Pressure Switches/ Pressure Sensors

Dimensions

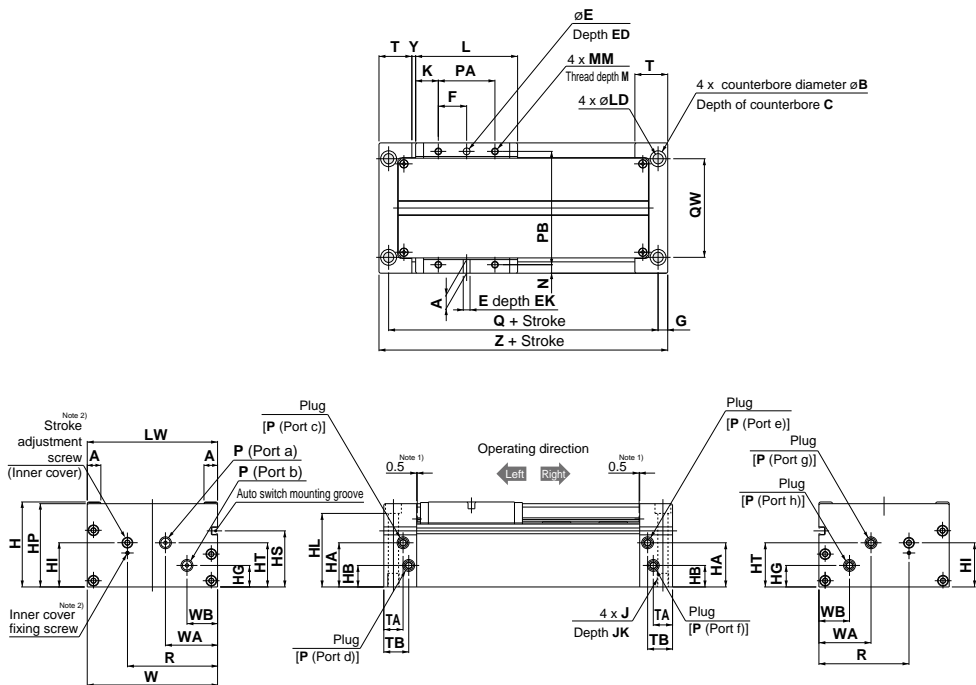

(mm)

Model	A	B	C	E	ED	EK	F	G	H	HA	HB	HG	HI	HL	HP	HS	HT	J	JK	K
CYP15	8	9.5	5.4	4H9 ^{+0.030} ₀	9.5	4	12.5	6.5	45	19.5	8.5	8.5	23	38.6	44	27	19.5	M6 x 1	10	21
CYP32	12	14	8.6	6H9 ^{+0.030} ₀	13	6	25	8.5	75	39	19	19	39	64.9	73.5	49.5	39	M10 x 1.5	12	20

Model	L	LD	LW	MM	M	N	P	PA	PB	Q	QW	R	T	TA	TB	W	WA	WB	Y	Z
CYP15	67	5.4	69	M4 x 0.7	6	4.5	M5 x 0.8	25	60	105	48	45	23	13	18	69	32	17	2.5	118
CYP32	90	8.6	115	M6 x 1	8	7.5	Rc1/8	50	100	138	87	79.5	29	17	22	115	46	27	3.5	155

Note 1) These dimensions indicate the protrusion of the bumper.

Note 2) Refer to the specific product precautions (stroke adjustment and cushion effect (sine cushion)).

⚠ Specific Product Precautions

Be sure to read this before handling.

Handling

⚠ Caution

1. Open the inner package of the double packaged clean series inside a clean room or other clean environment.
2. Perform parts replacement and disassembly work in a clean room after exhausting compressed air in the piping outside the clean room.

Mounting

⚠ Caution

1. Take care to avoid striking the cylinder tube with other objects or handling it in a way that could cause deformation. The cylinder tube and slider units have a non-contact construction. For this reason, even a slight deformation or slippage of position can cause malfunction and loss of durability, as well as a danger of degrading the particle generation characteristics.
2. Do not scratch or gouge the linear guide by striking it with other objects.
Since the linear guide is specially treated for maximum suppression of particle generation due to sliding, even a slight scratch can cause malfunction and loss of durability, as well as degradation in the particle generation characteristics.
3. Since the slide table is supported by precision bearings, do not apply strong impacts or excessive moment when mounting workpieces.
4. Be sure to operate the cylinder with the plates on both sides secured.
Avoid applications in which the slide table or only one plate is secured.
5. When changing the ports to be used, be sure that unused ports are securely sealed.
Take sufficient care in sealing unused ports, because if ports are not properly sealed, air can leak from the ports and particle generation characteristics can be degraded.

Operation

⚠ Caution

1. The maximum operating pressure of the clean rodless cylinder is 0.3 MPa.
If the maximum operating pressure of 0.3 MPa for the clean rodless cylinder is exceeded, the magnetic coupling could be broken, causing a danger of malfunction or degradation of particle generation characteristics, etc.
2. The product can be used with a direct load applied within the allowable range, but careful alignment is necessary when connecting to a load with an external guide mechanism.
Since alignment variations increase as the stroke gets longer, use a connection method which can absorb these variations and consider measures to control particle generation.

Operation

⚠ Caution

3. When used vertically for applications, use caution regarding dropping due to separation of the magnetic coupling.
When used vertically for applications, use caution as there is a possibility of dropping due to separation of the magnetic coupling if a load (pressure) greater than the allowable value is applied.
4. Do not operate with the magnetic coupling out of position.
If the magnetic coupling is out of position, push the external slider by hand (or the piston slider with air pressure) back to the proper position at the stroke end.
5. Do not supply lubrication, as this is a non-lube product.
The interior of the cylinder is lubricated at the factory, and lubrication with turbine oil, etc., will not satisfy the product's specifications.
6. Never apply lubricant newly.
Never apply lubricant newly, as there may be a degradation of particle generation characteristics or operation characteristics.

Speed Adjustment

⚠ Caution

1. A throttle valve for clean room use is recommended for speed adjustment. (Please consult with SMC regarding equipment and methods to be used.)
Speed adjustment can also be performed with a meter-in or meter-out type speed controller for clean room use, but it may not be possible to obtain smooth starting and stopping operation.

Throttle valves and dual speed controllers for recommended speed adjustment of CYP cylinders

Throttle valve	Series	Model	
		CYP15	CYP32
Metal body piping type	Elbow type	10-AS1200-M5-X216	10-AS2200-01-X214
	In-line type	10-AS1000-M5-X214	10-AS2000-01-X209
Resin body with One-touch fitting	Elbow type (Throttle valve)	10-AS1201F-M5-04-X214	10-AS2201F-01-04-X214
		10-AS1201F-M5-06-X214	10-AS2201F-01-06-X214
	Universal type (Throttle valve)	10-AS1301F-M5-04-X214	10-AS2301F-01-04-X214
		10-AS1301F-M5-06-X214	10-AS2301F-01-06-X214
	In-line type (Throttle valve)	10-AS1001F-04-X214	10-AS2001F-04-X214
		10-AS1001F-06-X214	10-AS2001F-06-X214
Dual type (Speed controller)	10-ASD230F-M5-04	10-ASD330F-01-06	
	10-ASD230F-M5-06	10-ASD330F-01-08	

Note 1) For the selection method of the metal body piping type and the resin body type with One-touch fitting, refer to pages 1243 to 1304.
Note 2) For fittings used with the metal body piping type, refer to pages 1124 to 1231.

2. For vertical mounting, a system with a reduced pressure supply circuit installed on the down side is recommended. (This is effective against upward starting delays and for air saving.)

Directional Control Valves

Air Cylinders

Rotary Actuators

Air Grippers

Air Preparation Equipment

Modular F. R.

Pressure Control Equipment

Fittings & Tubing

Flow Control Equipment

Pressure Switches/ Pressure Sensors

⚠ Specific Product Precautions

Be sure to read this before handling.

Stroke Adjustment and Cushion Effect (Sine Cushion)

⚠ Caution

1. A sine cushion function (for smooth start and soft stop) is included in the standard specifications.

Due to the nature of a sine cushion, adjustment of the cushion effect is not possible. There is no cushion needle adjustment as in the case of conventional cushion mechanisms.

2. The stroke adjustment is a mechanism to adapt the slide table's stroke end position to a mechanical stopper on other equipment, etc.

(Adjustment range: Total of both sides ± 2 mm)

To ensure safety, perform adjustment after shutting off the drive air, exhausting the residual pressure and implementing drop prevention measures.

- 1) Loosen the inner cover holding screw with a hexagon wrench, etc.
- 2) To align the position with a mechanical stopper on other equipment, rotate the stroke adjustment screw (inner cover) to the left or right with a hexagon wrench to move the inner cover back and force. Approximately 1 mm of adjustment is possible with one rotation.
- 3) The maximum adjustment on one side is ± 1 mm. A total adjustment of approximately ± 2 mm is possible with one rotation.
- 4) After completing the stroke adjustment, tighten the inner cover holding screw with a hexagon wrench, etc.

Inner cover holding screw tightening torque [N·m]

Model	Thread size	Tightening torque	Hexagon wrench size
CYP15	M3 x 0.5	0.3	1.5
CYP32	M6 x 1	2.45	3

Stroke adjustment screw

Model	Hexagon wrench size
CYP15	2.5
CYP32	4

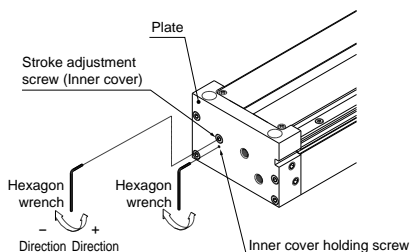

Maintenance

⚠ Caution

1. Never disassemble the cylinder tube or linear guide, etc.

If disassembled, the slide table may touch the outside surface of the cylinder tube, resulting in a degradation of particle generation characteristics.

2. Please consult with SMC when replacing seals and bearings (wear rings).

Particle Generation Characteristics

⚠ Caution

1. In order to maintain the particle generation class, use operation of 500 thousand cycles or travel distance of about 400 km as a standard. (Graph (1) below)

If operation is continued beyond the recommended values, lubrication failure of the linear guide and loss of particle generation characteristics may occur.

Graph (1)

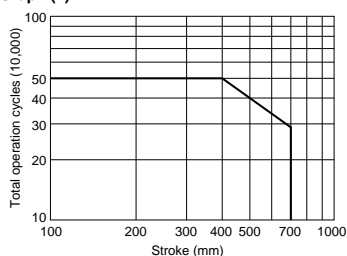

Graph (2)

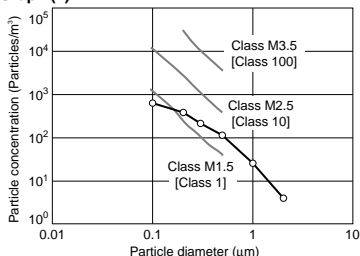

Note 1) This chart shows the level of cleanliness inside the measurement chamber.

Note 2) The vertical axis shows the number of particles per unit volume (1 m^3) of air which are no smaller than the particle size shown on the horizontal axis.

Note 3) The dotted lines show the upper concentration limit of the cleanliness class based on Fed.Std.209E-1992.

Note 4) The plots indicate a 95% upper reliability limit value for time series data up to 500 thousand operation cycles. (Cylinder: CYP32-200, Workpiece weight 5 kg, Average speed: 200 mm/s)

Note 5) The data above provides a guide for selection but is not guaranteed.

Series 13-22-MXS $\varnothing 6, \varnothing 8, \varnothing 12, \varnothing 16, \varnothing 20, \varnothing 25$ Air Side Table



How to Order

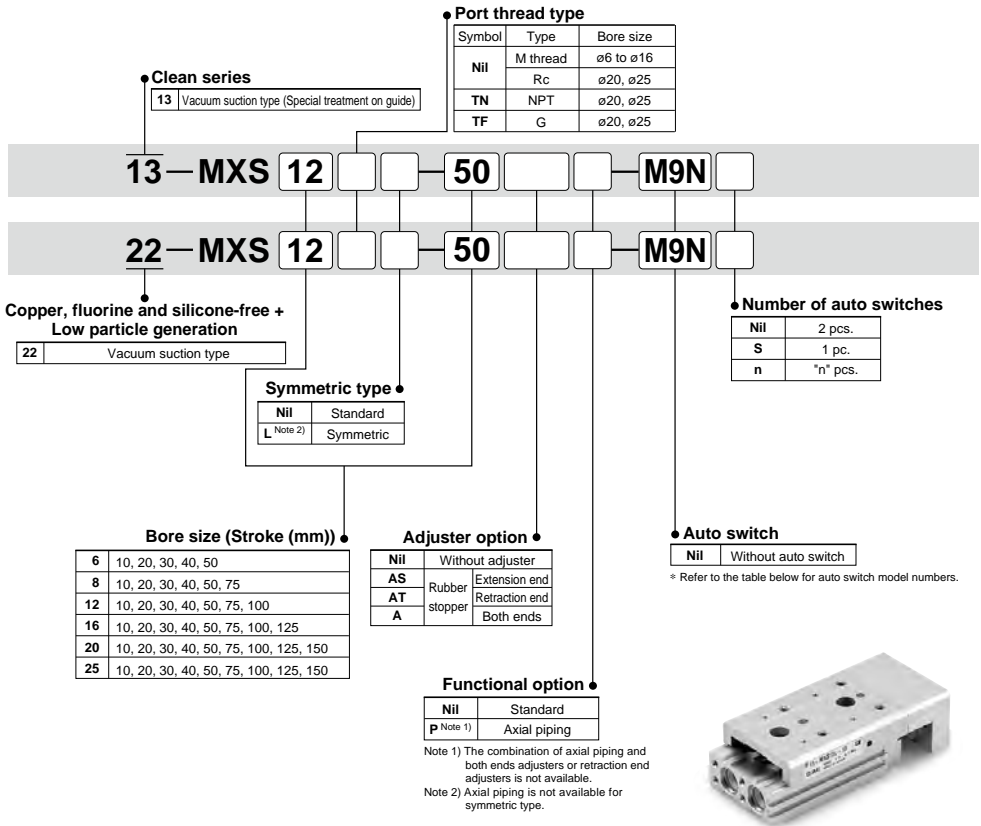

Auto Switch Specifications (Refer to the WEB catalog for detailed specifications and auto switches not in the following table.)

Type	Special function	Electrical entry	Indicator light	Wiring (Output)	Load voltage		Auto switch model	Lead wire length (m) *		Applicable load		
					DC	AC		Electrical entry direction				
					24 V	12 V	100 V	In-line	0.5 (Nil)		3 (L)	
Reed auto switch	—	Grommet	Yes	2-wire	24 V	12 V	100 V	A93	●	●	—	Relay, PLC
Solid state auto switch	—	Grommet	Yes	3-wire (NPN)	24 V	12 V	—	M9N	●	●	—	Relay, PLC
				2-wire				M9B	●	●	—	—

* Lead wire length symbols: 0.5 m.....Nil (Example) A93
 3 m.....L (Example) A93L

PLC: Programmable Logic Controller

Refer to page 889 for the applicable auto switch list.

Directional Control Valves

Air Cylinders

Rotary Actuators

Air Grippers

Air Preparation Equipment

Modular F. R.

Pressure Control Equipment

Fittings & Tubing

Flow Control Equipment

Pressure Switches/ Pressure Sensors

Specifications

Bore size (mm)	6	8	12	16	20	25
Fluid	Air					
Action	Double acting					
Operating pressure	0.15 to 0.7 MPa					
Proof pressure	1.05 MPa					
Ambient and fluid temperature	-10 to 60°C (No freezing)					
Piston speed	50 to 300 mm/s					
Cushion	Rubber bumper (Standard, With stroke adjuster)					
Lubrication	Non-lube					
Stroke length tolerance	+ ₀ mm					
Grease	13-: Fluorine grease 22-: Lithium soap based grease					
Cleanliness class (ISO class)	Without adjuster	13-/22-: Class 5				
	Rubber stopper					

Suction Flow Rate of Vacuum Suction Type (Reference values)

Bore size	Suction flow rate L/min (ANR)
6, 8, 12	1
16	2
20	3
25	5

Adjuster Option Stroke Adjustment Range

With stroke adjuster	Extension end (AS)	Stroke adjustment range 0 to 5 mm
	Retraction end (AT)	
	Both ends (A)	

Auto Switch Proper Mounting Position (Detection at Stroke End)



Reed auto switch: D-A93

Model	A	B										E										Auto switch operating range				
		Stroke										Stroke														
		10	20	30	40	50	75	100	125	150	10	20	30	40	50	75	100	125	150							
13-/22-MXS6	5.9	5.6	5.6	5.6	17.6	23.6	—	—	—	—	3.6 (1.1)	3.6 (1.1)	3.6 (1.1)	15.6 (13.1)	21.6 (19.1)	—	—	—	—	4.5						
13-/22-MXS8	7.6	10.9	5.9	6.9	14.9	22.9	47.9	—	—	—	—	8.9 (6.4)	3.9 (1.4)	4.9 (2.4)	12.9 (10.4)	20.9 (18.4)	45.9 (43.4)	—	—	—	5					
13-/22-MXS12	11.6	28.4	18.4	8.4	10.4	20.4	41.4	70.4	—	—	—	—	26.4 (23.9)	16.4 (13.9)	6.4 (3.9)	8.4 (5.9)	18.4 (15.9)	39.4 (36.9)	68.4 (65.9)	—	—	—	6			
13-/22-MXS16	16.3	28.7	18.7	8.7	8.7	13.7	38.7	61.7	86.7	—	—	—	—	26.7 (24.2)	16.7 (14.2)	6.7 (4.2)	6.7 (4.2)	11.7 (9.2)	36.7 (34.2)	59.7 (57.2)	84.7 (82.2)	—	—	7		
13-/22-MXS20	18.9	32.6	22.6	12.6	12.6	17.6	31.6	59.6	88.6	115.6	—	—	—	—	30.6 (28.1)	20.6 (18.1)	10.6 (8.1)	10.6 (8.1)	15.6 (13.1)	39.6 (37.1)	57.6 (55.1)	86.6 (84.1)	113.6 (111.1)	—	—	8
13-/22-MXS25	23	37.5	27.5	17.5	17.5	20.5	36.5	52.5	85.5	100.5	—	—	—	—	35.5 (33)	25.5 (23)	15.5 (13)	15.5 (13)	18.5 (16)	34.5 (32)	50.5 (48)	83.5 (81)	98.5 (96)	—	—	8

(): denotes D-A93.

Solid state auto switch: D-M9B, D-M9N

Model	A	B										E										Auto switch operating range				
		Stroke										Stroke														
		10	20	30	40	50	75	100	125	150	10	20	30	40	50	75	100	125	150							
13-/22-MXS6	10	9.6	9.6	9.6	21.6	27.6	—	—	—	—	-0.4	-0.4	-0.4	11.6	17.5	—	—	—	—	1.5						
13-/22-MXS8	11.6	14.9	9.9	10.9	18.9	26.9	51.9	—	—	—	—	4.9	-0.1	0.9	8.9	16.9	41.9	—	—	—	1.5					
13-/22-MXS12	15.6	32.4	22.4	12.4	14.4	24.4	45.4	74.4	—	—	—	—	22.4	12.4	2.4	4.4	14.4	35.4	64.4	—	—	2.5				
13-/22-MXS16	20.3	32.7	22.7	12.7	12.7	17.7	42.7	65.7	90.7	—	—	—	—	22.7	12.7	2.7	2.7	7.7	32.7	55.7	80.7	—	—	3		
13-/22-MXS20	22.9	36.6	26.6	16.6	16.6	21.6	35.6	63.6	92.6	119.6	—	—	—	—	26.6	16.6	6.6	6.6	11.6	25.6	53.6	82.6	109.6	—	—	3
13-/22-MXS25	27	41.5	31.5	21.5	21.5	24.5	40.5	56.5	89.5	104.5	—	—	—	—	31.5	21.5	11.5	11.5	14.5	30.5	46.5	79.5	94.5	—	—	3

Dimensions: 13-22-MXS6

Basic

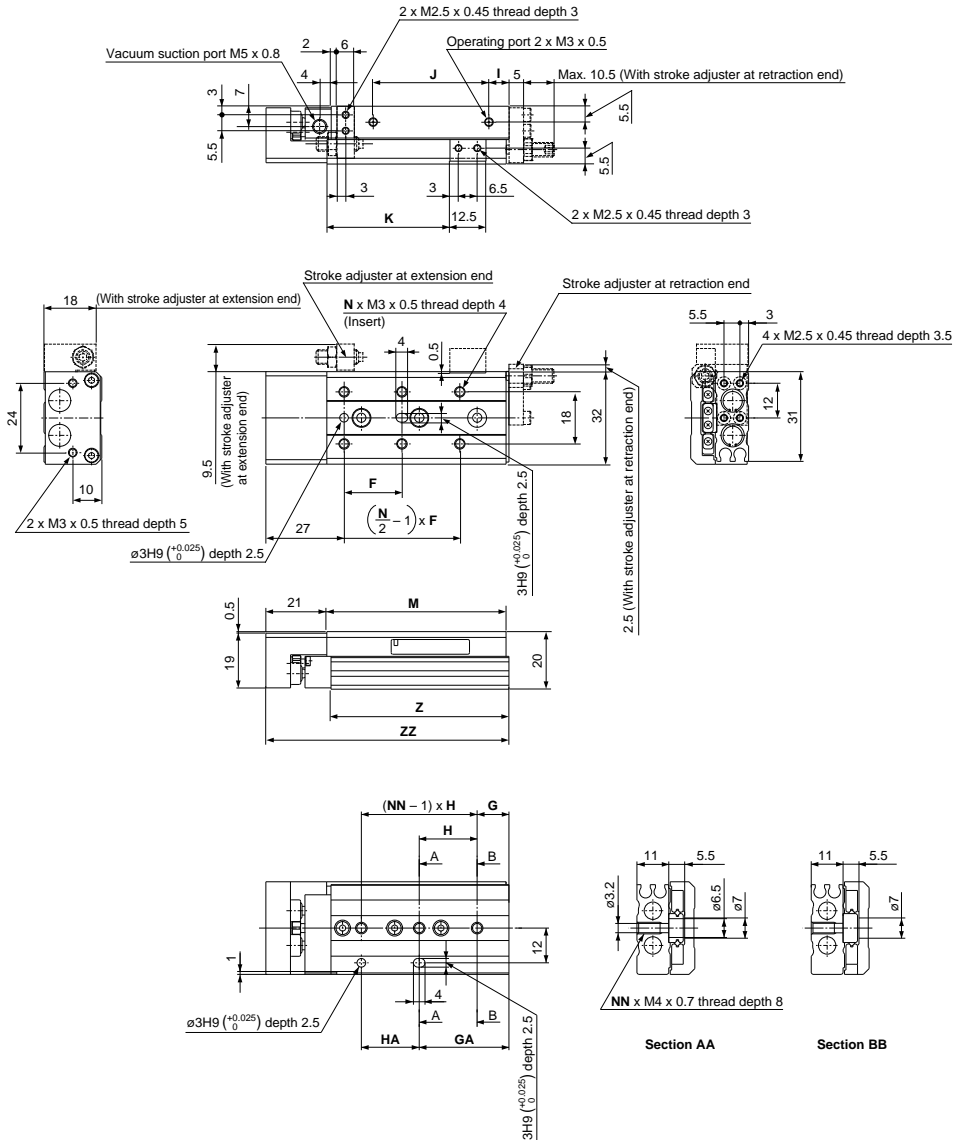

Model	F	N	G	H	NN	GA	HA	I	J	K	M	Z	ZZ
13-22-MXS6-10	20	4	6	25	2	11	20	10	17	22.5	42	41.5	64
13-22-MXS6-20	30	4	6	35	2	21	20	10	27	32.5	52	51.5	74
13-22-MXS6-30	20	6	11	20	3	31	20	7	40	42.5	62	61.5	84
13-22-MXS6-40	28	6	13	30	3	43	30	19	50	52.5	84	83.5	106
13-22-MXS6-50	38	6	17	24	4	41	48	25	60	62.5	100	99.5	122

(mm)

Directional Control Valves
Air Cylinders
Rotary Actuators
Air Grippers
Air Preparation Equipment
Modular F. R.
Pressure Control Equipment
Fittings & Tubing
Flow Control Equipment
Pressure Switches/ Pressure Sensors

Air Slide Table ¹³⁻₂₂₋**MXS**

Dimensions: ¹³⁻₂₂₋**MXS6**

Axial piping (ø6): ¹³⁻₂₂₋MXS6-□□P

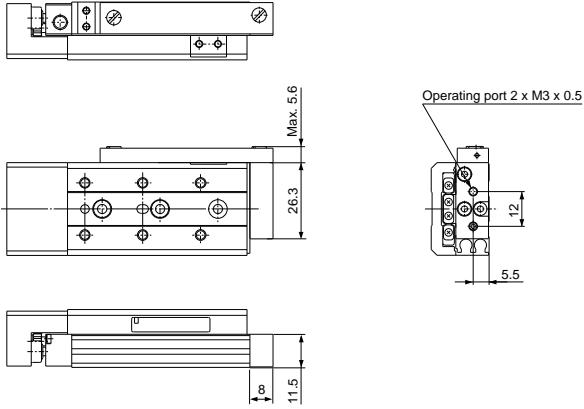

* Other dimensions are the same as those of basic type.

Dimensions: 13-22-MXS8

Basic

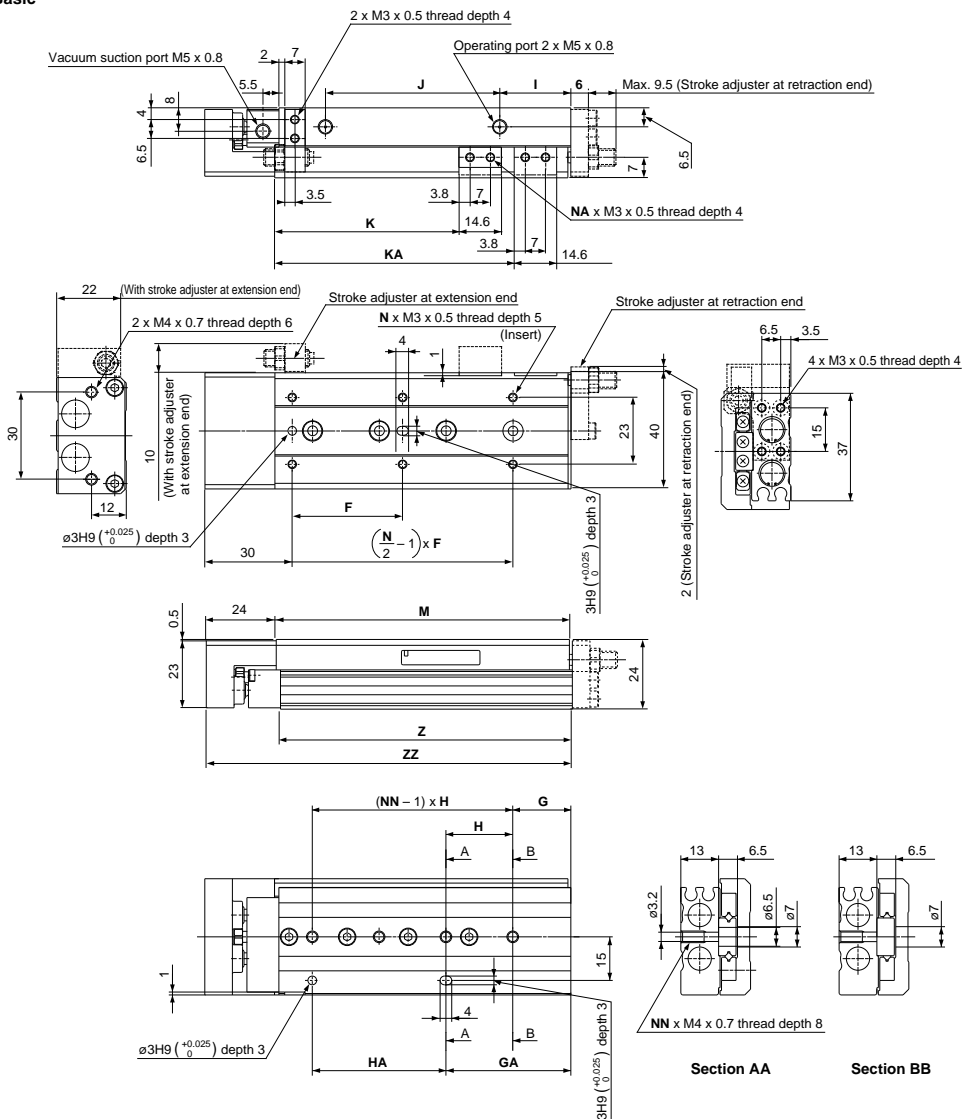

(mm)

Model	F	N	G	H	NN	GA	HA	I	J	K	KA	NA	M	Z	ZZ
13-/22-MXS8-10	25	4	9	28	2	17	20	13	19.5	23.5	—	2	49	48.5	74
13-/22-MXS8-20	25	4	12	30	2	12	30	8.5	29	33.5	—	2	54	53.5	79
13-/22-MXS8-30	40	4	13	20	3	33	20	9.5	39	43.5	—	2	65	64.5	90
13-/22-MXS8-40	50	4	15	28	3	43	28	10.5	56	53.5	—	2	83	82.5	108
13-/22-MXS8-50	38	6	20	23	4	43	46	24.5	60	63.5	82.5	4	101	100.5	126
13-/22-MXS8-75	50	6	27	28	5	83	56	38.5	96	88.5	132.5	4	151	150.5	176

Dimensions: 13-22-MXS8

Axial piping (ø8): 13-22-MXS8-□□P

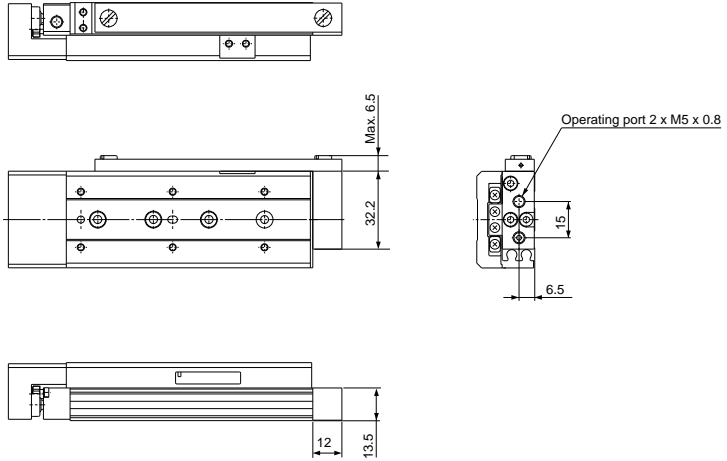

* Other dimensions are the same as those of basic type.

Directional Control Valves

Air Cylinders

Rotary Actuators

Air Grippers

Air Preparation Equipment

Modular F. R.

Pressure Control Equipment

Fittings & Tubing

Flow Control Equipment

Pressure Switches/ Pressure Sensors

Dimensions: 13-22-MXS12

Basic

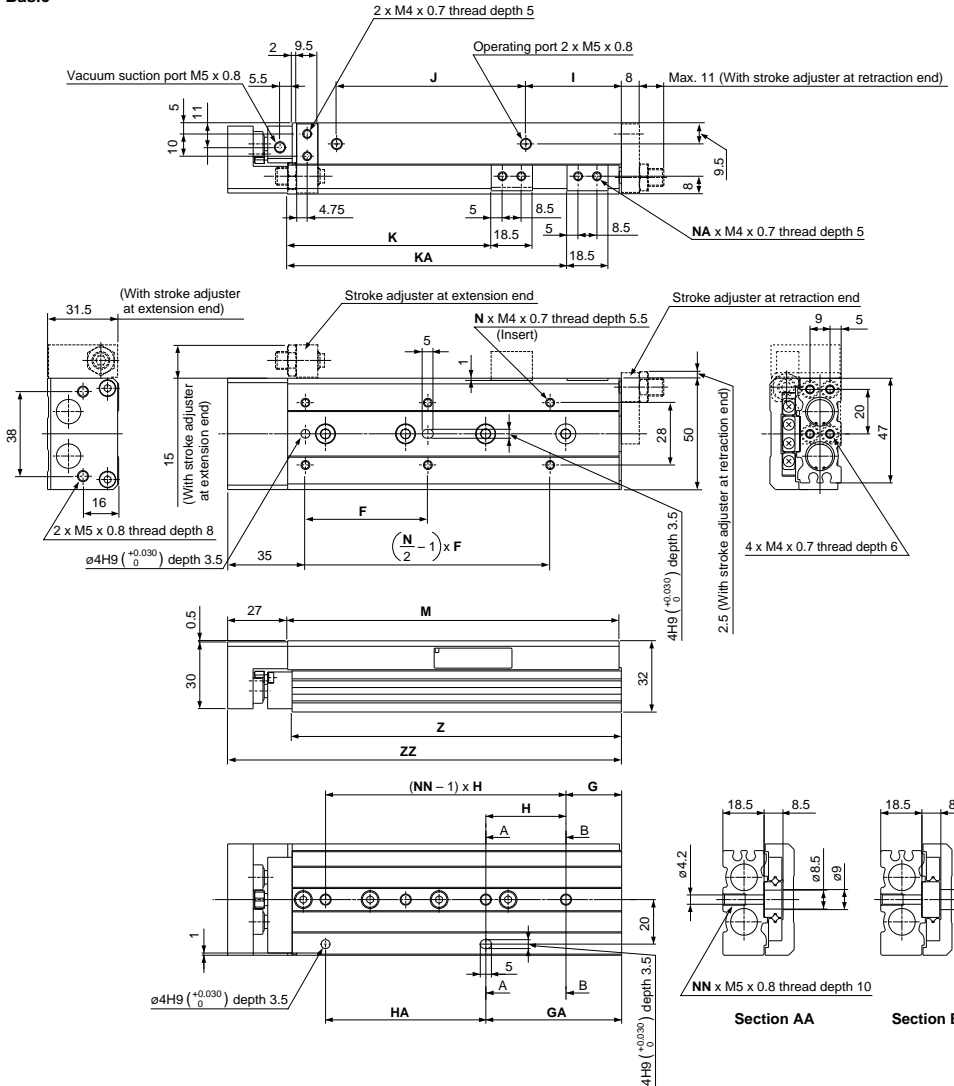

Model	F	N	G	H	NN	GA	HA	I	J	K	KA	NA	M	Z	ZZ
13-/22-MXS12-10	35	4	15	40	2	15	40	10	40	26.5	—	2	71	70	99
13-/22-MXS12-20	35	4	15	40	2	15	40	10	40	36.5	—	2	71	70	99
13-/22-MXS12-30	35	4	15	40	2	15	40	10	40	46.5	—	2	71	70	99
13-/22-MXS12-40	50	4	17	25	3	42	25	10	52	56.5	—	2	83	82	111
13-/22-MXS12-50	35	6	15	36	3	51	36	22	60	66.5	—	2	103	102	131
13-/22-MXS12-75	55	6	25	36	4	61	72	43	85	91.5	125.5	4	149	148	177
13-/22-MXS12-100	65	6	35	38	5	111	76	52	130	116.5	179.5	4	203	202	231

(mm)

- Directional Control Valves
- Air Cylinders
- Rotary Actuators
- Air Grippers
- Air Preparation Equipment
- Modular F. R.
- Pressure Control Equipment
- Fittings & Tubing
- Flow Control Equipment
- Pressure Switches/ Pressure Sensors

Air Slide Table ¹³⁻/₂₂₋MXS

Dimensions: ¹³⁻/₂₂₋MXS12

Axial piping (ø12) ¹³⁻/₂₂₋MXS12-□□P

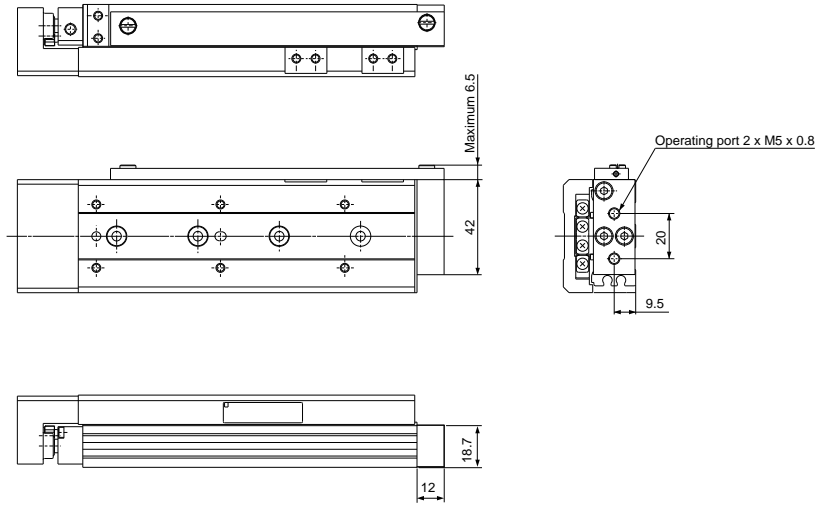

* Other dimensions are the same as those of basic type.

Dimensions: 13-22-MXS12L / Symmetric Type

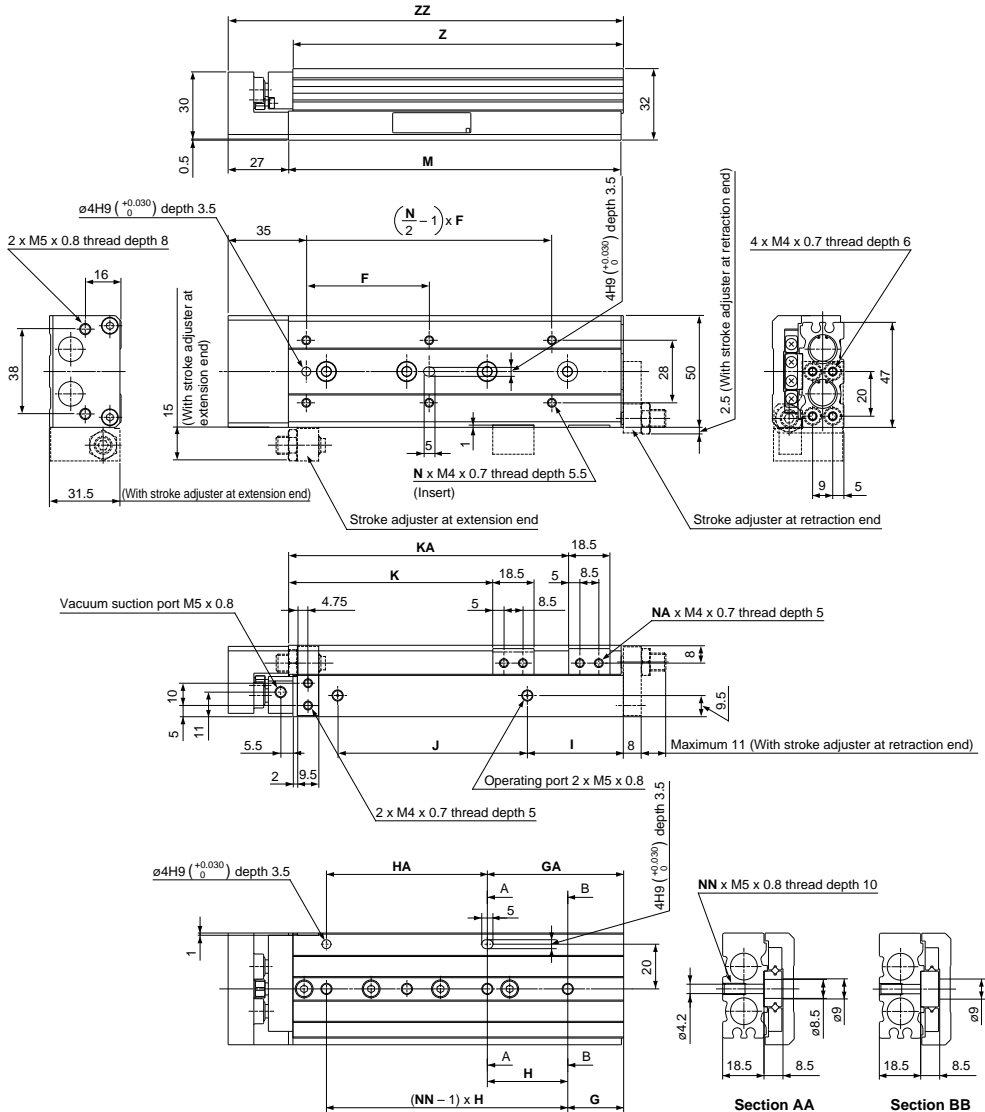

Model	F	N	G	H	NN	GA	HA	I	J	K	KA	NA	M	Z	ZZ
13-/22-MXS12L-10	35	4	15	40	2	15	40	10	40	26.5	—	2	71	70	99
13-/22-MXS12L-20	35	4	15	40	2	15	40	10	40	36.5	—	2	71	70	99
13-/22-MXS12L-30	35	4	15	40	2	15	40	10	40	46.5	—	2	71	70	99
13-/22-MXS12L-40	50	4	17	25	3	42	25	10	52	56.5	—	2	83	82	111
13-/22-MXS12L-50	35	6	15	36	3	51	36	22	60	66.5	—	2	103	102	131
13-/22-MXS12L-75	55	6	25	36	4	61	72	43	85	91.5	125.5	4	149	148	177
13-/22-MXS12L-100	65	6	35	38	5	111	76	52	130	116.5	179.5	4	203	202	231

(mm)

- Directional Control Valves
- Air Cylinders
- Rotary Actuators
- Air Grippers
- Air Preparation Equipment
- Modular F. R.
- Pressure Control Equipment
- Fittings & Tubing
- Flow Control Equipment
- Pressure Switches/ Pressure Sensors

Dimensions: 13-22-MXS16

Basic

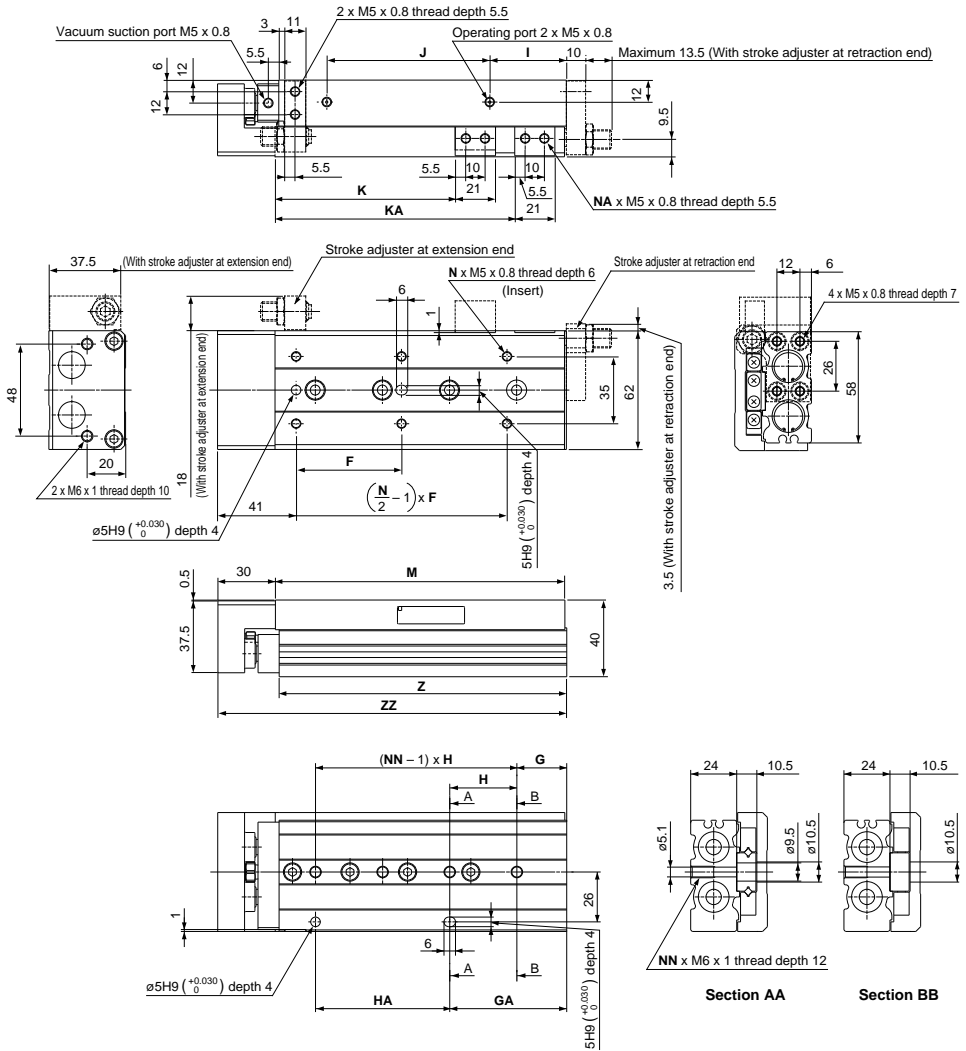

Model	F	N	G	H	NN	GA	HA	I	J	K	KA	NA	M	Z	ZZ
13-22-MXS16-10	35	4	16	40	2	16	40	10	40	29	—	2	76	75	107
13-22-MXS16-20	35	4	16	40	2	16	40	10	40	39	—	2	76	75	107
13-22-MXS16-30	35	4	16	40	2	16	40	10	40	49	—	2	76	75	107
13-22-MXS16-40	40	4	16	50	2	16	50	10	50	59	—	2	86	85	117
13-22-MXS16-50	30	6	21	30	3	51	30	15	60	69	—	2	101	100	132
13-22-MXS16-75	55	6	26	35	4	61	70	40	85	94	125	4	151	150	182
13-22-MXS16-100	65	6	39	35	5	109	70	55	118	119	173	4	199	198	230
13-22-MXS16-125	70	8	19	35	7	159	70	68	155	144	223	4	249	248	280

Dimensions: ¹³⁻₂₂₋MXS16

Axial piping (ø16) ¹³⁻₂₂₋MXS16-□□P

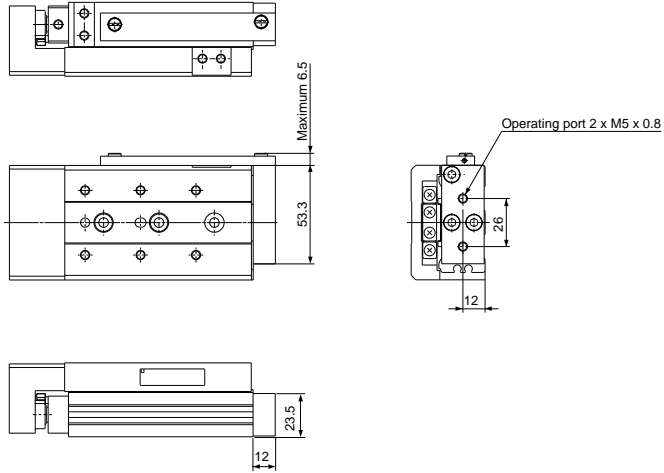

* Other dimensions are the same as those of basic type.

Directional Control Valves

Air Cylinders

Rotary Actuators

Air Grippers

Air Preparation Equipment

Modular F. R.

Pressure Control Equipment

Fittings & Tubing

Flow Control Equipment

Pressure Switches/ Pressure Sensors

Dimensions: **13-22-MXS16L / Symmetric Type**

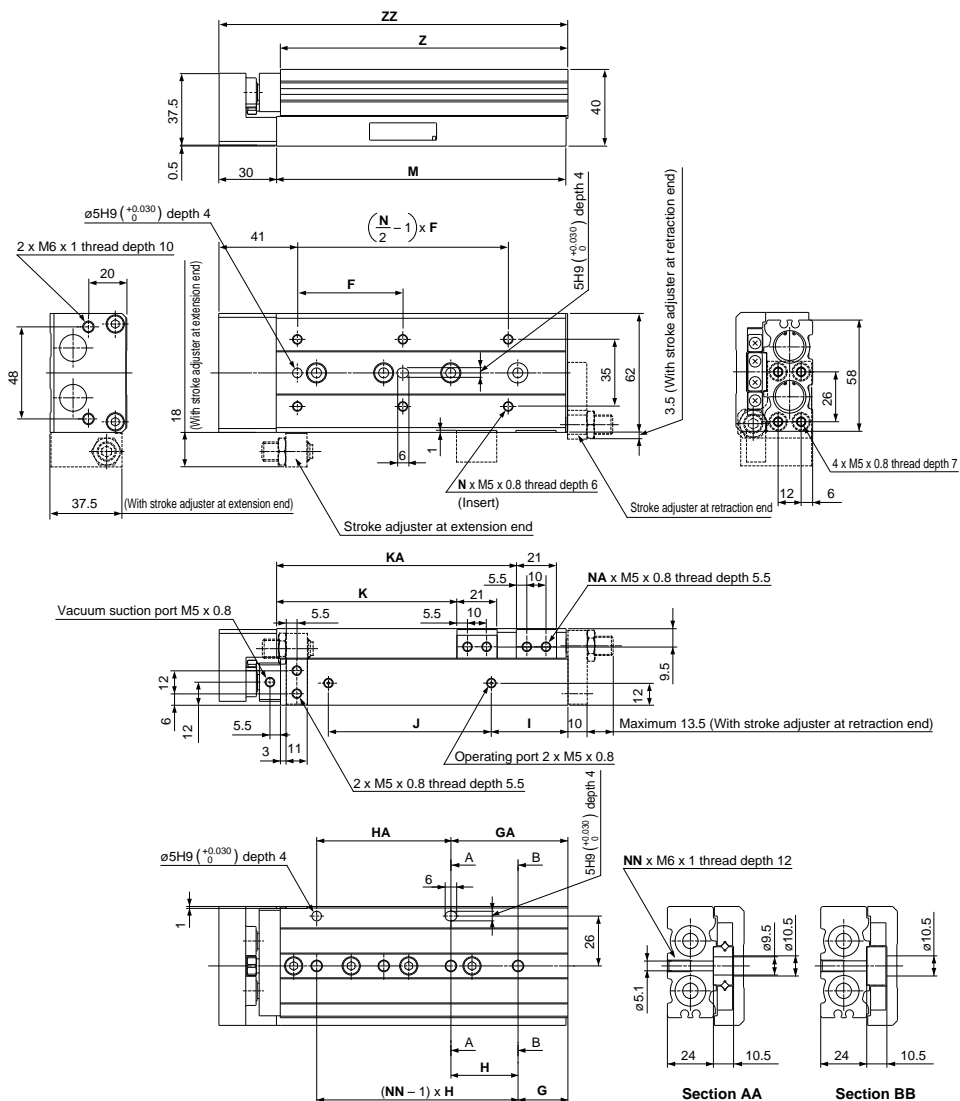

Model	F	N	G	H	NN	GA	HA	I	J	K	KA	NA	M	Z	ZZ
13-/22-MXS16L-10	35	4	16	40	2	16	40	10	40	29	—	2	76	75	107
13-/22-MXS16L-20	35	4	16	40	2	16	40	10	40	39	—	2	76	75	107
13-/22-MXS16L-30	35	4	16	40	2	16	40	10	40	49	—	2	76	75	107
13-/22-MXS16L-40	40	4	16	50	2	16	50	10	50	59	—	2	86	85	117
13-/22-MXS16L-50	30	6	21	30	3	51	30	15	60	69	—	2	101	100	132
13-/22-MXS16L-75	55	6	26	35	4	61	70	40	85	94	125	4	151	150	182
13-/22-MXS16L-100	65	6	39	35	5	109	70	55	118	119	173	4	199	198	230
13-/22-MXS16L-125	70	8	19	35	7	159	70	68	155	144	223	4	249	248	280

Dimensions: 13-22-MXS20

Basic

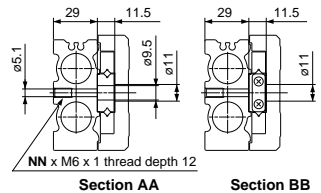
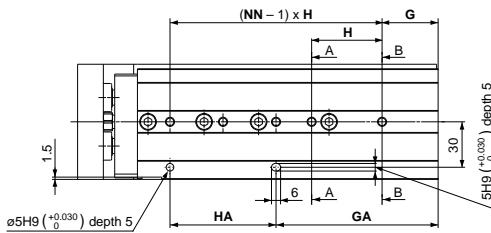
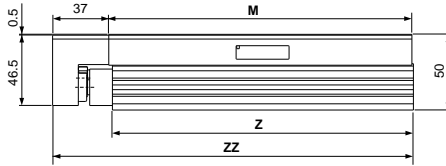
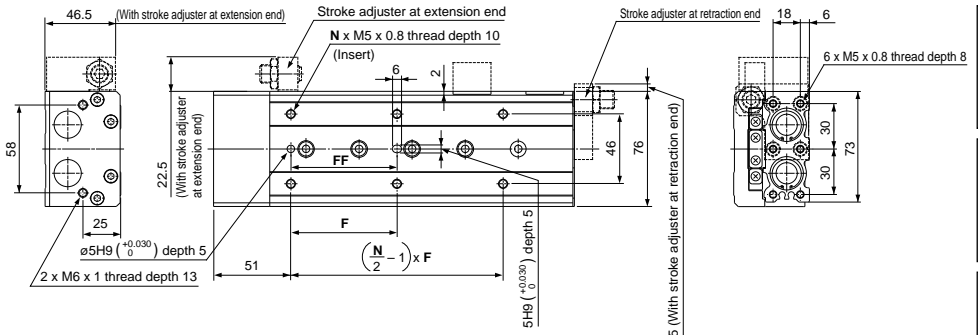
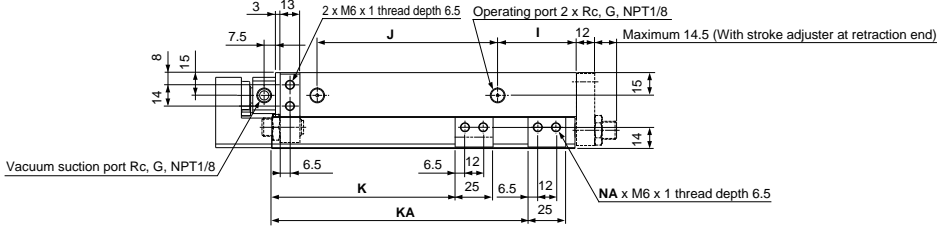

Model	F	FF	N	G	H	NN	GA	HA	I	J	K	KA	NA	M	Z	ZZ
13-/22-MXS20-10	50	40	4	15	45	2	25	35	10	44	31	—	2	83	81.5	121
13-/22-MXS20-20	50	40	4	15	45	2	25	35	10	44	41	—	2	83	81.5	121
13-/22-MXS20-30	50	40	4	15	45	2	25	35	10	44	51	—	2	83	81.5	121
13-/22-MXS20-40	60	50	4	15	55	2	35	35	10	54	61	—	2	93	91.5	131
13-/22-MXS20-50	35	35	6	15	35	3	50	35	10	69	71	—	2	108	106.5	146
13-/22-MXS20-75	60	60	6	19	35	4	54	70	10	108	96	—	2	147	145.5	185
13-/22-MXS20-100	70	70	6	37	35	5	107	70	58	113	121	169	4	200	198.5	238
13-/22-MXS20-125	70	70	8	41	38	6	155	76	70	155	146	223	4	254	252.5	292
13-/22-MXS20-150	80	80	8	19	44	7	195	88	87	190	171	275	4	306	304.5	344

Directional Control Valves
Air Cylinders
Rotary Actuators
Air Grippers
Air Preparation Equipment
Modular F. R.
Pressure Control Equipment
Fittings & Tubing
Flow Control Equipment
Pressure Switches/ Pressure Sensors

Air Slide Table ¹³⁻₂₂₋MXS

Dimensions: ¹³⁻₂₂₋MXS 20

Axial piping (ø20) ¹³⁻₂₂₋MXS20-□□P

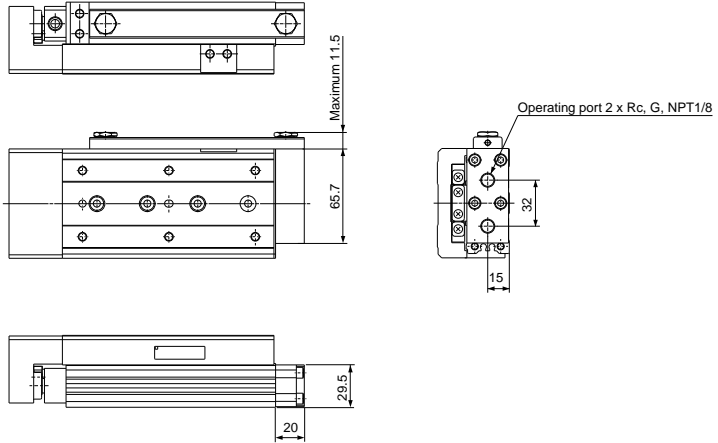

* Other dimensions are the same as those of basic type.

Dimensions: 13-22-MXS25

Basic

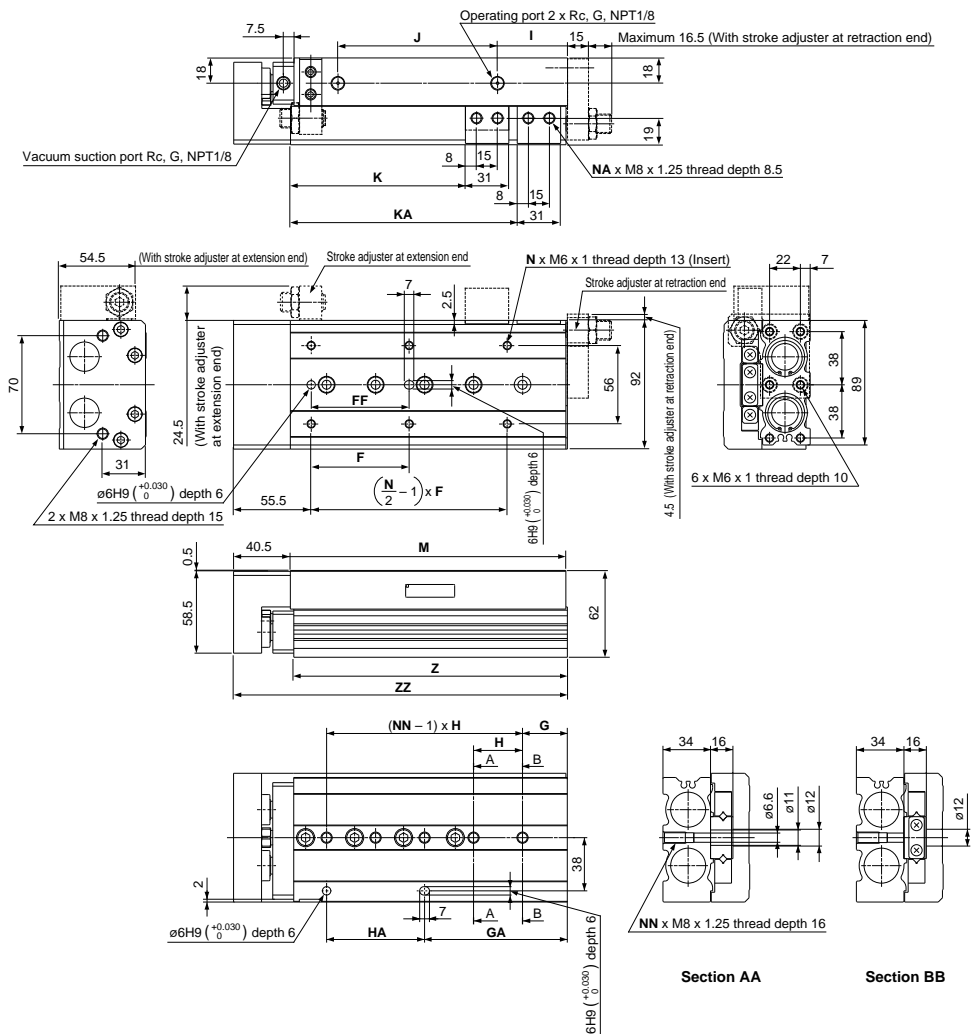

Model	F	FF	N	G	H	NN	GA	HA	I	J	K	KA	NA	M	Z	ZZ
13-/22-MXS25-10	50	40	4	22	45	2	22	45	12	47	35	—	2	92	90.5	133.5
13-/22-MXS25-20	50	40	4	22	45	2	22	45	12	47	45	—	2	92	90.5	133.5
13-/22-MXS25-30	50	40	4	22	45	2	22	45	12	47	55	—	2	92	90.5	133.5
13-/22-MXS25-40	60	50	4	22	55	2	22	55	12	57	65	—	2	102	100.5	143.5
13-/22-MXS25-50	35	35	6	20	35	3	55	35	12	70	75	—	2	115	113.5	156.5
13-/22-MXS25-75	60	60	6	26	35	4	61	70	33	90	100	—	2	156	154.5	197.5
13-/22-MXS25-100	70	70	6	32	35	5	102	70	50	114	125	162	4	197	195.5	238.5
13-/22-MXS25-125	75	75	8	40	38	6	154	76	67	155	150	218	4	255	253.5	296.5
13-/22-MXS25-150	80	80	8	30	40	7	190	80	82	180	175	258	4	295	293.5	336.5

Dimensions: 13-22-MXS25

Axial piping (ø25) 13-22-MXS25-□□P

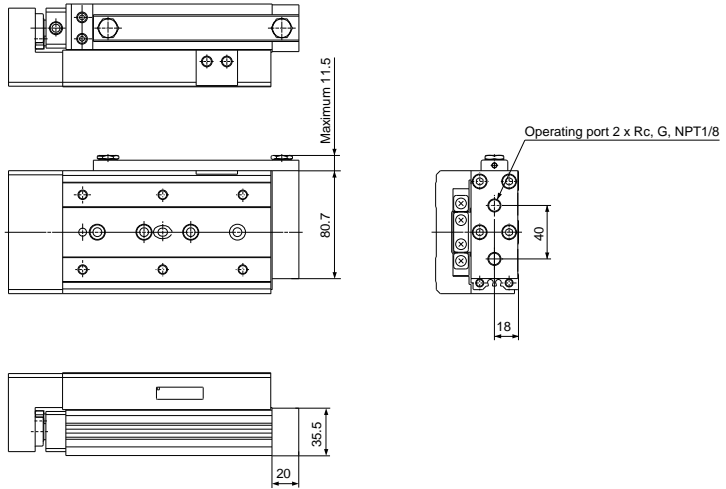

* Other dimensions are the same as those of basic type.

Directional Control Valves

Air Cylinders

Rotary Actuators

Air Grippers

Air Preparation Equipment

Modular F. R.

Pressure Control Equipment

Fittings & Tubing

Flow Control Equipment

Pressure Switches/ Pressure Sensors

Dimensions: **13-22-MXS25L / Symmetric Type**

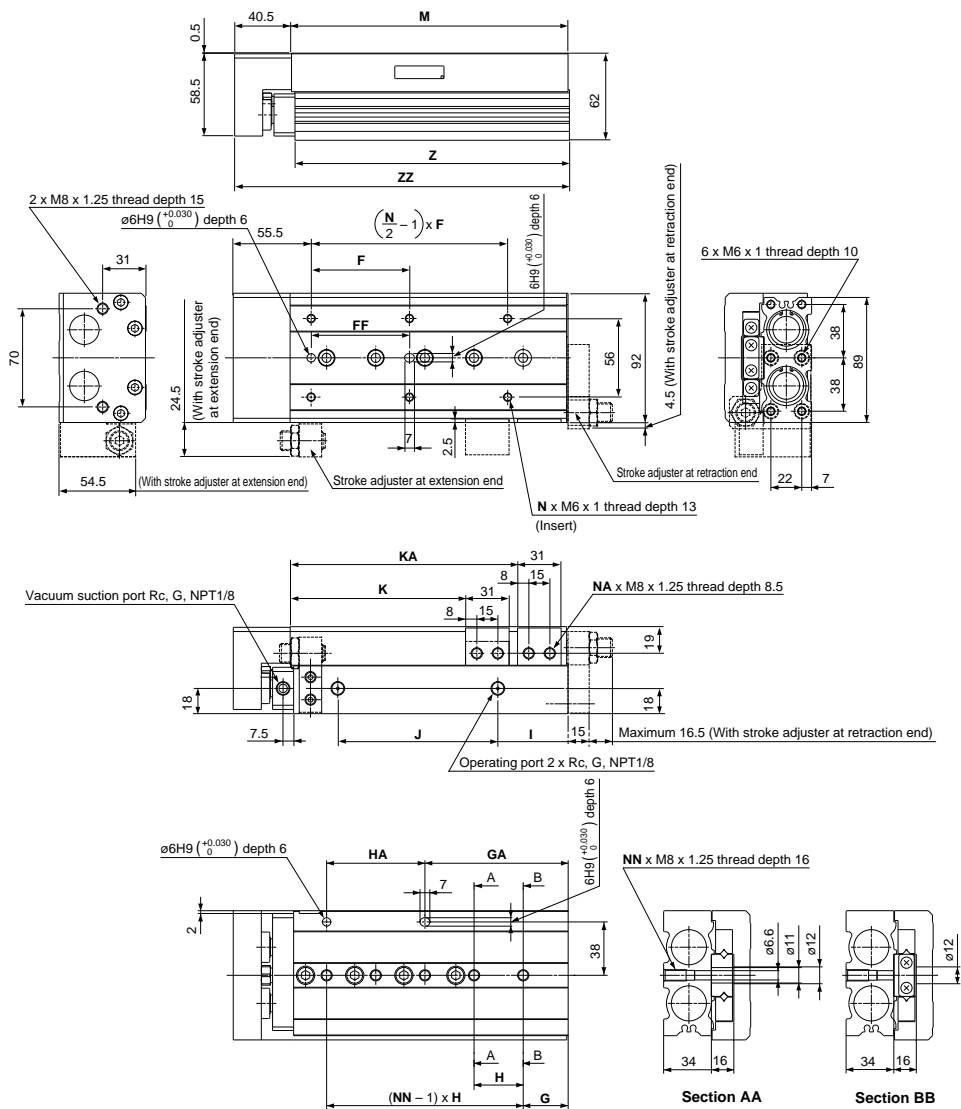

Model	F	FF	N	G	H	NN	GA	HA	I	J	K	KA	NA	M	Z	ZZ
13-/22-MXS25L-10	50	40	4	22	45	2	22	45	12	47	35	—	2	92	90.5	133.5
13-/22-MXS25L-20	50	40	4	22	45	2	22	45	12	47	45	—	2	92	90.5	133.5
13-/22-MXS25L-30	50	40	4	22	45	2	22	45	12	47	55	—	2	92	90.5	133.5
13-/22-MXS25L-40	60	50	4	22	55	2	22	55	12	57	65	—	2	102	100.5	143.5
13-/22-MXS25L-50	35	35	6	20	35	3	55	35	12	70	75	—	2	115	113.5	156.5
13-/22-MXS25L-75	60	60	6	26	35	4	61	70	33	90	100	—	2	156	154.5	197.5
13-/22-MXS25L-100	70	70	6	32	35	5	102	70	50	114	125	162	4	197	195.5	238.5
13-/22-MXS25L-125	75	75	8	40	38	6	154	76	67	155	150	218	4	255	253.5	296.5
13-/22-MXS25L-150	80	80	8	30	40	7	190	80	82	180	175	258	4	295	293.5	336.5

Made to Order

Dust cover and dust plug made by fluororubber -X52

13-MXS Standard model no. -X52

Material used for the dust cover and dust plug has been changed from silicone rubber to fluororubber.

Note 1) Dimensions are the same as those of standard type.

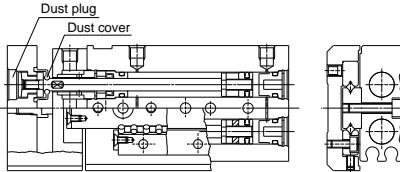

⚠ Specific Product Precautions

Be sure to read this before handling.

Handling

⚠ Caution

Plug the port after removing the stroke adjuster at the extension end.

Otherwise particle generation may occur because the prepared hole of the mounting screw penetrates the body. Contact SMC for more information.

Cylinder bore size (mm)	25
-------------------------	----

Extension end stroke adjuster mounting screw
(Generates particles because it penetrates to the body.)

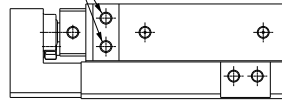

Stroke adjuster at extension end

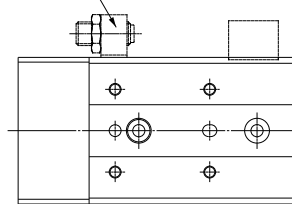

In case of without extension end adjuster type, port is plugged with a hexagon socket set screw at the time of shipment.

Hexagon socket set screw

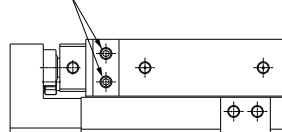

Directional Control Valves

Air Cylinders

Rotary Actuators

Air Grippers

Air Preparation Equipment

Modular F. R.

Pressure Control Equipment

Fittings & Tubing

Flow Control Equipment

Pressure Switches/ Pressure Sensors

Series 13-22-MXQ

ø6, ø8, ø12, ø16, ø20, ø25
Air Slide Table



How to Order

Clean series
13 Vacuum suction type (Special treatment on guide)

Copper, fluorine and silicone-free + Low particle generation
22 Vacuum suction type

Port thread type

Symbol	Type	Bore size
Nil	M thread	ø6 to ø16
	Rc	ø20, ø25
TN	NPT	ø20, ø25
TF	G	ø20, ø25

Symmetric type

Nil	Standard
L	Symmetric

Bore size/Stroke (mm)

	10, 20, 30, 40, 50
6	10, 20, 30, 40, 50
8	10, 20, 30, 40, 50, 75
12	10, 20, 30, 40, 50, 75, 100
16	10, 20, 30, 40, 50, 75, 100, 125
20	10, 20, 30, 40, 50, 75, 100, 125, 150
25	10, 20, 30, 40, 50, 75, 100, 125, 150

Adjuster option

Nil	Without adjuster
AS	Extension end adjuster
AT	Retraction end adjuster
A	Both ends adjuster
CS	Extension end metal stopper
CT	Retraction end metal stopper
C	Both ends metal stopper
ASCT	Extension end adjuster + Retraction end metal stopper
CSAT	Extension end metal stopper + Retraction end adjuster

Number of auto switches

Nil	2 pcs.
S	1 pc.
n	"n" pcs.

Auto switch

Nil	Without auto switch (Built-in magnet)
-----	---------------------------------------

* For the applicable auto switch model, refer to the table below.

Functional option

Nil	Standard
P (Note)	Axial piping

Note) The combination of axial piping and both ends adjusters or retraction end adjuster is not available.

Auto Switch Specifications (Refer to the WEB catalog for detailed specifications and auto switches not in the following table.)

Type	Special function	Electrical entry	Indicator light	Wiring (Output)	Load voltage			Auto switch model	Lead wire length (m) *				Applicable load	
					DC	AC	100 V		Electrical entry direction					
								In-line	0.5 (Nil)	1 (M)	3 (L)	5 (Z)		
Reed auto switch	—	Grommet	Yes	2-wire	24 V	12 V	12 V	A93	●	—	●	—	—	Relay, PLC
Solid state auto switch	—	Grommet	Yes	3-wire (NPN)	24 V	12 V	—	M9N	●	●	●	○	—	Relay, PLC
				2-wire				M9B	●	●	●	○	—	

* Lead wire length symbols: 0.5 m Nil (Example) M9N
1 m M (Example) M9NM
3 m L (Example) M9NL
5 m Z (Example) M9NZ

PLC: Programmable Logic Controller

Refer to page 889 for the applicable auto switch list.

Specifications

Bore size (mm)	6	8	12	16	20	25
Fluid	Air					
Action	Double acting					
Operating pressure	0.15 to 0.7 MPa					
Proof pressure	1.05 MPa					
Ambient and fluid temperature	-10 to 60°C (No freezing)					
Piston speed	50 to 300 mm/s (Adjuster option/Metal stopper: 50 to 200 mm/s)					
Cushion	Rubber bumper (Standard, Adjuster option/Rubber stopper) None (Adjuster option/Metal stopper)					
Lubrication	Non-lube					
Stroke length tolerance	+1 0 mm					
Grease	13-: Fluorine grease 22-: Lithium soap based grease					
Cleanliness class (ISO class)	Without adjuster	13-/22-: Class 5				
	Rubber stopper	13-/22-: Class 6				
	Metal stopper	13-/22-: Class 6				

Suction Flow Rate of Vacuum Suction Type (Reference values)

Bore size	Suction flow rate L/min (ANR)
6, 8, 12	1
16	2
20	3
25	5

Adjuster Option: Stroke Adjustment Range

Rubber stopper	Extension end (AS)	Stroke adjustment range 0 to 5 mm
	Retraction end (AT)	
	Both ends (A)	
Metal stopper	Extension end (CS)	Stroke adjustment range 0 to 5 mm
	Retraction end (CT)	
	Both ends (C)	

Proper Auto Switch Mounting Position (Detection at Stroke End)



Reed auto switch: D-A93

Model	A	B Stroke										E Stroke										Auto switch operating range
		10	20	30	40	50	75	100	125	150	10	20	30	40	50	75	100	125	150			
13-/22-MXQ6(L)	6	5.5	5.5	5.5	13.5	13.5	—	—	—	—	1	1	1	9	9	—	—	—	4.5			
13-/22-MXQ8(L)	7.5	8	8	12	16	31	32	—	—	—	3.5	3.5	7.5	11.5	26.5	27.5	—	—	5			
13-/22-MXQ12(L)	11.5	24.5	14.5	14.5	21.5	21.5	40.5	40.5	—	20	10	10	17	17	36	36	—	—	6			
13-/22-MXQ16(L)	16.5	30.5	20.5	20.5	26.5	26.5	33.5	51.5	51.5	—	26	16	16	22	29	47	47	—	7			
13-/22-MXQ20(L)	19	43.5	33.5	23.5	33.5	31.5	39.5	71.5	74.5	77.5	39	29	19	29	27	35	67	70	8			
13-/22-MXQ25(L)	22	52.5	42.5	32.5	32.5	46.5	46.5	60.5	88.5	88.5	48	38	28	28	42	42	56	84	9			

Solid state auto switch: D-M9B, D-M9N

Model	A	B Stroke										E Stroke										Auto switch operating range
		10	20	30	40	50	75	100	125	150	10	20	30	40	50	75	100	125	150			
13-/22-MXQ6(L)	10	9.5	9.5	9.5	17.5	17.5	—	—	—	—	-0.5	-0.5	-0.5	7.5	7.5	—	—	—	1.5			
13-/22-MXQ8(L)	11.5	12	12	16	20	35	36	—	—	—	2	2	6	10	25	26	—	—	1.5			
13-/22-MXQ12(L)	15.5	28.5	18.5	18.5	25.5	25.5	44.5	44.5	—	18.5	8.5	8.5	15.5	15.5	34.5	34.5	—	—	2.5			
13-/22-MXQ16(L)	20.5	34.5	24.5	24.5	24.5	30.5	37.5	55.5	55.5	—	24.5	14.5	14.5	14.5	20.5	27.5	45.5	45.5	—			
13-/22-MXQ20(L)	23	47.5	37.5	27.5	37.5	35.5	43.5	75.5	78.5	81.5	37.5	27.5	17.5	27.5	25.5	33.5	65.5	68.5	3			
13-/22-MXQ25(L)	27	56.5	46.5	36.5	36.5	50.5	50.5	64.5	92.5	92.5	46.5	36.5	26.5	26.5	40.5	40.5	54.5	82.5	3			

Dimensions: 13-22-MXQ6

Basic

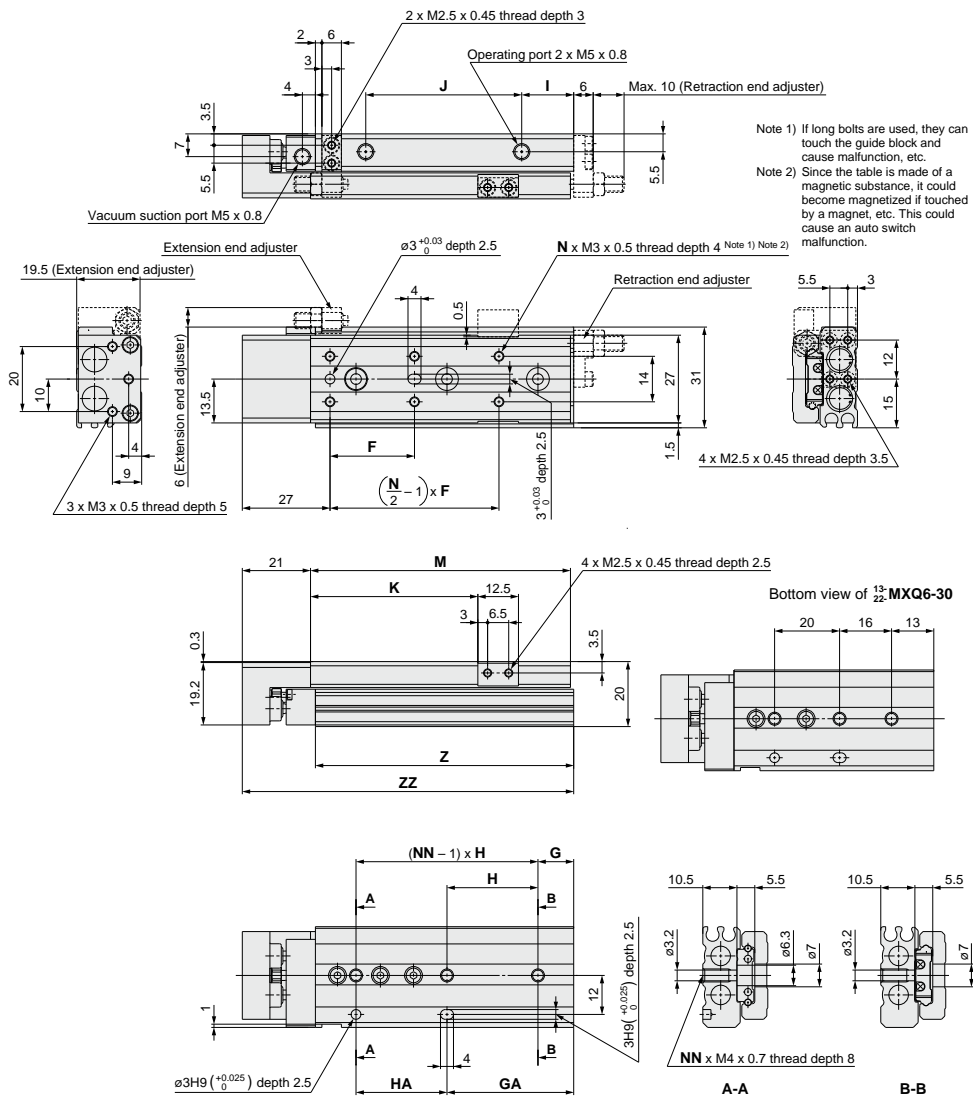

Model	F	N	G	H	NN	GA	HA	I	J	K	M	Z	ZZ
13-22-MXQ6-10	22	4	6	23	2	13	16	9	17	21.5	42	41.5	64
13-22-MXQ6-20	25	4	13	26	2	13	26	9	27	31.5	52	51.5	74
13-22-MXQ6-30	21	6	<small>(Note)</small>	<small>(Note)</small>	3	29	20	9	37	41.5	62	61.5	84
13-22-MXQ6-40	26	6	11	28	3	39	28	16	48	51.5	80	79.5	102
13-22-MXQ6-50	27	6	21	28	3	49	28	9	65	61.5	90	89.5	112

(mm)

Note) Refer to the bottom view of 13-22-MXQ6-30.

Dimensions: ¹³⁻₂₂₋MXQ6

Axial piping (ø6): ¹³⁻₂₂₋MXQ6-□□P

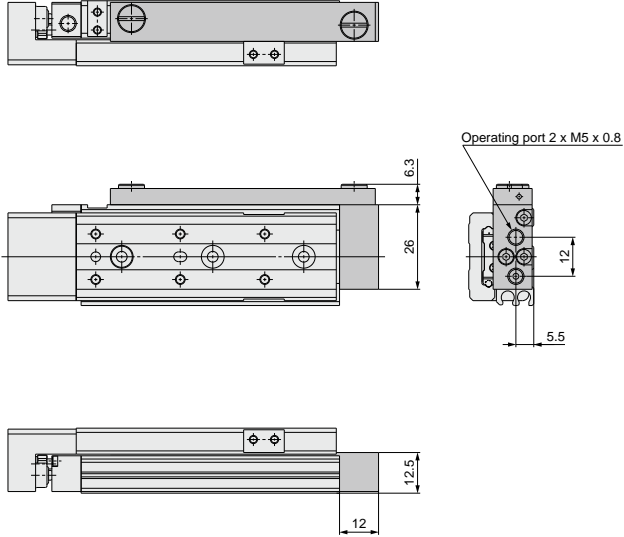

* Other dimensions are the same as basic type.

Directional
Control Valves

Air Cylinders

Rotary Actuators

Air Grippers

Air Preparation
Equipment

Modular F. R.

Pressure Control
Equipment

Fittings & Tubing

Flow Control
Equipment

Pressure Switches/
Pressure Sensors

Dimensions: 13-22-MXQ6L / Symmetric Type

Basic

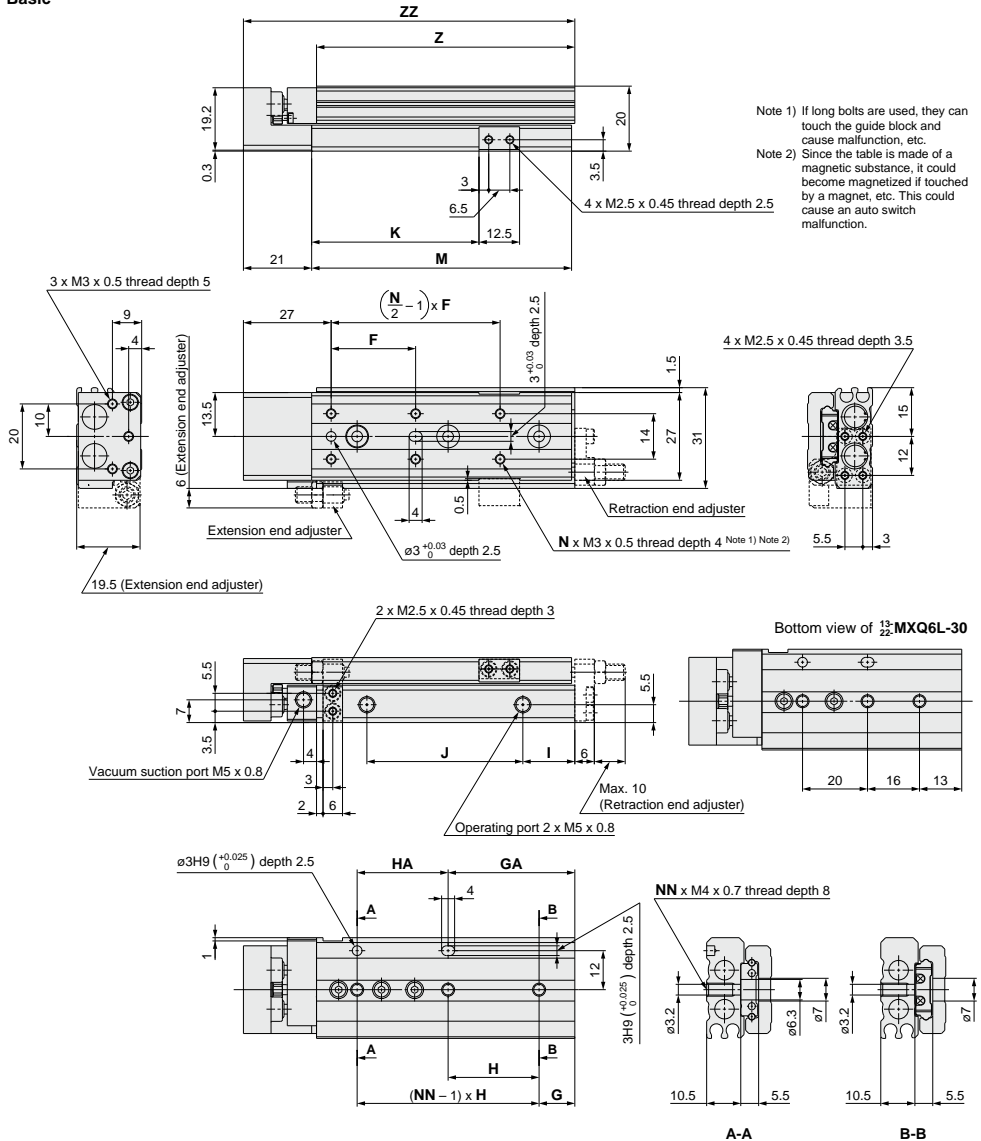

Model	F	N	G	H	NN	GA	HA	I	J	K	M	Z	ZZ
13-/22-MXQ6L-10	22	4	6	23	2	13	16	9	17	21.5	42	41.5	64
13-/22-MXQ6L-20	25	4	13	26	2	13	26	9	27	31.5	52	51.5	74
13-/22-MXQ6L-30	21	6	(Note)	(Note)	3	29	20	9	37	41.5	62	61.5	84
13-/22-MXQ6L-40	26	6	11	28	3	39	28	16	48	51.5	80	79.5	102
13-/22-MXQ6L-50	27	6	21	28	3	49	28	9	65	61.5	90	89.5	112

(Note) Refer to the bottom view of 13-22-MXQ6-30.

Dimensions: ¹³⁻/₂₂₋MXQ6L / Symmetric Type

Axial piping (ø6): ¹³⁻/₂₂₋MXQ6L-□□P

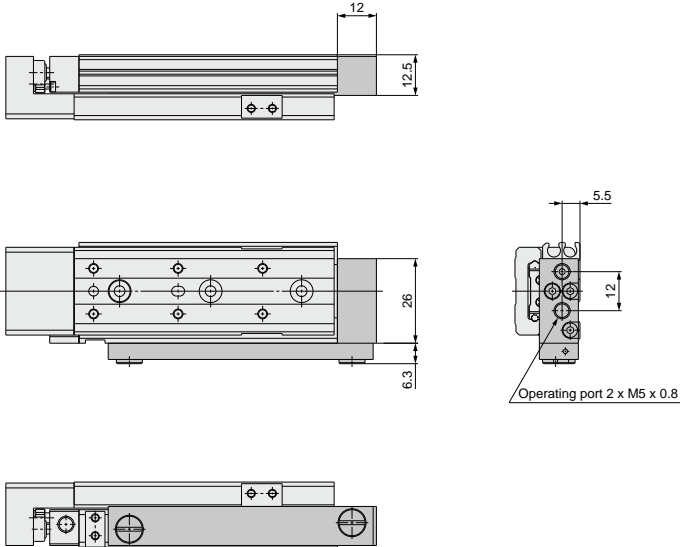

* Other dimensions are the same as basic type.

Directional
Control Valves

Air Cylinders

Rotary Actuators

Air Grippers

Air Preparation
Equipment

Modular F. R.

Pressure Control
Equipment

Fittings & Tubing

Flow Control
Equipment

Pressure Switches/
Pressure Sensors

Dimensions: ¹³⁻₂₂₋**MXQ8**

Axial piping (ø8): ¹³⁻₂₂₋**MXQ8-□□P**

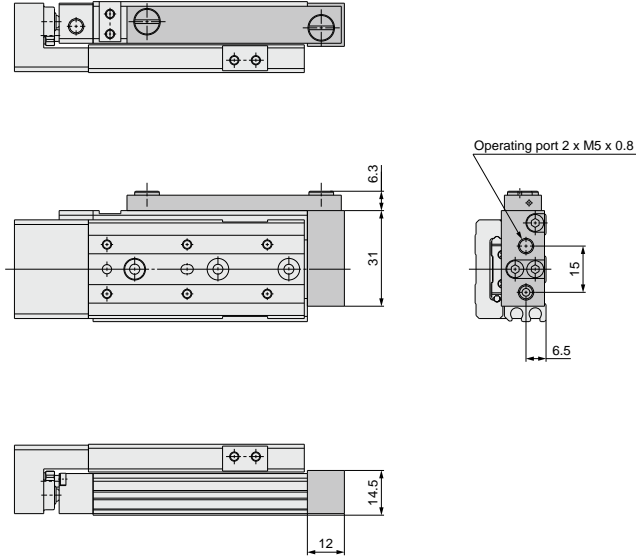

* Other dimensions are the same as basic type.

Directional Control Valves

Air Cylinders

Rotary Actuators

Air Grippers

Air Preparation Equipment

Modular F. R.

Pressure Control Equipment

Fittings & Tubing

Flow Control Equipment

Pressure Switches/ Pressure Sensors

Dimensions: **13-22-MXQ8L / Symmetric Type**

Basic

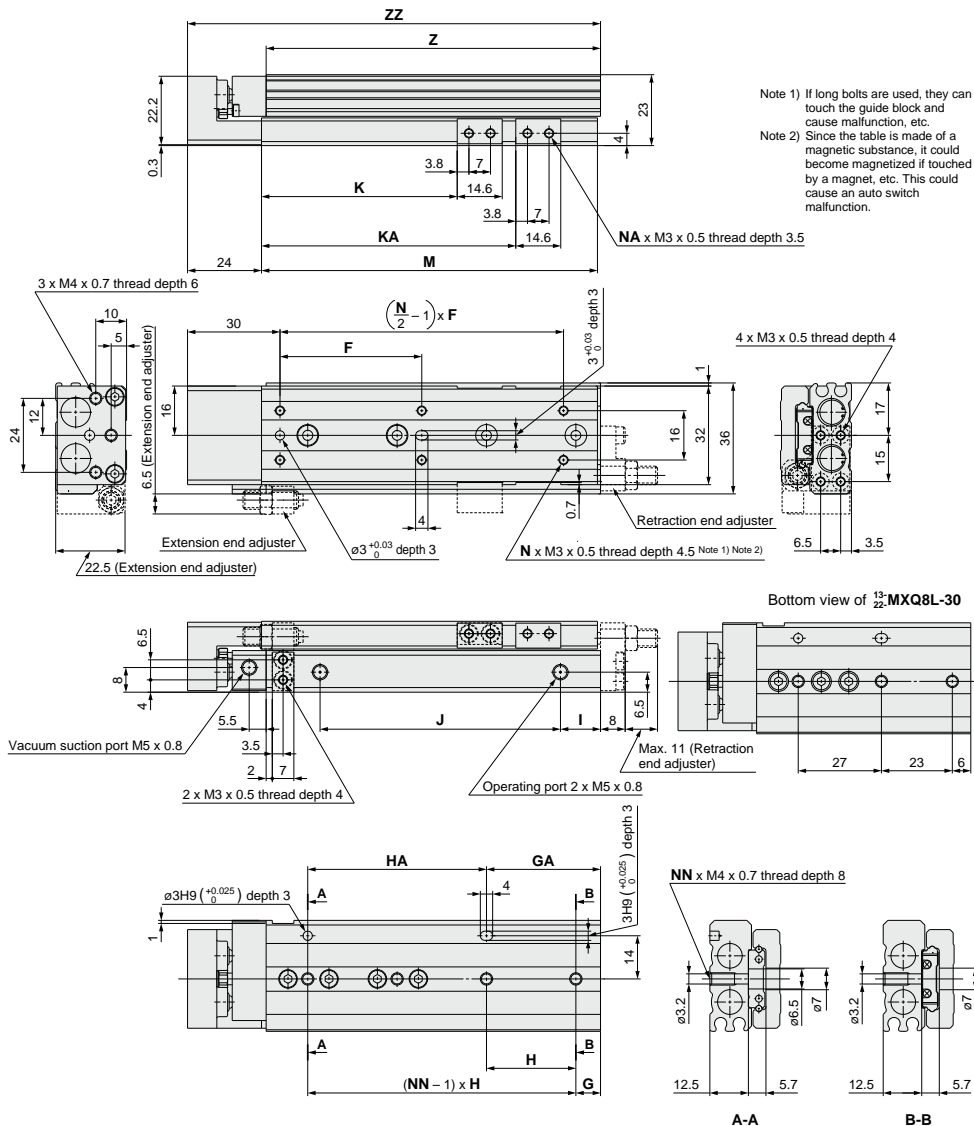

(mm)

Model	F	N	G	H	NN	GA	HA	I	J	K	KA	NA	M	Z	ZZ
13-22-MXQ8L-10	25	4	7	25	2	13	19	11	17	23.5	—	4	46	45.5	71
13-22-MXQ8L-20	25	4	14	28	2	14	28	10	28	33.5	—	4	56	55.5	81
13-22-MXQ8L-30	26	6	<small>(Note)</small>	<small>(Note)</small>	3	29	27	12	40	43.5	—	4	70	69.5	95
13-22-MXQ8L-40	32	6	8	31	3	39	31	14	52	53.5	—	4	84	83.5	109
13-22-MXQ8L-50	46	6	8	29	4	37	58	13	78	63.5	82.5	8	109	108.5	134
13-22-MXQ8L-75	50	6	31	30	4	61	60	12	105	88.5	112.5	8	135	134.5	160

Note) Refer to the bottom view of 13-22-MXQ8L-30.

Dimensions: ¹³⁻₂₂₋MXQ8L / Symmetric Type

Axial piping (ø8): ¹³⁻₂₂₋MXQ8L-□□P

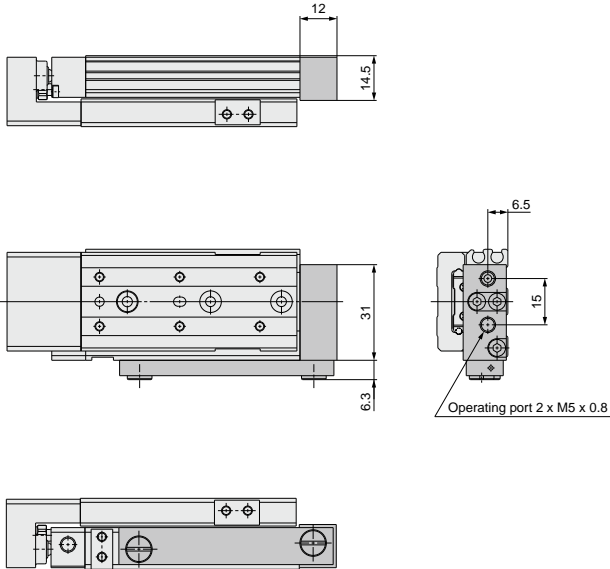

* Other dimensions are the same as basic type.

Directional
Control Valves

Air Cylinders

Rotary Actuators

Air Grippers

Air Preparation
Equipment

Modular F. R.

Pressure Control
Equipment

Fittings & Tubing

Flow Control
Equipment

Pressure Switches/
Pressure Sensors

Dimensions: **13-22-MXQ12**

Basic

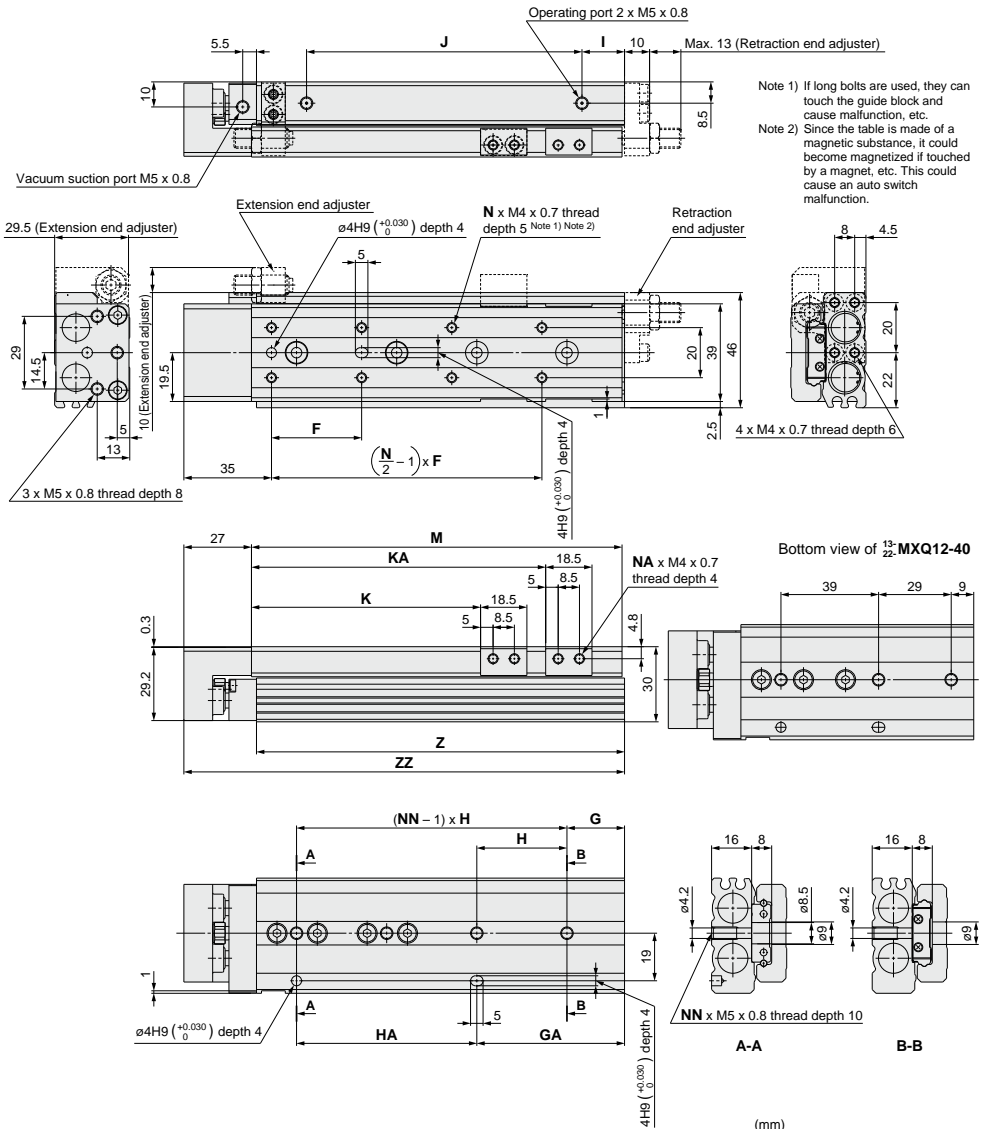

Note 1) If long bolts are used, they can touch the guide block and cause malfunction, etc.
 Note 2) Since the table is made of a magnetic substance, it could become magnetized if touched by a magnet, etc. This could cause an auto switch malfunction.

Model	F	N	G	H	NN	GA	HA	I	J	K	KA	NA	M	Z	ZZ
13-22-MXQ12- 10	28	4	18	32	2	18	32	12	34	26.5	—	4	67	66	95
13-22-MXQ12- 20	28	4	18	32	2	18	32	12	34	36.5	—	4	67	66	95
13-22-MXQ12- 30	38	4	20	40	2	20	40	14	42	46.5	—	4	77	76	105
13-22-MXQ12- 40	34	6	<small>None</small>	<small>None</small>	3	38	39	15	58	56.5	—	4	94	93	122
13-22-MXQ12- 50	34	6	9	39	3	48	39	13	70	66.5	—	4	104	103	132
13-22-MXQ12- 75	36	8	23	36	4	59	72	17	110	91.5	117.5	8	148	147	176
13-22-MXQ12-100	36	10	12	36	5	84	72	17	135	116.5	142.5	8	173	172	201

Note) Refer to the bottom view of **13-22-MXQ12-40**.

Dimensions: ¹³⁻₂₂₋MXQ12

Axial piping (ø12): ¹³⁻₂₂₋MXQ12-□□P

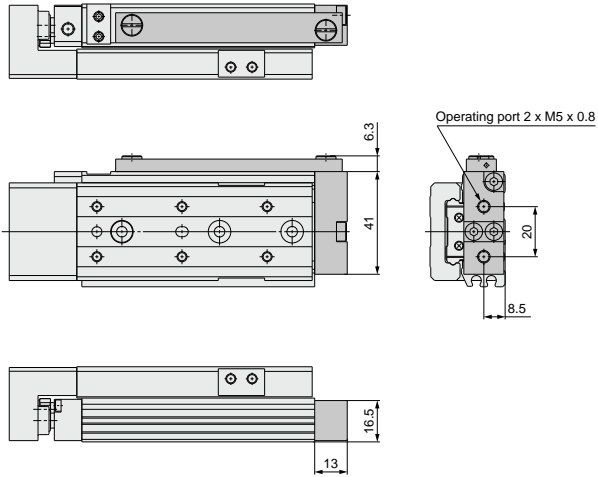

* Other dimensions are the same as basic type.

Directional Control Valves

Air Cylinders

Rotary Actuators

Air Grippers

Air Preparation Equipment

Modular F. R.

Pressure Control Equipment

Fittings & Tubing

Flow Control Equipment

Pressure Switches/ Pressure Sensors

Dimensions: **13-22-MXQ12L / Symmetric Type**

Basic

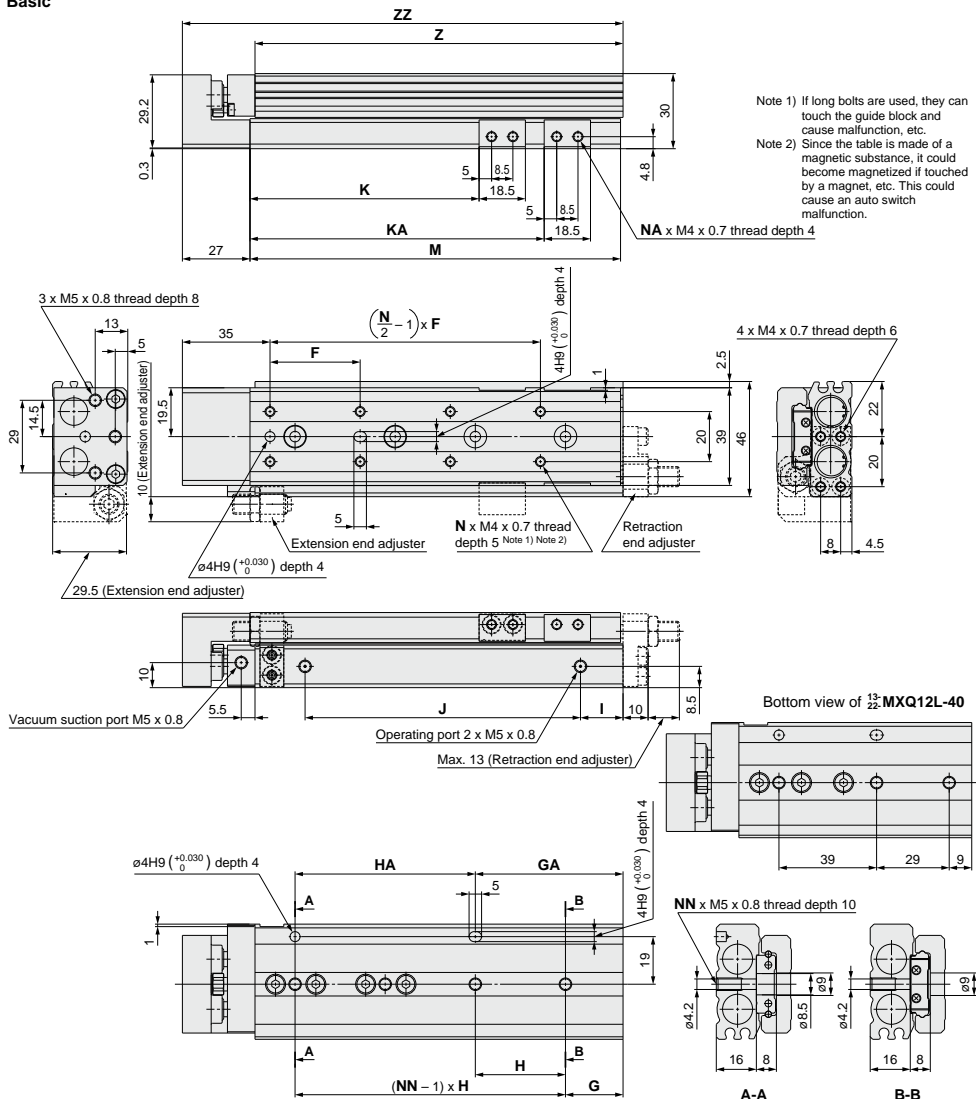

Note 1) If long bolts are used, they can touch the guide block and cause malfunction, etc.
 Note 2) Since the table is made of a magnetic substance, it could become magnetized if touched by a magnet, etc. This could cause an auto switch malfunction.

Model	F	N	G	H	NN	GA	HA	I	J	K	KA	NA	M	Z	ZZ
13-/22-MXQ12L- 10	28	4	18	32	2	18	32	12	34	26.5	—	4	67	66	95
13-/22-MXQ12L- 20	28	4	18	32	2	18	32	12	34	36.5	—	4	67	66	95
13-/22-MXQ12L- 30	38	4	20	40	2	20	40	14	42	46.5	—	4	77	76	105
13-/22-MXQ12L- 40	34	6	<small>(None)</small>	<small>(None)</small>	3	38	39	15	58	56.5	—	4	94	93	122
13-/22-MXQ12L- 50	34	6	9	39	3	48	39	13	70	66.5	—	4	104	103	132
13-/22-MXQ12L- 75	36	8	23	36	4	59	72	17	110	91.5	117.5	8	148	147	176
13-/22-MXQ12L-100	36	10	12	36	5	84	72	17	135	116.5	142.5	8	173	172	201

Note) Refer to the bottom view of 13-22-MXQ12L-40.

Dimensions: ¹³⁻/₂₂₋MXQ12L / Symmetric Type

Axial piping (ø12): ¹³⁻/₂₂₋MXQ12L-□□P

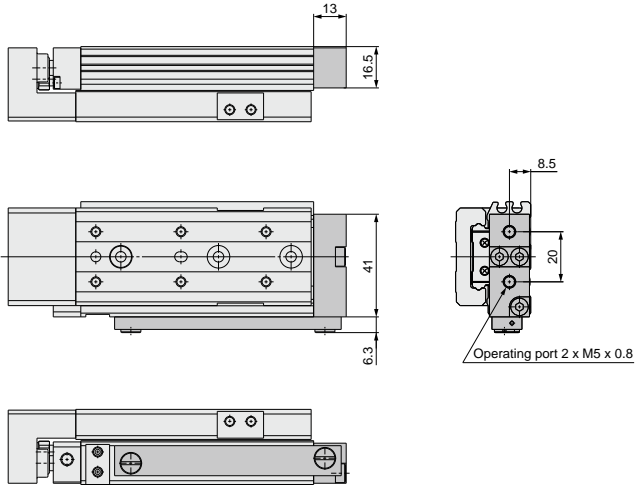

* Other dimensions are the same as basic type.

Directional Control Valves

Air Cylinders

Rotary Actuators

Air Grippers

Air Preparation Equipment

Modular F. R.

Pressure Control Equipment

Fittings & Tubing

Flow Control Equipment

Pressure Switches/ Pressure Sensors

Dimensions: **13-22-MXQ16**

Basic

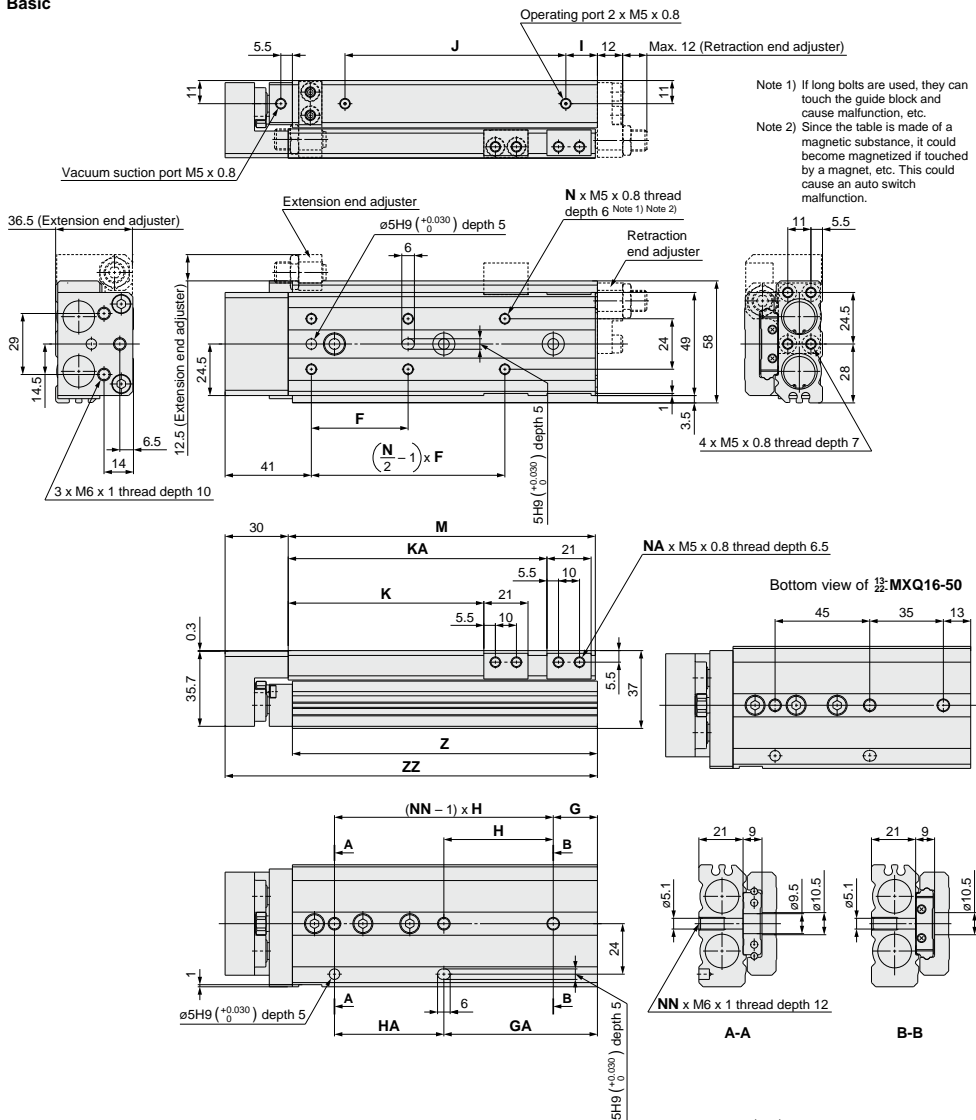

Note 1) If long bolts are used, they can touch the guide block and cause malfunction, etc.
 Note 2) Since the table is made of a magnetic substance, it could become magnetized if touched by a magnet, etc. This could cause an auto switch malfunction.

Model	F	N	G	H	NN	GA	HA	I	J	K	KA	NA	M	Z	ZZ
13-/22-MXQ16- 10	38	4	18	39	2	18	39	12	40	28	—	4	78	77	109
13-/22-MXQ16- 20	38	4	18	39	2	18	39	12	40	38	—	4	78	77	109
13-/22-MXQ16- 30	48	4	19	48	2	19	48	12	50	48	—	4	88	87	119
13-/22-MXQ16- 40	58	4	19	58	2	19	58	12	60	58	—	4	98	97	129
13-/22-MXQ16- 50	40	6	<small>None</small>	<small>None</small>	3	48	45	20	68	68	91	8	114	113	145
13-/22-MXQ16- 75	46	6	21	52	3	73	52	15	105	93	123	8	146	145	177
13-/22-MXQ16-100	44	8	36	44	4	80	88	18	145	118	166	8	189	188	220
13-/22-MXQ16-125	44	10	17	44	5	105	88	23	165	143	191	8	214	213	245

Note) Refer to the bottom view of 13-22-MXQ16-50.

Dimensions: ¹³⁻₂₂₋**MXQ16**

Axial piping (ø16): ¹³⁻₂₂₋**MXQ16-□□P**

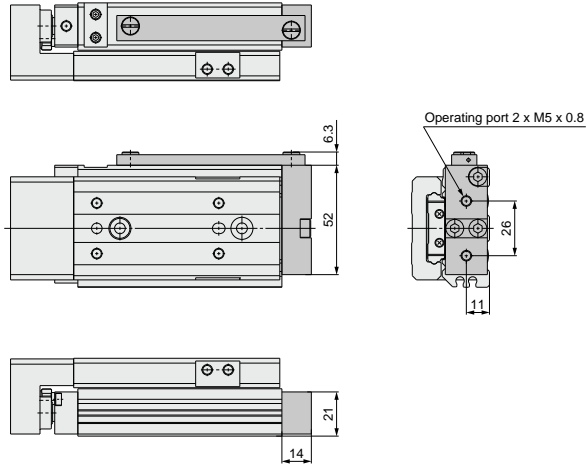

* Other dimensions are the same as basic type.

Directional Control Valves

Air Cylinders

Rotary Actuators

Air Grippers

Air Preparation Equipment

Modular F. R.

Pressure Control Equipment

Fittings & Tubing

Flow Control Equipment

Pressure Switches/ Pressure Sensors

Dimensions: 13-22-MXQ16L / Symmetric Type

Basic

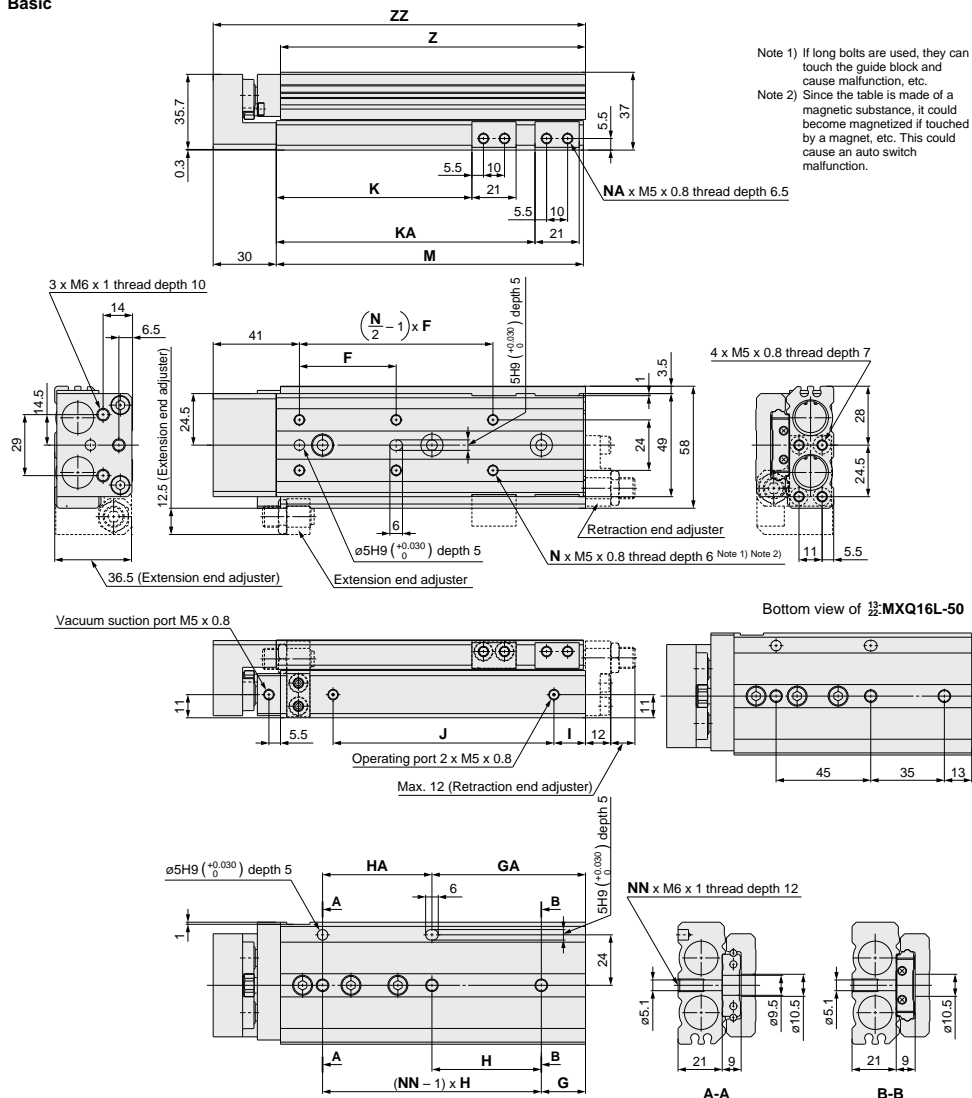

Model	F	N	G	H	NN	GA	HA	I	J	K	KA	NA	M	Z	ZZ
13-/22-MXQ16L- 10	38	4	18	39	2	18	39	12	40	28	—	4	78	77	109
13-/22-MXQ16L- 20	38	4	18	39	2	18	39	12	40	38	—	4	78	77	109
13-/22-MXQ16L- 30	48	4	19	48	2	19	48	12	50	48	—	4	88	87	119
13-/22-MXQ16L- 40	58	4	19	58	2	19	58	12	60	58	—	4	98	97	129
13-/22-MXQ16L- 50	40	6	<small>(Note)</small>	<small>(Note)</small>	3	48	45	20	68	68	91	8	114	113	145
13-/22-MXQ16L- 75	46	6	21	52	3	73	52	15	105	93	123	8	146	145	177
13-/22-MXQ16L-100	44	8	36	44	4	80	88	18	145	118	166	8	189	188	220
13-/22-MXQ16L-125	44	10	17	44	5	105	88	23	165	143	191	8	214	213	245

(mm)
 Note) Refer to the bottom view of 13-22-MXQ16L-50.

Dimensions: ¹³⁻/₂₂₋MXQ16L / Symmetric Type

Axial piping (ø16): ¹³⁻/₂₂₋MXQ16L-□□P

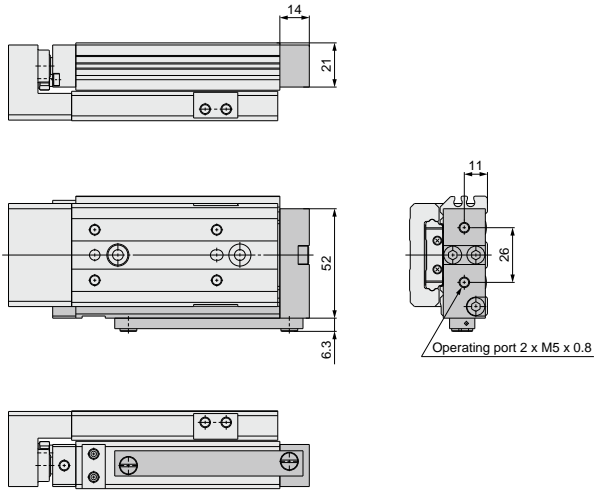

* Other dimensions are the same as basic type.

Directional Control Valves

Air Cylinders

Rotary Actuators

Air Grippers

Air Preparation Equipment

Modular F. R.

Pressure Control Equipment

Fittings & Tubing

Flow Control Equipment

Pressure Switches/ Pressure Sensors

Dimensions: ¹³⁻₂₂₋**MXQ20**

Basic

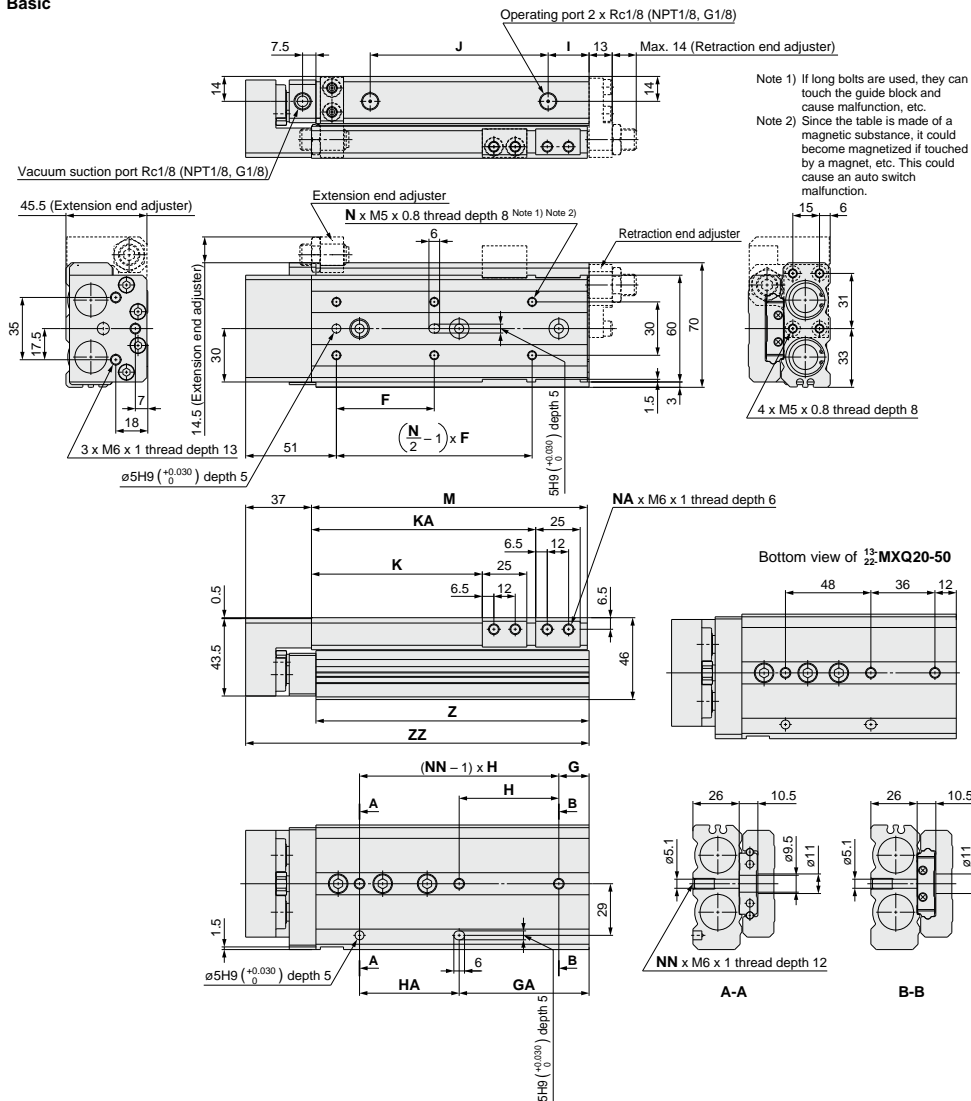

Note 1) If long bolts are used, they can touch the guide block and cause malfunction, etc.
 Note 2) Since the table is made of a magnetic substance, it could become magnetized if touched by a magnet, etc. This could cause an auto switch malfunction.

Model	F	N	G	H	NN	GA	HA	I	J	K	KA	NA	M	Z	ZZ
13-/22-MXQ20- 10	45	4	22	46	2	18	50	16	46	31	—	4	94	92.5	132
13-/22-MXQ20- 20	40	4	22	46	2	18	50	16	46	41	—	4	94	92.5	132
13-/22-MXQ20- 30	48	4	22	46	2	18	50	16	46	51	—	4	94	92.5	132
13-/22-MXQ20- 40	58	4	22	56	2	22	56	16	56	61	—	4	104	102.5	142
13-/22-MXQ20- 50	42	6	_{None}	_{None}	3	48	48	18	72	71	—	4	122	120.5	160
13-/22-MXQ20- 75	55	6	17	56	3	73	56	23	100	96	126	8	155	153.5	193
13-/22-MXQ20-100	50	8	18	56	4	74	112	25	155	121	183	8	212	210.5	250
13-/22-MXQ20-125	55	8	37	59	4	96	118	18	190	146	211	8	240	238.5	278
13-/22-MXQ20-150	62	8	56	62	4	118	124	21	215	171	239	8	268	266.5	306

Note) Refer to the bottom view of ¹³⁻₂₂₋**MXQ20-50**.

Dimensions: ¹³⁻~~22-~~**MXQ20**

Axial piping (ø20): ¹³⁻~~22-~~**MXQ20-□□P**

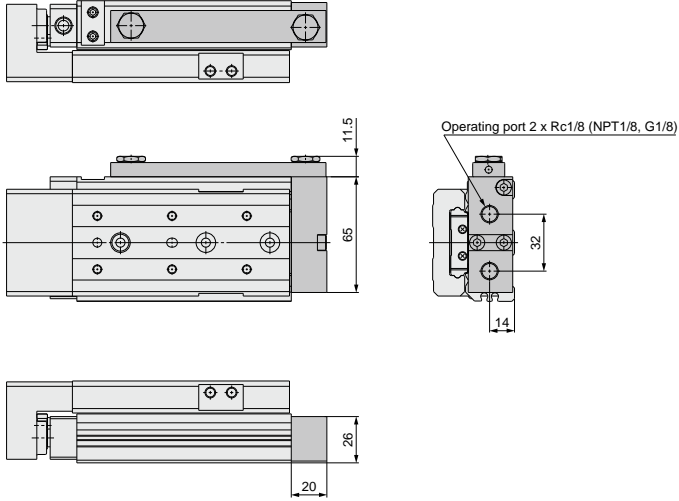

* Other dimensions are the same as basic type.

Directional Control Valves

Air Cylinders

Rotary Actuators

Air Grippers

Air Preparation Equipment

Modular F. R.

Pressure Control Equipment

Fittings & Tubing

Flow Control Equipment

Pressure Switches/ Pressure Sensors

Dimensions: ¹³⁻/₂₂₋MXQ20L / Symmetric Type

Axial piping (ø20): ¹³⁻/₂₂₋MXQ20L-□□P

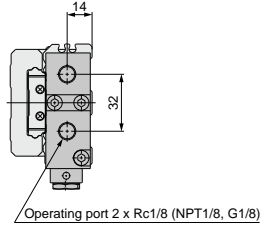
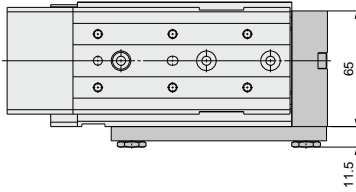
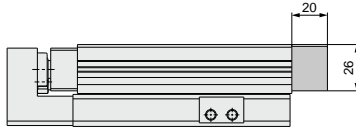

* Other dimensions are the same as basic type.

Directional Control Valves
Air Cylinders
Rotary Actuators
Air Grippers
Air Preparation Equipment
Modular F. R.
Pressure Control Equipment
Fittings & Tubing
Flow Control Equipment
Pressure Switches/ Pressure Sensors

Dimensions: 13-22-MXQ25

Basic

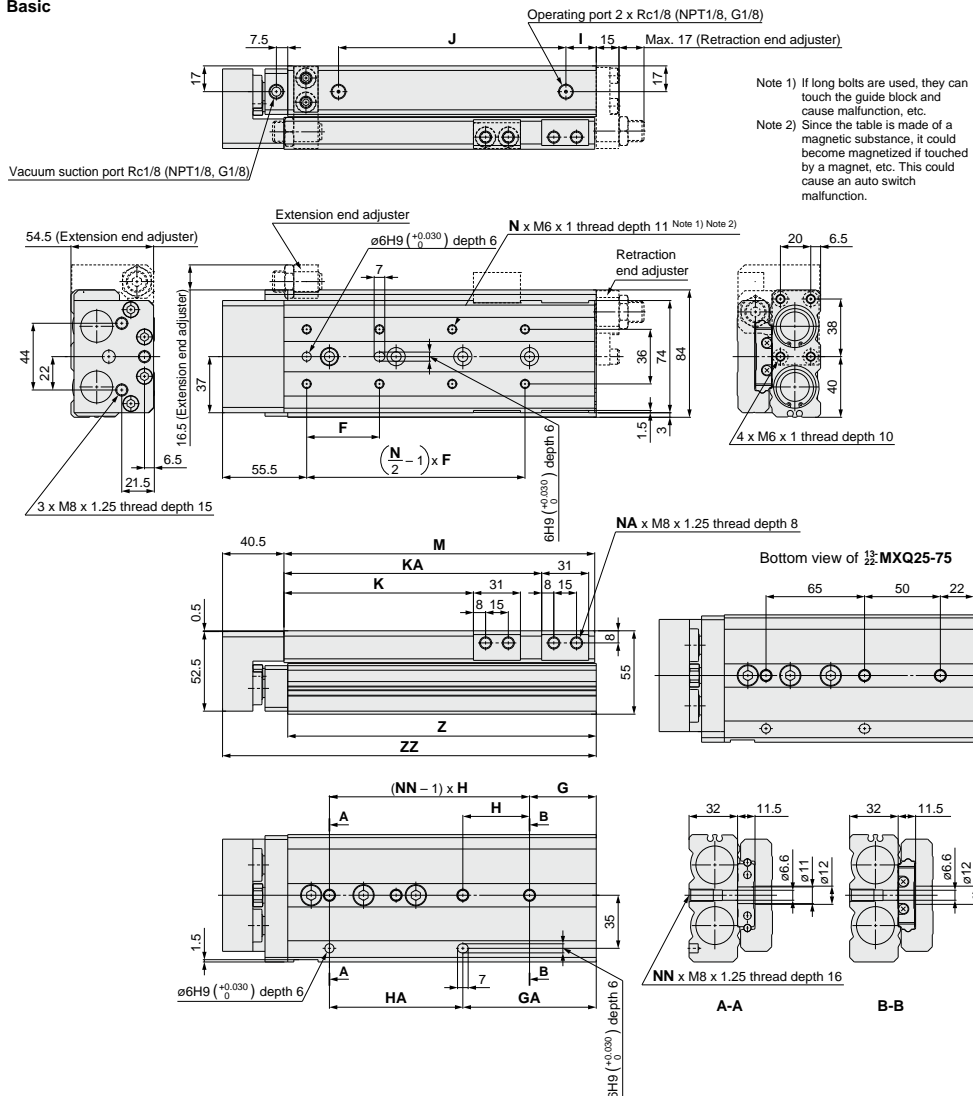

Model	F	N	G	H	NN	GA	HA	I	J	K	KA	NA	M	Z	ZZ
13-/22-MXQ25- 10	55	4	23	55	2	23	55	16	56	35	—	4	107	105.5	148.5
13-/22-MXQ25- 20	46	4	23	55	2	23	55	16	56	45	—	4	107	105.5	148.5
13-/22-MXQ25- 30	55	4	23	55	2	23	55	16	56	55	—	4	107	105.5	148.5
13-/22-MXQ25- 40	65	4	23	65	2	23	65	16	66	65	—	4	117	115.5	158.5
13-/22-MXQ25- 50	75	4	32	80	2	32	80	16	90	75	—	4	141	139.5	182.5
13-/22-MXQ25- 75	60	6	<small>(Note)</small>	<small>(Note)</small>	3	72	65	31	100	100	—	4	166	164.5	207.5
13-/22-MXQ25-100	48	8	44	44	4	88	88	20	150	125	170	8	205	203.5	246.5
13-/22-MXQ25-125	60	8	31	66	4	97	132	18	205	150	223	8	258	256.5	299.5
13-/22-MXQ25-150	65	8	56	66	4	122	132	18	230	175	248	8	283	281.5	324.5

Note) Refer to the bottom view of 13-22-MXQ25-75.

Dimensions: ¹³⁻₂₂₋MXQ25

Axial piping (ø25): ¹³⁻₂₂₋MXQ25-□□P

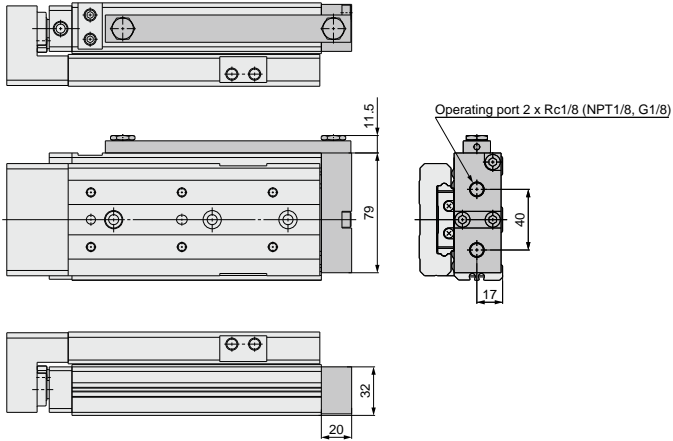

* Other dimensions are the same as basic type.

Directional Control Valves

Air Cylinders

Rotary Actuators

Air Grippers

Air Preparation Equipment

Modular F. R.

Pressure Control Equipment

Fittings & Tubing

Flow Control Equipment

Pressure Switches/ Pressure Sensors

Dimensions: 13-22-MXQ25L / Symmetric Type

Axial piping (ø25): 13-22-MXQ25L-□□P

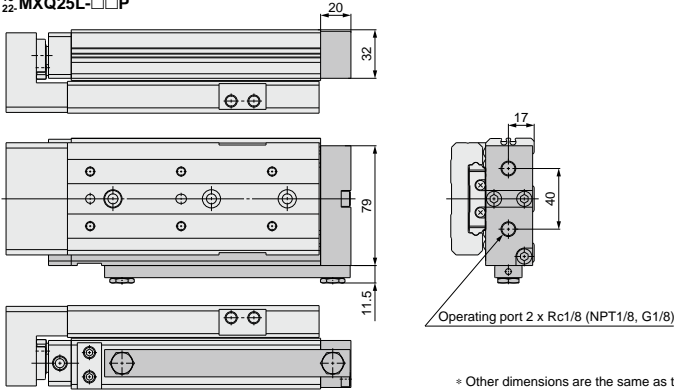

Made to Order

1. Anti-corrosive guide unit -X42

13-22-MXQ **Standard model no. -X42**

Martensitic stainless steel is used for table and guide block. Use this treatment if more effective anti-corrosiveness is necessary. Table and guide block are given anti-corrosive treatment ^{Note 2)}.

Note 1) Dimensions are the same as standard type.

Note 2) Special anti-corrosive treatment makes the table and guide block black.

2. Dust cover and dust plug made by fluororubber -X52

13-MXQ **Standard model no. -X52**

Fluororubber is used for the dust cover and the dust plug instead of silicone rubber for standard one.

Note 1) Dimensions are the same as standard type.

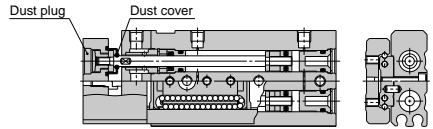

⚠ Specific Product Precautions

Be sure to read this before handling.

Handling

⚠ Caution

In case the extension end stroke adjuster is removed, plug the mounting hole.

Particle generation may occur because the bottom hole of the mounting screw penetrates the body. Consult with SMC for more information.

Applicable bore size (mm)	12, 16, 20, 25
---------------------------	----------------

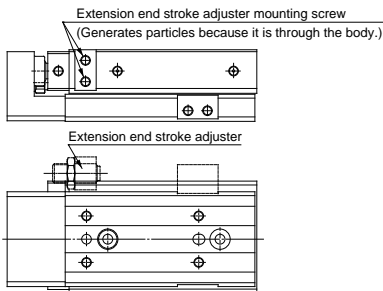

In case of types without extension end adjuster, the hole is plugged with a hexagon socket set screw at the time of shipment.

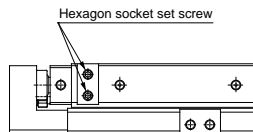

Directional Control Valves
Air Cylinders
Rotary Actuators
Air Grippers
Air Preparation Equipment
Modular F. R.
Pressure Control Equipment
Fittings & Tubing
Flow Control Equipment
Pressure Switches/ Pressure Sensors

Series 11-MXJ ø4, ø6, ø8 Air Slide Table



How to Order

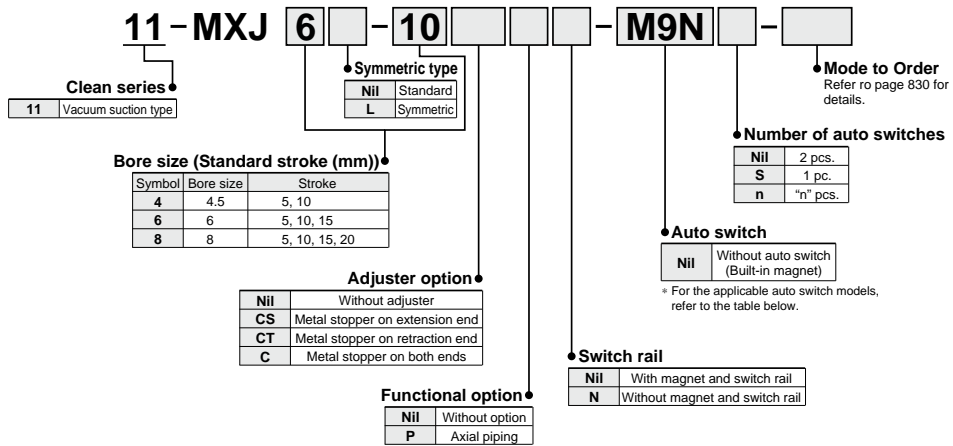

Auto Switch Specifications (Refer to the WEB catalog for detailed specifications and auto switches not in the following table.)

Type	Special function	Electrical entry	Indicator light	Wiring (Output)	Load voltage			Auto switch model	Lead wire length (m)*		Applicable load	
					DC	AC	Electrical entry direction		0.5 (Nil)	3 (L)		
								In-line				
Reed auto switch	—	Grommet	Yes	2-wire	24 V	12 V	100 V	A93	●	●	—	Relay, PLC
Solid state auto switch	—	Grommet	Yes	3-wire (NPN)	24 V	12 V	12 V	M9N	●	●	—	Relay, PLC
				2-wire				M9B	●	●	—	

* Lead wire length symbols 0.5 m.....Nil (Example) A93
3 m.....L
A93L

PLC: Programmable Logic Controller

Refer to page 889 for the applicable auto switch list.

Specifications

Model		11-MXJ4	11-MXJ6	11-MXJ8
Bore size (mm)		4.5	6	8
Piping port size		M3 x 0.5		
Fluid		Air		
Action		Double acting		
Operating pressure		0.15 to 0.7 MPa		
Proof pressure		1.05 MPa		
Ambient and fluid temperature		-10 to 60°C		
Operating speed range (Average operating speed) <small>Note</small>		50 to 500 mm/s (Metal stopper: 50 to 200 mm/s)		
Cushion		Rubber bumper (Metal stopper: Without cushion)		
Lubrication		Non-lube		
Stroke adjusting range (Metal stopper)		0 to 5 mm at both ends		
Stroke length tolerance		+1 0 mm		
Cleanliness class (ISO class)	Without adjuster	Class 5		
	Metal stopper	Class 6		

Note) Average operating speed: Speed that the stroke is divided by a period of time from starting the operation to reaching the end.

Auto Switch Proper Mounting Position (Detection at Stroke End)

Reed auto switch **D-A93** Solid state auto switch **D-M9□**

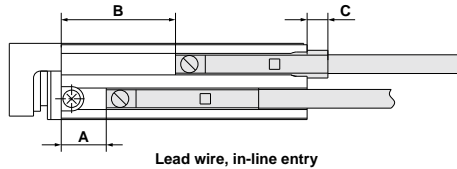

* Values in the table below are used as a reference when mounting the auto switches for stroke end detection. For actually setting the auto switches, adjust them after confirming their operation.

Reed Auto Switch: D-A93

Model	A				B				C				Auto switch operating range
	Stroke				Stroke				Stroke				
	5	10	15	20	5	10	15	20	5	10	15	20	
11-MXJ4	9	4	—	—	14	14	—	—	0.5	0.5	—	—	4
11-MXJ6	9	4	3	—	14	14	18	—	0.5	0.5	-0.5	—	
11-MXJ8	9	4	10	5	14	14	25	25	-0.5	-0.5	0.5	0.5	

Solid State Auto Switch (Lead Wire, In-line Entry): D-M9□

Model	A				B				C				Auto switch operating range
	Stroke				Stroke				Stroke				
	5	10	15	20	5	10	15	20	5	10	15	20	
11-MXJ4	13	8	—	—	18	18	—	—	4.5	4.5	—	—	2
11-MXJ6	13	8	7	—	18	18	22	—	4.5	4.5	3.5	—	
11-MXJ8	13	8	14	9	18	18	29	29	3.5	3.5	4.5	4.5	

Auto Switch Mounting

When using the solid state auto switch (D-M9□), mount it in the illustrated direction. The lower slot is for extension end detection.

Lead wire, in-line entry (D-M9□)

Extension end Retraction end



Suction Flow Rate of Vacuum Suction Type (Reference values)

Size	Suction flow rate L/min (ANR)
4	1
6	1
8	1

Directional Control Valves

Air Cylinders

Rotary Actuators

Air Grippers

Air Preparation Equipment

Modular F. R.

Pressure Control Equipment

Fittings & Tubing

Flow Control Equipment

Pressure Switches/Pressure Sensors

Dimensions Note) In the 11-MXJ4, there is no change in total length by stroke.

Basic (Without switch rail)

11-MXJ4-□□□N

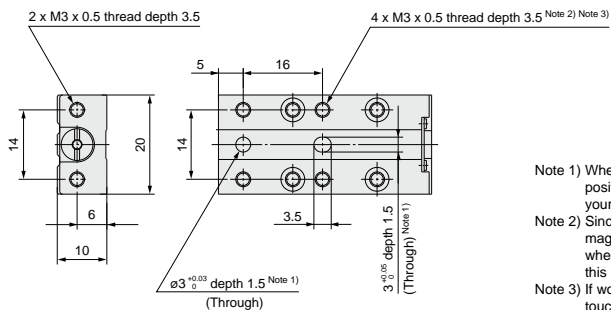
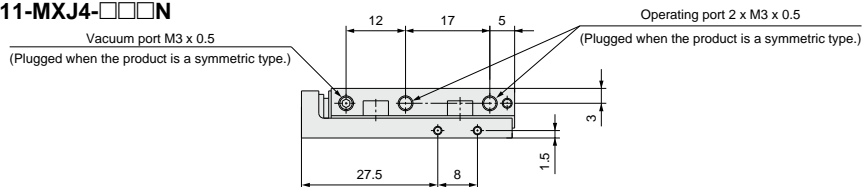

Note 1) When using a positioning pin, use a stepped positioning pin. For details, please consult with your SMC sales representative.

Note 2) Since the body and table are constructed with a magnetic substance, it becomes magnetized when magnets, etc. are attached to them, and this may cause the auto switch malfunction.

Note 3) If workpiece holding bolts are used, they can touch the body and cause malfunctions, etc. Refer to the Specific Product Precautions.

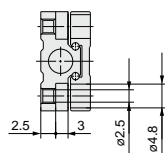
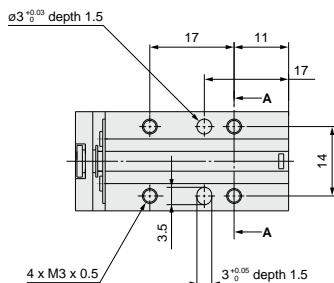
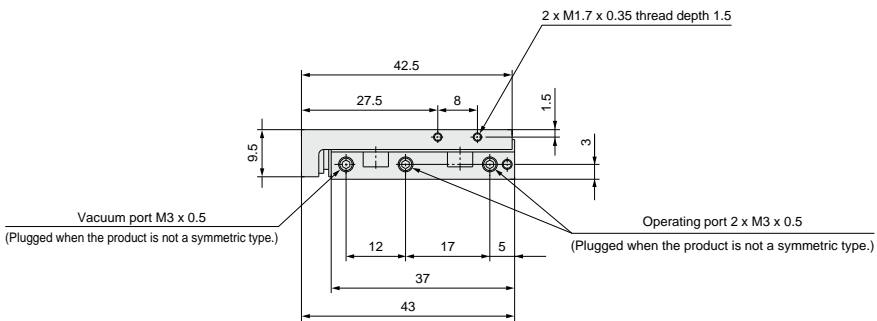

A-A

* Other dimensions are the same as standard model (Series MXJ).

Dimensions

Basic (Without switch rail)

11-MXJ6-□□□□N

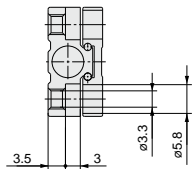
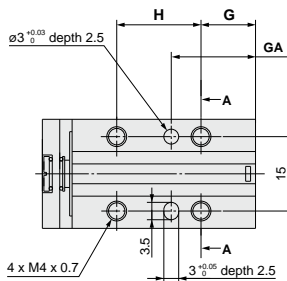
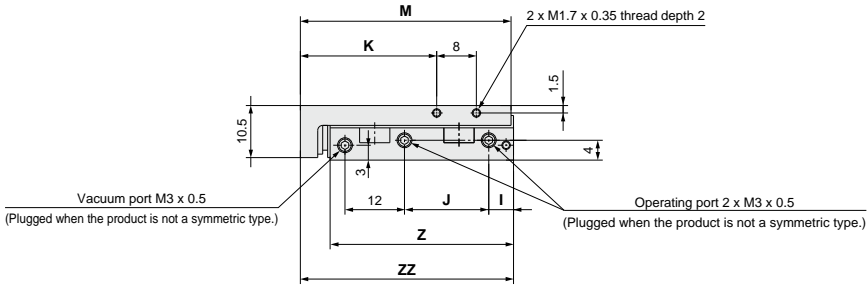
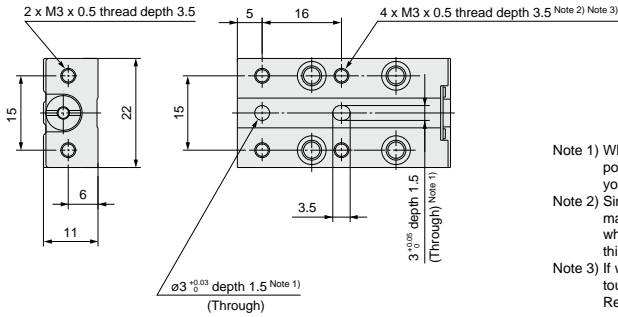
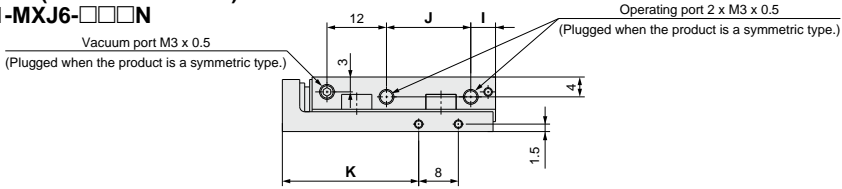

A-A

Model	G	GA	H	I	J	K	M	Z	ZZ
11-MXJ6-5	11	17	17	5	17	27.5	42.5	37	43
11-MXJ6-10	11	17	17	5	17	27.5	42.5	37	43
11-MXJ6-15	13	22	20	7	20	31.5	47.5	42	48

* Other dimensions are the same as standard model (Series MXJ).

Directional Control Valves
Air Cylinders
Rotary Actuators
Air Grippers
Air Preparation Equipment
Modular F. R.
Pressure Control Equipment
Fittings & Tubing
Flow Control Equipment
Pressure Switches/Pressure Sensors

Dimensions

Basic (Without switch rail)

11-MXJ8-□□□N

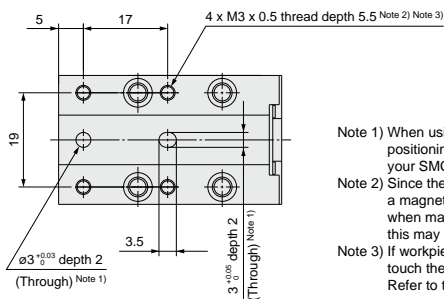
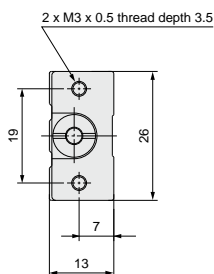
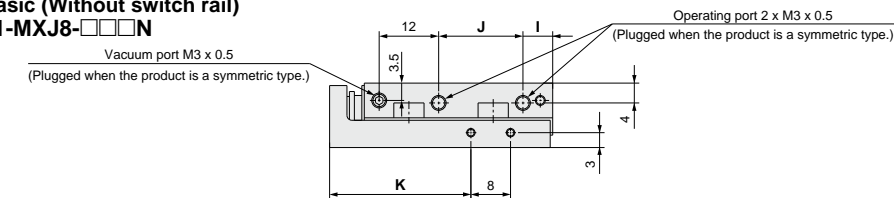

- Note 1) When using a positioning pin, use a stepped positioning pin. For details, please consult with your SMC sales representative.
- Note 2) Since the body and table are constructed with a magnetic substance, it becomes magnetized when magnets, etc. are attached to them, and this may cause the auto switch malfunction.
- Note 3) If workpiece holding bolts are used, they can touch the body and cause malfunctions, etc. Refer to the Specific Product Precautions.

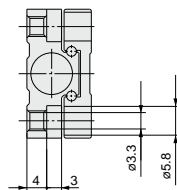
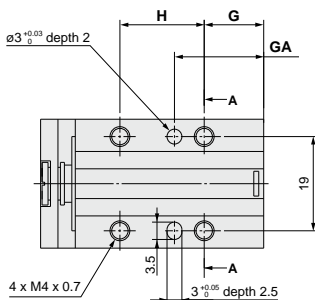
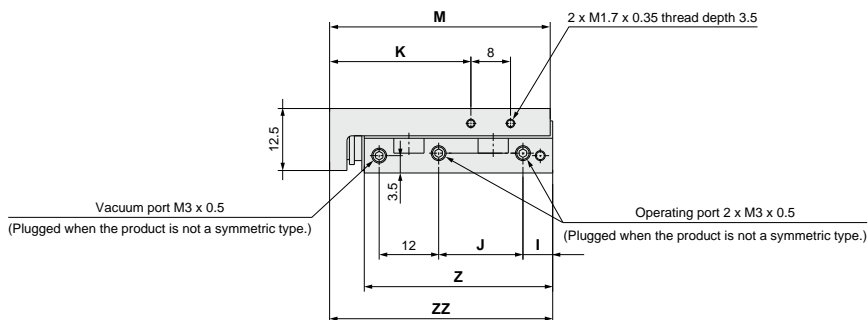

Model	G	GA	H	I	J	K	M	Z	ZZ
11-MXJ8-5	12	18	17	6	17	28.5	44.5	38	45
11-MXJ8-10	12	18	17	6	17	28.5	44.5	38	45
11-MXJ8-15	19	28	20	8	25	39.5	54.5	48	55
11-MXJ8-20	19	28	20	8	25	39.5	54.5	48	55

* Other dimensions are the same as standard model (Series MXJ).

Made to Order

Anti-corrosive guide unit	-X42
---------------------------	------

11-MXJ

Standard model no.

 -X42

Martensitic stainless steel is used for table and body. Use this treatment if more effective anti-corrosiveness is necessary.

Anti-corrosive treatment ^{Note 2)} is applied to the table and body.

Note 1) Dimensions are the same as standard type.

Note 2) Special anti-corrosive treatment makes the table and body black.

Directional
Control Valves

Air Cylinders

Rotary Actuators

Air Grippers

Air Preparation
Equipment

Modular F. R.

Pressure Control
Equipment

Fittings & Tubing

Flow Control
Equipment

Pressure Switches/
Pressure Sensors

Series 11-22-MXP/MXPJ6

ø6, ø10, ø12, ø16
Air Slide Table



How to Order

• **Clean series**
11 Vacuum suction type

11 — MXP 12 — 15 [] [] — M9N []

22 — MXP 12 — 15 [] [] — M9N []

• **Copper, fluorine and silicone-free + Low particle generation**
22 Vacuum suction type

• **Bore size - Stroke (mm)**

ø6	5, 10
ø10	10, 20
ø12	15, 25
ø16	20, 30

• **Auto switch**

Nil	2 pcs.
S	1 pc.
n	n pcs.

• **Auto switch**

Nil	Without auto switch
-----	---------------------

* Refer to the table below for auto switch part numbers.

• **Auto switch**

Nil	With magnet and rail
N	Without magnet and rail

* Auto switch cannot be mounted on types without magnet and rail (N).

• **Adjuster option**

Nil	Rubber stopper
C	Metal stopper
H	Without adjuster

* Adjuster for the 11-MXP6 series is available for one side only. Without adjuster type is not available for the 11-MXP6 series.



11-MXP

How to Order MXPJ6

• **Clean series**
11 Vacuum suction type

11 — MXPJ6 — 10

22 — MXPJ6 — 10

• **Copper, fluorine and silicone-free + Low particle generation**
22 Vacuum suction type

* With auto switch type is not available for the 11-MXPJ6 series.

• **Stroke**

5	5 mm
10	10 mm



11-MXPJ6

Auto Switch Specifications (Refer to the WEB catalog for detailed specifications and auto switches not in the following table.)

Type	Special function	Electrical entry	Indicator light	Wiring (Output)	Load voltage		Auto switch model		Lead wire length (m) [*]		Applicable load	
					DC	AC	Electrical entry direction	In-line	0.5 (Nil)	3 (L)		
Reed auto switch	—	Grommet	Yes	2-wire	24 V	12 V	100 V	A93	●	●	—	Relay, PLC
Solid state auto switch	—	Grommet	Yes	3-wire (NPN) 2-wire	24 V	12 V	—	M9N	●	●	—	Relay, PLC
						12 V	—	M9B	●	●	—	

* Lead wire length symbols 0.5 m.....Nil (Example) A93
3 m.....L A93L

PLC: Programmable Logic Controller

Refer to page 889 for the applicable auto switch list.

Specifications

Model	11-22-MXPJ6	11-22-MXP6	11-22-MXP10	11-22-MXP12	11-22-MXP16
Bore size (mm)	6	6	10	12	16
Piping port size	M3 x 0.5		M5 x 0.8		
Fluid	Air				
Action	Double acting				
Operating pressure	0.15 to 0.7 MPa				
Proof pressure	1.05 MPa				
Ambient and fluid temperature	-10 to 60°C				
Piston speed	30 to 200 mm/s				
Cushion	Rubber bumper	Rubber bumper (Rubber stopper)			
		—	Rubber bumper (Without adjuster)		
		No (Metal stopper)			
Lubrication	Non-lube				
Stroke adjuster	—	Standard equipment (MXP6 : Adjustable on one side only)			
Stroke adjustment range	Rubber stopper	—	0 to 5 mm on one side only	0 to 3 mm at both ends	
	Metal stopper	—	0 to 6 mm on one side only	0 to 5 mm at both ends	0 to 4 mm at both ends
Stroke length tolerance	± 0.1 mm				
Grease	11-: Fluorine grease				
	22-: Lithium soap based grease				
Cleanliness class (ISO class)	Without adjuster	Class 3	—	Class 3	
	Rubber stopper	—	Class 4	Class 4	
	Metal stopper	—	Class 6	Class 6	

Suction Flow Rate of Vacuum Type (Reference values)

Size	Suction flow rate L/min (ANR)
6	1
10	3
12	4
16	6

Auto Switch Proper Mounting Position (Detection at Stroke End)

11-22-MXP6

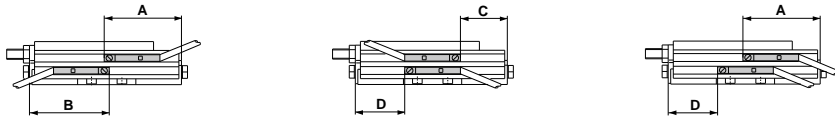

Reed auto switch D-A93

Model	Stroke (mm)				Auto switch operating range
	10	15	20	25	
11-22-MXP6	A	34.5	—	—	5
	B	35.5	—	—	
	C	14.5	—	—	
	D	15.5	—	—	

Solid state auto switch D-M9B, D-M9N

Model	Stroke (mm)		Auto switch operating range	
	5	10		
11-22-MXP6	A	25.5	30.5	3
	B	26.5	31.5	
	C	13.5	18.5	
	D	14.5	19.5	

11-22-MXP10, 12, 16

· Electrical entry from outside

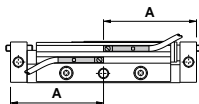

· Electrical entry from inside

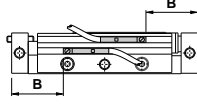

· Parallel electrical entry

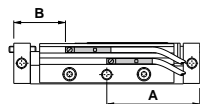

Reed auto switch D-A93

Model	Stroke (mm)					Auto switch operating range
	10	15	20	25	30	
11-22-MXP10	A	35	—	45	—	5
	B	15	—	25	—	
11-22-MXP12	A	—	40.5	—	50.5	5
	B	—	20.5	—	30.5	
11-22-MXP16	A	—	—	51	—	59
	B	—	—	31	—	39

Solid state auto switch D-M9B, D-M9N

Model	Stroke (mm)					Auto switch operating range
	10	15	20	25	30	
11-22-MXP10	A	31	—	41	—	3
	B	19	—	29	—	
11-22-MXP12	A	—	36.5	—	46.5	3
	B	—	24.5	—	34.5	
11-22-MXP16	A	—	—	47	—	55
	B	—	—	35	—	43

Dimensions: 11-22-MXPJ6

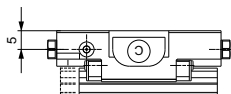

11-22-MXPJ6-5

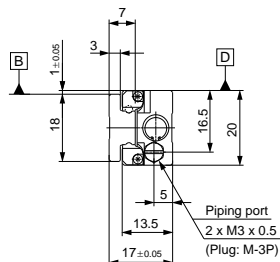
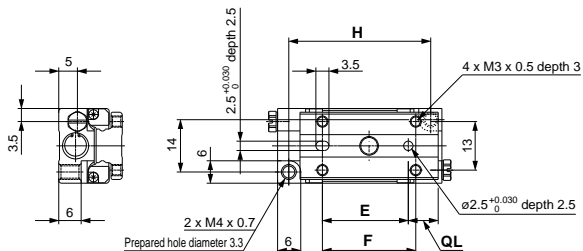

B D — Mounting base side

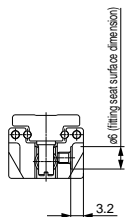

Section AA

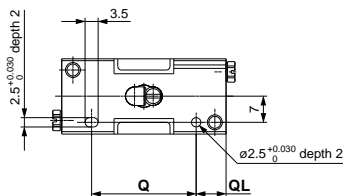
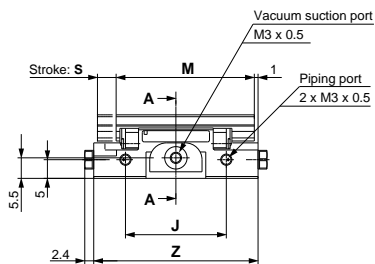

11-22-MXPJ6-10

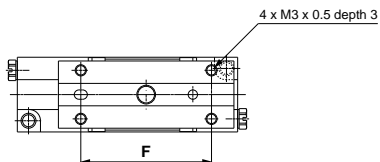

(mm)

Model	E	F	H	J	M	Q	QL	S	Z
11-22-MXPJ6-5	23	25	38	27	37	28	8	5	44
11-22-MXPJ6-10	30	35	53	42	47	37	11	10	59

Dimensions: 11-22-MXP10

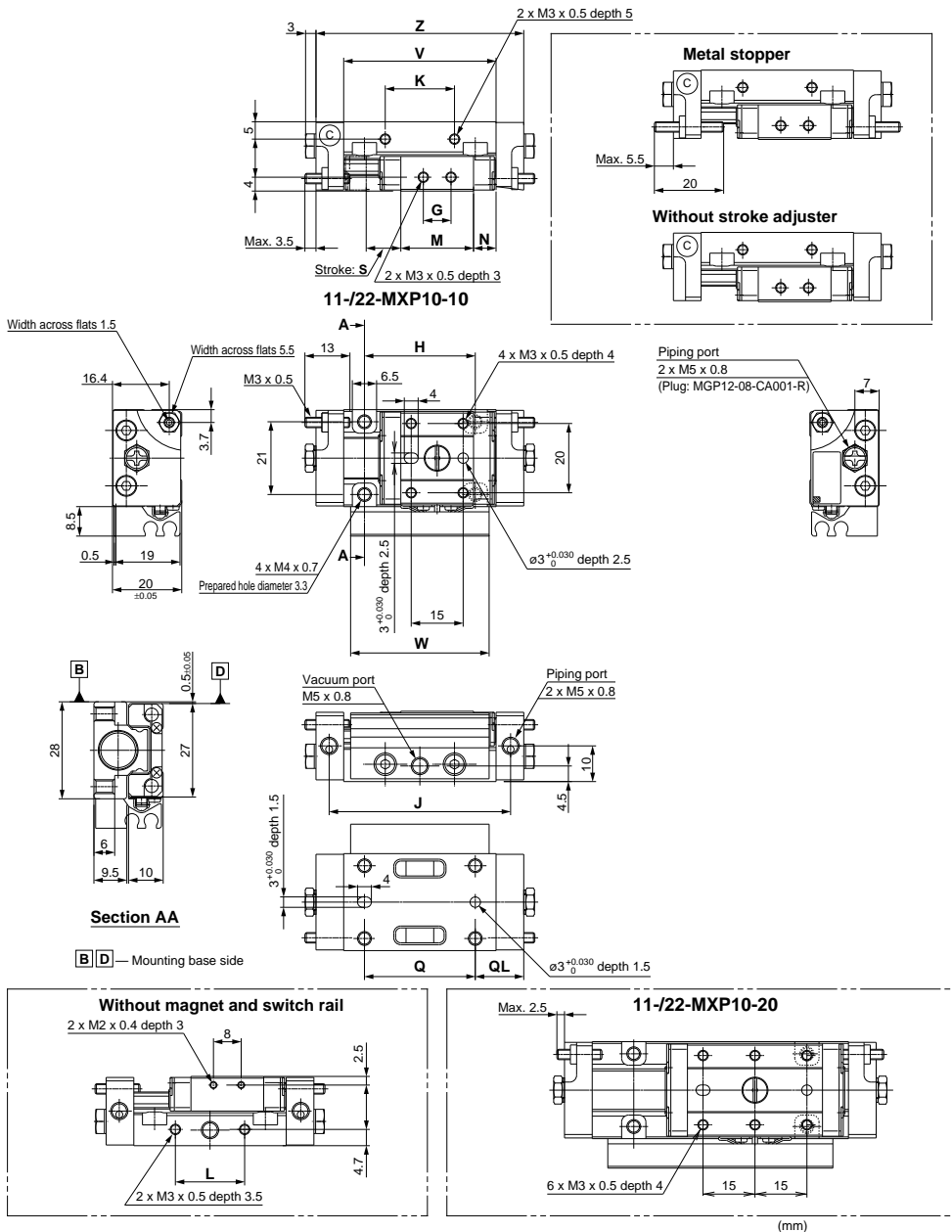

Model	G	H	J	K	L	M	N	Q	QL	S	V	W	Z
11-22-MXP10-10	8	32	52.4	20	20	21	6.5	32	14	10	44	40	60
11-22-MXP10-20	20	50	82.4	36	36	39	7.5	50	20	20	74	65	90

Dimensions: 11-22-MXP12

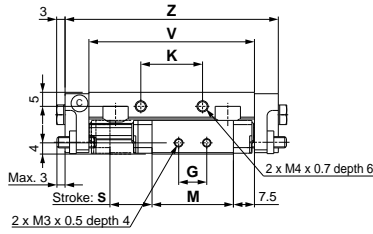

11-22-MXP12-15

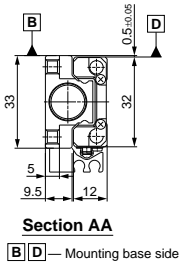
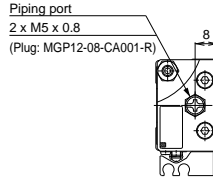
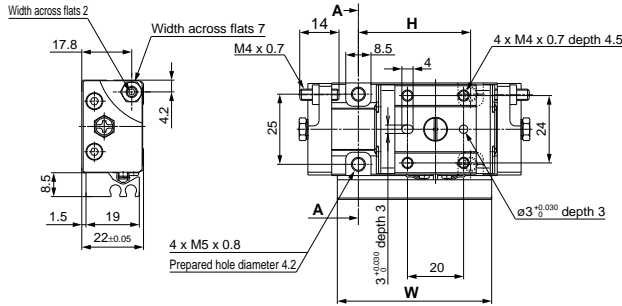

Section AA

B, D — Mounting base side

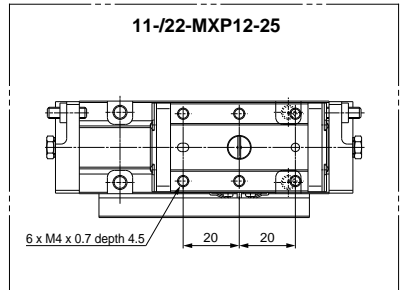
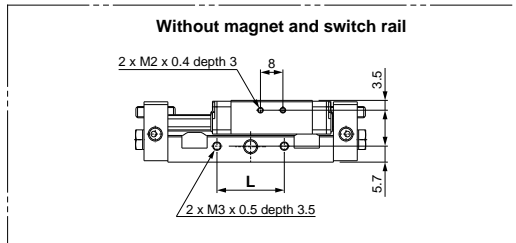
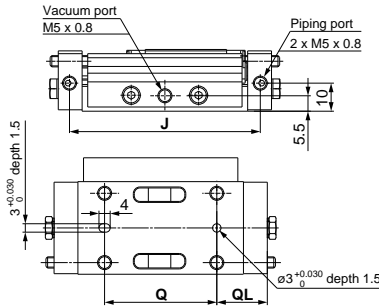

11-22-MXP12-25

Model	G	H	J	K	L	M	Q	QL	S	V	W	Z
11-22-MXP12-15	10	40	68	22	24	29	40	18	15	59	55	76
11-22-MXP12-25	30	60	98	40	42	49	60	23	25	89	75	106

(mm)

- Directional Control Valves
- Air Cylinders
- Rotary Actuators
- Air Grippers
- Air Preparation Equipment
- Modular F. R.
- Pressure Control Equipment
- Fittings & Tubing
- Flow Control Equipment
- Pressure Switches/ Pressure Sensors

Dimensions: 11-22-MXP16

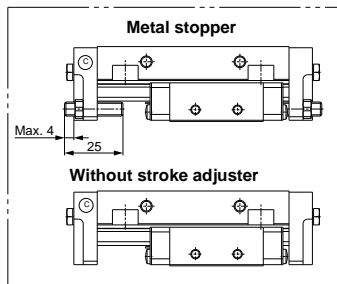
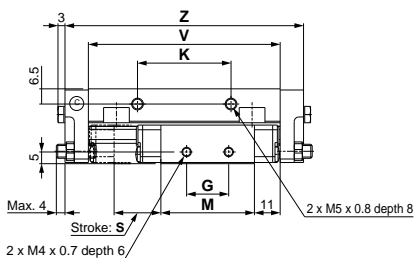

11-22-MXP16-20

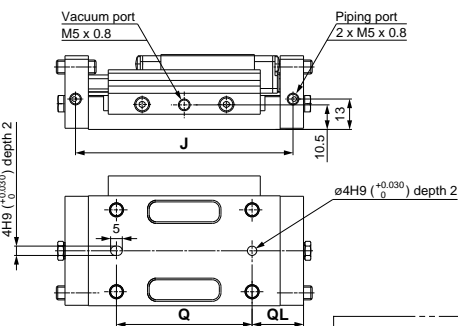
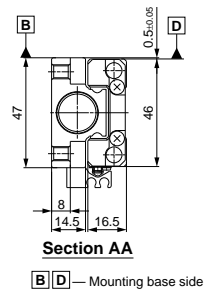
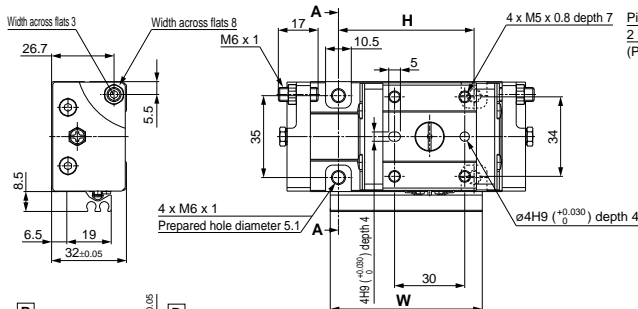

11-22-MXP16-30

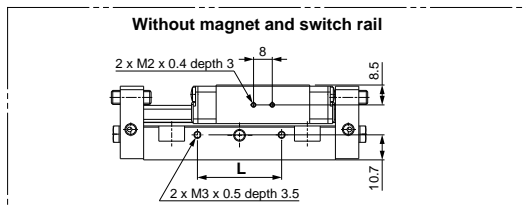
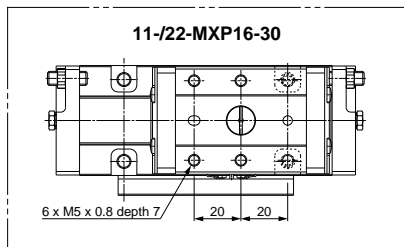

	(mm)											
Model	G	H	J	K	L	M	Q	QL	S	V	W	Z
11-22-MXP16-20	18	58	93	40	36	40	58	22	20	82	65	102
11-22-MXP16-30	28	70	119	50	42	56	70	29	30	108	75	128

Made to Order

Anti-corrosive guide unit	-X42
---------------------------	------

11-/22-MXP Standard model no. -X42

11-/22-MXPJ6 Standard model no. -X42

Martensitic stainless steel is used for the body, table and guide block. Use this treatment if more effective anti-corrosiveness is necessary.

Anti-corrosive treatment ^(Note 2) is applied to the body, table and guide block.

Note 1) Dimensions are the same as standard type.

Note 2) Special anti-corrosive treatment makes the body, table and guide block black.

⚠ Specific Product Precautions

Be sure to read this before handling.

Mounting

⚠ Caution

Mount the body on a flat surface in case of 11-/22-MXPJ6 series.

The 11-/22-MXPJ6 series has an opening on the bottom surface of the body and the opening is connected to the vacuum suction port. Sufficient vacuum suction may not be achieved in presence of any clearances.

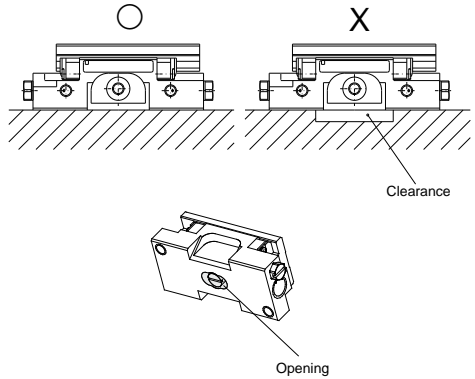

Directional Control Valves

Air Cylinders

Rotary Actuators

Air Grippers

Air Preparation Equipment

Modular F. R.

Pressure Control Equipment

Fittings & Tubing

Flow Control Equipment

Pressure Switches/ Pressure Sensors

Series 12-13-MGPL-Z $\phi 12, \phi 16, \phi 20, \phi 25, \phi 32, \phi 40, \phi 50, \phi 63$ Compact Guide Cylinder

How to Order

● Clean series

12	Relief type (with specially treated sliding parts)
13	Vacuum suction type (with specially treated sliding parts)



12 - MGPL 25 - 50 Z - M9BW

Ball bushing bearing

Bore size (mm)

Port type

Symbol	Type	Bore size
Nil	M5 x 0.8	$\phi 12, \phi 16$
	Rc	
TN	NPT	$\phi 20$ to $\phi 63$
TF	G	

● Number of auto switches

Nil	2 pcs.
S	1 pc.
n	n pcs.

● Auto switch

Nil	Without auto switch
Solid state	M9B, M9BW
Reed switch	A93

* The minimum stroke for auto switch mounting and operating range are the same as standard products.

● Cylinder stroke (mm)

Model

	Model	Bore size (mm)	Port size	Lubrication	Action	Standard stroke* (mm)	Auto switch mounting	Cushion	
								Rubber	Air
Relief type (with specially treated sliding parts)	12-MGPL12	12	M5 x 0.8	Non-lube	Double acting	10, 20, 30, 40, 50, 75, 100, 125, 150, 175, 200, 250	○	○ (Both sides)	-
	12-MGPL16	16							
	12-MGPL20	20							
	12-MGPL25	25	1/8			20, 30, 40, 50, 75, 100, 125, 150, 175, 200, 250, 300, 350, 400			
	12-MGPL32	32							
	12-MGPL40	40							
12-MGPL50	50	1/4	25, 50, 75, 100, 125, 150, 175, 200, 250, 300, 350, 400						
12-MGPL63	63								
12-MGPL63	63								
Vacuum suction type (with specially treated sliding parts)	13-MGPL12	12	M5 x 0.8	Non-lube	Double acting	10, 20, 30, 40, 50, 75, 100, 125, 150, 175, 200, 250	○	○ (Both sides)	-
	13-MGPL16	16							
	13-MGPL20	20							
	13-MGPL25	25	1/8			20, 30, 40, 50, 75, 100, 125, 150, 175, 200, 250, 300, 350, 400			
	13-MGPL32	32							
	13-MGPL40	40							
	13-MGPL50	50	1/4			25, 50, 75, 100, 125, 150, 175, 200, 250, 300, 350, 400			
	13-MGPL63	63							
	13-MGPL63	63							

* Non-standard intermediate strokes are available by attaching a spacer.

Specifications

Item	Bore size (mm)	
	12/16	20/25/32/40/50/63
Proof pressure	1.5 MPa	
Maximum operating pressure	1.0 MPa	
Minimum operating pressure	0.12 MPa	0.1 MPa
Ambient and fluid temperature	-10°C to 60°C (No freezing)	
Piston speed	50 to 400 mm/s	
Stroke length tolerance	+1.5	
Grease	12-/13-: Fluorine grease	
Cleanliness class (ISO class)	13-: Class 4	
	12-: Class 5	

Suction Flow Rate of Vacuum Suction Type (Reference values)

Size	Suction flow rate L/min (ANR)
12/16/20/25	5
32/40/50/63	10

Auto Switch Specifications (Refer to the **WEB catalog** for detailed specifications and auto switches not in the following table.)

Type	Electrical entry	Indicator light	Wiring (Output)	Load voltage		Auto switch model	Lead wire length (m)				Applicable load	
				DC	AC		Band mounting	0.5 (Nil)	1 (M)	3 (L)		5 (Z)
Solid state auto switch	Grommet	Yes	2-wire	24 V	5 V	—	M9B	●	●	●	○	—
				12 V	—		M9BW	●	●	●	○	
Reed auto switch	Grommet	Yes	2-wire	24 V	12 V	100 V	A93	●	—	●	●	—

Note 1) Lead wire length symbols: 0.5 m..... Nil M9BW
 1 m..... M M9BWM
 3 m..... L M9BWL
 5 m..... Z M9BWZ

Note 2) Solid state auto switches marked with "○" are produced upon receipt of order.
 Note 3) PLC: Programmable Logic Controller

Refer to page 889 for the applicable auto switch list.

Auto Switch Proper Mounting Position (Detection at Stroke End)

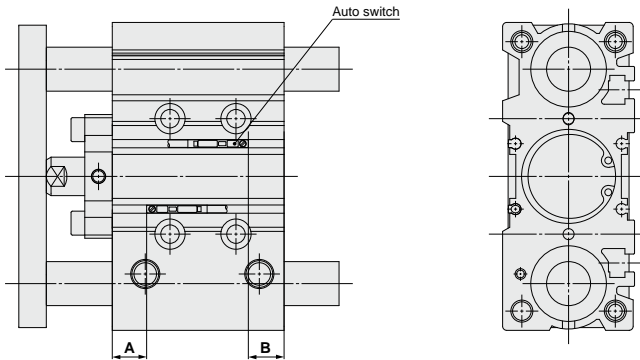

Auto Switch Proper Mounting Position (mm)

Auto switch model	D-M9□		D-A9□	
	D-M9□W			
	A	B	A	B
12	7.5	9.5	3.5	5.5
16	10.5	10.5	6.5	6.5
20	12.5	12.5	8.5	8.5
25	11.5	14	7.5	10
32	12.5	13	8.5	9
40	15.5	16.5	11.5	12.5
50	14.5	17	10.5	13
63	16.5	20	12.5	16

Note) The above values are a guide in the stroke end detection of the mounting positions of the auto switch. Please adjust in an actual setting after confirming the operating state of the auto switch.

Directional Control Valves
 Air Cylinders
 Rotary Actuators
 Air Grippers
 Air Preparation Equipment
 Modular F. R.
 Pressure Control Equipment
 Fittings & Tubing
 Flow Control Equipment
 Pressure Switches/ Pressure Sensors

Basic: ¹²⁻₁₃₋MGPL 12 to 25

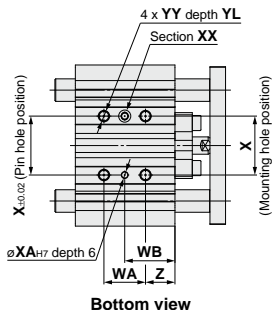

Detailed figure of XX section	T-slot dimensions
	(mm)
	Bore size (mm)
	12
	16
	20
	25

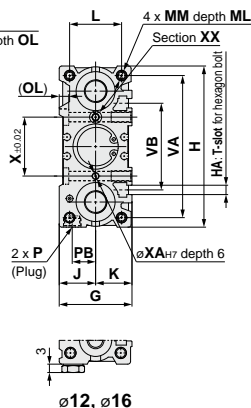
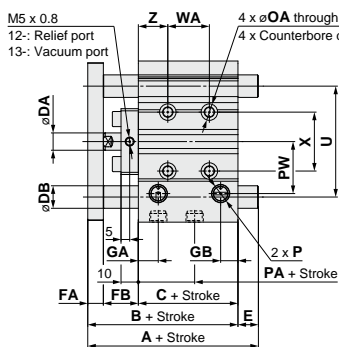
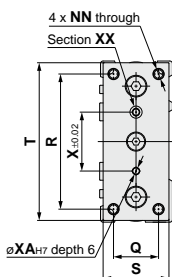

* The use of a slot (width XA, length XB, depth 3) allows for a relaxed pin pitch tolerance, with the pin hole (ϕXA_{H7} depth 6) as the reference, without affecting mounting accuracy.

* For bore size $\phi 12$ and $\phi 16$, only M5 x 0.8 port is available.

* For bore size $\phi 20$ or more, choice of Rc, NPT, G port is available. (Refer to page 839.)

Bore size (mm)	Standard stroke	A				B	C	DA	DB	E				FA	FB	G	GA
		30 st or less	Over 30 st and up to 100 st	Over 100 st and up to 200 st	Over 200 st					30 st or less	Over 30 st and up to 100 st	Over 100 st and up to 200 st	Over 200 st				
12	10,20,30,40,50,75,100	56	68	97.5	97.5	55	29	6	6	1	13	42.5	42.5	7	19	26	10
16	125,150,175,200,250	62	78	107.5	107.5	59	33	8	8	3	19	48.5	48.5	7	19	30	10.5
20	20,30,40,50,75,100,125,150	72	89	113	130.5	66	37	10	10	6	23	47	64.5	8	21	36	11.5
25	175,200,250,300,350,400	78.5	94.5	113.5	130.5	66.5	37.5	10	13	12	28	47	64	9	20	42	11.5

Bore size (mm)	GB	H	HA	J	K	L	MM	ML	NN	OA	OB	OL	P			PA	PB	PW	Q	R	S	T
													Nii	TN	TF							
12	7	58	M4	13	13	18	M4 x 0.7	10	M4 x 0.7	4.3	8	4.5	M5 x 0.8	—	—	13	8	18	14	48	22	56
16	7.5	64	M4	15	15	22	M5 x 0.8	12	M5 x 0.8	4.3	8	4.5	M5 x 0.8	—	—	14.5	10	19	16	54	25	62
20	9	83	M5	18	18	24	M5 x 0.8	13	M5 x 0.8	5.4	9.5	5.5	Rc1/8	NPT1/8	G1/8	13.5	10.5	25	18	70	30	81
25	10	93	M5	21	21	30	M6 x 1	15	M6 x 1	5.4	9.5	5.5	Rc1/8	NPT1/8	G1/8	12.5	13.5	30	26	78	38	91

Bore size (mm)	U	VA	VB	WA				WB				X	XA	XB	YY	YL	Z		
				30 st or less	Over 30 st and up to 100 st	Over 200 st and up to 300 st	Over 300 st	30 st or less	Over 30 st and up to 100 st	Over 200 st and up to 300 st	Over 300 st								
12	41	50	37	20	40	110	200	—	15	25	60	105	—	23	3	3.5	M5 x 0.8	10	5
16	46	56	38	24	44	110	200	—	17	27	60	105	—	24	3	3.5	M5 x 0.8	10	5
20	54	72	44	24	44	120	200	300	29	39	77	117	167	28	3	3.5	M6 x 1	12	17
25	64	82	50	24	44	120	200	300	29	39	77	117	167	34	4	4.5	M6 x 1	12	17

⚠ Specific Product Precautions

Be sure to read this before handling.

Mounting

⚠ Warning

1. Do not place your hands or fingers between the cylinder and the body.

Be careful not to get your hands or fingers caught between the cylinder body and the plate when air is applied.

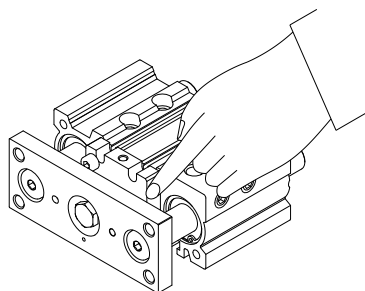

⚠ Caution

1. Be careful not to scratch or gouge the sliding portion of the piston rod and the guide rod.

Damaged seals may cause leakage or malfunction.

2. Bottom of cylinder

The guide rods protrude from the bottom of the cylinder at the end of the retracting stroke. Therefore, in cases where the cylinder is to be bottom mounted, it is necessary to provide bypass ports in the mounting surface for the guide rods, as well as holes for the hexagon socket head cap screws which are used for mounting.

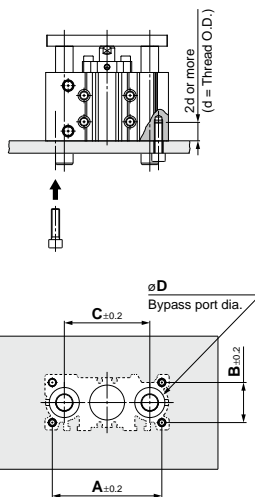

Bore size (mm)	A (mm)	B (mm)	C (mm)	øD (mm)	Hexagon socket head cap screw
12	50	18	41	8	M4 x 0.7
16	56	22	46	10	M5 x 0.8
20	72	24	54	12	M5 x 0.8
25	82	30	64	15	M6 x 1.0
32	98	34	78	18	M8 x 1.25
40	106	40	86	18	M8 x 1.25
50	130	46	110	22	M10 x 1.5
63	142	58	124	22	M10 x 1.5

Series 10-MGF

ø40, ø63, ø100 Guide Table

How to Order



10 - M G F 63 - **50** - **Y59B**

Clean series

10	Relief type
----	-------------

Bore size (mm)

Symbol	Type	Bore size
Nil	Rc	ø40, ø63, ø100
TN	NPT	
TF	G	

Port type

Number of auto switches

Nil	2 pcs.
S	1 pc.
n	n pcs.

Auto switch

Nil	Without auto switch
Reed switch	Z73
Solid state	Y59A, Y59B

* The minimum stroke for auto switch mounting and operating range are the same as standard products.

Cylinder stroke (mm)

Model

Relief type	Model	Bore size (mm)	Port size	Lubrication	Action	Standard stroke * (mm)	Auto switch mounting	Cushion	
								Rubber	Air
○	10-MGF40	40	1/8	Non-lube	Double acting	30, 50, 75, 100	○	○ (Both sides)	-
	10-MGF63	63	1/4						
	10-MGF100	100							

* Non-standard intermediate strokes (in 5 mm increments) are available by attaching a spacer of 5, 10, 15, 20 or 25 mm width.

Specifications

Item	Bore size(mm)	
		40/63/100
Proof pressure		1.5 MPa
Maximum operating pressure		1.0 MPa
Minimum operating pressure		0.1 MPa
Ambient and fluid temperature		-10 to 60°C (With no freezing)
Piston speed		20 to 200 mm/s
Stroke length tolerance		$^{+1.0}_0$ mm
Grease		Fluorine grease
Cleanliness class (ISO class)		Class 4

Directional Control Valves
 Air Cylinders
 Rotary Actuators
 Air Grippers
 Air Preparation Equipment
 Modular F. R.
 Pressure Control Equipment
 Fittings & Tubing
 Flow Control Equipment
 Pressure Switches/ Pressure Sensors

Guide Table 10-MGF

Auto Switch Specifications (Refer to the WEB catalog for detailed specifications and auto switches not in the following table.)

Type	Auto switch part no.	Load voltage	Load current range	Indicator light	Application
Reed auto switch	D-Z73	24 VDC, 100 VAC	5 to 40 mA, 5 to 20 mA	○	Relay, PLC
Solid state auto switch	D-Y59B	24 VDC (10 to 28 VDC)	5 to 40 mA	○	24 VDC Relay, PLC
auto switch	D-Y59A	28 VDC or less	40 mA or less	○	IC circuit, Relay, PLC

Refer to page 889 for the applicable auto switch list.

PLC: Programmable Logic Controller

Auto Switch Proper Mounting Position (Detection at Stroke End)

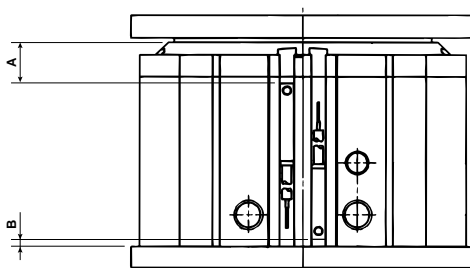

Proper Mounting Position (mm)

Bore size	A	B
40	16	0
63	27.5	0
100	32.5	0

Note) The above mentioned values are indicated as a guide for auto switch mounting positions for stroke end detection. When actually mounting an auto switch, adjust the position after confirming the operating state of the auto switch.

Dimensions

10-MGF40/63/100

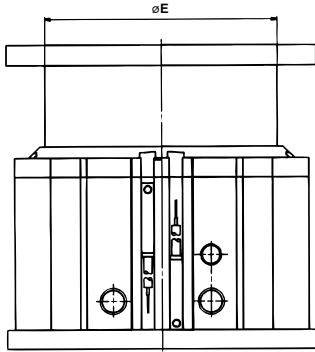

When the cylinder is extended

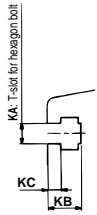

6-K (6 positions)

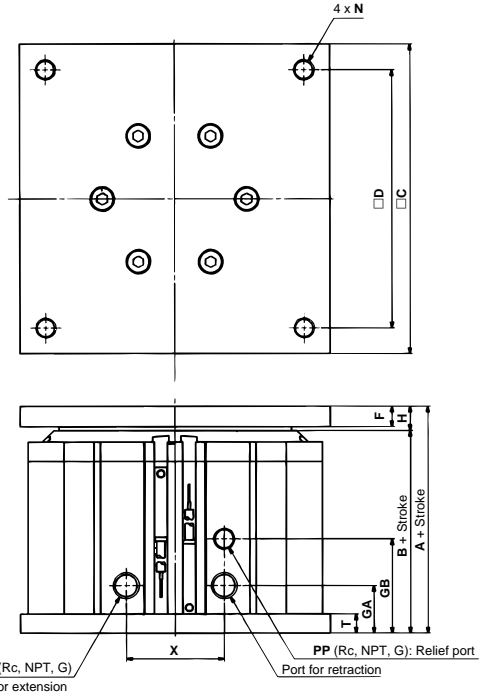

2 x P (Rc, NPT, G)
Port for extension

PP (Rc, NPT, G): Relief port
Port for retraction

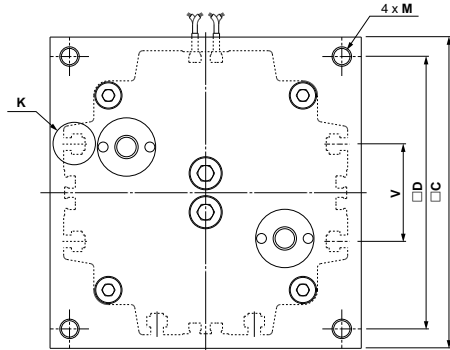

Boresize	Standard stroke	A	B	C	D	E	F	GA	GB	H	KA	KB	KC	M	N	P	PP	T	V	X
40		58	48.5	120	100	90	8	18.5	36.5	9.5	M5	8.7	3.5	M8 x 1.25	M8 x 1.25	1/8	1/8	8	40	38
63	30, 50, 75, 100	73	61.5	160	140	120	10	20	38	11.5	M6	11	4	M10 x 1.5	M10 x 1.5	1/4	1/8	10	50	46
100		78	66.5	200	170	160	10	20	38	11.5	M6	11	4	M12 x 1.75	M12 x 1.75	1/4	1/8	10	70	46

(mm)

- Directional Control Valves
- Air Cylinders
- Rotary Actuators
- Air Grippers
- Air Preparation Equipment
- Modular F. R.
- Pressure Control Equipment
- Fittings & Tubing
- Flow Control Equipment
- Pressure Switches/ Pressure Sensors

⚠ Specific Product Precautions

Be sure to read this before handling.

Selection

⚠ Caution

1. Operate loads within the range of the operating limits.
 Select a load taking into consideration the allowable horizontal loads, rotational torque and eccentric loads that will apply. When used in excess of the applicable limit, eccentric loads applied to the tube guide will cause wear of the guide, increase the guide's deviation range, cause stress cracks and breaks on the mounting bolts, and decrease the life of the cylinder.

2. Care should be taken to avoid scratches or gouges on the mounting surface of the plate or end plate.
 The flatness of the mounting face may deteriorate, the guide's deviation range may increase and the sliding resistance may become greater.

3. Do not allow hands or fingers near the cylinder during its operation.
 Your fingers may be caught between the body and the plate. If you need to come near the cylinder during its operation, install a cover on the cylinder.

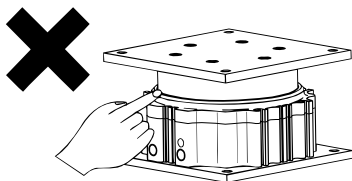

4. Do not bring objects that are sensitive to magnetism near the cylinder.
 The magnet is built into the cylinder. Do not bring magnetic disks, cards or tapes near the cylinder. Data may be lost.

5. If the cylinder is operated vertically with heavy loads, measures must be taken to prevent rapid extension of the piston rod when starting to operate in the downward direction.
 If the cylinder is operated vertically with heavy loads at the same pressure for both upward and downward directions, the starting speed in the downward direction may be higher than the speed controlled with a speed controller. In such cases, use a dual pressure control circuit as a pneumatic circuit.

Mounting

⚠ Caution

1. When mounting the cylinder, use screws of appropriate lengths and tighten with proper torque not exceeding the maximum tightening torque.

Mounting from upper side

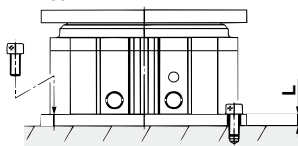

Model	Bolt	Maximum tightening torque (N·m)	L (mm)
MGF40	M6 x 1	10	8
MGF63	M8 x 1.25	25	10
MGF100	M10 x 1.5	51	10

Mounting from bottom side

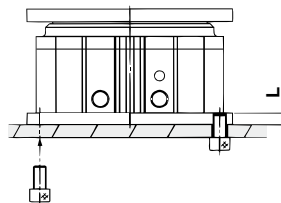

Model	Bolt	Maximum tightening torque (N·m)	L (mm)
MGF40	M8 x 1.25	18	8
MGF63	M10 x 1.5	36	10
MGF100	M12 x 1.75	65	10

Series 11-/12- 21-/22- **CXSJ** $\varnothing 6, \varnothing 10$ Dual Rod Cylinder/Compact Type

How to Order



Clean series

11	Vacuum suction type	CXSJM, CXSJL
12	Relief type (with specially treated sliding parts)	CXSJL

11 — CXS J L 6 — 50 — M9B S

21 — CXS J L 6 — 50 — M9B S

Copper, fluorine and silicone-free + Low particle generation

21	Relief type	CXSJL
22	Vacuum suction type	CXSJL

Compact type

Bearing type

M	Slide Bearing
L	Ball bushing bearing

Number of auto switches

Nil	2 pcs.
S	1 pc.
n	n pcs.

Auto switch

Nil	Without auto switch (Built-in magnet)
-----	---------------------------------------

* Select the applicable auto switch from the table below.
* The minimum stroke for auto switch mounting and operating range are the same as standard products.

Bore size/Stroke (mm)

Bore size	Standard stroke
6	10, 20, 30, 40, 50
10	10, 20, 30, 40, 50

Auto Switch Specifications (Refer to the WEB catalog for detailed specifications and auto switches not in the following table.)

Type	Special function	Electrical entry	Indicator light	Wiring (Output)	Load voltage			Auto switch model		Lead wire length (m)*			Applicable load
					DC	AC	Electrical entry direction	0.5 Nil	3 (L)	5 (Z)			
Reed auto switch	—	Grommet	Yes	2-wire	24 V	12 V	100 V	In-line A93	●	●	—	—	Relay, PLC
Solid state auto switch	—	Grommet	Yes	3-wire (NPN)	24 V	12 V	—	M9N	●	●	—	—	Relay, PLC
				2-wire				M9B	●	●	—	—	

* Lead wire length symbols 0.5 m..... Nil (Example) A93 3 m..... L A93L Refer to page 889 for the applicable auto switch list. PLC: Programmable Logic Controller

Specifications

Bore size (mm)	6	10
Fluid	Air (Non-lube)	
Proof pressure	1.05 MPa	
Max. operating pressure	0.7 MPa	
Min. operating pressure	0.15 MPa	0.1 MPa
Ambient and fluid temperature	-10°C to 60°C (No freezing)	
Piston speed	30 to 400 mm/s	
Cushion	Rubber bumper	
Stroke adjustable range	0 to -5 mm compared to the standard stroke	
Port size	M3 x 0.5	M5 x 0.8
Grease	11-/12-: Fluorine grease 21-/22-: Lithium soap based grease	
Cleanliness class (ISO class)	12-: Class 4, 21-: Class 5 11-/22-: Class 3	

* The maximum piston speed shown in the table above applies to the extension side. The maximum piston speed for retraction is approximately 70% that of extension.

Suction Flow Rate of Vacuum Suction Type (Reference values)

Size	Suction flow rate L/min (ANR)
6	7
10	15

Directional Control Valves
Air Cylinders
Rotary Actuators
Air Grippers
Air Preparation Equipment
Modular F. R.
Pressure Control Equipment
Fittings & Tubing
Flow Control Equipment
Pressure Switches/Pressure Sensors

Auto Switch Proper Mounting Positions (Detection at Stroke End)

¹¹⁻12-CXSJ□6 / ²¹⁻22-CXSJ□6

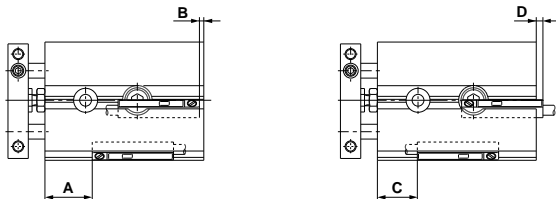

(mm)		
Symbol	D-A93	D-M9□
A	19 (20)	23 (24)
B ^{Note 1)}	—	2 (1)
C	14.5 (15.5)	13 (11.5)
D	6.5 (7.5)	8 (9)

Note 1) The above mentioned values are indicated as a guide for auto switch mounting positions for stroke end detection. When actually mounting an auto switch, adjust the position after confirming the operating state of the auto switch.

Note 2) For D-A93, only outward electrical entry (D dimension) is available.

Note 3) Dimensions in parentheses apply to 12-CXSJ□6.

¹¹⁻12-CXSJ□10 / ²¹⁻22-CXSJ□10

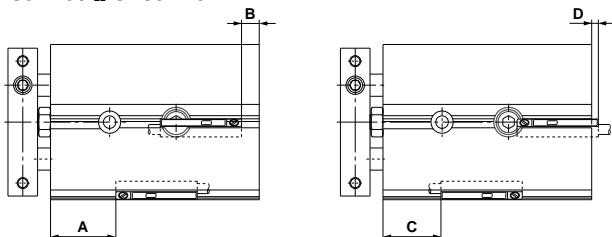

(mm)		
Symbol	D-A93	D-M9□
A	30 (31.5)	34 (35.5)
B ^{Note 1)}	—	3.5 (2)
C	25.5 (27)	24 (25.5)
D	5 (6.5)	6.5 (8)

Note 1) The above mentioned values are indicated as a guide for auto switch mounting positions for stroke end detection. When actually mounting an auto switch, adjust the position after confirming the operating state of the auto switch.

Note 2) For D-A93, only outward electrical entry (D dimension) is available.

Note 3) Dimensions in parentheses apply to 12-CXSJ□10.

Auto switch mounting dimensions

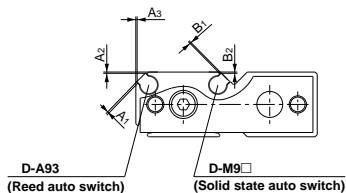

D-A93
(Reed auto switch)

D-M9□
(Solid state auto switch)

(mm)		
Auto switch model	Symbol	Bore size
		6, 10
D-A93	A1	0.4
	A2, A3	0.3
	B1	0.4
D-M9□	B2	0.3

! Specific Product Precautions

Be sure to read this before handling.

Mounting

Adjust the bolt holder with a hexagon wrench 3 mm in width across flats so that it does not protrude from the cylinder surface (approx. 0.5 mm depth from the cylinder surface to the top of the holder).

If the bolt holder is not properly adjusted, it can interfere with the switch rail, hindering the auto switch mounting.

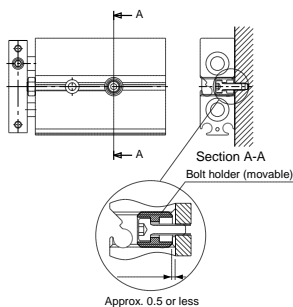

Dimensions: $\varnothing 6$

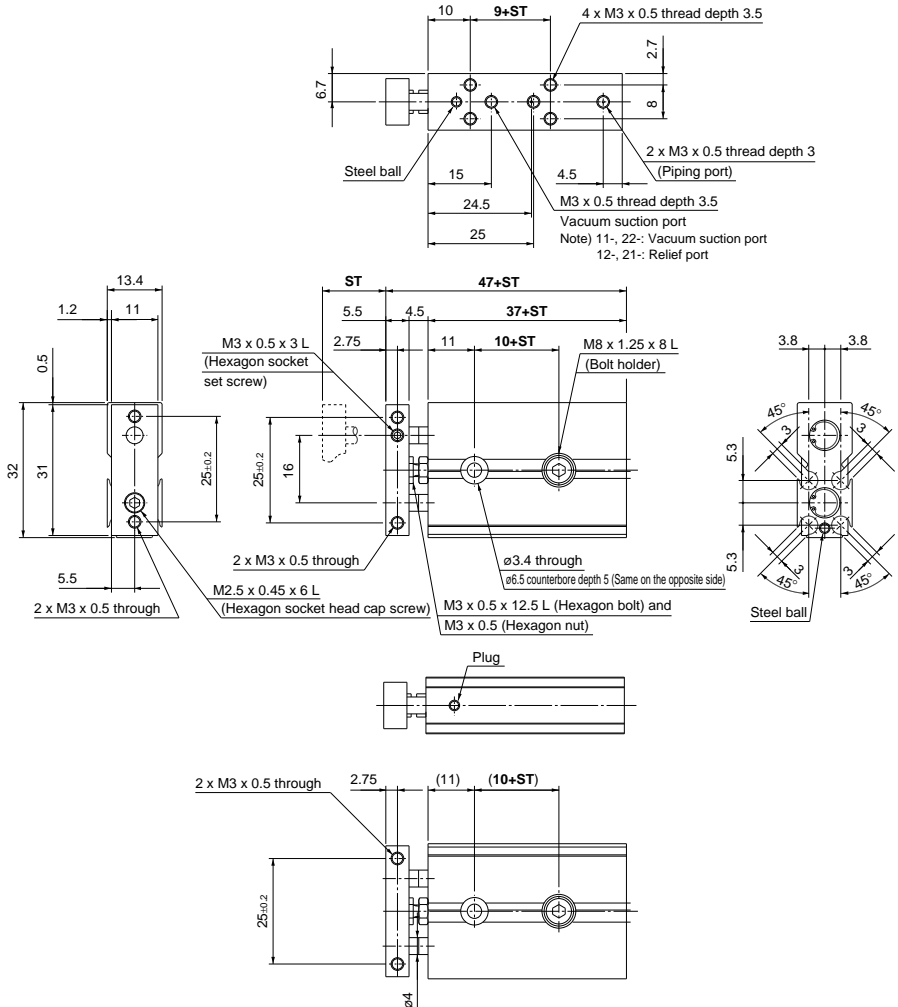

Part no.	ST	9+ST	10+ST	37+ST	47+ST
11-12-CXSJ□6-10	10	19	20	47	57
11-12-CXSJ□6-20	20	29	30	57	67
11-12-CXSJ□6-30	30	39	40	67	77
11-12-CXSJ□6-40	40	49	50	77	87
11-12-CXSJ□6-50	50	59	60	87	97

Dimensions: $\varnothing 10$

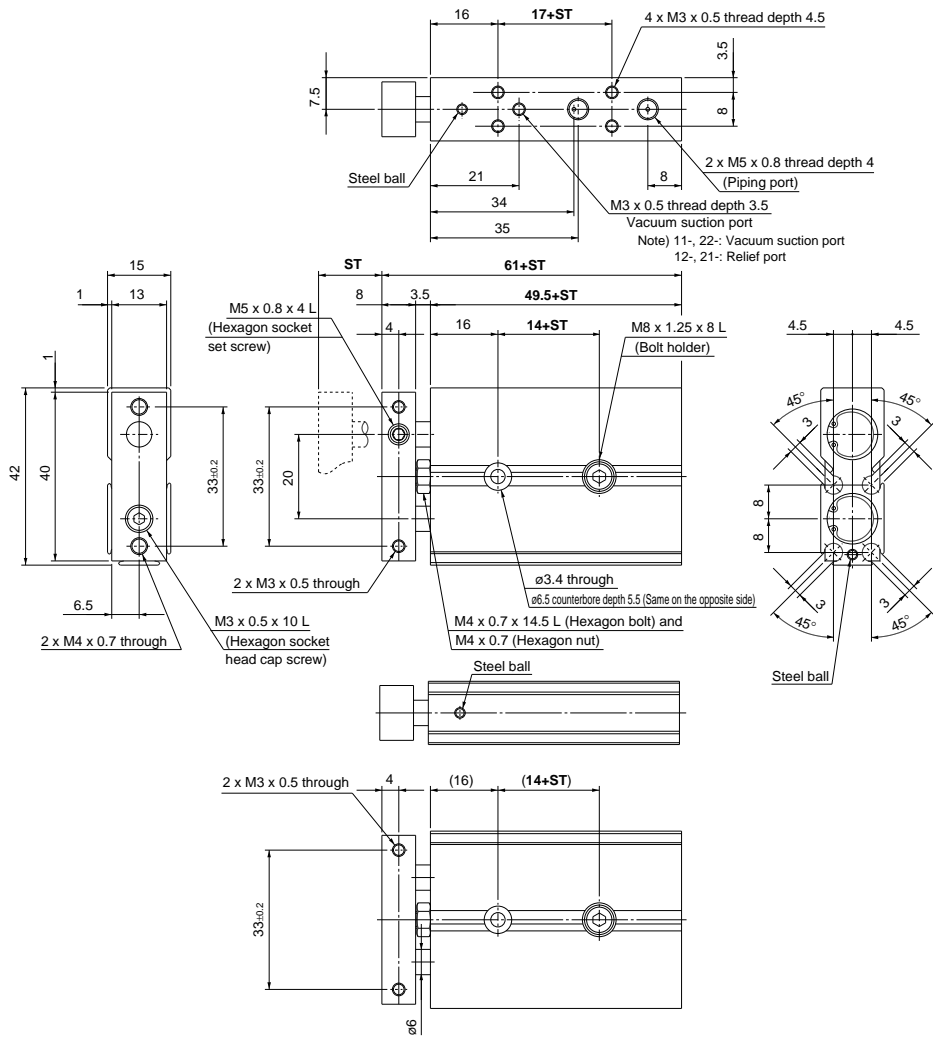

(mm)

Part no.	ST	14+ST	17+ST	49.5+ST	61+ST
CXSJ□10-10	10	24	27	59.5	71
CXSJ□10-20	20	34	37	69.5	81
CXSJ□10-30	30	44	47	79.5	91
CXSJ□10-40	40	54	57	89.5	101
CXSJ□10-50	50	64	67	99.5	111

Series 10-/11-/12-**CXS** 21-/22-**CXS** $\phi 6, \phi 10, \phi 15, \phi 20, \phi 25, \phi 32$ Dual Rod Cylinder

How to Order

● Clean series

10	Relief type	CXSM, CXSL
11	Vacuum suction type	CXSM, CXSL
12	Relief type (with specially treated sliding parts)	CXSL

● Dual rod cylinder

10 - CXS M 15 - 30 - Y59A

21 - CXS L 15 - 30 - Y59A

● Bearing type

L	Ball bushing bearing
M	Slide bearing

● Bore size (mm)

Symbol	Type	Bore size
Nil	M5 x 0.8	$\phi 6$ to $\phi 20$
	Rc	
TN	NPT	$\phi 25, \phi 32$
TF	G	

● Port type

● Number of auto switches

Nil	2 pcs.
S	1 pc.
n	n pcs.

● Auto switch

Reed switch	Z73
Solid state	Y59A, Y59B

* The minimum stroke for auto switch mounting and operating range are the same as standard products.

● Copper, fluorine and silicone-free + Low particle generation

21	Relief type	CXSL
22	Vacuum suction type	CXSL

● Cylinder stroke (mm)



Model

Model	Bore size (mm)	Port size	Lubrication	Action	Standard stroke (mm)	Auto switch mounting	Cushion		
							Rubber	Air	
Vacuum suction type	11-/22-CXS□6	6	M5 x 0.8	Non-lube	Double acting Single rod	10, 20, 30, 40, 50	○	○ (Both sides)	-
	11-/22-CXS□10	10							
	11-/22-CXS□15	15							
	11-/22-CXS□20	20							
	11-/22-CXS□25	25							
Relief type	11-/22-CXS□32	32	M5 x 0.8	Non-lube	Double acting Single rod	10, 20, 30, 40, 50, 75, 100	○	○ (Both sides)	-
	10-/12-/21-CXS□6	6							
	10-/12-/21-CXS□10	10							
	10-/12-/21-CXS□15	15							
	10-/12-/21-CXS□20	20							
	10-/12-/21-CXS□25	25							
	10-/12-/21-CXS□32	32							

Specifications

Item	Bore size (mm)	6	10/15	20/25/32
Proof pressure		1.05 MPa		
Maximum operating pressure		0.7 MPa		
Minimum operating pressure		0.15 MPa	0.1 MPa	0.05 MPa
Ambient and fluid temperature		-10 to 60°C (No freezing)		
Piston speed		30 to 400 mm/s		
Stroke adjustable range		0 to -5 mm compared to the standard stroke		
Bearing type		Ball bushing bearing/Slide bearing		
Grease		10-/11-/12-: Fluorine grease 21-/22-: Lithium soap based grease		
Cleanliness class (ISO class)		10-/12-: Class 4, 21-: Class 5 11-/22-: Class 3		

Suction Flow Rate of Vacuum Suction Type (Reference values)

Size	Suction flow rate L/min (ANR)
6	2
10	5
15	10
20/25	15
32	20

Auto Switch Specifications (Refer to the **WEB catalog** for detailed specifications and auto switches not in the following table.)

Type	Auto switch part no.	Load voltage	Load current range	Indicator light	Application
Reed auto switch	D-Z73	24 VDC, 100 VAC	5 to 40 mA, 5 to 20 mA	○	Relay, PLC
Solid state 2-wire auto switch	D-Y59B	24 VDC (10 to 28 V)	5 to 40 mA	○	24 VDC Relay, PLC
Solid state 3-wire auto switch	D-Y59A	28 VDC or less	40 mA or less	○	IC circuit, Relay, PLC

Refer to page 889 for the applicable auto switch list.

PLC: Programmable Logic Controller

Auto Switch Proper Mounting Position (Detection at Stroke End)

Electrical entry direction: Inward

Electrical entry direction: Outward

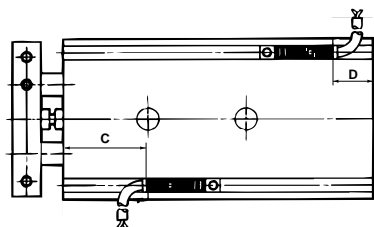
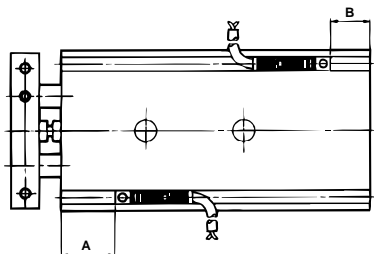

(mm)

Bore size	A	B	D-Z73		D-Y59A, D-Y59B	
			C	D	C	D
6	20.5	4.5	15	-1	16.5	0.5
10	27	8	21.5	2.5	23	4
15	38	4.5	32.5	-1	34	0.5
20	50	7	44.5	1.5	46	3
25	50.5	8.5	45	3.5	46.5	5
32	60	9	54.5	3.5	56	5

Note 1) The above mentioned values are indicated as a guide for auto switch mounting positions for stroke end detection. When actually mounting an auto switch, adjust the position after confirming the operating state of the auto switch.

Note 2) Lead wire entry is inward when the product is shipped.

Basic: ^{10/-11-}22-**CXS**□6, ^{12/-}21-**CXSL**6

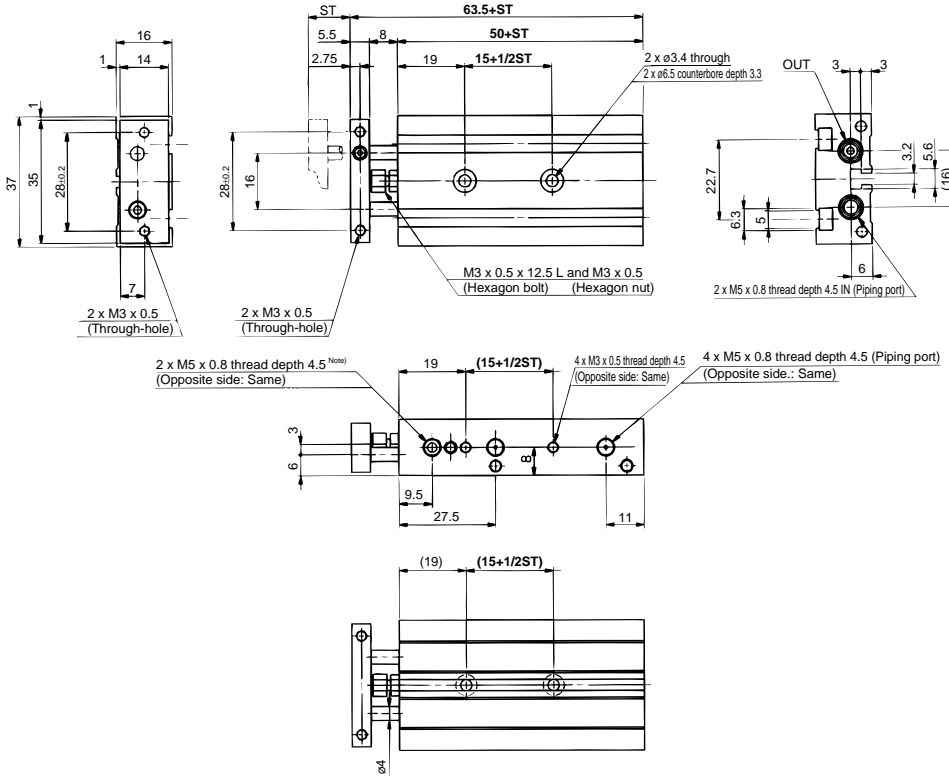

Note) 11-, 22-: Vacuum suction port Vacuum air from 2 ports on both sides.
 10/-12-, 21-: Relief port Exhaust air from a port on one side. The port on the piston rod B side for 10/-12-, 21- is plugged since unlike the vacuum, it is not necessary to exhaust from 2 ports.

Model	15+1/2ST	50+ST	63.5+ST
^{10/-11-} 21-22- CXS □6-10	20	60	73.5
^{10/-11-} 21-22- CXS □6-20	25	70	83.5
^{10/-11-} 21-22- CXS □6-30	30	80	93.5
^{10/-11-} 21-22- CXS □6-40	35	90	103.5
^{10/-11-} 21-22- CXS □6-50	40	100	113.5

Basic: 10-11-22: **CXS**□15, 12-21: **CXSL**15

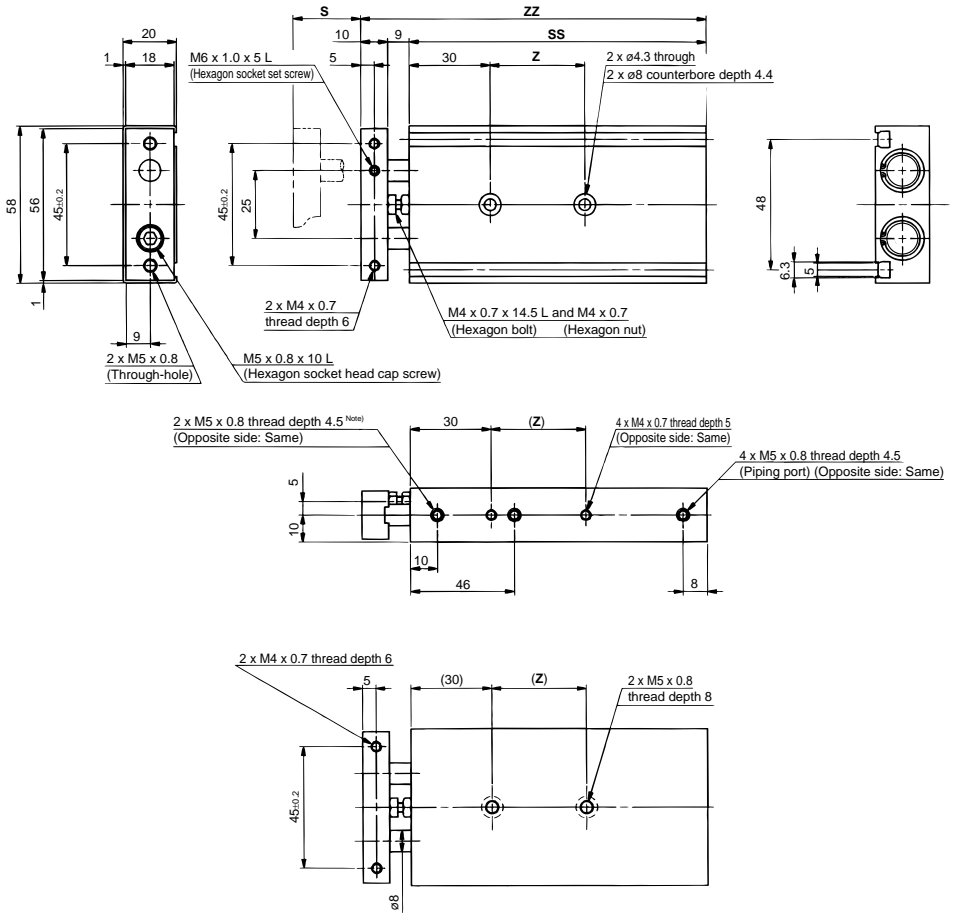

Note) 11-, 22-: Vacuum suction port Vacuum air from 2 ports on both sides.
 10-/12-, 21-: Relief port Exhaust air from a port on one side. The port on the piston rod B side for 10-/12-, 21- is plugged since unlike the vacuum, it is not necessary to exhaust from 2 ports.

Model	S	SS	ZZ	Z	(mm)
10-11-12-21-22: CXS □15-10	10	77.5	96.5	25	
10-11-12-21-22: CXS □15-20	20	87.5	106.5	25	
10-11-12-21-22: CXS □15-30	30	97.5	116.5	35	
10-11-12-21-22: CXS □15-40	40	107.5	126.5	35	
10-11-12-21-22: CXS □15-50	50	117.5	136.5	45	

Directional Control Valves
 Air Cylinders
 Rotary Actuators
 Air Grippers
 Air Preparation Equipment
 Modular F. R.
 Pressure Control Equipment
 Fittings & Tubing
 Flow Control Equipment
 Pressure Switches/ Pressure Sensors

Basic: 10-11-22: CXS□25, 12-21: CXSL25

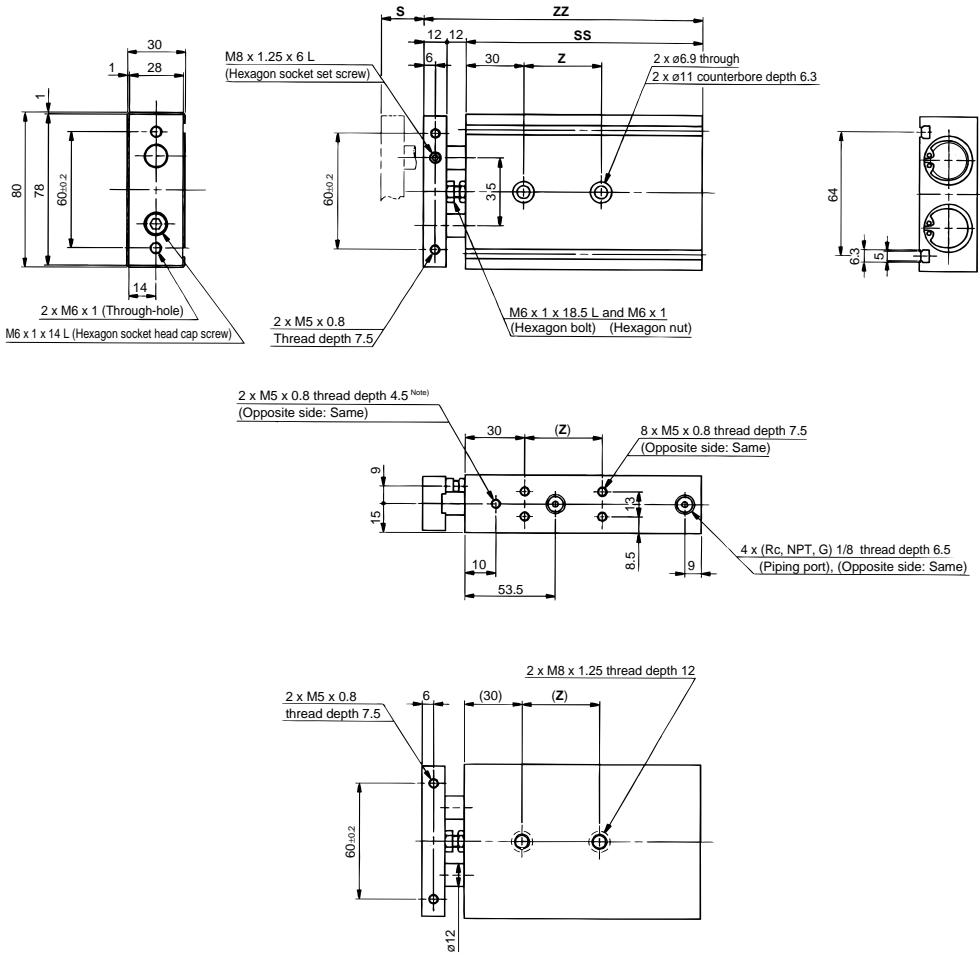

Note) 11-, 22-: Vacuum suction port Vacuum air from 2 ports on both sides.
 10-/12-, 21-: Relief port Exhaust air from a port on one side. The port on the piston rod B side for 10-/12-, 21- is plugged since unlike the vacuum, it is not necessary to exhaust from 2 ports.

Model	S	SS	ZZ	Z
10-11-22: CXS□25-10	10	94	118	30
10-11-21-22: CXS□25-20	20	104	128	40
10-11-21-30: CXS□25-30	30	114	138	40
10-11-21-40: CXS□25-40	40	124	148	40
10-11-21-50: CXS□25-50	50	134	158	60
10-11-21-75: CXS□25-75	75	159	183	60
10-11-21-100: CXS□25-100	100	184	208	80

(mm)

Dual Rod Cylinder ^{10-/11-}22-CXS□ / ¹²⁻21-CXSL

Basic: ^{10-/11-}22-CXS□32, ¹²⁻21-CXSL32

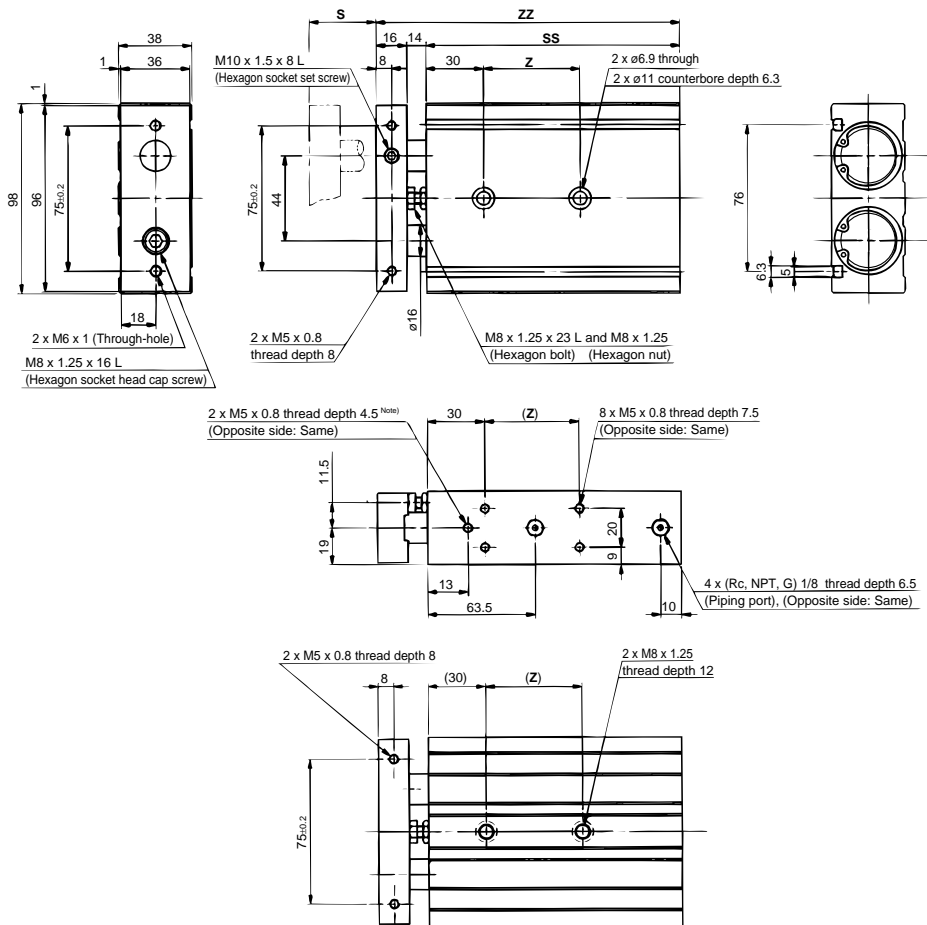

Note) 11-, 22-: Vacuum suction port. Vacuum air from 2 ports on both sides.
 10-/12-, 21-: Relief port. Exhaust air from a port on one side. The port on the piston rod B side for 10-/12-, 21- is plugged since unlike the vacuum, it is not necessary to exhaust from 2 ports.

(mm)

Model	S	SS	ZZ	Z
¹⁰⁻ 11-22-CXS□32-10	10	104	134	40
¹⁰⁻ 11-22-CXS□32-20	20	114	144	50
¹⁰⁻ 11-22-CXS□32-30	30	124	154	50
¹⁰⁻ 11-22-CXS□32-40	40	134	164	50
¹⁰⁻ 11-22-CXS□32-50	50	144	174	60
¹⁰⁻ 11-22-CXS□32-75	75	169	199	70
¹⁰⁻ 11-22-CXS□32-100	100	194	224	90

⚠ Specific Product Precautions

Be sure to read this before handling.

Mounting

⚠ Caution

- Make sure that the surface on which the cylinder is to be mounted is flat (reference value for flatness: 0.05 or less).**
Dual rod cylinders can be mounted from 3 directions, however, make sure that the surface on which the cylinder is to be mounted is flat (reference value for flatness: 0.05 or less). Otherwise, the accuracy of the piston rod operation is not achieved, and malfunction may occur.
- The piston rod must be retracted when mounting the cylinder.**
Scratches or gouges in the piston rod may lead to damaged bearings and seals, and causes malfunction or air leakage.
- Secure the plate before mounting the load.**
Load mounting without securing the plate may cause galling of the piston rod, leading to particle generation.

Piping

⚠ Caution

- Plug the appropriate supply port(s) according to the operating state.**
Dual rod cylinders have 2 supply ports for each operating direction (3 supply ports for ø6 only). Plug the appropriate supply port according to the operating state. After the plugged port has been changed, check the port for air leakage. If small leakage is detected, unplug the port, check the seat surface, and reassemble it.
- For 12- relief port, change the plug position according to the operating state.**
A relief port is provided on each side. Change the plug position according to the operating state. After the change, apply 0.1 MPa pressure from the relief port to check the plugged portion for air leakage. If small leakage is detected, unplug the port, check the seat surface, and reassemble it.
- Vacuum air from vacuum ports on both sides of 11- and 22-.**
Vacuum from one side is insufficient. Be sure to vacuum simultaneously from both sides.

Stroke Adjustment

⚠ Caution

- After adjusting the stroke, tighten firmly the hexagon nut to prevent it from loosening.**
Dual rod cylinders have a bolt to adjust 0 to -5 mm strokes on the retracted end (IN).
Loosen the hexagon nut to adjust the stroke. However, make sure to tighten the hexagon nut after making an adjustment.
- Do not operate a cylinder with its bumper bolt removed.**
If the bumper bolt is removed, the piston hits the head cover, causing damage to the cylinder. Therefore, do not use a cylinder without a bumper bolt.
- A bumper at the end of the bumper bolt is replaceable. In case a missing bumper, or a bumper has a permanent setting, use the following part numbers for ordering.**

Model	CXS6/10/15	CXS20/25	CXS32
Part number	CXS10-34A 28747	CXS20-34A 28749	CXS32-34A 28751
No. of bumpers	1		

Disassembly and Maintenance

⚠ Caution

- Never use a cylinder with its plate removed.**
When removing the hexagon socket head cap screw from the end plate, the piston rod must be secured to prevent rotation. However, if the sliding parts of the piston rod are scratched or gouged, malfunction may occur. If a plate is not required for your applications, use the cylinder that does not come with a plate, available through Made to Order (-X593).
- When disassembling and reassembling the cylinder, contact SMC or refer to the separate operation manual.**

⚠ Warning

- Take precautions when your hands are near the plate and housing.**
During cylinder operation, be careful not to get your hand or fingers caught between the plate and housing.

Directional Control Valves

Air Cylinders

Rotary Actuators

Air Grippers

Air Preparation Equipment

Modular F. R.

Pressure Control Equipment

Fittings & Tubing

Flow Control Equipment

Pressure Switches/ Pressure Sensors

Series 12-REA

∅25, ∅32, ∅40, ∅50, ∅63
Sine Rodless Cylinder

How to Order



● Clean series
12 — Special treatment on sliding part

● Bore size (mm)

12 - REA 25 - 300

● Cylinder stroke (mm)

● Port type

Symbol	Type
Nil	Rc
TN	NPT
TF	G

Model

Model	Bore size (mm)	Port size	Lubrication	Standard stroke (mm)	Maximum manufacturable stroke (mm)
12-REA25	25	Rc1/8	Non-lube	200, 250, 300, 350, 400, 450, 500, 600, 700, 800	1300
12-REA32	32	NPT1/8 G1/8			
12-REA40	40	Rc1/4		200, 250, 300, 350, 400, 450, 500, 600, 700, 800, 900, 1000	
12-REA50	50	NPT1/4			
12-REA63	63	G1/4			

Note 1) Stroke exceeding the standard stroke but below the maximum manufacturable stroke is available as special orders.

Note 2) Intermediate stroke is available in 1 mm increments.

Note 3) Please contact SMC if the maximum manufacturable stroke is exceeded.

Specifications

Item	Bore size (mm)	25/32/40/50/63
Proof pressure		1.05 MPa
Maximum operating pressure		0.7 MPa
Minimum operating pressure		0.18 MPa
Ambient and fluid temperature		-10 to 60°C (With no freezing)
Piston speed		50 to 300 mm/s
Stroke length tolerance		0 to 250 st: $^{+1.0}_0$, 251 to 1000 st: $^{+1.4}_0$, Over 1001 st: $^{+1.8}_0$
Grease		Fluorine grease
Cleanliness class (ISO class)		Class 5

Magnetic Holding Force

Bore size (mm)	25	32	40	50	63
Holding force (N)	363	588	922	1471	2256

Dimensions

12-REA 25 to 40

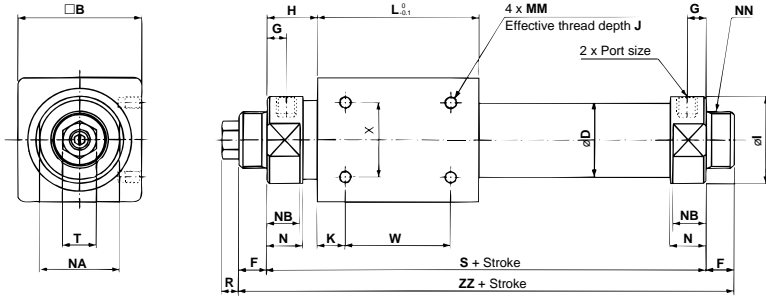

Model	Port size	B	D	F	G	H	I	K	L	MM x J	N	NA	NB	NN	S	W	X	ZZ	R	T
12-REA25	Rc, NPT, G 1/8	46	27.8	13	8	20.5	34	10	70	M5 x 0.8 x 8	15	30	13	M26 x 1.5	111	50	30	137	8	17
12-REA32	Rc, NPT, G 1/8	60	35	16	9	22	40	15	80	M6 x 1.0 x 8	17	36	15	M26 x 1.5	124	50	40	156	8	17
12-REA40	Rc, NPT, G 1/4	70	43	16	11	29	50	16	92	M6 x 1.0 x 10	21	46	19	M32 x 2.0	150	60	40	182	10	19

12-REA 50/63

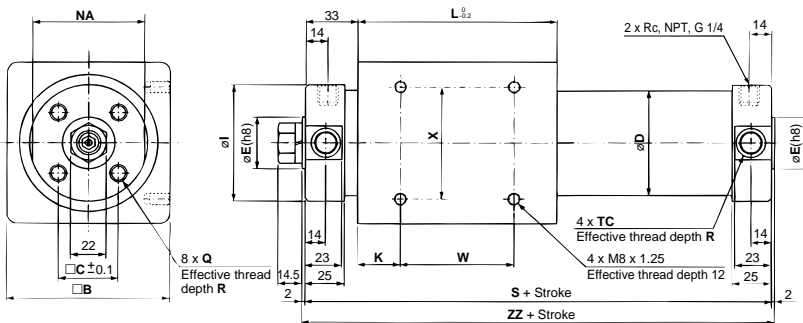

Model	B	C	D	E	I	K	L	NA	Q x R	S	TC x R	W	X	ZZ
12-REA50	86	32	53	30 ⁰ _{0.033}	58.2	25	110	55	M8 x 1.25 x 16	176	M12 x 1.25 x 7.5	60	60	180
12-REA63	100	38	66	32 ⁰ _{0.039}	72.2	26	122	69	M10 x 1.5 x 16	188	M14 x 1.5 x 11.5	70	70	192

Directional Control Valves
 Air Cylinders
 Rotary Actuators
 Air Grippers
 Air Preparation Equipment
 Modular F. R.
 Pressure Control Equipment
 Fittings & Tubing
 Flow Control Equipment
 Pressure Switches/ Pressure Sensors

⚠ Specific Product Precautions

Be sure to read this before handling.

Handling

⚠ Caution

1. **Use caution to the rotation of the external slider.**
Rotation should be controlled by connecting the external slider to another shaft (linear guide, etc.).
2. **Do not operate with the magnetic coupling out of position.**
If the magnetic coupling is out of position, push the external slider by hand (or the piston slider with air pressure) back to the proper position at the stroke end.
3. **Do not apply a lateral load to the external slider.**
When a load is mounted directly to the cylinder, variations in the alignment of each shaft center cannot be offset, which results in the generation of a lateral load that can cause malfunction. The cylinder should be operated using a connection method which allows for shaft alignment variations and deflection due to the cylinder's own weight. A drawing of a recommended mounting method is shown in Fig. 1.

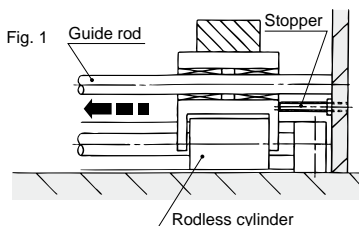

4. **When used vertically for applications, use caution regarding allowable load.**
When used vertically for applications, use caution as there is a possibility of dropping due to separation of the magnetic coupling if a load greater than the allowable value is added. Please contact SMC for the operating conditions (pressure, load, speed, stroke, frequency, etc.) before use.
5. **Do not scratch or gouge the external surface of the cylinder.**
It can damage the wear ring, increase particle generation and cause malfunction.
6. **Do not use the cylinder with its body fixed.**
Be sure to secure both head covers before using the cylinder. Operation of the cylinder with its body fixed will damage the wear ring, resulting in increase of particle generation or malfunction.

Disassembly and Maintenance

⚠ Warning

1. **Do not disassemble the product because it may damage the air cushion mechanism.**
Contact SMC when disassembly or maintenance is necessary.

Adjustment

⚠ Caution

1. **Stroke adjustment is provided for position adjustment.**
This mechanism is not intended for adjustment of the cushion effect (smooth start-up, soft stop). This mechanism is for matching of the cylinder's stroke end position to the mechanical stopper, etc., of a machine.
2. **Stroke adjustment should be conducted with no pressure supply.**
To ensure safety, stroke adjustment should be conducted with no pressure supply. Before adjustment is performed, shut off the drive air, release any residual pressure and implement measures to prevent dropping of workpieces, etc. Adjustment procedure is shown below.
 - 1) Insert a wrench into the hexagon hole of the adjustment screw to loosen lock nut A.
 - 2) Rotate the adjustment screw to right and left and move the cushion ring holder (stroke end) forward and backward to align the position with that of the external stopper.
 - 3) After the stroke end adjustment is completed, retighten lock nut A.

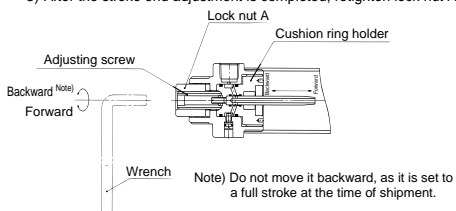

•Adjusting screw width across flats		•Lock nut A tightening torque	
Model	Width across flats (mm)	Model	Tightening torque (N·m)
12-REA25	5	12-REA25	1.2
12-REA32	5	12-REA32	1.2
12-REA40	6	12-REA40	2.1
12-REA50	8	12-REA50	3.4
12-REA63	8	12-REA63	3.4

3. **Throttle type speed controllers are recommended for speed adjustment, as shown in the table below.**

•Recommended speed controller

Model	Model		
	Elbow type	Straight type	In-line type
12-REA25	10-AS2201F-01-06-X214	10-AS2301F-01-06-X214	10-AS2001F-06-X214
12-REA32	10-AS2201F-02-06-X214	10-AS2301F-02-06-X214	10-AS2001F-06-X214
12-REA40	10-AS2201F-02-06-X214	10-AS2301F-02-06-X214	10-AS2001F-06-X214
12-REA50	10-AS3201F-02-08-X214	10-AS3301F-02-08-X214	10-AS3001F-08-X214
12-REA63	10-AS3201F-02-08-X214	10-AS3301F-02-08-X214	10-AS3001F-08-X214

Although speed adjustment is possible with meter-in and meter-out speed controllers, smooth start-up and soft stop may not be achieved.

In case the mounting orientation is not horizontal, a system with a pressure regulating circuit on the lower side is recommended. (It is also effective to shorten start-up delay in rising and for air conservation.)

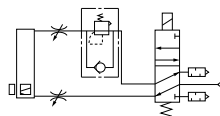

Lower-side reduced pressure supply circuit

4. **Cushion adjustment is not necessary.**
The fixed cushion mechanism does not require the conventional cushion adjustment.

Series 10-11-REC

ø20, ø25, ø32, ø40
Sine Cylinder

How to Order



10 - R E C L 25 **150** **M9BW** **C**

● **Mounting**

B	Basic
L	Axial foot
F	Rod flange
G	Head flange

● **Clean series**

10	Relief type
11	Vacuum suction type

Bore size (mm)

● **Port type**

Nil	Rc
TN	NPT
TF	G

Cylinder stroke (mm)

● **Number of auto switches**

Nil	2 pcs.
S	1 pc.
n	n pcs.

● **Auto switch**

Nil	Without auto switch (Built-in magnet)
-----	---------------------------------------

* The minimum stroke for auto switch mounting, operating range and auto switch mounting brackets/part no. are the same as standard products.

● **Auto switch mounting bracket** (Note)

(Note) This symbol is indicated when the D-A9□ or M9□ type auto switch is specified. This mounting bracket does not apply to other auto switches (D-C7□ and H7□, etc.) (Nil)

Model

	Model	Bore size (mm)	Port size	Lubrication	Action	Standard stroke (mm)	Auto switch mounting	Cushion	Effective cushioning stroke (mm)		
Relief type	10-REC□20	20	1/8	Non-lube	Double acting Single rod	150 to 700	○	Air cushion (Both sides)	45		
	10-REC□25	25								150 to 1000	50
	10-REC□32	32									
10-REC□40	40	1/4	150 to 700			45					
Vacuum suction type	11-REC□20	20							1/8	150 to 1000	50
	11-REC□25	25									
	11-REC□32	32	150 to 700	45							
	11-REC□40	40			1/4	150 to 1000	50				
				200 to 1000	60						

Specifications

Item	Bore size (mm)	20/25/32/40
Proof pressure		1.5 MPa
Maximum operating pressure		1.0 MPa
Minimum operating pressure		0.2 MPa
Ambient and fluid temperature		-10°C to 60°C (With no freezing)
Piston speed		50 to 400 mm/s
Cushion		Air cushion
Stroke length tolerance		Up to 250 ST: $+^{1.0}_0$, 251 to 1000 ST: $+^{1.4}_0$
Mounting		Basic/Axial foot/Rod flange/Head flange
Grease		Fluorine grease
Cleanliness class (ISO class)		10-: Class 4 11-: Class 3

Suction Flow Rate of Vacuum Suction Type (Reference values)

Size	Suction flow rate L/min (ANR)
20	1
25/32/40	2

Auto Switch Specifications (Refer to the WEB catalog for detailed specifications and auto switches not in the following table.)

Type	Electrical entry	Indicator light	Wiring (Output)	Load voltage		Auto switch model	Lead wire length (m)				Applicable load		
				DC	AC		Band mounting	0.5 (Nil)	1 (M)	3 (L)		5 (Z)	
Solid state auto switch	Grommet	Yes	2-wire	24 V	5 V 12 V	—	M9B	●	●	●	○	—	Relay, PLC
				24 V	12 V		100 V	M9BW	●	●	●		
Reed auto switch	Grommet	Yes	2-wire	24 V	12 V	100 V	A93	●	—	●	●	—	—

Note 1) Lead wire length symbols: 0.5 m Nil
 1 m M
 3 m L
 5 m Z
 M9BW
 M9BWM
 M9BWL
 M9BWZ

Note 2) Auto switches marked with "○" are produced upon receipt of order.
 Note 3) PLC: Programmable Logic Controller

Refer to page 889 for the applicable auto switch list.

Auto Switch Proper Mounting Position (Detection at Stroke End)

Solid state auto switch

D-M9□
 D-M9□W

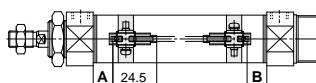

A and B are the dimensions from the end of the head cover/rod cover to the end of the auto switch.

Reed auto switch

D-A9□

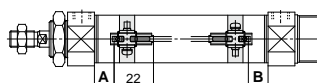

A and B are the dimensions from the end of the head cover/rod cover to the end of the auto switch.

Auto Switch Proper Mounting Position (mm)

Auto switch model	D-M9□ D-M9□W		D-A9□	
	A	B	A	B
20	59.5	34	55.5	30.5
25	59.5	34	55.5	30.5
32	63	40	59	36
40	73.5	42.5	69.5	38.5

Note) The above values are a guide in the stroke end detection of the mounting positions of the auto switch. Please adjust in an actual setting after confirming the operating state of the auto switch.

Auto Switch Mounting Height (mm)

Auto switch model	D-M9□ D-M9□W D-A9□	
	Hs	
20	24.5	
25	27	
32	30.5	
40	35	

! Specific Product Precautions

Be sure to read this before handling.

Speed Adjustment

! Caution

- The 10-AS series throttle type speed controllers are recommended for speed adjustment.

Recommended speed controllers

Model	Model		
	Elbow type	Straight type	In-line type
¹⁰⁻ REC20	10-AS2201F-01-06-X214	10-AS2301F-01-06-X214	10-AS2001F-06-X214
¹⁰⁻ REC25	10-AS2201F-01-06-X214	10-AS2301F-01-06-X214	10-AS2001F-06-X214
¹⁰⁻ REC32	10-AS2201F-01-06-X214	10-AS2301F-01-06-X214	10-AS3001F-08-X214
¹⁰⁻ REC40	10-AS3201F-02-08-X214	10-AS3301F-02-08-X214	10-AS3001F-08-X214

- Speed control is possible with meter-in and meter-out types of speed controllers. However, smooth acceleration and deceleration may not be obtained by these speed controllers.
- For installation other than horizontal mounting, it is recommended to use a system with reduced pressure supply circuit on the downward side. (This system is also effective for a start delay at rise and air reduction.)

Cushion Adjustment

! Caution

- Cushion adjustment mechanism is not provided. Cushion adjustment is not necessary because the model can perform smooth acceleration and deceleration in a wide range of strokes without an adjusting cushion.

Relief Port

! Caution

- Hexagon socket set screw is not prepared for clean room specifications, and use it as relief port accordingly.

Dimensions

Basic (B): 10-11.RECB

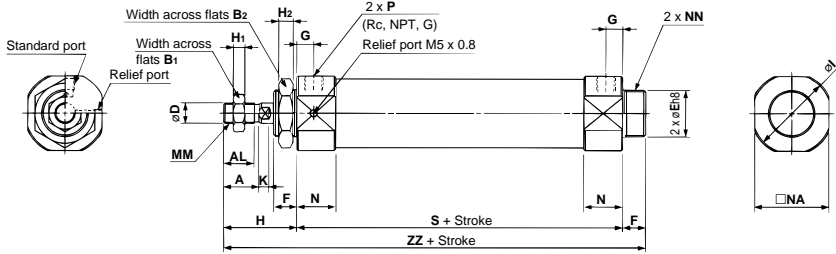

Bore size	Stroke range	A	AL	B ₁	B ₂	D	E	F	G	H	H ₁	H ₂	I	K	MM	N	NA	NN	P	S	ZZ
20	150 to 700	18	15.5	13	26	8	20 ^{0-0.033}	13	10	41	5	8	33.5	5	M8 x 1.25	20	30	M20 x 1.5	1/8	146	200
25	150 to 700	22	19.5	17	32	10	26 ^{0-0.033}	13	10	45	6	8	37.5	5.5	M10 x 1.25	20	34.5	M26 x 1.5	1/8	146	204
32	150 to 1000	22	19.5	17	32	12	26 ^{0-0.033}	13	11	45	6	8	46.5	5.5	M10 x 1.25	22	42.5	M26 x 1.5	1/8	159	217
40	200 to 1000	24	21	22	41	14	32 ^{0-0.039}	16	12.5	50	8	10	56.2	7	M14 x 1.5	26.5	51	M32 x 2	1/4	181	247

Axial foot (L): 10-11.RECL

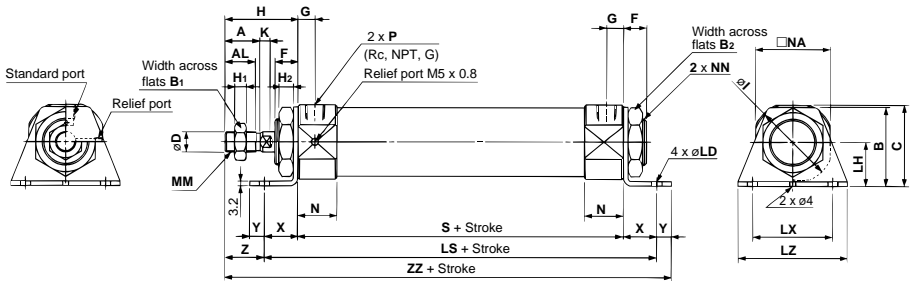

Bore size	Stroke range	A	AL	B	B ₁	B ₂	C	D	F	G	H	H ₁	H ₂	I	K	LD	LH	LS	LX	LZ	MM	N	NA
20	150 to 700	18	15.5	40	13	26	40	8	13	10	41	5	8	33.5	5	6.8	25	186	40	55	M8 x 1.25	20	30
25	150 to 700	22	19.5	47	17	32	45.5	10	13	10	45	6	8	37.5	5.5	6.8	28	186	40	55	M10 x 1.25	20	34.5
32	150 to 1000	22	19.5	47	17	32	49.5	12	13	11	45	6	8	46.5	5.5	6.8	28	199	40	55	M10 x 1.25	22	42.5
40	200 to 1000	24	21	54	22	41	55.5	14	16	12.5	50	8	10	56.2	7	7	30	227	55	75	M14 x 1.5	26.5	51

Bore size	Stroke range	NN	P	S	X	Y	Z	ZZ
20	150 to 700	M20 x 1.5	1/8	146	20	8	21	215
25	150 to 700	M26 x 1.5	1/8	146	20	8	25	219
32	150 to 1000	M26 x 1.5	1/8	159	20	8	25	232
40	200 to 1000	M32 x 2	1/4	181	23	10	27	264

Directional Control Valves
Air Cylinders
Rotary Actuators
Air Grippers
Air Preparation Equipment
Modular F. R.
Pressure Control Equipment
Fittings & Tubing
Flow Control Equipment
Pressure Switches/ Pressure Sensors

Sine Cylinder $\frac{10}{11}$ -REC

Rod flange (F): $\frac{10}{11}$ -REC F

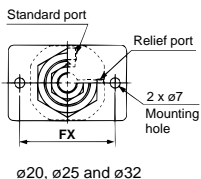
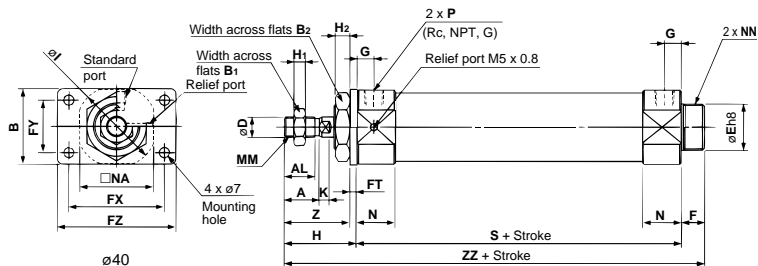

Bore size	Stroke range	A	AL	B	B ₁	B ₂	D	E	F	FT	FX	FY	FZ	G	H
20	150 to 700	18	15.5	34	13	26	8	20 ^{0.033} ₀	13	4	60	—	75	10	41
25	150 to 700	22	19.5	40	17	32	10	26 ^{0.033} ₀	13	4	60	—	75	10	45
32	150 to 1000	22	19.5	40	17	32	12	26 ^{0.033} ₀	13	4	60	—	75	11	45
40	200 to 1000	24	21	52	22	41	14	32 ^{0.039} ₀	16	5	66	36	82	12.5	50

Bore size	Stroke range	H ₁	H ₂	I	K	MM	N	NA	NN	P	S	Z	ZZ
20	150 to 700	5	8	33.5	5	M8 x 1.25	20	30	M20 x 1.5	1/8	146	37	200
25	150 to 700	6	8	37.5	5.5	M10 x 1.25	20	34.5	M26 x 1.5	1/8	146	41	204
32	150 to 1000	6	8	46.5	5.5	M10 x 1.25	22	42.5	M26 x 1.5	1/8	159	41	217
40	200 to 1000	8	10	56.2	7	M14 x 1.5	26.5	51	M32 x 2	1/4	181	45	247

Head flange (G): $\frac{10}{11}$ -REC G

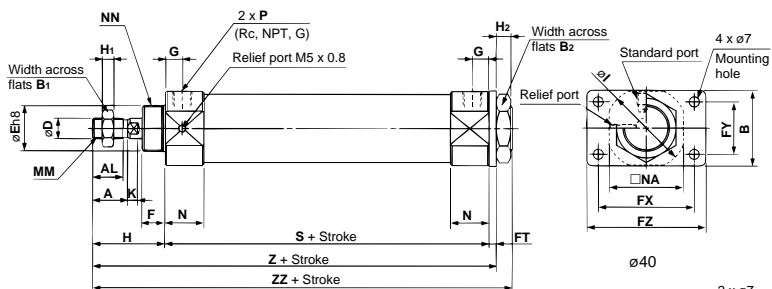

Bore size	Stroke range	A	AL	B	B ₁	B ₂	D	E	F	FT	FX	FY	FZ	G	H
20	150 to 700	18	15.5	34	13	26	8	20 ^{0.033} ₀	13	4	60	—	75	10	41
25	150 to 700	22	19.5	40	17	32	10	26 ^{0.033} ₀	13	4	60	—	75	10	45
32	150 to 1000	22	19.5	40	17	32	12	26 ^{0.033} ₀	13	4	60	—	75	11	45
40	200 to 1000	24	21	52	22	41	14	32 ^{0.039} ₀	16	5	66	36	82	12.5	50

Bore size	Stroke range	H ₁	H ₂	I	K	MM	N	NA	NN	P	S	Z	ZZ
20	150 to 700	5	8	33.5	5	M8 x 1.25	20	30	M20 x 1.5	1/8	146	191	200
25	150 to 700	6	8	37.5	5.5	M10 x 1.25	20	34.5	M26 x 1.5	1/8	146	195	204
32	150 to 1000	6	8	46.5	5.5	M10 x 1.25	22	42.5	M26 x 1.5	1/8	159	208	217
40	200 to 1000	8	10	56.2	7	M14 x 1.5	26.5	51	M32 x 2	1/4	181	236	247

Series 10-11-CM2X-Z

ø20, ø25, ø32, ø40 Low Speed Cylinder
Double Acting, Single Rod

How to Order

Clean series

10	Relief type
11	Vacuum suction type

Built-in magnet

Nil	No
D	With auto switch (Built-in magnet)

Low speed cylinder

Mounting

B	Basic (Double-side bossed)
L	Axial foot
F	Rod flange
G	Head flange
BZ	Boss-cut, Basic
FZ	Boss-cut, Rod flange

Bore size (mm)

Port thread type

Nil	Rc
TN	NPT*
TF	G*

* Rubber bumper only

Cylinder stroke (mm)

Auto switch

Nil	Without auto switch
-----	---------------------

* For applicable auto switches, refer to the "Applicable Auto Switch List".
* The minimum stroke for auto switch mounting, operating range and auto switch mounting brackets/part no. are the same as standard products.

Number of auto switches

Nil	2 pcs.
S	1 pc.
n	n pcs.

Rod end thread

Nil	Male rod end
F	Female rod end

Model

Model		Bore size (mm)	Port size	Lubrication	Action	Standard stroke (mm)	Auto switch mounting	Cushion Rubber
Vacuum suction type	10-CM2X□20	20	1/8	Non-lube	Double acting, Single Rod	25, 50, 75, 100, 125, 150, 200, 250, 300	○	○
	10-CM2X□25	25						
	10-CM2X□32	32						
	10-CM2X□40	40						
Relief type	11-CM2X□20	20	1/4	Non-lube	Double acting, Single Rod	25, 50, 75, 100, 125, 150, 200, 250, 300	○	○
	11-CM2X□25	25						
	11-CM2X□32	32						
	11-CM2X□40	40						

Specifications

Item	Bore size (mm)	20/25/32/40
Proof pressure		1.5 MPa
Maximum operating pressure		1.0 MPa
Minimum operating pressure		0.05 MPa
Ambient and fluid temperature		Without auto switch: -10°C to 70°C With auto switch: -10°C to 60°C (No freezing)
Piston speed		30 to 400 mm/s
Stroke length tolerance		$^{+1.4}$ 0
Mounting		Basic/Axial foot/Rod flange/Head flange
Grease		Fluorine grease
Cleanliness class (ISO class)		10-: Class 4
		11-: Class 3

Dimensions and applicable auto switches are the same as 10-/11-CM2-Z.
Refer to pages 701 to 707.

Suction Flow Rate of Vacuum Suction Type (Reference values)

Bore size (mm)	Suction flow rate L/min (ANR)
20/25/32/40	2

Specific Product Precautions

Be sure to read this before handling.

Handling

Warning

1. Do not rotate the cover.

If a cover is rotated when installing a cylinder or screwing a fitting into the port, it is likely to damage the junction part with cover.

Caution

1. Use caution to the popping of a retaining ring.

When replacing rod seals and removing and mounting a retaining ring, be much careful with the popping of a retaining ring.

Maintenance

Caution

1. Grease pack

When maintenance requires only grease, use the following part number to order.

Grease pack part no.: GR-X-005 (5 g)

Series 10-11-CQSX $\varnothing 12, \varnothing 16, \varnothing 20, \varnothing 25$ Low Speed Cylinder

How to Order

Clean series

10	Relief type
11	Vacuum suction type

10-C D QSX B 20 30 D M9B

Built-in magnet

Nil	No
D	With auto switch (Built-in magnet)

Low speed cylinder

Mounting

B	Through-hole/Both ends tapped (Standard)
---	--

Bore size

12	12 mm
16	16 mm
20	20 mm
25	25 mm

Cylinder stroke (mm)

Bore size (mm)	Standard stroke (mm)
12, 16	5, 10, 15, 20, 25, 30
20	5, 10, 15, 20, 25, 30, 35, 40, 45, 50
25	

*Manufacturing of intermediate strokes
Intermediate strokes in 1 mm increments are available by using spacers with standard stroke cylinders. The overall length of cylinder is the same as a standard stroke one size longer than this intermediate stroke.

Example) 10-CQSB25-47D: Install a 3 mm width spacer in a standard stroke cylinder 10-CQSB25-50D.

Number of auto switches

Nil	2 pcs.
S	1 pc.
n	n pcs.

Auto switch

Reed switch	A93
Solid state	F9B, F91

* The minimum stroke for auto switch mounting and operating range are the same as standard products.

Rod end thread

Nil	Standard (Rod end female thread)
M	Rod end male thread

Action

D	Double acting
---	---------------



Model

	Model	Bore size (mm)	Port size	Lubrication	Action	Standard stroke (mm)	Auto switch mounting	Cushion	
								Rubber	Air
Relief type	10-CQSB12	12	M5 x 0.8	Non-lube	Double acting Single rod	5, 10, 15, 20, 25, 30	○	-	-
	10-CQSB16	16							
	10-CQSB20	20							
	10-CQSB25	25							
Vacuum suction type	11-CQSB12	12	M5 x 0.8	Non-lube	Double acting Single rod	5, 10, 15, 20, 25, 30, 35, 40, 45, 50	○	-	-
	11-CQSB16	16							
	11-CQSB20	20							
	11-CQSB25	25							

Specifications

Bore size (mm)	10- (Relief type)			
	12	16	20	25
Fluid	Air			
Proof pressure	1.5 MPa			
Maximum operating pressure	1.0 MPa			
Minimum operating pressure	0.04 MPa		0.035 MPa	
Ambient and fluid temperature	Without auto switch: -10 to 70°C (With no freezing)			
	With auto switch: -10 to 60°C (With no freezing)			
Piston speed	1 to 200 mm/s			
Stroke length tolerance	$+1.0$ 0 mm			
Port size	M5 x 0.8			
Relief port	M5 x 0.8			
Grease	Fluorine grease			
Cleanliness class (ISO class)	Class 4			

Bore size (mm)	11- (Vacuum suction type)			
	12	16	20	25
Fluid	Air			
Proof pressure	1.5 MPa			
Maximum operating pressure	1.0 MPa			
Minimum operating pressure	0.03 MPa		0.025 MPa	
Ambient and fluid temperature	Without auto switch: -10 to 70°C (With no freezing)			
	With auto switch: -10 to 60°C (With no freezing)			
Piston speed	1 to 200 mm/s		0.5 to 200 mm/s	
Stroke length tolerance	$+1.0$ 0 mm			
Port size	M5 x 0.8			
Vacuum suction port	M5 x 0.8			
Grease	Fluorine grease			
Cleanliness class (ISO class)	Class 3			
Suction flow rate (Reference values)	5 L/min (ANR)			

Dimensions and applicable auto switches are the same as 10-/11-CQS.
Refer to pages 750 to 754.

Series 10-11-CQ2X

ø32, ø40, ø50, ø63
Low Speed Cylinder

How to Order

● **Clean series**

10	Relief type
11	Vacuum suction type

10 — C D Q2XB 40 — 30 D [] J79 []

● **Built-in magnet**

Nil	No
D	With auto switch (Built-in magnet)

● **Low speed cylinder**

● **Bore size**

32	32 mm
40	40 mm
50	50 mm
63	63 mm

● **Cylinder stroke (mm)**

Bore size (mm)	Standard stroke (mm)
32, 40	5, 10, 15, 20, 25, 30, 35, 40, 45, 50, 75, 100
50, 63	10, 15, 20, 25, 30, 35, 40, 45, 50, 75, 100

*Manufacturing of intermediate strokes
Intermediate strokes in 1 mm increments are available by using spacers with standard stroke cylinders.
Please contact SMC for ø40 with bumper.

Example 1) 10-CQ2XB40-57D: Install an 18 mm width spacer in a standard stroke cylinder 10-CQ2XB40-75D.

● **Number of auto switches**

Nil	2 pcs.
S	1 pc.
n	n pcs.

● **Auto switch**

Reed switch	A73, A93
Solid state	J79, M9B, F79, M9N

* The minimum stroke for auto switch mounting and operating range are the same as standard products.

● **Rod end thread**

Nil	Standard (Rod end female thread)
M	Rod end male thread

● **Action**

D	Double acting
---	---------------



Model

	Model	Bore size (mm)	Port size	Lubrication	Action	Standard stroke (mm)	Auto switch mounting	Cushion	
								Rubber	Air
Relief type	10-CQ2XB32	32	M5 x 0.8, Rc1/8 ^{Note 1)}	Non-lube	Double acting Single rod	5, 10, 15, 20, 25, 30, 35, 40, 45, 50, 75, 100	○	—	—
	10-CQ2XB40	40	Rc1/8						
	10-CQ2XB50	50	Rc1/4						
	10-CQ2XB63	63	Rc1/4						
Vacuum suction type	11-CQ2XB32	32	M5 x 0.8, Rc1/8 ^{Note 1)}	Non-lube	Double acting Single rod	5, 10, 15, 20, 25, 30, 35, 40, 45, 50, 75, 100	○	—	—
	11-CQ2XB40	40	Rc1/8						
	11-CQ2XB50	50	Rc1/4						
	11-CQ2XB63	63	Rc1/4						

Note 1) For ø32 without an auto switch, M5 x 0.8 is used for 5 mm stroke only.

Low Speed Cylinder 10-CQ2X/11-CQ2X

Specifications

Bore size (mm)	10- (Relief type)			
	32	40	50	63
Fluid	Air			
Proof pressure	1.5 MPa			
Maximum operating pressure	1.0 MPa			
Minimum operating pressure	0.035 MPa		0.03 MPa	
Ambient and fluid temperature	Without auto switch: -10 to 70°C (With no freezing) With auto switch: -10 to 60°C (With no freezing)			
Piston speed	1 to 200 mm/s			
Stroke length tolerance	${}^{+1.0}_0$ mm			
Port size	M5 x 0.8, 1/8	1/8		1/4
Relief port	M5 x 0.8			
Grease	Fluorine grease			
Cleanliness class (ISO class)	Class 4			

Bore size (mm)	11- (Vacuum suction type)			
	32	40	50	63
Fluid	Air			
Proof pressure	1.5 MPa			
Maximum operating pressure	1.0 MPa			
Minimum operating pressure	0.025 MPa		0.02 MPa	
Ambient and fluid temperature	Without auto switch: -10 to 70°C (With no freezing) With auto switch: -10 to 60°C (With no freezing)			
Piston speed	0.5 to 200 mm/s			
Stroke length tolerance	${}^{+1.0}_0$ mm			
Port size	M5 x 0.8, 1/8	1/8		1/4
Vacuum suction port	M5 x 0.8			
Grease	Fluorine grease			
Cleanliness class (ISO class)	Class 3			
Suction flow rate (Reference values)	5 L/min (ANR)		10 L/min (ANR)	

Dimensions and applicable auto switches are the same as 10-/11-CQ2.
Refer to pages 759 to 762.



Actuators Precautions 1

Be sure to read this before handling.

Design/Selection

Warning

1. Confirm the specifications.

Products represented in this catalog are designed only for use in compressed air systems (including vacuum).

Do not operate at pressures or temperatures, etc., beyond the range of specifications, as this can cause damage or malfunction. (Refer to the specifications.)

Please contact SMC when using a fluid other than compressed air made by pneumatic equipment (including vacuum).

We do not guarantee against any damage if the product is used outside of the specification range.

2. Confirm the applicable specification range.

The cylinder specifications listed in this catalog apply to standard strokes, including intermediate strokes. Please consult with SMC for specifications on long strokes. There are also some made-to-order products (-XB□/-XC□) for which product specifications do not apply.

3. There is a danger of sudden action by cylinders if sliding parts of machinery are twisted, etc., and changes in forces occur.

In such cases, human injury may occur; e.g., by catching hands or feet in the machinery, or damage to the machinery itself may occur. Therefore, the machine should be designed to operate smoothly and to avoid such dangers.

4. If there is a chance that the product will pose a hazard to humans, install a protective cover.

If the moving portion of the product will pose a hazard to humans or will damage machinery or equipment, provide a construction that prevents direct contact with those areas.

5. Be certain that the secured portions will not loosen.

Be certain to adopt a reliable connecting method if the cylinder is used very frequently or if it is used in a location that is exposed to a large amount of vibration.

6. There may be cases in which a speed reduction circuit or a shock absorber is required.

If the driven object moves at high speeds or is heavy, it will be unfeasible for only the cylinder's cushion to absorb the shock. Therefore, provide a speed-reduction circuit to reduce the cylinder's speed before the thrust is applied to the cushion, or an external shock absorber to dampen the shock. If these countermeasures are taken, make sure to take the rigidity of the mechanical equipment into consideration.

7. Consider the possibility of power source related malfunction that could occur.

For the equipment that rely on power sources such as compressed air, electricity, or hydraulic pressure, adopt a countermeasure to prevent the equipment from causing a hazard to humans or damage to the equipment in the event of malfunction.

8. Design the circuitry to prevent sudden lurching of driven objects.

When a cylinder is driven by an exhaust center type directional control valve or when starting up after residual pressure is exhausted from the circuit, etc., the piston and its driven object will lurch at high speed if pressure is applied to one side of the cylinder because of the absence of air pressure inside the cylinder. Therefore, select equipment and design circuits to prevent sudden lurching, because there is a danger of human injury and/or damage to equipment when this occurs.

9. Consider the behavior of the cylinder in the event of an emergency stop.

Devise a safe system so that if a person engages the emergency stop, or if a safety device is tripped during a system malfunction such as a power outage, the movement of the cylinder will not cause a hazard to humans or damage the equipment.

10. Avoid synchronized operation using cylinders only.

Even if multiple pneumatic cylinders are initially set to the same speed, their speed may vary due to changes in operating conditions. Therefore, avoid designs where a single load is moved by synchronizing multiple cylinder operations.

11. Consider the action of the cylinder when restarting after an emergency stop.

Devise a safe design so that the restarting of the cylinder will not pose a hazard to humans or damage the equipment. Install manually controlled equipment for safety when the actuator has to be reset to the starting position.

12. Intermediate stops

When intermediate stopped position is performed with a 3 position closed center type/double check valve type directional control valve, it is difficult to achieve accurate and precise stopped positions due to the compressibility of air.

Furthermore, since valves or cylinders are not guaranteed for zero air leakage, it may not be possible to hold a stopped position for an extended period of time. Please contact SMC in case it is necessary to hold a stopped position for an extended period.

13. Do not disassemble the product or make any modifications, including additional machining.

It may cause human injury and/or an accident.

14. Refer to the Auto Switches Precautions for using with an auto switch.

15. When a cylinder is used in a clamping, suspending and lifting mechanism

There is a danger of workpieces dropping if there is a decrease of thrust due to a drop in circuit pressure caused by a power outage, etc. Therefore, safety equipment should be installed to prevent damage to machinery and/or human injury.

Directional Control Valves

Air Cylinders

Rotary Actuators

Air Grippers

Air Preparation Equipment

Modular F. R.

Pressure Control Equipment

Fittings & Tubing

Flow Control Equipment

Pressure Switches/ Pressure Sensors



Actuators Precautions 2

Be sure to read this before handling.

Design/Selection

Caution

1. **Use the product within the limits of the maximum usable stroke.**

The piston rod will be damaged if operated beyond the maximum stroke. Refer to the Cylinder Model Selection Procedure for the maximum usable stroke.

2. **Operate the cylinder component parts within a range such that collision damage will not occur at the stroke end.**

For applications where a piston with inertial force strikes a cover and stops at the stroke end, follow the cylinder model selection procedure (Best Pneumatics No. 2), or select while taking into account the allowable kinetic energy indicated in the each model specifications.

3. **Use a speed controller to adjust the cylinder drive speed, gradually increasing from a low speed to the desired speed setting.**

4. **Provide intermediate supports for long stroke cylinders.**

Provide intermediate supports for cylinders with long strokes to prevent rod damage due to sagging of the rod, deflection of the tube, vibration and external loads, etc.

In addition, thoroughly examine the possibility of buckling and establish safety measures, such as constructing a guide outside of the product, etc.

5. **If pressure is applied to the external cylinder parts, there is a possibility that air will get inside the cylinder from the rod seal section. (Example: Inside a chamber, etc.)**

Mounting

Warning

1. **Operation manual**

Install the product and operate it only after reading the operation manual carefully and understanding its contents. Also, keep the manual in a location where it can be referred to as necessary.

2. **Ensure sufficient space for maintenance activities.**

When installing the products, allow access for maintenance.

3. **Tighten threads with the proper tightening torque.**

When installing the products, follow the listed torque specifications.

4. **Do not place a magnetic object near the product.**

The auto switch is a magnetic sensing type. If a magnetic object is placed close to it, the rotary actuator could operate suddenly, which could pose a hazard to humans and damage the machinery and equipment.

5. **Do not perform additional machining to the product.**

Additional machining to the product can result in insufficient strength and cause damage to the product. This can lead to possible human injury and damage to the surrounding equipment.

6. **Do not enlarge the fixed throttle by modifying the pipe connectors.**

If the hole diameter is enlarged, the product's rotation speed will increase, causing the shock force to increase and damage to the product. As a result, it could pose a hazard to humans and damage the machinery and equipment.

Mounting

Caution

1. **Be certain to align the rod axis with the load and direction of movement when connecting.**

When not properly aligned, the rod and tube may be twisted, and damage may be caused due to wear on areas such as the inner tube surface, bushings, rod surface and seals.

2. **When an external guide is used, connect the rod end and the load in such a way that there is no interference at any point within the stroke.**

3. **Do not scratch or gouge the sliding parts of the cylinder tube or piston rod, etc., by striking or grasping them with other objects.**

Cylinder bores are manufactured to precise tolerances, so that even a slight deformation may cause malfunction. Also, scratches or gouges, etc., in the piston rod may lead to damaged seals and cause air leakage.

4. **Prevent the seizure of rotating parts.**

Prevent the seizure of rotating parts (pins, etc.) by applying grease.

5. **Do not use until you can verify that equipment can operate properly.**

Verify correct mounting by function and leak tests properly after compressed air and power are connected following mounting or repair.

6. **Cantilever fastening**

If a cylinder is actuated at high speed when mounted with one side fastened and one side free (basic type, flange type, direct mount type), the bending moment may act on the cylinder due to vibration at the stroke end, causing damage to the cylinder. In such cases, install a mounting bracket to suppress vibration of the cylinder body, or reduce piston speed until the cylinder body does not vibrate at the stroke end.

Also, use a mounting bracket when moving the cylinder body, or mounting a long stroke cylinder horizontally with one-sided fastening.

7. **Be very careful when handling the product.**

Depending on the handling method, there is a risk that the corners of the product will injure your hand or fingers, etc.



Actuators Precautions 3

Be sure to read this before handling.

Piping

⚠ Caution

1. Refer to the **Fittings and Tubing Precautions (pages 1237 to 1240)** for handling **One-touch fittings**.
2. **Preparation before piping**
Before piping is connected, it should be thoroughly flushed out with air or washed to remove chips, cutting oil and other debris from inside the pipe.
3. **Winding of sealant tape**

When screwing piping or fittings into ports, ensure that chips from the pipe threads or sealing material do not enter the piping. Also, if sealant tape is used, leave 1.5 to 2 thread ridges exposed at the end of the threads.

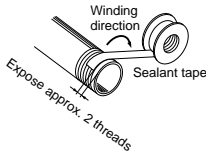

Cushion

⚠ Caution

1. **Readjust using the cushion needle.**
Adjust the cushion needle on the cover when the product is put into service, based upon factors such as the size of the load and the operating speed. When the cushion needle is turned clockwise, the restriction becomes smaller and the cushion's effectiveness is increased. Tighten the lock nut securely after adjustment is performed.
2. **Do not operate with the cushion needle in a fully closed condition.**
This could tear the seal.

Lubrication

⚠ Warning

1. **Lubricating the lube type cylinder**
Install a lubricator in the circuit, and use class 1 turbine oil (with no additive) ISO VG32. Do not use machine oil or spindle oil. If turbine oil is used, refer to the Material Safety Data Sheet (MSDS) of the oil.
2. **Lubricating the non-lube type cylinder**
The cylinder has been lubricated for life at the factory and can be used without any further lubrication. However, in the event that it is additionally lubricated, be sure to use class 1 turbine oil (with no additive) ISO VG32. Do not use machine oil or spindle oil. Stopping lubrication later may lead to malfunction because the new lubricant will displace the original lubricant. Therefore, lubrication must be continued once it has been started. If turbine oil is used, refer to the corresponding Material Safety Data Sheet (MSDS).

Air Supply

⚠ Warning

1. **Type of fluids**
Please consult with SMC when using the product in applications other than compressed air.
2. **When there is a large amount of drainage.**
Compressed air containing a large amount of drainage can cause malfunction of pneumatic equipment. An air dryer or water separator should be installed upstream from filters.
3. **Drain flushing**
If condensation in the drain bowl is not emptied on a regular basis, the bowl will overflow and allow the condensation to enter the compressed air lines. It causes malfunction of pneumatic equipment.
If the drain bowl is difficult to check and remove, installation of a drain bowl with an auto drain option is recommended.
For compressed air quality, refer to SMC Best Pneumatics No. 5 catalog.
4. **Use clean air.**
Do not use compressed air that contains chemicals, synthetic oils including organic solvents, salt or corrosive gases, etc., as it can cause damage or malfunction.

⚠ Caution

1. **When extremely dry air is used as the fluid, degradation of the lubrication properties inside the equipment may occur, resulting in reduced reliability (or reduced service life) of the equipment. Please consult with SMC.**
2. **Install an air filter.**
Install an air filter upstream near the valve. Select an air filter with a filtration size of 5 μm or smaller.
3. **Take measures to ensure air quality, such as by installing an aftercooler, air dryer, or water separator.**
Compressed air that contains a large amount of drainage can cause malfunction of pneumatic equipment such as valves. Therefore, take appropriate measures to ensure air quality, such as by providing an aftercooler, air dryer, or water separator.
4. **Ensure that the fluid and ambient temperature are within the specified range.**
If the fluid temperature is 5°C or less, the moisture in the circuit could freeze, causing damage to the seals and equipment malfunction. Therefore, take appropriate measures to prevent freezing.
For compressed air quality, refer to SMC Best Pneumatics No. 5 catalog.
5. **Precautionary measures against condensation**
Moisture condensation can occur inside pneumatic systems due to a drop in temperature caused by the piping or operating conditions. This can degrade or wash away grease, resulting in shortened service life or malfunctions.
For details, refer to the catalog "Precautionary measures against condensation in a pneumatic system" (CAT.P-E01-11).

Directional Control Valves

Air Cylinders

Rotary Actuators

Air Grippers

Air Preparation Equipment

Modular F. R.

Pressure Control Equipment

Fittings & Tubing

Flow Control Equipment

Pressure Switches/Pressure Sensors



Actuators Precautions 4

Be sure to read this before handling.

Operating Environment

Warning

1. Do not use in an atmosphere having corrosive gases, chemicals, sea water, water, water steam, or where there is direct contact with any of these.

Long machined parts made by machining plated carbon steel (end threads of piston rods, double-sided chamfer portion, tie rod threads etc.) are not plated. Consider a made-to-order product (-XC6/-XC7) when using in an environment where rusting or corrosion will be a problem. Refer to each construction on drawing on the rotary actuators material.

2. Do not expose the product to direct sunlight for an extended period of time.
3. Do not use in a place subject to heavy vibration and/or shock.
4. Do not mount the product in locations where it is exposed to radiant heat.
5. Do not use in dusty locations or where water or oil, etc., splash on the equipment.
Use the heavy duty scraper type (-XC4) in situations where there is a lot of dust. Use a water resistant cylinder when there is splashing or spraying of a liquid.
6. When using auto switches, do not operate in an environment with strong magnetic fields.
7. If a shock absorber is attached to an actuator, read the Specific Product Precautions for the shock absorber.
8. A decrease in grease base oil may be accelerated by the properties of compressed air used in pneumatic equipment, the external environment, or operating conditions, etc., and the resulting drop in lubricating performance may have an effect on equipment service life.

Caution

1. Internal lubricant or grease base oil may seep out of the cylinder depending on the operating conditions (an ambient temperature of 40°C or more, pressure retention, and low frequency actuation, etc.). Take great care when the clean environment is required.

Maintenance

Warning

1. Perform maintenance inspection according to the procedures indicated in the operation manual.

If handled improperly, malfunction and damage of machinery or equipment may occur.

2. Maintenance work

If handled improperly, compressed air can be dangerous. Assembly, handling, repair and element replacement of pneumatic systems should be performed by a knowledgeable and experienced person.

3. Drain flushing

Remove drainage from air filters regularly.

4. Removal of equipment, and supply/exhaust of compressed air

When components are removed, first confirm that measures are in place to prevent workpieces from dropping, run-away equipment, etc. Then, cut off the supply pressure and electric power, and exhaust all compressed air from the system using the residual pressure release function.

When machinery is restarted, proceed with caution after confirming that appropriate measures are in place to prevent cylinders from sudden movement.



Actuators Precautions 5

Be sure to read this before handling.

For Air-hydro Type

Please read this page along with the Actuators Precautions.

Design/Selection

Warning

1. Do not use an air-hydro cylinder near flames, or in equipment or machinery that exceeds an ambient temperatures of 60°C.

There is a danger of causing a fire because the air-hydro cylinder uses a flammable hydraulic fluid.

Refer to the Material Safety Data Sheet (MSDS) of the hydraulic fluid when supplying the fluid.

2. Do not use the product in a clean room.

Caution

1. Select an air-hydro cylinder in combination with an air-hydro unit.

Since good operation of an air-hydro cylinder depends on its combination with an air-hydro unit, carefully select an appropriate air-hydro unit.

2. Set the load of the air-hydro cylinder to be 50% or less of the theoretical force.

For an air-hydro cylinder to obtain constant speed and stopping accuracy similar of a hydraulic cylinder, it is necessary to keep the load at 50% or less of the theoretical output.

3. Do not use in an environment, equipment, or machine that is not compatible with oil mist.

Air-hydro cylinders generate an oil mist during operation which may affect the environment.

4. Be certain to install an exhaust cleaner on the directional control valve for the air-hydro cylinder.

A very small amount of hydraulic fluid is discharged from the exhaust port of the air-hydro cylinder's directional control valve, which may contaminate the surrounding area.

5. Install an air-hydro cylinder in locations where it can be serviced easily.

Since the air-hydro cylinder requires maintenance, such as refilling of hydraulic fluid and bleeding of air, ensure sufficient space for these activities.

Piping

Warning

1. For air-hydro cylinder piping, use self-aligning fittings.

Do not use One-touch fittings in the piping for an air-hydro cylinder, because oil leakage may occur.

2. For air-hydro cylinder piping, use hard nylon tubing or copper piping.

As in the case of hydraulic circuits, surge pressures greater than the operating pressure may occur in an air-hydro cylinder's piping, making it necessary to use safer piping materials.

Lubrication

Warning

1. Completely discharge the compressed air in the system before filling the air-hydro unit with hydraulic oil.

When supplying hydraulic fluid to the air-hydro unit, first confirm that safety measures are implemented to prevent dropping of objects and the release of clamped objects, etc. Then, shut off the air supply and the equipment's electric power and exhaust the compressed air in the system.

If the air-hydro unit's supply port is opened with compressed air still remaining in the system, there is a danger of hydraulic fluid being blown out.

Refer to the Material Safety Data Sheet (MSDS) of the hydraulic fluid when supplying the fluid.

2. Use petroleum hydraulic fluid which can be used as turbine oil.

If non-flammable hydraulic fluid is used, it may cause problems.

The operating temperature range suitable for ISO VG32 is 15 to 35°C. If the operating temperature range is beyond that for ISO VG32, select ISO VG46 (suitable for operating range of 25 to 45°C).

(Note) Refer to the SMC website for details about each manufacturer's brand name of class 1 turbine oil (no additive) ISO VG32. Additionally, please contact SMC for details about class 2 turbine oil (with additives) ISO VG32.

Maintenance

Caution

1. Bleed air from the air-hydro cylinder on a regular basis.

Since air may accumulate inside an air-hydro cylinder, bleed air from it, for example before starting work. Bleed air from a bleeder valve provided on the air-hydro cylinder or the piping.

2. Verify the oil level of the air-hydro system on a regular basis.

Since a very small amount of hydraulic fluid is discharged from the air-hydro cylinder and air-hydro unit circuit, the fluid will gradually decrease. Therefore, check the fluid regularly and refill as necessary.

The oil level can be checked with a level gauge in the air-hydro converter.

Directional Control Valves

Air Cylinders

Rotary Actuators

Air Grippers

Air Preparation Equipment

Modular F. R.

Pressure Control Equipment

Fittings & Tubing

Flow Control Equipment

Pressure Switches/ Pressure Sensors



Auto Switches Precautions 1

Be sure to read this before handling.

Design/Selection

Cylinders or actuators include cylinders, air grippers, rotary actuators, and electric actuators/cylinders.

⚠ Warning

1. Confirm the specifications.

If the product is used with excess load applied or beyond the specification range, this may cause the product to break or malfunction. We do not guarantee against any damage if the product is used outside of the specification range.

2. Cautions for use in an interlock circuit

When an auto switch is used for an interlock signal requiring high reliability, devise a double interlock system to avoid trouble by providing a mechanical protection function, or by also using another switch (sensor) together with the auto switch.

Also, perform periodic maintenance and confirm proper operation.

3. Do not attempt to disassemble, modify (including exchanging the printed circuit boards), or repair the product.

An injury or failure can result.

⚠ Caution

1. Pay attention to the length of time that a switch is ON at an intermediate stroke position.

When an auto switch is placed at an intermediate position of the stroke and a load is driven at the time the piston passes, the auto switch will operate, but the operating time will be short if the speed is too fast. As a result, the load may not operate completely. The maximum detectable piston speed is:

$$V \text{ (mm/s)} = \frac{\text{Auto switch operating range (mm)}}{\text{Time load applied (ms)}} \times 1000$$

In cases of high piston speed, the use of an auto switch (D-F5NT, F7NT, G5NT, M5NT, M5PT) with a built-in OFF delay timer (≈ 200 ms) makes it possible to extend the load operating time.

The wide-range detection type D-G5NB (operating range 35 to 50 mm) may also be useful, depending on the application. Please consult with SMC for other models.

2. Take precautions when multiple cylinders/actuators are used close together.

When multiple auto switch cylinders/actuators are used in close proximity, magnetic field interference may cause the auto switches to malfunction. Maintain a minimum cylinder separation of 40 mm. (When the allowable interval is specified for each cylinder series, use the indicated value.)

The auto switches may malfunction due to the interference from the magnetic fields.

Use of a magnetic screen plate (MU-S025) or commercially available magnetic screen tape can reduce the interference of magnetic force.

3. Ensure sufficient clearance for maintenance activities.

When designing an application, be certain to allow sufficient clearance for maintenance.

⚠ Caution

4. Do not mount the cylinder or actuator with the auto switch on a footing.

If work personnel gets on or puts the work personnel's foot on the footing accidentally, an excessive load is applied to the cylinder or actuator, causing the cylinder or actuator to break.

5. Design the circuit so that any back-flow current does not flow in if a short-circuit trouble occurs or forced operation is performed to check the operation.

If a back-flow current occurs, this may cause the switch to malfunction or break.

6. When multiple auto switches are required.

"n" indicates the number of auto switches which can be physically mounted on the cylinders/actuators. Detection intervals depends on the auto switch mounting structure and set position, therefore some required interval and set positions may not be available.

7. Limitations on detectable position

There are positions or surfaces (bottom surface of the foot bracket, etc.) where the auto switch cannot be mounted due to the physical interference depending on the cylinder or actuator mounting status or mounting bracket. Select an appropriate auto switch setting position where the auto switch does not interfere with the cylinder or actuator mounting bracket (trunnion or reinforcing ring) after checking it sufficiently.



Auto Switches Precautions 2

Be sure to read this before handling.

Mounting/Adjustment

⚠ Caution

1. Do not drop or bump.

Do not drop, bump, or apply an excessive impact (300 m/s² or more for reed auto switches, 1000 m/s² or more for solid state auto switches) while handling the auto switch. It may cause the auto switch to break or malfunction.

2. Observe the proper tightening torque for mounting an auto switch.

When an auto switch is tightened beyond the range of tightening torque, auto switch mounting screws, auto switch mounting brackets or auto switch may be damaged.

On the other hand, tightening below the range of tightening torque may allow the auto switch to slip out of position.

3. Do not carry a cylinder by the auto switch lead wires.

This may cause disconnection of the lead wire or the internal element to break.

4. Do not use screws other than the set screws installed on the auto switch body to secure the auto switch.

If using other screws, auto switch may be damaged.

5. Mount an auto switch at the center of the operating range.

In the case of 2-color indicator auto switch, mount it at the center of the green LED illuminating range.

Adjust the mounting position of the auto switch so that the piston stops at the center of the operating range. (The mounting position shown in the catalog indicates the optimum position at stroke end.)

If mounted at the end of the operating range (around the borderline of ON and OFF), operation will be unstable depending on the operating environment. Also there are some cylinders or actuators with individual setting methods for auto switches. If so, mount it in accordance with the indicated method.

Even if 2-color indicator solid state auto switches are fixed at a proper operating range (the green light lights up), the operation may become unstable depending on the installation environment or magnetic field disturbance.

(Magnetic body, external magnetic field, proximal installation of cylinders with built-in magnet and actuators, temperature change, other factors for magnetic force fluctuation during operation, etc.)

6. Check the actual actuation position and adjust the auto switch mounting position.

According to the installation environment, the cylinder or actuator may not operate even at its proper mounting position. Even when setting at a midpoint of the stroke, check the actuation status and make the adjustment in the same manner.

7. Be very careful when handling the auto switch mounting band, as it has a thin structure.

Wiring

⚠ Caution

1. Confirm proper insulation of wiring.

If there is any improper insulation (mixed contact with other circuit, grounding fault, or improper insulation between terminals, etc.) in the wiring, an over-current flows in, causing the auto switch to break.

2. Wire separately from power lines or high voltage lines, avoiding parallel wiring or wiring in the same conduit with these lines.

If an inrush current is generated, the noise may cause the auto switch to malfunction.

3. Avoid repeatedly bending or stretching lead wires.

Broken lead wires will result from repeatedly applying bending stress or stretching force to the lead wires.

Stress and tensile force applied to the connection between the lead wire and auto switch increases the possibility of disconnection.

Keep the lead wire from moving especially in the area where it connects with the auto switch.

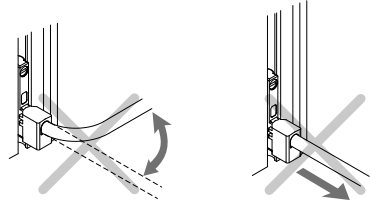

4. Be certain to connect the load before power is applied.

<2-wire type>

If the power is turned ON when an auto switch is not connected to a load, the auto switch will be instantly damaged because of excess current (short circuit).

It is the same as when the 2-wire brown lead wire (+, output) is directly connected to the (+) power supply terminal.

5. Carry out the wiring work after shutting down the power.

If the wiring work is performed with the power turned ON, this may cause electric shock, malfunction, or damage to the auto switch.

Directional Control Valves

Air Cylinders

Rotary Actuators

Air Grippers

Air Preparation Equipment

Modular F. R.

Pressure Control Equipment

Fittings & Tubing

Flow Control Equipment

Pressure Switches/ Pressure Sensors



Auto Switches Precautions 3

Be sure to read this before handling.

Operating Environment

⚠ Warning

1. Never use in an atmosphere of explosive gases.

The structure of auto switches is not intended to prevent explosion. This may lead to explosion hazard.
Please contact SMC concerning ATEX compliant products.

⚠ Caution

1. Do not use in an area where a magnetic field is generated.

Auto switches will malfunction or magnets inside cylinders/actuators will become demagnetized. (Please consult with SMC if a magnetic field resistant auto switch can be used.)

2. Do not use in an environment where the auto switch will be continually exposed to water.

Although auto switches satisfy IEC standard IP67 construction except some models (D-A3□, A44□, G39, K39□, RNK, RPK) do not use auto switches in applications where continually exposed to water splash or spray. This may cause improper insulation or malfunction.

3. Do not use in an environment with oil or chemicals.

If auto switches are used in an environment containing coolant, cleaning solvent, various oils, or chemicals even for a short period of time, this may adversely affect the auto switches, resulting in improper insulation, malfunction due to swelling of the potting resin, or hardening of the lead wires.

4. Do not use in an environment with temperature cycles.

If temperature cycles other than normal temperature changes are applied, this may adversely affect the insides of the auto switches.

5. Avoid accumulation of iron waste or close contact with magnetic substances.

If many iron particles, such as cutting chips or spatters accumulate around a cylinder with the auto switches or an actuator or if a magnetic substance (attracted by a magnet) is put close to a cylinder with the auto switch or an actuator, the magnetic force inside the cylinder or actuator loses, causing the auto switch to malfunction.

6. Please contact SMC concerning water resistance, elasticity of lead wires, usage at welding sites, etc.

7. Do not use in direct sunlight.

8. Do not mount the product in locations where it is exposed to radiant heat.

9. Take appropriate measures against the lightning surge on the equipment side as the auto switches do not have any lightning surge resistance specified in the CE marking.

Maintenance

⚠ Warning

1. Removal of equipment, and supply/exhaust of compressed air

Before any machinery or equipment is removed, first ensure that the appropriate measures are in place to prevent the fall or erratic movement of driven objects and equipment, then cut off the electric power and reduce the pressure in the system to zero. Only then should you proceed with the removal of any machinery and equipment.

When machinery is restarted, proceed with caution after confirming that appropriate measures are in place to prevent actuators from moving suddenly.

2. Do not touch a terminal during energizing.

Touching a terminal during energizing may cause electric shock, malfunction, or auto switch breakage.

⚠ Caution

1. Perform the following maintenance periodically in order to prevent possible danger due to unexpected auto switch malfunction.

1) Secure and tighten auto switch mounting screws.

If screws become loose or the mounting position is dislocated, retighten them after readjusting the mounting position.

2) Confirm that there is no damage to lead wires.

To prevent faulty insulation, replace auto switches or repair lead wires, etc., if damage is discovered.

3) Confirm the detection setting position.

• Red light of 1-color indicator auto switch

Confirm that the set position stops at the center of the operating range (red indication area).

• Confirm the green light and position of the 2-color indicator auto switch.

Confirm that the set position stops at the center of the appropriate operating range (green indication area). If stopped with the red LED lit, the operation may become unstable due to effects of the equipment environment or external disturbance. So, set the mounting position at the center of the appropriate operating range again.

Some cylinders or actuators indicate the individual setting procedures for the auto switch. If so, set the mounting position using the individual setting procedures.

2. Do not use solvents such as benzene, thinner etc. to clean the product.

They could damage the surface of the body and erase the markings on the body. For heavy stains, use a cloth lightly dampened with diluted neutral detergent, then wipe up any residue with a dry cloth.



Solid State Auto Switches Precautions

Be sure to read this before handling.

Design/Selection

⚠ Caution

1. Keep wiring as short as possible.

Be sure to use a wire length of 100 m or less.
When the wire length is long, we recommend the ferrite core is attached to the both ends of the cable to prevent excess noise. A contact protection box is not necessary for solid state auto switches due to the nature of this product construction.

2. Do not use a load that generates surge voltage.

If driving a load such as a relay that generates a surge voltage, use a built-in surge absorbing element type device.

3. Pay attention to the internal voltage drop of the auto switch.

Generally, the internal voltage drop of the solid state auto switch is larger than that of the reed auto switch. When the auto switches ("n" pcs.) are connected in series, the voltage drop is multiplied by "n". In this case, the auto switches operate correctly, but the loads may not operate. Additionally, note that the 12 VDC relay does not apply to the auto switch.

4. Pay attention to leakage current.

<2-wire type>

Current (leakage current) flows to the load to operate the internal circuit when in the OFF state.

Operating current of load (OFF condition) > Leakage current

If the criteria given in the above formula are not met, it will not reset correctly (stays ON). Use a 3-wire auto switch if this specification will not be satisfied.

Moreover, leakage current flow to the load will be "n" times larger when "n" auto switches are connected in parallel.

5. Output operation of the solid state auto switch is not stable for 50 [ms] after powered ON.

In the output operation immediately after powered ON or AND connection operation, the input device (PLC or relay, etc.) may judge the ON position as OFF output or the OFF position as ON output. So, please make the setting on the equipment so that the input judgement signal is set disabled for 50 [ms] immediately after powered ON or AND connection. When using SMC's AHC system (Auto Hand Changing System) Series MA, please also make this setting.

Wiring

⚠ Caution

1. Do not allow short-circuit of loads.

All models of D-J51, G5NB and PNP output type auto switches do not have built-in short circuit protection circuits. Carefully handle as the auto switch may be damaged.

Wiring

⚠ Caution

2. Avoid incorrect wiring.

- 1) If connections are reversed on a 2-wire type auto switch, the auto switch will not be damaged if protected by a protection circuit, but the auto switch will always stay in an ON state. However, it is still necessary to avoid reversed connections, since the auto switch could be damaged by a load short circuit in this condition.
- 2) If connections are reversed (power supply line + and power supply line -) on a 3-wire type auto switch, the auto switch will be protected by a protection circuit. However, if the power supply line (+) is connected to the blue wire and the power supply line (-) is connected to the black wire, the auto switch will be damaged.

3. When the lead wire sheath is stripped, confirm the stripping direction. The insulator may be split or damaged depending on the direction. (D-M9□ only)

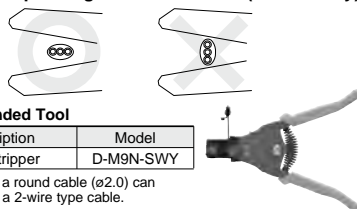

Recommended Tool

Description	Model
Wire stripper	D-M9N-SWY

* Stripper for a round cable (ø2.0) can be used for a 2-wire type cable.

4. Do not disconnect the cable between the sensor and amplifier of the heat resistant 2-color indicator solid state auto switch by the customer.

Even when the sensor and amplifier are connected again, a contact resistance is produced, causing the auto switch to malfunction. Additionally, the sensor and amplifier are paired and they do not operate correctly in different combinations.

Operating Environment

⚠ Caution

1. Do not use in an area where surges are generated.

If there is an equipment unit (electromagnetic lifter, high-frequency induction furnace, motor, or radio, etc.) that generates large surges or electromagnetic waves around cylinders with solid state auto switches or actuators, this may cause the circuit element inside the auto switch to break.

2. The AC magnetic field resistant solid state auto switch has no immunity against DC magnetic fields.

So it is not suitable for use in applications where welding takes place using DC inverter/rectified source. If using in conjunction with a DC welding application, use it at a distance from the conductor, as with ordinary switches.

Rough guide for distance from conductor to prevent malfunction (10,000 A: 30 cm or more).

Additionally, as for effects of magnetization and demagnetization, in areas exceeding 10,000 A, occasionally detection performance may become unstable due to demagnetization of the detection magnet (weakening of magnetic field) and magnetization (temporary magnetization) of materials around the cylinders and actuators.

If green and red indicators are not lit or if multi points operate, contact SMC.



Reed Auto Switches Precautions

Be sure to read this before handling.

Design/Selection

Caution

1. Keep wiring as short as possible.

As the length of the wiring to a load gets longer, the rush current at switching ON becomes greater, and this may shorten the product's life. (The switch will stay ON all the time.)

- 1) Use a contact protection box when the wire length is 5 m or longer.
- 2) Even if an auto switch has a built-in contact protection circuit, when the wiring is more than 30 m long, it is not able to adequately absorb the rush current and its life may be reduced. It is again necessary to connect a contact protection box in order to extend its life. Please consult with SMC in this case.

2. Do not use a load that generates surge voltage.

If a surge voltage is generated, the discharge occurs at the contact, possibly resulting in the shortening of product life.

If driving a load such as a relay that generates a surge voltage, use an auto switch with built-in contact protection circuit or use a contact protection box.

3. Pay attention to the internal voltage drop of the auto switch.

- 1) Auto switch with an indicator light (Except D-A56, A76H, A96, A96V, C76, E76A, Z76)

- If auto switches are connected in series as shown below, take note that there will be a large voltage drop because of internal resistance in the light emitting diodes. (Refer to the internal voltage drop in the auto switch specifications.) [The voltage drop will be "n" times larger when "n" auto switches are connected.]

Even though an auto switch operates normally, the load may not operate.

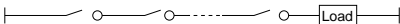

- In the same way, when operating under a specified voltage, although an auto switch may operate normally, the load may not operate. Therefore, the formula below should be satisfied after confirming the minimum operating voltage of the load.

$$\text{Supply voltage} - \text{Internal voltage drop of auto switch} > \text{Minimum operating voltage of load}$$

- 2) If the internal resistance of a light emitting diode causes a problem, select an auto switch without an indicator light (D-A6□, A80, A80H, A90, A90V, C80, R80, 90, 90A, E80A, Z80).

Wiring

Caution

1. Do not allow short-circuit of loads.

If the power is turned ON with a load in a short circuited condition, the auto switch will be instantly damaged because of excess current flow into the switch.

2. Avoid incorrect wiring.

A 24 VDC auto switch with indicator light has polarity. The brown lead wire or terminal No. 1 is (+), and the blue lead wire or terminal No. 2 is (-).

[For D-97, (+) is on the no-indicated side, (-) is on the black line side.]

- 1) If connections are reversed, an auto switch will operate, however, the light emitting diode will not light up. Also, take note that a current greater than that specified will damage a light emitting diode and it will no longer operate. Applicable model: D-A73, A73H, A73C, A93, A93V, A53, A54, B53, B54, C73, C73C, E73A, Z73, D-R73, R73C, 97, 93A, A33, A34, A33A, A34A, A44, A44A
- 2) When using a 2-color indicator auto switch (D-A79W, A59W and B59W), the auto switch will constantly remain ON if the connections are reversed.

Operating Environment

Caution

1. Do not use in an environment where there is excessive impact shock.

When an excessive impact (300 m/s² or more) is applied to a reed auto switch during operation, the contact point will malfunction and generate or cut off a signal momentarily (1 ms or less). If a further excessive impact is applied, the reed auto switch may break. Please consult with SMC if a solid state auto switch can be used according to the environment.

Handling Precautions

Caution

1. The protective cover supplied with the product when D-A9□, A9□V, Z7□ or Z80 is shipped from the factory is intended to absorb the impact generated by handling and prevent the auto switch holding screw from falling. Do not remove this cover until immediately before installing the auto switch on the cylinder or actuator.

Prior to Use

Auto Switches Common Specifications 1

Refer to the Auto Switch Precautions on pages 879 to 881 before using auto switches.

Auto Switches Common Specifications

Type	Reed auto switch	Solid state auto switch
Leakage current	None	3-wire: 100 μ A or less, 2-wire: 0.8 mA or less
Operating time	1.2 ms	1 ms or less *3)
Impact resistance	300 m/s ²	1000 m/s ² *4)
Insulation resistance	50 M Ω or more (500 VDC measured via megohmmeter) (Between lead wire and case)	
Withstand voltage	1500 VAC for 1 minute *1) (Between lead wire and case)	1000 VAC for 1 minute (Between lead wire and case)
Ambient temperature	-10 to 60°C	
Enclosure	IEC60529 Standard IP67 *2)	

- * 1) Electrical entry: Connector type (A73C/A80C/C73C/C80C): 1000 VAC/min. (Between lead wire and the case)
- * 2) The terminal conduit type (D-A3/A3□/A3□C/G39/G39A/G39C/K39/K39A/K39C), DIN terminal type (D-A44/A44A/A44C) and heat resistant auto switch (D-F7NJ) conform to IEC60529 Standard IP63.
The trimmer type amplifier section (D-R□K) conforms to IP40.
- * 3) Excluding the solid state auto switches with a timer (D-M5□T/G5NT/F7NT/F5NT types) and magnetic field resistant 2-color indicator solid state auto switch (D-P3DW□/P4DW).
The operating time for D-J51 is 2 ms or less and for D-P3DW□/P4DW are 40 ms or less.
- * 4) 980 m/s² for the trimmer type sensor section, 98 m/s² for the amplifier section.

Lead Wire

Lead wire length indication

(Example)

D-M9BW L

Auto switch model

Lead wire length

Symbol	Length	Tolerance	Connector specifications	Solid state	Reed
Nil	0.5 m	±15 mm		●	●
M	1 m	±30 mm		● *2)	● *2)
L	3 m	±90 mm		●	●
Z	5 m	±150 mm		●	● *3)
N *1)	None	—		●	●
SAPC	0.5 m	±15 mm	M8-3 pin	○	—
MAPC	1 m	±30 mm	Plug connector	○	—
SBPC	0.5 m	±15 mm	M8-4 pin	○	—
MBPC	1 m	±30 mm	Plug connector	○	—
SDPC	0.5 m	±15 mm	M12-4 pin A code (Normal key) Plug connector	○	—
MDPC	1 m	±30 mm		○	—
LDPC	3 m	±90 mm		○	—

●: Standard ○: Produced upon receipt of order (Standard)

- * 1) Applicable to the connector type (D-□□C) only.
- * 2) Applicable to the D-M9□ (V), D-M9□W (V), D-M9□A (V), and D-A93 only.
- * 3) Applicable to the D-B53/B54, D-C73(C)/C80C, D-A93(V), D-A73(C)/A80C, D-A53/A54, D-Z73, and D-90/97/90A/93A only.
- * 4) For reed auto switches M8 and M12 type with connector, please contact SMC.
- * 5) The standard lead wire length of the trimmer auto switch is 3 m.
- * 6) The standard lead wire length of the solid state auto switch with the timer except for the D-P3DW and D-M9□A (V)□, water-resistant 2-color indicator solid state auto switch, wide range detection auto switch, heat resistant 2-color indicator solid state auto switch, and strong magnetic field resistant 2-color indicator solid state auto switch is 3 m or 5 m. (Product with a lead wire length of 0.5 m is not available.)

Lead wires with a connector indication

Part No. of Lead Wires with Connectors
(Applicable only for connector type)

Model	Lead wire length
D-LC05	0.5 m
D-LC30	3 m
D-LC50	5 m

Directional Control Valves

Air Cylinders

Rotary Actuators

Air Grippers

Air Preparation Equipment

Modular F. R.

Pressure Control Equipment

Fittings & Tubing

Flow Control Equipment

Pressure Switches/Pressure Sensors

Prior to Use

Auto Switches Common Specifications 2

Refer to the Auto Switch Precautions on pages 879 to 881 before using auto switches.

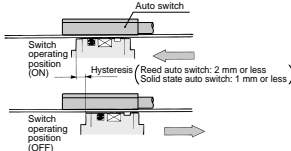
Term	Meaning
Hysteresis	 <p>A deviation amount between the ON position and OFF position caused by auto switch characteristics (difference in sensitivity between ON and OFF). When the switch is turned ON once and the switch (or piston) is moved in the opposite direction, a symptom occurs that the position where the switch turns OFF deviates to a position where it is further returned from the ON position. This deviation amount is called "hysteresis".</p> <p>Note) Hysteresis may fluctuate due to the operating environment. Please contact SMC if hysteresis causes an operational problem.</p>
Most sensitive position	A position (sensor layout position) where the sensitivity is highest on the detection surface of the auto switch enclosure. When the center of the magnet is aligned with this position, this becomes almost the center of the operating range and stable operation can be obtained.
Programmable Logic Controller (PLC)	One of elements making up the sequence control. The PLC is so designed that it receives signals, such as auto switch output and outputs them to other devices so as to perform the electrical control according to the preset program.
Operating temperature range	A temperature range, in which the auto switch can be used. If significant temperature change or freezing occurs even in this temperature range, this may cause the auto switch to malfunction.
Operating voltage	A voltage, at which the auto switch can be used. The operating voltage is indicated using generally used voltage (24 VDC or 100 VAC, etc.). For 2-wire type, the operating voltage has the same meaning as the power supply voltage or load voltage.
Operating current range	A range of the current value that can be flowed to the output of the auto switch. If the operating current is lower than this range, the auto switch does not operate correctly. Conversely, if the operating current is higher than this range, this may cause the auto switch to break.
Current consumption	This current value is necessary for the 3-wire type auto switch to operate the circuit through the power cable. For 2-wire type, as the current consumption is a part of the load current, it is not defined.
Insulation resistance	A resistance between the electric circuit and enclosure. Unless otherwise described particularly, 50 M Ω (Min) is used for auto switch.
Magnetic field resistant auto switch	An auto switch, for which measures against effects arising from external (welding) magnetic field generated in the spot welding process, etc. are taken. The solid state auto switch functions as it detects the frequency of the applied magnetic field. If the external magnetic field (AC) is applied, the last signal is retained not to be affected by the external magnetic field. This system can be used by the cylinder with normal magnetic force. The reed auto switch built-in a magnetic field shielded sensor with a low sensitivity to make the effect of the external magnetic field (DC or AC magnetic field) insusceptible. Therefore, a dedicated cylinder built-in the strong magnet needs to be selected and there is also an operable range (conditions).
Impact resistance value	A minimum acceleration that may cause the auto switch to malfunction or break when the standard impact is applied.
Water-resistant type auto switch	A model, long-term water resistance of which is improved by taking structural measures for the general (general purpose) product.
Withstand voltage	A tolerance dose when the voltage is applied to the portion between the electrical circuit and enclosure. The withstand voltage shows a strength level of the product against the voltage. If a voltage exceeding the withstand voltage is applied, this may cause the product to break. (The voltage described here is different from the power supply voltage necessary to operate the product.)
Proper mounting position	A dimension that shows the mounting position when the position is detected at the stroke end of the cylinder. As this position is set, the maximum sensitivity position is aligned with the center of the magnet. However, make the adjustment with the actual machine by considering the characteristic difference during actual setting. When an adjustment allowance is needed for the detection before the stroke, set a value with an adjustment allowance added to the proper mounting position.
Applicable load	A device that is assumed as a target load of the auto switch.
Operating time	A period of time until the auto switch output becomes stable after the magnetic force to operate the auto switch has been received.
Operating range	An auto switch operating range in response to the cylinder piston movement (ON length in response to the stroke). The operating range is determined by the magnetic force of the magnet (range, in which the magnetic force acts) and switch sensitivity. So, the operating range may vary as these conditions are changed by the ambient environment, etc. The operating range in the standard status (normal temperature, single cylinder, magnetic force, and sensitivity, etc.) is described in the catalog.

Prior to Use

Auto Switches Common Specifications 3

Refer to the Auto Switch Precautions on pages 879 to 881 before using auto switches.

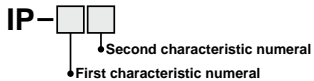
Term	Meaning																																
Minimum Stroke for Auto Switch Mounting	A minimum stroke value of the auto switch that can be mounted on the cylinder. The minimum stroke is determined by the specification limit (auto switch operation or position setting ability, etc.) and physical limit (mechanical interference associated with the auto switch mounting). Note that the catalog shows the value assuming that the position detection is performed at the stroke end and this value does not consider the adjustment allowance. When an adjustment allowance is needed, such as detection before the stroke, a value is set that this adjustment allowance is added to the minimum stroke.																																
Internal voltage drop	A voltage that is applied to the portion between the COM and signal line when the auto switch is ON. As only a value that the internal voltage drop is subtracted from the power supply voltage is applied to the input side of the PLC, the detection fault (incorrect input) may occur if this value is lower than the minimum operating voltage. So, take great care when selecting a device.																																
2-Color Indication	As the end part of the auto switch operating range (boundary between ON and OFF) is an area where is susceptible to the external disturbance or stroke change during cylinder operation, this function is intended to quickly and properly make the setting at the center of the operating range where the stable operation can be obtained by changing the operation indication color of the auto switch.																																
Load	A device that is connected to the output of the auto switch so as to do any work is called "load". For example, the load is a relay or PLC, etc. To check the operation of the auto switch, a device equivalent to the load (such as resistor, etc.) is connected.																																
Load current	A current that flows to the load when the ON-OFF output is ON.																																
Enclosure	A class of protection against solid or water entry of the electrical machinery and apparatus specified in IEC60529.  <p>●First Characteristics: Degrees of protection against solid foreign objects</p> <table border="1"> <tbody> <tr><td>0</td><td>Non-protected</td></tr> <tr><td>1</td><td>Protected against solid foreign objects of 50 mm ϕ and greater</td></tr> <tr><td>2</td><td>Protected against solid foreign objects of 12 mm ϕ and greater</td></tr> <tr><td>3</td><td>Protected against solid foreign objects of 2.5 mm ϕ and greater</td></tr> <tr><td>4</td><td>Protected against solid foreign objects of 1.0 mm ϕ and greater</td></tr> <tr><td>5</td><td>Dust-protected</td></tr> <tr><td>6</td><td>Dusttight</td></tr> </tbody> </table> <p>●Second Characteristics: Degrees of protection against water</p> <table border="1"> <tbody> <tr><td>0</td><td>Non-protected</td></tr> <tr><td>1</td><td>Protected against vertically falling water drops</td></tr> <tr><td>2</td><td>Protected against vertically falling water drops when enclosure tilted up to 15°</td></tr> <tr><td>3</td><td>Protected against rainfall when enclosure tilted up to 60°</td></tr> <tr><td>4</td><td>Protected against splashing water</td></tr> <tr><td>5</td><td>Protected against water jets</td></tr> <tr><td>6</td><td>Protected against powerful water jets</td></tr> <tr><td>7</td><td>Protected against the effects of temporary immersion in water</td></tr> <tr><td>8</td><td>Protected against the effects of continuous immersion in water</td></tr> </tbody> </table> <p>Example) In the case of stipulated as IP65, we can know the degrees of protection is dusttight and water jet-proof on the grounds that the first characteristic numeral is 6 and the second characteristic numeral is 5 respectively, that gives it will not be adversely affected by direct water jets from any direction.</p>	0	Non-protected	1	Protected against solid foreign objects of 50 mm ϕ and greater	2	Protected against solid foreign objects of 12 mm ϕ and greater	3	Protected against solid foreign objects of 2.5 mm ϕ and greater	4	Protected against solid foreign objects of 1.0 mm ϕ and greater	5	Dust-protected	6	Dusttight	0	Non-protected	1	Protected against vertically falling water drops	2	Protected against vertically falling water drops when enclosure tilted up to 15°	3	Protected against rainfall when enclosure tilted up to 60°	4	Protected against splashing water	5	Protected against water jets	6	Protected against powerful water jets	7	Protected against the effects of temporary immersion in water	8	Protected against the effects of continuous immersion in water
0	Non-protected																																
1	Protected against solid foreign objects of 50 mm ϕ and greater																																
2	Protected against solid foreign objects of 12 mm ϕ and greater																																
3	Protected against solid foreign objects of 2.5 mm ϕ and greater																																
4	Protected against solid foreign objects of 1.0 mm ϕ and greater																																
5	Dust-protected																																
6	Dusttight																																
0	Non-protected																																
1	Protected against vertically falling water drops																																
2	Protected against vertically falling water drops when enclosure tilted up to 15°																																
3	Protected against rainfall when enclosure tilted up to 60°																																
4	Protected against splashing water																																
5	Protected against water jets																																
6	Protected against powerful water jets																																
7	Protected against the effects of temporary immersion in water																																
8	Protected against the effects of continuous immersion in water																																
Solid state auto switch	A switch that detects the magnetic field by the MR element and incorporates the judgement circuit to turn ON or OFF the output regardless of the contact or non-contact of the mechanical contact like transistor (non-contact part).																																
Leak current	A current that flows to operate the internal circuit when the ON-OFF output is OFF. In particular, if this leak current exceeds the detection current in the 2-wire type auto switch or PLC, this may cause reset fault. So, take great care when selecting a device.																																
Reed auto switch	A switch that uses the reed switch to detect the magnetic field and turn ON or OFF the output by the contact or non-contact of the mechanical contact (contact part is provided like relay or limit switch).																																
Induction load	A load that has the coil. The connection target of the auto switch is a relay.																																
Recommended lead wire bending radius	A minimum bending radius (reference value) of the lead wire when the lead wire is secured and constructed (oscillation or rotation is not considered). (As the temperature or current value conforms to the auto switch specifications, this lead wire bending radius differs from the value disclosed by the electric wire manufacturer.)																																
Electrical entry	A structure, in which the lead wire of the auto switch is taken out in the horizontal direction when the cylinder is laid out horizontally (cylinder rod is horizontal), is called "in-line entry". A structure, in which the lead wire is taken out in a direction perpendicular to the cylinder axis center, is called "perpendicular entry".																																

Directional Control Valves

Air Cylinders

Rotary Actuators

Air Grippers

Air Preparation Equipment

Modular F. R.

Pressure Control Equipment

Fittings & Tubing

Flow Control Equipment

Pressure Switches/ Pressure Sensors

Prior to Use

Auto Switches/Internal Circuit

Solid State Auto Switches

Solid state 3-wire, NPN

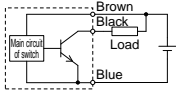

Solid state 3-wire, PNP

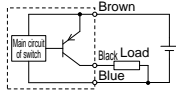

2-wire (Solid state)

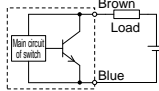

(Power supply for switch and load are separate)

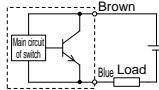
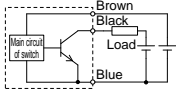

Reed Auto Switches

No.	①	②	③	④
Circuit diagram	<p>2-wire (Reed switch)</p>	<p>2-wire (Reed switch)</p>	<p>2-wire (Reed switch)</p>	<p>2-wire (Reed switch)</p>
Circuit diagram	<p>3-wire (Reed switch, NPN)</p>	<p>2-wire (Reed switch)</p>	<p>2-wire (Reed switch)</p>	

Contact Protection Box/CD-P11, CD-P12

<Applicable switch models>

D-A7/A8, D-A7□H/A80H, D-A73C, A80C, D-C7/C8, D-C73C/C80C, D-E7□A, E80A, D-Z7/Z8, D-9/9□A, D-A9/A9□V, D-A79W

The auto switches above do not have a built-in contact protection circuit. A contact protection box is not required for solid state auto switches due to their construction.

- Where the operation load is an inductive load.
- Where the wiring length to load is greater than 5 m.
- Where the load voltage is 100/200 VAC.

Therefore, use a contact protection box with the switch for any of the above cases:

The contact life may be shortened (due to permanent energizing state.)

D-A72(H) must be used with the contact protection box regardless of load types and lead wire length since it is greatly affected by loads.

(Where the load voltage is 110 VAC)

When the load voltage is increased by more than 10% to the rating of applicable auto switches (except D-A73C/A80C/C73C/C80C/90/97/A79W) above, use a contact protection box (CD-P11) to reduce the upper limit of the load current by 10% so that it can be set within the range of the load current range, 110 VAC.

Even for the built-in contact protection circuit type (D-A34[A][C], DA44[A][C], D-A54/A64, D-A59W, D-B59W), use the contact protection box when the wiring length to load is very long (over 30 m) and PLC (Programmable Logic Controller) with a large inrush current is used.

Contact Protection Box Specifications

Part no.	CD-P11	CD-P12
Load voltage	100 VAC or less	200 VAC 24 VDC
Max. load current	25 mA	12.5 mA 50 mA

*Lead wire length — Auto switch connection side 0.5 m
Load connection side 0.5 m

Contact Protection Box Internal Circuit

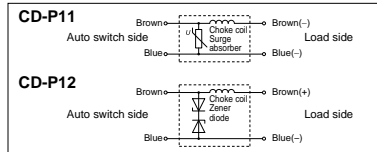

Dimensions: Contact Protection Box

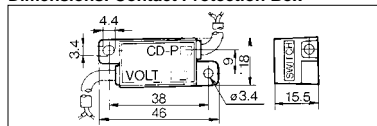

Contact Protection Box Connection

To connect a switch unit to a contact protection box, connect the lead wire from the side of the contact protection box marked SWITCH to the lead wire coming out of the switch unit. Keep the switch as close as possible to the contact protection box, with a lead wire length of no more than 1 meter.

Prior to Use

Auto Switch Connection and Example

Sink Input Specifications

3-wire, NPN

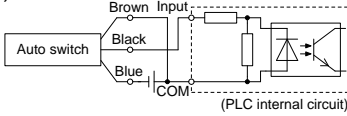

2-wire

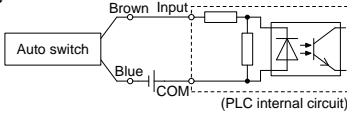

Source Input Specifications

3-wire, PNP

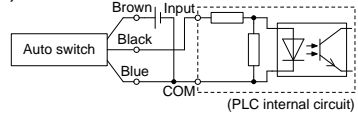

2-wire

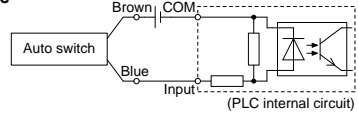

Connect according to the applicable PLC input specifications, as the connection method will vary depending on the PLC input specifications.

Example of AND (Series) and OR (Parallel) Connection

* When using solid state auto switches, ensure the application is set up so the signals for the first 50 ms are invalid.

3-wire AND connection for NPN output (Using relays)

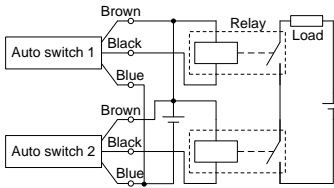

(Performed with auto switches only)

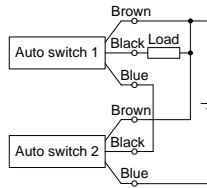

3-wire OR connection for NPN output

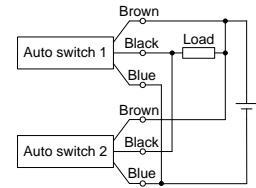

3-wire AND connection for PNP output (Using relays)

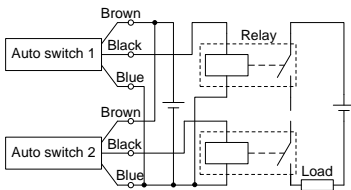

(Performed with auto switches only)

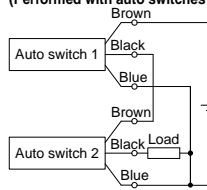

3-wire OR connection for PNP output

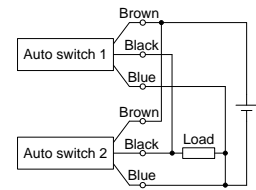

2-wire AND connection

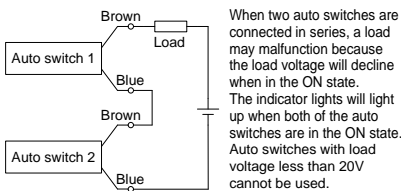

2-wire OR connection

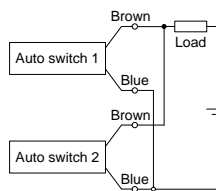

(Solid state)
When two auto switches are connected in parallel, malfunction may occur because the load voltage will increase when in the OFF state.

(Reed)
Because there is no current leakage, the load voltage will not increase when turned OFF. However, depending on the number of auto switches in the ON state, the indicator lights may sometimes grow dim or not light up, due to the dispersion and reduction of the current flowing to the auto switches.

Load voltage at ON = Power supply voltage – Residual voltage x 2 pcs.
= 24 V – 4 V x 2 pcs.
= 16 V

Example: Power supply is 24 VDC
Internal voltage drop in auto switch is 4 V.

Load voltage at OFF = Leakage current x 2 pcs. x Load impedance
= 1 mA x 2 pcs. x 3 kΩ
= 6 V

Example: Load impedance is 3 kΩ.
Leakage current from auto switch is 1 mA.

Directional Control Valves
Air Cylinders
Rotary Actuators
Air Grippers
Air Preparation Equipment
Modular F. R.
Pressure Control Equipment
Fittings & Tubing
Flow Control Equipment
Pressure Switches/Pressure Sensors





Cylinder Applicable Auto Switch List

Cylinder series	Bore size																												
	CDJ2-Z	CDJ2	CDM2-Z	CDBM2	CDG1-Z	CDG1		CD42	CUJ	CDU	CDQS	CDQ2-Z	REC	CXSJ	CXS	MGP-Z	MGP	MGF	MXP	MXQ	MXS	CYP	CDQSX	CDQ2X	CDM2X				
	ø10/ø16	ø6	ø20 to ø40	ø20 to ø40	ø20 to ø63	ø60/ø100	ø20 to ø63	ø60/ø100	ø40 to ø63	ø6 to ø10	ø6 to ø25	ø12 to ø25	ø32 to ø100	ø20 to ø40	ø6/ø10	ø6 to ø32	ø12 to ø63	ø12 to ø63	ø40/ø63/ø100	ø6 to ø16	ø6 to ø25	ø6 to ø25	ø15/ø32	ø12 to ø25	ø32 to ø63	ø20 to ø40			
Solid state auto switch	D-H7																												
	D-H7C																												
	D-H7BA																												
	D-H7□F																												
	D-H7□W																												
	D-G5/K5																												
	D-G5BA																												
	D-G59F																												
	D-G5NT																												
	D-G5□W/K59W																												
	D-G39/K39																												
	D-G39A/K39A																												
	D-F7/J7																												
	D-J79C																												
	D-F79F																												
	D-F7BA																												
	D-F7BAV																												
	D-F7□V																												
	D-F7NT																												
	D-F7□W(V)																												
	D-F5/J5																												
	D-F5BA																												
	D-F5□W/J59W																												
	D-F59F																												
	D-F5NT																												
	D-G39C/K39C																												
	D-M9	*	*	*	*	*	*	*	*	*	*	*	*	*	*	*	*	*	*	*	*	*	*	*	*	*	*	*	*
	D-M9□V	*	*	*	*	*	*	*	*	*	*	*	*	*	*	*	*	*	*	*	*	*	*	*	*	*	*	*	*
	D-M9□W	*	*	*	*	*	*	*	*	*	*	*	*	*	*	*	*	*	*	*	*	*	*	*	*	*	*	*	*
	D-M9□WV	*	*	*	*	*	*	*	*	*	*	*	*	*	*	*	*	*	*	*	*	*	*	*	*	*	*	*	*
	D-M9□A/M9□AV	*	*	*	*	*	*	*	*	*	*	*	*	*	*	*	*	*	*	*	*	*	*	*	*	*	*	*	*
	D-Y59A/Y7P/Y59B																												
	D-Y69A/Y7PV/Y69B																												
	D-Y7□W																												
	D-Y7□WV																												
	D-Y7BA																												
	D-P4DW																												
	D-F9G/H(Normally closed)	*	*	*	*	*	*	*	*	*	*	*	*	*	*	*	*	*	*	*	*	*	*	*	*	*	*	*	*
	D-Y7G/H(Normally closed)																												
	D-G5NB																												
D-F8□																													
D-C7/C8																													
D-C73C/C80C																													
D-B5/B6																													
D-B59W																													
D-A3/A4																													
D-A3□A/A44A																													
D-A3□C/A44C																													
D-A7/A8																													
D-A7□H/A80H																													
D-A73C/A80C																													
D-A79W																													
D-A5/A6																													
D-A59W																													
D-A9	*	*	*	*	*	*	*	*	*	*	*	*	*	*	*	*	*	*	*	*	*	*	*	*	*	*	*	*	
D-A9□V	*	*	*	*	*	*	*	*	*	*	*	*	*	*	*	*	*	*	*	*	*	*	*	*	*	*	*	*	
D-Z7/Z8																													

Please refer to the next page for applicable auto switches and cylinders in the fields marked with asterisks (*).

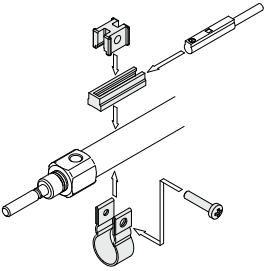
Compact Auto Switch Mounting Bracket

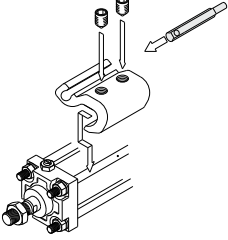
Mounting brackets used for installing the compact auto switches D-A9/M9 onto band mounting/tie-rod mounting/groove mounting type cylinders are available.

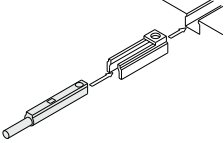
<p>Band mounting</p>  <p>Applicable cylinder Series 10-11-121-122-CDJ2 Series 10-11-121-122-CDM2 Series 10-11-121-122-CDG1 Series 10-11-REC Series 10-11-CDM2X</p>		
<p>Tie-rod mounting</p>  <p>Applicable cylinder Series 10-11-121-122-CDA2</p>		<p>Applicable auto switch</p> <p>Solid state auto switch D-M9/M9□V D-M9□W/M9□WV (2-color indication) D-M9□A (Water resistant type)</p> <p>Reed auto switch D-A9/D-A9□V</p>
<p>Groove mounting</p>  <p>Applicable cylinder Series 21-122-MGP</p>		

* For detailed auto switch specifications, refer to the **WEB catalog**.

Directional
Control Valves

Air Cylinders

Rotary Actuators

Air Grippers

Air Preparation
Equipment

Modular F. R.

Pressure Control
Equipment

Fittings & Tubing

Flow Control
Equipment

Pressure Switches/
Pressure Sensors

For Clean Room

Rotary Actuators

Contents	Series	Page
Vane Type Rotary Actuator	10-/21-CRB1	P.893
Rack & Pinion Type Rotary Actuator	11-CRA1-Z	P.905
Rack & Pinion Type Rotary Table	11-/22-MSQ	P.909
Precautions		P.914
Applicable Auto Switch List		P.920

Directional
Control Valves

Air Cylinders

Rotary Actuators

Air Grippers

Air Preparation
Equipment

Modular F. R.

Pressure Control
Equipment

Fittings & Tubing

Flow Control
Equipment

Pressure Switches/
Pressure Sensors

Series 10-21-CRB1 Vane Type Rotary Actuator

Size: 10, 15, 20, 30

How to Order



Clean series

10	Relief type
----	-------------

Mounting

B	Basic
F	Flange

Rotating angle

Vane type	Symbol	Rotating angle
Single vane	90	90°
	180	180°
	270	270°
Double vane	90	90°
	100	100°

Vane type

S	Single vane
D	Double vane

* Double vane is not available for size 10.

10 - C D R B 1 F W 10 - 180 S - 90 L

21 - C D R B 1 F W 10 - 180 S - 90 L

Auto switch

Nil	Without switch unit
D	With switch unit

Size

10
15
20
30

Auto switch

	90	Size: 10, 15
Reed switch	S99	
Solid state	T99	
Reed switch	R73	Size: 20, 30
Solid state	S79	
	T79	

Copper, fluorine and silicone-free + Low particle generation

21	Relief type
----	-------------

Electrical entry / Lead wire length

Nil	Grommet / Lead wire 0.5 m
L	Grommet / Lead wire 3 m
C *	Connector / Lead wire 0.5 m
CL *	Connector / Lead wire 3 m
CN *	Connector / Without lead wire

* Connectors are available only for auto switch types R73, T79.

Specifications

Single vane

Model	10-/21-CRB1BW10-□S	10-/21-CRB1BW15-□S	10-/21-CRB1BW20-□S	10-/21-CRB1BW30-□S
Rotating angle	90°, 180°, 270°			
Proof pressure (MPa)	1.05			1.5
Maximum operating pressure (MPa)	0.7			1.0
Minimum operating pressure (MPa)	0.2	0.15		
Ambient and fluid temperature (°C)	5 to 60			
Adjustable speed range (s/90°) ^{Note 1)}	0.03 to 0.3			0.04 to 0.3
Allowable kinetic energy (J) ^{Note 2)}	0.00015	0.001	0.003	0.0087
Shaft load (N)	Allowable radial load	14.7	14.7	24.5
	Allowable thrust load	9.8	9.8	19.6
Bearing type	Bearing			
Port location	Side ported or Axial ported			
Port size	Side ported	M3 x 0.5		M5 x 0.8
	Axial ported	M3 x 0.5		M5 x 0.8
Shaft type	Double shaft (Double shaft with single flat on both shafts)			
Mounting	Basic, Flange			
Auto switch	Mountable (Side ported only)			
Grease	10-: Fluorine grease			
	21-: Lithium soap based grease			
Cleanliness class (ISO class)	10-: Class 4			
	21-: Class 4			

Note 1) Make sure to use the actuator within the adjustable speed range. Exceeding the maximum speed (0.3 s/90°) can cause the unit to stick or not operate.

Note 2) The numbers in the table indicate the energy factor when the rubber bumper is used (at the end of the rotation).

Double vane

Model	10-/21-CRB1BW15-□D	10-/21-CRB1BW20-□D	10-/21-CRB1BW30-□D
Rotating angle	90°, 100°		
Proof pressure (MPa)	1.05		1.5
Maximum operating pressure (MPa)	0.7		1.0
Minimum operating pressure (MPa)	0.15		
Ambient and fluid temperature (°C)	5 to 60		
Adjustable speed range (s/90°) ^{Note 1)}	0.03 to 0.3		0.04 to 0.3
Allowable kinetic energy (J) ^{Note 2)}	0.001	0.003	0.0087
Shaft load (N)	Allowable radial load	14.7	24.5
	Allowable thrust load	9.8	19.6
Bearing type	Bearing		
Port location	Side ported or Axial ported		
Port size: Side ported, Axial ported	M3 x 0.5		M5 x 0.8
Shaft type	Double shaft (Double shaft with single flat on both shafts)		
Mounting	Basic, Flange		
Auto switch	Mountable (Side ported only)		
Grease	10-: Fluorine grease		
	21-: Lithium soap based grease		
Cleanliness class (ISO class)	10-: Class 4		
	21-: Class 4		

Note 1) Make sure to use the actuator within the adjustable speed range. Exceeding the maximum speed (0.3 s/90°) can cause the unit to stick or not operate.

Note 2) The numbers in the table indicate the energy factor when the rubber bumper is used (at the end of the rotation).

Auto Switch Specifications (Refer to the **WEB catalog** for further information on auto switches.)

Type	Auto switch model	Load voltage	Load current range	Indicator light	Applicable load
Size 10/15	Reed auto switch	D-90	24 VAC/DC or less	50 mA	No
	Solid state auto switch	D-T991/T992	24 VDC	5 to 150 mA	Yes
	3-wire	D-S991/S992	28 VDC or less	150 mA or less	Yes
Size 20/30	Reed auto switch	D-R731/R732	100 VAC	5 to 20 mA	Yes
	Solid state auto switch	D-T791/T792	24 VDC	5 to 150 mA	Yes
	3-wire	D-S791/S792	28 VDC or less	150 mA or less	Yes

Refer to page 920 for the applicable auto switch list.

PLC: Programmable Logic Controller

Classification of Auto Switches: Right-handed and Left-handed (includes one of each)

Right-handed

D-□□□1

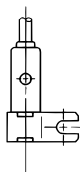

D-□991

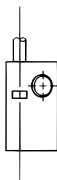

Left-handed

D-□□□2

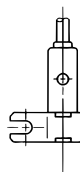

D-□992

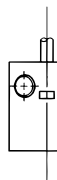

How to Change the Auto Switch Detecting Position

When setting the detecting position, loosen the cross recessed round head screw a bit and move the auto switch to the preferred position and then tighten again and fix it. At this time, if tightened too much, screw can become damaged and unable to fix position. Be sure to set the tightening torque around 0.5 N-m.

Operating Range and Hysteresis of Auto Switch

Model	Operating range	Hysteresis range
10-/21-CDRB1BW10/15	110°	10°
10-/21-CDRB1BW20/30	90°	10°

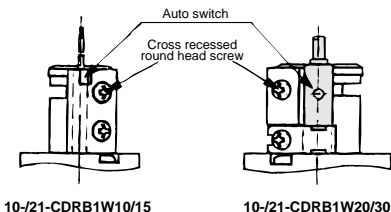

Option

Flange assembly

- * The flange (with countersunk head screws) is not mounted on the actuator at the time of shipment.
- * The flange can be mounted on the rotary actuator at 60-degree intervals.

Type		Flange assembly part no.
Basic	With auto switch	
10-21-CRB1FW10	10-21-CDRB1FW10	P414070-2
10-21-CRB1FW15	10-21-CDRB1FW15	P414090-2
10-21-CRB1FW20	10-21-CDRB1FW20	P414060-2
10-21-CRB1FW30	10-21-CDRB1FW30	P414080-2

Assembly part no:

P414070-2 (for 10-21-C□RB1FW□10)

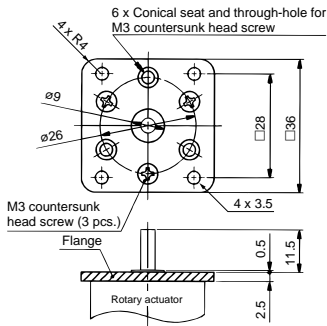

Assembly part no:

P414090-2 (for 10-21-C□RB1FW□15)

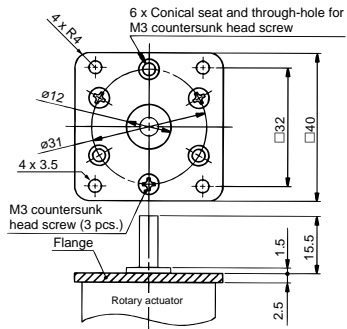

Assembly part no:

P414060-2 (for 10-21-C□RB1FW□20)

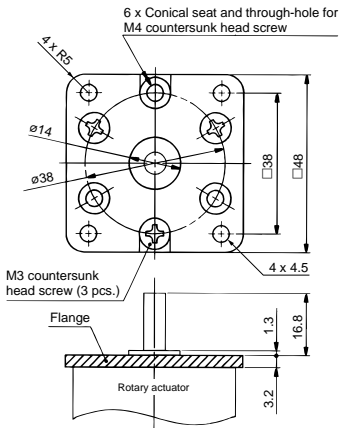

Assembly part no:

P414080-2 (for 10-21-C□RB1FW□30)

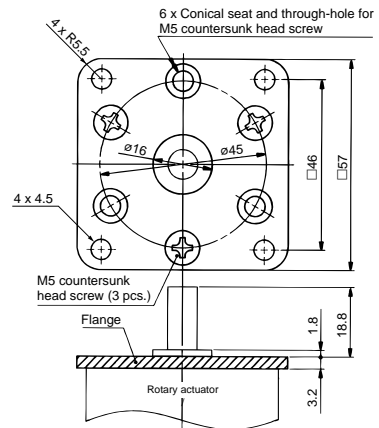

Directional Control Valves
 Air Cylinders
 Rotary Actuators
 Air Grippers
 Air Preparation Equipment
 Modular F. R.
 Pressure Control Equipment
 Fittings & Tubing
 Flow Control Equipment
 Pressure Switches/ Pressure Sensors

Without Auto Switch: 10-
21-CRB1BW10

* Double vane is not available for size 10.

Size 10

Rotation range (Chamfered positions shown below illustrate the conditions of actuators when B port is pressurized.)

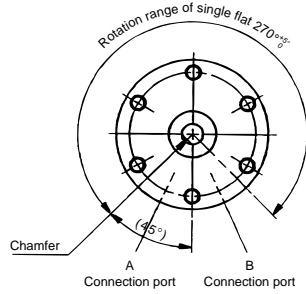
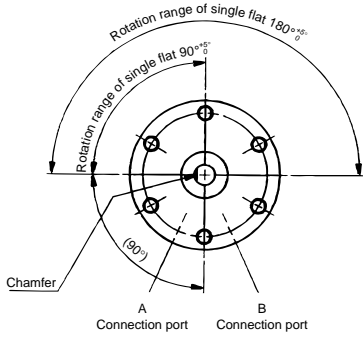

3 x M3 x 0.5 depth 9.5 (through body B)
 Circumference divided in 3 equivalents

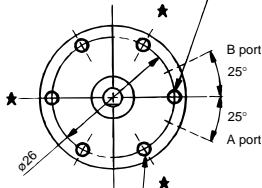

3 x M3 x 0.5 depth 5
 Circumference divided in 3 equivalents at ★ marks

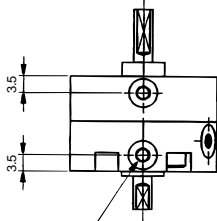

2 x M3 x 0.5
 Relief port

2 x M3 x 0.5
 Port: Side of body

8.5
 2 x M3 x 0.5
 Port: Axial direction of body



3 x 3.4 depth 6.5 (through body A)
 (Long groove counterbore $\phi 5.8$, from bearing surface of depth 4)

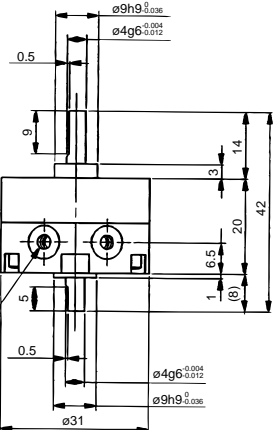

Without Auto Switch: 10-21-CRB1BW15 (Dimensions are common to both single vane and double vane)

Size 15

Rotation range of single vane type (Chamfered positions shown below illustrate the conditions of actuators when B port is pressurized.)

Rotation range of double vane type (Chamfered positions shown below illustrate the intermediate rotation position when A or B port is pressurized.)

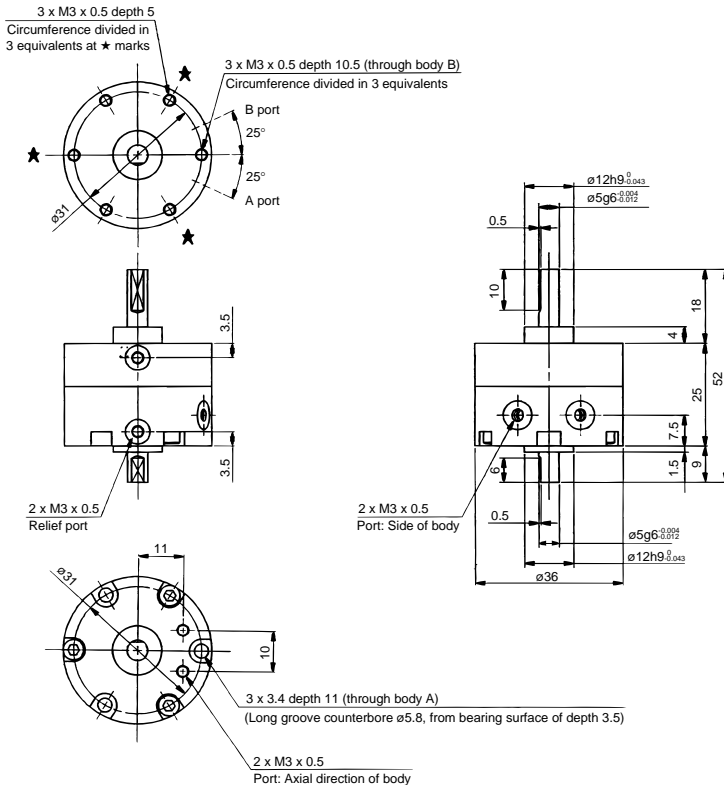
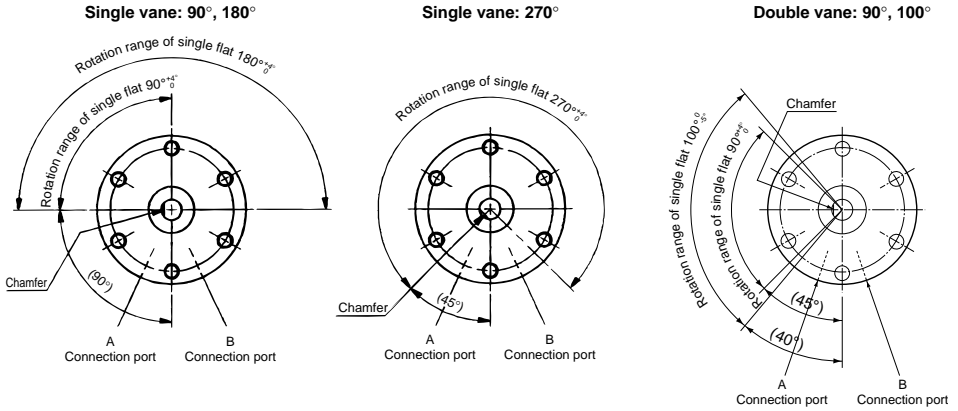

Directional Control Valves

Air Cylinders

Rotary Actuators

Air Grippers

Air Preparation Equipment

Modular F. R.

Pressure Control Equipment

Fittings & Tubing

Flow Control Equipment

Pressure Switches/ Pressure Sensors

Without Auto Switch: 10-21:CRB1BW20 (Dimensions are common to both single vane and double vane)

Size 20

Rotation range of single vane type (Chamfered positions shown below illustrate the conditions of actuators when B port is pressurized.)

Rotation range of double vane type (Chamfered positions shown below illustrate the intermediate rotation position when A or B port is pressurized.)

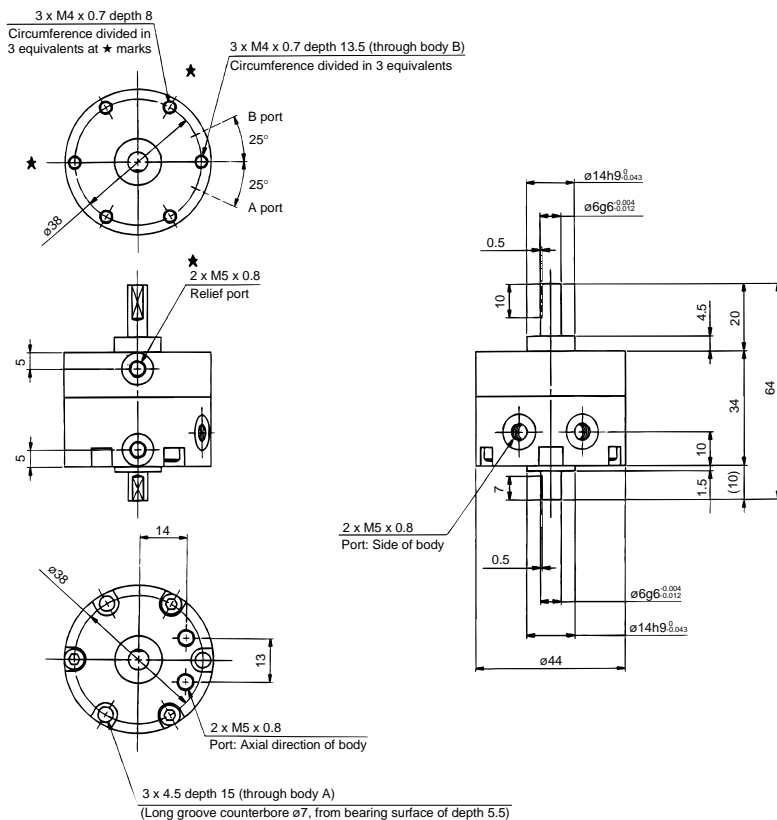
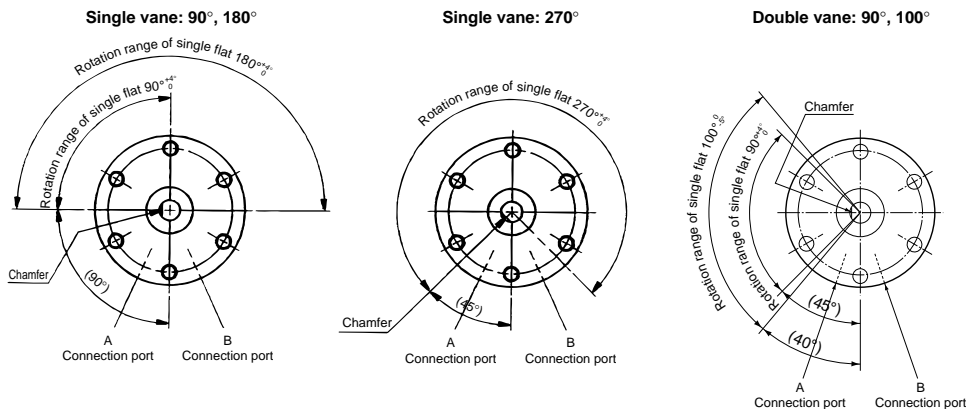

With Auto Switch: 10-21-**CDRB1BW10**

* Double vane is not available for size 10.

Size 10

Rotation range (Chamfered positions shown below illustrate the conditions of actuators when B port is pressurized.)

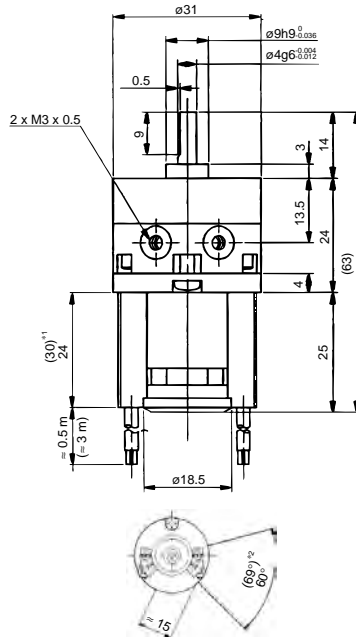
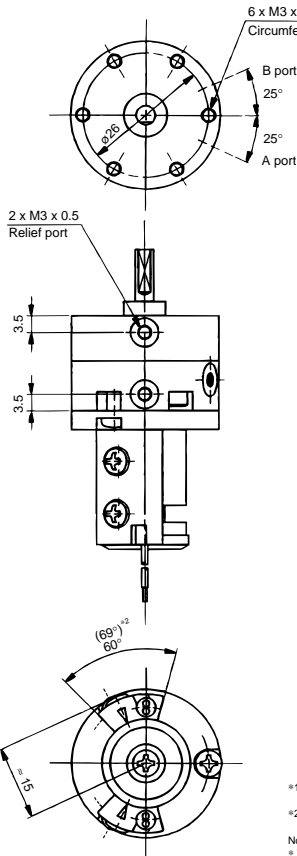
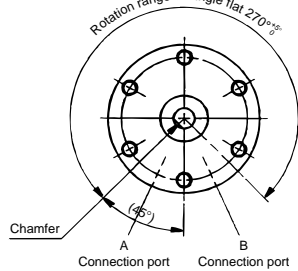
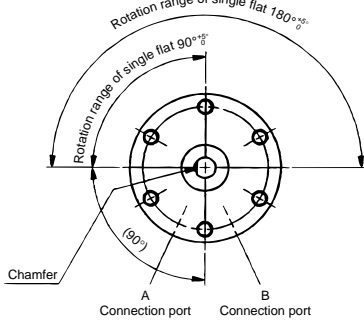

*1 The length is 24 when any of the following auto switches are used: D-90, D-90A, D-S99(V), D-T99(V), and D-S9P(V). The length is 30 when any of the following auto switches are used: D-97 and D-93A.
 *2 The angle is 60° when any of the following auto switches are used: D-90, D-90A, D-97, and D-93A. The angle is 69° when any of the following auto switches are used: D-S99(V), D-T99(V), and D-S9P(V).
 Note) For rotary actuators with auto switch unit, connection ports are side ports only.
 * The above exterior view drawings illustrate rotary actuators with one right-handed and one left-handed switch.

With Auto Switch: 10-21-CDRB1BW15 (Dimensions are common to both single vane and double vane)

Size 15

Rotation range of single vane type (Chamfered positions shown below illustrate the conditions of actuators when B port is pressurized.)

Rotation range of double vane type (Chamfered positions shown below illustrate the intermediate rotation position when A or B port is pressurized.)

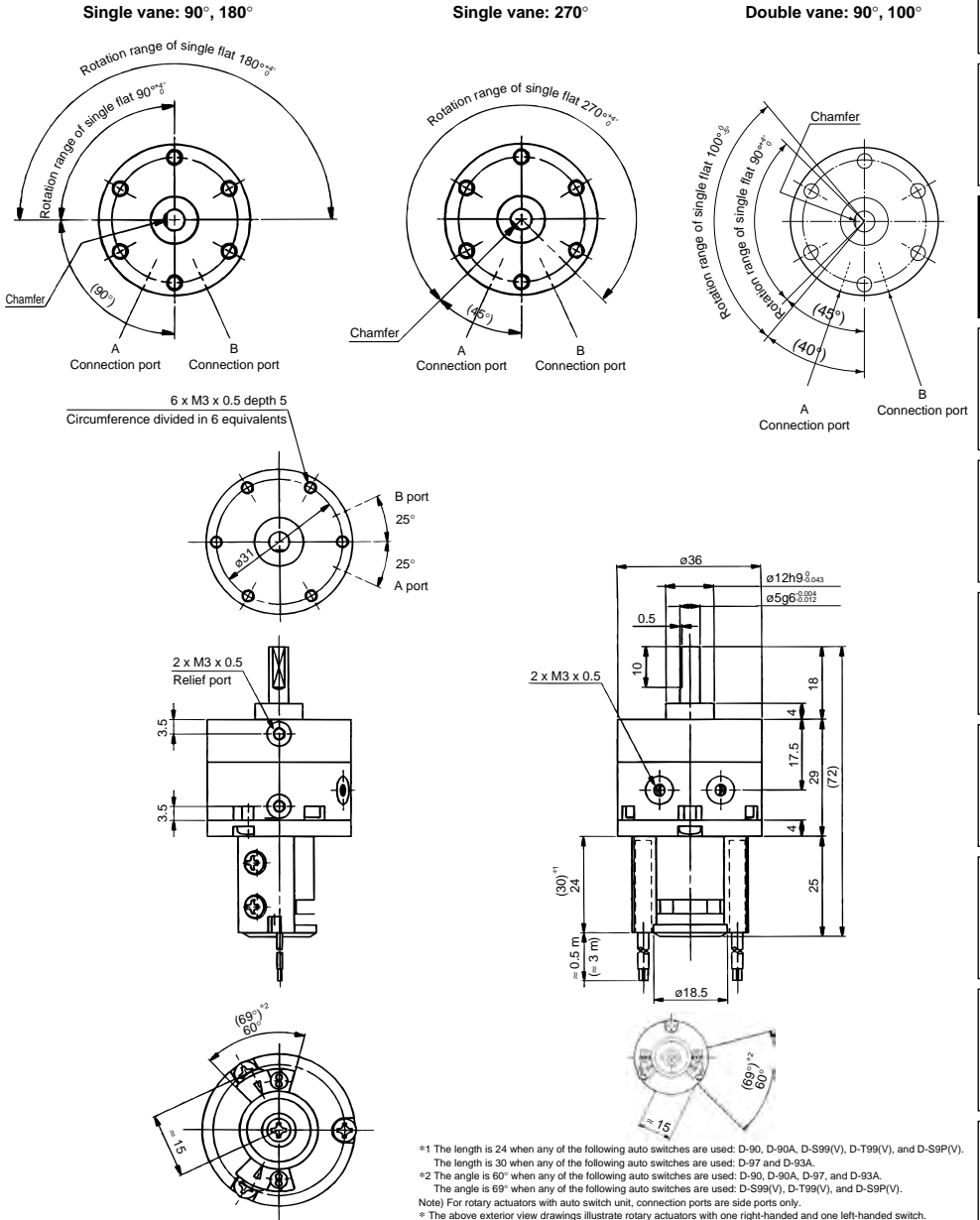

*1 The length is 24 when any of the following auto switches are used: D-90, D-90A, D-S99(V), D-T99(V), and D-S9P(V).
 The length is 30 when any of the following auto switches are used: D-97 and D-93A.
 *2 The angle is 60° when any of the following auto switches are used: D-90, D-90A, D-97, and D-93A.
 The angle is 69° when any of the following auto switches are used: D-S99(V), D-T99(V), and D-S9P(V).
 Note) For rotary actuators with auto switch unit, connection ports are side ports only.
 * The above exterior view drawings illustrate rotary actuators with one right-handed and one left-handed switch.

Directional Control Valves
 Air Cylinders
 Rotary Actuators
 Air Grippers
 Air Preparation Equipment
 Modular F. R.
 Pressure Control Equipment
 Fittings & Tubing
 Flow Control Equipment
 Pressure Switches/ Pressure Sensors

With Auto Switch: 10-21-CDRB1BW20 (Dimensions are common to both single vane and double vane)

Size 20

Rotation range of single vane type (Chamfered positions shown below illustrate the conditions of actuators when B port is pressurized.)

Rotation range of double vane type (Chamfered positions shown below illustrate the intermediate rotation position when A or B port is pressurized.)

Single vane: 90°, 180°

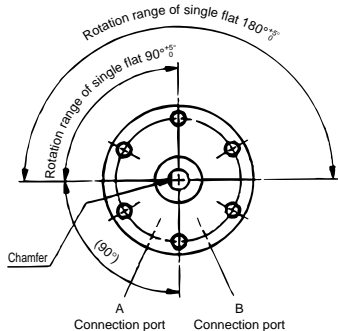

Single vane: 270°

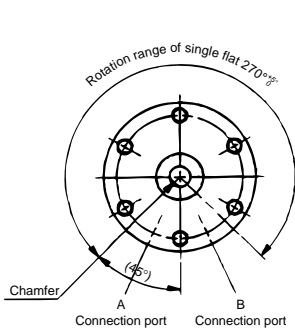

Double vane: 90°, 100°

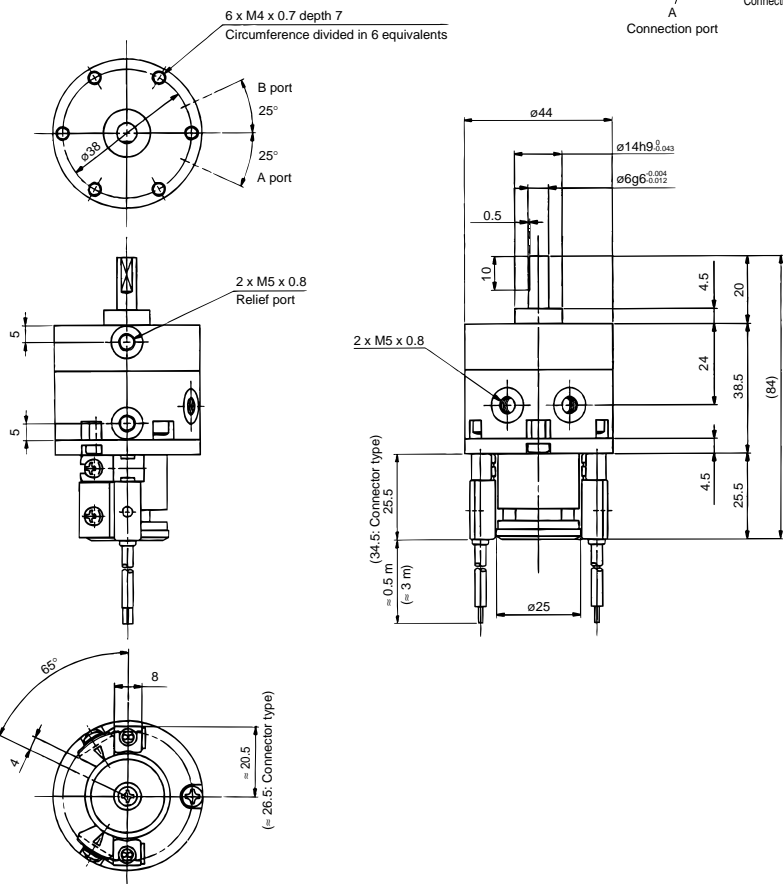
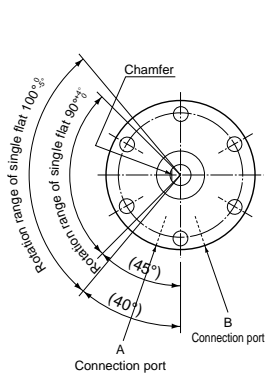

With Auto Switch: 10-21-CDRB1BW30 (Dimensions are common to both single vane and double vane)

Size 30

Rotation range of single vane type (Chamfered positions shown below illustrate the conditions of actuators when B port is pressurized.)

Rotation range of double vane type (Chamfered positions shown below illustrate the intermediate rotation position when A or B port is pressurized.)

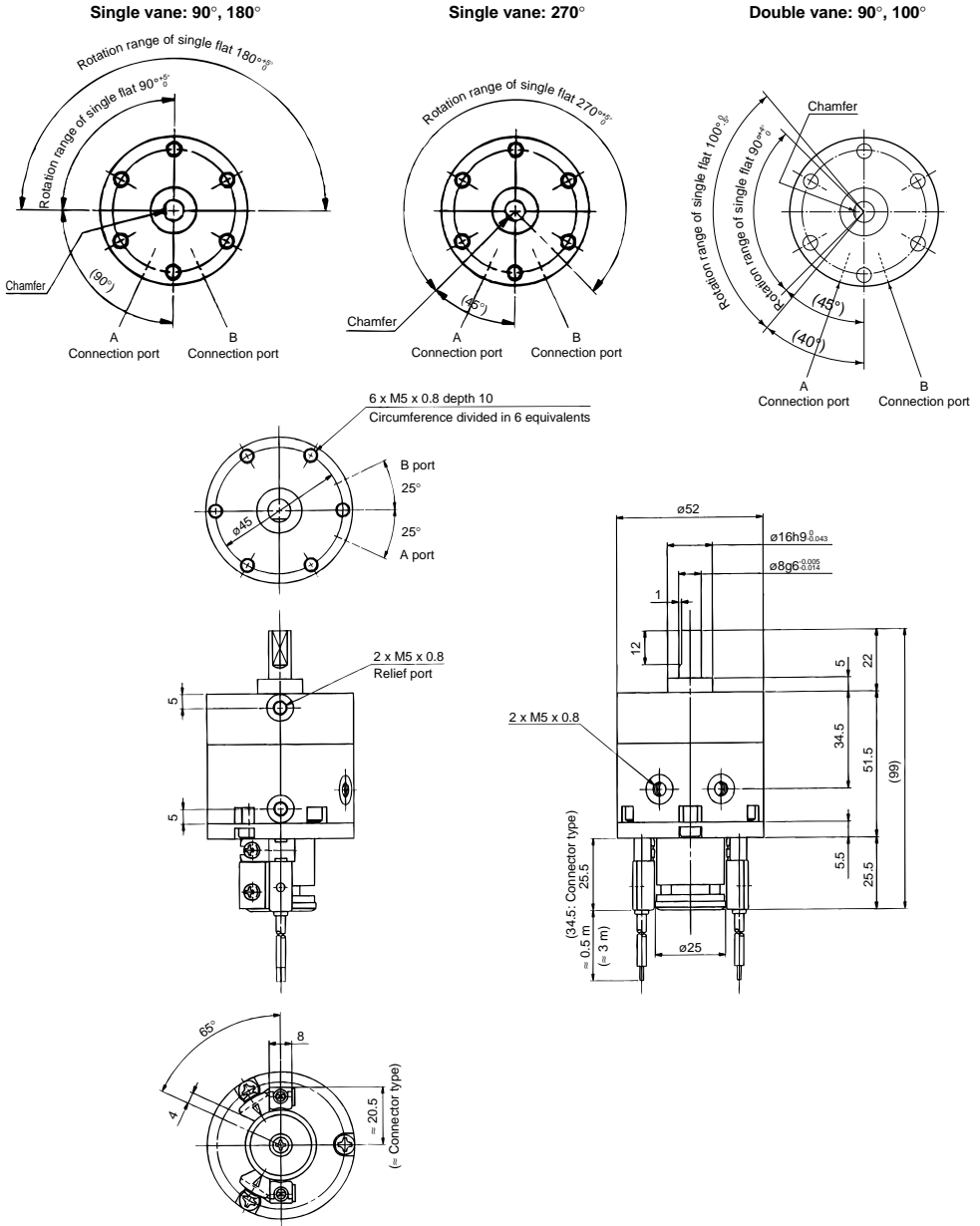

- Directional Control Valves
- Air Cylinders
- Rotary Actuators**
- Air Grippers
- Air Preparation Equipment
- Modular F. R.
- Pressure Control Equipment
- Fittings & Tubing
- Flow Control Equipment
- Pressure Switches/ Pressure Sensors

Series 11-CRA1-Z

Rack & Pinion Type Rotary Actuator
Size: 30, 50

RoHS

How to Order

Clean series
11 Vacuum suction type

Auto switch

Nil	No
D	Built-in magnet

Mounting

B	Basic
L	Foot

Shaft type

S	Single shaft
W	Double shaft

Size

30
50



11 - C D R A 1 B S 50 - 90 Z - M9B

Rotating angle

90	90°
180	180°
100	100°*
190	190°*

* Not available for ø30

Cushion

Nil	Without air cushion
C	With air cushion on both ends

Number of auto switches

Nil	2 pcs.
S	1 pc.

Type of auto switch (For model with auto switch)

Nil	Without auto switch (Built-in magnet cylinder)
-----	--

* For the applicable auto switch model, refer to the table below.
* Auto switches are shipped together, (but not assembled).

Specifications

Size	30	50
Fluid	Air (Non-lube)	
Maximum operating pressure	1 MPa	
Minimum operating pressure	0.1 MPa	
Ambient and fluid temperature	0 to 60°C	
Cushion	With air cushion	Without air cushion, With air cushion
Allowable kinetic energy (J)	Without air cushion	0.01
	With air cushion	0.12
Cushion angle	35°	
Adjustable range of rotation time	0.2 to 1 s/90°	0.2 to 2 s/90°
Port size	M5 x 0.8	Rc1/8
Mounting	Basic, Flange	
Grease	Fluorine grease	
Cleanliness class (ISO class)	Class 4	

* The maximum absorbed energy under proper adjustment of the cushion valve

Suction Flow Rate of Vacuum Suction Type (Reference values)

Size	Suction flow rate L/min (ANR)
30	1
50	5

Auto Switch Specifications (Refer to the WEB catalog for detailed specifications and auto switches not in the following table.)

Type	Auto switch part no.	Load voltage	Load current range	Indicator light	Application
Solid state	2-wire D-M9B	24 VDC (10 to 28 VDC)	2.5 to 40 mA	○	24 VDC relay, PLC
auto switch	3-wire D-M9N, D-M9P	28 VDC or less	40 mA or less	○	IC circuit, Relay, PLC
Reed auto switch	D-A93	24 VDC, 100 VAC	5 to 40 mA, 5 to 20 mA	○	Relay, PLC

Refer to page 920 for the applicable auto switch list.

PLC: Programmable Logic Controller

Rotation Range of Keyway/Switch Mounting Position

11-CDRA1□□30

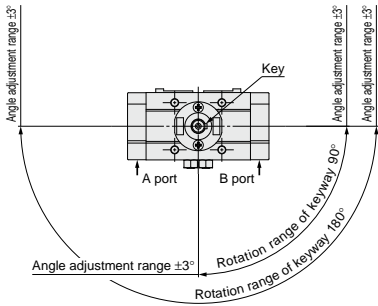

11-CDRA1□□50

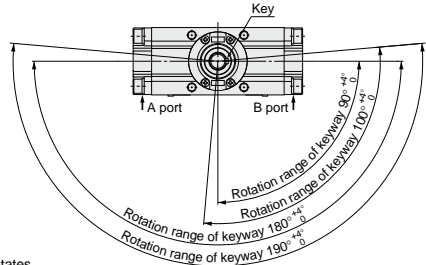

* The shaft rotates clockwise when the pressure is applied from the A port while it rotates counterclockwise when the pressure is applied from the B port.

Auto Switch Proper Mounting Position (Detection at Rotation End)

11-CDRA1□□30

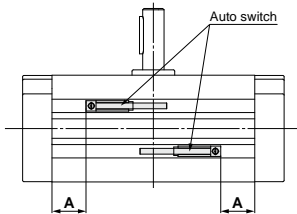

11-CDRA1□□50

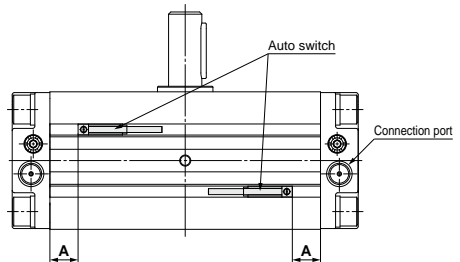

Note) For size 30, the auto switch cannot be mounted on the connection port side since there is a vacuum port.

Size	Rotating angle	D-M9□/M9□V D-M9□W/M9□WV D-M9□A/M9□AV		D-A9□/A9□V	
		Proper mounting position A (mm)	Operating range θ (°)	Proper mounting position A (mm)	Operating range θ (°)
30	90	13	42°	9	81°
	180	22		18	
50	90	22.5	30°	18.5	44°
	180	39		35	

* Values which include hysteresis are for guideline purposes only, they are not a guarantee (assuming approximately $\pm 30\%$ dispersion) and may change substantially depending on the ambient environment. Adjust the auto switch after confirming the operating conditions in the actual setting.

Switch Spacer Part No.

Size	30	50
Switch spacer part no.	BMY3-016	

* The above part number includes one switch spacer.
 * Two switch spacers are included with the product with built-in magnet.

Directional Control Valves

Air Cylinders

Rotary Actuators

Air Grippers

Air Preparation Equipment

Modular F. R.

Pressure Control Equipment

Fittings & Tubing

Flow Control Equipment

Pressure Switches/ Pressure Sensors

Dimensions: Basic Type, 11-C□RA1□S30

Size: 30

Single shaft

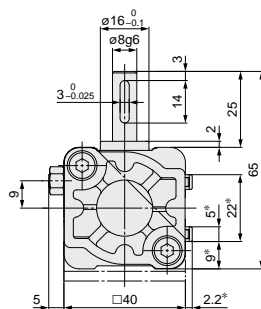
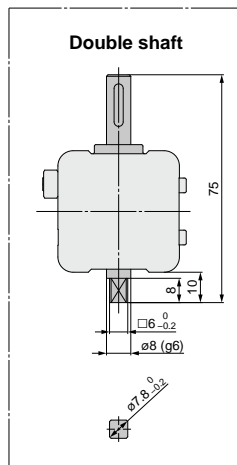
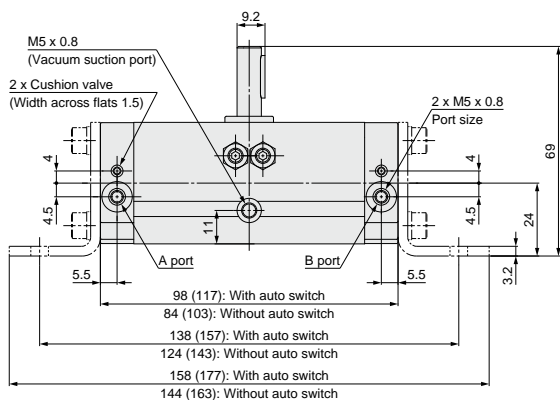
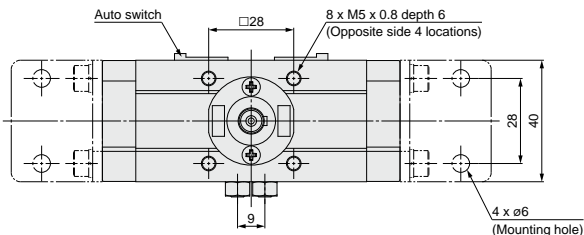
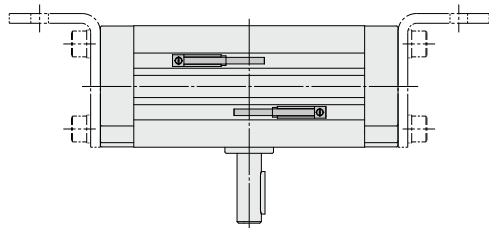

- The dimensions above show pressurization to B port.
 - Drawing shows the auto switch is mounted. (Dimensions with an asterisk mark (*) are not required for actuators without the auto switch.)
 - * () are the dimensions for rotation of 180°.
- Note) A parallel key is included in the same package, (but not assembled).

Dimensions: Basic Type, 11-CRA1S50

Size: 50

Single shaft

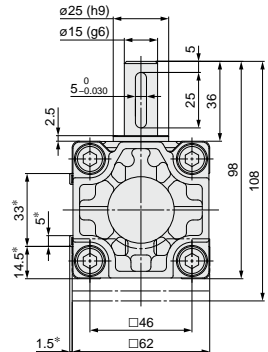
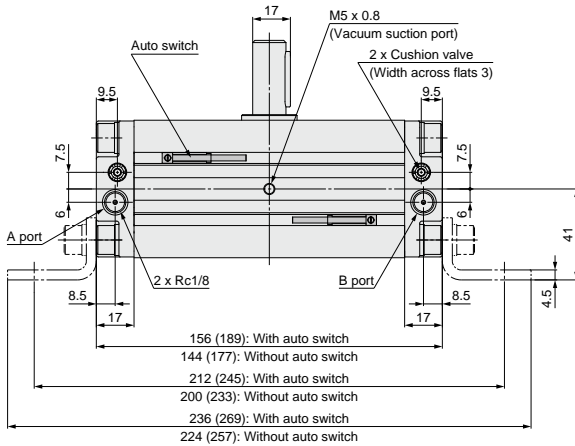
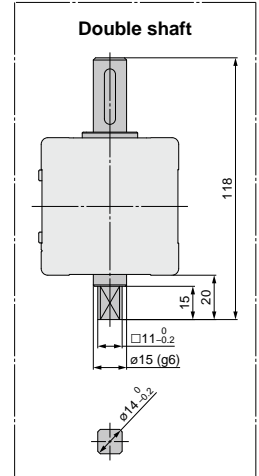
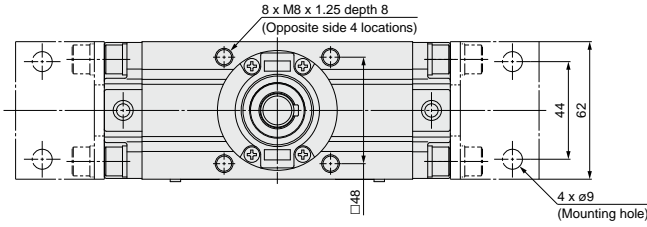

- The dimensions above show pressurization to B port.
 - Drawing shows the auto switch mounted on the port side. (Dimensions with an asterisk mark (*) are not required for actuators without the auto switch, * () are the dimensions for rotation of 180° and 190°.
- Note) A parallel key is included in the same package, (but not assembled).

Directional Control Valves

Air Cylinders

Rotary Actuators

Air Grippers

Air Preparation Equipment

Modular F. R.

Pressure Control Equipment

Fittings & Tubing

Flow Control Equipment

Pressure Switches/ Pressure Sensors

Series 11-22-MSQ

Rack & Pinion Type Rotary Table
Size: 1, 2, 3, 7, 10, 20, 30, 50

How to Order

Size: 1, 2, 3, 7

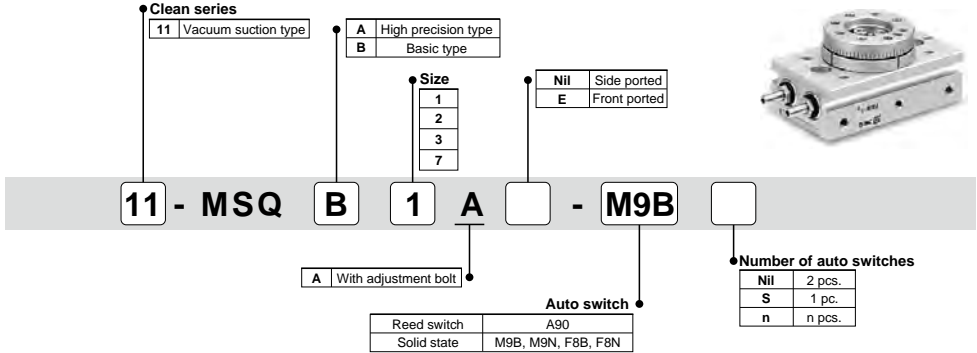

Size: 10, 20, 30, 50

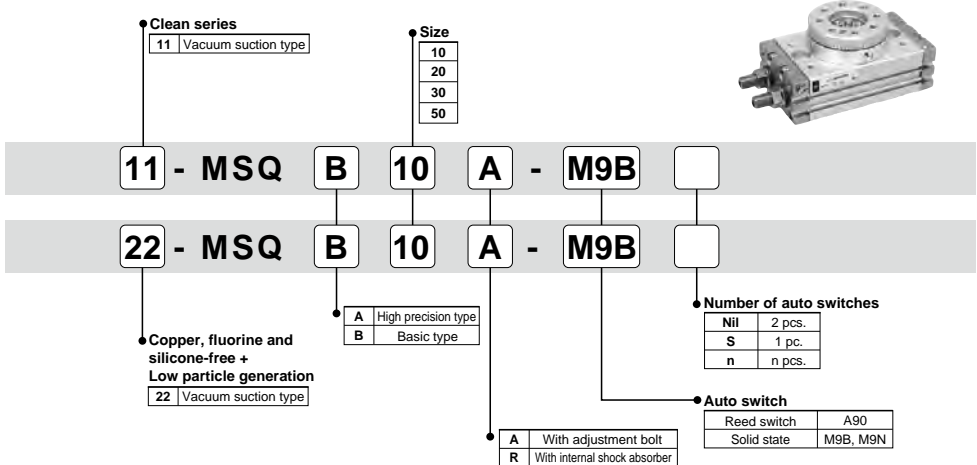

Auto Switch Specifications

Type	Auto switch model	Load voltage	Load current range	Indicator light	Applicable load
Reed auto switch	D-A90	24 VAC or less, 48 VAC or less, 100 VAC or less 24 VDC or less, 48 VDC or less, 100 VDC or less	50 mA, 40 mA, 20 mA	No	IC circuit, Relay, PLC
Solid state auto switch	2-wire D-M9B, D-F8B	24 VDC (10 to 28 VDC)	2.5 to 40 mA	Yes	24 VDC relay, PLC
	3-wire D-M9N, D-F8N	24 VDC (4.5 to 28 VDC)	40 mA or less	Yes	24 VDC relay, PLC

Refer to page 920 for the applicable auto switch list.

Specifications

Size		1	2	3	7	10	20	30	50
Fluid		Air (Non-lube)							
Maximum operating pressure	With adjustment bolt	0.7 MPa			1 MPa				
	With internal shock absorber	Not available			0.6 MPa				
Minimum operating pressure	Basic type	0.1 MPa							
	High precision type	0.1 MPa			0.2 MPa		0.1 MPa		
Ambient and fluid temperature		0 to 60°C (No freezing)							
Cushion	With adjustment bolt	Not available			Rubber bumper				
	With internal shock absorber	Not available			Shock absorber				
Allowable kinetic energy (mJ)	With adjustment bolt	1	1.5	2	6	7	25	48	81
	With internal shock absorber	Not available			39		116		294
Angle adjustment range		0 to 190°							
Maximum rotating angle		190°							
Rotation time adjustment range	With adjustment bolt	0.2 to 0.7 s/90°			0.2 to 1.0 s/90°				
	With internal shock absorber	Not available			0.2 to 0.7 s/90°				
Port size		M3 x 0.5			M5 x 0.8		Rc 1/8, M5 x 0.8		
Grease		11-: Fluorine grease							
		22-: Lithium soap based grease							
Cleanliness class (ISO class)		11-: Class 3							
		22-: Class 3							

Suction Flow Rate of Vacuum Suction Type (Reference values)

Size	Suction flow rate L/min (ANR)
1/2/3/7	1
10/20/30/50	

Rotation Range Example

- The rotary table turns in the clockwise direction when the A port is pressurized, and in the counterclockwise direction when the B port is pressurized.
- By adjusting the adjustment bolt, the rotation end can be set within the ranges shown in the drawing for the desired rotation angle.
- The rotation angle can also be set on a type with internal shock absorber.

Size: 1 to 7

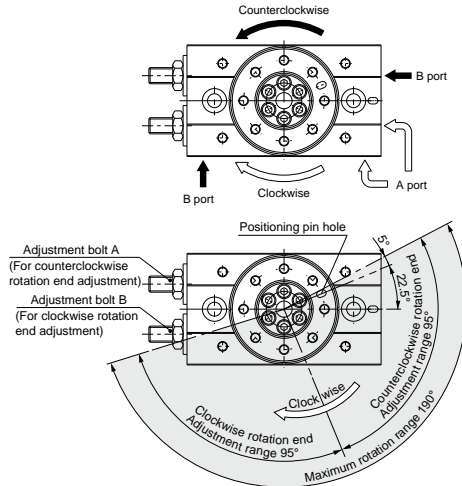

Note) · The drawing shows the rotation range of the positioning pin hole.
 · The pin hole position in the drawing shows the counterclockwise rotation end when the adjustment bolts A and B are tightened equally and the rotation is adjusted 180°.

With adjustment bolt, internal shock absorber

Size	Adjustment angle per rotation of angle adjustment bolt
1	8.2°
2	10.0°
3	10.9°
7	10.2°

Size: 10 to 50

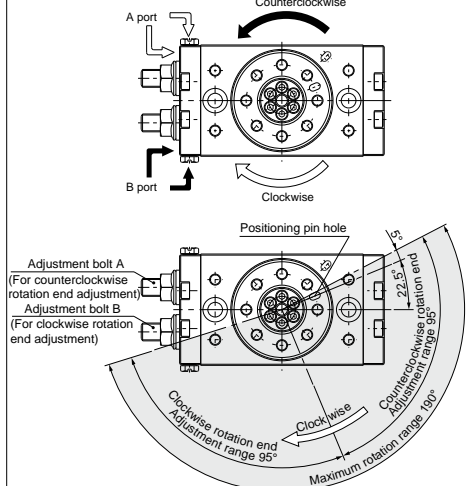

Note) · The drawing shows the rotation range of the positioning pin hole.
 · The pin hole position in the drawing shows the counterclockwise rotation end when the adjustment bolts A and B are tightened equally and the rotation is adjusted 180°.

With adjustment bolt, internal shock absorber

Size	Adjustment angle per rotation of angle adjustment bolt
10	10.2°
20	7.2°
30	6.5°
50	8.2°

Auto Switch Proper Mounting Position (Detection at Rotation End)

Size: 1 to 7

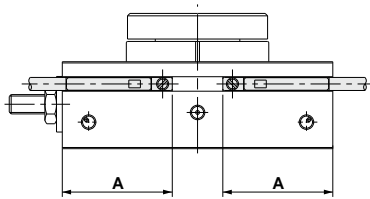

D-F9, M9

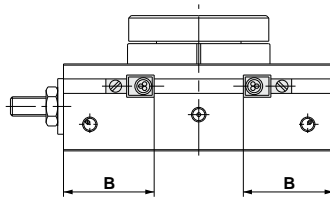

D-F8

Size	Rotating angle	Solid state auto switch					
		D-M9□			D-F8□		
		A	Operating angle θ m	Hysteresis angle	B	Operating angle θ m	Hysteresis angle
1	190°	20.9	49°	10°	16.9	20°	10°
2	190°	22.8	50°	10°	18.8	20°	10°
3	190°	24.4	47°	10°	20.4	15°	10°
7	190°	28.7	31°	10°	24.7	15°	10°

Operating angle θ m: Converts the operating range (Lm) of the auto switch into the rotation angle
 Angle of hysteresis: The hysteresis of the auto switch is converted to degrees.

Size: 10 to 50

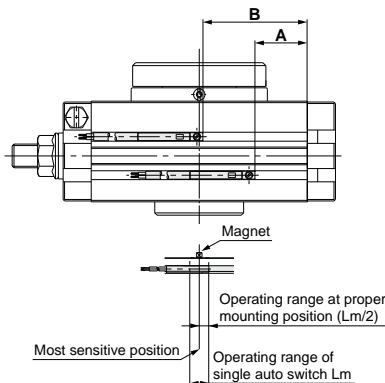

Size	Rotating angle	Reed auto switch				Solid state auto switch			
		D-A9□, D-A9□V				D-M9□			
		A	B	Operating angle θ m	Hysteresis angle	A	B	Operating angle θ m	Hysteresis angle
10	190°	27	45	90°	10°	31	49	42°	10°
20	190°	35	62	80°	10°	39	66	35°	10°
30	190°	39	68	65°	10°	43	72	30°	10°
50	190°	49	83	50°	10°	53	87	24°	10°

Operating angle θ m: Converts the operating range (Lm) of the auto switch into the rotation angle
 Angle of hysteresis: The hysteresis of the auto switch is converted to degrees.

Dimensions: Size 1, 2, 3, 7

Basic type: 11-MSQB□A

High precision type: MSQA□A

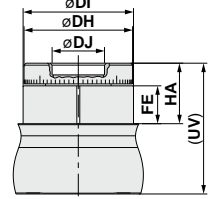
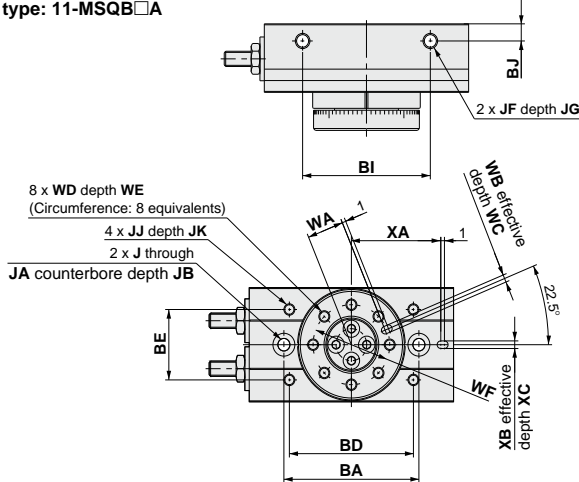

Size	DH	DI	DJ	FE	HA	UV
1	27h8	27.5h8	14H8	8.2	13.5	29.5
2	29h8	29.5h8	14H8	9.7	15.5	33.5
3	33h8	34h8	17H8	9.7	15.5	36
7	39h8	40h8	20H8	9.5	16.5	39.5

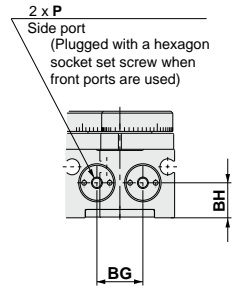
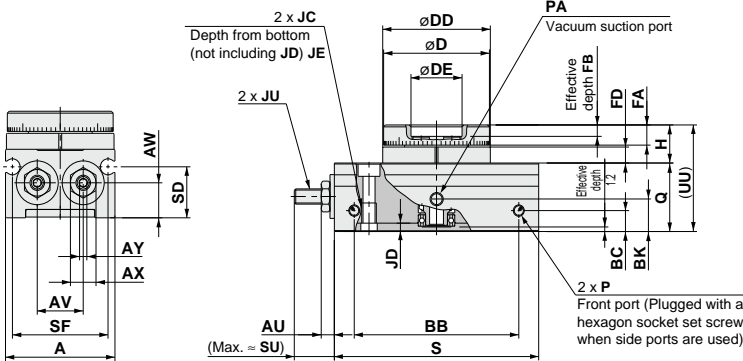

Size	A	AU	AV	AW	AX	AY	BA	BB
1	28	2.8	11	8.2	5.5	1.5	35	39.6
2	30	3.6	12.6	9.2	7	2	37	45.1
3	34.5	4.4	15.5	10.5	8	2.5	43	46.7
7	41	4.8	18.4	12.2	10	3	50	59.2

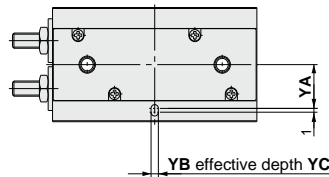

Size	BC	BD	BE	BG	BH	BI	BJ	BK	D	DD	DE	FA	FB	FD	H	J	JA	JB	JC	JD	JE	JF	JG
1	4.5	32	17	11	8.2	30	4.5	5.3	27h9	27.5h9	14H9	4.8	2	3.7	9	3.3	6	3.5	M4 x 0.7	2.2	5.3	M4 x 0.7	4
2	5.5	34	18.5	12.6	9.2	35	4.5	7.5	29h9	29.5h9	14H9	5.3	2.5	4.2	10	3.3	6	3.5	M4 x 0.7	2.2	5.3	M4 x 0.7	4
3	5.5	38	23	15.5	10.5	40	4.5	9.5	33h9	34 h9	17H9	5.3	2.5	4.2	10	4.2	7.5	4.5	M5 x 0.8	2.5	6	M4 x 0.7	4
7	5.5	45	30	18.4	12.2	50	5	7	39h9	40 h9	20H9	6.5	2.5	4.5	11.5	4.2	7.5	4.5	M5 x 0.8	2.5	6	M5 x 0.8	5

Size	JJ	JK	JU	P	PA	Q	S	SD	SF	SU	UU	WA	WB	WC	WD	WE	WF	XA	XB	XC	YA	YB	YC
1	M3 x 0.5	3.5	M3 x 0.5	M3 x 0.5	M3 x 0.5	16	50.5	10.8	24.4	9.4	25	9.5	2H9	2	M3 x 0.5	4.8	20	22.5	2H9	2	11	2H9	2
2	M3 x 0.5	3.5	M4 x 0.7	M3 x 0.5	M3 x 0.5	18	56	13.4	26.2	11.3	28	10	2H9	2	M3 x 0.5	5.3	21	24.5	2H9	2	11.5	2H9	2
3	M3 x 0.5	3.5	M5 x 0.8	M3 x 0.5	M3 x 0.5	20.5	60	15.2	31	11.8	30.5	12	2H9	2	M3 x 0.5	5.3	25	27	2H9	2	13.5	2H9	2
7	M4 x 0.7	4.5	M6 x 1	M5 x 0.8	M5 x 0.8	23	73.5	15.4	37.4	14.9	34.5	14	3H9	3	M4 x 0.7	6.5	29	32.5	3H9	3	15.5	3H9	3

Directional Control Valves
Air Cylinders
Rotary Actuators
Air Grippers
Air Preparation Equipment
Modular F. R.
Pressure Control Equipment
Fittings & Tubing
Flow Control Equipment
Pressure Switches/ Pressure Sensors



Rotary Actuators Precautions 1

Be sure to read this before handling.

Design/Selection

Warning

1. Confirm the specifications.

Products represented in this catalog are designed only for use in compressed air systems (including vacuum). Do not operate at pressures or temperatures, etc., beyond the range of specifications, as this can cause damage or malfunction. (Refer to the specifications.) Please contact SMC when using a fluid other than compressed air (including vacuum). We do not guarantee against any damage if the product is used outside of the specification range.

2. If the operation involves load fluctuations, ascending/descending movements, or changes in frictional resistance, make sure to provide safety measures.

Operating speed will increase, and bodily injury may occur, or damage to the machinery itself may occur.

3. If there is a chance that the product will pose a hazard to humans, install a protective cover.

If the moving portion of the product will pose a hazard to humans or will damage machinery or equipment, provide a construction that prevents direct contact with those areas.

4. Be certain that the secured portions will not loosen.

Be certain to adopt a reliable connecting method if the rotary actuator is used very frequently or if it is used in a location that is exposed to a large amount of vibration.

5. There may be cases in which a speed reduction circuit or a shock absorber is required.

If the driven object moves at high speeds or is heavy, it will be unfeasible for only the rotary actuator's cushion to absorb the shock. Therefore, provide a speed-reduction circuit to reduce the rotary actuator's speed before the thrust is applied to the cushion, or an external shock absorber to dampen the shock. If these countermeasures are taken, make sure to take the rigidity of the machinery and equipment into consideration.

6. Consider the possibility of a reduction in the circuit air pressure caused by a power failure.

When an actuator is used as clamping mechanism, there is a danger of workpiece dropping if there is a decrease in clamping force, due to a drop in circuit pressure caused by a power failure. Therefore, safety equipment should be installed to prevent damage to machinery/equipment and bodily injury.

7. Consider the possibility of power source related malfunctions that could occur.

For the machinery and equipment that rely on power sources such as compressed air, electricity, or hydraulic pressure, adopt a countermeasure to prevent the equipment from causing a hazard to humans or damage to the machinery and equipment in the event of malfunction.

8. If a speed controller is provided in the exhaust restrictor, implement a safety design taking the residual pressure into consideration.

If air pressure is applied to the air supply side without residual pressure in the exhaust side, the rotary actuator will operate at abnormally high speed, which could pose a hazard to humans and can damage the machinery and equipment.

9. Consider the behavior of the rotary actuator in the event of an emergency stop.

Devise a safe system so that if a person engages the emergency stop, or if a safety device is tripped during a system malfunction such as a power failure, the movement of the rotary actuator will not cause a hazard to humans or damage the equipment.

10. Consider the action of the rotary actuator when restarting after an emergency stop.

Devise a safe design so that the restarting of the rotary actuator will not pose a hazard to humans or damage the equipment. Install manually controlled equipment for safety when the actuator has to be reset to the starting position.

11. Do not use the product as a shock absorber.

If an abnormal pressure or air leakage occurs, the rotary actuator's speed reduction capability could become severely effected, which could pose a hazard to humans and damage the machinery and equipment.

12. Select a speed within the product's allowable energy value.

If the product's kinetic energy of the load exceeds the allowable value, it could damage the product (damage to the shaft, gear, etc.), and cause a hazard to humans and damage the machinery and equipment.

13. Provide a shock absorber if the kinetic energy that is applied to the product exceeds the allowable value.

If the product's kinetic energy exceeds the allowable value, it could damage the product (damage to the shaft, gear, etc.), and cause a hazard to humans and damage the machinery or equipment.

14. Do not stop or hold the product at midpoint by keeping air pressure in the product. (Air balancers etc.)

For a product lacking an external stopping mechanism, if the directional control valve is closed to keep the air pressure in the product, in an attempt to stop the product at midpoint, it might not be possible to maintain that stopped position due to an air leakage. As a result, it could pose a hazard to humans and cause damage to machinery and/or equipment.

15. Give consideration to the decline in strength caused by changes of the shaft type.

Some shaft types, such as simple specials, may have shapes and dimensions that result in decreased strength when compared with standard models. Consider this carefully when using.

16. Do not use two or more rotary actuators with the aim of synchronized movement.

One of the actuators may bear the load of operation, making synchronized movement impossible, and possibly leading to deformation of the equipment.

17. Do not use in a location where adverse effect could be occurred by the oozing of the lubricant to the exterior.

The lubricant coating the interior of the product may leak to the outside of the product from the portion of the connection of the rotary shaft, body cover, etc.

18. Do not disassemble the product or make any modifications, including additional machining.

It may cause human injury and/or an accident.

19. Refer to the Auto Switches Precautions (pages 879 to 883) for using with an auto switch.

Directional
Control Valves

Air Cylinders

Rotary Actuators

Air Grippers

Air Preparation
Equipment

Modular F. R.

Pressure Control
Equipment

Fittings & Tubing

Flow Control
Equipment

Pressure Switches/
Pressure Sensors



Rotary Actuators Precautions 2

Be sure to read this before handling.

Design/Selection

⚠ Caution

1. Do not use below the speed adjustment range specified for the product.

If the product is used below the specified speed adjustment range, it could cause the product to stick, slip, or the movement to stop.

2. Do not apply an external torque to the product that exceeds the rated output.

If an external force that exceeds the product's rated output is applied to the product, it could damage the product.

3. The holding torque of the rotating end of the double piston type.

If the internal piston of a double piston product comes in contact with the angle adjustment screen or the cover and stops, the holding torque at the rotating end is one half of the actual output.

4. If it is necessary to provide repeatability of the rotation angle, directly stop the load externally.

Even with a product that is equipped with an angle adjuster, there are times in which the initial rotation angle could change.

5. Do not use under hydraulic pressure.

The product will be damaged if it is used by applying hydraulic pressure.

6. There is a possibility of backlash being generated when stopping the double piston type in the middle with a valve of the closed center type.

7. For the vane type product, if it is necessary to ensure a rotation angle, make sure to use a minimum pressure of 0.3 MPa.

8. Do not use the Made-to-Order -XC30 at low speeds.

Although fluorine grease is used, it is not designed for low-speed applications.

For information on fluorine grease, refer to the Material Safety Data Sheet (MSDS).

9. Do not use in places where there are many temperature fluctuations. When using in lower temperature applications, use caution so that frost does not occur inside the cylinder or the piston rod.

Operation may be unstable.

10. Adjust the speed control in the environment in which it will be used in.

Speed adjustment may be changed if the environment is different.

Mounting

⚠ Warning

1. Operation manual

Install the product and operate it only after reading the operation manual carefully and understanding its contents. Also, keep the manual in a location where it can be referred to as necessary.

Mounting

⚠ Warning

2. Ensure sufficient space for maintenance activities.

When installing the products, allow access for maintenance.

3. Tighten threads with the proper tightening torque.

When installing the products, follow the listed torque specifications.

4. Before adjusting the angle by supplying air pressure, take appropriate measures to prevent the equipment from rotating unnecessarily.

When an adjustment is performed under air pressure, the equipment could rotate and fall during the adjustment, depending on the mounted placement of the equipment. As a result, it could pose a hazard to humans and damage the machinery and equipment.

5. Do not loosen the angle adjustment screw beyond the allowable adjustment range.

The angle adjustment screw could fall out if it is loosened beyond its allowable adjustment range and cause a hazard to humans and damage to machinery and equipment.

6. Do not place a magnetic object near the product.

The auto switch is a magnetic sensing type. If a magnetic object is placed close to it, the rotary actuator could operate suddenly, which could pose a hazard to humans and damage the machinery and equipment.

7. Do not perform additional machining to the product.

Additional machining to the product can result in insufficient strength and cause damage to the product. This can lead to possible human injury and damage to the surrounding equipment.

8. Do not enlarge the fixed throttle by modifying the pipe connectors.

If the hole diameter is enlarged, the product's rotation speed will increase, causing the shock force to increase and damage to the product. As a result, it could pose a hazard to humans and damage the machinery and equipment.

9. If shaft couplings are used, use those with angular freedom.

If shaft couplings that lack angular freedom are used, they could scrape due to eccentricity, leading to equipment malfunction and product damage. As a result, it could pose a hazard to humans and damage the machinery and equipment.

10. Do not apply to the shaft a load that exceeds the values given in a catalog.

If a load that exceeds the allowable value is applied to the product, it could lead to equipment malfunction, a hazard to humans, and damage to the machinery and equipment. Provided that a dynamic load is not generated, a load that is within the allowable radial/thrust load can be applied. However, applications in which the load is applied directly to the shaft should be avoided wherever possible. The methods such as those described below are recommended to prevent the load from being applied directly to the shaft in order to ensure a proper operating condition.

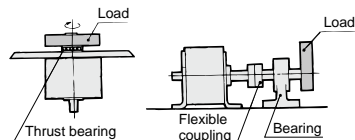



Rotary Actuators Precautions 3

Be sure to read this before handling.

Mounting

Warning

11. Place an external stopper in a position that is away from the rotating shaft.

If the stopper is placed near the rotating shaft, the torque that is generated by the product itself will cause the reaction force which is directed to the stopper to be redirected and applied to the rotating shaft. This will lead to the breakage of the rotating shaft and bearing. As a result, it could pose a hazard to humans and damage the machinery and equipment.

Precautions when Using External Stoppers

- Be sure to install external stoppers in the proper places. Installation in the wrong place can result in equipment breakage, which could damage other equipment or cause human injury.

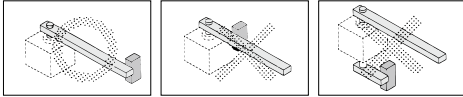

Install the stopper at a sufficient distance from the rotating shaft.

The external stopper becomes a fulcrum, resulting in the load's inertia force being applied to the shaft as a bending moment.

If an external stopper is installed on the shaft side which is opposite of the load, the inertia force generated by the load is applied directly to the shaft.

- Install external stoppers within the range of the rotating shaft angle. Installing an external stopper at the maximum rotation angle may result in inability to fully absorb the kinetic energy generated, and damage to equipment may occur. When using external stoppers at rotation angles of 90°, 180°, or 270°, use products with rotation angles of 100°, 190°, or 280° respectively.

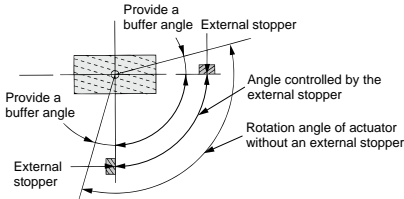

Backlash of the Single Rack Pinion Type CRA1 Series

There is a backlash of within 1° at the rotation end of the CRA1 series. It is necessary to decide the position of the external stopper when precise rotation is required.

Precautions when Converting Rotational Motion to Linear Motion

When using a link mechanism, etc., to convert rotational motion to linear motion, and determining the operation end using the stopper on the linear motion end (see below), a small value for θ at the operation end may result in the torque of the rotary actuator causing excessive radial load to act on the output axle, and equipment breakage may occur.

Install a stopper on the rotational motion side, or increase the value of θ at the operation end, to make sure the load generated does not exceed the allowable value for the product.

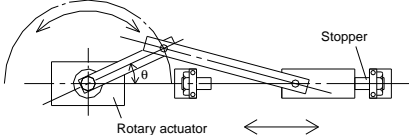

12. Do not use springs, etc., to add force in the rotational movement direction.

When rotational force from an external spring, etc., acts and generates negative pressure on the product's interior, breakage of the internal seal or acceleration of abrasion may occur.

Caution

1. Observe the specified torque to secure the block of the angle adjustment unit.

If it is secured with a torque that is lower than the specified torque, the block could become loosened during use, causing the angle to exceed the set angle.

2. Do not use organic solvent to wipe the area of the name plate that shows the model.

It will erase what is indicated on the name plate.

3. Do not hit the rotating shaft by securing the body or hit the body by securing the rotating shaft.

These actions could cause the shaft to bend or damage the bearing. When a load must be coupled to the rotating shaft, secure the rotating shaft.

4. Do not place your foot directly on the shaft or on the equipment that is coupled to the shaft.

Placing one's weight directly onto the rotating shaft could cause the rotating shaft or the bearing to become damaged.

5. If a product is equipped with an angle adjustment function, use it within the specified adjustment range.

If the product is used outside the specified adjustment range, it could lead to equipment malfunction or product damage. Refer to the product specifications for details on the adjustment range of the products.

Piping

Caution

1. Refer to the Fittings and Tubing Precautions (pages 1237 to 1240) for handling One-touch fittings.

2. Preparation before piping

Before piping is connected, it should be thoroughly flushed out with air or washed to remove chips, cutting oil and other debris from inside the pipe.

3. Winding of sealant tape

When screwing piping or fittings into ports, ensure that chips from the pipe threads or sealing material do not enter the piping. Also, if sealant tape is used, leave 1.5 to 2 thread ridges exposed at the end of the threads.

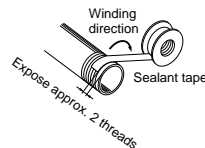

Directional Control Valves
Air Cylinders
Rotary Actuators
Air Grippers
Air Preparation Equipment
Modular F. R.
Pressure Control Equipment
Fittings & Tubing
Flow Control Equipment
Pressure Switches/Pressure Sensors



Rotary Actuators Precautions 4

Be sure to read this before handling.

Speed and Cushion Adjustment

Warning

1. To make a speed adjustment, gradually adjust starting from the low speed end.

If the speed adjustment is performed from the high speed end, it could damage the product. As a result, it could pose a hazard to humans and damage the machinery and equipment.

2. The cushion needle is not adjusted at the time of shipment. Therefore, an adjustment must be made in accordance with the operating speed and the moment of inertia of the load.

The absorption of kinetic energy by the bumper is regulated by the adjustment of the needle. An improper adjustment could lead to damage of the equipment and the product. As a result, it could pose a hazard to humans and damage the machinery and equipment.

3. Do not operate with the cushion needle in a fully closed condition.

This could tear the seal, which could pose a hazard to humans and damage the machinery and equipment.

4. Do not apply an excessive force to loosen the cushion needle.

The needle itself is provided with a pull stop. However, the pull stop could be damaged if the needle is loosened through the application of excessive force. As a result, it could pose a hazard to humans and damage the machinery and equipment.

5. For products with shock absorbers, when the shock absorber stops motion before reaching the stroke end using a stopper mechanism with the objective of shortening takt time, be sure the shock absorber is stopped in a position where it has adequately absorbed the kinetic energy.

Failure to do so can result in damage to equipment.

Lubrication

Warning

1. This product should be used without lubrication. If it is lubricated, it could lead to sticking or slipping.

Air Supply

Warning

1. Type of fluids

Please consult with SMC when using the product in applications other than compressed air.

2. When there is a large amount of drainage.

Compressed air containing a large amount of drainage can cause malfunction of pneumatic equipment. An air dryer or water separator should be installed upstream from filters.

3. Drain flushing

If condensation in the drain bowl is not emptied on a regular basis, the bowl will overflow and allow the condensation to enter the compressed air lines. It causes malfunction of pneumatic equipment.

If the drain bowl is difficult to check and remove, installation of a drain bowl with an auto drain option is recommended.

For compressed air quality, refer to SMC Best Pneumatics No.5 catalog.

4. Use clean air.

Do not use compressed air that contains chemicals, synthetic oils including organic solvents, salt or corrosive gases, etc., as it can cause damage or malfunction.

Caution

1. When extremely dry air is used as the fluid, degradation of the lubrication properties inside the equipment may occur, resulting in reduced reliability (or reduced service life) of the equipment. Please consult with SMC.

2. Install an air filter.

Install an air filter upstream near the valve. Select an air filter with a filtration size of 5 μm or smaller.

3. Take measures to ensure air quality, such as by installing an aftercooler, air dryer, or water separator.

Compressed air that contains a large amount of drainage can cause malfunction of pneumatic equipment such as rotary actuators. Therefore, take appropriate measures to ensure air quality, such as by providing an aftercooler, air dryer, or water separator.

4. Ensure that the fluid and ambient temperature are within the specified range.

If the fluid temperature is 5°C or less, the moisture in the circuit could freeze, causing damage to the seals and equipment malfunction. Therefore, take appropriate measures to prevent freezing.

For compressed air quality, refer to SMC Best Pneumatics No.5 catalog.



Rotary Actuators Precautions 5

Be sure to read this before handling.

Operating Environment

⚠ Warning

- 1. Do not use in an atmosphere having corrosive gases, chemicals, sea water, water, water steam, or where there is direct contact with any of these.**
Refer to the construction for information on the rotary actuators material.
- 2. Do not expose the product to direct sunlight for an extended period of time.**
- 3. Do not use in a place subject to heavy vibration and/or shock.**
- 4. Do not mount the product in locations where it is exposed to radiant heat.**
- 5. Do not use in dusty locations or where water or oil, etc., splash on the equipment.**

Maintenance

⚠ Warning

- 1. Perform maintenance inspection according to the procedures indicated in the operation manual.**

If handled improperly, malfunction and damage of machinery or equipment may occur.

- 2. Maintenance work**

If handled improperly, compressed air can be dangerous. Assembly, handling, repair and element replacement of pneumatic systems should be performed by a knowledgeable and experienced person.

- 3. Drain flushing**

Remove drainage from air filters regularly.

- 4. Removal of equipment, and supply/exhaust of compressed air**

When components are removed, first confirm that measures are in place to prevent workpieces from dropping, run-away equipment, etc. Then, cut off the supply pressure and electric power, and exhaust all compressed air from the system using the residual pressure release function.

When machinery is restarted, proceed with caution after confirming that appropriate measures are in place to prevent cylinders from sudden movement.

⚠ Caution

- 1. For lubrication, use the designated grease for each specific product.**

The use of a non-designated lubricant could damage the seals.

Directional
Control Valves

Air Cylinders

Rotary Actuators

Air Grippers

Air Preparation
Equipment

Modular F. R.

Pressure Control
Equipment

Fittings & Tubing

Flow Control
Equipment

Pressure Switches/
Pressure Sensors



Rotary Actuators Precautions 6

Be sure to read this before handling.

For Air-hydro Type

Please read this page along with the Rotary Actuators Precautions.

Design

Warning

1. Do not use the product near flames, or in equipment or machinery that exceeds an ambient temperatures of 60°C.

There is a danger of causing a fire because the air-hydro type uses a flammable hydraulic fluid.

Refer to the Material Safety Data Sheet (MSDS) of the hydraulic fluid when supplying the fluid.

2. Do not use the product in a clean room.

Caution

1. Do not use in an environment, equipment, or machine that is not compatible with oil mist.

The air-hydro type generates an oil mist during operation which may affect the environment.

2. Be certain to install an exhaust cleaner on the directional control valve for the air-hydro type.

A very small amount of hydraulic fluid is discharged from the exhaust port of a directional control valve, which may contaminate the surrounding area.

3. Install the air-hydro type in locations where it can be serviced easily.

Since the air-hydro type requires maintenance, such as refilling of hydraulic fluid and bleeding of air, ensure sufficient space for these activities.

Selection

Caution

1. Select an air-hydro type in combination with an air-hydro unit.

Since good operation of an air-hydro type depends on its combination with an air-hydro unit, carefully select an appropriate air-hydro unit.

Piping

Warning

1. For air-hydro type piping, use self-aligning fittings.

Do not use One-touch fittings in the piping for an air-hydro type, because oil leakage may occur.

2. For air-hydro type piping, use hard nylon tubing or copper piping.

As in the case of hydraulic circuits, surge pressures greater than the operating pressure may occur in an air-hydro type piping, making it necessary to use safer piping materials.

Lubrication

Warning

1. Completely discharge the compressed air in the system before filling the air-hydro unit with hydraulic oil.

When supplying hydraulic fluid to the air-hydro unit, first confirm that safety measures are implemented to prevent dropping of objects and the release of clamped objects, etc. Then, shut off the air supply and the equipment's electric power and exhaust the compressed air in the system.

If the air-hydro unit's supply port is opened with compressed air still remaining in the system, there is a danger of hydraulic fluid being blown out.

Refer to the Material Safety Data Sheet (MSDS) of the hydraulic fluid when supplying the fluid.

2. Use petroleum hydraulic fluid which can be used as turbine oil.

If non-flammable hydraulic fluid is used, it may cause problems.

Suitable viscosity is in the range of approximately 40 to 100 mm²/s in operating temperature.

The suitable operating temperature for ISO VG32 is the range of 15 to 35°C. If the operating temperature range is beyond ISO VG32, select ISO VG46 (suitable for 25 to 45°C range).

Note) Refer to the SMC website for details about each manufacturer's brand name of class 1 turbine oil (no additive) ISO VG32. Additionally, please contact SMC for details about class 2 turbine oil (with additives) ISO VG32.

Maintenance

Caution

1. Bleed air from the air-hydro type on a regular basis.

Since air may accumulate inside the air-hydro type, bleed air from it, for example before starting work. Bleed air from a bleeder valve provided on the air-hydro type or the piping.

2. Verify the oil level of the air-hydro system on a regular basis.

Since a very small amount of hydraulic fluid is discharged from the air-hydro type and the air-hydro unit circuit, the fluid will gradually decrease. Therefore, check the fluid regularly and refill as necessary.

The oil level can be checked with a level gauge in the air-hydro converter.

Rotary Actuator Applicable Auto Switch List

Type	Auto switch mounting	Electrical entry	Auto switch model	Applicable rotary actuators						
				Size						
				11- CDRA1		10-/21- CDRB1		11-/22- MSQ		
				30	50	10, 15	20, 30	1 to 7	10 to 50	
Reed auto switch	Direct	Grommet	D-90, 97			●				
			D-A90, A93, A96 D-A90V, A93V, A96V	●	●			●	●	
			D-90A, 93A			●				
			D-R731, R732				●			
		D-R801, R802					●			
		Connector	D-R731C, R732C					●		
			D-R801C, R802C						●	
Solid state auto switch	Direct	Grommet	D-S991, S992 D-S99V1, S99V2			●				
			D-T991, T992 D-T99V1, T99V2			●				
			D-S9P1, S9P2 D-S9PV1, S9PV2			●				
			D-S791, S792				●			
			D-T791, T792					●		
			D-S7P1, S7P2						●	
		Connector	D-T791C, T792C						●	
			D-F8N, F8P, F8B							●
		Grommet	D-M9N, M9P, M9B D-M9NV, M9PV, M9BV	●	●				●	●
			D-M9NW, M9PW, M9BW D-M9NVW, M9PVW, M9BWW	●	●				●	●
		Direct	Grommet	D-M9BAL	●	●			●	●

1 - White
2 - color
3 - indicator

Directional Control Valves
Air Cylinders
Rotary Actuators
Air Grippers
Air Preparation Equipment
Modular F. R.
Pressure Control Equipment
Fittings & Tubing
Flow Control Equipment
Pressure Switches/
Pressure Sensors

For Clean Room

Air Grippers

Contents	Series	Page
2 Finger Air Gripper	11-/22-MHZ2	P.923
2 Finger Parallel Type Wide Opening Air Gripper	11-/22-MHL2	P.927
2 Finger Rotary Actuated Air Gripper	11-/22-MHR2	P.932
3 Finger Rotary Actuated Air Gripper	11-/22-MHR3	P.938
Precautions		P.942
Applicable Auto Switch List		P.946

Directional
Control Valves

Air Cylinders

Rotary Actuators

Air Grippers

Air Preparation
Equipment

Modular F. R.

Pressure Control
Equipment

Fittings & Tubing

Flow Control
Equipment

Pressure Switches/
Pressure Sensors

Series 11-22-MHZ2

ø10, ø16, ø20, ø25
Air Gripper

How to Order

• **Clean series**
11 Vacuum suction type

11 — MHZ2 — 16 D [] — M9N []

22 — MHZ2 — 16 D [] — M9N []

• **Copper, fluorine and silicone-free + Low particle generation**
22 Vacuum suction type

• **Bore size**

10	10 mm
16	16 mm
20	20 mm
25	25 mm

• **Action**
D Double acting

• **Number of auto switches**

Nil	2 pcs.
S	1 pc.

• **Finger option**

Standard type	Nil: Basic	1: Side tapped mounting	2: Through-holes in open/close direction	3: Flat finger
	N: Basic	N1: Side tapped mounting	N2: Through-holes in open/close direction	
Narrow type				

• **Auto switch**

Nil Without auto switch (Built-in magnet)



Auto Switch Specifications (Refer to the WEB catalog for further information on auto switches.)

Type	Special function	Electrical entry	Indicator light	Wiring (Output)	Load voltage		Auto switch model		Lead wire length (m) ^(Note 1)			Applicable load	Applicable model					
					DC	AC	Perpendicular	In-line	0.5 Nil	3 (L)	5 ^(Note 2) (Z)		ø10	ø16	ø20	ø25		
Solid state auto switch	—	Grommet	Yes	3-wire (NPN)	24 V	5 V 12 V	—	M9NV	M9N	●	●	○	IC circuit	Relay PLC	●	●	●	●
								F8N	—	●	●	○			—	—	●	●
								M9PV	M9P	●	●	○			●	●	●	●
								F8P	—	●	●	○			—	—	●	●
								M9BV	M9B	●	●	○			●	●	●	●
								F8B	—	●	●	○			—	—	●	●

Note 1) Lead wire length symbols: 0.5 m.....Nil (Example) M9N
3 m.....L (Example) M9NL
5 m.....Z (Example) M9NZ

Note 2) Auto switches marked with "○" symbol are produced upon receipt of order.

Refer to page 946 for the applicable auto switch list.

Specifications

Fluid	Air
Operating pressure	ø10: 0.2 to 0.7 MPa ø16 to ø25: 0.1 to 0.7 MPa
Ambient and fluid temperature	-10 to 60°C
Repeatability	±0.01
Maximum operating frequency	180 c.p.m.
Lubrication	Not required
Action	Double acting
Grease	11-: Fluorine grease 22-: Lithium soap based grease
Cleanliness class (ISO class)	11-/22-: Class 4

Suction Flow Rate of Vacuum Suction Type (Reference values)

Size	Suction flow rate L/min (ANR)
10/16	1
20/25	2

Model

Model	Bore size mm	Gripping force ^{Note 1)} per finger		Open/Close stroke (Both sides) mm	Weight ^{Note 2)} g
		External	Internal		
11-MHZ2-10D	10	9.8	17	4	60
11-MHZ2-16D	16	30	40	6	125
11-MHZ2-20D	20	42	66	10	250
11-MHZ2-25D	25	65	104	14	455

Note 1) Values based on pressure of 0.5 MPa, gripping point L = 20 mm, at center of stroke.

Note 2) Values excluding weight of auto switch.

Protrusion of Auto Switch from Edge of Body

- The amount of auto switch protrusion from the body's end surface is as shown in the table below.
- Use this as a standard when mounting, etc.
- D-F8□ has no protrusion from the body's end surface.

Model	Lead wire type Explanatory drawing	In-line electrical entry	
		Auto switch Finger position	D-M9□
11-MHZ2-10□	Open	8	8
	Closed	10	10
11-MHZ2-16□	Open	4	4
	Closed	7	7
11-MHZ2-20□	Open	—	—
	Closed	5	5
11-MHZ2-25□	Open	—	—
	Closed	2	2

[Mounting of Auto Switch: Precautions]

When mounting an auto switch on the piping port surface of the 11-MHZ2-10□, the auto switch may not be mountable due to interference with the fitting. Use an extension fitting included with the product for the combinations in the table below.

Auto switch model	One-touch Fittings (KQ2H/KQ2S/KQ2L/KQ2W/KJH/KJS/KJL/KJW)
D-M9□(V)	×
D-M9□W(V)	×
D-F8□	×
D-M9□A(V)	×

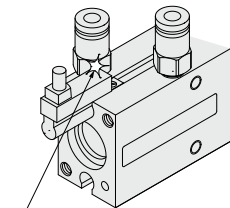

Interference between the auto switch and the fitting

Mounting dimensions of extension fitting

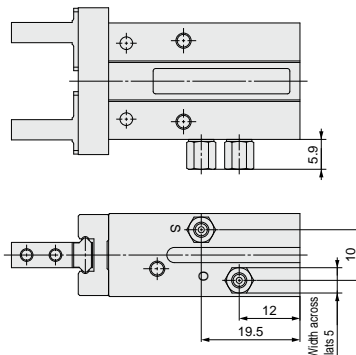

• When mounting extension fittings, first, tighten it by hand, then give it an additional 1/4 turn with a wrench.

Dimensions

11-22-MHZ2-10, 16, 20, 25

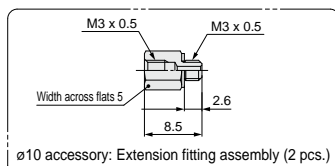
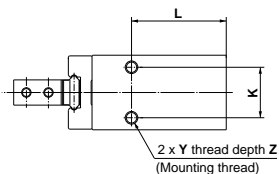

Note) If the fitting attached to the port interferes with the auto switch, please use the extension fitting assembly supplied with the air gripper.

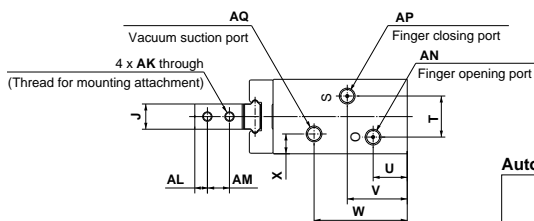
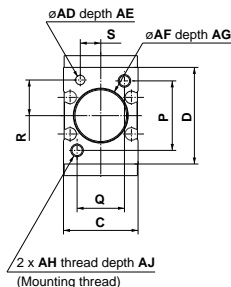
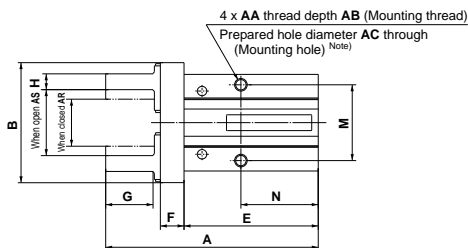

Finger option: Narrow type (N)

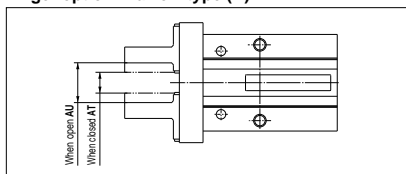

Auto switch mounting groove dimensions

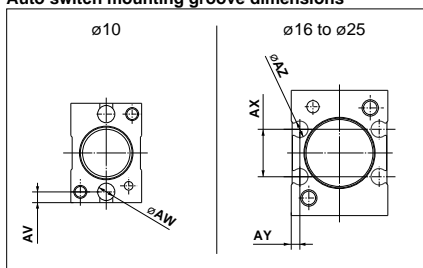

Model	A	B	C	D	E	F	G	H	J	K	L	M	N	P	Q	R	S	T
11-22-MHZ2-10D□	57	29	16.4 ^{+0.05}	23	37.8	6	12	4 ⁰ _{-0.1}	5 ⁰ _{-0.05}	11.4	27	16	23	18	12	7.6 ^{+0.02}	5.2 ^{+0.02}	10
11-22-MHZ2-16D□	67.3	38	23.6 ^{+0.05}	30.6	42.5	7.5	15	5 ⁰ _{-0.1}	8 ⁰ _{-0.05}	16	30	24	24.5	22	15	11 ^{+0.02}	6.5 ^{+0.02}	13
11-22-MHZ2-20D□	84.8	50	27.6 ^{+0.05}	42	52.8	9.5	20	8 ⁰ _{-0.1}	10 ⁰ _{-0.05}	18.6	35	30	29	32	18	16.8 ^{+0.02}	7.5 ^{+0.02}	15
11-22-MHZ2-25D□	102.7	63	33.6 ^{+0.05}	52	63.6	11	25	10 ⁰ _{-0.1}	12 ⁰ _{-0.05}	22	36.5	36	30	40	22	21.8 ^{+0.02}	10 ^{+0.02}	20

(mm)

Model	U	V	W	X	Y	Z	AA	AB	AC	AD	AE	AF	AG	AH	AJ	AK
11-22-MHZ2-10D□	12	19.5	28.2	5.5	M3 x 0.5	6	M3 x 0.5	5.5	2.6	2H9 ^{+0.025} ₀	3	12.4H9 ^{+0.043} ₀	1.5	M3 x 0.5	6	M2.5 x 0.45
11-22-MHZ2-16D□	10.8	19	29.5	6.5	M4 x 0.7	4.5	M4 x 0.7	8	3.4	3H9 ^{+0.025} ₀	3	17.4H9 ^{+0.043} ₀	1.5	M4 x 0.7	8	M3 x 0.5
11-22-MHZ2-20D□	12	23	39.8	8.3	M5 x 0.8	8	M5 x 0.8	10	4.3	4H9 ^{+0.030} ₀	4	22.4H9 ^{+0.052} ₀	2	M5 x 0.8	10	M4 x 0.7
11-22-MHZ2-25D□	13	37	49.7	10.8	M6 x 1	10	M6 x 1	12	5.1	4H9 ^{+0.030} ₀	4	27.4H9 ^{+0.052} ₀	3	M6 x 1	12	M5 x 0.8

Model	AL	AM	AN	AP	AQ	AR	AS	AT	AU	AV	AW	AX	AY	AZ
11-22-MHZ2-10D□	3	5.7	M3 x 0.5	M3 x 0.5	M3 x 0.5	11.2 ^{+0.5} _{-0.2}	15.2 ^{+2.2} ₀	5.7 ^{+0.5} _{+0.1}	9.7 ^{+2.2} ₀	2.5	4	—	—	—
11-22-MHZ2-16D□	4	7	M5 x 0.8	M5 x 0.8	M5 x 0.8	14.9 ^{+0.5} _{-0.2}	20.9 ^{+2.2} _{-0.2}	6.6 ^{+0.5} _{+0.1}	12.6 ^{+2.2} ₀	—	—	11.6	2.1	4
11-22-MHZ2-20D□	5	9	M5 x 0.8	M5 x 0.8	M5 x 0.8	16.3 ^{+0.5} _{-0.2}	26.3 ^{+2.2} _{-0.2}	7.2 ^{+0.5} _{+0.1}	17.2 ^{+2.2} ₀	—	—	14	2.1	4
11-22-MHZ2-25D□	6	12	M5 x 0.8	M5 x 0.8	M5 x 0.8	19.3 ^{+0.5} _{-0.3}	33.3 ^{+2.5} _{-0.2}	8.8 ^{+0.5} _{+0.1}	22.8 ^{+2.5} ₀	—	—	19	3.5	4

Note) Through-hole mounting is not possible for ø10.

Standard Type / Series ¹¹⁻²²MHZ2 Finger Option

Side tapped mounting [1/N1]

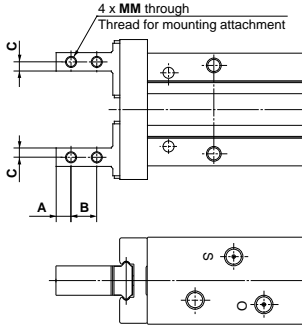

Model	A	B	C	MM
¹¹⁻²² MHZ2-10D ¹ _{N1}	3	5.7	2	M2.5 x 0.45
¹¹⁻²² MHZ2-16D ¹ _{N1}	4	7	2.5	M3 x 0.5
¹¹⁻²² MHZ2-20D ¹ _{N1}	5	9	4	M4 x 0.7
¹¹⁻²² MHZ2-25D ¹ _{N1}	6	12	5	M5 x 0.8

* Specifications and dimensions other than the above are the same as the basic type (including narrow type).

Through-holes in open/close direction [2/N2]

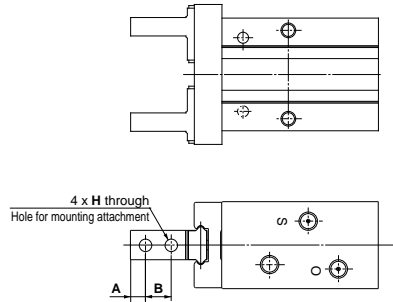

Model	A	B	H
¹¹⁻²² MHZ2-10D ² _{N2}	3	5.7	2.9
¹¹⁻²² MHZ2-16D ² _{N2}	4	7	3.4
¹¹⁻²² MHZ2-20D ² _{N2}	5	9	4.5
¹¹⁻²² MHZ2-25D ² _{N2}	6	12	5.5

* Specifications and dimensions other than the above are the same as the basic type (including narrow type).

Flat finger [3]

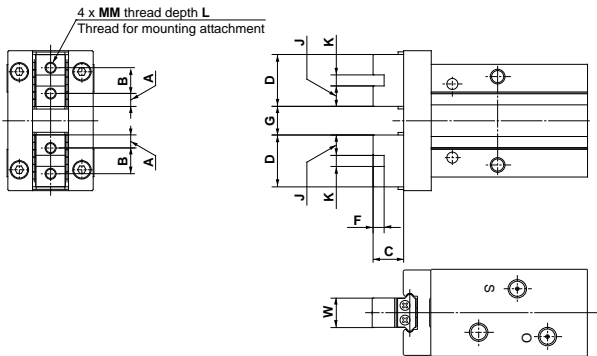

Model	A	B	C	D	F	G		J	K	MM	L	W	Weight (g)
						Open	Closed						
¹¹⁻²² MHZ2-10D3 * 1), * 2)	2.45	6	5.2	10.9	2	5.4 ^{+2.2} ₀	1.4 ^{+0.5} _{-0.3}	4.45	2H9 ^{+0.025} ₀	M2.5 x 0.45	5	5 ⁰ _{0.05}	60
¹¹⁻²² MHZ2-16D3 * 1), * 2)	3.05	8	8.3	14.1	2.5	7.4 ^{+2.2} ₀	1.4 ^{+0.5} _{-0.3}	5.8	2.5H9 ^{+0.025} ₀	M3 x 0.5	6	8 ⁰ _{0.05}	125
¹¹⁻²² MHZ2-20D3 * 1), * 2)	3.95	10	10.5	17.9	3	11.0 ^{+2.3} ₀	1.6 ^{+0.5} _{-0.3}	7.45	3H9 ^{+0.025} ₀	M4 x 0.7	8	10 ⁰ _{0.05}	250
¹¹⁻²² MHZ2-25D3 * 1), * 2)	4.9	12	13.1	21.8	4	16 ^{+2.5} ₀	2 ^{+0.5} _{-0.3}	8.9	4H9 ^{+0.030} ₀	M5 x 0.8	10	12 ⁰ _{0.05}	450

* 1) Specifications and dimensions other than the above are the same as the basic type (Narrow type is not available for D3).

* 2) The overall length is the same as the MHQ(G) flat finger type.

Series 11-22-MHL2

ø10, ø16, ø20, ø25, ø32, ø40
Parallel Type Wide Opening Air Gripper

How to Order



• Clean series
11 Vacuum suction type

11—MHL 2—16 □ D 1—M9N □

22—MHL 2—16 □ D 1—M9N □

• Wide opening

• Number of fingers
2 2 fingers

• Bore size

10	10 mm
16	16 mm
20	20 mm
25	25 mm
32	32 mm
40	40 mm

• Copper, fluorine and silicone-free + Low particle generation

22 Vacuum suction type

• Port thread type

Nil	M	ø10, ø16, ø20, ø25
	Rc	ø32, ø40
TN	NPT	ø32, ø40
TG	G	ø32, ø40

• Number of auto switches

Nil	2 pcs.
S	1 pc.
n	n pcs.

• Auto switch

Nil Without auto switch (Built-in magnet)

• Open/Close stroke (mm)

Symbol	Bore size					
	ø10	ø16	ø20	ø25	ø32	ø40
Nil	20	30	40	50	70	100
1	40	60	80	100	120	160
2	60	80	100	120	160	200

• Action

D Double acting

Model/Stroke

Model	Bore size (mm)	Maximum operating frequency (c.p.m)	Open/Close stroke (mm) (L2-L1)	Width at closing (mm) (L1)	Width at opening (mm) (L2)	Weight (g)
11-22 MHL2-10D	10	60	20	72	92	340
11-22 MHL2-10D1		40	40	94	134	405
11-22 MHL2-10D2		60	60	112	172	485
11-22 MHL2-16D	16	60	30	84	114	660
11-22 MHL2-16D1		40	60	126	186	870
11-22 MHL2-16D2		80	146	226	1010	
11-22 MHL2-20D	20	60	40	98	138	1175
11-22 MHL2-20D1		40	80	158	238	1645
11-22 MHL2-20D2		100	178	278	1840	
11-22 MHL2-25D	25	60	50	116	166	1850
11-22 MHL2-25D1		40	100	198	298	2720
11-22 MHL2-25D2		120	216	336	2935	
11-22 MHL2-32D	32	30	70	150	220	3070
11-22 MHL2-32D1		20	120	198	318	3985
11-22 MHL2-32D2		160	242	402	4820	
11-22 MHL2-40D	40	30	100	188	288	5620
11-22 MHL2-40D1		20	160	246	406	7180
11-22 MHL2-40D2		200	286	486	8255	

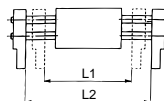

Note) The width at closing/opening represent the valve when the exterior of the workpiece is being held.

Specifications

Bore size (mm)	10	16	20	25	32	40
Fluid	Air					
Action	Double acting					
Operating pressure (MPa)	0.15 to 0.6		0.1 to 0.6			
Ambient and fluid temperature	-10 to 60°C					
Repeatability	±0.1					
Lubrication	Not required					
Effective gripping force (N) at 0.5 MPa <small>(Note)</small>	14	45	74	131	228	396
Grease	11-: Fluorine grease 22-: Lithium soap based grease					
Cleanliness class (ISO class)	11-/22-: Class 4					

Note) Gripping point = Bore size 10, 16, 20, 25: 40 mm, Bore size 32, 40: 80 mm

* Refer to the **WEB catalog** for details of gripping force at each gripping point.

Suction Flow Rate of Vacuum Suction Type (Reference values)

Size	Suction flow rate L/min (ANR)
10/16/20/25/32/40	One side 10

Auto Switch Specifications (Refer to the **WEB catalog** for further information on auto switches.)

Type	Auto switch model	Load voltage	Load current range	Indicator light	Applicable load
Solid state	2-wire D-M9B(V)	24 VDC (10 to 28 VDC)	5 to 40 mA	Yes	24 VDC relay, PLC
auto switch	3-wire D-M9N(V)	28 VDC or less	40 mA or less	Yes	24 VDC relay, PLC

* When ordering the air gripper with the D-M9□ type auto switch, the auto switch mounting bracket is supplied with the product.

* When ordering the D-M9□ type auto switch separately, the auto switch mounting bracket (BMG2-012) is required.

Refer to page 946 for the applicable auto switch list.

PLC: Programmable Logic Controller

Auto Switch Mounting

- To set the auto switch, insert the auto switch mounting bracket into the installation groove of the cylinder as shown below and set it roughly.
- Insert the auto switch into the auto switch mounting bracket installation groove.
- After confirming the detecting position, tighten the set screws (M2.5) attached to the auto switch and set it.
- Be sure to change the detecting position in the state of step 2.

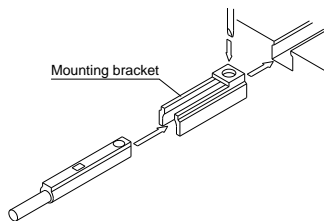

Note) Use a watchmaker's screwdriver with a grip diameter of 5 to 6 mm to tighten the set screws (M2.5).

The tightening torque should be 0.05 to 0.1 N·m.

As a rule, it should be turned about 90° beyond the point at which tightening can be felt.

Auto Switch Mounting Bracket Part No.

Auto switch part no.	Auto switch mounting bracket part no.
D-M9□(V)	BMG2-012
D-M9□W(V)	
D-M9□A(V)	

Auto Switch Mounting Brackets: Precautions

When auto switch is set on the mounting side as shown below, allow at least 2 mm runoff space on mounting plate since the auto switch is protruded from the gripper edge.

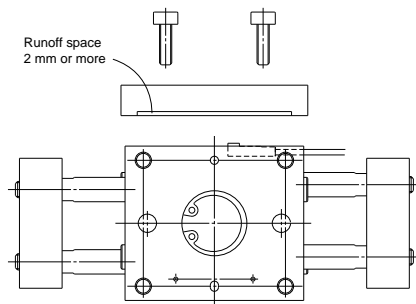

Dimensions

11/22:MHL2-32D □

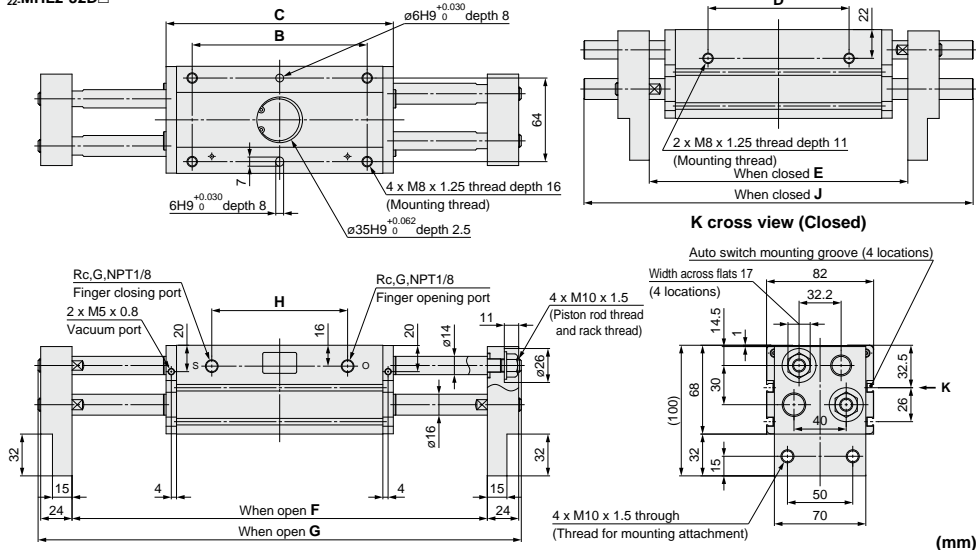

	B	C	D	E	F	G	H	J
11/22:MHL2-32D	86	126	60	150	220	272	56	202
11/22:MHL2-32D1	134	174	108	198	318	370	104	298
11/22:MHL2-32D2	178	218	152	242	402	454	148	382

11/22:MHL2-40D □

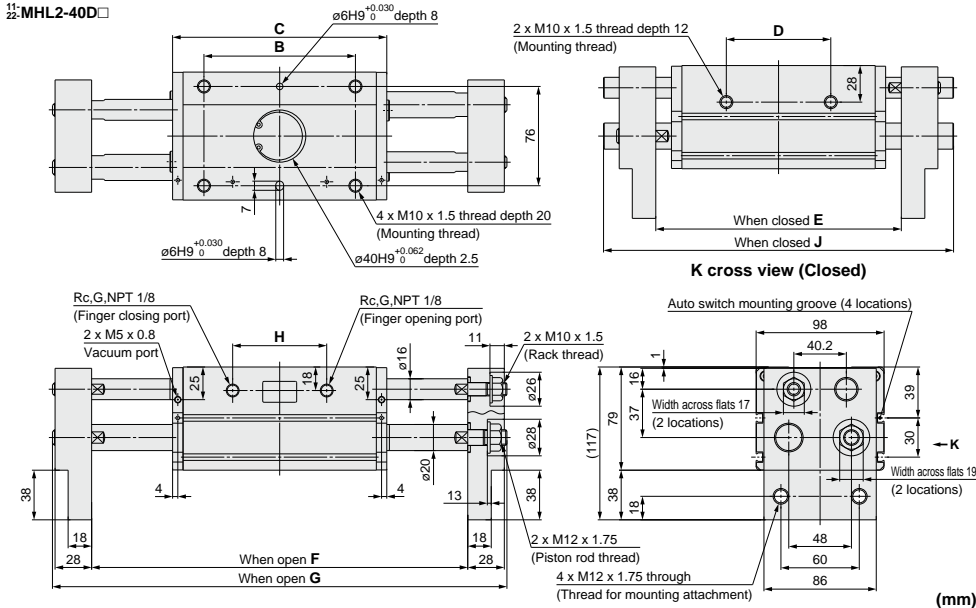

	B	C	D	E	F	G	H	J
11/22:MHL2-40D	116	164	80	188	288	348	72	268
11/22:MHL2-40D1	174	222	138	246	406	466	130	386
11/22:MHL2-40D2	214	262	178	286	486	546	170	466

Series 11-22-MHR2

2 Finger Rotary Actuated Air Gripper
Size: 10, 15, 20, 30

How to Order



Clean series
11 | Vacuum suction type

Copper, fluorine and silicone-free + Low particle generation
22 | Vacuum suction type

Number of fingers
2 | 2 fingers

Nominal size
10
15
20
30

Auto switch
Nil | Without auto switch (without magnet)

Number of auto switches
Nil | 2 pcs.
S | 1 pc.

Built-in magnet

Nil	No
D	With magnet (For auto switch)

Connecting port

R: Body side	E: Axial side
--------------	---------------

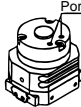
11 — M D HR 2 — 10 R — M9B S

22 — M D HR 2 — 10 R — M9B S

Model

Vacuum suction type	Model	Nominal size	Port size	Lubrication	Action	Gripping force N (Effective value at 0.5 MPa) ^{Note 1)}		Open/Close stroke (Both sides)			Weight g ^{Note 2)}
						External	Internal	Finger opening width (mm)	Finger closing width (mm)	Stroke (mm)	
11- 22-	11- 22- MHR2-10	10	M3 x 0.5	Non-lube	Double acting	12	12	10	16	6	105 (100)
	11- 22- MDHR2-10										
	11- 22- MHR2-15	15	M3 x 0.5			24	25	14	22	8	185 (180)
	11- 22- MDHR2-15										
	11- 22- MHR2-20	20	M5 x 0.8			33	34	16	28	12	400 (390)
	11- 22- MDHR2-20										
11- 22- MHR2-30	30	M5 x 0.8	58	59	19	37	18	780 (760)			
11- 22- MDHR2-30											

Note 1) Refer to the Best Pneumatics No. 4 for details of gripping force at each gripping point.

Value of effective gripping force is measured at the middle of open/close stroke.

Note 2) Values in () show MDHR weight, but it does not include auto switch weight.

Specifications

Item	Nominal size	
	10	15, 20, 30
Operating pressure	0.2 to 0.6 MPa	0.15 to 0.6 MPa
Ambient and fluid temperature	0 to 60°C	
Repeatability	±0.01 mm	
Maximum operating frequency	180 c.p.m.	
Grease	11-: Fluorine grease 22-: Lithium soap based grease	
Cleanliness class (ISO class)	11-/22-: Class 3	

Suction Flow Rate of Vacuum Suction Type (Reference values)

Size	Suction flow rate L/min (ANR)
10/15	1
20/30	2

Auto Switch Specifications (Refer to the **WEB catalog** for further information on auto switches.)

Type		Auto switch model	Load voltage	Load current range	Indicator light	Applicable load
Solid state auto switch	2-wire	D-M9B(V)	24 VDC (10 to 28 VDC)	5 to 40 mA	Yes	24 VDC relay, PLC
	3-wire	D-M9N(V)	28 VDC or less	40 mA or less	Yes	

Refer to page 946 for the applicable auto switches list.

PLC: Programmable Logic Controller

Auto Switch Hysteresis

¹¹⁻₂₂₋**MDHR2**

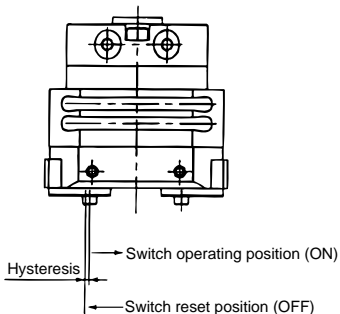

Please refer to the table as a guide when setting auto switch positions.

Model	Hysteresis (Max. value) (mm)
¹¹⁻ ₂₂₋ MDHR2-10	0.4
¹¹⁻ ₂₂₋ MDHR2-15	
¹¹⁻ ₂₂₋ MDHR2-20	0.5
¹¹⁻ ₂₂₋ MDHR2-30	

Protrusion of Auto Switch from Edge of Body

- The maximum protrusion of an auto switch (when fingers are fully open) from the edge of the body is shown in the table below. Use the table as a guideline for mounting.

¹¹⁻₂₂₋**MDHR2-10,15**

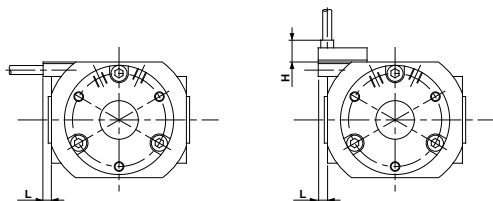

When auto switch **D-M9N, D-M9P, D-M9B** is used

When auto switch **D-M9NV, D-M9PV, D-M9BV** is used

Max. protrusion of auto switch from edge of body: L, H (mm)

Auto switch model		D-M9□	
		D-M9□	D-M9□V
Air gripper model	MDHR2-10	L	0.6
		H	6.8
	MDHR2-15	L	-
		H	6.8

¹¹⁻₂₂₋**MDHR2-20,30**

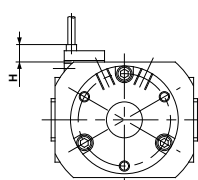

When auto switch **D-M9NV, D-M9PV, D-M9BV** is used

Max. protrusion of auto switch from edge of body: H (mm)

Air gripper model	Auto switch model	
	D-M9□	D-M9□V
MDHR2-20	D-M9□	6.8
	D-M9□V	6.8
MDHR2-30	D-M9□	6.8

* The auto switch will not protrude in the case of D-M9□.

Without Auto Switch: 11-22-MHR2-10R

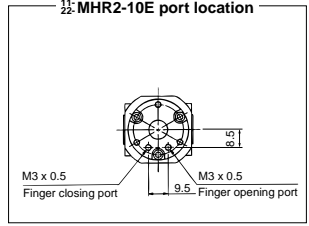
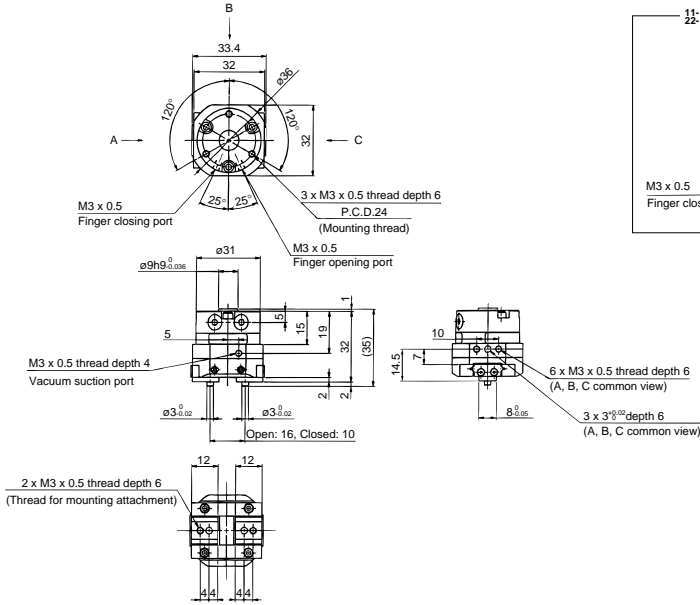

With Auto Switch: 11-22-MDHR2-10R

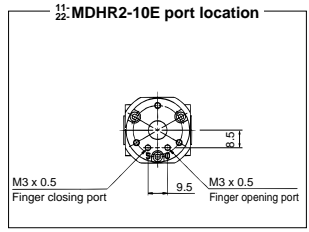
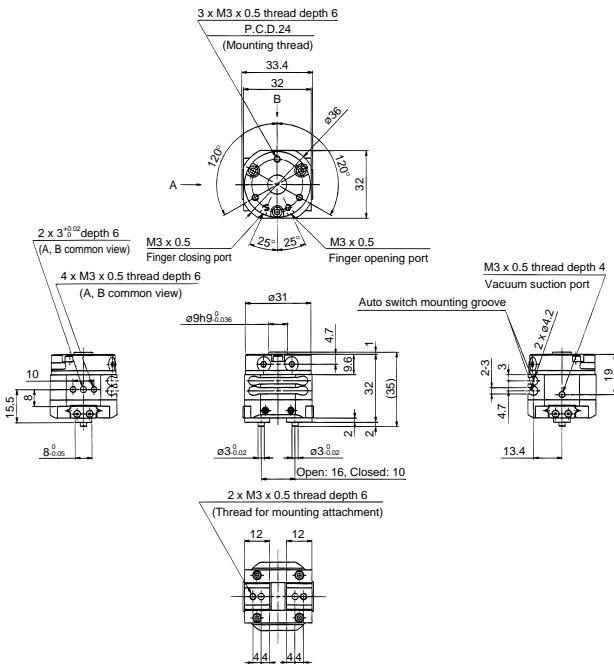

Directional Control Valves

Air Cylinders

Rotary Actuators

Air Grippers

Air Preparation Equipment

Modular F. R.

Pressure Control Equipment

Fittings & Tubing

Flow Control Equipment

Pressure Switches/ Pressure Sensors

Without Auto Switch: 11-22-MHR2-20R

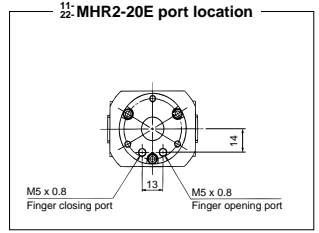
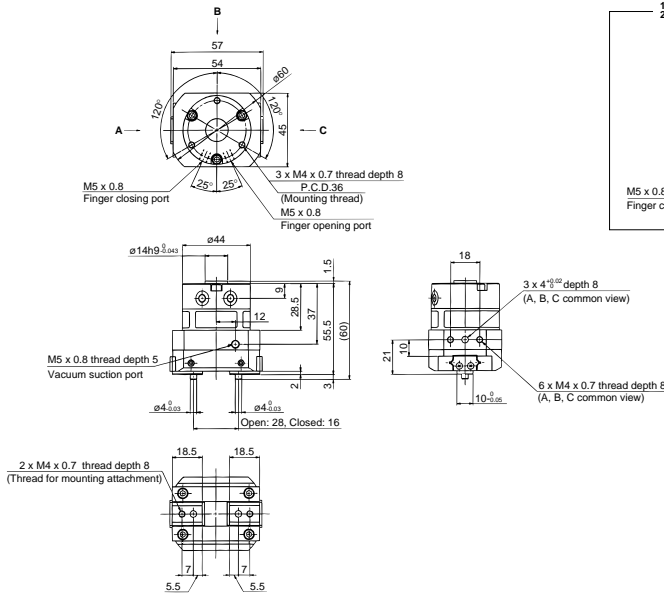

With Auto Switch: 11-22-MDHR2-20R

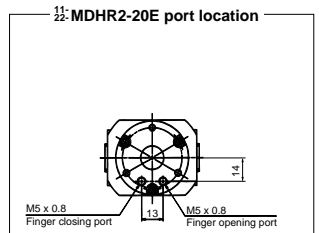
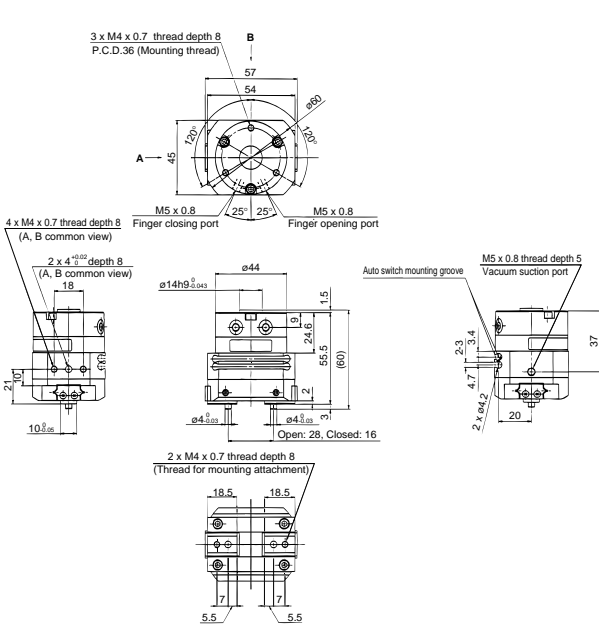

- Directional Control Valves
- Air Cylinders
- Rotary Actuators
- Air Grippers**
- Air Preparation Equipment
- Modular F. R.
- Pressure Control Equipment
- Fittings & Tubing
- Flow Control Equipment
- Pressure Switches/ Pressure Sensors

Series 11-22-MHR3

3 Finger Rotary Actuated Air Gripper
Size: 10, 15

How to Order



Clean series
11 | Vacuum suction type

11 — M D H R 3 — 10 R — M9B S

22 — M D H R 3 — 10 R — M9B S

Copper, fluorine and silicone-free + Low particle generation
22 | Vacuum suction type

Number of fingers
3 | 3 fingers

Nominal size
10
15



Auto switch
Nil | Without auto switch (Built-in magnet)
S | 1 pc.

Built-in magnet

Nil	No
D	With magnet (For auto switch)

Connecting port

R: Body side	E: Axial side
Port	Port

* Only R type is available for "Without auto switch".

Model

Vacuum suction type	Model	Nominal size	Port size	Lubrication	Action	Gripping force N (Effective value at 0.5 MPa) (Note 1)		Open/Close stroke (Diameter)			Weight (g)
						External	Internal	Finger closing width (mm)	Finger opening width (mm)	Stroke (mm)	
11- 22-	MHR3-10 MDHR3-10	10	M3 x 0.5	Non-lube	Double acting	7	6.5	16	22	6	125 (130)
11- 22-	MHR3-15 MDHR3-15	15				13	12	19	27	8	230 (235)

Note 1) Refer to the **WEB catalog** for details of gripping force at each gripping point.
Value of effective gripping force is measured at the middle of open/close stroke.
Note 2) Values in () show MDHR weight, but it does not include auto switch weight.

Specifications

Item	Nominal size	
	10	15
Operating pressure	0.2 to 0.6 MPa	0.15 to 0.6 MPa
Ambient and fluid temperature	0 to 60°C	
Repeatability	±0.01 mm	
Maximum operating frequency	180 c.p.m.	
Grease	11-: Fluorine grease 22-: Lithium soap based grease	
Cleanliness class (ISO class)	11-/22-: Class 3	

Suction Flow Rate of Vacuum Suction Type (Reference values)

Size	Suction flow rate L/min (ANR)
10/15	1

Directional Control Valves

Air Cylinders

Rotary Actuators

Air Grippers

Air Preparation Equipment

Modular F. R.

Pressure Control Equipment

Fittings & Tubing

Flow Control Equipment

Pressure Switches/Pressure Sensors

Auto Switch Specifications (Refer to the **WEB catalog** for further information on auto switches.)

Type	Auto switch model	Load voltage	Load current range	Indicator light	Applicable load
Solid state auto switch	2-wire D-M9B(V)	24 VDC (10 to 28 VDC)	5 to 30 mA	Yes	24 VDC relay, PLC
	3-wire D-M9N(V)	28 VDC or less	50 mA or less	Yes	

Refer to page 946 for the applicable auto switch list.

PLC: Programmable Logic Controller

Auto Switch Hysteresis

11-22-**MDHR3**

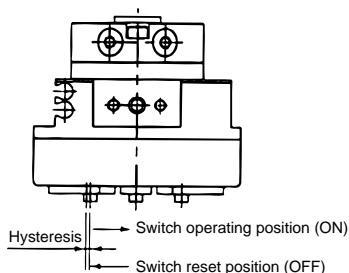

Please refer to the table as a guide when setting auto switch positions.

Model	Hysteresis (Max. value) (mm)
11-22- MDHR3-10	0.3
11-22- MDHR3-15	0.5

Protrusion of Auto Switch from Edge of Body

The maximum protrusion of auto switch (when fingers are fully open) from the edge of the body is shown in the table below. Use the table as a guideline for mounting.

11-22-**MDHR3-10**

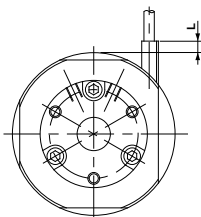

When auto switch D-M9□ is used

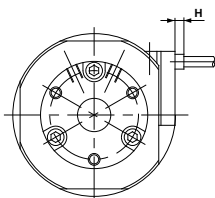

When auto switch D-M9□V is used

Max. protrusion of auto switch from edge of body: L, H (mm)

Auto switch model	D-M9□	D-M9□V
L	—	—
H	—	2.3

11-22-**MDHR3-15**

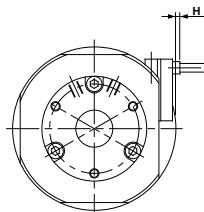

When auto switch D-M9□V is used

Max. protrusion of auto switch from edge of body: H (mm)

Auto switch model	D-M9□V
H	1.3

The auto switch will not protrude in the case of D-M9□.

Without Auto Switch: 11-22-MHR3-10R

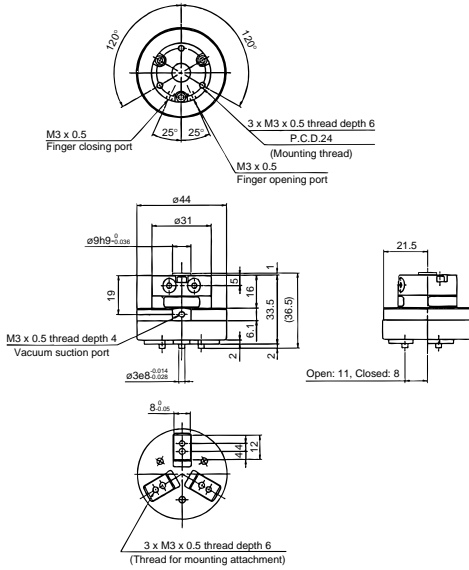

With Auto Switch: 11-22-MDHR3-10R

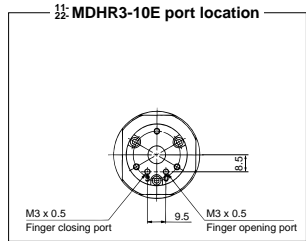
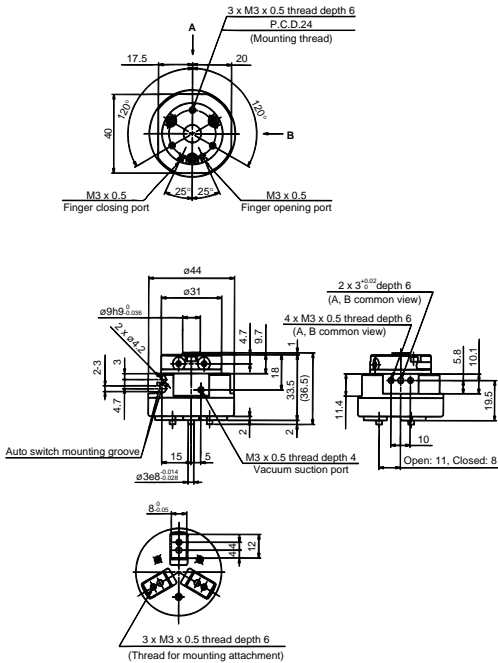

Directional Control Valves

Air Cylinders

Rotary Actuators

Air Grippers

Air Preparation Equipment

Modular F. R.

Pressure Control Equipment

Fittings & Tubing

Flow Control Equipment

Pressure Switches/ Pressure Sensors

Without Auto Switch: 11-22-MHR3-15R

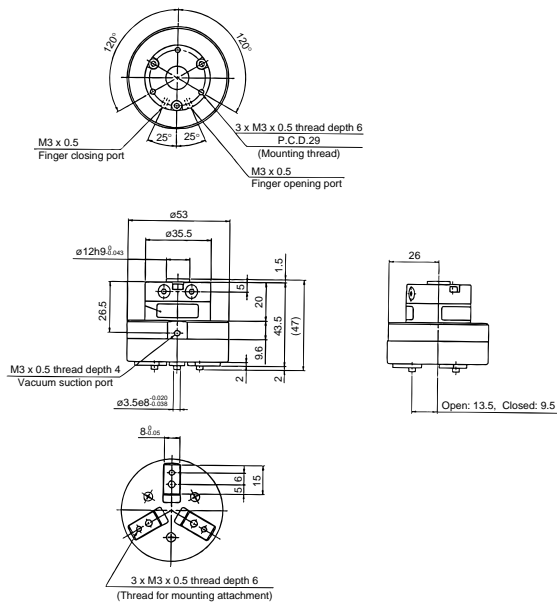

With Auto Switch: 11-22-MDHR3-15R

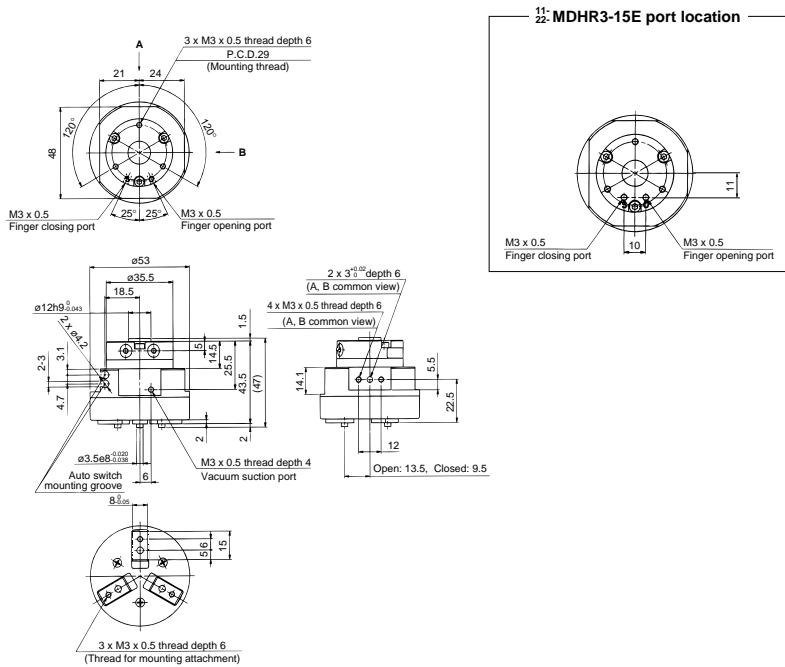



Air Grippers Precautions 1

Be sure to read this before handling.

Design/Selection

⚠ Warning

1. Confirm the specifications.

Products represented in this catalog are designed only for use in compressed air systems (including vacuum). Do not operate at pressures or temperatures, etc., beyond the range of specifications, as this can cause damage or malfunction. (Refer to the specifications.)

Please contact SMC when using a fluid other than compressed air (including vacuum). We do not guarantee against any damages if the product is used outside of the specification range.

2. Take safety measures (e.g. mounting protective covers) when workpieces pose a danger of fingers being caught in a gripper, etc.

3. If circuit pressure drops due to a power failure or trouble with the air supply, etc., there is a danger of workpieces dropping because of reduced gripping force. Implement drop prevention measures to avoid human injury and equipment damage.

4. Keep the gripping point within the specified range of the gripping distance.

When the gripping point distance becomes large, the gripper attachment applies an excessively large load to the gripper sliding section, and causes adverse effects on the service life. Refer to the graph of the specified range of the gripping distance for each series.

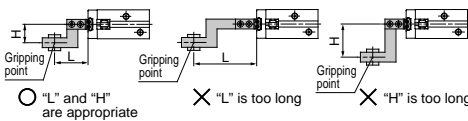

5. Attachment should be designed as light and short as possible.

- 1) A long or heavy attachment increases the inertia force to open or close the fingers. Therefore, it may cause unsteady movement of fingers and have an adverse effect on life.
- 2) Even if the gripping point remains within the range limit, make the attachment as light and short as possible.

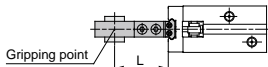

- 3) Select a larger size gripper or use two or more grippers for handling a long and/or large workpiece at one time.

6. Provide a runoff space in the attachment when using with a small or thin workpiece.

If a runoff space is not provided within the finger part, gripping becomes unsteady, and it may lead to gripping failure or slippage.

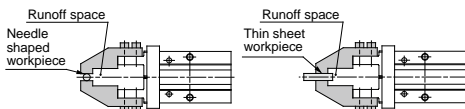

7. Select a model whose gripping force is compatible with the workpiece mass.

Incorrect selection may lead to the dropping of a workpiece, etc. Refer to the model selection criteria of each series of the effective gripping force and the workpiece mass.

8. Do not use in applications where excessive external force or impact force may be applied to the gripper.

Excessive external force or impact force may cause a malfunction. Please consult with SMC regarding any other applications.

9. Select a model having a sufficient working finger open/close width.

<In case of insufficient width>

- 1) Gripping becomes unsteady due to variations in open/close width or workpiece diameter.
- 2) When using an auto switch, the detection may not be reliable. Refer to the Auto Switch Hysteresis section and set the stroke including the hysteresis length for a reliable switch function.

When using the water resistant 2-color indicator auto switch, the gripper stroke may be limited by the setting of the indicator color during detection.

10. Please consult with SMC regarding a single acting, spring force only grip type.

This can cause unstable gripping in some cases or return malfunction, due to faulty operation, etc.

11. Do not disassemble the product or make any modifications, including additional machining. It may cause human injury and/or an accident.

12. Refer to the Auto Switches Precautions (pages 879 to 883) if using with an auto switch.

Mounting

⚠ Warning

1. Operation manual

Install the product and operate it only after reading the operation manual carefully and understanding its contents. Also, keep the manual in a location where it can be referred to as necessary.

2. Ensure sufficient space for maintenance activities.

When installing the products, allow access for maintenance.

3. Tighten threads with the proper tightening torque.

When installing the products, follow the listed torque specifications.

4. Do not scratch or dent the air gripper by dropping or bumping it when mounting.

Slight deformation can cause inaccuracy or malfunction.

5. Tighten the screw within the specified torque range when mounting the attachment.

Tightening with higher torque than the specified range may cause malfunction, while the tightening with lower torque may allow movement of gripping position and dropping of workpiece.



Air Grippers Precautions 2

Be sure to read this before handling.

Mounting

⚠ Caution

1. Avoid twisting the gripper when mounting an attachment.

Any damage to the gripper may cause malfunction and reduce the accuracy.

2. Avoid external force to fingers.

Fingers may be damaged by a continual lateral or impact load. Provide clearance to prevent the workpiece or the attachment from striking against any object at the stroke end.

1) Stroke end when fingers are opened

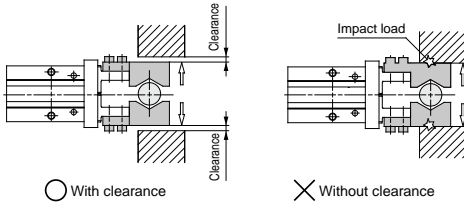

2) Stroke end when gripper is moving

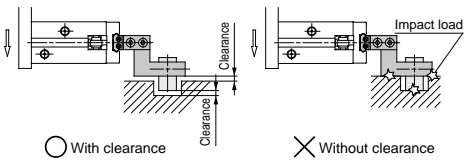

3) When turning over

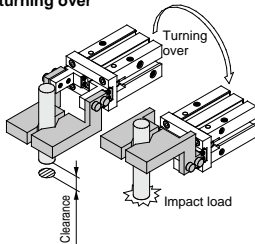

3. Adjust the gripping point so that an excessive force will not be applied to the fingers when inserting a workpiece.

Confirm that the gripper can operate without receiving any shock by testing it in manual operation mode or by low speed operation.

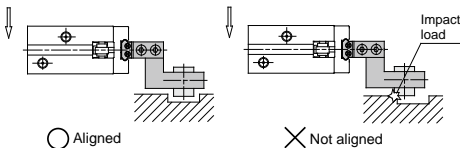

4. Control the open/close speed with the speed controller to avoid excessive high-speed operation.

If the finger open/close speed is greater than necessary, impact forces on the fingers and other parts will increase. This can cause a loss of repeatability when gripping a workpiece and have an adverse effect on the life of the unit.

Finger Open/Close Speed Adjustment

Example of Using SMC's Speed Controller

Double acting	<ul style="list-style-type: none"> The speed can be adjusted with the built-in speed controller in the following series: MHC2-10D to 25D, MHK2-12D to 25D and MHKL2-12D to 25D. Use the table below as a guide for adjusting the speed. Series other than those previously mentioned For a cylinder with an inner diameter of $\phi 6$ and $\phi 10$, connect 2 speed controllers in a meter-in state or 1 dual speed controller. If the cylinder has a bore size of $\phi 16$ or larger, connect 2 speed controllers in a meter-out state.
Single acting	<p>Connect one speed controller, then adjust the speed with the meter-in control.</p> <p>External gripping ——— Connect to closing port. Internal gripping ——— Connect to opening port.</p>

Applicable speed controllers

Air gripper mounted type ——— AS1200-M3/M5
AS2200-01, etc.

Piping type ——— AS1000 series
AS1001F, AS2051F, etc.

Guide to Built-in Needle Adjustment

Model	Number of needle rotations from fully closed state (*)
MHC2-10	1/4 to 1/2
MHC2-16	1/2 to 1
MHC2-20	1 to 1 1/2
MHC2-25	1 1/2 to 2
MHK2-12D	3/4 to 1
MHK2-16D	1 to 1 1/4
MHK2-20D	1 1/2 to 1 3/4
MHK2-25D	1 3/4 to 2
MHKL2-12D	1 to 1 1/4
MHKL2-16D	1 1/4 to 1 1/2
MHKL2-20D	1 3/4 to 2
MHKL2-25D	2 to 2 1/4

(*) Needle is tightened until it strikes the end lightly.

When an angular gripper is used, depending on the length of the attachment, it might be necessary to adjust the open/close movement to a slower speed. This will prevent the base of the fingers from being exposed to shocks that are created by inertial force.



Air Grippers Precautions 3

Be sure to read this before handling.

Piping

⚠ Caution

1. Refer to the Fittings and Tubing Precautions (pages 1237 to 1240) for handling One-touch fittings.
2. Preparation before piping
Before piping is connected, it should be thoroughly flushed out with air or washed to remove chips, cutting oil and other debris from inside the pipe.
3. Winding of sealant tape

When screwing piping or fittings into ports, ensure that chips from the pipe threads or sealing material do not enter the piping. Also, if sealant tape is used, leave 1.5 to 2 thread ridges exposed at the end of the threads.

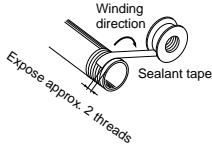

Lubrication

⚠ Caution

1. The non-lube type air gripper is lubricated at the factory, and can be used without any further lubrication.
In the event that lubrication will be applied, use class 1 turbine oil (without additives) ISO VG32. Furthermore, once lubrication is applied, it must be continued.
If lubrication is later stopped, malfunction can occur due to loss of the original lubricant.
Refer to the Material Safety Data Sheet (MSDS) of the hydraulic fluid when supplying the fluid.

Air Supply

⚠ Warning

1. Type of fluids
Please consult with SMC when using the product in applications other than compressed air.
2. When there is a large amount of drainage.
Compressed air containing a large amount of drainage can cause malfunction of pneumatic equipment. An air dryer or water separator should be installed upstream from filters.
3. Drain flushing
If condensation in the drain bowl is not emptied on a regular basis, the bowl will overflow and allow the condensation to enter the compressed air lines. It causes malfunction of pneumatic equipment.
If the drain bowl is difficult to check and remove, installation of a drain bowl with an auto drain option is recommended.
For compressed air quality, refer to SMC Best Pneumatics No.5 catalog.
4. Use clean air.
Do not use compressed air that contains chemicals, synthetic oils including organic solvents, salt or corrosive gases, etc., as it can cause damage or malfunction.

⚠ Caution

1. When extremely dry air is used as the fluid, degradation of the lubrication properties inside the equipment may occur, resulting in reduced reliability (or reduced service life) of the equipment. Please consult with SMC.
2. Install an air filter.
Install an air filter upstream near the valve. Select an air filter with a filtration size of 5 μm or smaller.
3. Take measures to ensure air quality, such as by installing an aftercooler, air dryer, or water separator.
Compressed air that contains a large amount of drainage can cause malfunction of pneumatic equipment such as air grippers. Therefore, take appropriate measures to ensure air quality, such as by providing an aftercooler, air dryer, or water separator.
4. Ensure that the fluid and ambient temperature are within the specified range.
If the fluid temperature is 5°C or less, the moisture in the circuit could freeze, causing damage to the seals and equipment malfunction. Therefore, take appropriate measures to prevent freezing.
For compressed air quality, refer to SMC Best Pneumatics No.5 catalog.

Directional Control Valves

Air Cylinders

Rotary Actuators

Air Grippers

Air Preparation Equipment

Modular F. R.

Pressure Control Equipment

Fittings & Tubing

Flow Control Equipment

Pressure Switches/ Pressure Sensors



Air Grippers Precautions 4

Be sure to read this before handling.

Operating Environment

Warning

- 1. Do not use in an atmosphere having corrosive gases, chemicals, sea water, water, water steam, or where there is direct contact with any of these.**
Refer to each construction drawing on the air grippers material.
- 2. Do not expose the product to direct sunlight for an extended period of time.**
- 3. Do not use in a place subject to heavy vibration and/or shock.**
- 4. Do not mount the product in locations where it is exposed to radiant heat.**
- 5. Do not use in dusty locations or where water or oil, etc., splash on the equipment.**

Maintenance

Warning

- 1. Perform maintenance inspection according to the procedures indicated in the operation manual.**
If handled improperly, malfunction and damage of machinery or equipment may occur.
- 2. Maintenance work**
If handled improperly, compressed air can be dangerous. Assembly, handling, repair and element replacement of pneumatic systems should be performed by a knowledgeable and experienced person.
- 3. Drain flushing**
Remove drainage from air filters regularly.
- 4. Removal of equipment, and supply/exhaust of compressed air**
When components are removed, first confirm that measures are in place to prevent workpieces from dropping, run-away equipment, etc. Then, cut off the supply pressure and electric power, and exhaust all compressed air from the system using the residual pressure release function.
When machinery is restarted, proceed with caution after confirming that appropriate measures are in place to prevent cylinders from sudden movement.
- 5. Do not allow people to enter or place objects in the carrying path of the air gripper.**
This can cause an injury or accident, etc.
- 6. Do not put hands, etc. in between the air gripper fingers or attachments.**
This can cause an injury or accident, etc.
- 7. When removing the air gripper, first confirm that no workpieces are being held and then release the compressed air before removing the air gripper.**
If a workpiece is still being held, there is a danger of it being dropped.

Caution

- 1. The dust cover is a consumable part. Replace it as necessary.**
Fine particles, cutting oil, etc., may cause the main body to malfunction.

Air Grippers

Applicable Auto Switch List

Type	Auto switch mounting	Electrical entry	Auto switch model	Applicable air grippers			
				Size			
				11-/22-MHZ2 10 to 25	11-/22-MDHR2 10 to 30	11-/22-MDHR3 10-15	11-/22-MHL2 10 to 40
Solid state auto switch	Direct	Grommet	D-F8N-F8P-F8B	●			
			D-M9N-M9P-M9B D-M9NV-M9PV-M9BV	●	●	●	●
			D-Y59A-Y7P-Y59B D-Y69A-Y7PV-Y69B				●
	Direct	Grommet	D-Y7NW-7PW-7BW D-Y7N WV-7PWV-7BWV				●
			D-F9NW-F9PW-F9BW D-F9N WV-F9PWV-F9BWV	●	●	●	●
	Direct	Grommet	D-Y7BAL				●
2-color indicator							
Water sensing indicator							

Note) Refer to the **WEB catalog** for further information on auto switches.

Note) When using the 2-color indicator type, please make the setting so that the indicator is lit in red to ensure the detection at the proper position of the air gripper.

Directional Control Valves

Air Cylinders

Rotary Actuators

Air Grippers

Air Preparation Equipment

Modular F. R.

Pressure Control Equipment

Fittings & Tubing

Flow Control Equipment

Pressure Switches/ Pressure Sensors

For Clean Room

Air Preparation Equipment

Contents	Series	Page
■ Air Dryers		
Membrane Air Dryer	10-IDG□A	P.949
Membrane Air Dryer	10-IDG	P.950
■ Compressed Air Cleaning Filter Series		
Main Line Filter	10-AFF	P.959
Mist Separator	10-AM	P.966
Micro Mist Separator	10-AMD	P.973
Micro Mist Separator with Pre-filter	10-AMH	P.980
Super Mist Separator	10-AME	P.987
Odor Removal Filter	10-AMF	P.994
■ Clean Gas Filters/Air Filters		
Clean Gas Filter: Cartridge Type/Disc Type	SFA100/200/300	P.1011
Clean Gas Filter: Cartridge Type/Straight Type	SFB100/200	P.1014
Clean Gas Filter: Disposable Type/Straight Type	SFB300	P.1018
Clean Gas Filter: Disposable Type/Multiple Disc Type	SFC100	P.1021
Clean Air Filter	SFD	P.1031
Clean Air Module	LLB	P.1039
■ Clean Exhaust Cleaner/Filter		
Exhaust Cleaner for Clean Room	AMP	P.1055
Clean Exhaust Filter	SFE	P.1060
Precautions		P.1064

Directional
Control Valves

Air Cylinders

Rotary Actuators

Air Grippers

Air Preparation
Equipment

Modular F. R.

Pressure Control
Equipment

Fittings & Tubing

Flow Control
Equipment

Pressure Switches/
Pressure Sensors



Series 10-IDG□A

Standard dew point -20°C, -15°C, -40°C, -60°C

Membrane Air Dryer/Single Unit Type

How to Order



Clean series • **10-IDG 30** □ **A** - □ **03** □ - □

Size •

30
50
60
75
100

Standard dew point temperature/Outlet air flow rate •

Symbol	Standard dew point (°C)	Flow rate by size, Outlet air flow rate (L/min [ANR])				
		30	50	60	75	100
Nil	-20	300	500	Select from Series 10-IDG (Page 950)		
H	-15	300	500			
L	-40	75	110	170	240	300
S	-60	—	—	50	100	150

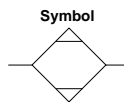

Thread type •

Symbol	Type
Nil	Rc
N	NPT
F	G

• Semi-standard

Symbol	Specifications
Nil	None (Standard)
R	Flow direction (Right → Left)

• Accessory

Symbol	Specifications
Nil	None (Standard)
B	With bracket

Note) When B is designated, a bracket assembly with a part number shown to the left below is included as an accessory.

• Port size

Symbol	Port size	Size				
		30	50	60	75	100
02	1/4	●	●	—	—	—
03	3/8	●	●	●	●	●
04	1/2	—	—	●	●	●

Bracket Assembly (Accessory)/Part No.

Part no.	Applicable model
10-BM64	10-IDG30□A, 10-IDG50□A
10-BM65	10-IDG60□A, 10-IDG75□A, 10-IDG100□A

* With hexagon socket head cap screws (2 pcs.) and spring washers (2 pcs.)



Series 10-IDG

Membrane Air Dryer
Single Unit Type

RoHS

How to Order

10-IDG 10 - - 02 - -

Clean series

Size

3
5
10
20
60
75
100



Standard dew point temperature/Outlet air flow rate

Symbol	Standard dew point (°C)	Flow rate by size, Outlet air flow rate (L/min [ANR])						
		3	5	10	20	60	75	100
Nil	-20	25	50	100	200	600	750	1000
H	-15	25	50	100	200	600	750	1000
L	-40	—	—	—	—	Select from Series 10-IDG□A (Page 949)		
S	-60	—	—	—	—	Series 10-IDG□A (Page 949)		

Accessory

Symbol	Specifications
Nil	None (Standard)
B	With bracket

Note) When B is designated, a bracket assembly with a part number shown to the left below is included as an accessory.

Port size/Applicable tubing O.D.

Symbol	Port size	Piping type	Size						
			3	5	10	20	60	75	100
01	1/8	Thread	●	●	—	—	—	—	—
02	1/4		●	●	●	●	—	—	—
03	3/8		—	—	●	●	●	—	—
04	1/2		—	—	—	—	●	●	●

Thread type/One-touch fitting

Symbol	Type
Nil	Rc
N	NPT
F	G

Symbol

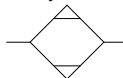

Bracket Assembly (Accessory)/Part No.

Part no.	Applicable model
10-BM59	10-IDG3□, 10-IDG5□
10-BM61	10-IDG10□
10-BM63	10-IDG20□
10-BM65	10-IDG60□, 10-IDG75□, 10-IDG100□

* With hexagon socket head cap screws (2 pcs.) and spring washers (2 pcs.)

Semi-standard

Symbol	Specifications	Size						
		3	5	10	20	60	75	100
Nil	None (Standard)	●	●	●	●	●	●	●
R	Flow direction (Right → Left)	●	●	●	●	●	●	●
S	With dew point indicator	●	●	Standard equipment				

Note) In the case of more than one symbol, indicate them alphabetically.

Directional Control Valves

Air Cylinders

Rotary Actuators

Air Grippers

Air Preparation Equipment

Modular F. R.

Pressure Control Equipment

Fittings & Tubing

Flow Control Equipment

Pressure Switches/ Pressure Sensors

Standard Specifications/Single Unit Type (Standard dew point -20°C, -15°C)

Standard dew point----20°C

Model		Standard dew point -20°C								
		10-IDG3	10-IDG5	10-IDG10	10-IDG20	10-IDG30A	10-IDG50A	10-IDG60	10-IDG75	10-IDG100
Range of operating conditions	Fluid	Compressed air								
	Inlet air pressure (MPa)	0.3 to 0.85			0.3 to 1.0					
	Inlet air temperature (°C)	-5 to 55 ^{Note 1)}			-5 to 50 ^{Note 1)}					
	Ambient temperature (°C)	-5 to 55 ^{Note 1)}			-5 to 50 ^{Note 1)}					
Standard performance conditions	Outlet air atmospheric pressure dew point (°C)	-20								
	Inlet air flow rate (L/min [ANR]) ^{Note 2)}	31	62	125	250	360	586	725	900	1190
	Outlet air flow rate (L/min [ANR])	25	50	100	200	300	500	600	750	1000
	Purge air flow rate (L/min [ANR]) ^{Note 3)}	6	12	25	50	60	86	125	150	190
	Inlet air pressure (MPa)	0.7								
	Inlet air temperature (°C)	25								
	Inlet air saturation temperature (°C)	25								
	Ambient temperature (°C)	25								
	Dew point indicator purge air flow rate	—			1 L/min [ANR] (Inlet air pressure at 0.7 MPa)					
	Port size	1/8, 1/4			1/4, 3/8			3/8, 1/2		1/2
Weight (kg)(With bracket)	0.3 (0.36)		0.5 (0.58)	0.78 (0.88)	1.01 (1.04)	1.04 (1.17)	1.67 (1.82)	1.67 (1.82)	1.72 (1.87)	
Cleanliness class (ISO class)	Class 3									

Note 1) No freezing.

Note 2) "ANR" indicates the flow rate converted to the value at 20°C, under the atmospheric pressure and the state of relative humidity 65%.

Note 3) Includes 1 L/min [ANR] of purge air flow (Inlet air pressure at 0.7 MPa) for the dew point indicator (except 10-IDG3, 10-IDG5).

Standard dew point----15°C/Type H

Model		Standard dew point -15°C								
		10-IDG3H	10-IDG5H	10-IDG10H	10-IDG20H	10-IDG30HA	10-IDG50HA	10-IDG60H	10-IDG75H	10-IDG100H
Range of operating conditions	Fluid	Compressed air								
	Inlet air pressure (MPa)	0.3 to 0.85			0.3 to 1.0					
	Inlet air temperature (°C)	-5 to 55 ^{Note 1)}			-5 to 50 ^{Note 1)}					
	Ambient temperature (°C)	-5 to 55 ^{Note 1)}			-5 to 50 ^{Note 1)}					
Standard performance conditions	Outlet air atmospheric pressure dew point (°C)	-15								
	Inlet air flow rate (L/min [ANR]) ^{Note 2)}	28	56	111	222	329	550	665	830	1110
	Outlet air flow rate (L/min [ANR])	25	50	100	200	300	500	600	750	1000
	Purge air flow rate (L/min [ANR]) ^{Note 3)}	3	6	11	22	29	50	65	80	110
	Inlet air pressure (MPa)	0.7								
	Inlet air temperature (°C)	25								
	Inlet air saturation temperature (°C)	25								
	Ambient temperature (°C)	25								
	Dew point indicator purge air flow rate	—		1 L/min [ANR] (Inlet air pressure at 0.7 MPa)						
	Port size	1/8, 1/4			1/4, 3/8			3/8, 1/2		1/2
Weight (kg)(With bracket)	0.3 (0.36)		0.5 (0.58)	0.78 (0.88)	1.01 (1.04)	1.04 (1.17)	1.67 (1.82)	1.67 (1.82)	1.72 (1.87)	
Cleanliness class (ISO class)	Class 3									

Note 1) No freezing.

Note 2) "ANR" indicates the flow rate converted to the value at 20°C, under the atmospheric pressure and the state of relative humidity 65%.

Note 3) Includes 1 L/min [ANR] of purge air flow (Inlet air pressure at 0.7 MPa) for the dew point indicator (except 10-IDG3H, 10-IDG5H).

Standard Specifications/Single Unit Type (Standard dew point -40°C, -60°C)

Standard dew point...-40°C/Type L

Model		Standard dew point -40°C				
		10-IDG30LA	10-IDG50LA	10-IDG60LA	10-IDG75LA	10-IDG100LA
Range of operating conditions	Fluid	Compressed air				
	Inlet air pressure (MPa)	0.3 to 1.0				
	Inlet air temperature (°C)	-5 to 50 ^{Note 1)}				
	Ambient temperature (°C)	-5 to 50 ^{Note 1)}				
Standard performance	Outlet air atmospheric pressure dew point (°C)	-40				
	Inlet air flow rate (L/min [ANR]) ^{Note 2)}	93	135	224	308	400
Standard performance conditions	Outlet air flow rate (L/min [ANR])	75	110	170	240	300
	Purge air flow rate (L/min [ANR]) ^{Note 3)}	18	25	54	68	100
	Inlet air pressure (MPa)	0.7				
	Inlet air temperature (°C)	25				
	Inlet air saturation temperature (°C)	25				
	Ambient temperature (°C)	25				
	Dew point indicator purge air flow rate	1 L/min [ANR] (Inlet air pressure at 0.7 MPa)				
Port size	1/4, 3/8			3/8, 1/2		
Weight (kg)(With bracket)	1.01 (1.04)	1.04 (1.17)	1.73 (1.88)	1.86 (2.01)	1.99 (2.14)	
Cleanliness class (ISO class)	Class 3					

Note 1) No freezing.

Note 2) "ANR" indicates the flow rate converted to the value at 20°C, under the atmospheric pressure and the state of relative humidity 65%.

Note 3) Includes 1 L/min [ANR] of purge air flow (Inlet air pressure at 0.7 MPa) for the dew point indicator.

Standard dew point...-60°C/Type S

Model		Standard dew point -60°C		
		10-IDG60SA	10-IDG75SA	10-IDG100SA
Range of operating conditions	Fluid	Compressed air		
	Inlet air pressure (MPa)	0.3 to 1.0		
	Inlet air temperature (°C)	-5 to 50 ^{Note 1)}		
	Ambient temperature (°C)	-5 to 50 ^{Note 1)}		
Standard performance	Outlet air atmospheric pressure dew point (°C)	-60		
	Inlet air flow rate (L/min [ANR]) ^{Note 2)}	75	140	230
Standard performance conditions	Outlet air flow rate (L/min [ANR])	50	100	150
	Purge air flow rate (L/min [ANR]) ^{Note 3)}	25	40	80
	Inlet air pressure (MPa)	0.7		
	Inlet air temperature (°C)	25		
	Inlet air saturation temperature (°C)	25		
	Ambient temperature (°C)	25		
	Dew point indicator purge air flow rate	1 L/min [ANR] (Inlet air pressure at 0.7 MPa)		
Port size	3/8, 1/2			
Weight (kg)(With bracket)	1.73 (1.88)	1.86 (2.01)	1.99 (2.14)	
Cleanliness class (ISO class)	Class 3			

Note 1) No freezing.

Note 2) "ANR" indicates the flow rate converted to the value at 20°C, under the atmospheric pressure and the state of relative humidity 65%.

Note 3) Includes 1 L/min [ANR] of purge air flow (Inlet air pressure at 0.7 MPa) for the dew point indicator.

Directional Control Valves
 Air Cylinders
 Rotary Actuators
 Air Grippers
 Air Preparation Equipment
 Modular F. R.
 Pressure Control Equipment
 Fittings & Tubing
 Flow Control Equipment
 Pressure Switches/ Pressure Sensors

Dimensions

10-IDG3, 5 10-IDG3H, 5H

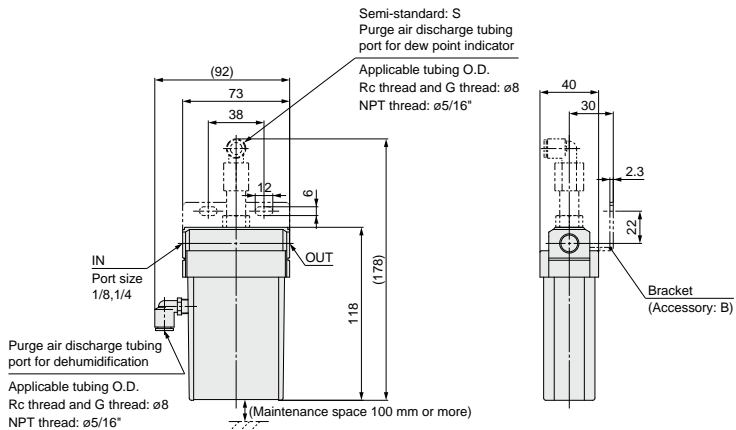

10-IDG10, 10H

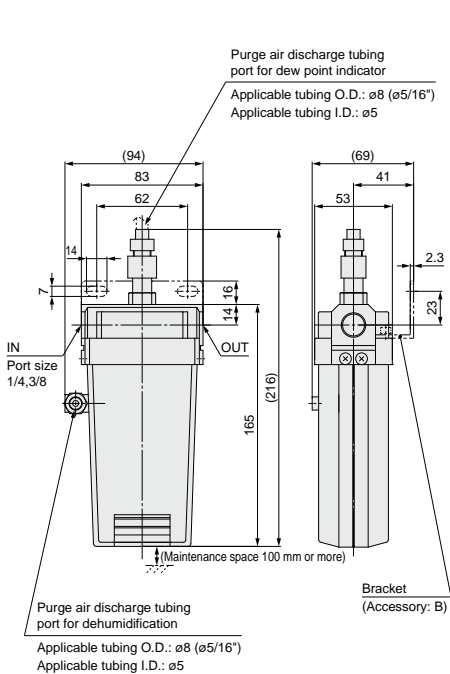

10-IDG20, 20H

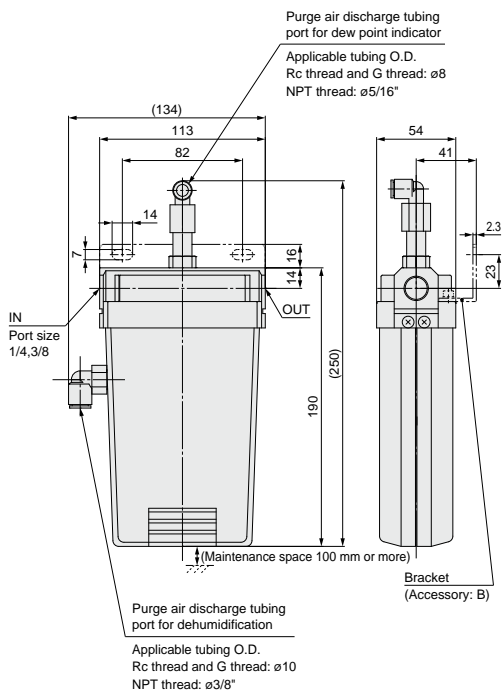



Dimensions

10-IDG30□A, 50□A

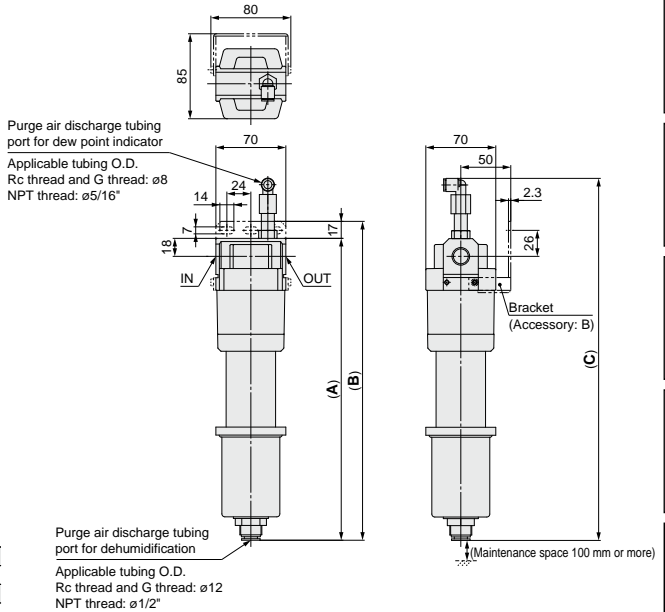

Model	Port size	A	B	C
10-IDG30□A	1/4, 3/8	302	319	362
10-IDG50□A		341	358	401

**10-IDG60□, 75□, 100□
10-IDG60□A, 75□A, 100□A**

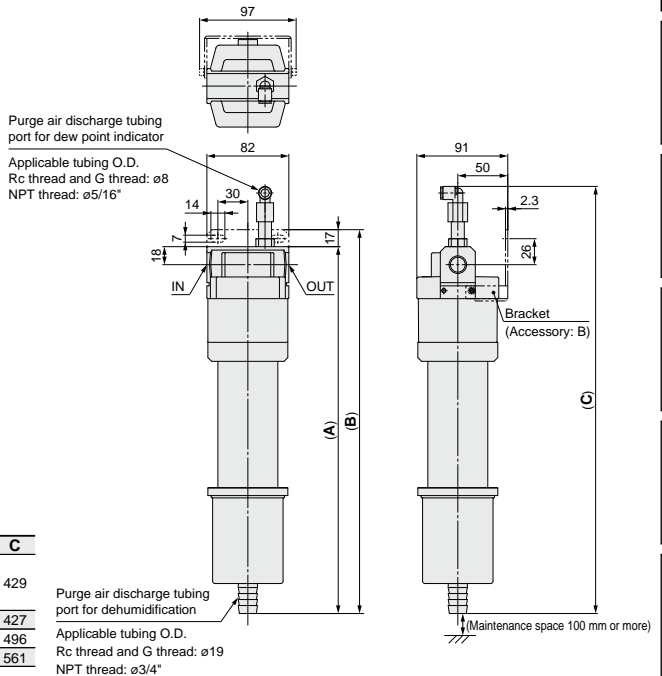

Model	Port size	A	B	C
10-IDG60, 60H	3/8, 1/2	369	386	429
10-IDG75, 75H	1/2			
10-IDG100, 100H	3/8, 1/2	367	384	427
10-IDG60LA, 60SA		436	453	496
10-IDG75LA, 75SA		501	518	561
10-IDG100LA, 100SA				

Directional Control Valves

Air Cylinders

Rotary Actuators

Air Grippers

Air Preparation Equipment

Modular F. R.

Pressure Control Equipment

Fittings & Tubing

Flow Control Equipment

Pressure Switches/Pressure Sensors

⚠ Specific Product Precautions

Be sure to read this before handling.

Design

⚠ Warning

- Depending on the model and operating conditions, the oxygen ratio of the outlet air may drop below the prescribed standard.**

Do not use standard dew point -40°C (symbol: L) type, standard dew point -60°C (symbol: S) type and 10-IDG30A, 50A, 30HA, 50HA for dehumidifying breathing air. Do not use only outlet air (dry air) in a closed room.

⚠ Caution

- Install a regulator on the outlet side of the membrane air dryer.**

If it is installed on the inlet side, dehumidification performance will be reduced.

- Devise a layout which considers the position of purge air discharge ports.**

Purge air is humid air. Devise a layout in which purge air will not cause trouble such as corrosion or malfunction of peripheral equipment.

- When highly purified air is required**

(Supply to air bearings, blowing of semiconductor parts, etc.)
Install a micro mist separator or super mist separator on the outlet side (end terminal) of the membrane air dryer (unit).

- Time to reach the standard dew point**

A certain amount of time is required to achieve the standard dew point after the air begins flowing into the membrane air dryer. Using the times below as a guide, begin operating outlet side equipment after the standard dew point is achieved.

Standard dew point -20°C , -15°C : About 10 minutes
 Standard dew point -40°C : About 30 minutes *
 Standard dew point -60°C : About 60 minutes *

* This time can be shortened as described below.

- Provide a valve on the outlet side of the membrane air dryer.
- Supply air with the valve closed. Only purge air flows into the membrane air dryer.
- After 15 minutes or more, open the valve and let air flow to the outlet side equipment.

- Dehumidification performance when inlet air temperature changes**

Performance chart shows the case at an inlet air temperature of 25°C . In other cases, refer to Model Selection (**WEB catalog** or Best Pneumatics No. 5) for proper selection.

Selection

⚠ Caution

- Consider the purge air flow rate.**

Find the purge air flow rate from the charts and calculate the "required outlet air flow rate + purge air flow rate". The air supply capacity must be at least equal to the calculated flow or the required outlet air flow rate cannot be obtained.

- Selection for a compressed air line in which a mist separator or micro mist separator is already installed**

Verify the operating air flow rate and air pressure, and select a membrane air dryer in accordance with Model Selection (**WEB catalog** or Best Pneumatics No. 5). If a membrane air dryer is selected using the port size of the equipment that is already installed as a reference, it could result in the selection of a model that is too small and has an insufficient dehumidification capacity.

Mounting

⚠ Caution

- Do not obstruct the purge air discharge ports.**

Dehumidification performance will decrease or may become impossible if purge air back pressure becomes too high or purge air stops flowing.

- Be sure to install a mist separator and micro mist separator or a micro mist separator with pre-filter on the inlet side of the membrane air dryer.**

If the inlet air contains oil, performance will be reduced.

- Take sufficient care in handling.**

There is a danger of damage if dropped.

- Remove water droplets from the inlet air.**

Water droplets in the air can lower performance and cause malfunction.

⚠ Specific Product Precautions

Be sure to read this before handling.

Piping

⚠ Warning

- Check for tightening of the holder.**
(for 10-IDG30A to IDG100, 10-IDG30HA to IDG100H, 10-IDG30LA to IDG100LA, 10-IDG60SA to IDG100SA)
Before starting the flow of compressed air, turn the membrane air dryer's holder in its tightening direction, confirming that it is completely tightened and that the case will not come off.
- Piping for dehumidification purge air outlet**
The piping of purge air for dehumidification and for the dew point indicator can be combined, but do not combine it with compressed air lines or drain piping. As this can cause damage.

⚠ Caution

- Use of tools**
Hold the upper portion of the body (aluminum die-casted section) with a wrench or adjustable angle wrench. Do not turn it while holding the case section.
- Piping materials for low dew point air**
If air of a low dew point (−40°C or less) is required, do not use a nylon tube piping and resin fittings (except fluoropolymer) for the outlet side of the membrane air dryer. Due to the nature of the nylon tube, it could be affected by the ambient air, and it might not be possible to achieve the prescribed low dew point at the end of the tube. Therefore, for low dew point air, use a stainless steel or fluoropolymer piping.

3. Length of the connecting tube for dehumidification purge air outlet

The dehumidification capacity decreases in proportion to the length of the tube for discharging purge air. Use a tube of the specified size and keep its length within 5 m. For the outlet air atmospheric pressure dew point in relation to the tube length for discharging purge air, refer to the table "regarding the outlet air atmospheric dew point in relation to the tube length for purge air discharge" on **WEB catalog** or Best Pneumatics No. 5.

4. Connection of purge air discharge tubing (for 10-IDG60 to IDG100, 10-IDG60H to IDG100H, 10-IDG60LA to IDG100LA, 10-IDG60SA to IDG100SA)

To install piping for dehumidification purge air discharge, attach tubing of the prescribed size to the hose nipple section and then secure it with tubing bands.

Air Supply

⚠ Caution

- Compressed air supply capacity**
An air source that has a supply capacity that is larger than the "required outlet air flow rate (dry air flow rate) + purge air flow rate" is required. Verify the purge air flow rate in Purge Air Flow-rate Characteristics. (**WEB catalog** or Best Pneumatics No. 5)
- Chemicals with a negative effect on this product**
Chemicals listed in the table below in the compressed air can lower performance and damage the element. Do not use the product in environments including these chemicals.

Category	Chemicals not to be included
Solvents	Acetone, benzene, phenol, toluene, trichloroethylene, xylene, cresol, thinner, aniline, chloroform, chlorobenzene, trichloroethane, ethylbenzene, ethyl alcohol, methyl alcohol, isopropyl alcohol, dioxin, tetrahydrofuran, methylene chloride, cyclohexane, carbon tetrachloride, methyl ketone, ethyl ketone, hexafluoroisopropanol, and others
Acids	Sulfuric acid, nitric acid, hydrochloric acid, acetic acid, lactic acid, chromic acid, and others
Gases	Chlorine gas, sulfurous acid gas, hydrogen chloride, bromine, ozone, ammonia, and others
Oils	Phosphoric-ester hydraulic oil, fuel oil, water soluble cutting oil (alkaline), kerosene, and others
Strong bases	Lithium hydroxide, sodium hydroxide, potassium hydroxide, calcium hydroxide, and others
Others	Anaerobic adhesive, anaerobic sealant, and others

Operating Environment

⚠ Caution

- Do not use at temperatures (fluid or ambient temperatures) higher than the prescribed operating conditions.**
Resin is used in the membrane module, and it can be damaged by operation at high temperatures. Especially when installed immediately after a reciprocating type air compressor, confirm that the fluid temperature does not exceed the range of operating conditions during use.
- Keep the inlet air temperature lower than the ambient temperature.**
If the membrane air dryer body is cooled by the surrounding air, water drops may accumulate inside and reduce its dehumidification capacity.

Directional Control Valves

Air Cylinders

Rotary Actuators

Air Grippers

Air Preparation Equipment

Modular F. R.

Pressure Control Equipment

Fittings & Tubing

Flow Control Equipment

Pressure Switches/ Pressure Sensors

⚠ Precautions

Be sure to read this before handling.

Maintenance

⚠ Warning

- Do not remove the parts or piping when in a pressurized state.**

Never remove them while under pressure, as they could fly out, causing dangerous situations.

⚠ Caution

- Check the dehumidification function with the dew point indicator.**

Observe the color of the dew point indicator to confirm whether the membrane air dryer is functioning normally.

[When dew point indicator color is blue: Functioning normally]

[When dew point indicator color is pink: Dew point temperature is high. (Outlet air is humid.) Note: Atmospheric pressure dew point approximately -10°C minimum]

Performance state	Color of the dew point indicator	Note
Initial state	White/Pink	There are both white and pink grains.
Normal operating	Blue	
Decrease in performance	White/Pink	Air flow rate etc. can be outside of the specifications.
	Brown/Black	Contained oils can lower the performance.

If humid air flowing in turns the color pink, and then if dry air enters, the color turns back to blue.

It takes about 1 hour from the start of air flow for the dew point indicator color to change.

- Dew point indicator replacement period**

The absorbent is used in the dew point indicator. It absorbs the gasified oil in the compressed air and/or the gaseous elements other than the air, and then may turn brown.

When it turned brown, replace the dew point indicator. Besides, in the event of replacing them periodically, carry out after two-year operation as a guideline.

- Membrane module replacement period**

Replace the membrane module when the color of the dew point indicator turns white or pink.

- Tightening torque for installing the membrane module and the case (for 10-IDG5, 10, 20, 5H, 10H, 20H)**

Use caution not to tighten excessively.

It may result in a breakdown of membrane module, case and mounting screws or insufficient sealing.

(Check the tightening torque range in the Operation Manual.)

- Installing a pressure gauge**

A pressure gauge (for clean series) should be installed on the inlet and outlet sides of the membrane air dryer for the maintenance and inspection purposes.

Metrology (Measurement) Law

⚠ Caution

- SMC products are not intended for use as instruments for legal metrology.**

Measurement instruments that SMC manufactures or sells have not been qualified by type approval tests relevant to the metrology (measurement) laws of each country.

Therefore, SMC products cannot be used for business or certification ordained by the metrology (measurement) laws of each country.

Series 10-AFF/10-AM

Compressed Air Cleaning Filter Series

	Series	Nominal filtration rating	Oil mist density at outlet	Smell	Page	
Solid/Oil Separator	Series 10-AFF	3 μm (Filtration efficiency: 99%)	—		P.959	Directional Control Valves
	Series 10-AM	0.3 μm (Filtration efficiency: 99.9%)	1 mg/m ³ [ANR] (=0.8 ppm) (after oil saturation)	—	P.966	Air Cylinders
	Series 10-AMD	0.01 μm (Filtration efficiency: 99.9%)	0.1 mg/m ³ [ANR] (=0.08 ppm) (after oil saturation)		P.973	Rotary Actuators
	Series 10-AMH	0.3 + 0.01 μm (Filtration efficiency: 99.9%)			P.980	Air Grippers
	Series 10-AME	0.01 μm (Filtration efficiency: 99.9%)	0.01 mg/m ³ [ANR] (=0.008 ppm)	Reduces oil smell.	P.987	
Deodorizer	Series 10-AMF		0.004 mg/m ³ [ANR] (=0.0032 ppm)	Deodorizes oil smell.	P.994	Air Preparation Equipment
Modular Connection Examples					P.1001	
How to Order Bowl Assembly					P.1002	
Options	<ul style="list-style-type: none"> Seal material: Fluororubber IN-OUT reversal direction For medium air pressure With element service indicator 				Refer to How to Order of respective models.	Modular F. R.
Specific Product Precautions					P.1006	

Series 10-AFF

Main Line Filter

RoHS

Can remove impurities such as oil, water and foreign matter in compressed air and can improve the function of a dryer in the downstream, extend the replacement period of precision filter element, and prevent trouble with the equipment.

Modular connection is possible with 10-AFF2C to 22C.

(For details, refer to page 1001.)



10-AFF2C to 22C



10-AFF37B/75B

Caution

Be sure to read this before handling.
Refer to page 1382 for Safety Instructions and pages 1064 to 1066 for Air Preparation Equipment Precautions.

Model

Model	10-AFF2C	10-AFF4C	10-AFF8C	10-AFF11C	10-AFF22C	10-AFF37B	10-AFF75B
Rated flow (Note) (L/min [ANR])	300	750	1500	2200	3700	6000	12000
Port size	1/8, 1/4	1/4, 3/8	3/8, 1/2	1/2, 3/4	3/4, 1	1, 1 1/2	1 1/2, 2
Weight (kg)	0.38	0.55	0.9	1.4	2.1	4.2	10.5

Note) Maximum flow capacity at 0.7 MPa.

Maximum flow capacity varies depending on the operating pressure.

Refer to Flow Rate Characteristics (page 962) and Max. Flow Capacity Line below.

Specifications

Fluid	Compressed air
Max. operating pressure	1.0 MPa
Min. operating pressure	0.05 MPa
Proof pressure	1.5 MPa
Ambient and fluid temperature	5 to 60°C
Nominal filtration rating	3 μm (Filtration efficiency: 99%)
Element replacement period	2 years or when pressure drop reached 0.1 MPa
Cleanliness class (ISO class)	Class 3

Accessory/For 10-AFF2C to 22C, 10-AFF37B/75B

Applicable model	10-AFF2C	10-AFF4C	10-AFF8C	10-AFF11C	10-AFF22C	10-AFF37B	10-AFF75B
Bracket assembly (with 2 mounting screws)	10-AM-BM101	10-AM-BM102	10-AM-BM103	10-AM-BM104	10-AM-BM105	10-BM56	10-BM57

Model Selection

Select a model in accordance with the following procedure taking the inlet pressure and the maximum flow capacity into consideration.

(Example) Inlet pressure: 0.6 MPa

Maximum flow capacity: 5 m³/min [ANR]

1. Obtain the intersecting point A of inlet pressure and maximum flow capacity in the graph.
2. The 10-AFF37B is obtained when the max. flow capacity line is above the intersecting point A in the graph.

Note) Make sure to select a model that has the max. flow capacity line above the obtained intersecting point. With a model that has the max. flow capacity line below the obtained intersecting point, the flow rate will be exceeded, thus leading to a problem such as being unable to satisfy the specifications.

Max. Flow Capacity Line

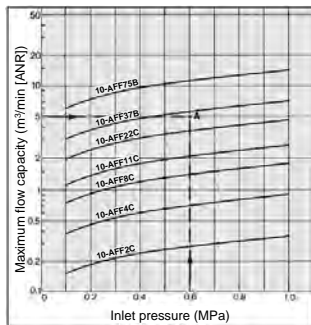



How to Order

10-AFF2C to 10-AFF22C

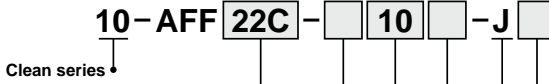

Clean series

Body size

2C
4C
8C
11C
22C

Thread type

Symbol	Type
Nil	Rc
F	G
N	NPT

Port size

Symbol	Size	Applicable body size				
		2C	4C	8C	11C	22C
01	1/8	●				
02	1/4	●	●			
03	3/8		●	●		
04	1/2			●	●	
06	3/4				●	●
10	1					●

Option

Symbol	Description
Nil	—
F	Rubber material: Fluororubber*3
H	For medium air pressure (1.6 MPa)*3
R	IN-OUT reversal direction
T	With element service indicator*3

*3 Combination of T and F or H is not available.

Drain guide*2 1/4 female thread

*2 Drain piping and piping for a stop valve such as ball valve are required.

Accessory

Symbol	Description
Nil	—
B	Bracket *1

*1 Bracket is included (but not assembled).

Options

Symbol F: Rubber material: Fluororubber

Fluororubber is used for the parts such as O-ring and gasket.

Symbol H: For medium air pressure (1.6 MPa)

Can be used up to 1.6 MPa at maximum.

Symbol R: IN-OUT reversal direction

Air flow direction is changed to right to left.
(Air flow direction of the standard: Left to right.)

Symbol T: With element service indicator

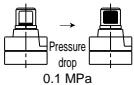

Saturation of the element can be observed visually.

Directional Control Valves

Air Cylinders

Rotary Actuators

Air Grippers

Air Preparation Equipment

Modular F. R.

Pressure Control Equipment

Fittings & Tubing

Flow Control Equipment

Pressure Switches/ Pressure Sensors

How to Order



10-AFF37B, 75B

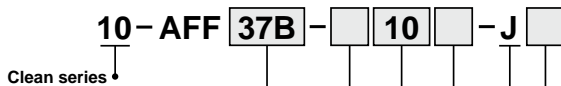

Body size •

37B
75B

Thread type •

Symbol	Type
Nil	Rc
F	G
N	NPT

Port size •

Symbol	Size	Applicable body size	
		37B	75B
10	1	●	—
14	1 1/2	●	●
20	2	—	●

Option

Symbol	Description
Nil	—
R	IN-OUT reversal direction
T	With element service indicator

• **Drain guide*2 1/4 female thread (10-AFF37B), 3/8 female thread (10-AFF75B)**

*2 Drain piping and piping for a stop valve such as ball valve are required.

Accessory

Symbol	Description
Nil	—
B	Bracket *1

*1 Bracket is included (but not assembled).

Flow Rate Characteristics/Select the model under the max. flow capacity line. (Element oil saturation)

Note) Compressed air over max. flow capacity line in the table below may not meet the specifications of the product.

10-AFF2C

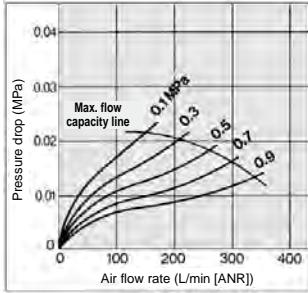

10-AFF11C

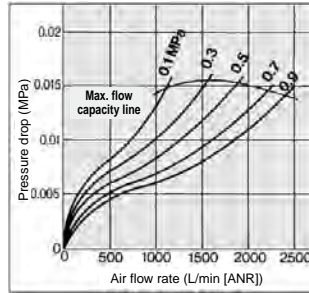

10-AFF75B

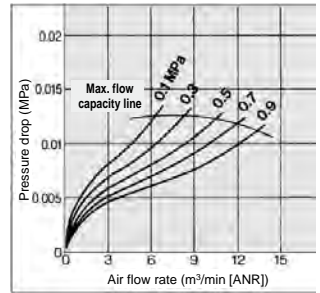

10-AFF4C

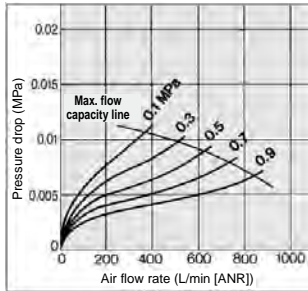

10-AFF22C

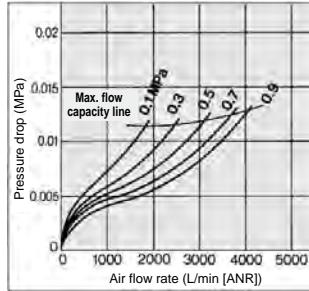

10-AFF8C

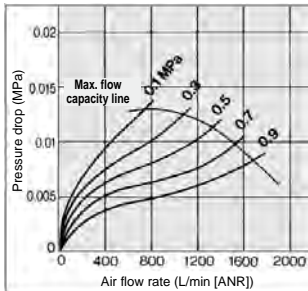

10-AFF37B

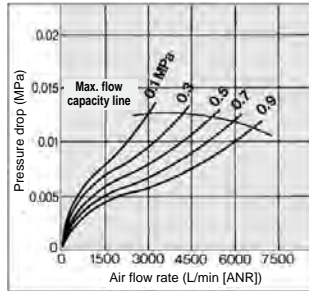

- Directional Control Valves
- Air Cylinders
- Rotary Actuators
- Air Grippers
- Air Preparation Equipment
- Modular F. R.
- Pressure Control Equipment
- Fittings & Tubing
- Flow Control Equipment
- Pressure Switches/ Pressure Sensors

Construction

10-AFF2C to 22C, 10-AFF37B

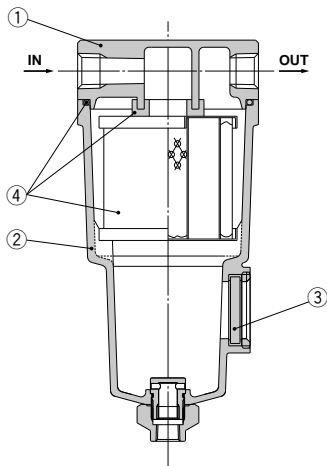

10-AFF75B

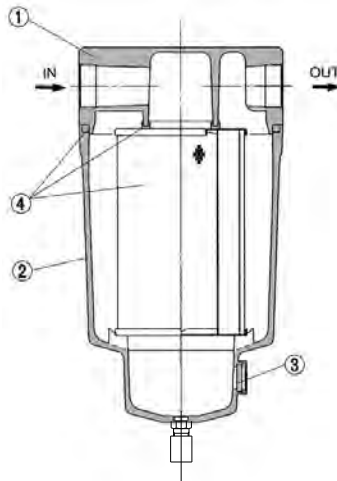

Component Parts

No.	Description	Material	Note
1	Body	Aluminum die-casted	Inner/outer surface coating
2	Housing	Aluminum die-casted*	Inner/outer surface coating
3	Sight glass	Tempered glass	—

* The 10-AFF75B is aluminum casted.

Note) Sight glass is indicated in the figure for easy understanding of component parts. However, it differs from the actual construction. Refer to Dimensions on pages 964 to 965 for details.

Replacement Parts

No.	Description	Material	Applicable model	Model						
				10-AFF2C	10-AFF4C	10-AFF8C	10-AFF11C	10-AFF22C	10-AFF37B	10-AFF75B
4	Element assembly	Cotton paper, others	Except option F	10-AFF-EL2B	10-AFF-EL4B	10-AFF-EL8B	10-AFF-EL11B	10-AFF-EL22B	10-AFF-EL37B	10-AFF-EL75B
			For option F	10-AFF-EL2B-F	10-AFF-EL4B-F	10-AFF-EL8B-F	10-AFF-EL11B-F	10-AFF-EL22B-F	—	—

- Element assembly: With gasket (1 pc.) and O-ring (1 pc.)
- Refer to How to Order Bowl Assembly on page 1002.

Dimensions

10-AFF2C to 22C

Option

T: With element service indicator

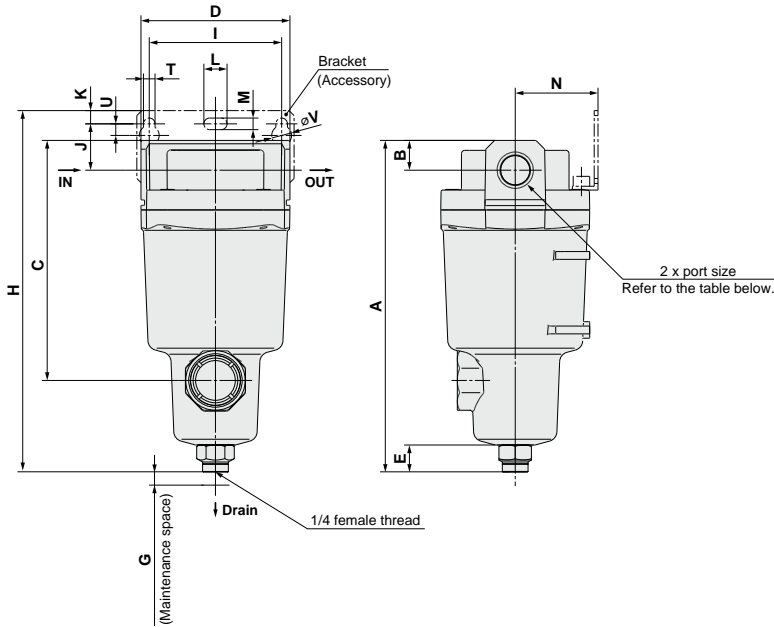
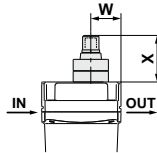
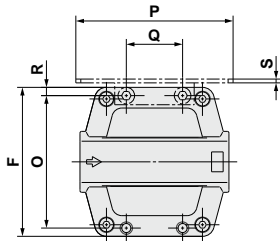

Model	Port size	A	B	C	D	E	F	G	Bracket related dimensions										Element service indicator related dimensions						
									H	I	J	K	T	U	L	M	V	N	O	P	Q	R	S	W	X
10-AFF2C	1/8, 1/4	158	10	99	63	20	63	10	173	56	20	5	6	6	12	6	10	35	54	70	26	4.5	1.6	24	37
10-AFF4C	1/4, 3/8	172	14	113	76	20	76	10	190	66	24	8	6	6	12	6	10	40	66	80	28	5	2	27	37
10-AFF8C	3/8, 1/2	204	18	145	90	20	90	10	222	80	28	8	7	7	14	7	12	50	80	95	34	5	2.3	32	37
10-AFF11C	1/2, 3/4	225	20	166	106	20	106	10	246	90	31	10	9	9	18	9	15	55	88	111	50	9	3.2	37	37
10-AFF22C	3/4, 1	259	24	200	122	20	122	15	278	100	33	10	9	9	18	9	15	65	102	126	60	10	3.2	39	37

Directional Control Valves
Air Cylinders
Rotary Actuators
Air Grippers
Air Preparation Equipment
Modular F. R.
Pressure Control Equipment
Fittings & Tubing
Flow Control Equipment
Pressure Switches/ Pressure Sensors

Dimensions

10-AFF37B

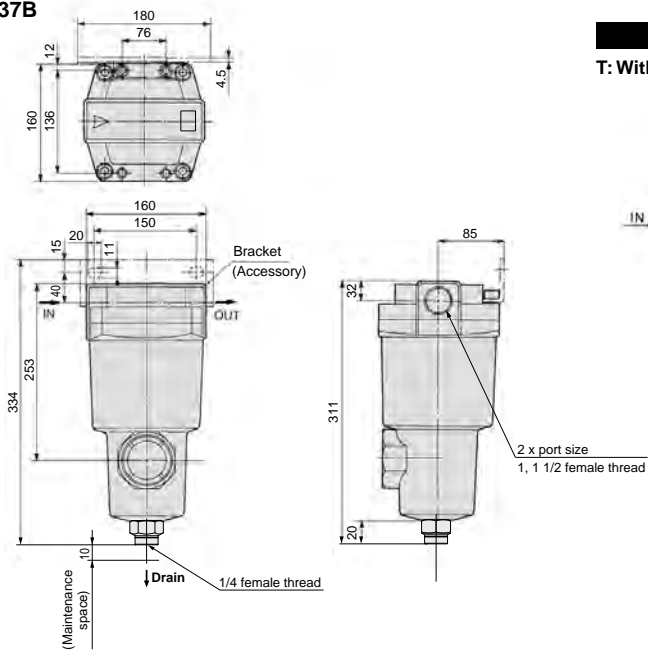

Option

T: With element service indicator

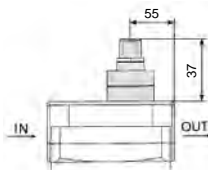

10-AFF75B

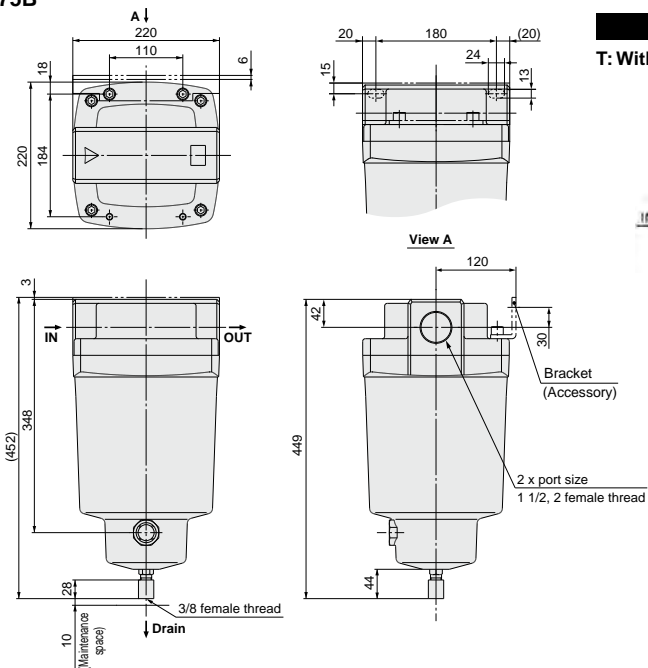

Option

T: With element service indicator

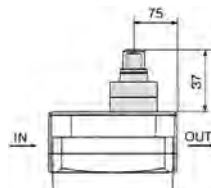

Series 10-AM Mist Separator

RoHS

Can remove oil mist in compressed air and remove particles such as rust or carbon of more than 0.3 μm.

Modular connection is possible with 10-AM150C to 550C. (For details, refer to page 1001.)



10-AM150C to 550C

10-AM650/850

Model

Model	10-AM150C	10-AM250C	10-AM350C	10-AM450C	10-AM550C	10-AM650	10-AM850
Rated flow (L/min [ANR]) ^{Note)}	300	750	1500	2200	3700	6000	12000
Port size	1/6, 1/4	1/4, 3/8	3/8, 1/2	1/2, 3/4	3/4, 1	1, 1 1/2	1 1/2, 2
Weight (kg)	0.38	0.55	0.9	1.4	2.1	4.2	10.5

Note) Maximum flow capacity at 0.7 MPa.

Maximum flow capacity varies depending on the operating pressure.

Refer to Flow Rate Characteristics (page 969) and Max. Flow Capacity Line (page 970).

Specifications

Fluid	Compressed air
Max. operating pressure	1.0 MPa
Min. operating pressure	0.05 MPa
Proof pressure	1.5 MPa
Ambient and fluid temperature	5 to 60°C
Nominal filtration rating	0.3 μm (Filtration efficiency: 99.9%)
Oil mist density at outlet	Max. 1.0 mg/m ³ [ANR] (≈0.8 ppm) ^{*1}
Element replacement period	2 years or when pressure drop reached 0.1 MPa
Cleanliness class (ISO class)	Class 3

*1 Oil mist density at 30 mg/m³ [ANR] blown out by compressor.

Accessory

Applicable model	10-AM150C	10-AM250C	10-AM350C	10-AM450C	10-AM550C	10-AM650	10-AM850
Bracket assembly (with 2 mounting screws)	10-AM-BM101	10-AM-BM102	10-AM-BM103	10-AM-BM104	10-AM-BM105	10-BM56	10-BM57

⚠ Caution

Be sure to read this before handling.
Refer to page 1382 for Safety Instructions and pages 1064 to 1066 for Air Preparation Equipment Precautions.

How to Order



10-AM150C to 550C

10-AM 550C - [] **10** [] - **J** []

Clean series ↓

Body size ↓

150C
250C
350C
450C
550C

Thread type ↓

Symbol	Type
Nil	Rc
F	G
N	NPT

Port size ↓

Symbol	Size	Applicable body size				
		150C	250C	350C	450C	550C
01	1/8	●				
02	1/4	●	●			
03	3/8		●	●		
04	1/2			●	●	
06	3/4				●	●
10	1					●

• Option

Symbol	Description
Nil	—
F	Rubber material: Fluororubber*3
H	For medium air pressure (1.6 MPa)*3
R	IN-OUT reversal direction
T	Element service indicator*3

*3 Combination of T and F or H is not available.

• Drain guide*2 1/4 female thread

*2 Drain piping and piping for a stop valve such as ball valve are required.

• Accessory

Symbol	Description
Nil	—
B	Bracket *1

*1 Bracket is included (but not assembled).

Options

Symbol F: Rubber material: Fluororubber

Fluororubber is used for the parts such as O-ring and gasket.

Symbol H: For medium air pressure (1.6 MPa)

Can be used up to 1.6 MPa at maximum.

Symbol R: IN-OUT reversal direction

Air flow direction is changed to right to left.
(Air flow direction of the standard: Left to right.)

Symbol T: With element service indicator

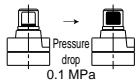

Saturation of the element can be observed visually.



How to Order

10-AM650/850

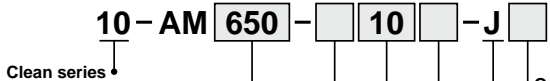

Body size •

650
850

Thread type •

Symbol	Type
NII	Rc
F	G
N	NPT

Port size •

Symbol	Size	Applicable body size	
		650	850
10	1	●	—
14	1½	●	●
20	2	—	●

Option

Symbol	Description
Nil	—
R	IN-OUT reversal direction
T	With element service indicator

• **Drain guide** *2 1/4 female thread (10-AM650),
3/8 female thread (10-AM850)

*2 Drain piping and piping for a stop valve such as ball valve are required.

Accessory

Symbol	Description
NII	—
B	Bracket *1

*1 Bracket is included (but not assembled).

Directional Control Valves

Air Cylinders

Rotary Actuators

Air Grippers

Air Preparation Equipment

Modular F. R.

Pressure Control Equipment

Fittings & Tubing

Flow Control Equipment

Pressure Switches/ Pressure Sensors

Flow Rate Characteristics/Select the model under the max. flow capacity line. (Element oil saturation)

Note) Compressed air over max. flow capacity line in the table below may not meet the specifications of the product.

10-AM150C

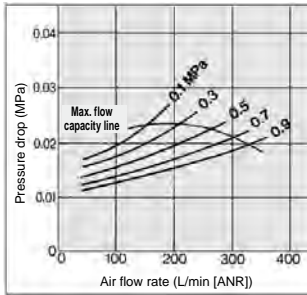

10-AM450C

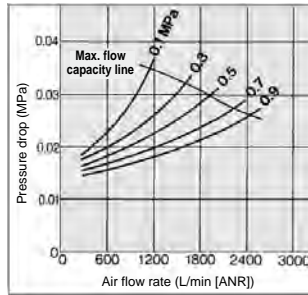

10-AM850

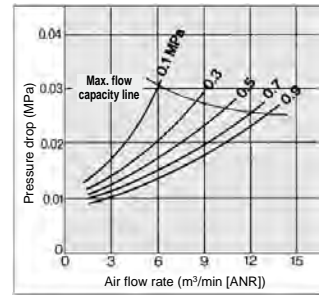

10-AM250C

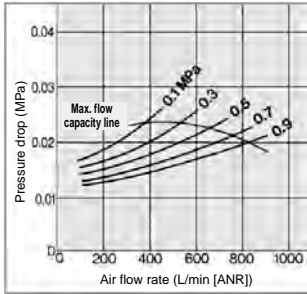

10-AM550C

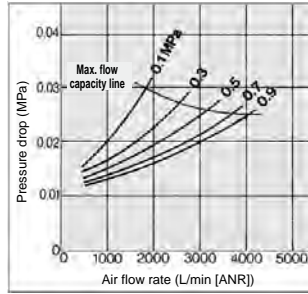

10-AM350C

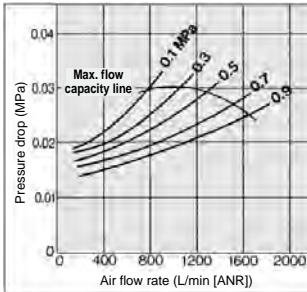

10-AM650

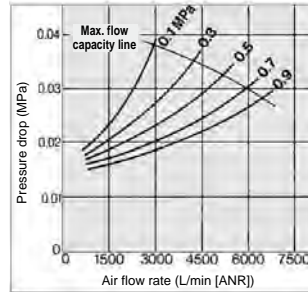

Construction

10-AM150C to 550C, 10-AM650

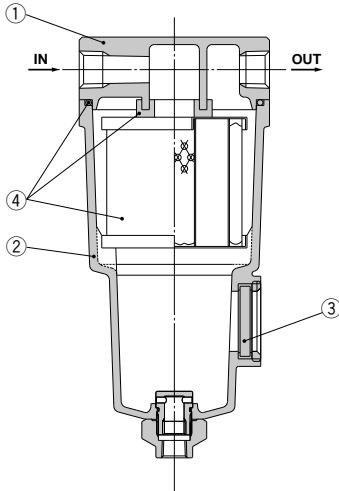

10-AM850

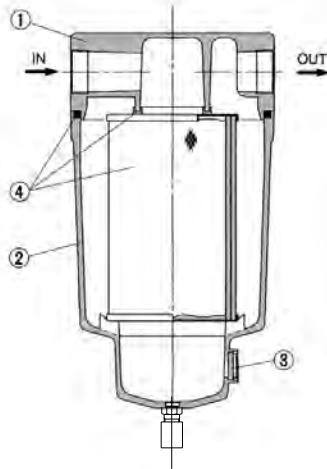

Component Parts

No.	Description	Material	Note
1	Body	Aluminum die-casted	Inner/outer surface coating
2	Housing	Aluminum die-casted*	Inner/outer surface coating
3	Sight glass	Tempered glass	—

* The 10-AM850 is aluminum casted.

Note) Sight glass is indicated in the figure for easy understanding of component parts. However, it differs from the actual construction. Refer to Dimensions on pages 971 to 972 for details.

Replacement Parts

No.	Description	Material	Applicable model	Model						
				10-AM150C	10-AM250C	10-AM350C	10-AM450C	10-AM550C	10-AM650	10-AM850
4	Element assembly	Glass fiber, others	Except option F For option F	10-AM-EL150	10-AM-EL250	10-AM-EL350	10-AM-EL450	10-AM-EL550	10-AM-EL650	10-AM-EL850

- Element assembly: With gasket (1 pc.) and O-ring (1 pc.)
- Refer to How to Order Bowl Assembly on page 1002.

Max. Flow Capacity Line

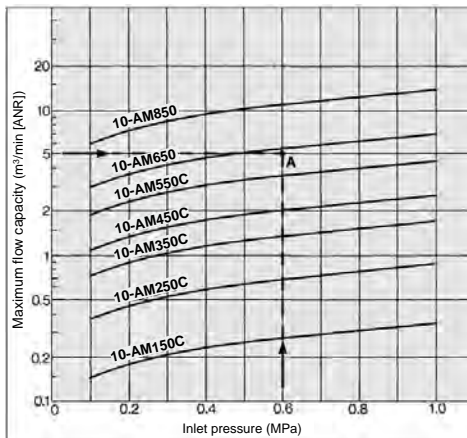

Model Selection

Select a model in accordance with the following procedure taking the inlet pressure and the maximum flow capacity into consideration.
(Example) Inlet pressure: 0.6 MPa

Maximum flow capacity: 5 m³/min [ANR]

1. Obtain the intersecting point A of inlet pressure and maximum flow capacity in the graph.
2. The 10-AM650 is obtained when the max. flow capacity line is above the intersecting point A in the graph.

Note) Make sure to select a model that has the max. flow capacity line above the obtained intersecting point. With a model that has the max. flow capacity line below the obtained intersecting point, the flow rate will be exceeded, thus leading to a problem such as being unable to satisfy the specifications.

Directional Control Valves
Air Cylinders
Rotary Actuators
Air Grippers
Air Preparation Equipment
Modular F. R.
Pressure Control Equipment
Fittings & Tubing
Flow Control Equipment
Pressure Switches/Pressure Sensors

Dimensions

10-AM150C to 550C

Option

T: With element service indicator

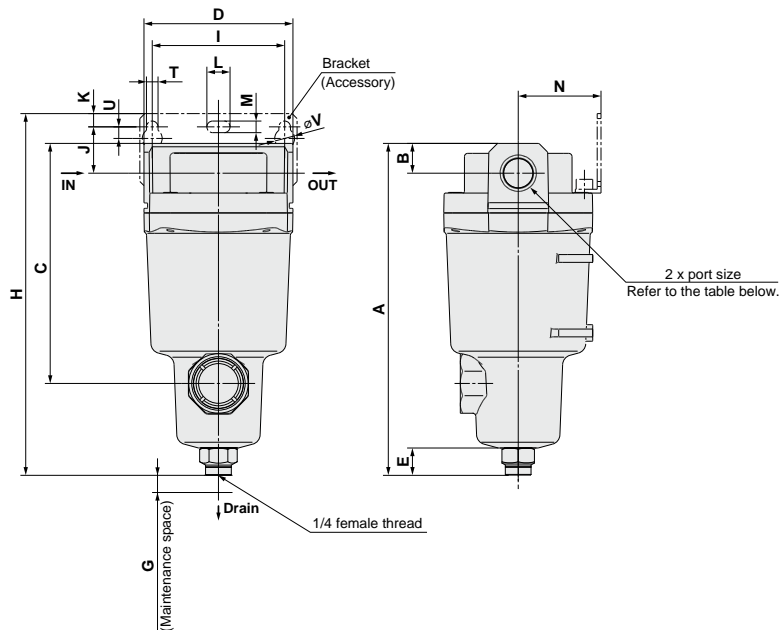
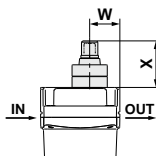
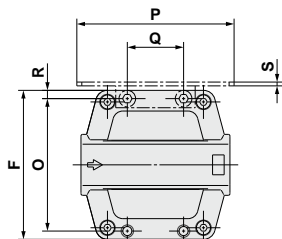

Model	Port size	A	B	C	D	E	F	G	Bracket related dimensions											Element service indicator related dimensions					
									H	I	J	K	T	U	L	M	V	N	O	P	Q	R	S	W	X
10-AM150C	1/8, 1/4	158	10	99	63	20	63	10	173	56	20	5	6	6	12	6	10	35	54	70	26	4.5	1.6	24	37
10-AM250C	1/4, 3/8	172	14	113	76	20	76	10	190	66	24	8	6	6	12	6	10	40	66	80	28	5	2	27	37
10-AM350C	3/8, 1/2	204	18	145	90	20	90	10	222	80	28	8	7	7	14	7	12	50	80	95	34	5	2.3	32	37
10-AM450C	1/2, 3/4	225	20	166	106	20	106	10	246	90	31	10	9	9	18	9	15	55	88	111	50	9	3.2	37	37
10-AM550C	3/4, 1	259	24	200	122	20	122	15	278	100	33	10	9	9	18	9	15	65	102	126	60	10	3.2	39	37

Dimensions

10-AM650

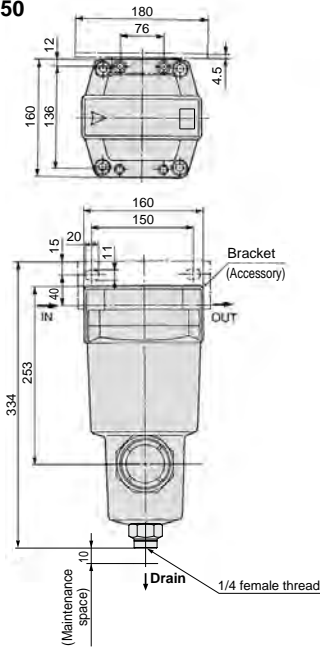

Option
T: With element service indicator

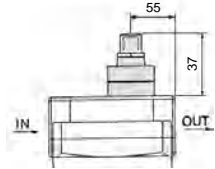

10-AM850

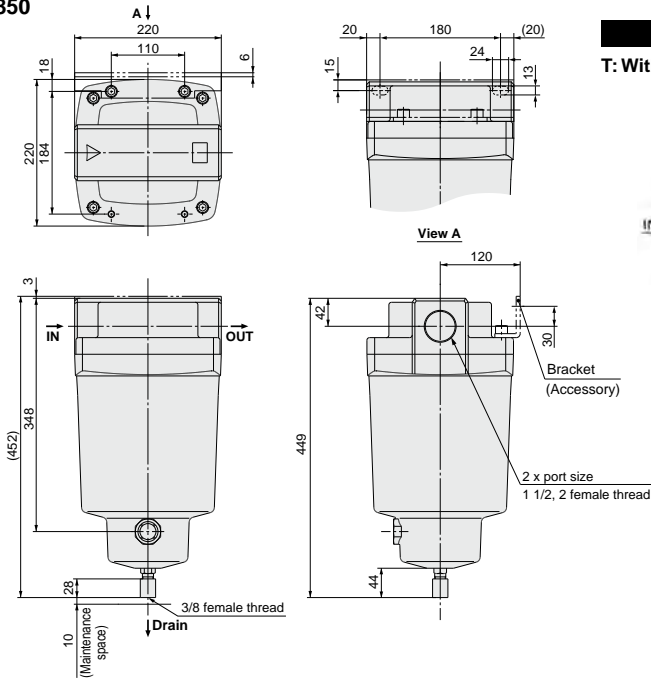

Option
T: With element service indicator

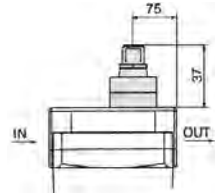

Directional Control Valves
Air Cylinders
Rotary Actuators
Air Grippers
Air Preparation Equipment
Modular F. R.
Pressure Control Equipment
Fittings & Tubing
Flow Control Equipment
Pressure Switches/ Pressure Sensors

Series 10-AMD

Micro Mist Separator

RoHS

Can separate and remove aerosol state oil mist in compressed air and remove particles such as carbon or dust of more than 0.01 μm .

Use this product as a pre-filter for compressed air for precision instruments or clean room requiring higher clean air.

Modular connection is possible with 10-AMD150C to 550C. (For details, refer to page 1001.)



10-AMD150C to 550C 10-AMD650/850

Model

Model	10-AMD150C	10-AMD250C	10-AMD350C	10-AMD450C	10-AMD550C	10-AMD650	10-AMD850
Rated flow (L/min [ANR]) <small>Note)</small>	200	500	1000	2000	3700	6000	12000
Port size	1/8, 1/4	1/4, 3/8	3/8, 1/2	1/2, 3/4	3/4, 1	1, 1 1/2	1 1/2, 2
Weight (kg)	0.38	0.55	0.9	1.4	2.1	4.2	10.5

Note) Maximum flow capacity at 0.7 MPa.

Maximum flow capacity varies depending on the operating pressure.

Refer to Flow Rate Characteristics (page 976) and Max. Flow Capacity Line (page 975).

Specifications

Fluid	Compressed air
Max. operating pressure	1.0 MPa
Min. operating pressure*	0.05 MPa
Proof pressure	1.5 MPa
Ambient and fluid temperature	5 to 60°C
Nominal filtration rating	0.01 μm (Filtration efficiency: 99.9%)
Oil mist density at outlet	Max. 0.1 mg/m ³ [ANR] ^{*1} (Before saturated with oil, less than 0.01 mg/m ³ [ANR] =0.008 ppm)
Element replacement period	2 years or when pressure drop reached 0.1 MPa
Cleanliness class (ISO class)	Class 3

* Oil mist density at 30 mg/m³ [ANR] blown out by compressor.

Accessory

Applicable model	10-AMD150C	10-AMD250C	10-AMD350C	10-AMD450C	10-AMD550C	10-AMD650	10-AMD850
Bracket assembly (with 2 mounting screws)	10-AM-BM101	10-AM-BM102	10-AM-BM103	10-AM-BM104	10-AM-BM105	10-BM56	10-BM57

⚠ Caution

Be sure to read this before handling.
Refer to page 1382 for Safety Instructions and pages 1064 to 1066 for Air Preparation Equipment Precautions.



How to Order

10-AMD150C to 550C

10-AMD 550C - 10 - J

Clean series

Body size

150C
250C
350C
450C
550C

Thread type

Symbol	Type
Nll	Rc
F	G
N	NPT

Port size

Symbol	Size	Applicable body size				
		150C	250C	350C	450C	550C
01	1/8	●				
02	1/4	●	●			
03	3/8		●			
04	1/2			●	●	
06	3/4				●	●
10	1					●

Option

Symbol	Description
Nll	—
F	Rubber material: Fluororubber*3
H	For medium air pressure (1.6 MPa)
R	IN-OUT reversal direction*3
T	With element service indicator*3

*3 Combination of T and F or H is not available.

Drain guide*2 1/4 female thread

*2 Drain piping and piping for a stop valve such as ball valve are required.

Accessory

Symbol	Description
Nll	—
B	Bracket *1

*1 Bracket is included (but not assembled).

Options

Symbol F: Rubber material: Fluororubber

Fluororubber is used for the parts such as O-ring and gasket.

Symbol H: For medium air pressure (1.6 MPa)

Can be used up to 1.6 MPa at maximum.

Symbol R: IN-OUT reversal direction

Air flow direction is changed to right to left.
(Air flow direction of the standard: Left to right.)

Symbol T: With element service indicator

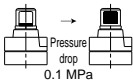

Saturation of the element can be observed visually.

Directional Control Valves

Air Cylinders

Rotary Actuators

Air Grippers

Air Preparation Equipment

Modular F. R.

Pressure Control Equipment

Fittings & Tubing

Flow Control Equipment

Pressure Switches/ Pressure Sensors

How to Order



10-AMD650/850

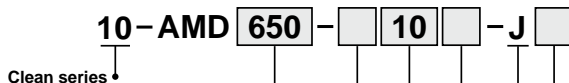

Clean series

Body size

650
850

Thread type

Symbol	Type
Nll	Rc
F	G
N	NPT

Port size

Symbol	Size	Applicable body size	
		650	850
10	1	●	—
14	1 1/2	●	●
20	2	—	●

Option

Symbol	Description
Nll	—
R	IN-OUT reversal direction
T	With element service indicator

Drain guide *2 1/4 female thread (10-AMD650),
3/8 female thread (10-AMD850)

*2 Drain piping and piping for a stop valve such as ball valve are required.

Accessory

Symbol	Description
Nll	—
B	Bracket *1

*1 Bracket is included (but not assembled).

Model Selection

Select a model in accordance with the following procedure taking the inlet pressure and the maximum flow capacity into consideration.

(Example) Inlet pressure: 0.6 MPa

Maximum flow capacity: 5 m³/min [ANR]

1. Obtain the intersecting point A of inlet pressure and maximum flow capacity in the graph.
2. The 10-AMD650 is obtained when the max. flow capacity line is above the intersecting point A in the graph.

Note) Make sure to select a model that has the max. flow capacity line above the obtained intersecting point. With a model that has the max. flow capacity line below the obtained intersecting point, the flow rate will be exceeded, thus leading to a problem such as being unable to satisfy the specifications.

Max. Flow Capacity Line

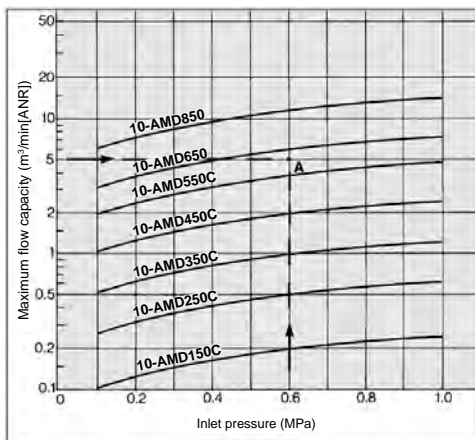

Flow Rate Characteristics Select the model under the max. flow capacity line. (— Element oil saturation ----- Initial condition)

Note) Compressed air over max. flow capacity line in the table below may not meet the specifications of the product.

10-AMD150C

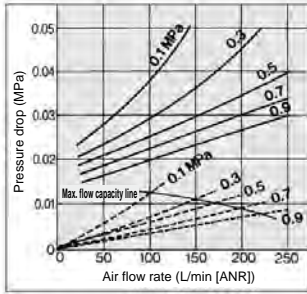

10-AMD450C

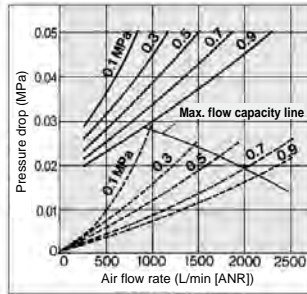

10-AMD850

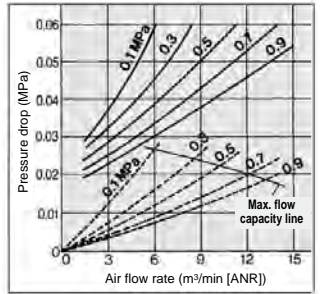

10-AMD250C

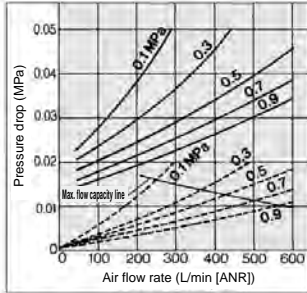

10-AMD550C

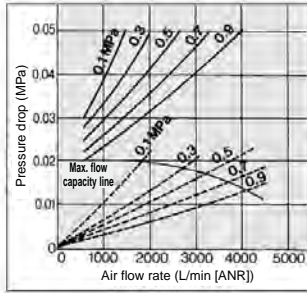

10-AMD350C

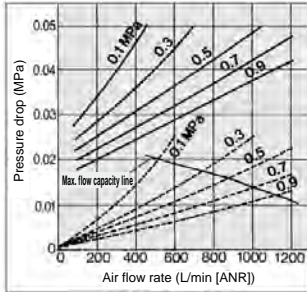

10-AMD650

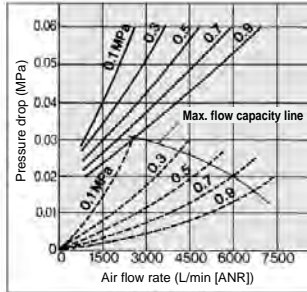

- Directional Control Valves
- Air Cylinders
- Rotary Actuators
- Air Grippers
- Air Preparation Equipment
- Modular F. R.
- Pressure Control Equipment
- Fittings & Tubing
- Flow Control Equipment
- Pressure Switches/ Pressure Sensors

Construction

10-AMD150C to 550C, 10-AMD650

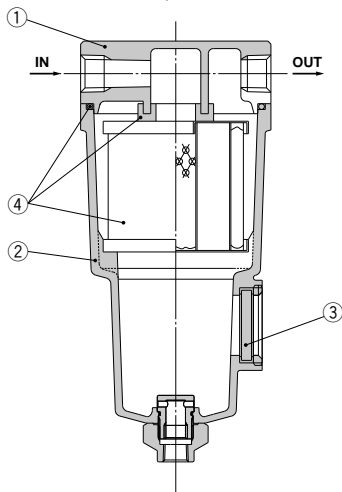

10-AMD850

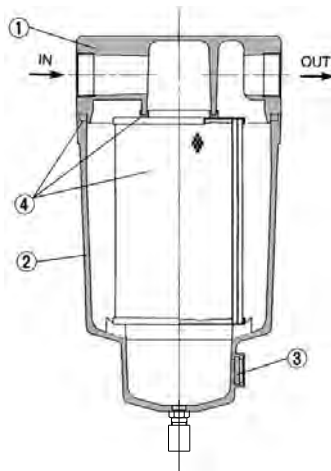

Component Parts

No.	Description	Material	Note
1	Body	Aluminum die-casted	Inner/outer surface coating
2	Housing	Aluminum die-casted*	—
3	Sight glass	Tempered glass	—

* The 10-AMD850 is aluminum casted.

Note) Sight glass is indicated in the figure for easy understanding of component parts. However, it differs from the actual construction. Refer to Dimensions on pages 978 to 979 for details.

Replacement Parts

No.	Description	Material	Applicable model	Model						
				10-AMD150C	10-AMD250C	10-AMD350C	10-AMD450C	10-AMD550C	10-AMD650	10-AMD850
4	Element assembly	Glass fiber, others	Except option F For option F	10-AMD-EL150	10-AMD-EL250	10-AMD-EL350	10-AMD-EL450	10-AMD-EL550	10-AMD-EL650	10-AMD-EL850
				10-AMD-EL150-F	10-AMD-EL250-F	10-AMD-EL350-F	10-AMD-EL450-F	10-AMD-EL550-F	—	—

- Element assembly: With gasket (1 pc.) and O-ring (1 pc.)
- Refer to How to Order Bowl Assembly on page 1002.

Dimensions

10-AMD150C to 550C

Option

T: With element service indicator

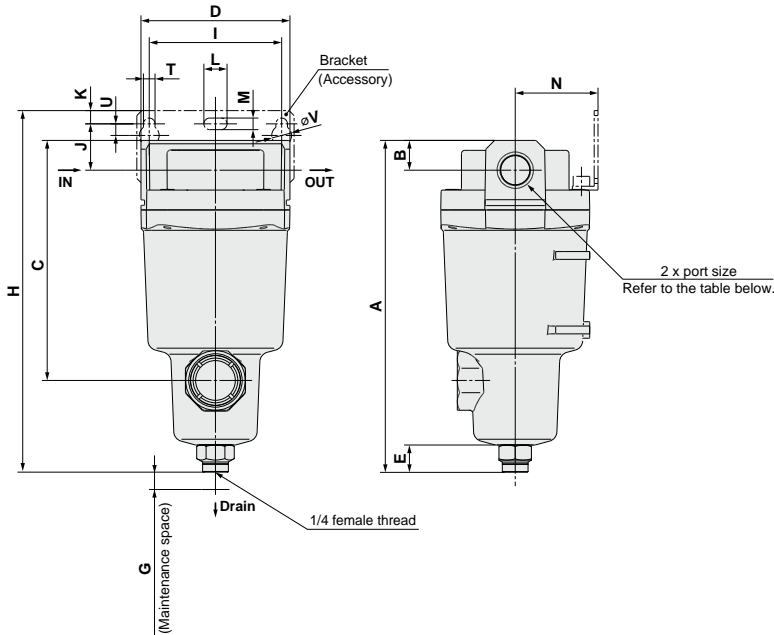
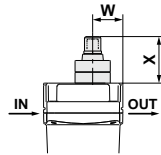
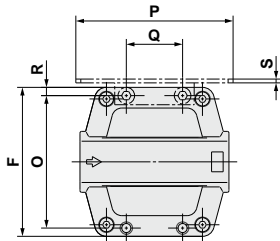

Model	Port size	A	B	C	D	E	F	G	Bracket related dimensions											Element service indicator related dimensions					
									H	I	J	K	T	U	L	M	V	N	O	P	Q	R	S	W	X
									10-AMD150C	1/8, 1/4	158	10	99	63	20	63	10	173	56	20	5	6	6	12	6
10-AMD250C	1/4, 3/8	172	14	113	76	20	76	10	190	66	24	8	6	6	12	6	10	40	66	80	28	5	2	27	37
10-AMD350C	3/8, 1/2	204	18	145	90	20	90	10	222	80	28	8	7	7	14	7	12	50	80	95	34	5	2.3	32	37
10-AMD450C	1/2, 3/4	225	20	166	106	20	106	10	246	90	31	10	9	9	18	9	15	55	88	111	50	9	3.2	37	37
10-AMD550C	3/4, 1	259	24	200	122	20	122	15	278	100	33	10	9	9	18	9	15	65	102	126	60	10	3.2	39	37

Directional Control Valves
Air Cylinders
Rotary Actuators
Air Grippers
Air Preparation Equipment
Modular F. R.
Pressure Control Equipment
Fittings & Tubing
Flow Control Equipment
Pressure Switches/Pressure Sensors

Dimensions

10-AMD650

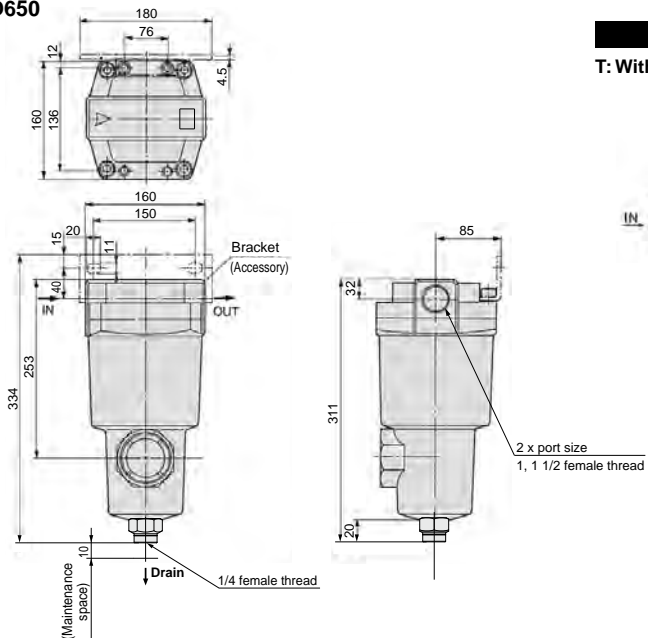

Option

T: With element service indicator

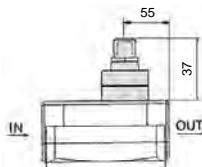

10-AMD850

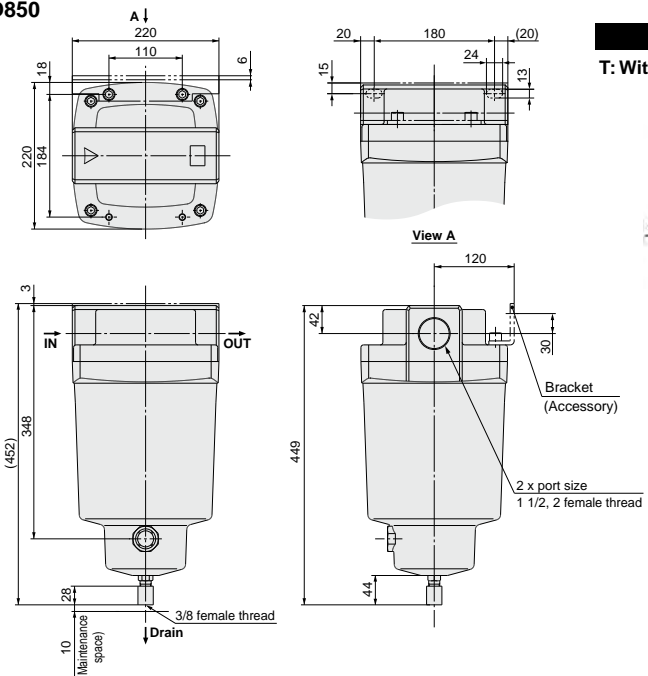

Option

T: With element service indicator

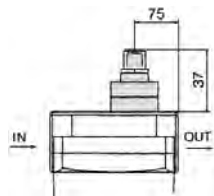

Series 10-AMH

Micro Mist Separator
with Pre-filter

RoHS

Can separate and remove aerosol state oil mist in compressed air and remove particles such as carbon or dust of more than 0.01 μm .

Use this product as a pre-filter for compressed air for precision instruments or clean room requiring higher clean air.

The conventional pneumatic pressure line, 10-AM series + 10-AMD series have been integrated to achieve a reduction in installation space and in piping labor.

Modular connection is possible with 10-AMH150C to 550C.
(For details, refer to page 1001.)



10-AMH150C to 550C 10-AMH650/850

Model

Model	10-AMH150C	10-AMH250C	10-AMH350C	10-AMH450C	10-AMH550C	10-AMH650	10-AMH850
Rated flow (L/min [ANR]) ^{Note)}	200	500	1000	2000	3700	6000	12000
Port size	1/8, 1/4	1/4, 3/8	3/8, 1/2	1/2, 3/4	3/4, 1	1, 1 1/2	1 1/2, 2
Weight (kg)	0.38	0.55	0.9	1.4	2.1	4.2	10.5

Note) Maximum flow capacity at 0.7 MPa.

Maximum flow capacity varies depending on the operating pressure.

Refer to Flow Rate Characteristics (page 983) and Max. Flow Capacity Line below.

Specifications

Fluid	Compressed air
Max. operating pressure	1.0 MPa
Min. operating pressure*	0.05 MPa
Proof pressure	1.5 MPa
Ambient and fluid temperature	5 to 60°C
Nominal filtration density	0.01 μm (Filtration efficiency: 99.9%)
Oil mist density at outlet	Max. 0.1 mg/m^3 [ANR] ^{†)} (Before saturated with oil, less than 0.01 mg/m^3 [ANR] = 0.008 ppm)
Element replacement period	2 years or when pressure drop reached 0.1 MPa
Cleanliness class (ISO class)	Class 3

* Oil mist density at 30 mg/m^3 [ANR] blown out by compressor.

Accessory

Applicable model	10-AMH150C	10-AMH250C	10-AMH350C	10-AMH450C	10-AMH550C	10-AMH650	10-AMH850
Bracket assembly (with 2 mounting screws)	10-AM-BM101	10-AM-BM102	10-AM-BM103	10-AM-BM104	10-AM-BM105	10-BM56	10-BM57

Model Selection

Select a model in accordance with the following procedure taking the inlet pressure and the maximum flow capacity into consideration.

(Example) Inlet pressure: 0.6 MPa

Maximum flow capacity: 5 m^3/min [ANR]

1. Obtain the intersecting point A of inlet pressure and maximum flow capacity in the graph.
2. The 10-AMH650 is obtained when the max. flow capacity line is above the intersecting point A in the graph.

Note) Make sure to select a model that has the max. flow capacity line above the obtained intersecting point. With a model that has the max. flow capacity line below the obtained intersecting point, the flow rate will be exceeded, thus leading to a problem such as being unable to satisfy the specifications.

Max. Flow Capacity Line

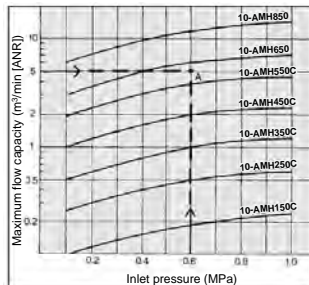

⚠ Caution

Be sure to read this before handling.
Refer to page 1382 for Safety Instructions and pages 1064 to 1066 for Air Preparation Equipment Precautions.

Directional Control Valves

Air Cylinders

Rotary Actuators

Air Grippers

Air Preparation Equipment

Modular F. R.

Pressure Control Equipment

Fittings & Tubing

Flow Control Equipment

Pressure Switches/ Pressure Sensors

How to Order



10-AMH150C to 550C



Clean series

Body size

150C
250C
350C
450C
550C

Thread type

Symbol	Type
Nil	Rc
F	G
N	NPT

Option

Symbol	Description
Nil	—
F	Rubber material: Fluororubber*3
H	For medium air pressure (1.6 MPa)*3
R	IN-OUT reversal direction
T	With element service indicator*3

*3 Combination of T and F or H is not available.

Drain guide*2 1/4 female thread

*2 Drain piping and piping for a stop valve such as ball valve are required.

Accessory

Symbol	Description
Nil	—
B	Bracket *1

*1 Bracket is included (but not assembled).

Port size

Symbol	Size	Applicable body size				
		150C	250C	350C	450C	550C
01	1/8	●				
02	1/4	●				
03	3/8		●		●	
04	1/2				●	●
06	3/4					●
10	1					●

Options

Symbol F: Rubber material: Fluororubber

Fluororubber is used for the parts such as O-ring and gasket.

Symbol H: For medium air pressure (1.6 MPa)

Can be used up to 1.6 MPa at maximum.

Symbol R: IN-OUT reversal direction

Air flow direction is changed to right to left.
(Air flow direction of the standard: Left to right.)

Symbol T: With element service indicator

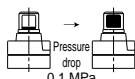

Saturation of the element can be observed visually.



How to Order

10-AMH650/850

10-AMH 650 - 10 - J

Clean series

Body size

650
850

Thread type

Symbol	Type
N il	Rc
F	G
N	NPT

Port size

Symbol	Size	Applicable body size	
		650	850
10	1	●	—
14	1½	●	●
20	2	—	●

Option

Symbol	Description
N il	—
R	IN-OUT reversal direction
T	With element service indicator

Drain guide *2 1/4 female thread (10-AMH650), 3/8 female thread (10-AMH850)

*2 Drain piping and piping for a stop valve such as ball valve are required.

Accessory

Symbol	Description
N il	—
B	Bracket *1

*1 Bracket is included (but not assembled).

Directional Control Valves

Air Cylinders

Rotary Actuators

Air Grippers

Air Preparation Equipment

Modular F. R.

Pressure Control Equipment

Fittings & Tubing

Flow Control Equipment

Pressure Switches/ Pressure Sensors

Flow Rate CharacteristicsSelect the model under the max. flow capacity line. (— Element oil saturation ---- Initial condition)

Note) Compressed air over max. flow capacity line in the table below may not meet the specifications of the product.

10-AMH150C

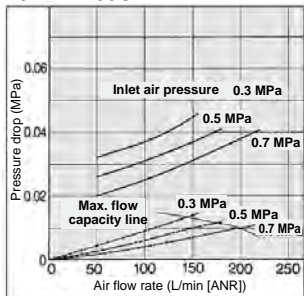

10-AMH450C

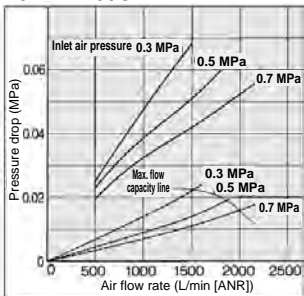

10-AMH850

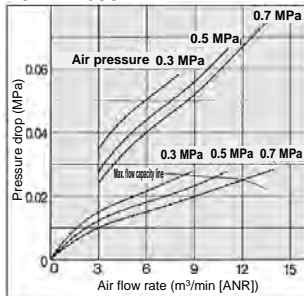

10-AMH250C

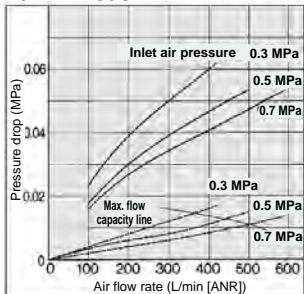

10-AMH550C

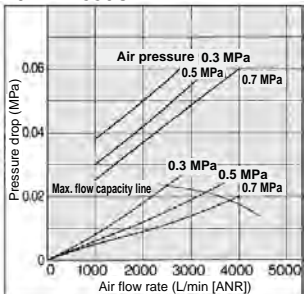

10-AMH350C

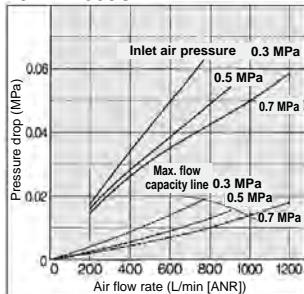

10-AMH650

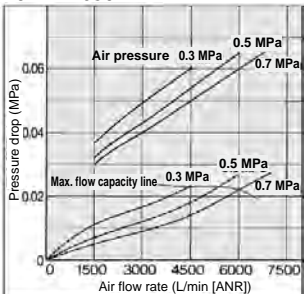

Construction

10-AMH150C to 550C, 10-AMH650

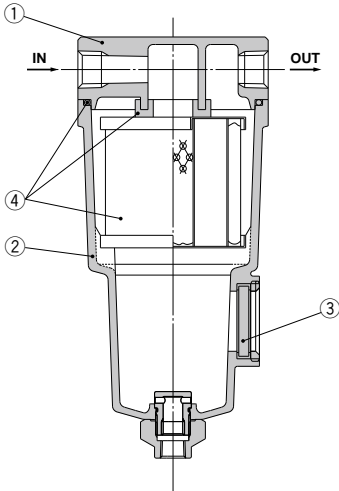

10-AMH850

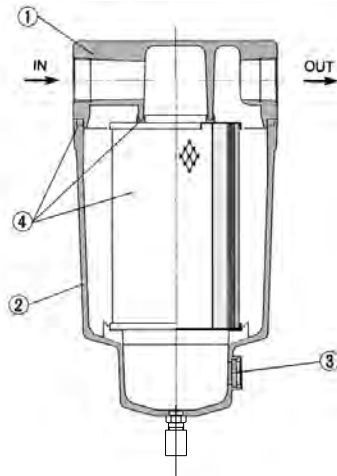

Component Parts

No.	Description	Material	Note
1	Body	Aluminum die-casted	Inner/outer surface coating
2	Housing	Aluminum die-casted*	
3	Sight glass	Tempered glass	—

* The 10-AMH850 is aluminum casted.

Note) Sight glass is indicated in the figure for easy understanding of component parts. However, it differs from the actual construction. Refer to Dimensions on pages 985 to 986 for details.

Replacement Parts

No.	Description	Material	Applicable model	Model						
				10-AMH150C	10-AMH250C	10-AMH350C	10-AMH450C	10-AMH550C	10-AMH650	10-AMH850
4	Element assembly	Glass fiber, others	Except option F For option F	10-AMH-EL150	10-AMH-EL250	10-AMH-EL350	10-AMH-EL450	10-AMH-EL550	10-AMH-EL650	10-AMH-EL850
				10-AMH-EL150-F	10-AMH-EL250-F	10-AMH-EL350-F	10-AMH-EL450-F	10-AMH-EL550-F	—	—

- Element assembly: With gasket (1 pc.) and O-ring (1 pc.)
- Refer to How to Order Bowl Assembly on page 1002.

Directional Control Valves
Air Cylinders
Rotary Actuators
Air Grippers
Air Preparation Equipment
Modular F. R.
Pressure Control Equipment
Fittings & Tubing
Flow Control Equipment
Pressure Switches/ Pressure Sensors

Dimensions

10-AMH150C to 550C

Option

T: With element service indicator

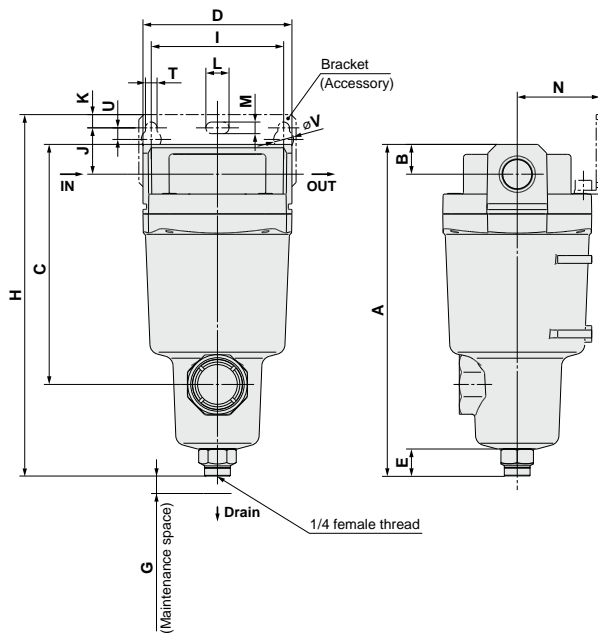
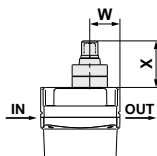
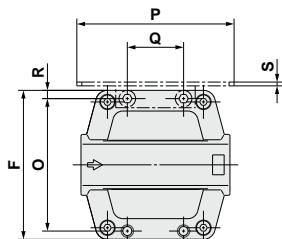

Model	Port size	A	B	C	D	E	F	G	Bracket related dimensions											Element service indicator related dimensions					
									H	I	J	K	T	U	L	M	V	N	O	P	Q	R	S	W	X
									10-AMH150C	1/8, 1/4	158	10	99	63	20	63	10	173	56	20	5	6	6	12	6
10-AMH250C	1/4, 3/8	172	14	113	76	20	76	10	190	66	24	8	6	6	12	6	10	40	66	80	28	5	2	27	37
10-AMH350C	3/8, 1/2	204	18	145	90	20	90	10	222	80	28	8	7	7	14	7	12	50	80	95	34	5	2.3	32	37
10-AMH450C	1/2, 3/4	225	20	166	106	20	106	10	246	90	31	10	9	9	18	9	15	55	88	111	50	9	3.2	37	37
10-AMH550C	3/4, 1	259	24	200	122	20	122	15	278	100	33	10	9	9	18	9	15	65	102	126	60	10	3.2	39	37

Dimensions

10-AMH650

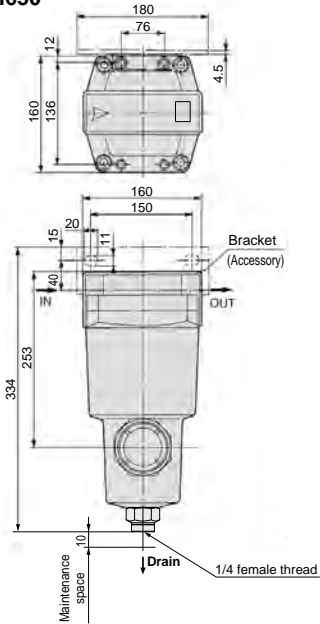

Option
T: With element service indicator

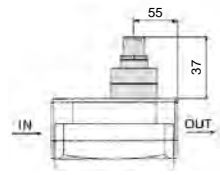

10-AMH850

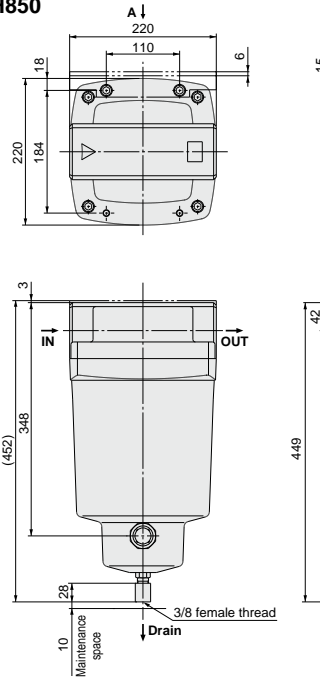

Option
T: With element service indicator

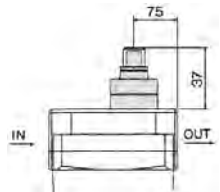

Directional Control Valves
Air Cylinders
Rotary Actuators
Air Grippers
Air Preparation Equipment
Modular F. R.
Pressure Control Equipment
Fittings & Tubing
Flow Control Equipment
Pressure Switches/ Pressure Sensors

Series 10-AME

Super Mist Separator

RoHS

Can separate and adsorb aerosol state fine oil particles in compressed air and change the oil lubricating compressed air to oilless air or equivalent.

Use this product for filtration of compressed air requiring higher clean air for painting lines, compressed air for clean rooms and/or equipment where oils must be avoided.

Indicates the replacement time of the filter element by a color change. Accordingly, the replacement time can be judged visually. (A red color spot indicates the replacement time.)

⚠ Caution

By all means the AM series should be used as a pre-filter.

Modular connection is possible with 10-AME150C to 550C. (For details, refer to page 1001.)



10-AME150C to 350C 10-AME450C/550C



10-AME650/850

Model

Model	10-AME150C	10-AME250C	10-AME350C	10-AME450C	10-AME550C	10-AME650	10-AME850
Rated flow (L/min [ANR])	200	500	1000	2000	3700	6000	12000
Port size	1/8, 1/4	1/4, 3/8	3/8, 1/2	1/2, 3/4	3/4, 1	1, 1 1/2	1 1/2, 2
Weight (kg)	0.3	0.48	0.8	1.3	2.0	4.2	10.5

Note) Maximum flow capacity at 0.7 MPa.

Maximum flow capacity varies depending on the operating pressure.

Refer to Flow Rate Characteristics (page 990) and Max. Flow Capacity Line (page 990).

Specifications

Fluid	Compressed air
Max. operating pressure	1.0 MPa
Min. operating pressure	0.05 MPa
Proof pressure	1.5 MPa
Ambient and fluid temperature	5 to 60°C
Nominal filtration rating	0.01 μm (Filtration efficiency: 99.9%)
Cleanliness at outlet	Less than 100 particles of 0.3 μm or larger per cubic foot [Less than 35 particles per 10 liters [ANR]]
Oil mist density at outlet	Max. 0.01 mg/m ³ [ANR] (=0.008 ppm)
Element replacement period	① Element color indicator (Replace the element when a red color spot occurred on the surface.) ② Even if a red color spot does not appear on the surface, the replacement interval for the element is when the pressure drop reaches 0.1 MPa or after two years of operation, whichever comes first.
Cleanliness class (ISO class)	Class 3

Accessory

Applicable model	10-AME150C	10-AME250C	10-AME350C	10-AME450C	10-AME550C	10-AME650	10-AME850
Bracket assembly (with 2 mounting screws)	10-AM-BM101	10-AM-BM102	10-AM-BM103	10-AM-BM104	10-AM-BM105	10-BM56	10-BM57

⚠ Caution

Be sure to read this before handling.
Refer to page 1382 for Safety Instructions and pages 1064 to 1066 for Air Preparation Equipment Precautions.



How to Order

10-AME150C to 550C

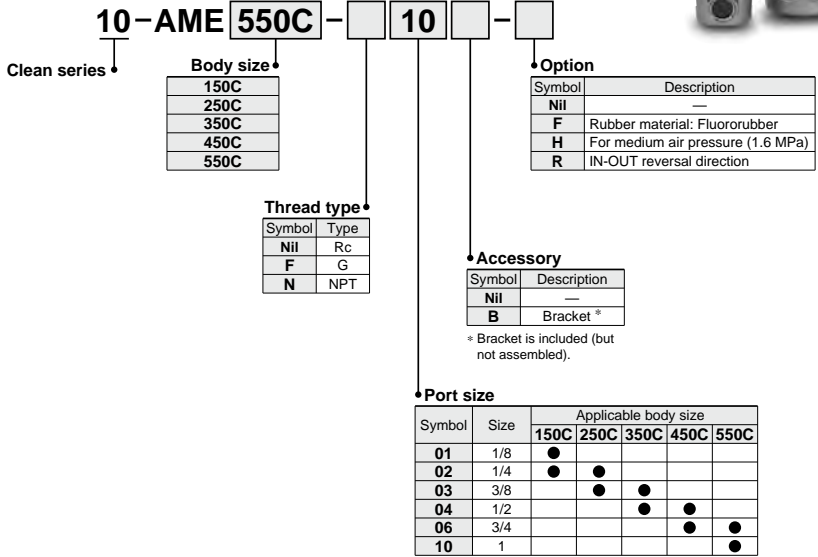

Options

Symbol F: Rubber material: Fluororubber

Fluororubber is used for the parts such as O-ring and gasket.

Symbol H: For medium air pressure (1.6 MPa)

Can be used up to 1.6 MPa at maximum.

Symbol R: IN-OUT reversal direction

Air flow direction is changed to right to left.
(Air flow direction of the standard: Left to right.)

- Directional Control Valves
- Air Cylinders
- Rotary Actuators
- Air Grippers
- Air Preparation Equipment
- Modular F. R.
- Pressure Control Equipment
- Fittings & Tubing
- Flow Control Equipment
- Pressure Switches/ Pressure Sensors

How to Order



10-AME650/850

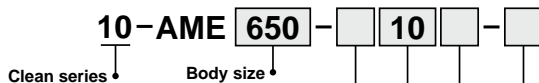

Clean series

Body size

650
850

Thread type

Symbol	Type
Nil	Rc
F	G
N	NPT

Port size

Symbol	Size	Applicable body size	
		650	850
10	1	●	—
14	1 1/2	●	●
20	2	—	●

Option

Symbol	Description
Nil	—
R	IN-OUT reversal direction

Accessory

Symbol	Description
Nil	—
B	Bracket*

* Bracket is included (but not assembled).

Flow Rate Characteristics/Select the model under the max. flow capacity line. (Element initial condition)

Note) Compressed air over max. flow capacity line in the table below may not meet the specifications of the product.

10-AME150C

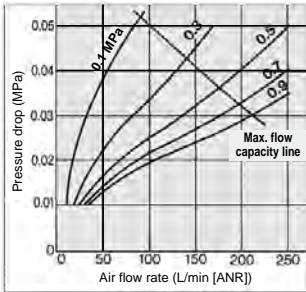

10-AME450C

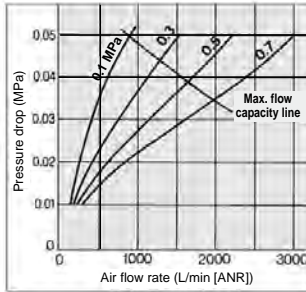

10-AME650

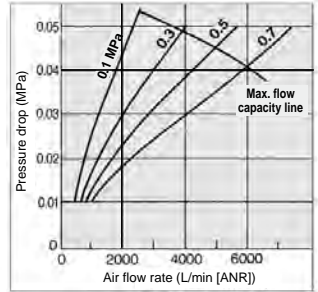

10-AME250C

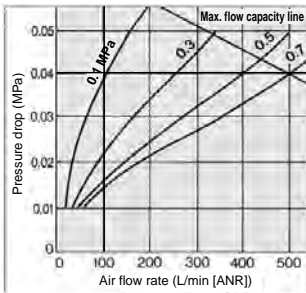

10-AME550C

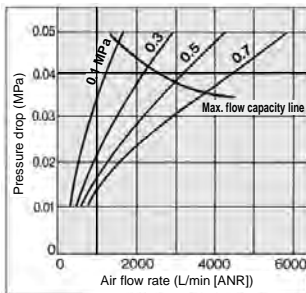

10-AME850

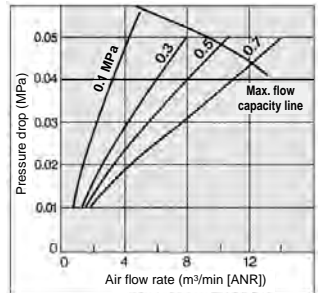

10-AME350C

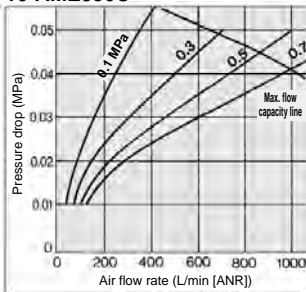

Model Selection

Select a model in accordance with the following procedure taking the inlet pressure and the maximum flow capacity into consideration.

(Example) Inlet pressure: 0.6 MPa

Maximum flow capacity: 5 m³/min [ANR]

1. Obtain the intersecting point A of inlet pressure and maximum flow capacity in the graph.
2. The 10-AME650 is obtained when the max. flow capacity line is above the intersecting point A in the graph.

Note) Make sure to select a model that has the max. flow capacity line above the obtained intersecting point. With a model that has the max. flow capacity line below the obtained intersecting point, the flow rate will be exceeded, thus leading to a problem such as being unable to satisfy the specifications.

Max. Flow Capacity Line

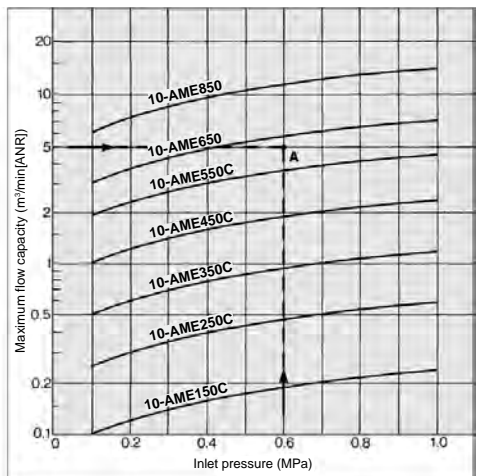

Directional Control Valves
Air Cylinders
Rotary Actuators
Air Grippers
Air Preparation Equipment
Modular F. R.
Pressure Control Equipment
Fittings & Tubing
Flow Control Equipment
Pressure Switches/ Pressure Sensors

Construction

10-AME150C to 550C

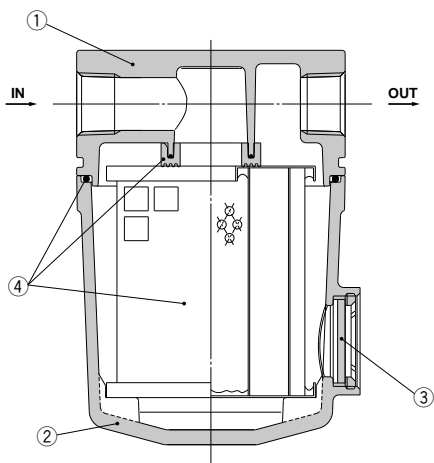

10-AME650/850

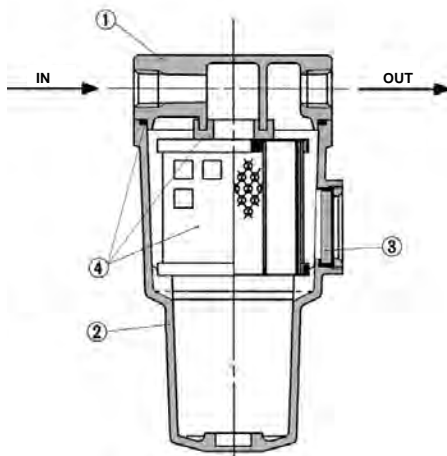

Component Parts

No.	Description	Material	Note
1	Body	Aluminum die-casted	Chrome treated
2	Housing	Aluminum die-casted*	Epoxy coating on inner surface
3	Sight glass	Tempered glass	—

* The 10-AME850 is aluminum casted.

Note) Sight glass is indicated in the figure for easy understanding of component parts. However, it differs from the actual construction. Refer to Dimensions on pages 992 to 993 for details.

Replacement Parts

No.	Description	Material	Applicable model	Model						
				10-AME150C	10-AME250C	10-AME350C	10-AME450C	10-AME550C	10-AME650	10-AME850
4	Element assembly	Glass fiber, others	Except option F For option F	10-AME-EL150	10-AME-EL250	10-AME-EL350	10-AME-EL450	10-AME-EL550	10-AME-EL650	10-AME-EL850
				10-AME-EL150-F	10-AME-EL250-F	10-AME-EL350-F	10-AME-EL450-F	10-AME-EL550-F	—	—

• Element assembly: With gasket (1 pc.) and O-ring (1 pc.)

• Refer to How to Order Bowl Assembly on page 1002.

Dimensions

10-AME150C to 350C

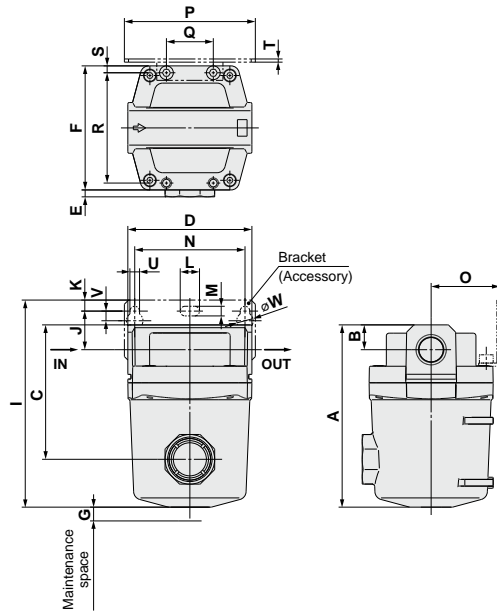

		(mm)						
Model	Port size	A	B	C	D	E	F	G
10-AME150C	1/8, 1/4	83	10	54	63	7.5	63	10
10-AME250C	1/4, 3/8	103	14	73	76	5	76	10
10-AME350C	3/8, 1/2	132	18	98	90	5	90	10

Model	Bracket related dimensions							
	I	N	J	K	U	V	L	M
10-AME150C	99	56	20	5	6	6	12	6
10-AME250C	121	66	24	8	6	6	12	6
10-AME350C	150	80	28	8	7	7	14	7

Model	Bracket related dimensions						
	W	O	P	Q	R	S	T
10-AME150C	10	35	70	26	54	4.5	1.6
10-AME250C	10	40	80	28	66	5	2
10-AME350C	12	50	95	34	80	5	2.3

10-AME450C/550C

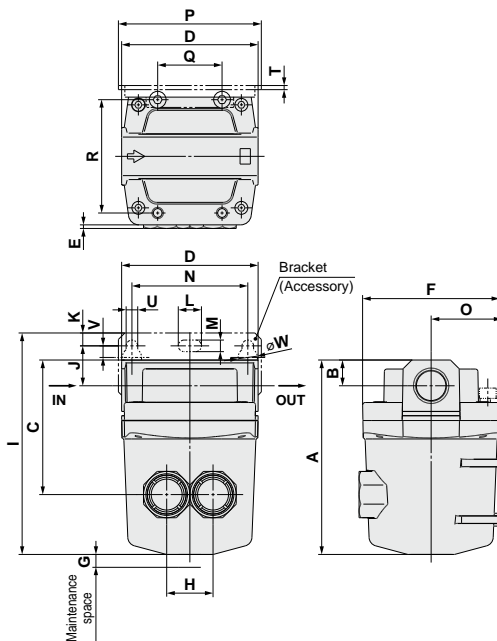

		(mm)							
Model	Port size	A	B	C	D	E	F	G	H
10-AME450C	1/2, 3/4	151	20	105	106	3	106	10	36
10-AME550C	3/4, 1	187	24	130	122	3	122	15	44

Model	Bracket related dimensions							
	I	N	J	K	U	V	L	M
10-AME450C	172	90	31	10	9	9	18	9
10-AME550C	206	100	33	10	9	9	18	9

Model	Bracket related dimensions					
	W	O	P	Q	R	T
10-AME450C	15	55	111	50	88	3.2
10-AME550C	15	65	126	60	102	3.2

Directional Control Valves
Air Cylinders
Rotary Actuators
Air Grippers
Air Preparation Equipment
Modular F. R.
Pressure Control Equipment
Fittings & Tubing
Flow Control Equipment
Pressure Switches/ Pressure Sensors

Dimensions

10-AME650/10-AME850

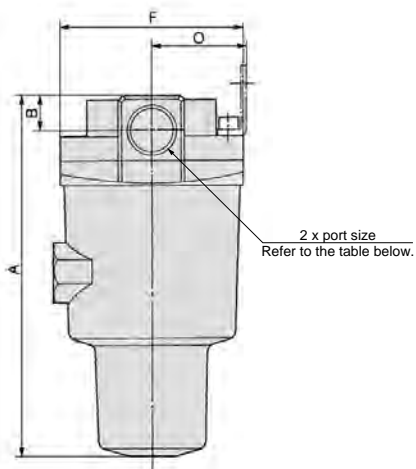
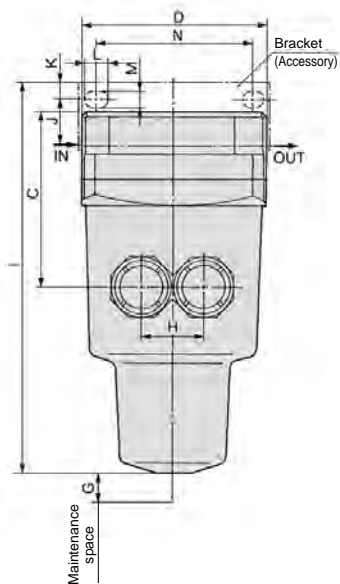
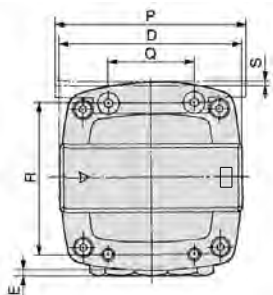

(mm)

Model	Port size	A	B	C	D	E	F	G	H	Bracket related dimensions										
										I	J	K	L	M	N	O	P	Q	R	S
10-AME650	1, 1½	291	32	167	160	—	160	10	66	314	40	15	20	11	150	85	180	76	136	4.5
10-AME850	1½, 2	403	42	235	220	—	220	10	96	406	30	15	24	13	180	120	220	110	184	6

Series 10-AMF

Odor Removal Filter

RoHS

Efficiently can remove odor in compressed air with an activated carbon element. The unit is designed for use in the area such as a clean room where odors must be avoided.

Can remove odor and gas ingredients in compressed air. Activated carbon element with large filtration area. Easy replacement of elements.

Modular connection is possible with 10-AMF150C to 550C. (For details, refer to page 1001.)



10-AMF150C to 350C 10-AMF450C, 550C



10-AMF650, 850

Model

Model	10-AMF150C	10-AMF250C	10-AMF350C	10-AMF450C	10-AMF550C	10-AMF650	10-AMF850
Rated flow (L/min [ANR])	200	500	1000	2000	3700	6000	12000
Port size	1/8, 1/4	1/4, 3/8	3/8, 1/2	1/2, 3/4	3/4, 1	1, 1 1/2	1 1/2, 2
Weight (kg)	0.3	0.48	0.8	1.3	2.0	4.2	10.5

Note) Maximum flow capacity at 0.7 MPa.

Maximum flow capacity varies depending on the operating pressure.

Refer to Flow Rate Characteristics (page 997) and Max. Flow Capacity Line (page 996).

Specifications

Fluid	Compressed air
Max. operating pressure	1.0 MPa
Min. operating pressure	0.05 MPa
Proof pressure	1.5 MPa
Ambient and fluid temperature	5 to 60°C
Nominal filtration rating	0.01 μm (Filtration efficiency: 99.9%)
Cleanliness at outlet	Less than 100 particles of 0.3 μm or larger per cubic foot [Less than 35 particles per 10 liters [ANR]] (The AME series is required on the inlet side.)
Oil mist density at outlet	Max. 0.004 mg/m ³ [ANR] (=0.0032 ppm) (The AME series is required on the inlet side.)
Element replacement period	1. Replace the element when you smell oil on the outlet side. 2. Even if the deodorization performance is normal, the replacement interval for the element is when the pressure drop reaches 0.1 MPa or after two years of operation, whichever comes first.
Cleanliness class (ISO class)	Class 3

Accessory (Option)

Applicable model	10-AMF150C	10-AMF250C	10-AMF350C	10-AMF450C	10-AMF550C	10-AMF650	10-AMF850
Bracket assembly (with 2 mounting screws)	10-AM-BM101	10-AM-BM102	10-AM-BM103	10-AM-BM104	10-AM-BM105	10-BM56	10-BM57

⚠ Caution

Be sure to read this before handling.
Refer to page 1382 for Safety Instructions and pages 1064 to 1066 for Air Preparation Equipment Precautions.

Directional Control Valves

Air Cylinders

Rotary Actuators

Air Grippers

Air Preparation Equipment

Modular F. R.

Pressure Control Equipment

Fittings & Tubing

Flow Control Equipment

Pressure Switches/ Pressure Sensors

How to Order



10-AMF150C to 550C

10-AMF 550C - [] **10** [] - []

Body size

150C
250C
350C
450C
550C

Thread type

Symbol	Type
Nil	Rc
F	G
N	NPT

Option

Symbol	Description
Nil	—
F	Rubber material: Fluororubber
H	For medium air pressure (1.6 MPa)
R	IN-OUT reversal direction

Accessory

Symbol	Description
Nil	—
B	Bracket *

* Bracket is included (but not assembled).

Port size

Symbol	Size	Applicable body size				
		150C	250C	350C	450C	550C
01	1/8	●				
02	1/4	●	●			
03	3/8		●	●		
04	1/2			●	●	
06	3/4				●	●
10	1					●

Options

Symbol F: Rubber material: Fluororubber

Fluororubber is used for the parts such as O-ring and gasket.

Symbol H: For medium air pressure (1.6 MPa)

Can be used up to 1.6 MPa at maximum.

Symbol R: IN-OUT reversal direction

Air flow direction is changed to right to left.
(Air flow direction of the standard: Left to right.)



How to Order

10-AMF650 to 850

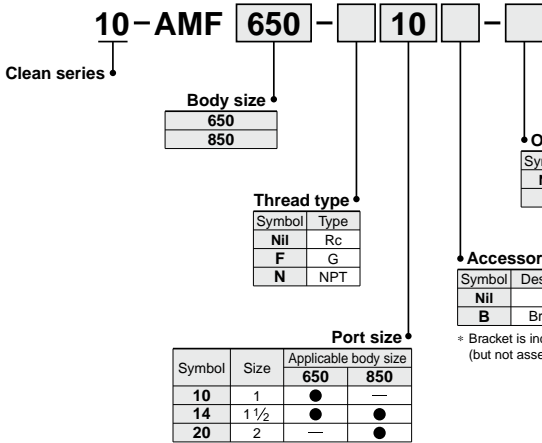

Model Selection

Select a model in accordance with the following procedure taking the inlet pressure and the maximum flow capacity rate into consideration.
 (Example) Inlet pressure: 0.6 MPa
 Maximum flow capacity: 5 m³/min [ANR]

1. Obtain the intersecting point A of inlet pressure and maximum flow capacity in the graph.
2. The 10-AMF650 is obtained when the max. flow capacity line is above the intersecting point A in the graph.

Note) Make sure to select a model that has the max. flow capacity line above the obtained intersecting point. With a model that has the max. flow capacity line below the obtained intersecting point, the flow rate will be exceeded, thus leading to a problem such as being unable to satisfy the specifications.

Max. Flow Capacity Line

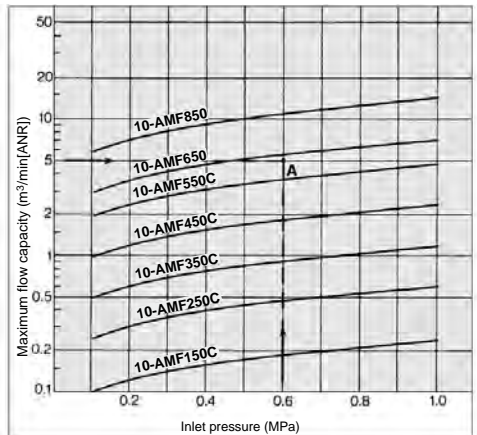

- Directional Control Valves
- Air Cylinders
- Rotary Actuators
- Air Grippers
- Air Preparation Equipment
- Modular F. R.
- Pressure Control Equipment
- Fittings & Tubing
- Flow Control Equipment
- Pressure Switches/ Pressure Sensors

Flow Rate Characteristics/Select the model under the max. flow capacity line. (Element oil saturation)

Note) Compressed air over max. flow capacity line in the table below may not meet the specifications of the product.

10-AMF150C

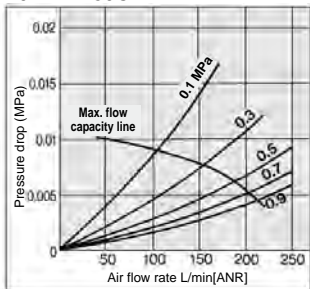

10-AMF450C

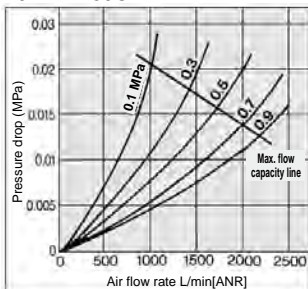

10-AMF850

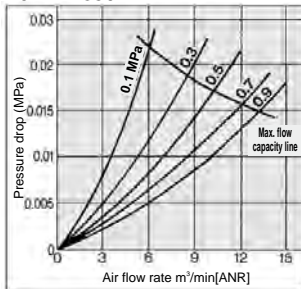

10-AMF250C

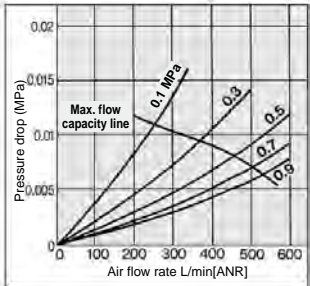

10-AMF550C

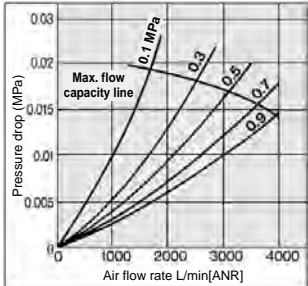

10-AMF350C

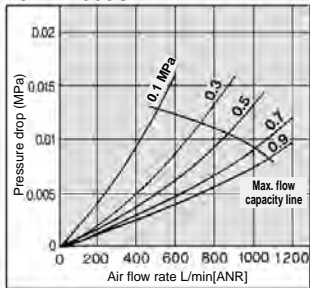

10-AMF650

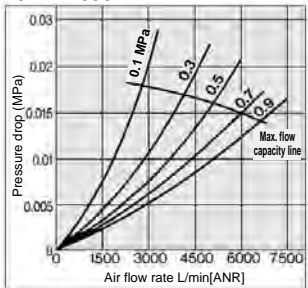

Construction

10-AMF150C to 550C

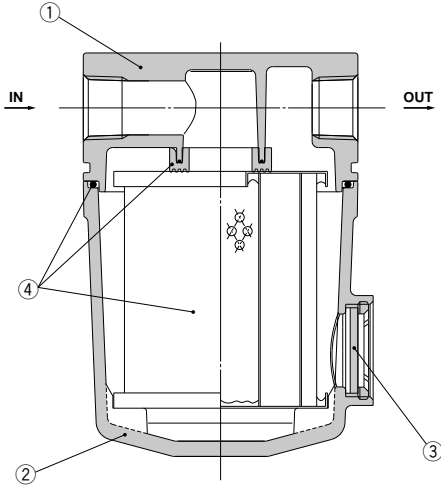

10-AMF650, 10-AMF850

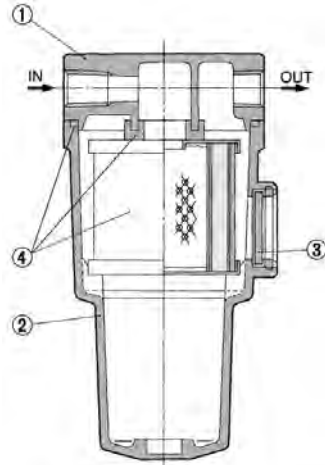

Component Parts

No.	Description	Material	Note
1	Body	Aluminum die-casted	Inner/outer surface coating
2	Housing	Aluminum die-casted*	
3	Sight glass	Tempered glass	—

* The 10-AMF850 is aluminum casted.

Note) Sight glass is indicated in the figure for easy understanding of component parts. However, it differs from the actual construction. Refer to Dimensions on pages 999 to 1000 for details.

Replacement Parts

No.	Description	Material	Applicable model	Model						
				10-AMF150C	10-AMF250C	10-AMF350C	10-AMF450C	10-AMF550C	10-AMF650	10-AMF850
4	Element assembly	Glass fiber, others	Except option F For option F	10-AMF-EL150 10-AMF-EL150-F	10-AMF-EL250 10-AMF-EL250-F	10-AMF-EL350 10-AMF-EL350-F	10-AMF-EL450 10-AMF-EL450-F	10-AMF-EL550 10-AMF-EL550-F	10-AMF-EL650	10-AMF-EL850

- Element assembly: With gasket (1 pc.) and O-ring (1 pc.)
- Refer to How to Order Bowl Assembly on page 1002.

Directional Control Valves
Air Cylinders
Rotary Actuators
Air Grippers
Air Preparation Equipment
Modular F. R.
Pressure Control Equipment
Fittings & Tubing
Flow Control Equipment
Pressure Switches/ Pressure Sensors

Dimensions

10-AMF150 to 350C

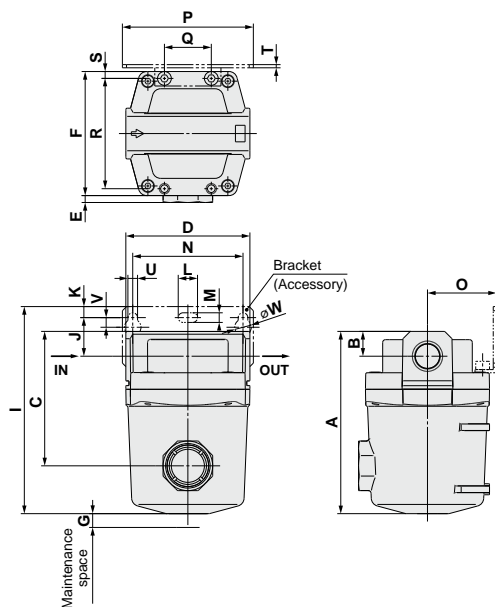

		[mm]						
Model	Port size	A	B	C	D	E	F	G
10-AMF150C	1/8, 1/4	83	10	54	63	7.5	63	10
10-AMF250C	1/4, 3/8	103	14	73	76	5	76	10
10-AMF350C	3/8, 1/2	132	18	98	90	5	90	10

Model	Bracket related dimensions							
	I	N	J	K	U	V	L	M
10-AMF150C	99	56	20	5	6	6	12	6
10-AMF250C	121	66	24	8	6	6	12	6
10-AMF350C	150	80	28	8	7	7	14	7

Model	Bracket related dimensions						
	W	O	P	Q	R	S	T
10-AMF150C	10	35	70	26	54	4.5	1.6
10-AMF250C	10	40	80	28	66	5	2
10-AMF350C	12	50	95	34	80	5	2.3

10-AMF450C/550C

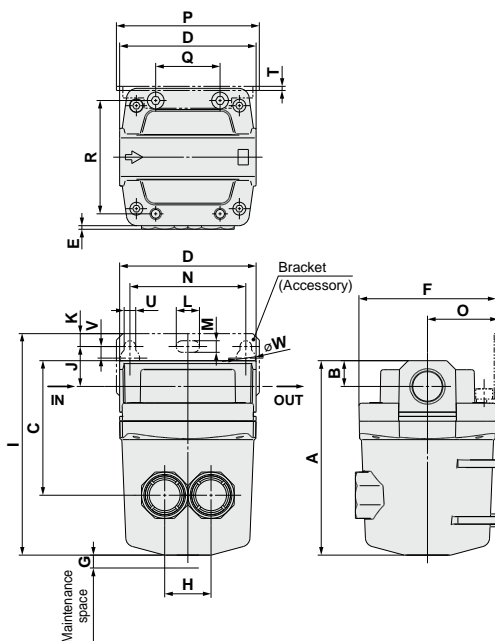

		[mm]							
Model	Port size	A	B	C	D	E	F	G	H
10-AMF450C	1/2, 3/4	151	20	105	106	3	106	10	36
10-AMF550C	3/4, 1	187	24	130	122	3	122	15	44

Model	Bracket related dimensions							
	I	N	J	K	U	V	L	M
10-AMF450C	172	90	31	10	9	9	18	9
10-AMF550C	206	100	33	10	9	9	18	9

Model	Bracket related dimensions					
	W	O	P	Q	R	T
10-AMF450C	15	55	111	50	88	3.2
10-AMF550C	15	65	126	60	102	3.2

Dimensions

10-AMF650/850

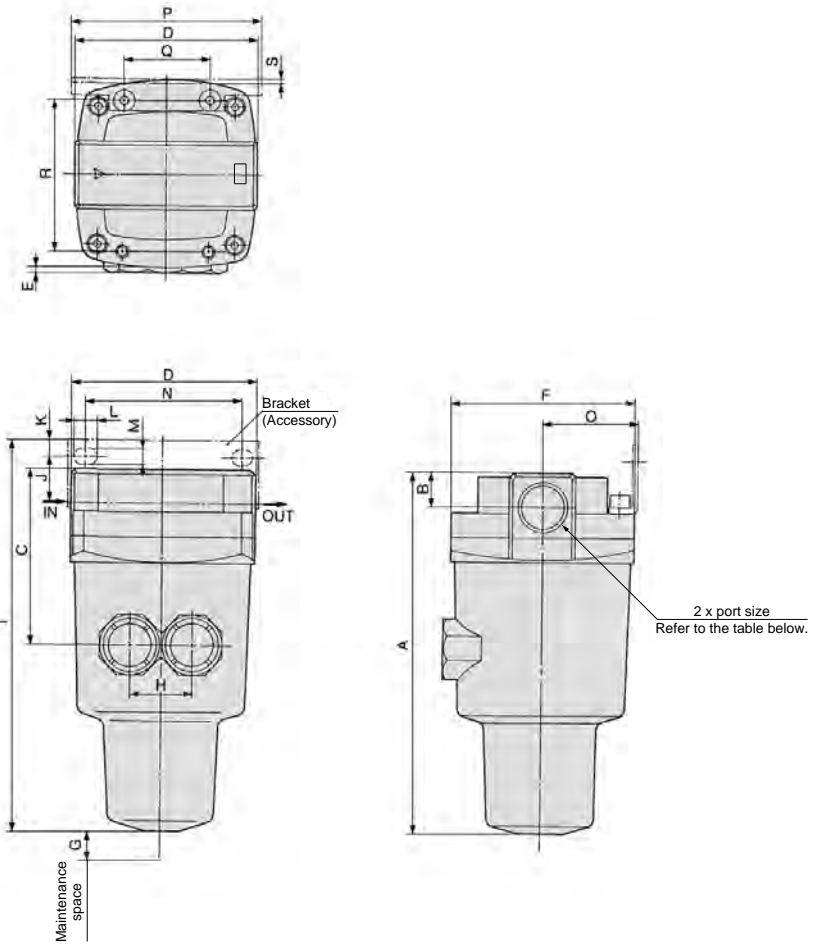

[mm]

Model	Port size	A	B	C	D	E	F	G	H	Bracket related dimensions											
										I	J	K	L	M	N	O	P	Q	R	S	
10-AMF650	1, 1½	291	32	167	160	—	160	10	66	314	40	15	20	11	150	85	180	180	76	136	4.5
10-AMF850	1½, 2	403	42	235	220	—	220	10	96	406	30	15	24	13	180	120	220	110	184	6	

Directional Control Valves
Air Cylinders
Rotary Actuators
Air Grippers
Air Preparation Equipment
Modular F. R.
Pressure Control Equipment
Fittings & Tubing
Flow Control Equipment
Pressure Switches/Pressure Sensors

Series 10-AM□/10-AFF□ Spacer for Modular Connection

Select a spacer from those listed below when combining modular type 10-AFF2C to 22C, 10-AM□150C to 550C. The spacer must be ordered separately.

(Note: Spacer with bracket (10-Y200T to Y600T) cannot be used.)

Caution

Modular connection

- Mount the attached bracket on one side when connecting 2 sets.
- Mount the attached brackets on both sides when connecting 3 sets or more.
- As a guideline for the number of brackets, one bracket should be mounted for every 2 products.



Combination examples of modular applicable products

Arrangement example

- 10-AMH250C-□□B — 1 pc.
- 10-AME250C — 1 pc.
- 10-Y300 — 1 pc.

Arrangement example

- 10-AMH250C-□□B — 1 pc.
- 10-AME250C — 1 pc.
- 10-AMF250C-□□B — 1 pc.
- 10-Y300 — 2 pcs.

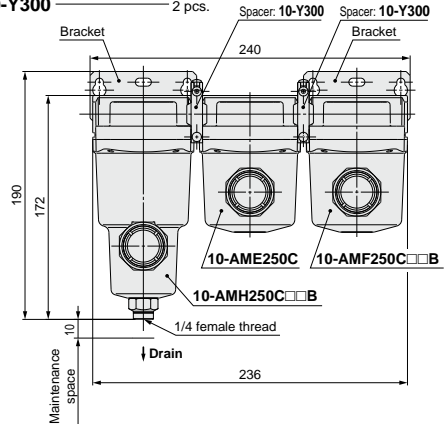
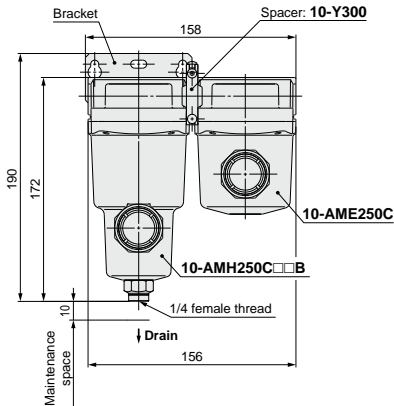

Spacer

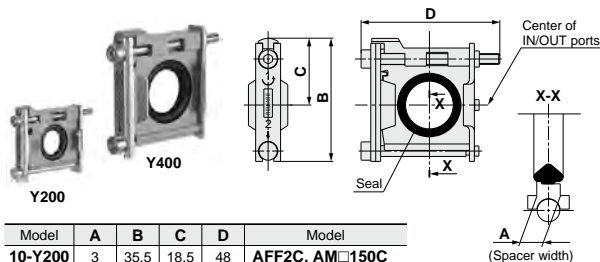

Model	A	B	C	D	Model
10-Y200	3	35.5	18.5	48	AFF2C, AM□150C
10-Y300	4	47	26	59	AFF4C, AM□250C
10-Y400	5	57	31	65	AFF8C, AM□350C
10-Y500	5	61	33	75	AFF11C, AM□450C
10-Y600	6	75.5	41	86	AFF22C, AM□550C

Replacement Parts

Description	Material	Part no.				
		10-Y200	10-Y300	10-Y400	10-Y500	10-Y600
Seal	HNBR	Y200P-061S	Y300P-060S	Y400P-060S	Y500P-060S	Y600P-060S

10-AFF-CA□/10-AM□-CA□

Bowl Assembly

Bowl Assembly

Bowl assembly for the AFF and AM □ series can be replaced without removing the main body from piping if the bowl has been damaged.

How to Order Bowl Assembly

■ 10-AFF2C to 22C, 10-AM, 10-AMD, 10-AMH

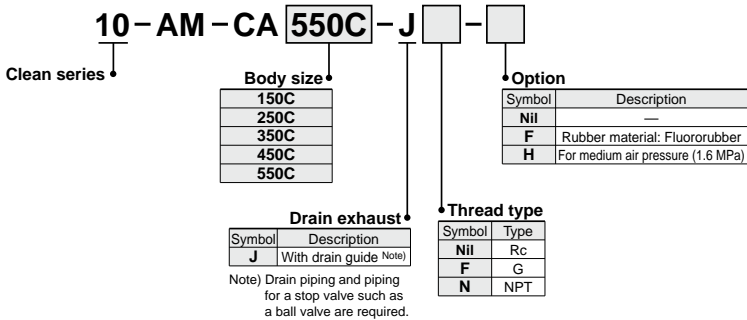

Applicable Model

Bowl assembly model	Applicable model
10-AM-CA150C-J	10-AFF2C, 10-AM150C, 10-AMD150C, 10-AMH150C
10-AM-CA250C-J	10-AFF4C, 10-AM250C, 10-AMD250C, 10-AMH250C
10-AM-CA350C-J	10-AFF8C, 10-AM350C, 10-AMD350C, 10-AMH350C
10-AM-CA450C-J	10-AFF11C, 10-AM450C, 10-AMD450C, 10-AMH450C
10-AM-CA550C-J	10-AFF22C, 10-AM550C, 10-AMD550C, 10-AMH550C

■ 10-AFF37B/75B

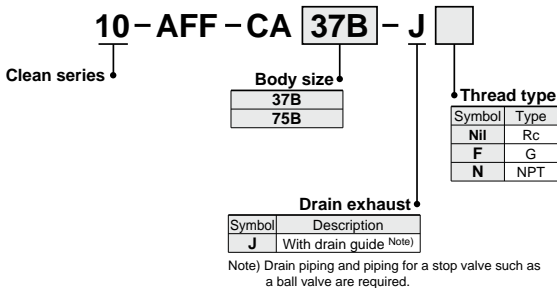

How to Order Bowl Assembly

■ 10-AM, 10-AMD, 10-AMH

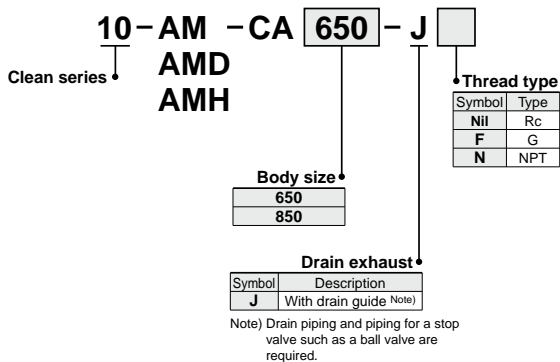

■ 10-AME, 10-AMF150C to 550C

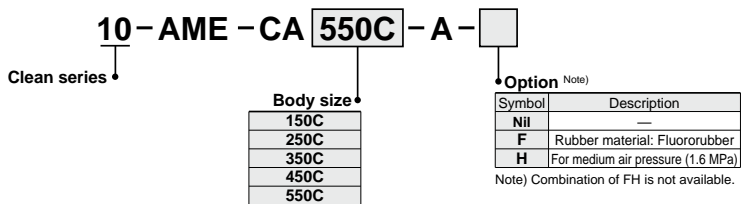

Applicable Model

Bowl assembly model	Applicable model
10-AME-CA150C-A	10-AME150C, 10-AMF150C
10-AME-CA250C-A	10-AME250C, 10-AMF250C
10-AME-CA350C-A	10-AME350C, 10-AMF350C
10-AME-CA450C-A	10-AME450C, 10-AMF450C
10-AME-CA550C-A	10-AME550C, 10-AMF550C

■ 10-AME, 10-AMF650, 850

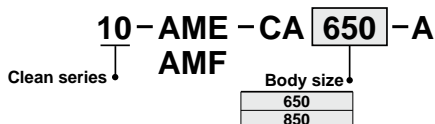

Dimensions: Series 10-AFF, 10-AM, 10-AMD, 10-AMH

Size: 10-AFF2C to 22C, 10-AFF37B, 10-AM□150C to 550C, 10-AM□650

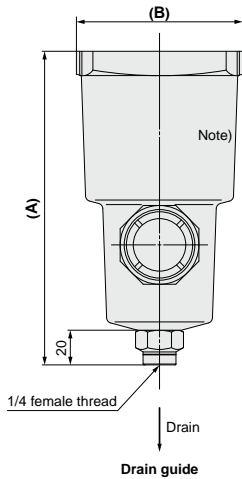

		(mm)	
Series AFF	Series AM, AMD, AMH	A	B
Size	Size		
2C	150C	134	63
4C	250C	139	76
8C	350C	162	90
11C	450C	178	106
22C	550C	202	122
37B	650	245	160

Note) Model no. labels are not affixed to the AM-CA150C to 550C.

Size: 10-AFF75B, 10-AM□850

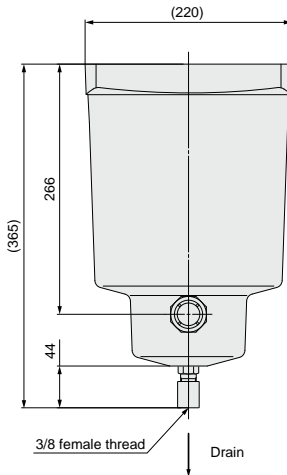

Directional Control Valves
Air Cylinders
Rotary Actuators
Air Grippers
Air Preparation Equipment
Modular F. R.
Pressure Control Equipment
Fittings & Tubing
Flow Control Equipment
Pressure Switches/Pressure Sensors

Bowl Assembly 10-AFF-CA□/10-AM□-CA□

Dimensions: Series 10-AME, 10-AMF

■ 10-AME150C to 550C, 10-AMF150C to 550C

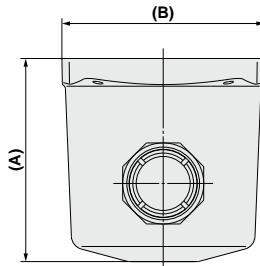

(mm)

Series 10-AME, 10-AMF Size	A	B
150	60	63
250	70	76
350	90	90
450	104	106
550	130	122

■ 10-AME650/850, 10-AMF650/850

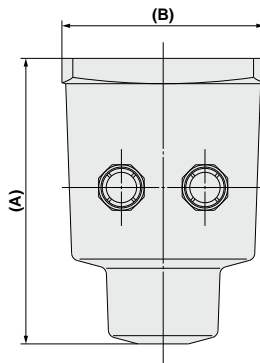

(mm)

Series 10-AME, 10-AMF Size	A	B
650	225	160
850	319	120



Series 10-AM□/10-AFF Specific Product Precautions 1

Be sure to read this before handling.
Refer to page 1382 for Safety Instructions and pages 1064 to 1066 for Air Preparation Equipment Precautions.

Design

⚠ Caution

1. Design the layout so that the mist separator should be installed in an area that is less susceptible to pulsations.

The element could be damaged if a difference between the inlet pressure and the outlet pressure exceeds 0.1 MPa.

2. Be careful of dust generation by the pneumatic equipment mounted on the outlet side.

When installing pneumatic equipment on the outlet side of the 10-AFF series, 10-AM□ series, dust particles may come off from outlet equipment, which will lower the cleanliness of compressed air. Consider this impact upon the cleanliness of compressed air when installing pneumatic equipment on the outlet side.

3. Use the 10-AFF and 10-AM as a pre-filter for the 10-AME and 10-AMF.

(Do not use outlet air of the 10-AFF and 10-AM in a clean room.)

4. Provide a design that prevents back pressure and back flow.

Back pressure or back flow may damage an element.

⚠ Warning

1. Hold the female thread side and tighten to the recommended torque when screwing in the piping material.

Insufficient tightening torque may cause loosening or defective sealing. Over-tightening torque may damage the thread etc. If it is tightened without holding the female thread side, excessive force will be directly applied to the piping bracket resulting in a product failure.

Recommended Torque

Unit: N·m

Connection thread	1/8	1/4	3/8	1/2	3/4	1	1 1/2	2
Torque	7 to 9	12 to 14	22 to 24	28 to 30	28 to 30	36 to 38	48 to 50	48 to 50

* After tightening manually, tighten additionally by about 1/6 turn with a tightening tool.

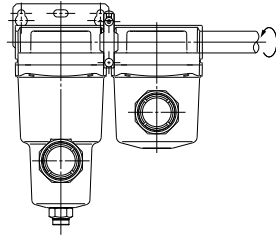

2. Do not apply torsional moment or bending moment (except the product's own weight) to the bracket. It may damage the bracket. Support external piping separately.

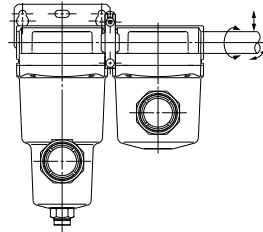

3. Inflexible piping such as steel piping tends to be affected by spread of excessive moment load or vibration from the piping side. Lay flexible tubing between the steel pipe and the product to prevent such effects.

Directional Control Valves

Air Cylinders

Rotary Actuators

Air Grippers

Air Preparation Equipment

Modular F. R.

Pressure Control Equipment

Fittings & Tubing

Flow Control Equipment

Pressure Switches/ Pressure Sensors



Series 10-AM□/10-AFF

Specific Product Precautions 2

Be sure to read this before handling.

Refer to page 1382 for Safety Instructions and pages 1064 to 1066 for Air Preparation Equipment Precautions.

Selection

⚠ Caution

1. About the system composition of purifying compressed air

Compressed air generally contains particulate contaminants as listed below, though there are some variations due to the compressor type and specifications. Determine the system configuration according to the desired cleanliness of compressed air and application, while referring to the Air Preparation Equipment Selection Guide for the 10-AM□ series (Best Pneumatics No.⑤ P. 2, 3).

[Particulate contaminants in compressed air]

- Water (drainage)
- Dust sucked from ambient air
- Degenerated oil from compressor
- Solid foreign matter such as rust inside piping and oil

2. Select according to the maximum flow capacity.

When compressed air is used for air blow, etc., find the maximum air consumption before selecting the size of the 10-AM□ series. (If compressed air exceeding the maximum flow capacity is supplied, it can result in decline of the cleanliness of compressed air or discharge of oil mist to outlet side.)

Mounting

⚠ Caution

1. About the mounting orientation of the products

Make sure to install this product on horizontal piping. If it is installed diagonally, laterally, or upside down, the drain separated by the element will splash to the outlet side.

Piping

⚠ Caution

1. Connect it with IN and OUT ports in proper location. It does not work with the connection reversed.

In the case of the 10-AFF2C to 22C, 37B, 75B, 10-AM□150C to 550C, 650, 850

Verify the direction of the flow of the compressed air and the "⇨" mark that indicates the inlet of the product before connecting. It cannot be used if connected in the opposite direction.

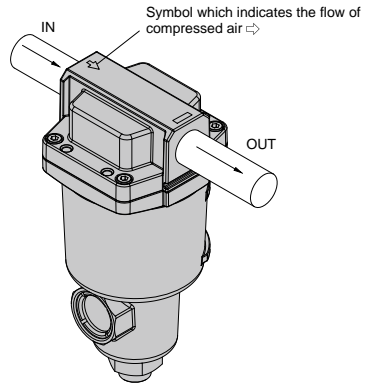

2. Use an air blower to flush the piping before connecting the piping.

Use an air blower to thoroughly flush the piping, or wash the piping to remove any cutting chips, cutting oil, or debris from inside the piping before connecting them.

3. Winding of sealant tape

When screwing in the pipes or fittings, make sure to prevent cutting chips or the sealant material on the threaded portion of the pipe from entering the piping. If sealant tape is to be used, leave about 1.5 to 2 ridges of threads uncovered.

4. Modular connection

Mount the attached bracket on one side when connecting 2 sets. Mount the attached brackets on both sides when connecting 3 sets or more. As a guideline for the number of brackets, one bracket should be mounted for every 2 products.



Series 10-AM□/10-AFF Specific Product Precautions 3

Be sure to read this before handling.

Refer to page 1382 for Safety Instructions and pages 1064 to 1066 for Air Preparation Equipment Precautions.

Air Supply

⚠ Caution

1. The mist separator is not applicable to gases other than compressed air.

The mist separator is not applicable to gases other than compressed air (example: oxygen, hydrogen, flammable gas, mixed gas).

2. Do not use compressed air that contains chemicals, organic solvents, salt, or corrosive gases.

Do not use compressed gas containing chemicals, organic solvents, salt or corrosive gas. This can cause rust, damage to rubber and resin parts, or malfunction.

3. Operate within the specified operating pressure range.

Damage, failure, or malfunction may occur if the mist separator is operated above the maximum operating pressure. If the mist separator is used below the minimum operating pressure, increase in the air-flow resistance due to clogging will have such influence that the desired flow rate cannot be obtained.

If the mist separator is used under a low pressure such as for a blower, conduct sufficient tests by users to confirm the specifications and performances.

Operating Environment

⚠ Caution

1. Do not use in the following environments, as this can cause failure.

- 1) In locations having corrosive gases, organic solvents, and chemical solutions, or in locations where these elements are likely to adhere to the equipment.
- 2) In locations where salt water, water, or water vapor could come in contact with the equipment.
- 3) In locations that is exposed to shocks and vibrations.

2. Be careful about the contamination of the workpieces due to entrainment of the ambient air.

If compressed air is used for air blow, compressed air blowing out from the blow nozzle may entrain foreign matter (solid particles and liquid particles) floating in the ambient air, blowing it against the workpieces and causing adhesion. Therefore, sufficient precautions must be taken about the ambient environment.

Maintenance

⚠ Caution

1. Replace the element immediately when the time for its replacement has arrived.

To replace the element, replace the O-ring and the gasket, too. For the replacement procedure, refer to the operation manual.

<Element replacement>

a. In the case of the 10-AFF2C to 22C, 37B, 75B, 10-AM□150C to 550C, 650, 850

The replacement interval for the element is when the pressure drop reaches 0.1 MPa or after two years of operation, whichever comes first. [A pressure drop can be verified with the element service indicator (-T)]

b. In the case of the 10-AME

Regardless of the time for its replacement indicated in "a" above, replace the element when a red color spot occurred on the surface.

c. In the case of the 10-AMF

Regardless of the time for its replacement indicated in "a" or "b", replace the element when you smell oil on the outlet side.

2. Be sure to exhaust the drain accumulated in the filter container.

Failure to discharge the drain will allow the accumulated drain to flow over to the outlet side.

Drain guide or ball valve, discharge the drain before the drainage level reaches the center of the sight glass. If the drain is not discharged properly, it will flow over to the outlet side.

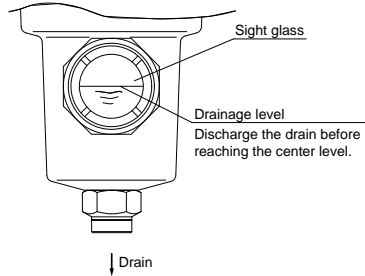

Directional Control Valves

Air Cylinders

Rotary Actuators

Air Grippers

Air Preparation Equipment

Modular F. R.

Pressure Control Equipment

Fittings & Tubing





Flow Control Equipment

Pressure Switches/ Pressure Sensors

Series SF

Clean Gas Filter Clean Gas Strainer

Variations

	Series	Filtration	Flow rate L/min (ANR) (Inlet pressure is 0.7 MPa, at pressure drop of 0.02 MPa)	Pressure MPa	Temperature °C	Replacement of element	Page
Cartridge type	Disc type 		0.01 μm (Filtering efficiency 99.99%) (Membrane element)	0.99	5 to 80	Replaceable	P. 1011
	SFA10 <input type="checkbox"/>	26					
	SFA20 <input type="checkbox"/>	70					
	SFA30 <input type="checkbox"/>	140					
Cartridge type	Straight type 		Nominal 120 μm (Strainer) (Sintered metallic element)	0.99	5 to 80	Replaceable	P. 1014
	SFB10 <input type="checkbox"/>	45					
	SFB20 <input type="checkbox"/>	(Strainer)	400				P. 1015
Disposable type	Straight type 		0.01 μm (Filtering efficiency 99.99%) (Membrane element)	0.99	5 to 120	Nonreplaceable	P. 1018
	SFB30 <input type="checkbox"/>	45					
	Multiple disc type 		0.01 μm (Filtering efficiency 99.99%) (Membrane element)	0.99	5 to 120	Nonreplaceable	P. 1021
SFC10 <input type="checkbox"/>	240						
Made to Order	<ul style="list-style-type: none"> Case/Cover material: Aluminum alloy (SFB100) Strainer with other nominal filtration: 1, 2, 5, 10, 20, 40, 70, 100 μm (SFB200) 						P. 1024

Series SF

Model Selection

Determine the model by using the following procedures involving the inlet pressure and the maximum flow rate.

Example) Inlet pressure: 0.6 MPa

Maximum flow rate: 200 L/min (ANR)

1. Determine intersection A for the inlet pressure and the maximum flow rate by using the maximum flow rate graph.
2. If the obtained intersection A is above the maximum flow rate line, SFC10 is selected.

Note) Please be sure to select a model with a maximum flow rate line which is above the obtained intersection A. If the obtained intersection A is below the maximum flow rate line, overflow will occur. This will cause a nonconformance in which the specification will not be satisfied.

Maximum Flow Rate Lines

Clean Gas Filter

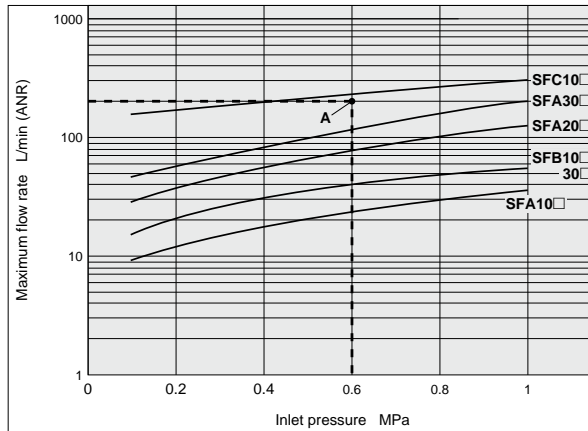

Clean Gas Strainer

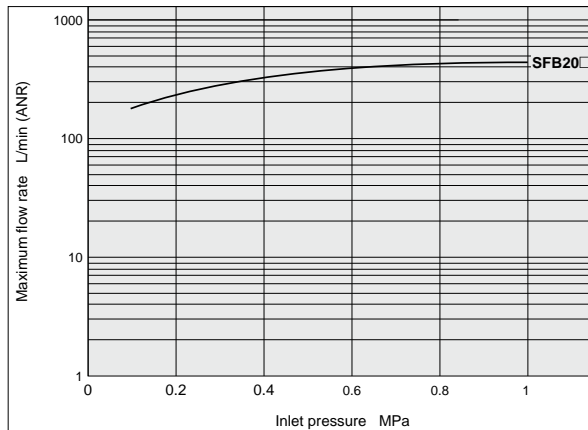

Series SFA100/200/300

Clean Gas Filter:
Cartridge Type/Disc Type

Precision filtration for compressed air, nitrogen, etc. used in the electronic industry, etc.

PTFE membrane element is made into a cartridge. (Filtration 0.01 μm (Filtering efficiency 99.99%))

Made into a cartridge by polyester holder and fluororubber (FKM) gasket.

Elements are replaceable.



How to Order

SFA 10 0 - 02

Clean gas filter
Cartridge type
(Disc type)

Port size

Symbol	Port size
02	Rc, NPT, TSJ, UOJ 1/4

Model size

Symbol	Rated flow rate L/min(ANR)
10	Up to 26
20	Up to 70
30	Up to 140

Connection

Symbol	Connection (IN, OUT)
0	Rc
1	NPT
2	TSJ
3	UOJ

Model

Model	Rated flow rate L/min (ANR) ^{Note 1)}	Connection	Filtration area cm ²	Element part no. ^{Note 2)}	Weight kg
SFA100-02	26	Rc 1/4 (Female thread)	13.85	ED001S-X10V	0.34
SFA101-02		NPT 1/4 (Female thread)			
SFA200-02	70	Rc 1/4 (Female thread)	33.18	ED101S-X10V	0.44
SFA201-02		NPT 1/4 (Female thread)			
SFA300-02	140	Rc 1/4 (Female thread)	56.75	ED201S-X10V	0.66
SFA301-02		NPT 1/4 (Female thread)			
SFA102-02	26	TSJ 1/4 Tube Swage Joint	13.85	ED001S-X10V	0.38
SFA202-02	70		33.18	ED101S-X10V	0.49
SFA302-02	140		56.75	ED201S-X10V	0.70
SFA103-02	26	UOJ 1/4 Union O-ring Joint	13.85	ED001S-X10V	0.42
SFA203-02	70		33.18	ED101S-X10V	0.53
SFA303-02	140		56.75	ED201S-X10V	0.75

Note 1) Inlet pressure 0.7 MPa, at pressure drop 0.02 MPa

Note 2) Element part numbers include numbers 3 to 7 in the construction figure. (Refer to page 1012.)

Specifications

Fluid	Air, Nitrogen	
Operating pressure <small>Note 1)</small>	Max. 0.99 MPa, Vacuum 1.3×10^{-6} kPa	
Operating temperature	5 to 80°C	
Element proof differential pressure	Max. 0.1 MPa	
Element reverse differential pressure	Max. 0.05 MPa	
Filtration <small>Note 2)</small>	0.01 μm (Filtering efficiency 99.99%)	
Purification in the outlet side	Particle with 0.1 μm or larger 0 pcs/6 L	
Main material	Case	Stainless steel 316 (Interior/Exterior: Electrolytic polishing)
	Filter medium	PTFE membrane
	Seal	Fluororubber (FKM)
Packaging	Antistatic sealed double package	

Note 1) The maximum operating pressure is 0.99 MPa since this product does not conform to the High Pressure Gas Safety Law.
 Note 2) Based on SMC's measuring conditions.

Construction

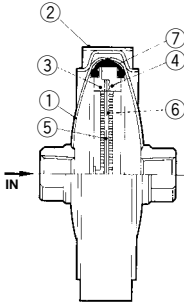

No.	Description	Material	Note
1	Case	Stainless steel 316	Electrolytic polishing (Interior/Exterior)
2	V-clamp	Stainless steel 304	—
3	Holder 1	Polyester	Cartridge element
4	Holder 2		
5	Filter medium	PTFE	
6	Seal	FKM	
7	V-seal		

Directional Control Valves

Air Cylinders

Rotary Actuators

Air Grippers

Air Preparation Equipment

Modular F. R.

Pressure Control Equipment

Fittings & Tubing

Flow Control Equipment

Pressure Switches/ Pressure Sensors

Flow Rate Characteristics Fluid: Compressed air Inlet temperature: 20°C

SFA100

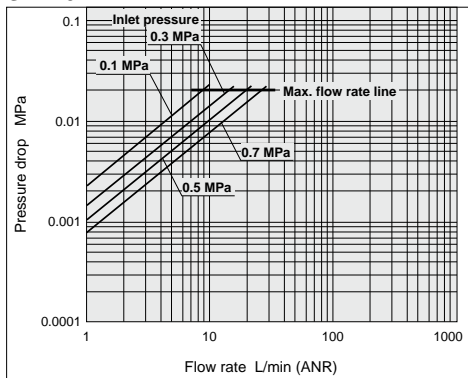

SFA200

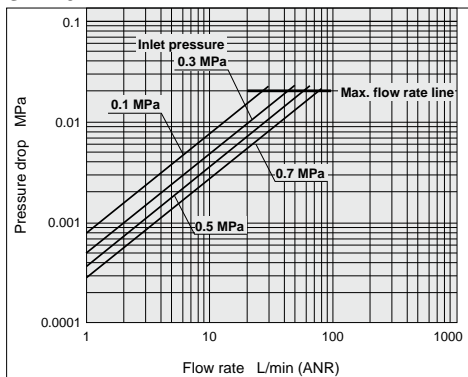

SFA300

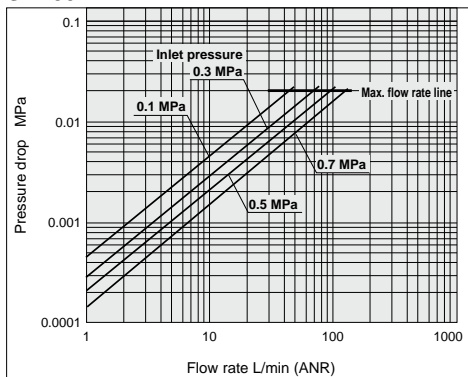

Dimensions

SFA100/101, SFA200/201, SFA300/301

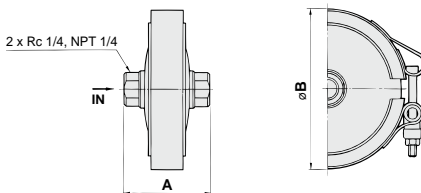

Model	Connection	A	øB
SFA100-02	Rc 1/4	46	76
SFA101-02	NPT 1/4		
SFA200-02	Rc 1/4	51	96
SFA201-02	NPT 1/4		
SFA300-02	Rc 1/4	59	120
SFA301-02	NPT 1/4		

SFA102, SFA202, SFA302

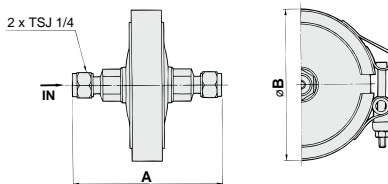

Model	Connection	A	øB
SFA102-02	TSJ 1/4 (Tube Swage Joint)	89	76
SFA202-02		93	96
SFA302-02		101	120

SFA103, SFA203, SFA303

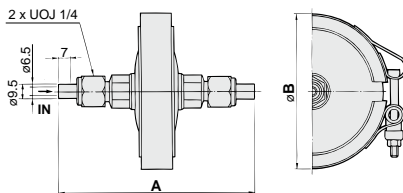

Model	Connection	A	øB
SFA103-02	UOJ 1/4 (Union O-ring Joint)	117	76
SFA203-02		122	96
SFA303-02		130	120

Series SFB100

Clean Gas Filter:
Cartridge Type/Straight Type

RoHS

Precision filtration for compressed air, nitrogen, etc. used in the electronic industry, etc.

PTFE membrane element is made into a cartridge. (Filtration 0.01 μm (Filtering efficiency 99.99%))

Made into a cartridge by fluoropolymer holder and fluororubber (FKM) gasket.

Elements are replaceable.

Bracket is included as a standard.



How to Order

SFB 10 0 - 02

Clean gas filter
(Straight type)

Made to Order

(Note) Refer to page 1024 for details.

Model type

Symbol	Type
10	Cartridge

Port size

Symbol	Port size
02	Rc, NPT, TSJ, UOJ 1/4
M5	Female thread M5

Connection

Symbol	Connection (IN, OUT)
0	Rc
1	NPT
2	TSJ
3	UOJ
4	M5 (Female thread)

Specifications

Fluid		Air, Nitrogen
Operating pressure <small>Note 1)</small>		Max. 0.99 MPa, Vacuum 1.3×10^{-6} kPa
Operating temperature		5 to 80°C
Element proof differential pressure		Max. 0.5 MPa
Element reverse differential pressure		Max. 0.07 MPa
Filtration <small>Note 2)</small>		0.01 μm (Filtering efficiency 99.99%)
Purification in the outlet side		Particle with 0.1 μm or larger 0 pcs/6 L
Main material	Case/Cover	Stainless steel 316 (Interior/Exterior: Electrolytic polishing)
	Filter medium	PTFE membrane
	Seal	Fluororubber (FKM)
Packaging		Antistatic sealed double package

Note 1) The maximum operating pressure is 0.99 MPa since this product does not conform to the High Pressure Gas Safety Law.
Note 2) Based on SMC's measuring conditions.

Model

Model	Rated flow rate L/min (ANR) <small>Note)</small>	Connection	Filtration area cm^2	Element part no. (Including O-rings)	Weight kg
SFB100-02	45	Rc 1/4 (Female thread)	10	ED301S-X10V (Including O-rings)	0.15
SFB101-02		NPT 1/4 (Female thread)			
SFB102-02		TSJ 1/4			
SFB103-02		UOJ 1/4			
SFB104-M5		M5 (Female thread)			

Note) Inlet pressure 0.7 MPa, at pressure drop 0.02 MPa

Series SFB200

Clean Gas Strainer: **RoHS**
Cartridge Type/Straight Type

Cartridge made of stainless steel
316 sintered metallic element
(Nominal filtration: 120 μm)

Clean gas strainers made of an element (120 μm, stainless steel 316 sintered metal) to protect regulators and vacuum regulators are also available.



How to Order

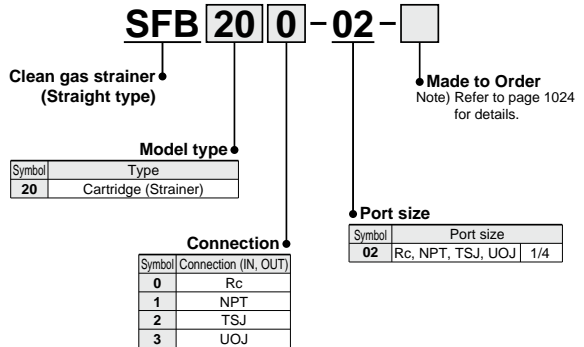

Specifications

Fluid	Air, Nitrogen	
Operating pressure	Max. 0.99 MPa, Vacuum 1.3 x 10 ⁻⁶ kPa	
Operating temperature <small>(Note)</small>	5 to 80°C	
Element proof differential pressure	Max. 1.0 MPa	
Element reverse differential pressure	Max. 1.0 MPa	
Nominal filtration	120 μm	
Main material	Case/Cover	Stainless steel 316 (Interior/Exterior: Electrolytic polishing)
	Seal	Fluororubber (FKM)
	Filter medium	Stainless steel 316 sintered metal
Packaging	Antistatic sealed double package	

Model

Model	Rated flow rate L/min (ANR) <small>(Note)</small>	Connection	Filtration area cm ²	Element part no.	Weight kg
SFB200-02	400	Rc 1/4 (Female thread)	10	ES001S-120V (Including O-rings)	0.16
SFB201-02		NPT 1/4 (Female thread)			
SFB202-02		TSJ 1/4			
SFB203-02		UOJ 1/4			

(Note) Inlet pressure 0.7 MPa, at pressure drop 0.02 MPa

Construction

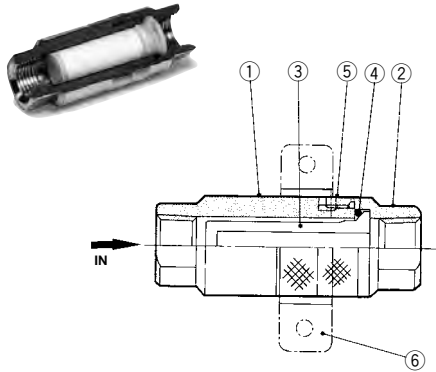

No.	Description	Material	Note
1	Case	Stainless steel 316	Electrolytic polishing (Interior/Exterior)
2	Cover	Stainless steel 316	Electrolytic polishing (Interior/Exterior)
3	Clean gas filter	PTFE membrane	For SFB10□
	Clean gas strainer	Stainless steel 316 sintered metal	For SFB20□
4	O-ring	FKM	—
5	Hexagon socket head cap screw	Stainless steel 304	M3
6	Bracket	Stainless steel 304	—

Flow Rate Characteristics

Fluid: Compressed air Inlet temperature: 20°C

SFB104-M5

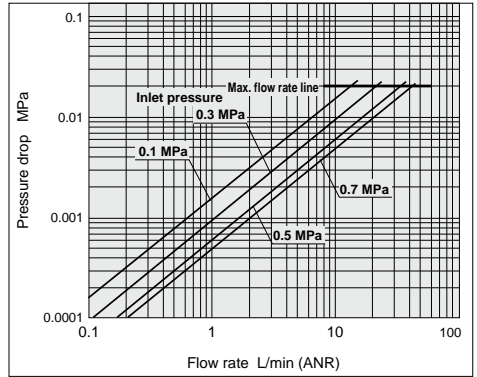

SFB10□-02

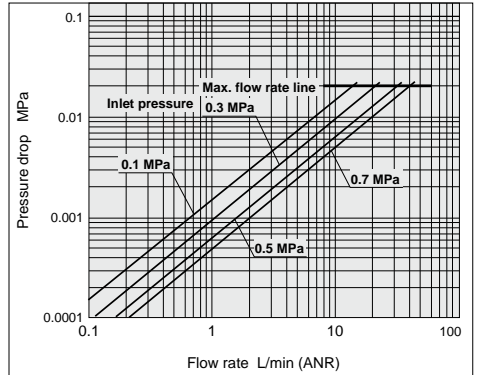

SFB20□-02

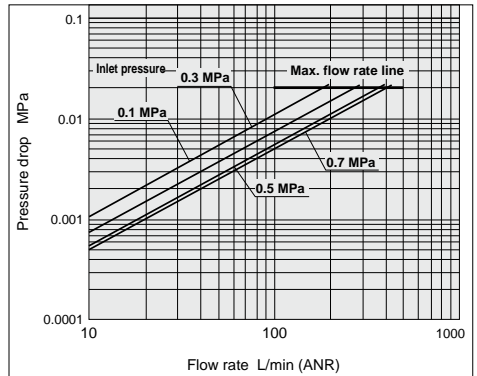

Directional Control Valves
Air Cylinders
Rotary Actuators
Air Grippers
Air Preparation Equipment
Modular F. R.
Pressure Control Equipment
Fittings & Tubing
Flow Control Equipment
Pressure Switches/Pressure Sensors

Dimensions

SFB100/200: Rc 1/4
SFB101/201: NPT 1/4
SFB104: M5

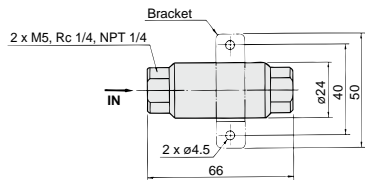

Model	Connection
SFB100-02, 200-02	Rc 1/4
SFB101-02, 201-02	NPT 1/4
SFB104-M5	M5

SFB102-02, SFB202-02: TSJ 1/4 (Tube Swage Joint)

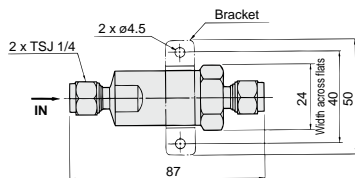

SFB103-02, SFB203-02: UOJ 1/4 (Union O-ring Joint)

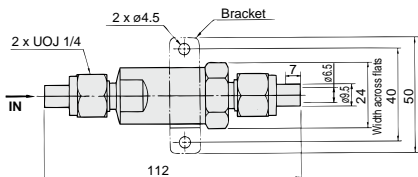

Series SFB300

Clean Gas Filter:
Disposable Type/Straight Type

Precision filtration for compressed air, nitrogen, etc. used in the semi-conductor process

PTFE membrane with high reliability

Filtration 0.01 μm (Filtering efficiency 99.99%)

Bracket is included as a standard.



How to Order

SFB 30 0 - 02

Clean gas filter
(Straight type)

Port size

Symbol	Port size
02	Rc, NPT, TSJ, UOJ 1/4

Model type

Symbol	Type
30	Disposable (Narrow size)
31	Disposable (Long size)

Connection

Symbol	Connection (IN, OUT)
0	Rc
2	TSJ
5	URJ

* SFB31: Only 5 is selectable.

Model

Model	Rated flow rate L/min (ANR) <small>Note)</small>	Connection	Filtration area cm ²	Weight kg
SFB300-02	45	Rc 1/4 (Female thread)	10	0.14
SFB302-02		TSJ 1/4		0.15
SFB305-02		URJ 1/4		0.14
SFB315-02		URJ 1/4		0.15

Note) Inlet pressure 0.7 MPa, at pressure drop 0.02 MPa

Directional Control Valves

Air Cylinders

Rotary Actuators

Air Grippers

Air Preparation Equipment

Modular F. R.

Pressure Control Equipment

Fittings & Tubing

Flow Control Equipment

Pressure Switches/ Pressure Sensors

Specifications

Fluid	Air, Nitrogen	
Operating pressure <small>Note 1)</small>	Max. 0.99 MPa, Vacuum 1.3×10^{-6} kPa	
Operating temperature	5 to 120°C	
Element proof differential pressure	Max. 0.5 MPa	
Element reverse differential pressure	Max. 0.07 MPa	
Filtration <small>Note 2)</small>	0.01 μm (Filtering efficiency 99.99%)	
Purification in the outlet side	Particle with 0.1 μm or larger 0 pcs/6 L	
Helium leak volume	4.0×10^{-9} Pa·m ³ /sec or less	
Main material	Case/Cover	Stainless steel 316 (Interior/Exterior: Electrolytic polishing)
	Filter medium	PTFE membrane
	O-ring	Stainless steel 304

Note 1) The maximum operating pressure is 0.99 MPa since this product does not conform to the High Pressure Gas Safety Law.
 Note 2) Based on SMC's measuring conditions.

Construction

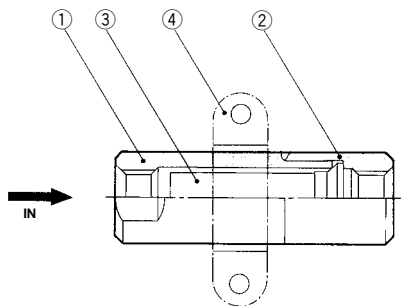

No.	Description	Material	Note
1	Case	Stainless steel 316	Electrolytic polishing (Interior/Exterior)
2	Cover		
3	Element	PTFE membrane	
4	Bracket	Stainless steel 316 sintered metal	

Flow Rate Characteristics Fluid: Compressed air Inlet temperature: 20°C

SFB300-02

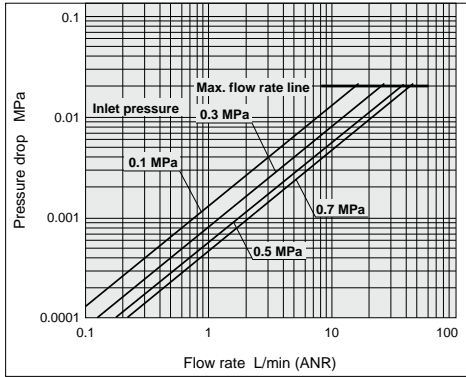

Dimensions

SFB300-02: Rc 1/4

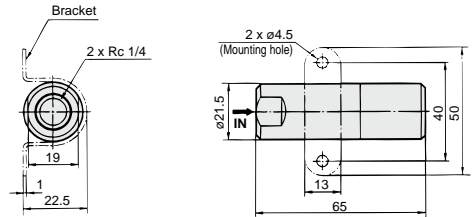

SFB302-02: TSJ 1/4 (Tube Swage Joint)

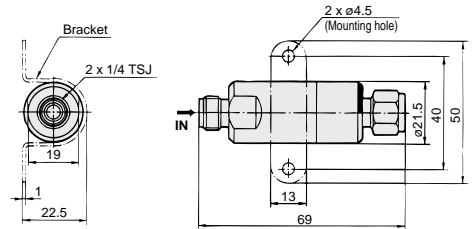

SFB305-02, SFB315-02: URJ 1/4 (Union Ring Joint)

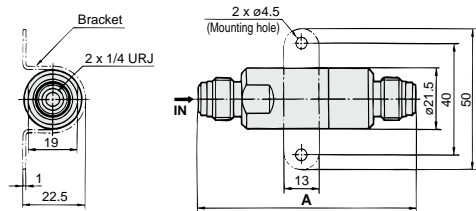

Model	A
SFB305-02	79
SFB315-02	84

Directional Control Valves

Air Cylinders

Rotary Actuators

Air Grippers

Air Preparation Equipment

Modular F. R.

Pressure Control Equipment

Fittings & Tubing

Flow Control Equipment

Pressure Switches/ Pressure Sensors

Series SFC100

Clean Gas Filter:
Disposable Type/Multiple Disc Type



Precision filtration for compressed air, nitrogen, etc. used in the semi-conductor process

PTFE membrane with high reliability

Filtration 0.01 μm (Filtering efficiency 99.99%)



How to Order

SFC 10 0 - 02

Clean gas filter
Disposable type
(Multiple disc type)

Port size

Symbol	Port size
02	Rc, TSJ, URJ 1/4
03	Rc, TSJ, URJ 3/8

Model type

Symbol	Rated flow rate L/min (ANR)
10	Up to 240

Connection

Symbol	Connection (IN, OUT)
0	Rc
2	TSJ
5	URJ

Model

Model	Rated flow rate L/min (ANR) ^{Note)}	Connection	Filtration area cm ²	Weight kg
SFC100-02	240	Rc 1/4 (Female thread)	300	0.35
SFC100-03		Rc 3/8 (Female thread)		0.36
SFC102-02		TSJ 1/4		0.40
SFC102-03		TSJ 3/8		0.41
SFC105-02		URJ 1/4		0.44
SFC105-03		URJ 3/8		0.49

Note) Inlet pressure 0.7 MPa, at pressure drop 0.02 MPa

Specifications

Fluid	Air, Nitrogen	
Operating pressure <small>Note 1)</small>	Max. 0.99 MPa, Vacuum 1.3×10^{-6} kPa	
Operating temperature	5 to 120°C	
Element proof differential pressure	Max. 0.42 MPa	
Element reverse differential pressure	Max. 0.07 MPa	
Filtration <small>Note 2)</small>	0.01 μm (Filtering efficiency 99.99%)	
Purification in the outlet side	Particle with 0.1 μm or larger 0 pcs/6 L	
Helium leak volume	4.0×10^{-9} Pa·m ³ /sec or less	
Main material	Case/Cover	Stainless steel 316 (Interior/Exterior: Electrolytic polishing)
	Filter medium	PTFE membrane
	O-ring	PTFE

Note 1) The maximum operating pressure is 0.99 MPa since this product does not conform to the High Pressure Gas Safety Law.
 Note 2) Based on SMC's measuring conditions.

Construction

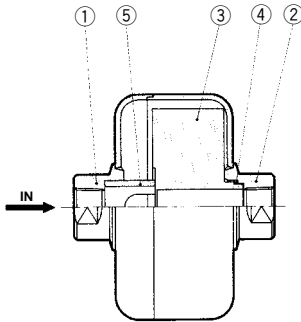

No.	Description	Material	Note
1	Case 1	Stainless steel 316	Electrolytic polishing (Interior/Exterior)
2	Case 2		
3	Element	PTFE, PVDF	
4	O-ring	PTFE	
5	Spacer	PVDF	

Directional Control Valves

Air Cylinders

Rotary Actuators

Air Grippers

Air Preparation Equipment

Modular F. R.

Pressure Control Equipment

Fittings & Tubing

Flow Control Equipment

Pressure Switches/ Pressure Sensors

Flow Rate Characteristics Fluid: Compressed air Inlet temperature: 20°C

SFC10□

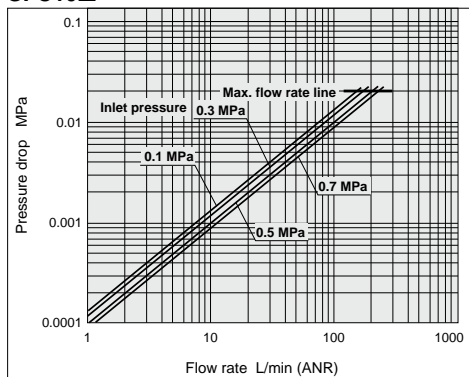

Dimensions

SFC100-02: Rc 1/4

SFC100-03: Rc 3/8

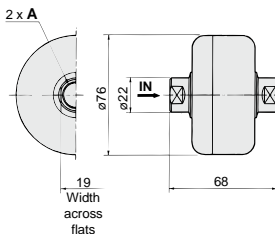

Model	A
SFC100-02	Rc 1/4
SFC100-03	Rc 3/8

SFC102-02: TSJ 1/4 (Tube Swage Joint)

SFC102-03: TSJ 3/8 (Tube Swage Joint)

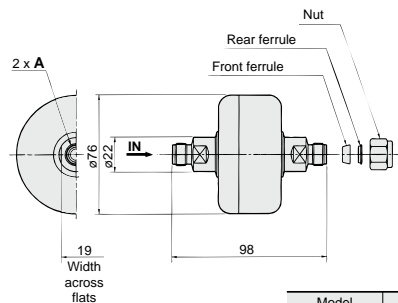

Model	A
SFC102-02	TSJ 1/4
SFC102-03	TSJ 3/8

SFC105-02: URJ 1/4 (Union Ring Joint)

SFC105-03: URJ 3/8 (Union Ring Joint)

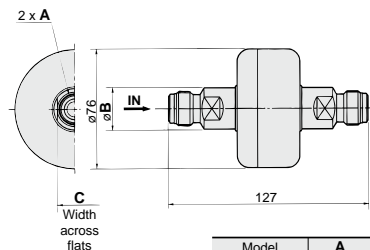

Model	A	B	C
SFC105-02	URJ 1/4	22	19
SFC105-03	URJ 3/8	26.5	22



Case/Cover material: Aluminum alloy

Part No.: SFB100-02X8

Specifications

Fluid	Air	
Operating pressure	Max. 0.99 MPa	
Max. operating temperature	80°C	
Element proof differential pressure	Max. 0.5 MPa	
Element reverse differential pressure	Max. 0.07 MPa	
Filtration ^{Note)}	0.01 μm (Filtering efficiency 99.99%)	
Connection	Rc 1/4	
Filtration area	10 cm ²	
Element part no.	ED301S-X10V	
Weight	0.06 kg	
Main material	Case/Cover	A2017 (Clear anodized)
	Seal	Fluororubber (FKM)
	Element	PTFE membrane

Dimensions are identical to the standard models. For details, refer to page 1017.
 Note) Based on SMC's measuring conditions. (Refer to Technical Data SM-86-009.)

Strainer with other nominal filtration (1,2,5,10,20,40,70,100 μm)

The filtration other than the standard filtration accuracy, 120 μm, is available with the clean gas strainer.

Part No.: SFB200-02-S -X40**Nominal filtration**

Symbol	Nominal filtration μm ^{Note 1)}	Rated flow rate L/min (ANR) ^{Note 2)}
001	1	5
002	2	10
005	5	15
010	10	30
020	20	50
040	40	80
070	70	130
100	100	250

Note 1) Nominal filtration refers to value used to categorize raw material.

Note 2) Maximum flow rate at inlet pressure 0.7 MPa.
 Other specifications and dimensions are identical to the standard models. For details, refer to pages 1015 and 1017.

O-ring

Symbol	Material
N	NBR
V	FKM
T	PTFE

Element Part No.

Nominal filtration (μm)	Part no.	Note
1	ES001S-001VX25	O-ring
2	ES001S-002VX25	
5	ES001S-005VX25	
10	ES001S-010VX25	
20	ES001S-020VX25	
40	ES001S-040VX25	
70	ES001S-070VX25	
100	ES001S-100VX25	

Directional Control Valves

Air Cylinders

Rotary Actuators

Air Grippers

Air Preparation Equipment

Modular F. R.

Pressure Control Equipment

Fittings & Tubing

Flow Control Equipment

Pressure Switches/ Pressure Sensors



Series SF □

Specific Product Precautions 1

Be sure to read this before handling.

Refer to page 1382 for Safety Instructions and pages 1064 to 1066 for Air Preparation Equipment Precautions.

Selection

Warning

1. Confirm the specifications.

This product is designed for only general gases such as compressed air or Nitrogen.

Do not use this product with special gases, pressure or temperature beyond the specifications. Otherwise, they could cause damage to the product.

(Refer to the specifications.)

Mounting

Warning

1. Operation manual

Mount the product after reading and understanding the instruction manual. Keep it in a location where it can easily be found.

2. Provide enough space for maintenance.

Provide space for maintenance because the IN/OUT pipes have to be removed when the elements are replaced.

3. Follow the piping instructions on pages 1026 and 1027 when a screw is tightened.

Operating Environment

Warning

1. Do not use the product in a place where corrosive gas, chemicals, brine, water and/or water steam are present or can splash on it.

2. Insulate the product if it is used under direct sunlight.

3. Avoid using the product in a place where vibration or impact can occur.

4. Do not use the product in the vicinity of a heat source or under radiant heat.

Maintenance

Warning

1. Follow the maintenance procedures in the operation manual. If handled incorrectly equipment or device can be damaged or cause a malfunction.

2. Maintenance

Product specifications must be observed, because mishandling compressed air and/or Nitrogen can cause a dangerous situation. Maintenance such as replacing elements has to be performed by a well-experienced and knowledgeable person.

3. Pre-maintenance inspection

When removing the product, turn off the electrical power, and be sure to shut off the supply pressure and exhaust the compressed air in the system. Proceed only after confirming that all pressure has been released to the atmosphere.

Maintenance

Warning

4. Post maintenance inspection

After installation or repair, perform an appropriate function and leakage test.

5. Modification is prohibited.

Do not disassemble or modify the product.

Caution on Design

Caution

1. If the pressure difference (pressure drop) between the inlet and the outlet exceeds 0.1 MPa, it can cause damage to the product.

2. Do not install the product in a place where it can be affected by a pulsation of over 0.1 MPa.

3. Use caution regarding the particles that may be emitted from the outlet side of a pneumatic equipment.

Installation of a pneumatic equipment on the outlet side of the SF□ series can deteriorate the cleanliness because a particle will be generated from the equipment. In the case of installing the pneumatic equipment in the outlet side of the SF□ series, dusts can be generated from the equipment, and the degree of cleanliness can be deteriorated.

The mounting position of the pneumatic equipment needs to be considered depending on the degree of cleanliness of a required operating fluid.

4. Design the system to prevent reverse pressure and reverse flow.

Reverse pressure and reverse flow can damage the element.

5. Design that the piping load should not be applied on the product body.

Mount a bracket for the piping and the other connecting equipment so that the piping load is not applied to the product body.

6. Generally, the following pollutant particles are contained in compressed air, although the degree of cleanliness of the compressed air is different depending on the compressor type and specifications.

[Pollutant particle substances contained in the compressed air]

- Moisture (drainage)
- Dusts and particles which are in the surrounding air
- Deteriorated oil which is discharged from the compressor
- Solid foreign matter such as rust and/or oil in the piping

1) The SF□ series is not compatible with compressed air which contains fluids such as water and/or oil.

2) Install a dryer (IDF, IDG, ID series), mist separator (AM series), micro mist separator (AMD series), super mist separator (AME series), or odor removal filter (AMF series), etc., for the source of the air for the SF□ series.



Series SF □

Specific Product Precautions 2

Be sure to read this before handling.

Refer to page 1382 for Safety Instructions and pages 1064 to 1066 for Air Preparation Equipment Precautions.

Selection

⚠ Warning

1. Thoroughly and carefully confirm the purpose of use, required specifications and operating conditions (fluid, pressure, flow rate and environment) then select a model within the specifications.
2. Contact SMC beforehand when the product will be used in applications such as a caisson shield, and breathing and/or medical treatment that affects the human body directly or indirectly.
3. Determine the product by the maximum consumption flow rate.

When using compressed air for an air blow application, calculate the maximum volume of air that will be consumed before selecting the SF □ series product size. (Using a product which exceeds the maximum air flow and running excessive compressed air can cause the cleanliness of the compressed air to deteriorate and/or its element to be damaged.)

4. Set the air flow capacity with an initial pressure drop of 0.02 MPa or less.
If the initial pressure drop is set to be high, its service life will be shortened due to clogging.

Piping

⚠ Caution

1. Unpacking the sealed package

Since the filter is sealed in an antistatic double bag, the inner package should be unpacked in a clean atmosphere (such as a clean room).

2. Confirm that there is enough space for maintenance before installing and piping this product.
3. Apply a wrench to 2 chamfered flats on the IN side or the OUT side to prevent the housing from rotating.
4. Confirm the IN and the OUT before piping. The product should not be used with the wrong connection.
5. Winding of sealant tape

When screwing together pipes and fittings, etc., confirm that chips from the pipe threads and sealing material do not enter the piping.

Also, when sealant tape is used, leave 1.5 to 2 thread ridges exposed at the end of the threads.

6. Connection

- 1) Rc and NPT connection

Confirm that chips from the pipe threads and sealing material do not enter the piping.

Also, when sealant tape is used, leave 1.5 to 2 thread ridges exposed at the end of the threads.

Piping

⚠ Caution

- 2) TSJ connection

The TSJ fitting is a kind of a self-align fittings. Set it as shown in the figure.

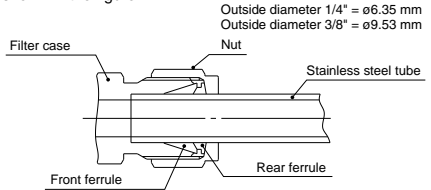

Regarding the TSJ fittings, after tightening the nut by hand, add another 1 1/4 to 1 1/2 turns with a wrench to seal the fitting. In case the fitting is re-installed after filter replacement, first tighten the nut by hand and add another 1/4 to 1/2 turns for sealing. Use the following parts as piping and fittings.

- Piping Outside diameter 1/4" = $\phi 6.35$ mm
Stainless steel tube
or
Outside diameter 3/8" = $\phi 9.53$ mm
Stainless steel tube
 - Nut
 - Front ferrule
 - Rear ferrule
- } Attached to product (2 pcs each)

In the event of replacing the body, a space (20 mm or longer) for extending the stainless steel tubes from the IN and OUT side will be required.

When using similar fittings of other brands, be sure to conduct a helium leak test to confirm there is no leakage before using.

- 3) UOJ fittings

The UOJ fitting is a union type fitting using a O-ring seal. Install it as illustrated below.

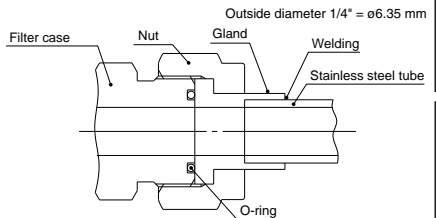

Weld the gland and piping when the fitting is used. At the time of welding, supply inert gas such as Nitrogen to the piping to prevent the formation of an oxide film. Also, remove the oxide film on the external surface through electrolytic polishing or acid cleaning.

After tightening the nut by hand, add another 1/8 turn with a wrench to seal the fitting. Use the following parts for piping and fittings.

- Piping Outside diameter 1/4" = $\phi 6.35$ mm
Stainless steel tube
 - Nut
 - Gland
 - O-ring
- } Attached to product (2 pcs each)



Series SF □

Specific Product Precautions 3

Be sure to read this before handling.

Refer to page 1382 for Safety Instructions and pages 1064 to 1066 for Air Preparation Equipment Precautions.

Piping

⚠ Caution

4) URJ fittings

The URJ fitting is a union type fitting using a metal gasket. Install it as illustrated below.

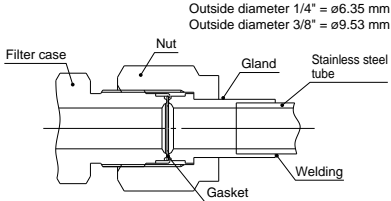

Weld the gland and piping when the fitting is used. At the time of welding, supply inert gas such as Nitrogen to the piping to prevent the formation of an oxide film. Also, remove the oxide film on the external surface through electrolytic polishing or acid cleaning.

After tightening the nut by hand, add another 1/8 turn with a wrench to seal the fitting. Use the following parts for piping and fittings.

<1/4">

- Nut Swagelok® fittings by Swagelok Company VCR female nut (SS-4-VCR-1)
- Gland Swagelok® fittings by Swagelok Company VCR gland (SS-4-VCR-3)
- Gasket Swagelok® fittings by Swagelok Company VCR gasket retainer assembly (SS-4-VCR-2-GR)

<3/8">

- Piping O.D. 3/8" = \varnothing 9.53 mm Stainless steel tube
- Nut Swagelok® fittings by Swagelok Company VCR female nut (SS-8-VCR-1)
- Gland Swagelok® fittings by Swagelok Company VCR gland (SS-6-VCR-3)
- Gasket Swagelok® fittings by Swagelok Company VCR gasket retainer assembly (SS-8-VCR-2-GR)

Be sure to conduct a helium leak test before using similar fittings from other companies.

(Note) Swagelok is a registered trademark of Swagelok Company.

Piping

⚠ Caution

7. Line flushing

Flush the piping line when the filter is used for the first time or has been replaced. In the event of connecting such as piping, flush (air blow) when using this product for the first time or replacing its elements in order to reduce the affect of the dust generated from the connection, etc.

Flushing the line is also required to eliminate contamination resulting from the piping line installation. Therefore, be sure to flush the line before actually running the system.

When general gases (excluding toxic, corrosive and flammable gases) are used after mounting the filter, sufficiently flush the line with a dry inert gas such as Nitrogen gas. This should be followed by a helium leak test on the fittings before actually running the product.

8. Filter replacement (or element replacement)

Release the gas from the piping to reduce the internal pressure to 0.

Also, when Nitrogen gas is used, replace it with dry Nitrogen gas by purging it in advance.

Replace the filter (or cartridge element) when a differential pressure of 0.1 MPa (pressure drop) between IN and OUT is reached and/or when 1 year has elapsed.

9. Filter replacement should be performed according to the operation manual to maintain the filter performance and safety.

The operation manual is contained in the replacement element. However, if the manual is lost, another one can be requested by inquiring to our company.

Fluid

⚠ Warning

1. Do not use the clean gas filter with fluids other than inert gas such as compressed air and Nitrogen gas.

Using this product with fluids other than inert gas such as compressed air and Nitrogen gas can cause damage and leaks in the seals and O-rings, depending on the operating fluid.

Confirm the seal material in the specifications and the compatibility with the operating fluid.



Series SF □

Specific Product Precautions 4

Be sure to read this before handling.

Refer to page 1382 for Safety Instructions and pages 1064 to 1066 for Air Preparation Equipment Precautions.

Operating Environment

Caution

1. When the product is used for blowing, use caution to prevent the workpiece from being damaged by entrained air from the surrounding area.

When the compressed air is used for air blow, the exhausted air from the blow nozzle may have taken in airborne foreign matter (such as solid particle, fluid particle) from the surround air. The foreign matter will be sprayed on the workpiece, and the airborne foreign matter may adhere to it.

Therefore, use caution for the surrounding environment.

Maintenance

1. When the element comes to the end of its life, immediately replace it with a new filter or replacement element (cartridge type).

2. Service life of element

The service life of the element ends when either of the following two conditions occurs.

- 1) After 1 year of usage has elapsed.
- 2) When the pressure drop reaches 0.1 MPa even though the operating period has been less than 1 year.

3. Unpacking the sealed package

Since the filter, as well as the cartridge element (cartridge type) are sealed in an antistatic double bag, the inner package should be unpacked in a clean atmosphere (such as a clean room).

Directional
Control Valves

Air Cylinders

Rotary Actuators

Air Grippers

Air Preparation
Equipment

Modular F. R.

Pressure Control
Equipment

Fittings & Tubing

Flow Control
Equipment

Pressure Switches/
Pressure Sensors

Series SFD Clean Air Filter

Variations



Type		Disposable (non-replaceable element)			Cartridge (replaceable element)				
Flow rate L/min (ANR) (at inlet pressure 0.7 MPa)		Up to 60	Up to 80	Up to 100	Up to 300	Up to 400	Up to 500	Up to 100	
Port size	One-touch fitting	ø4	ø6	ø8	ø8	ø10	ø12	—	
	Female thread	—	—	Rc1/4, G1/4 NPT1/4	—	—	Rc1/4, G1/4 NPT1/4	Rc 1/4, G 1/4, NPT 1/4	
Case material		Resin			Resin			Aluminum	Stainless steel
Fluid		Air (Nitrogen)							
Nominal filtration rating		0.01 μm (filtration efficiency: 99.99%) Note							
Initial pressure drop		0.03 MPa (at inlet pressure 0.7 MPa, maximum flow)							
Maximum operating pressure (at 20°C)		1.0 MPa (in case of nitrogen: 0.99 MPa)							
Operating temperature		5 to 45°C							
Page		Page 1031					Page 1035		

Note) The clean air filter is designed for the filtration of solid objects. It is not suitable for the separation of water and oil.

Series SFD Model Selection

Select the model by using the following procedures involving the inlet pressure and the maximum flow rate.

[Example] Inlet pressure: 0.6 MPa

Maximum flow rate: 100 L/min (ANR)

1. Obtain the intersection A for the inlet pressure and the maximum flow rate by using the maximum flow rate chart.
2. If the obtained intersection A is above the maximum flow rate line, the SFD200-C12, -□02, -C10, or -C08 are selected.

Maximum Flow Rate

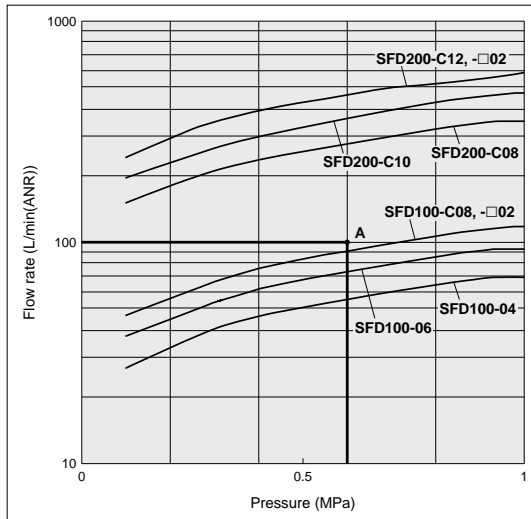

Directional Control Valves

Air Cylinders

Rotary Actuators

Air Grippers

Air Preparation Equipment

Modular F. R.

Pressure Control Equipment

Fittings & Tubing

Flow Control Equipment

Pressure Switches/ Pressure Sensors

How to Order

SFD 1 0 0 - C08 □

Clean air filter

Size

Symbol	Max. flow rate
1	100 L/min (ANR)
2	500 L/min (ANR)

Case material

Symbol	Material
0	Resin
1	Aluminum
2	Stainless steel

Symbol 1 and 2 are made to order. For details, refer to page 1035.

Option

Symbol	Option
NII	None
B	Bracket (SFD100 only)

* The brackets are provided with the SFD200 series as a standard product. (Nil)

Port size

Symbol	Connection size	Note
C04	ø4	SFD100 only
C06	ø6	
C08	ø8	
C10	ø10	SFD200 only
C12	ø12	
02	Rc 1/4	Female thread SFD100/200
N02	NPT 1/4	
F02	G 1/4	



Different diameters for IN and OUT ports are Made to Order. For details, refer to page 1036.

Relationship between Operating Temperature and Max. Operating Pressure

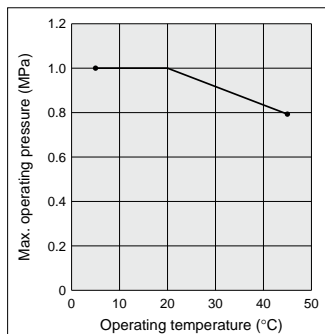

Specifications

Model	SFD10□	SFD20□
Port size	One-touch fittings ø4, ø6, ø8 Rc, NPT, G 1/4	One-touch fittings ø8, ø10, ø12 Rc, NPT, G 1/4
Fluid	Air (Nitrogen)	Air (Nitrogen)
Air flow capacity	Up to 100 L/min (ANR)	Up to 500 L/min (ANR)
Nominal filtration rating ^{Note 1)}	0.01 µm (99.99%)	
Operating pressure range ^{Note 2)}	- 100 kPa to 1.0 MPa (in case of nitrogen: 0.99 MPa)	
Operating temperature	5 to 45°C	
Initial pressure drop	0.03 MPa (at inlet pressure 0.7 MPa, maximum flow)	
Element proof differential pressure ^{Note 3)}	0.5 MPa	
Proof pressure	1.5 MPa	
Element service life	1 year, or when the pressure drop reaches 0.1 MPa.	

Note 1) Measured under SMC's specified conditions.

Note 2) The maximum operating pressure varies depending on temperature. Refer to the graph that shows the relationship between operating temperature and maximum operating pressure on the left.

Note 3) This means that the element does not break at 0.5 MPa. See Specific Product Precautions.

Model	Port size	Rated flow (L/min (ANR)) ^{Note 1)}	Weight
SFD100	ø4 (One-touch fittings)	60	35 g
	ø6 (One-touch fittings)	80	35 g
	ø8 (One-touch fittings)	100	35 g
	Rc, NPT, G 1/4	100	35 g
SFD101 ^{Note 2)}	Rc, NPT, G 1/4	100	60 g
SFD102 ^{Note 2)}	Rc, NPT, G 1/4	100	150 g
SFD200	ø8 (One-touch fittings)	300	190 g
	ø10 (One-touch fittings)	400	190 g
	ø12 (One-touch fittings)	500	190 g
	Rc, NPT, G 1/4	500	260 g

Note 1) The maximum flow rate when the inlet pressure is 0.7 MPa.

Note 2) SFD101 and SFD102 are produced upon receipt of order.

Flow Rate Characteristics

SFD100-C04

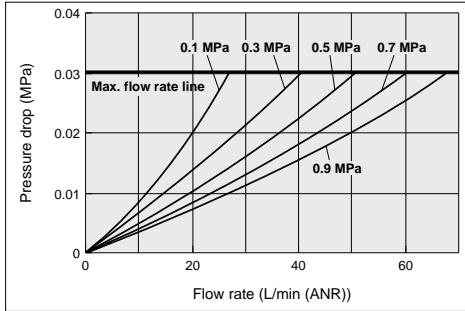

SFD200-C08

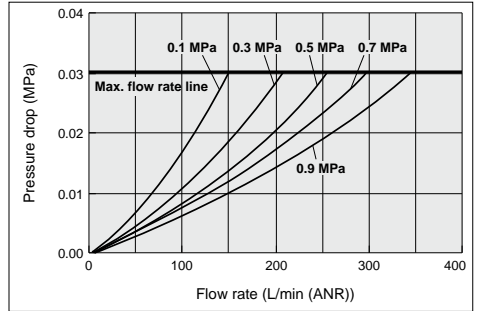

SFD100-C06

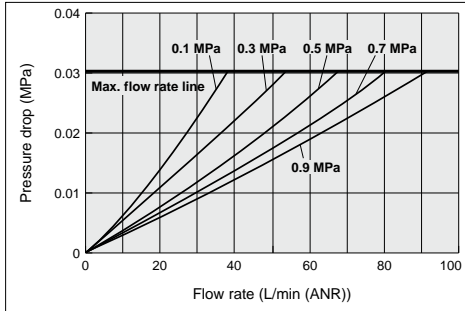

SFD200-C10

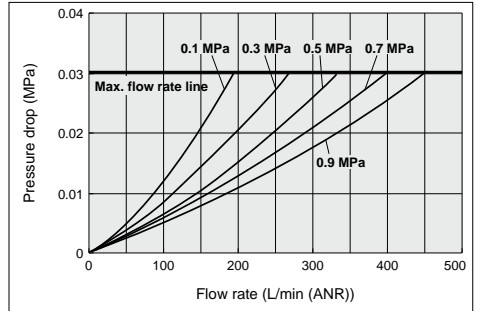

SFD100-C08, -02, -N02, -F02

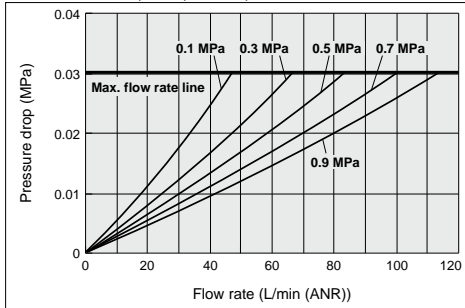

SFD200-C12, -02, -N02, -F02

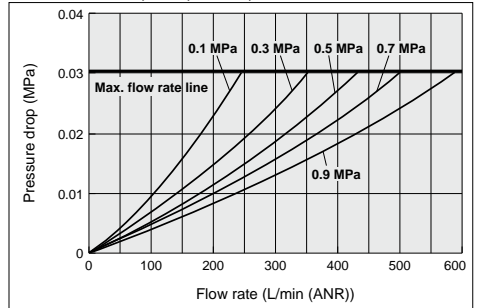

Directional Control Valves

Air Cylinders

Rotary Actuators

Air Grippers

Air Preparation Equipment

Modular F. R.

Pressure Control Equipment

Fittings & Tubing

Flow Control Equipment

Pressure Switches/ Pressure Sensors

Construction

SFD100-C□

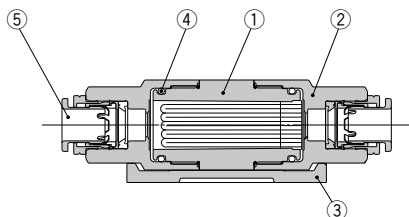

SFD100-□02

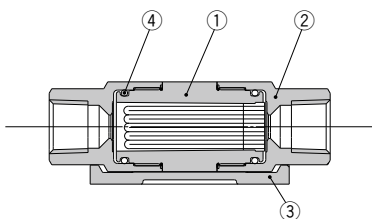

SFD200-C□

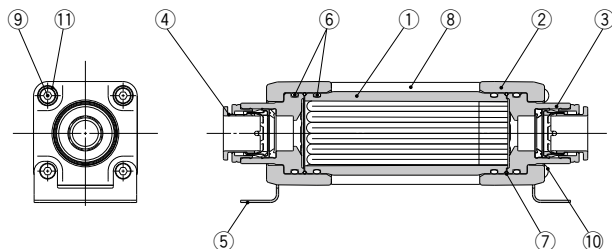

SFD200-□02

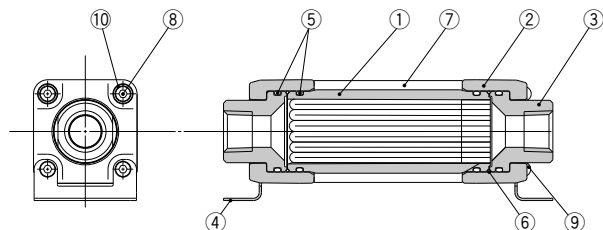

Component Parts

No.	Description	Material	Note
1	Element	PC, Polyolefin, PU, PET, ABS	
2	Cover	PBT	
3	Bracket	PBT	
4	O-ring	H-NBR	
5	Cassette	PP, EPDM, Stainless steel	

Replacement Parts

No.	Description	Material	Note
1	Bracket set	SFD-BR100	With 2 countersunk head screws (M3)

Component Parts

No.	Description	Material	Note
1	Element	PC, Polyolefin, PU, PET, ABS	
2	Cover	PBT	
3	Bracket	PBT	
4	O-ring	H-NBR	

Replacement Parts

No.	Description	Material	Note
1	Bracket set	SFD-BR100	With 2 countersunk head screws (M3)

Component Parts

No.	Description	Material	Note
1	Element	PC, Polyolefin, PU	
2	Cover	Aluminum alloy	
3	Fitting body	PBT	
4	Cassette	PP, EPDM, Stainless steel	
5	Bracket	Stainless steel alloy	
6	O-ring A	H-NBR	
7	O-ring B	H-NBR	
8	Rod cover	Stainless steel alloy	
9	Tie-rod	Stainless steel alloy	
10	Cap nut	Stainless steel alloy	
11	Plain washer	Stainless steel alloy	

Replacement Parts

No.	Description	Material	Note
1	Element set	SFD-EL200	With 3 O-rings

Component Parts

No.	Description	Material	Note
1	Element	PC, Polyolefin, PU	
2	Cover	Aluminum alloy	
3	Fitting body	Stainless steel alloy	
4	Bracket	Stainless steel alloy	
5	O-ring A	H-NBR	
6	O-ring B	H-NBR	
7	Rod cover	Stainless steel alloy	
8	Tie-rod	Stainless steel alloy	
9	Cap nut	Stainless steel alloy	
10	Plain washer	Stainless steel alloy	

Replacement Parts

No.	Description	Material	Note
1	Element set	SFD-EL200	With 3 O-rings

Dimensions

SFD100-C□

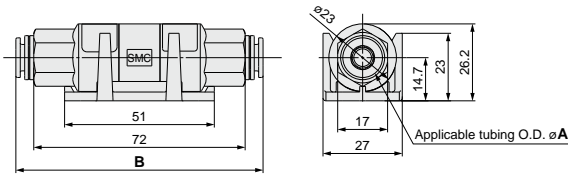

SFD100-C□ Dimensions

Model	A	B	
SFD100-	C04	4	81
	C06	6	81
	C08	8	82

Bracket mounting dimensions

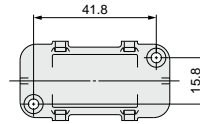

SFD100-□02

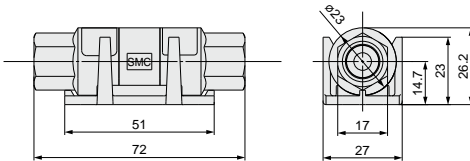

Hole shape for bracket mounting

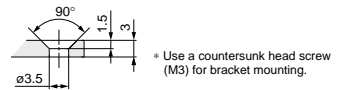

SFD200-C□

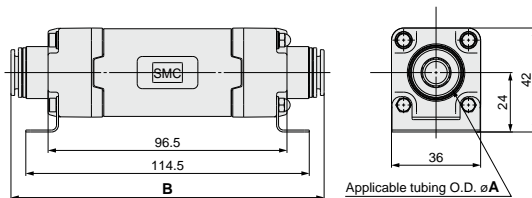

SFD200-C□ Dimensions

Model	A	B	
SFD200-	C08	8	125
	C10	10	126
	C12	12	126

Bracket mounting dimensions

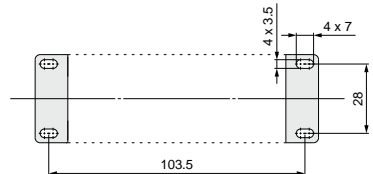

SFD200-□02

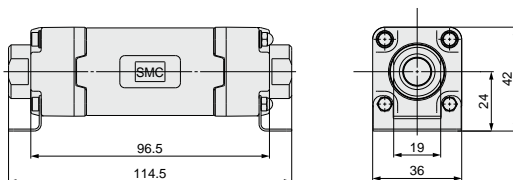

Series SFD Made to Order 1

Contact SMC for detailed specifications, delivery and prices.



1 Metal Case

SFD 10 1 - 02

Clean air filter

Size

Symbol	Max. flow rate
1	100 L/min (ANR)

* The SFD2 is not applicable.

Case material

Symbol	Material
1	Aluminum
2	Stainless steel

Port size

Symbol	Connection size
02	Rc 1/4
N02	NPT 1/4
F02	G 1/4

* The metal case is not available with a clean One-touch fitting.
* The bracket is provided as a standard product.

Metal case suitable for an atmosphere exposed to organic solvents and chemicals



Specifications

The specifications are the same as the standard product. Refer to Specifications on page 1031.

Flow Rate Characteristics

The flow rate characteristics are the same as the SFD100-02. Refer to Flow Rate Characteristics on page 1032.

Construction

SFD101-02

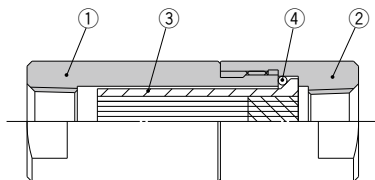

SFD102-02

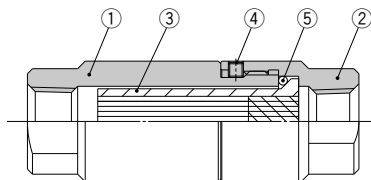

Component Parts

No.	Description	Material	Note
1	Case	Aluminum alloy	
2	Cover	Aluminum alloy	
3	Element	PC, Polyolefin, PU, PET, ABS	
4	O-ring	FKM	

Component Parts

No.	Description	Material	Note
1	Case	Stainless steel alloy	
2	Cover	Stainless steel alloy	
3	Element	PC, Polyolefin, PU, PET, ABS	
4	Hex. socket head set screw	Stainless steel alloy	
5	O-ring	FKM	

Replacement Parts

No.	Description	Part no.	Note
1	Element set	SFD-EL101	With O-ring
2	Bracket	SFD-BR101	Material: Stainless steel 304

Replacement Parts

No.	Description	Part no.	Note
1	Element set	SFD-EL101	With O-ring
2	Bracket	SFD-BR101	Material: Stainless steel 304

Dimensions

SFD101-02

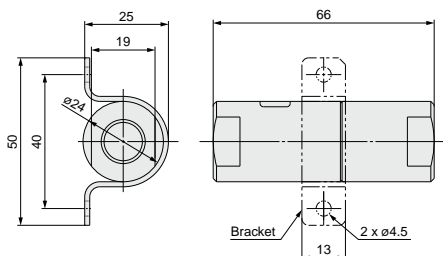

SFD102-02

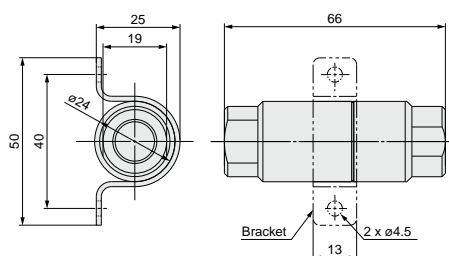

Series SFD Made to Order 2

Contact SMC for detailed specifications, delivery and prices.



2 Different Diameters for IN and OUT Ports

SFD 1 00 - C04 C06

Clean air filter

Size

Symbol	Max. flow rate
1	100 L/min (ANR)
2	500 L/min (ANR)

Case material

Symbol	Material
0	Resin

Option

Symbol	Option
Nil	None
B	Bracket (SFD100 only)

* The brackets are provided with the SFD200 series as a standard product. (Nil)

IN side connection symbol

IN side connection symbol	Connection size
C04	ø4
C06	ø6
C08	ø8
C10	ø10
C12	ø12
02	Rc 1/4
N02	NPT 1/4
F02	G 1/4

Clean One-touch fittings (Series KP)

OUT side connection symbol

OUT side connection symbol	Connection size
C04	ø4
C06	ø6
C08	ø8
C10	ø10
C12	ø12
02	Rc 1/4
N02	NPT 1/4
F02	G 1/4

Clean One-touch fittings (Series KP)

* IN/OUT combination is the below table.

SFD100 Different Diameter Combinations

IN port size	OUT port size					
	C04	C06	C08	02	N02	F02
C04	●	●	—	●	●	●
C06	●	●	—	●	●	●
C08	—	—	●	●	●	●
02	●	●	—	—	—	—
N02	●	●	—	—	—	—
F02	●	●	—	—	—	—

* The symbol "—" stands for unavailable combination.

SFD200 Different Diameter Combinations

IN port size	OUT port size					
	C08	C10	C12	02	N02	F02
C08	●	●	—	●	●	●
C10	●	●	—	●	●	●
C12	—	—	●	●	●	●
02	●	●	—	—	—	—
N02	●	●	—	—	—	—
F02	●	●	—	—	—	—

* The symbol "—" stands for unavailable combination.

Specifications

The specifications are the same as the standard models.

Refer to Specifications on page 1031.

Flow Rate Characteristics

When the IN and OUT ports have different diameters, the flow rate characteristics will be those of the port with the smaller diameter. Refer to Flow Rate Characteristics for the smaller diameter from the chart of standard product on page 1032.

Construction

The construction and materials are the same as the standard product.

Refer to Construction on page 1033.

Dimensions

SFD100 different diameters

One-touch fitting dimensions (A, B)

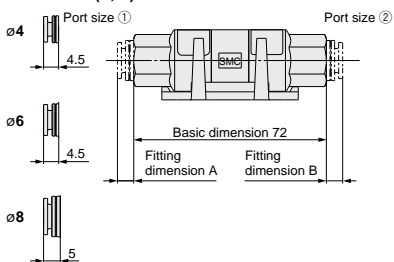

Model	Port size ①	Port size ②	Total length
SFD100-	C04 (C06)	C06 (C04)	81 (A + 72 + B)
	C04 (□02)	□02 (C04)	76.5 (72 + A)
	C06 (C08)	C08 (C06)	81.5 (A + 72 + B)
	C06 (□02)	□02 (C06)	76.5 (72 + A)
	C08 (□02)	□02 (C08)	77 (72 + A)

SFD200 different diameters

One-touch fitting dimensions (A, B)

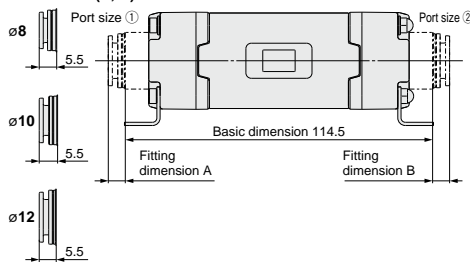

Model	Port size ①	Port size ②	Total length
SFD200-	C08 (C10)	C10 (C08)	125.5 (A + 114.5 + B)
	C08 (□02)	□02 (C08)	120 (114.5 + A)
	C10 (C12)	C12 (C10)	125.5 (A + 114.5 + B)
	C10 (□02)	□02 (C10)	120 (114.5 + A)
	C12 (□02)	□02 (C12)	120 (114.5 + A)

Directional Control Valves

Air Cylinders

Rotary Actuators

Air Grippers

Air Preparation Equipment

Modular F. R.

Pressure Control Equipment

Fittings & Tubing

Flow Control Equipment

Pressure Switches/Pressure Sensors



Series SFD Specific Product Precautions 1

Be sure to read this before handling. Refer to page 1382 for Safety Instructions and pages 1064 to 1066 for Air Preparation Equipment Precautions.

Selection

⚠ Warning

1. Thoroughly and carefully confirm the purpose of use, required specifications and operating conditions (fluid, pressure, flow rate, nominal filtration rating and environment) then select a model within the specifications.
2. The product is not certified under the High Pressure Gas Safety law, so for nitrogen, its maximum operating pressure will be 0.99 MPa (gauge pressure).
3. Contact SMC beforehand if the product will be used in an application such as a caisson shield, breathing, food and/or medical treatment that affects the human body directly or indirectly.
4. If the compressed air includes ozone, do not use it since it may damage the product or cause malfunction. When it includes ozone, use a clean gas filter (SFA/B/C).

Mounting

⚠ Warning

1. **Operation manual**
Mount the product after reading and understanding the operation manual. Keep it in a location where it can easily be found.
2. **Flushing**
Flush the piping line when the filter is used for the first time or has been replaced. In the event of connecting such as piping, flush (air blow) when using this product for the first time or replacing its elements in order to reduce the affect of the dust generated from the connection, etc. Flushing the line is also required to eliminate contamination resulting from the piping line installation. Therefore, be sure to flush the line before actually running the system. Fix all mounting parts for use.
3. **Use fittings with resin threads for the connection of fittings to the IN and OUT ports.**
Using fittings with metal threads could damage the IN and OUT ports.
4. **Connect tubing to the IN and OUT One-touch fittings in accordance with the precautions for One-touch fittings.**

⚠ Caution

1. **Connect the piping in accordance with the flow direction marked on the case.**
If connected in reverse, the element could break.
2. **The mounting orientation does not affect the performance, but if excessive force is applied to the SFD100 series, the body may become disconnected from the bracket.**

Therefore, take particular care about the mounting orientation.

Caution on Installation

⚠ Warning

1. **The material of the element is polycarbonate.**
The material is resistant to wiping with alcohol, but is not suitable for atmospheres or places with organic solvents, chemicals, cutting oils, synthetic oils, ester base compressor oils, alkalis or thread locking agents.

⚠ Caution

1. **If the pressure difference (pressure drop) between the inlet and the outlet exceeds 0.1 MPa, it can cause damage to the product.**

2. **Do not install the product in a place where it can be affected by a pulsation (including surge pressure) of over 0.1 MPa.**

3. **Use caution regarding the particles that may be emitted from the outlet side of a pneumatic equipment.**

Installation of a pneumatic equipment on the outlet side can deteriorate the cleanliness because a particle will be generated from the equipment.

The mounting position of the pneumatic equipment needs to be considered.

4. **Set the air flow capacity with an initial pressure drop of 0.03 MPa or less. If the initial pressure drop is set to be high, its service life will be shorten due to clogging.**

5. **Determine the product by the maximum consumption flow rate.**

When using compressed air for an air blow application, calculate the maximum volume of air that will be consumed before selecting the SFD series product size.

6. **Generally, the following pollutant particles are contained in compressed air.**

[Pollutant particle substances contained in the compressed air]

- Moisture (drainage)
- Dusts and particles which are in the surrounding air
- Deteriorated oil which is discharged from the compressor
- Solid foreign matter such as rust and/or oil in the piping

1) The SFD series is not compatible with compressed air which contains fluids such as water and/or oil.

2) Install a dryer (IDF, IDG, ID series), mist separator (AM series), micro mist separator (AMD series), super mist separator (AME series), or odor removal filter (AMF series), etc., for the source of the air for the SFD series.

7. **Using with a flow rate much higher than its specifications could lead to exceeding the differential pressure the product can resist.**

Use the product within its specifications. Also, take care about the replacement period of the product, taking into consideration that the differential pressure of the filter will increase over time.



Series SFD Specific Product Precautions 2

Be sure to read this before handling. Refer to page 1382 for Safety Instructions and pages 1064 to 1066 for Air Preparation Equipment Precautions.

Piping

⚠ Caution

1. Unpacking the sealed package

Since the filter is sealed in an antistatic double bag, the inner package should be unpacked in a clean atmosphere (such as a clean room).

2. Apply a wrench to 2 chamfered flats or hexagonal portion on the IN side or the OUT side to prevent the housing from rotating.

3. Always tighten threads with the proper tightening torque.

When attaching fittings to the product, tighten with the proper tightening torque shown below.

Material	Tightening torque (N·m)
Resin	2 to 3
Metal	12 to 14

4. Check the arrow mark on the case which shows the flow direction to connect the IN and OUT ports correctly.

If connected in reverse, the element could break.

Maintenance

⚠ Warning

1. Follow the maintenance procedures in the operation manual. If handled incorrectly equipment or device can be damaged or cause a malfunction.
2. When removing the product, exhaust the air and ensure the air is released to atmosphere before removing it.
3. When the element comes to the end of its life, immediately replace it with a new filter or replacement element (cartridge type).

Service life of element

The service life of the element ends when either of the following two conditions occurs.

- 1) After 1 year of usage has elapsed.
- 2) When the pressure drop reaches 0.1 MPa even though the operating period has been less than 1 year.

Operating Environment

⚠ Warning

1. Do not operate under the conditions listed below due to a risk of malfunction.

In locations having corrosive gases, organic solvents, and chemical solutions, or in locations in which these elements are likely to adhere to the equipment.

In locations in which salt water, water, or water vapor could come in contact with the equipment.

In locations that are exposed to direct sunlight. (Shield the equipment from sunlight to prevent its resin material from ultraviolet ray degradation or overheating.)

In locations that have a heat source and poor ventilation. (Shield the equipment from heat sources to protect it from softening degradation due to radiated heat.)

In locations that are exposed to shocks and vibrations.

In locations with high humidity or a large amounts of dust.

2. When the product is used for blowing, use caution to prevent the work from being damaged by entrained air from the surrounding area.

When the compressed air is used for air blow, the exhausted air from the blow nozzle may have taken in airborne foreign matter (such as solid particle, fluid particle) from the surround air. The foreign matter will be sprayed on the work, and the airborne foreign matter may adhere to it. Therefore, use caution for the surrounding environment.

Other Tubing Brands

⚠ Caution

1. When tubing of brands other than SMC's are used, verify that the tubing O.D. satisfies the following accuracy;

- 1) Polyolefin tubing: Within ± 0.1 mm
- 2) Polyurethane tubing: Within $+0.15$ mm, within -0.2 mm
- 3) Nylon tubing: Within ± 0.1 mm
- 4) Soft nylon tubing: Within ± 0.1 mm

Do not use tubing which does not meet these outside diameter tolerances. It may not be possible to connect them, or they may cause other trouble, such as air leakage or the tubing coming out after connection.

The recommended tubing for the clean fitting is polyolefin tubing. Other tubing can satisfy the performance in terms of leakage, tensile strength, etc., but impair the cleanliness. Note this point for use.

Directional Control Valves

Air Cylinders

Rotary Actuators

Air Grippers

Air Preparation Equipment

Modular F. R.

Pressure Control Equipment

Fittings & Tubing

Flow Control Equipment

Pressure Switches/ Pressure Sensors

Series **LLB** Clean Air Module



Note) For CE compliant models, digital flow switch type

How to Order

Port size

1	ø10 One-touch fitting
2	Rc 1/4
2N	NPT 1/4

Note) Use a resin fitting (no metal) for Rc and NPT thread.

Filter

F	With filter
F1	With filter with differential pressure indicator

Standard (100 L/min (ANR))

LLB3 - 1 - [] - [] - [] - [] - F

High flow type (500 L/min (ANR))

LLB4 - 1 - [] - [] - [] - [] - F

Port size

1	ø12 One-touch fitting
3	Rc 3/8
3N	NPT 3/8

Note) Use a resin fitting (no metal) for Rc and NPT thread.

Filter

F	With filter
----------	-------------

Restrictor

Nil	Without restrictor
S	With restrictor

Digital flow switch

Nil	Without digital flow switch
P1	NPN open collector 1 output + Analog output (1 to 5 V)
P2	PNP open collector 1 output + Analog output (1 to 5 V)
P3	NPN open collector 2 outputs
P4	PNP open collector 2 outputs
P5	NPN open collector 1 output + Analog output (4 to 20 mA)
P6	PNP open collector 1 output + Analog output (4 to 20 mA)

ON/OFF valve

Nil	Without ON/OFF valve
V	With air operated
V1	With air operated flow adjuster
V2	Manual operation valve (with lever lock)

Regulator

Nil	Without regulator
R	With regulator
R1	With regulator + Pressure outlet port assembly



LLB3



LLB4

Variations

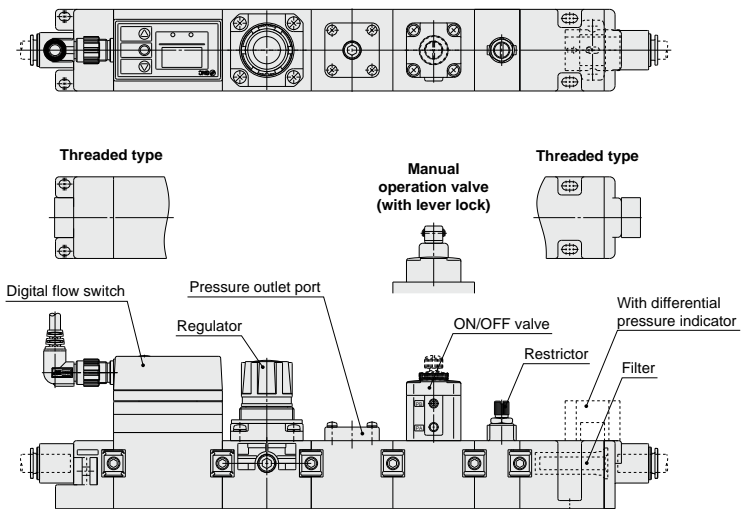

Variations

Flow switch P□	Regulator R	Regulator + Pressure outlet port R1	ON/OFF valve V (V1/V2)	Restrictor S	Filter F (F1)	Weight (kg)	
						LLB3	LLB4
●	—	—	—	—	●	0.36	0.84
●	●	—	—	—	●	0.52	1.18
●	—	—	●	—	●	0.47	1.10
●	—	—	—	●	●	0.41	1.09
●	—	—	●	—	●	0.52	1.35
●	●	—	●	—	●	0.63	1.44
●	—	●	—	●	●	0.57	1.44
●	●	—	—	—	●	0.59	1.36
●	●	—	●	—	●	0.61	1.70
●	—	●	—	●	●	0.57	1.61
●	—	●	●	—	●	0.63	1.62
●	—	●	●	—	●	0.76	1.87
—	●	—	—	—	—	0.33	0.90
—	●	—	—	●	—	0.39	1.15
—	●	—	●	—	●	0.44	1.16
—	●	—	●	●	●	0.50	1.41
—	—	●	—	—	●	0.41	1.07
—	—	●	—	●	●	0.46	1.32
—	—	●	●	—	●	0.52	1.33
—	—	●	●	●	●	0.51	1.71
—	—	—	●	—	●	0.28	0.82
—	—	—	●	●	●	0.34	1.07
—	—	—	—	●	●	0.23	0.81
—	—	—	—	—	●	0.19	0.49

Directional Control Valves

Air Cylinders

Rotary Actuators

Air Grippers

Air Preparation Equipment

Modular F. R.

Pressure Control Equipment

Fittings & Tubing

Flow Control Equipment

Pressure Switches/ Pressure Sensors

Specifications

Model	LLB3	LLB4
-------	------	------

Clean Air Module Common Specifications

Fluid	Clean air, N ₂ gas (Inlet air conditions: equivalent to ISO 8573-1 and Quality Class 1.4.1-1.6.1) <small>(Note 3)</small>	
Maximum operating pressure	0.7 MPa	
Set pressure	0.05 to 0.4 MPa	
Withstand pressure	1.0 MPa	
Fluid temperature	5°C to 45°C (No freezing)	
Ambient temperature	* The guaranteed display of digital flow switch ranges between 15 to 35°C.	
Flow range <small>Note 1)</small>	5 to 100 L/min (ANR)	50 to 500 L/min (ANR)
Nominal filtration rating <small>Note 2)</small>	0.01 μm (Filtration efficiency 99.99%)	
Fluid contact space	Grease-free, Silicone-free	
Material	Body	PBT
	Module connection seal	FKM
	One-touch fitting seal	EPDM

Note 1) The maximum flow rate varies depending on set pressure. Refer to Flow Rate Characteristics for detail.

Note 2) According to SMC measurement conditions.

Note 3) Refer to page 1049 Operating Environment.

Digital Flow Switch Unit Specifications

Detection type	Heat type			
Measured flow range	5 to 100 L/min	50 to 500 L/min		
Smallest settable increment	1 L/min	5 L/min		
Accumulated pulse flow rate exchange value (Pulse width: 50 [ms])	1 L/pulse	5 L/pulse		
Accumulated flow range	0 to 999999 L			
Linearity	±5% F.S. or less (15 to 35°C: Based on 25°C)			
Repeatability	±2% F.S. or less			
Temperature characteristics	±5% F.S. or less (15 to 35°C: Based on 25°C)			
Specifications	Switch output	Maximum load current	NPN or PNP open collector output 80 mA	
		Maximum applied voltage	30 VDC (at NPN output)	
		Internal voltage drop	NPN output: 1 V or less (at 80 mA), PNP output: 1.5 V or less (at 80 mA)	
	Analog output	Voltage output	Output voltage	1 to 5 V
			Allowable load resistance	100 kΩ or more
		Current output	Output current	4 to 20 mA
		Allowable load resistance	300 Ω or less (12 VDC), 600 Ω or less (24 VDC)	
Status LED's	Lights up when output is turned ON, OUT1: Green; OUT2: Red (OUT1 only for analog output)			
Response time	1 s or less			
Power supply voltage	12 to 24 VDC (Ripple ±10% or less)			
Current consumption	160 mA or less	170 mA or less		
Withstand voltage	1000 VAC for 1 min. between external terminal and case			
Insulation resistance	50 MΩ or more (500 VDC measured via megohmmeter) between external terminal and case			
Noise resistance	1000 Vp-p, Pulse width 1 μs, Rise time 1 ns			
Lead wire	Lead wire with connector			
Enclosure	IP65			
Fluid contact space material	Mesh	Stainless steel		
	Sensor housing	PBT		
	Sensor	Lead glass (exempted from the RoHS application)		
		PtIr		
		FeNi		

Regulator Unit Specifications

Relief mechanism	Non-relief	
Fluid contact space material	Diaphragm	FKM

ON/OFF Valve Unit Specifications

Pilot pressure (ON/OFF valve operating pressure)	0.4 to 0.5 MPa	
Back pressure	0.4 MPa or less	
Valve type	N.C.	
Orifice size	4 mm	8 mm
Cv factor	0.35	1.7
Fluid contact space material	Diaphragm	PTFE
Valve leakage	1 cm ³ /min (ANR) or less	

Specifications

Model		LLB3	LLB4
Restrictor Unit Specifications			
Cv factor		0.28	1.4
Number of needle rotations		8 rotations	10 rotations
Fluid contact space material	Needle	Stainless steel	
Filter Unit Specifications			
Normal filtration rating <small>Note 1)</small>		0.01 μm (Filtration efficiency 99.99%)	
Element withstand differential pressure <small>Note 2)</small>		0.5 MPa	
Flow capacity		Up to 100 L/min (ANR)	Up to 500 L/min (ANR)
Fluid contact space material	Filter case	PC	
	Hollow fiber	PP	
	Potting	PU	

Note 1) According to SMC measurement conditions.

Note 2) This means that the element will not break at 0.5 MPa. Refer to Installation of Specific Product Precautions prior to use.

Component Parts

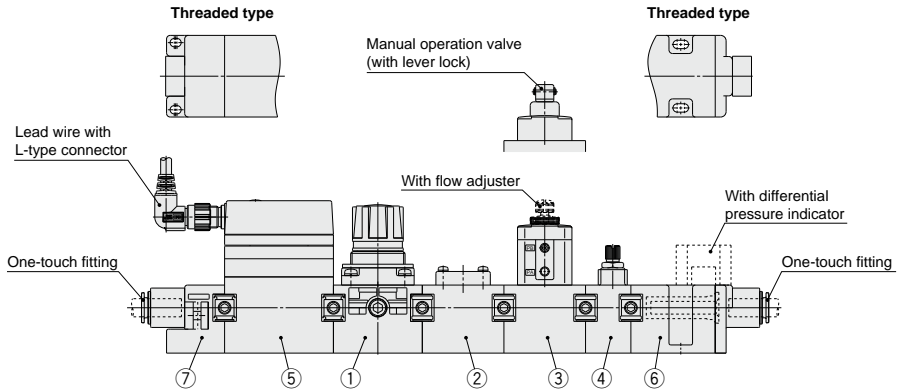

No.	Description	Individual part no.		Note
		LLB3	LLB4	
1	Clean regulator assembly	—	LVB3-1 LVB4-1	—
2	Pressure outlet port assembly	—	LVB3-2 LVB4-2	—
3	ON/OFF valve assembly/ Air operated valve	Without flow adjuster	LVB2-3 LVB4-3	—
	ON/OFF valve assembly/Manual operation valve	With flow adjuster	LVB2-3-1 LVB4-3-1	—
4	Restrictor assembly	—	LVB2-4 LVB4-4	—
5	Digital flow switch assembly	5 to 100 L/min	LVB3-6□	—
		50 to 500 L/min	—	LVB4-6□
6	Clean air filter assembly	With ø10 One-touch fitting	LVB3-7-2	LVB4-7 (Filter body only)
		Rc 1/4	LVB3-7-3	
		NPT 1/4	LVB3-7-4	
		With ø10 One-touch fitting, with differential pressure indicator	LVB3-7-2-1	—
		Rc 1/4, with differential pressure indicator	LVB3-7-3-1	
		NPT 1/4, with differential pressure indicator	LVB3-7-4-1	
		Replacement element	SFD-EL101	
7	End plate assembly	With ø10 One-touch fitting	LVB3-8-2	—
		Rc 1/4	LVB3-8-3	—
		NPT 1/4	LVB3-8-4	—
		With ø12 One-touch fitting	—	LVB4-8-1
		Rc 3/8	—	LVB4-8-2
		NPT 3/8	—	LVB4-8-3

* Each module has 2 connecting brackets.

Flow Rate Characteristics

LLB3-1-P1R1VSF: Standard (100 L/min)

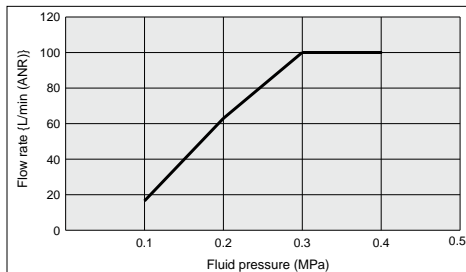
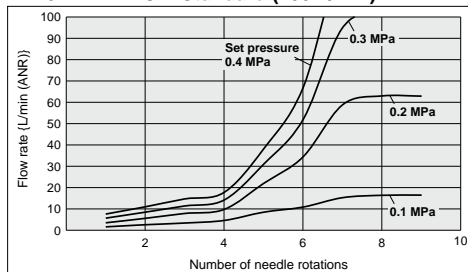

LLB4-1-P1R1VSF: High Flow Type (500 L/min)

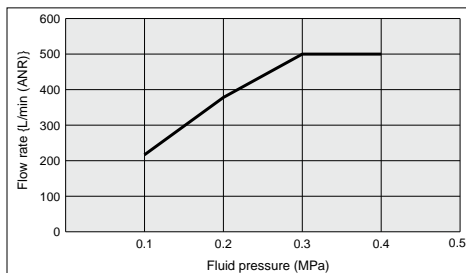
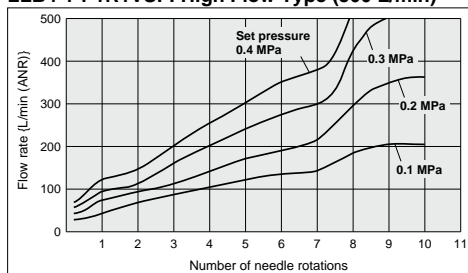

<Test Conditions>

Model: LLB3-1-P1R1VSF and LLB4-1-P1R1VSF

Supplied pressure: 0.5 MPa

Pressure setting condition and measured position: Pressure is set by turning the regulator knob with ON/OFF valve turned off.

Pressure is measured at the pressure outlet port.

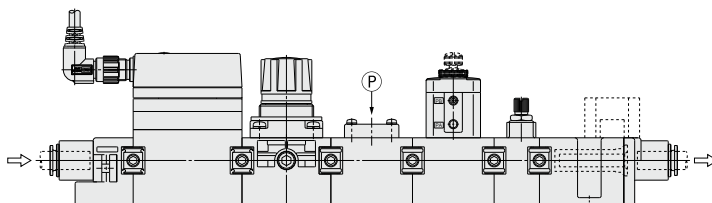

Digital Flow Switch Output Specifications

• Analog output

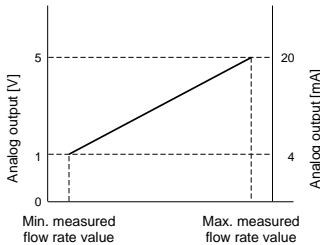

Flow Rate Range by Type

Model	Normal condition (L/min) [nor]		Standard condition (L/min) [ANR]	
	Minimum measured flow rate range	Maximum measured flow rate range	Minimum measured flow rate range	Maximum measured flow rate range
LLB3	5	100	5	107
LLB4	50	500	55	535

• Connector pin numbers

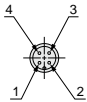

Pin no.	Pin description
1	DC (+)
2	Analog output
3	DC (-)
4	OUT1

• Internal circuits and wiring examples

NPN open collector 2 outputs

LLB□-□-P3□□□F (F1)

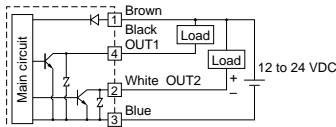

Max. 30 V, 80 mA
Internal voltage drop 1 V or less

NPN open collector 2 outputs

LLB□-□-P4□□□F (F1)

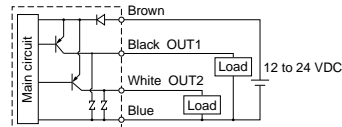

Max. 80 mA
Internal voltage drop 1.5 V or less

NPN open collector 1 output + Analog output

LLB□-□-P1 P5□□□F (F1)

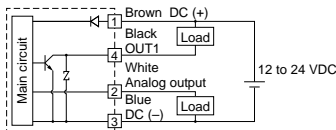

P1: Analog output 1 to 5 V
Allowable load resistance 100 kΩ or more
P5: Analog output 4 to 20 mA
Allowable load resistance 300 Ω or less (12 VDC),
600 Ω or less (24 VDC)

NPN open collector 1 output + Analog output

LLB□-□-P2 P6□□□F (F1)

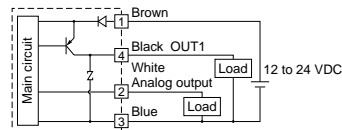

P2: Analog output 1 to 5 V
Allowable load resistance 100 kΩ or more
P6: Analog output 4 to 20 mA
Allowable load resistance 300 Ω or less (12 VDC),
600 Ω or less (24 VDC)

Directional Control Valves
 Air Cylinders
 Rotary Actuators
 Air Grippers
 Air Preparation Equipment
 Modular F. R.
 Pressure Control Equipment
 Fittings & Tubing
 Flow Control Equipment
 Pressure Switches/ Pressure Sensors

Functions

Flow rate selection display

Real-time flow rate and accumulated flow rate can be selected. Up to 999999 of flow rate value can be accumulated. The accumulated flow rate is reset when power is turned off.

Flow rate conversion

Normal condition {0°C, 101.3 kPa, Dry air} or standard condition (ANR) {20°C, 101.3 kPa, 65% RH} can be selected.

Flow rate confirmation display

This function allows the accumulated flow rate confirmation when real-time flow rate is selected, and the real-time flow rate confirmation when accumulated flow rate is selected.

Key lock

This function prevents incorrect operations such as changing the set value accidentally.

Error correction

LED display	Contents	Solution
Er1	A current of more than 80 mA is flowing to OUT1	Check the load and wiring for OUT1.
Er2	A current of more than 80 mA is flowing to OUT2.	Check the load and wiring for OUT2.
Er4	The setting data has changed for whatever reasons.	Perform the RESET operation, and reset all data again. If the setting does not return to the factory setting, inspection needs to be performed by SMC.
---	The flow rate is over the flow rate measurement range.	Reduce the flow rate until it is within the flow rate measurement range, using an adjustment valve.

Output types

Real-time switch output, accumulated switch output, or accumulated pulse output can be selected as an output type.

Real-time switch output

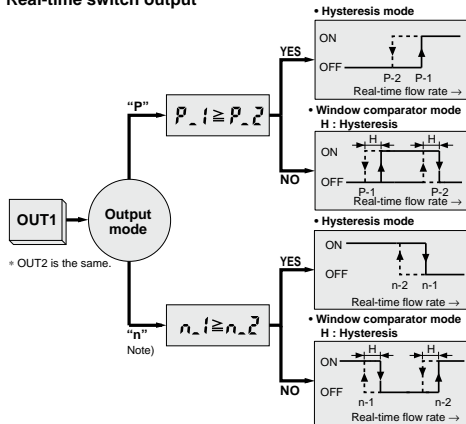

Accumulated switch output

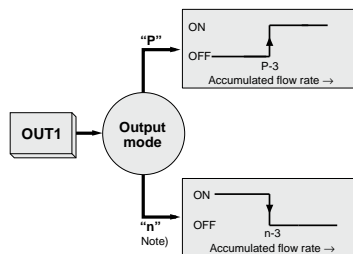

Accumulated pulse output

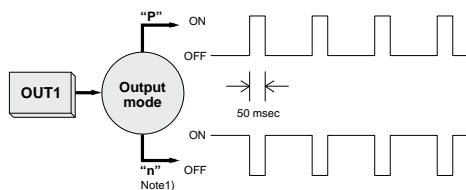

Dimensions

LLB3-1-P□R□V□SF

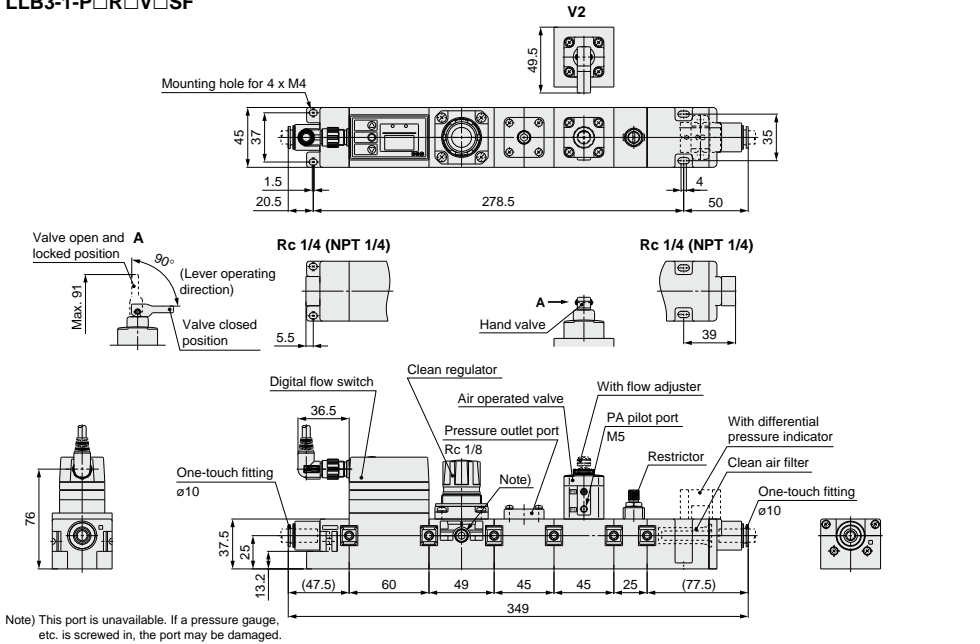

LLB4-1-P□R□V□SF

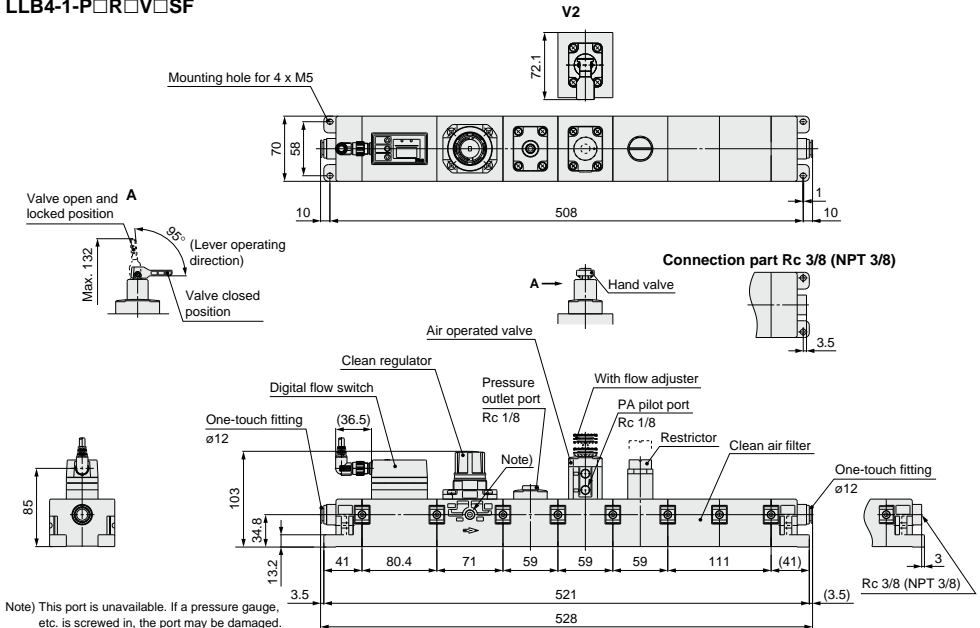

Directional Control Valves

Air Cylinders

Rotary Actuators

Air Grippers

Air Preparation Equipment

Modular F. R.

Pressure Control Equipment

Fittings & Tubing

Flow Control Equipment

Pressure Switches/Pressure Sensors

Additional Module Procedure

LLB3

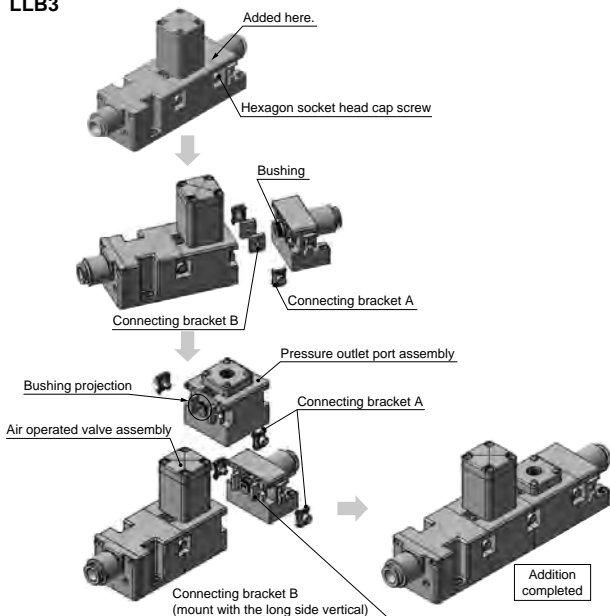

Example: Addition of the pressure outlet port assembly (LVB3-2)

- ① Loosen two hexagon socket head cap screws at the position where the clean air module is added, and remove the connecting bracket A.
- ② After removing the connecting bracket A, separate the forward and backward blocks from each other.
Note) Do not lose the connecting bracket A.
- ③ Check that the connecting brackets B (at two positions) are attached, and insert the bushing projection of the pressure outlet port assembly into the indent of the air operated valve assembly. Similarly, insert the end plate assembly into the pressure outlet port assembly.
- ④ Mount the connecting bracket A, and tighten the hexagon socket head cap screw with the following torque.
Tightening torque: 1.0 to 1.4 N·m

LLB4

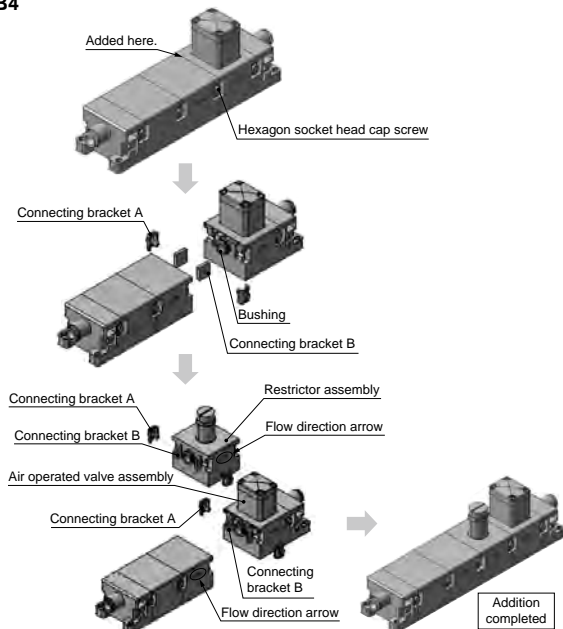

Example: Addition of the restrictor assembly (LVB4-4)

- ① Loosen two hexagon socket head cap screws at the position where the clean air module is added, and remove the connecting bracket A.
- ② After removing the connecting bracket A, separate the forward and backward blocks from each other.
Note) Do not lose the connecting bracket A.
- ③ Check that the connecting brackets B (at two positions) are attached, and assemble the restrictor assembly on the groove of the block with care as to the direction of the restrictor assembly. Similarly, connect the air operated valve assembly to the restrictor assembly.
Note) The arrow on the module and the arrow on the block must point in the same direction.
- ④ Mount the connecting bracket A, and tighten the hexagon socket head cap screw with the following torque.
Tightening torque: 1.6 to 2.0 N·m

Element Replacing Procedure

LLB3

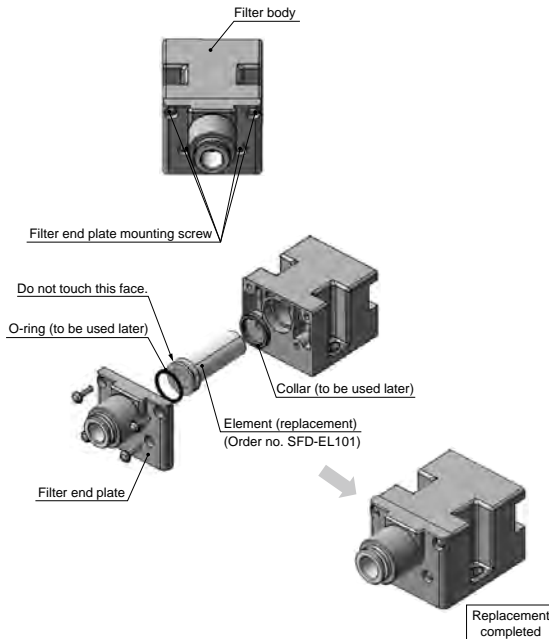

- ① Loosen the four filter end plate mounting screws on the clean air module.
- ② After removing the filter end plate, take out the element.
Note) Do not lose the collar and O-ring.
- ③ Assemble a new element on the filter body.
- ④ Mount the filter end plate, and tighten the screws with the following torque.
Tighten the screws diagonally so that torque can be given to the screws evenly.
Tightening torque: 0.45 to 0.55 N·m
- ⑤ After replacing the elements, flush air before operation.

LLB4

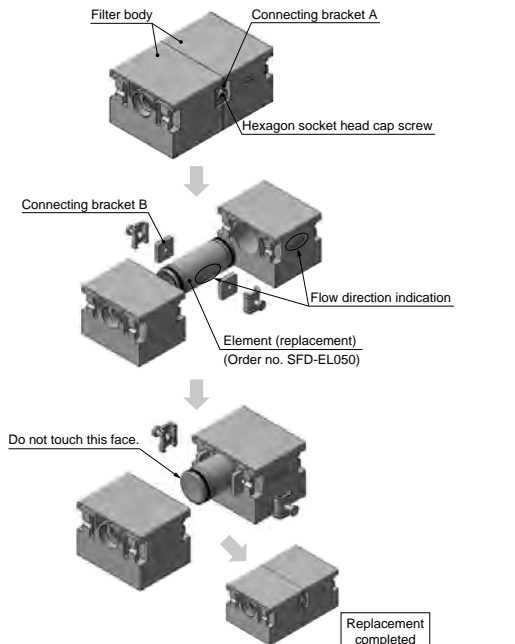

- ① Remove the clean air filter from the clean air module.
* Refer to the additional module procedure on page 1047 for removal.
- ② Loosen two hexagon socket head cap screws and remove the connecting bracket A.
- ③ After removing the connecting bracket A, open the filter body, and take out the element.
Note) Do not lose the connecting bracket.
- ④ Assemble a new element on the filter body.
Note) The arrow on the element and the arrow in the filter body must point in the same direction.
- ⑤ Check that two connecting brackets B are attached to the filter body, and assemble the filter body to the groove of the block.
- ⑥ Mount the connecting bracket A on the assembled filter body, and tighten the hexagon socket head cap screw with the following torque.
Tightening torque: 1.6 to 2.0 N·m
- ⑦ After replacing the elements, flush air before operation.



Series LLB Clean Air Module / Precautions 1

Be sure to read this before handling. Refer to page 1382 for Safety Instructions and pages 1064 to 1066 for Air Preparation Equipment Precautions.

Design and Selection

⚠ Warning

1. Confirm the specifications.

Give careful consideration to the operating conditions such as the application, fluid and environment, and use within the operating ranges specified in this catalog.

2. Ensure sufficient space for maintenance activities.

Provide space required for maintenance.

3. Fluid pressure range

Supplied fluid pressure must be within the operating pressure range specified in the catalog.

Mounting

⚠ Warning

1. If air leakage increases or equipment does not operate properly, stop operation.

After mounting is completed, confirm that it has been done correctly by performing a suitable function test and leakage test.

Operating Environment

⚠ Warning

1. Do not operate under the conditions listed below due to a risk of malfunction.

In locations having corrosive gases, organic solvents, and chemicals, or in locations in which these elements are likely to adhere to the equipment.

In locations in which salt water, water, or water vapor could come in contact with the equipment.

In locations that are exposed to direct sunlight. (Shield the equipment from sunlight to prevent its resin material from ultraviolet ray degradation or overheating.)

In locations that have a heat source and poor ventilation. (Shield the equipment from heat sources to protect it from softening degradation due to radiated heat.)

In locations that are exposed to shocks and vibrations.

In locations with high humidity or a large amounts of dust.

2. When the product is used for blowing, use caution to prevent the workpiece from being damaged by entrained air from the surrounding area.

When the compressed air is used for air blow, the exhausted air from the blow nozzle may have taken in airborne foreign matter (such as solid particle, fluid particle) from the surrounding air. The foreign matter will be sprayed on the workpiece, and the airborne foreign matter may adhere to it. Therefore, use caution for the surrounding environment.

Recommended Pneumatic Circuit

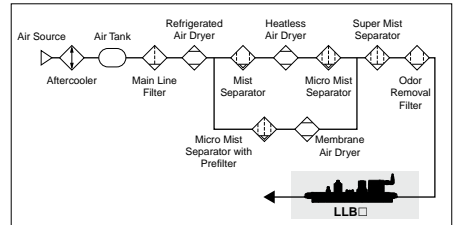

3. ISO compressed air quality class

The class regarding the cleanliness of compressed air (solid particles, moisture and oil) stipulated by ISO 8573-1:1991 (JIS B8392-1:2000)

Quality class	Maximum particle size (μm)	Minimum pressure dew point (°C)	Maximum oil concentration (mg/m ³)
1	0.1	-70	0.01
2	1	-40	0.1
3	5	-20	1.0
4	15	3	5
5	40	7	25
6	—	10	—

Notation system

Example) Solid particle size: 0.1 μm

Pressure dew point: 3°C

Oil concentration: 0.1 mg/m³

With the above conditions, notation of the quality class is 1, 4, 2.



Series LLB Clean Air Module / Precautions 2

Be sure to read this before handling. Refer to page 1382 for Safety Instructions and pages 1064 to 1066 for Air Preparation Equipment Precautions.

Piping

⚠ Caution

1. Preparation before piping

Before piping is connected, it should be thoroughly flushed out with air or washed to remove chips, cutting oil and other debris from inside the pipe.

Install piping so that it does not apply pulling, pressing, bending or other forces on the module unit.

2. Be certain that sealing material does not enter the piping.

When connecting pipes, fittings, etc., be sure that chips from the pipe threads and sealing material do not enter the module. Any dust or scale residing in the piping can cause malfunction or failure. Furthermore, when pipe tape is used, leave 1.5 to 2 thread ridges exposed at the end of the threads.

3. Use fittings with resin threads for the connection of fittings to the IN and OUT ports.

Using fittings with metal threads could damage the ports.

Tightening Torque for Thread

Size	Release torque (N·m)	Tightening torque (N·m)	Tightening guide (Thread rotation number)
LLB3	2 to 3	0.5 to 1	2 to 3 rotations
LLB4	8 to 9	2 to 3	3 to 4 rotations

4. Connect tubing to the IN and OUT One-touch fittings in accordance with the precautions for One-touch fittings.

Other Tubing Brands

⚠ Caution

1. When tubing of brands other than SMC's are used, verify that the tubing O.D. satisfies the following accuracy;

- 1) Polyolefin tubing: Within ± 0.1 mm
- 2) Polyurethane tubing: Within $+0.15$ mm, within -0.2 mm
- 3) Nylon tubing: Within ± 0.1 mm
- 4) Soft nylon tubing: Within ± 0.1 mm

Do not use tubing which does not meet these outside diameter tolerances. It may not be possible to connect them, or they may cause other trouble, such as air leakage or the tubing coming out after connection.

The recommended tubing for the clean fitting is polyolefin tubing. Other tubing can satisfy the performance in terms of leakage, tensile strength, etc., but impair the cleanliness. Note this point for use.

Directional Control Valves

Air Cylinders

Rotary Actuators

Air Grippers

Air Preparation Equipment

Modular F. R.

Pressure Control Equipment

Fittings & Tubing

Flow Control Equipment

Pressure Switches/ Pressure Sensors



Series LLB Specific Product Precautions 1

Be sure to read this before handling. Refer to page 1382 for Safety Instructions and pages 1064 to 1066 for Air Preparation Equipment Precautions.

Precautions on Digital Flow Switch

Design and Selection

⚠ Warning

1. Operate the switch only within the specified voltage.

Use of the switch outside the range of the specified voltage can cause not only malfunction and damage of the switch but also electrocution and fire.

2. Do not exceed the maximum allowable load specification.

A load exceeding the maximum load specification can cause damage to the switch.

3. Do not use a load that generates surge voltage.

Although surge protection is installed in the circuit at the output side of the switch, damage may still occur if a surge is applied repeatedly. When a surge generating a load such as a relay or solenoid is directly driven, use a type of switch with a built-in surge absorbing element.

4. The switch does not have explosion proof structure, so do not use flammable gas. Otherwise, fire may occur.

5. Monitor the internal voltage drop of the switch.

When operating below a specified voltage, it is possible that the load may be ineffective even though the pressure switch function is normal. Therefore, the formula below should be satisfied after confirming the minimum operating voltage of the load.

$$\frac{\text{Supply voltage}}{\text{Internal voltage drop of switch}} > \frac{\text{Minimum operating voltage of load}}{\text{Minimum operating voltage of load}}$$

6. Use the switch within the specified flow rate measurement and operating pressure.

Operating beyond the specified flow rate and operating pressure can damage the switch.

⚠ Caution

1. Data of the flow switch will be stored even after the power is turned off.

Input data will be stored in EEPROM so that the data will not be lost after the flow switch is turned off. (Data can be rewritten for up to one million times, and data will be stored for up to 20 years.)

2. The accumulated flow rate is reset when power is turned off.

Mounting

⚠ Warning

1. Hold the body of the switch when handling.

The tensile strength of the lead wire with connector is 49N. Applying a greater pulling force on it can cause a malfunction. When handling, hold the body of the switch – do not dangle it from the wire.

2. Do not use until you can verify that equipment can operate properly.

Following mounting, repair, or retrofit, conduct suitable function tests after piping and power connections have been made.

3. Never mount a switch in a place that will be used as a scaffold during piping.

Damage may occur if an excessive load is applied to the switch.

Mounting

⚠ Warning

4. Be sure to allow straight pipe length that is minimum 8 times the port size for the inlet side of the switch piping.

When abruptly reducing the size of piping or when there is a restriction such as a valve on the inlet side, the pressure distribution in the piping changes and makes accurate measurement impossible.

Wiring

⚠ Warning

1. Verify the color and terminal number when wiring.

Incorrect wiring can cause the switch to be damaged and malfunction. Verify the color and the terminal number in the instruction manual when wiring.

2. Avoid repeatedly bending or stretching the lead wire.

Repeatedly applying bending stress or stretching force to the lead wire will cause it to break.

3. Confirm proper insulation of wiring.

Make sure that there is no faulty wiring insulation (contact with other circuits, ground fault, improper insulation between terminals, etc.). Damage may occur due to excess current flow into a switch.

4. Do not wire in conjunction with power lines or high voltage lines.

Wire separately from power lines and high voltage lines, avoiding wiring in the same conduit with these lines. Control circuits including switches may malfunction due to noise from these other lines.

5. Do not allow loads to short circuit.

Although switches indicate excess current error if loads are short circuited, all incorrect wiring connections (power supply polarity, etc.) cannot be protected. Take precautions to avoid incorrect wiring.

Operating Environment

⚠ Warning

1. Never use in the presence of explosive gases.

The switches do not have an explosion proof rating. Never use in the presence of an explosive gas as this may cause a serious explosion.

2. Mount switches in locations where there is no vibration greater than 98 m/s², or impact greater than 490 m/s².

3. Do not use in an area where surges are generated.

When there are units that generate a large amount of surge in the area around pressure switches, (e.g., solenoid type lifters, high frequency induction furnaces, motors, etc.) this may cause deterioration or damage to the switches' internal circuitry. Avoid sources of surge generation and crossed lines.



Series LLB Specific Product Precautions 2

Be sure to read this before handling. Refer to page 1382 for Safety Instructions and pages 1064 to 1066 for Air Preparation Equipment Precautions.

Precautions on Digital Flow Switch

Operating Environment

⚠ Warning

- Switches are not equipped with surge protection against lightning.

Flow switches are CE compliant; however, they are not equipped with surge protection against lightning. Lightning surge protection measures should be applied directly to system components as necessary.

- Avoid using switches in an environment where the likelihood of splashing or spraying of liquids exists.

Switches are dustproof and splashproof; however, avoid using in an environment where the likelihood of heavy splashing or spraying of liquids exists.

- Use the switch within the specified fluid and ambient temperature range.

The fluid temperature and ambient temperature ranges are 5 to 45°C, but the accuracy warranted range is 15 to 35°C. Take measures to prevent frozen fluid when using in low temperatures, since this may cause damage to the switch and lead to a malfunction. The installation of an air dryer is recommended to eliminate condensate and moisture. Never use the switch in an environment where there are drastic temperature changes even when these temperatures are within the specified temperature range.

Maintenance

⚠ Warning

- Perform periodical inspections to ensure proper operation of the switch.

Unexpected malfunctions may cause possible danger.

- Take precautions when using the switch for an interlock circuit.

When a pressure switch is used for an interlock circuit, devise a multiple interlock system to prevent trouble or malfunctioning, verify the operation of the switch and interlock function on a regular basis.

- Do not make any modifications to the product.

Measured Fluid

⚠ Warning

- The fluids that the switch can measure accurately are nitrogen and clean air.

Please note that accuracy cannot be guaranteed when other fluids are used.

- Never use flammable fluids.

The flow velocity sensor heats up to approximately 150°C.

Others

⚠ Warning

- Since switch output remains OFF while a message is displayed after the power is turned on, start measurement after a value is displayed.

- Perform settings after stopping control systems.

When the switch's initial setting and flow rate setting are performed, output maintains the condition prior to the settings.

- Do not apply excessive rotational force to the display unit.

The integrated type display unit can rotate 90°. If more rotation is required, a separate display unit is available as special order.

- Be certain to turn on the power when the flow rate is at zero.

Allow an interval of 10 minutes after turning on the power, as there are some changes in the display.

- Flow rate unit

Switch measures at mass flow rates without being influenced by temperature and pressure. The switches use L/min as the flow rate indicator unit, in which the volumetric flow is substituted for mass flow at 0°C and 101.3 kPa (NOR). The volumetric flow rate at 20°C, 101.3 kPa, and 65%RH (ANR) can be displayed.

Detection Principle of Digital Flow Switch for Air

A heated thermistor is installed in the passage, and fluid absorbs heat from the thermistor as it is introduced to the passage. The thermistor's resistance value increases as it loses heat. Since the resistance value increase ratio has a uniform relationship to the fluid velocity, the fluid velocity can be detected by measuring the resistance value. To further compensate the fluid and ambient temperature, the temperature sensor is also built into the switch to allow stable measurement within the operating temperature range.

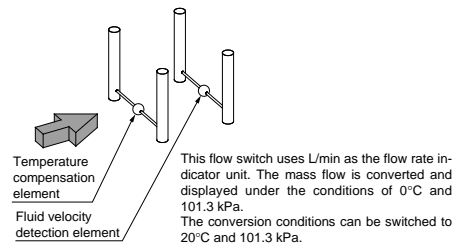

Directional Control Valves

Air Cylinders

Rotary Actuators

Air Grippers

Air Preparation Equipment

Modular F. R.

Pressure Control Equipment

Fittings & Tubing

Flow Control Equipment

Pressure Switches/ Pressure Sensors



Series LLB Specific Product Precautions 3

Be sure to read this before handling. Refer to page 1382 for Safety Instructions and pages 1064 to 1066 for Air Preparation Equipment Precautions.

Precautions on Regulator

Pressure Adjustment

⚠ Warning

1. Do not use any tool to operate the pressure regulator knob.

Using a tool to operate the pressure regulator knob may cause breakage. Operate the knob by hand.

⚠ Caution

1. Adjust pressure after unlocking the pressure regulator knob.

If the pressure regulator knob does not rotate, it is locked. Pull up on the pressure regulator knob once to unlock it. Rotating the knob forcibly may break the knob.

After adjusting pressure, lock the knob. Press down on the knob to lock.

2. Adjust pressure by increasing the pressure.

If pressure is adjusted by decreasing the pressure, pressure cannot be set correctly. Rotating the knob clockwise increases the outlet pressure, and rotating the knob counterclockwise decreases the pressure.

3. As this is a non-relief type regulator, rotating the knob counterclockwise does not decrease pressure.

The non-relief type regulator does not decrease outlet pressure even if it is rotated counterclockwise unless the fluid at the outlet side is consumed.

If the knob is rotated forcibly, the knob may break.

If pressure setting is too high, consume fluid at the outlet side once to decrease the outlet pressure to the necessary set pressure or less, and set the pressure again.

4. Check the inlet pressure.

The setting of the outlet pressure should be 85% or less of the inlet pressure. If the inlet pressure is low, pressure cannot be set correctly.

5. Do not operate fluid which contains solid matter.

Otherwise, this may cause malfunction.

6. Oscillation (beat) may occur with some operating conditions even if the operation is within specification. Contact SMC for that case.

Precautions on ON/OFF Valve

Precautions

⚠ Warning

1. The maximum operating pressure and back pressure must be within the specified range.

⚠ Caution

1. Valve leakage

Valve leakage of 1 cm³/min or less (at pneumatic pressure) can happen when shipped from factory.

2. Product with flow adjuster can cause oscillation with some operating conditions if operating flow rate is very small, so examine the flow rate, pressure, and piping conditions carefully before operating.

3. For flow adjustment with flow adjuster, adjust the flow rate by opening the knob gradually from the fully closed state.

Turning the adjusting knob counterclockwise opens the valve. Do not apply excessive force to the knob around the fully open or closed state. Otherwise, the orifice seat can be deformed or the adjusting knob screw can be broken. It is fully closed when shipped from factory.

4. Have a trial run before operation if the valve is not used for long periods of time.

5. Pay attention to the lever operating direction and handling of the lever.

Piping

⚠ Caution

1. Tighten with the tightening torque below for pilot port.

Tightening Torque for Operating Port

Operating port	Torque (N·m)
M5	After tightening by hand, tighten additional 1/6 rotation with a tightening tool.
Rc, NPT 1/8	0.8 to 1.0

2. Use the pilot ports and sensor (respiration) port as follows.

	PA port	PB port	Sensor (respiration) port
N.C.	Pressurization	Respiration	Respiration
N.O.	Respiration	Pressurization	Respiration
Double acting	Pressurization	Pressurization	Respiration

For N.C. and N.O. type, the port which is not pressurized should be open to atmosphere. If air intake to and exhaust from the valve is not preferable due to ambient atmosphere or dust, install piping to the valve so that the valve can intake/exhaust air at the proper place.

Air Supply for Operation

⚠ Warning

1. Use clean air.

If the compressed air is contaminated with chemicals, synthetic oil including organic solvent, salt, corrosive gas, etc., it may lead to the breakdown or malfunction of the equipment.



Series LLB Specific Product Precautions 4

Be sure to read this before handling. Refer to page 1382 for Safety Instructions and pages 1064 to 1066 for Air Preparation Equipment Precautions.

Precautions on Restrictor

Precautions

⚠ Warning

1. Restrictor cannot be used as a stop valve, which requires zero leakage. It is tolerant to some extent of leakage as a specification.

2. Check the number of rotations of the needle valve.
It does not rotate further because it has a drop-out prevention mechanism. Check the number of needle rotations. Rotating the needle too much may cause damage.

Precautions on Filter

Installation

⚠ Warning

1. Air equipment which is mounted on the outlet side may generate dust.
If air equipment is installed on the outlet side, the equipment may generate dust, and it will be a factor to deteriorate cleanliness. Examine the position to install air equipment.
2. Set operating flow rate within the specified range.
[Specified range]
LLB3: 100 L/min (ANR) or less
LLB4: 500 L/min (ANR) or less
If the operating flow rate is out of the specified range, it will cause functional deterioration and breakage.
3. The filter should be installed in a place where pulsation does not occur.
4. This product cannot operate compressed air which contains fluid such as water and oil.

- For the air source for this product, install a dryer, mist separator, micro mist separator, super mist separator, odor removal filter, etc.
- Generally, compressed air contains following particle contaminants:
[Example of particle contaminants contained in compressed air]
 - Moisture (Condensate)
 - Dust in atmospheric air
 - Deteriorated oil exhausted from the compressor
 - Solid foreign matter such as rust or oil in the piping

5. Flush air into the piping for cleaning before installing the product.

To decrease the affect of dust from a connection, also flush air into the piping before using the product for the first time and when replaced.

Maintenance

⚠ Warning

1. When removing the product, exhaust the air and ensure the air is released to atmosphere before removing it.
2. When the element comes to the end of its life, immediately replace it with a new filter or replacement element.

Service life of element

- 1) After 1 year of usage has elapsed.
- 2) When the set flow rate is not achieved even if it has been less than 1 year since operation started.

Operating Environment

⚠ Warning

1. Do not operate under the conditions listed below due to a risk of malfunction.
 - In locations having corrosive gases, organic solvents, and chemicals, or in locations in which these elements are likely to adhere to the equipment.
 - In locations in which salt water, water, or water vapor could come in contact with the equipment.
 - In locations that are exposed to direct sunlight. (Shield the equipment from sunlight to prevent its resin material from ultraviolet ray degradation or overheating.)
 - In locations that have a heat source and poor ventilation. (Shield the equipment from heat sources to protect it from softening degradation due to radiated heat.)
 - In locations that are exposed to shocks and vibrations.
 - In locations with high humidity or a large amounts of dust.
2. When the product is used for blowing, use caution to prevent the work from being damaged by entrained air from the surrounding area.

When the compressed air is used for air blow, the exhausted air from the blow nozzle may have taken in airborne foreign matter (such as solid particle, fluid particle) from the surround air. The foreign matter will be sprayed on the work, and the airborne foreign matter may adhere to it. Therefore, use caution for the surrounding environment.

Directional Control Valves

Air Cylinders

Rotary Actuators

Air Grippers

Air Preparation Equipment

Modular F. R.

Pressure Control Equipment

Fittings & Tubing

Flow Control Equipment

Pressure Switches/ Pressure Sensors

An exhaust cleaner that can be used inside a clean room

Exhaust air cleanliness: Equivalent to ISO Class 5 (ISO 14644-1)

(Consult SMC in advance, as this will differ depending on the operating conditions.)

- **Particles of 0.3 μm or larger are 3.5 particles/L or less**

Since it is possible to release exhaust air from pneumatic equipment directly into a clean room, piping to exhaust ducts is unnecessary.

Worry free two stage element construction

- **After the first element is saturated with oil, the oil flowing into the secondary side is collected by the second element. This prevents discharge to the outside for a fixed time.**



How to Order

AMP 2 2 0- 03 -

Body size

Symbol	Size
2	1/4 standard
3	3/8 standard
4	1/2 standard

Element construction

Symbol	Stage
2	2 stage

Thread type

Symbol	Type
Nil	Rc
N	NPT
F	G

Optional

Symbol	Description
Nil	None
R	Flow direction Right→Down
T	With element service indicator

Accessories

Symbol	Name
Nil	None
B	With bracket

Note) The brackets are shipped together, but not assembled.

Port size

Symbol	Port size	Body size		
		2	3	4
02	1/4	●	—	—
03	3/8	●	●	—
04	1/2	—	●	●
06	3/4	—	—	●

Models

Model	AMP220	AMP320	AMP420
Maximum flow capacity (L/min (ANR))	200	500	1000
Port size	1/4, 3/8	3/8, 1/2	1/2, 3/4
Weight (kg)	0.43	0.68	1.15

Refer to page 1058 for the model selection.

Specifications

Fluid	Compressed air
Upstream pressure	0.1 MPa or less
Ambient and fluid temperature	5 to 50°C
Filtration degree	0.01 μm (Trapping efficiency 95%)
Cleanliness class (ISO class)	Class 3
Downstream cleanliness	ISO class 5 (ISO 14644-1) (3.5 particles or less/L (ANR))
Element replacement period	· One year from first use or when back pressure reached 0.1 MPa · When the system fails to operate normally due to clogging
Element replacement period indication (saturated with oil)	Element color indication
Element construction	Two stage element
Silencing effect	40 dB (A) or more

Refer to page 1059 for the specific product precautions.

Accessories

Applicable model	AMP220	AMP320	AMP420
Bracket assembly (With body mounting bolt)	BM66	BM67	BM68

Construction

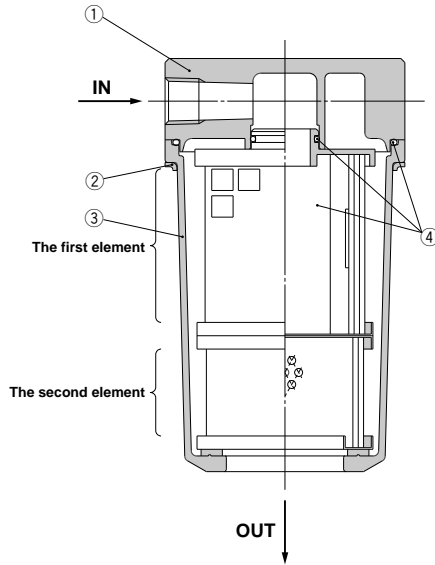

Parts list

No.	Description	Material	Note
1	Body	Aluminum alloy	Inner/outer surface coating
2	Ring	Stainless steel	
3	Case	Resin	

Replacement parts

No.	Description	Part number			Note
		AMP220	AMP320	AMP420	
4	Element assembly	AMP-EL220	AMP-EL320	AMP-EL420	With O-ring

Note) The first and second elements are integrated, and cannot be replaced separately.

Directional Control Valves

Air Cylinders

Rotary Actuators

Air Grippers

Air Preparation Equipment

Modular F. R.

Pressure Control Equipment

Fittings & Tubing

Flow Control Equipment

Pressure Switches/ Pressure Sensors

Dimensions

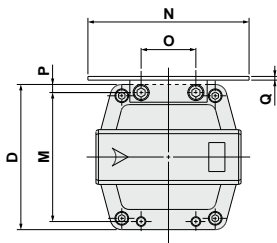

Optional specifications

T: With element service indicator

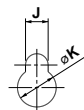
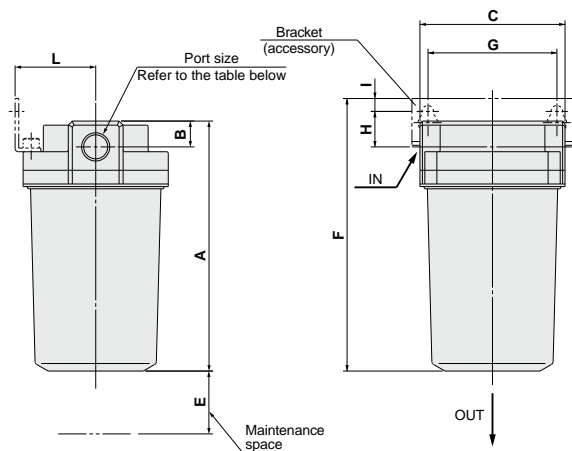
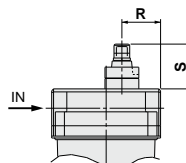

Bracket mounting hole

Model	Applicable screw
AMP220	M5 hexagon socket head cap screw
AMP320	M6 hexagon socket head cap screw
AMP420	M8 hexagon socket head cap screw

Model	Port size	A	B	C	D	E	Bracket related dimensions												Element service indicator related dimensions	
							F	G	H	I	J	K	L	M	N	O	P	Q	R	S
AMP220	1/4, 3/8	108	13	76	76	80	123	66	20	8	6	10	40	66	84	28	5	2	27.2	37
AMP320	3/8, 1/2	155.5	16	90	90	120	169	80	22	8	7	12	50	80	100	34	5	2.3	32.2	37
AMP420	1/2, 3/4	221.5	19	106	106	180	237.5	90	25	10	10	15	55	88	110	50	9	3.2	36.7	37

(mm)



Series AMP Model Selection

Selection

⚠ Caution

1. When selecting an exhaust cleaner, refer to the selection method shown below, as the selection method will differ for exhaust from actuator drive systems, etc., and exhaust from ejectors, etc.

(Take note that an exhaust flow rate exceeding that of the model selected can cause a drop in exhaust air cleanliness, reduced performance of drive equipment and ejectors, etc., and damage to the element.)

2. Exhaust from drive systems

1. Find the air flow required for the actuator to be used. When operating with common piping, add up the required air flow for all actuators that will be operated simultaneously and find the maximum air flow.
2. Select a model such that the maximum required air flow obtained in (1) does not exceed the maximum flow rate line of the exhaust cleaner.

3. Exhaust from ejectors, etc.

1. In case of ejectors or other equipment whose performance can be affected by back pressure on the exhaust air, confirm the range in which the equipment will not be affected by back pressure.
2. In the case of ejectors, the exhaust flow rate is the total of the maximum suction flow rate and the air consumption. Since the method of calculating the exhaust flow rate differs in this way depending on the equipment, confirm this in the catalog or operation manual of the equipment to be used.
3. When operating with common piping, add up the exhaust flow rates for all equipment that will be exhausted simultaneously and find the maximum exhaust flow rate.
4. Find the upstream pressure in the flow characteristic graph, using the maximum exhaust flow rate obtained in (3) as the exhaust flow rate. Select a model such that the upstream pressure is lower than the back pressure generated when the exhaust flow rate is at a maximum.

Flow characteristic graph (Representative value)

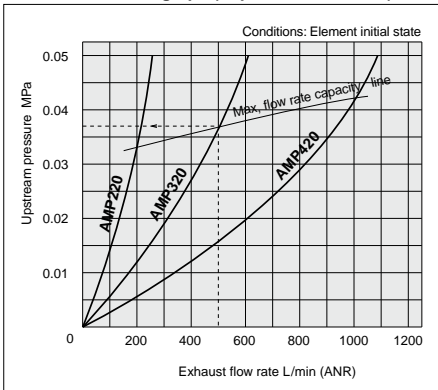

Viewing the graph: When using AMP320 at a flow rate of 500 L/min, the upstream pressure is 0.037 MPa.

⚠ Caution

4. Exhaust flow speed characteristics are shown in graph 2.

1. Operate giving consideration to the effects of turbulence on dust, etc., that has settled on the floor or other areas.
2. In cases where there is concern about the effect of turbulence on dust, install in a location where dust will not be affected.

Exhaust flow speed (Representative value)

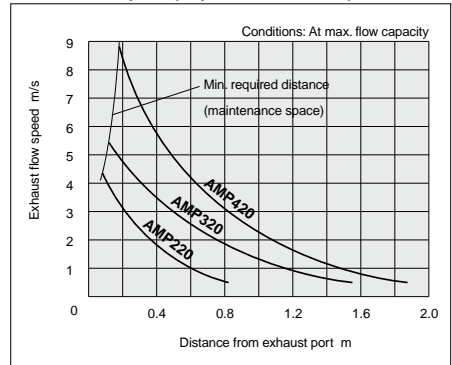

<Measurement>

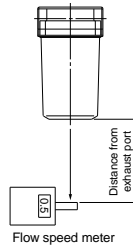

Directional Control Valves

Air Cylinders

Rotary Actuators

Air Grippers

Air Preparation Equipment

Modular F. R.

Pressure Control Equipment

Fittings & Tubing

Flow Control Equipment

Pressure Switches/ Pressure Sensors



Series AMP Specific Product Precautions

Be sure to read this before handling. Refer to page 1382 for Safety Instructions and pages 1064 to 1066 for Air Preparation Equipment Precautions.

Mounting

Caution

1. Air piping should be thoroughly flushed before mounting.
2. When piping and fittings, etc. are being screwed together, take care that chips from the pipe threads, sealing material and other debris do not get inside the piping.
Further, when sealant tape is used, leave 1.5 to 2 thread ridges exposed at the end of the threads.
3. Mount the unit vertically. Furthermore, when mounting is performed, the case section (resin) will be damaged if it is held while screwing in piping, etc. Screw in piping while holding the upper body area (aluminum die-cast) with a wrench or other tool.
4. In cases such as common piping, reverse flow may occur depending on the timing for switching of solenoid valves, etc. In this situation, install a check valve on the upstream side.
5. Ensure the necessary space for maintenance and inspections. (Confirm with the dimensions on page 1057.)

Operating Environment

Warning

1. Do not use in environments or locations where there is a danger of the case or element service indicator (optional specification: T) being penetrated.
2. Since the case material is nylon, avoid use in environments with chemicals such as alcohol, thinner, carbon tetrachloride, chloroform, aniline, cyclohexane, trichloroethylene, sulfuric acid, lactic acid, water soluble cutting oil (alkaline), etc.
Furthermore, use a neutral detergent for cleaning the case.
3. Do not use in locations where static electric charge will be a problem.
4. Block off heat from nearby heat sources.

If heat sources are located nearby, the temperature of the product may rise above the operating temperature range due to radiated heat. Block off this heat with a cover, etc.

Supply Air

Caution

1. The product cannot be used with air containing water droplets.
2. Install a mist separator (series AM), micro mist separator (series AMD), or micro mist separator with pre-filter (series AMH) on the air supply side.
3. When using ejectors, etc., do not allow liquids such as water or oil to be drawn in with the air.

Maintenance

Caution

1. Replace the element after one year of use, or when the upstream pressure reaches 0.1 MPa even if one year has not elapsed.

If operation is continued without replacing the element, the cleanliness of the exhaust air will decline.

When replacing the element, also install a new O-ring.

(When equipped with an element service indicator (optional specification: T), the condition of the element can be easily confirmed.)

2. When saturated with oil, red dots appear on the surface of the first element. Check it once a day and replace it immediately with a new element when red dots appear.

If operation is continued after red dots have appeared, the second element will also be saturated with oil, and oil mist imbued with red dye will be mixed with the exhaust air, contaminating the surrounding air.

Operation in a Clean Room

Caution

1. Open the inner bag of the double packaging in a clean room or other clean environment.
2. In a down flow area, mount with the exhaust port facing downward.
3. Avoid mounting in locations where exhaust air will blow directly on work pieces, etc.
4. Confirm the exhaust flow speed, and operate giving consideration to the effect of turbulence on dust, etc., in a clean room.

How to Order



Male thread type

SFE 11

◆ Size/Port size
Male thread type

Symbol	Port size	Max. flow capacity L/min (ANR)
11	M5 x 0.8	3
42	R1/8	65
52	R1/8	130
53	R1/4	130
73	R1/4	200

Plug-in type

Symbol	Port size	Max. flow capacity L/min (ANR)
3A	ø4	30
4B	ø6	65
5C	ø8	130
7D	ø10	200



Plug-in type

One-touch fitting type

Symbol	Applicable tubing O.D.	Max. flow capacity L/min (ANR)
3F	ø4	30
4G	ø6	65
5H	ø8	130
7J	ø10	200



One-touch fitting type

Bracket

SFE-BR 3

Symbol	Applicable model
3	SFE3□
4	SFE4□
5	SFE5□
7	SFE7□



Specifications

Model	SFE11	SFE3□	SFE4□	SFE5□	SFE7□
Fluid ^{Note 1)}	Air				
Maximum flow capacity ^{Note 2)}	Up to 3 L/min (ANR)	Up to 30 L/min (ANR)	Up to 65 L/min (ANR)	Up to 130 L/min (ANR)	Up to 200 L/min (ANR)
Filtration rating ^{Note 3)}	0.01 μm (Trapping efficiency 99.99%)				
Noise reduction ^{Note 3)}	30 dB (A)				
Operating temperature	5 to 45°C				
Differential pressure proof ^{Note 4)} (Maximum operating pressure)	0.1 MPa				
Material ^{Note 5)}	PBT, Polyolefin, Polyurethane, PP*, Stainless steel*, EPDM (Fluoro coated)*				
Body	PBT, Polyolefin, Polyurethane, PP*, Stainless steel*, EPDM (Fluoro coated)*				
Gasket	NBR, Stainless steel				
Weight					
Male thread	1 g	—	7 g	12 g	17 g
Plug-in	—	3 g	6 g	11 g	16 g
One-touch fitting	—	5.5 g	8 g	16 g	24 g
Bracket weight	—	1.2 g	2.5 g	3.5 g	5.5 g
Applicable tubing material ^{Note 6)} (One-touch fitting type)	—	PFA, Polyolefin, Soft polyolefin, Polyurethane			
Replacement period	· 2 years or when back pressure reached 0.1 MPa · When the system fails to operate normally due to clogging				
Packaging	Antistatic double packaging processes				

Note 1) Do not use this product in air containing ozone, since it may break.

Note 2) Model should be selected based on the flow capacity. (Refer to the **WEB catalog**.)

Note 3) Based on SMC's measuring conditions.

Note 4) Pressure applied to SFE, and not supply pressure to the equipment that SFE is mounted to (e.g. solenoid valve, cylinder).

Note 5) The materials with an asterisk (*) are used for the One-touch fitting type only.

Note 6) Due to the softness of polyurethane tubing, it may fold when being inserted. Hold the end of the tubing and insert it all the way in.

Dimensions

SFE11

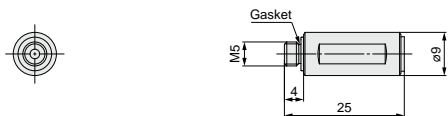

SFE42/52/53/73

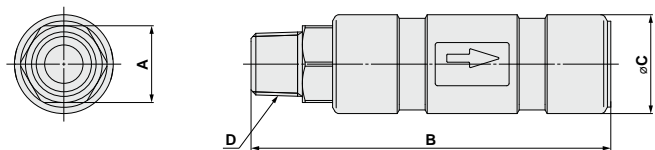

Dimensions (mm)

Model	A	B	C	D
SFE42	10	62	16.5	R1/8
SFE52	10	71	20.5	R1/8
SFE53	17	75	20.5	R1/4
SFE73	17	84	24	R1/4

SFE3A

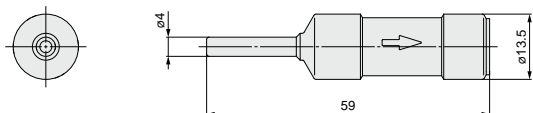

SFE4B/5C/7D

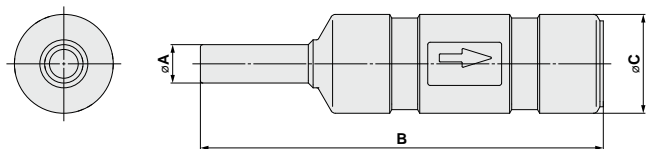

Dimensions (mm)

Model	A	B	C
SFE4B	6	73	16.5
SFE5C	8	84	20.5
SFE7D	10	94	24

Dimensions

SFE3F

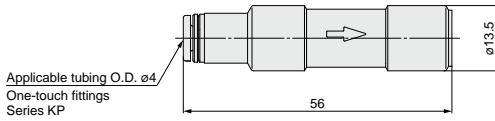

SFE4G/5H/7J

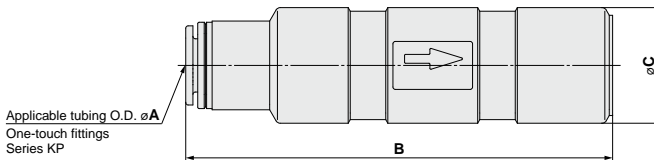

Dimensions (mm)

Model	A	B	C
SFE4G	6	68.5	16.5
SFE5H	8	79	20.5
SFE7J	10	89	24

Bracket

SFE-BR3



SFE-BR4/5/7

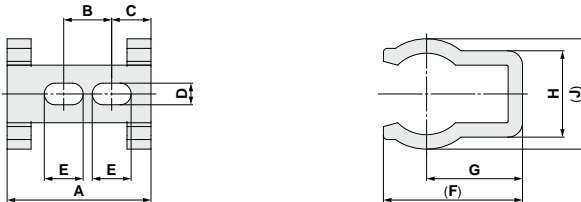

Dimensions

Model	A	B	C	D	E	F	G	H	J
SFE-BR4	30	16	7	4.5	7.5	(24.5)	17	15.5	(19.5)
SFE-BR5	30	10	8.2	4.5	8.1	(29)	20	18	(23)
SFE-BR7	34	14	7.35	4.5	9.8	(35)	24	20	(27.3)

(): Reference dimensions

Directional Control Valves
Air Cylinders
Rotary Actuators
Air Grippers
Air Preparation Equipment
Modular F. R.
Pressure Control Equipment
Fittings & Tubing
Flow Control Equipment
Pressure Switches/ Pressure Sensors



Series SFE Specific Product Precautions

Be sure to read this before handling. Refer to page 1382 for Safety Instructions and pages 1064 to 1066 for Air Preparation Equipment Precautions.

Selection

⚠ Warning

1. Thoroughly and carefully confirm the purpose of use, required specifications and operating conditions (fluid, pressure, flow rate, filtration rating, and environment), then select a model within the specifications.
2. Do not use this product for any purposes that may adversely influence, directly or indirectly, the human body such as for food or medical applications.
3. Do not use air which contains ozone, as it will cause damage to the product.

Mounting

⚠ Caution

1. Flush and clean the piping before connecting it to the product.
2. Do not apply excessive force to the product.
Install piping so that it does not apply pulling, pressing, bending or other forces on the products.
Tighten the screws by hand, and then apply a wrench to the wrench flats to tighten the screw for additional 1 to 2 rotations. For the model with the M-thread, tighten the tip of the main body securely by hand until it is in contact with the end face, and then retighten it by hand. At this time, note that the retightening amount should be 30° or less. (Tighten it with 0.2 N·m or less.)
3. Do not mount the product in a place where dust will be stirred up by the exhaust air from the product and affect peripheral equipment.
4. Do not mount the product in a location where air from the product will be directly exhausted to the workpiece.
5. If installing the products to valve ports, interference may occur with the fittings. Please confirm the dimensions before installing.

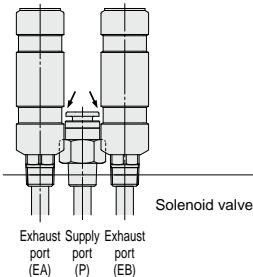

Fig. Example of the interference with fittings

Supply Air

⚠ Caution

1. The product cannot be used with air containing water droplets.
2. Install a mist separator (Series AM), micro mist separator (Series AMD), or micro mist separator with pre-filter (Series AMH) on the air supply side.

Supply Air

⚠ Caution

3. When using on the ejector etc., do not allow liquids such as water or oil to be drawn in with the air.

Operating Environment

⚠ Warning

1. Do not operate under the conditions listed below due to a risk of malfunction.
 - 1) In locations having ozone, corrosive gases, organic solvents, and chemical solutions, or in locations in which these elements are likely to adhere to the equipment.
 - 2) In locations in which sea water, water, or water steam could come in contact with the equipment.
 - 3) Where the product is exposed to ultraviolet rays or temperature increase.
 - 4) Where the product is exposed to heat sources or in areas that the product is exposed to radiant heat.
 - 5) In locations that are exposed to direct sunlight.
 - 6) In locations that are exposed to shocks and vibrations.

Maintenance

⚠ Warning

1. Replace the product with a new one right away when it reaches its life.
Make sure to verify the operating conditions of the actuator at least once a day.
— Criteria of the product's life —
The service life of the product ends when either of the following two conditions occurs.
 - 1) After 2 years of usage has elapsed.
 - 2) When the back pressure of the SFE reaches 0.1 MPa even though the operating period has been less than 2 years.
 - 3) When the system fails to operate normally due to clogging.

Handling of One-touch Fitting Type

⚠ Caution

1. Clean One-touch fittings (Series KP) are used for the One-touch fitting type. Grease is not used due to the KP series oil-free specifications. For this reason, a greater insertion force is required when the tube is installed. In particular, polyurethane tubing may fold when inserted due to its softness. Hold the end of the tubing, and insert it all the way in slowly and securely.
2. The outside diameter of tubes that have been used at high temperatures or for long periods of time will expand, and in some cases pipe fittings cannot be reattached. Tubes that cannot be attached should be discarded and replaced with new ones.
3. Refer to the precautions of the KP series for handling.



Air Preparation Equipment Precautions 1

Be sure to read this before handling.

Design/Selection

⚠ Warning

1. Confirm the specifications.

Products represented in this catalog are designed only for use in compressed air systems (including vacuum).

Do not operate at pressures or temperatures, etc., beyond the range of specifications, as this can cause damage or malfunction. (Refer to the specifications.)

Please contact SMC when using a fluid other than compressed air (including vacuum).

We do not guarantee against any damage if the product is used outside of the specification range.

2. To select equipment first, thoroughly verify the purpose, specification requirements, and the operating conditions such as pressure, flow rate, temperature, environment, and power supply. Then, make a selection based on the latest catalog, making sure not to exceed the specification ranges. If something is not clear, please contact SMC before making a selection.

3. Provide a design that prevents high temperature compressed air from flowing into the outlet side of a cooling equipment.

If the flow of the cooling water in a water-cooled aftercooler is stopped or if the fan motor of an air-cooled aftercooler is stopped, the hot compressed air will flow to the outlet side of the cooling equipment, causing the equipment on the outlet side such as the AFF, AM, AD, or IDF series to be damaged or malfunction.

4. Provide a design in which interruptions in the supply of compressed air are taken into consideration.

There are cases in which compressed air cannot flow due to the freezing of the refrigeration air dryer or malfunction of heatless dryer in the switching valve.

5. Do not use this product for caisson shielding, breathing, medical use, medicine that is injected by humans, or for blowing air on food products.

The air preparation equipment has been designed exclusively for industrial compressed air, and it should not be used for any other purpose. Due to unavoidable circumstances, if it must be used for other purposes, make sure to follow safety measures and contact SMC beforehand.

6. Do not use this product on board a vehicle or a vessel.

This product must not be installed and used on board a conveyance such as a vehicle or a vessel, since it may become damaged due to vibrations. If it must be used in such a manner due to unavoidable circumstances, please contact SMC beforehand.

7. Do not disassemble the product or make any modifications, including additional machining.

It may cause human injury and/or an accident.

⚠ Caution

1. Design a layout in which the leakage of cooling water and the dripping of condensation are taken into consideration.

A water-cooled aftercooler that uses cooling water could lead to water leakage due to freezing. Depending on the operating conditions, the refrigerated air dryer and its downstream pipes could drip water due to condensation formed by supercooling.

⚠ Caution

2. Provide a design that prevents back pressure and back flow.

The generation of back pressure and back flow could lead to equipment damage. Take appropriate safety measures and proper installation procedures.

3. Do not introduce an air flow that is greater than the rated flow rate.

If the rated flow rate is exceeded even momentarily, it could cause insufficient moisture elimination or drainage or oil splash to the outlet side or lead to equipment damage.

4. Do not use with low air pressure (blower).

The air preparation equipment, which operates at a specific minimum operating pressure in accordance with the equipment to be used, is designed to be used exclusively with compressed air. Using it below the minimum operating pressure could lower its performance or cause malfunction. If it must be used under such conditions due to unavoidable circumstances, please contact SMC beforehand.

Mounting

⚠ Warning

1. Operation manual

Install the products and operate them only after reading the operation manual carefully and understanding its contents. Also, keep the manual where it can be referred to as necessary.

2. Ensure sufficient space for maintenance activities.

When installing the products, allow access for maintenance.

3. Tighten threads with the proper tightening torque.

When installing the products, follow the listed torque specifications.

⚠ Caution

1. Verify the installation position.

Because the installation position differs by model, verify it in this catalog or in the operation manual. If the equipment installed is slanted, it could lead to improper drainage, causing the auto drain to malfunction, or damage to the equipment.

2. Provide ventilation space.

Unless a necessary ventilation space for each piece of equipment is provided, the air-cooled aftercooler or the refrigerated air dryer could cool poorly or stall.

Piping

⚠ Warning

1. Hold the female thread side and tighten to the recommended torque when screwing in the piping material.

Insufficient tightening torque may cause loosening or defective sealing. Over-tightening torque may damage the thread etc. If it is tightened without holding the female thread side, excessive force will be directly applied to the piping bracket resulting in a product failure.

Recommended Torque

Unit: N·m

Connection thread	1/8	1/4	3/8	1/2	3/4	1	1 1/2	2
Torque	7 to 9	12 to 14	22 to 24	28 to 30	28 to 30	36 to 38	48 to 50	48 to 50

* After tightening manually, tighten additionally by about 1/6 turn with a tightening tool.

Directional Control Valves

Air Cylinders

Air Actuators
Rotary Actuators

Air Grippers

Air Preparation Equipment

Modular F. R.

Pressure Control Equipment

Fittings & Tubing

Flow Control Equipment

Pressure Switches/
Pressure Sensors



Air Preparation Equipment Precautions 2

Be sure to read this before handling.

Piping

⚠ Caution

1. Refer to the Fittings and Tubing Precautions (pages 1237 to 1240) for handling One-touch fittings.
2. Preparation before piping
3. Winding of sealant tape

When screwing piping or fittings into ports, ensure that chips from the pipe threads or sealing material do not enter the piping. Also, if sealant tape is used, leave 1.5 to 2 thread ridges exposed at the end of the threads.

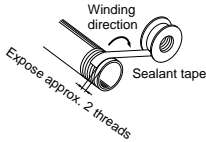

4. Take measures to prevent drainage from accumulating in the piping.

Design the piping so that a drain relief is provided at the bottom of a riser pipe, or a slight taper is provided along the flow to prevent the drainage from accumulating.

5. Verify the IN and OUT sides.

When connecting the piping, avoid interchanging the water and air sides as well as the IN and the OUT sides.

Wiring

⚠ Warning

1. Installing a dedicated breaker

To operate air preparation equipment that uses electricity (such as an air-cooled aftercooler or air dryer), install on the power supply side a leakage breaker with an appropriate leakage sensitivity and load capacity to prevent electric shocks or motor damage. Verify the breaker specifications in this manual or in the operation manual.

2. Verify the power supply voltage.

Operating the equipment with a voltage that is out of specification could lead to a fire or an electrical shocks. Verify the power supply and the voltage before wiring. The voltage fluctuation must be within ± 10 of the specified value.

3. Handle the wires carefully.

To prevent fire or electric shocks, do not bend, twist, or pull on the power supply cords or wires.

4. Wire with appropriate size terminal.

When connecting a power supply cord to equipment with a terminal box, use a terminal applicable to the terminal box. If an incorrect terminal size is used, it may cause a fire.

5. Have the wiring done by a qualified professional.

Only a qualified professional should carry out wiring work such as mounting the breaker, wiring the breaker to other equipment, or connecting to the terminal block.

Wiring

⚠ Caution

1. Installing ground

To operate air preparation equipment that uses electricity (such as an air-cooled aftercooler or air dryer), provide a ground connection to prevent earth leakage. Do not connect the ground wire to a water pipe or a gas pipe due to a risk of explosion.

2. Verify the color of the wires and terminal numbers before wiring.

Before connecting the wires, verify the color of the wires and terminal numbers in the operation manual or on the electrical wiring diagram name plate. Improper wiring could cause the electrical parts to become damaged, malfunction, or operate improperly.

3. Precautions for connecting a 3-phase power supply

Make sure to correctly connect the R, S, and T terminals to an equipment that uses a 3-phase power supply. If the terminals are connected improperly, the fan of the air-cooled after cooler will rotate in reverse, and the refrigerated air dryer will not operate because the reverse phase relay will trip. In such cases, interchange two of the three power supply wires (except IDF370B).

Air Supply

⚠ Warning

1. Type of fluids

Please consult with SMC when using the product in applications other than compressed air.

⚠ Caution

1. Do not use compressed air that contains chemicals, organic solvents, or corrosive gases.

Do not use compressed air that contains chemicals, organic solvents, salt, or corrosive gases as it can cause damage or malfunction.



Air Preparation Equipment Precautions 3

Be sure to read this before handling.

Operating Environment

⚠ Warning

1. Do not operate under the conditions listed below due to a risk of malfunction.

- 1) In locations having corrosive gases, organic solvents, and chemical solutions, or in locations in which these elements are likely to adhere to the equipment.
- 2) In locations in which sea water, water, or water steam could come in contact with the equipment.
- 3) In locations that are exposed to direct sunlight. (Shield the equipment from sunlight to prevent its resin material from ultraviolet ray degradation or overheating.)
- 4) In locations that have a heat source and poor ventilation. (Shield the equipment from heat sources to protect it from softening degradation due to radiated heat.)
- 5) In locations that are exposed to shocks and vibrations.
- 6) In locations with high humidity or a large amounts of dust. (Please contact SMC beforehand.)

2. Do not operate this equipment outdoors.

The air-cooled aftercooler and air dryer have been designed for indoor use. Exposing the equipment to rain could lead to electrical shock, equipment damage, or improper operation. If the equipment must be used under such conditions due to unavoidable circumstances, please contact SMC beforehand.

3. Adhere to the specified fluid temperature and ambient temperature ranges.

The fluid temperature and the ambient temperature are established according to the equipment. Using the equipment outside of its specification range could cause it to be damaged, malfunction, or operate improperly.

Maintenance

⚠ Warning

1. Perform maintenance inspection according to the procedures indicated in the operation manual.

If handled improperly, malfunction and damage of machinery or equipment may occur.

2. Maintenance work

If handled improperly, compressed air can be dangerous. Assembly, handling, repair and element replacement of pneumatic systems should be performed by a knowledgeable and experienced person.

3. Removal of equipment, and supply/exhaust of compressed air

When components are removed, first confirm that measures are in place to prevent workpieces from dropping, run-away equipment, etc. Then, cut off the supply pressure and electric power, and exhaust all compressed air from the system using the residual pressure release function.

When the equipment is operated after remounting or replacement, first confirm that measures are in place to prevent lurching of actuators, etc. Then, confirm that the equipment is operating normally.

4. If an abnormal condition occurs, turn off the power supply and stop the flow of compressed air.

If an abnormal condition occurs, such as smoke, foul smell, or noise, immediately turn off the power supply, stop the flow of compressed air and set the pressure of the compressed air to zero because there is a possible risk of electrical shock or fire.

5. Do not place your hands or foreign matter inside the unit.

To operate air preparation equipment (such as an air-cooled aftercooler or air dryer) in which power is supplied, do not place your hands or foreign matter inside the unit, to prevent electrical shock, burns, or injury. If the equipment must be used under such conditions due to unavoidable circumstances, turn off the power supply of the equipment, and confirm that it has stopped.

Maintenance

⚠ Warning

6. For inspection, disengage the breaker or pull out the power supply plug.

To prevent electrical shock, burns, or injury during inspection, disengage the breaker or disconnect the power supply plug before inspecting the equipment.

7. Do not touch high temperature areas.

Do not touch the aftercooler (through which high-temperature compressed air flows), the refrigeration unit of the refrigerated air dryer or refrigerant piping, because each generates high heat and poses a risk of burns.

8. Set the pressure of the compressed air to zero before an inspection.

Before disassembling the equipment on the compressed air side for inspecting the auto drain or for replacing the filter element, confirm that the pressure is set to zero.

9. The adjustment of the safety valve and periodical voluntary inspection of the Class 2 Pressure Vessels are required by the Ordinance on Safety of Boilers and Pressure Vessels. Conduct the inspection according to the mentioned ordinance.

⚠ Caution

1. Do not place a heavy object on top of an equipment or use it as a step stool.

Failure to observe this precaution could cause the equipment to become deformed or damaged and a loss of balance could cause a fall or injury.

2. Discharge the drainage on a regular basis.

If drain remains accumulated in the equipment or in the piping, it could cause the equipment to operate improperly, or the drain could splash to the outlet side, leading to unforeseen accidents. Therefore, check the drainage volume and the operation of the auto drain on a daily basis.

3. Additional tightening of the screws for the wire connection terminals.

Depending on the operating conditions, the screws for the wire connection terminals could loosen, leading to overheating or a fire. As a preventive measure, tighten the screws on a regular basis.

4. Use sufficient care in the disposal of refrigeration type air dryers.

Some refrigerated air dryers use a refrigerant that destroys the ozone layer. Please consult with a professional contractor when collecting a refrigerant or disposing of such equipment.

5. Turn off the power supply at the source if the equipment will not be used for long periods of time.

To prevent accidents, turn off the power supply at the source if the equipment will not be used for long periods of time.

6. Keep the Class 2 Pressure Vessel Certificate in a safe place.

Large refrigerated air dryers (IDF190D and larger) and large AFF, AMD, (AFF220A, AMD901/900/1000) and air tanks comply with Class 2 Pressure Vessel requirements. A class 2 pressure vessel certificate will be sent to you in 2 to 4 weeks after the product. Keep this certificate in a safe place.

Directional Control Valves

Air Cylinders

Rotary Actuators

Air Grippers

Air Preparation Equipment

Modular F. R.

Pressure Control Equipment

Fittings & Tubing

Flow Control Equipment

Pressure Switches/ Pressure Sensors

For Clean Room

Modular F.R.

Contents	Series	Page
Air Filter	10- 21- AF	P.1069
Mist Separator	10- 21- AFM	P.1071
Micro Mist Separator	10- 21- AFD	P.1073
Regulator	10- 21- AR	P.1075
Regulator with Backflow Function	10- 21- AR□K	P.1075
Filter Regulator	10- 21- AW	P.1079
Filter Regulator with Backflow Function	10- 21- AW□K	P.1079
Mist Separator Regulator	10- 21- AWM	P.1083
Micro Mist Separator Regulator	10- 21- AWD	P.1083
Precautions		P.1087

Directional
Control Valves

Air Cylinders

Rotary Actuators

Air Grippers

Air Preparation
Equipment

Modular F. R.

Pressure Control
Equipment

Fittings & Tubing

Flow Control
Equipment

Pressure Switches/
Pressure Sensors

Series 10-21-AF Air Filter

How to Order

Clean series

10-AF30-F03B-J

21-AF30-F03B-J

* "J" must always be selected.

Copper, fluorine and silicone-free + Low particle generation

Air filter

Body size

20 30 40 50 60

Thread type

Nil	Rc
N (Note 1)	NPT
F (Note 2)	G

Note 1) Drain guide is NPT1/8 (applicable to size 20), and NPT1/4 (applicable to size 30 to 60).

Note 2) Drain guide is G1/8 (applicable to size 20), and G1/4 (applicable to size 30 to 60).

Port size

Symbol	Port size	Body size				
		20	30	40	50	60
01	1/8	●	—	—	—	—
02	1/4	●	—	—	—	—
03	3/8	—	●	●	—	—
04	1/2	—	—	●	—	—
06	3/4	—	—	—	●	—
10	1	—	—	—	—	●

Accessory

Symbol	Description	Applicable model
Nil	—	—
B (Note 3)	With bracket	20 to 60

Note 3) Bracket is not assembled and is supplied loose at the time of shipment.

Option

Symbol	Description	Applicable model
2	Metal bowl	20 to 60
6	Nylon bowl	20 to 60
8	Metal bowl with level gauge	30 to 60
C	With bowl guard	20
J (Note 4)	Drain guide 1/8	20
J	Drain guide 1/4	30 to 60
R	Flow direction: Right to left	20 to 60
Z (Note 5)	Name plate and caution plate for bowl in imperial units (PSI, °F)	20 to 60



Accessory/Optional Specifications Combinations

Accessory/Optional specifications	Symbol	Option specifications							Applicable filter	
		B	2	6	8	C	J	R	Z	10-21-AF20
Bracket assembly	B	○	○	○	○	○	○	△	○	○
Metal bowl	-2	○					○	○	△	○
Nylon bowl	-6	○				○	○	△	○	○
Metal bowl with level gauge	-8	○					○	△		○
With bowl guard	-C	○	○				○	△	○	
Drain guide	-J	○	○	○	○	○		△	○	○
Flow direction: Right to left	-R	○	○	○	○	○		△	○	○
Name plate and caution plate for bowl in imperial units (PSI, °F)	-Z	△	△	△	△	△	△	△	△	△

Standard Specifications

Model	10-21-AF20	10-21-AF30	10-21-AF40	10-21-AF40-06	10-21-AF50	10-21-AF60
Port size	1/8, 1/4	1/4, 3/8	1/4, 3/8, 1/2	3/4	3/4, 1	1
Fluid	Air					
Proof pressure	1.5 MPa					
Maximum operating pressure	1.0 MPa					
Ambient & fluid temperature	-5 to 60°C (No freezing)					
Nominal filtration rating	5 μm					
Air flow capacity (L/min (ANR))	800 (1/8) 1000 (1/4)	1600 (1/4) 2100 (3/8)	1600 (1/4) 2800 (3/8) 3700 (1/2)	4200 (3/4)	6100 (3/4) 7000 (1)	8200 (1)
Drain capacity (cm ³)	8	25	45	45	45	45
Drain guide port size	1/8	1/4	1/4	1/4	1/4	1/4
Grease	10-: Fluorine grease 21-: Lithium soap based grease					
Cleanliness class (ISO class)	10-: Class 3 21-: Class 3					

Note 6) Inlet side pressure: 0.5 MPa. Pressure drop: 0.05 MPa (Representative value).

Accessory Part No.

Accessory	Applicable model	10-21-AF20	10-21-AF30	10-21-AF40	10-21-AF40-06	10-21-AF50	10-21-AF60
Bracket assembly (Note 7)		AF20P-050AS	AF30P-050AS	AF40P-050AS	AF40P-070AS	AF50P-050AS	AF50P-050AS

Note 7) Assembly includes a bracket and 2 mounting screws.

Dimensions

10-21-AF20

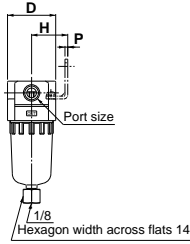
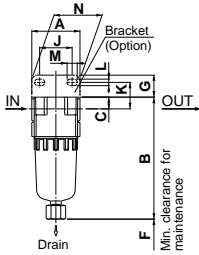

10-21-AF30 to 40-06

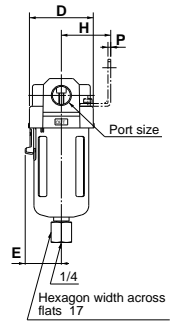
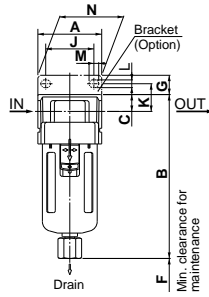

10-21-AF50/60

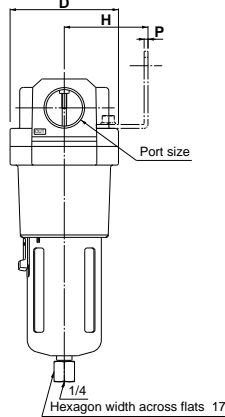
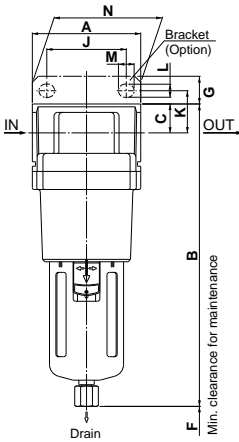

Applicable model	10-21-AF20		10-21-AF30 to 60	
Optional specifications	With bowl guard	Metal bowl	Metal bowl	Metal bowl with level gauge
Dimensions				

Model	Port size	Standard specifications						Accessory specifications						Optional specifications				
		A	B	C	D	E	F	Bracket mounting size						With bowl guard	Metal bowl	Metal bowl with level gauge		
							G	H	J	K	L	M	N	P	B	B	B	
10-21-AF20	1/8, 1/4	40	101	10	40	—	40	18	30	27	22	5.4	8.4	40	2.3	101	104	—
10-21-AF30	1/4, 3/8	53	136	14	53	30	50	16	41	40	23	6.5	8	53	2.3	—	136	156
10-21-AF40	1/4, 3/8, 1/2	70	172	18	70	38	75	17	50	54	26	8.5	10.5	70	2.3	—	172	192
10-21-AF40-06	3/4	75	176	20	70	38	75	14	50	54	25	8.5	10.5	70	2.3	—	176	196
10-21-AF50	3/4, 1	90	252	24	90	—	20	23	70	66	35	11	13	90	3.2	—	252	272
10-21-AF60	1	95	265	24	95	—	20	23	70	66	35	11	13	90	3.2	—	265	285

- Directional Control Valves
- Air Cylinders
- Rotary Actuators
- Air Grippers
- Air Preparation Equipment
- Modular F. R.
- Pressure Control Equipment
- Fittings & Tubing
- Flow Control Equipment
- Pressure Switches/ Pressure Sensors

Series 10-21-AFM Mist Separator

How to Order

Clean series

10-AFM 30-F 03 B-J

21-AFM 30-F 03 B-J

* "J" must always be selected.

Copper, fluorine and silicone-free + Low particle generation

Mist separator

Body size

20 30 40

Thread type

Nil	Rc
N (Note 1)	NPT
F (Note 2)	G

Note 1) Drain guide is NPT1/8 (applicable to size 20), and NPT1/4 (applicable to size 30 and 40).

Note 2) Drain guide is G1/8 (applicable to size 20), and G1/4 (applicable to size 30 and 40).

Port size

Symbol	Port size	Body size	20	30	40
01	1/8	●	—	—	—
02	1/4	●	●	—	—
03	3/8	—	●	●	—
04	1/2	—	—	●	●
06	3/4	—	—	—	●

Accessory

Symbol	Description	Applicable model
Nil	—	—
B (Note 3)	With bracket	20 to 40

Note 3) Bracket is not assembled and is supplied loose at the time of shipment.

Option

Symbol	Description	Applicable model
2	Metal bowl	20 to 40
6	Nylon bowl	20 to 40
8	Metal bowl with level gauge	30, 40
C	With bowl guard	20
J (Note 4)	Drain guide 1/8	20
J	Drain guide 1/4	30, 40
R	Flow direction: Right to left	20 to 40
Z (Note 5)	Name plate and caution plate for bowl in imperial units (PSI, "F)	20 to 40

When more than one specification is required, indicate in ascending alphanumeric order.

Note 4) Without a valve function.

Note 5) For NPT thread type. This product is for overseas use only according to the new Measurement Law. (The SI unit type is provided for use in Japan.)



Accessory/Optional Specifications Combinations

Accessory/Optional specifications	Combination	Symbol	Accessory	Optional specifications							Applicable mist separator	
				B	2	6	8	C	J	R	Z	10-/21-AFM20
With bracket		B		○	○	○	○	○	○	△	○	○
Metal bowl		-2	○					○	○	△	○	○
Nylon bowl		-6	○					○	○	△	○	○
Metal bowl with level gauge		-8	○					○	○	△		○
With bowl guard		-C	○	○				○	○	△	○	
Drain guide		-J	○	○	○	○	○		○	△	○	○
Flow direction: Right to left		-R	○	○	○	○	○	○		△	○	○
Name plate and caution plate for bowl in imperial units (PSI, F)		-Z	△	△	△	△	△	△	△		△	△

Standard Specifications

Model	10-/21-AFM20	10-/21-AFM30	10-/21-AFM40	10-/21-AFM40-06
Port size	1/8, 1/4	1/4, 3/8	1/4, 3/8, 1/2	3/4
Fluid	Air			
Proof pressure	1.5 MPa			
Maximum operating pressure	1.0 MPa			
Minimum operating pressure	0.05 MPa			
Ambient & fluid temperature	-5 to 60°C (No freezing)			
Nominal filtration rating	0.3 μm (95% filtered particle size)			
Outlet side oil mist concentration	Maximum 1.0 mg/m ³ (ANR) (approx. 0.8 ppm) ^{Note 6)}			
Rated flow (L/min (ANR)) ^{Note 7)}	200	450	1100	1100
Drain capacity (cm ³)	8	25	45	45
Drain guide port size	1/8	1/4	1/4	1/4
Grease	10-: Fluorine grease 21-: Lithium soap based grease			
Cleanliness class (ISO class)	10-: Class 3 21-: Class 3			

Note 6) When the compressor oil mist discharge concentration is 30 mg/m³ (ANR).

Note 7) When the inlet pressure is 0.7 MPa. Flow rate varies depending on the inlet pressure.

Accessory Part No.

Accessory	Applicable model	10-/21-AFM20	10-/21-AFM30	10-/21-AFM40	10-/21-AFM40-06
Bracket assembly ^{Note 8)}		AF20P-050AS	AF30P-050AS	AF40P-050AS	AF40P-070AS

Note 8) Assembly includes a bracket and 2 mounting screws.

Dimensions

10-21-AFM20

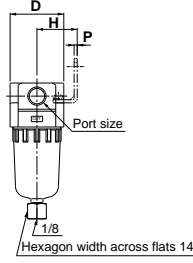
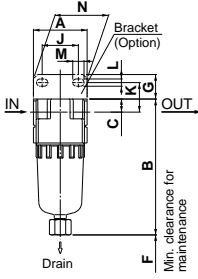

10-21-AFM30 to 40-06

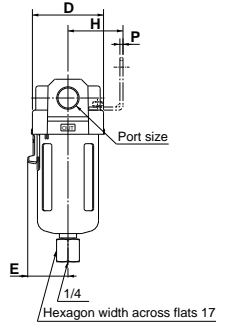
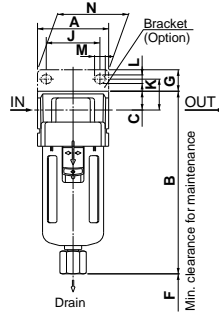

Applicable model	10-21-AFM20		10-21-AFM30 to 40-06		
	Optional specifications	With bowl guard	Metal bowl	Metal bowl	Metal bowl with level gauge
Dimensions					

Model	Port size	Standard specifications						Accessory specifications							Optional specifications			
		A	B	C	D	E	F	Bracket mounting size							With bowl guard	Metal bowl	Metal bowl with level gauge	
								G	H	J	K	L	M	N				P
10-21-AFM20	1/8, 1/4	40	101	10	40	—	45	18	30	27	22	5.4	8.4	40	2.3	101	104	—
10-21-AFM30	1/4, 3/8	53	136	14	53	30	50	16	41	40	23	6.5	8	53	2.3	—	136	156
10-21-AFM40	1/4, 3/8, 1/2	70	172	18	70	38	75	17	50	54	26	8.5	10.5	70	2.3	—	172	192
10-21-AFM40-06	3/4	75	176	20	70	38	75	14	50	54	25	8.5	10.5	70	2.3	—	176	196

Directional Control Valves

Air Cylinders

Rotary Actuators

Air Grippers

Air Preparation Equipment

Modular F. R.

Pressure Control Equipment

Fittings & Tubing

Flow Control Equipment

Pressure Switches/ Pressure Sensors

Series 10-21-AFD Micro Mist Separator

How to Order

Clean series

10 - AFD 30 F 03 B J

21 - AFD 30 F 03 B J

* "J" must always be selected.

Copper, fluorine and silicone-free + Low particle generation

Micro mist separator

Body size

20 30 40

Thread type

Nil	Rc
N (Note 1)	NPT
F (Note 2)	G

Port size

Symbol	Port size	20	30	40
01	1/8	●	—	—
02	1/4	●	●	—
03	3/8	—	●	●
04	1/2	—	—	●
06	3/4	—	—	●

Accessory

Symbol	Description	Applicable size
Nil	—	—
B (Note 3)	With bracket	20 to 40

Note 3) Bracket is not assembled and is supplied loose at the time of shipment.

Option

Symbol	Description	Applicable size
2	Metal bowl	20 to 40
6	Nylon bowl	20 to 40
8	Metal bowl with level gauge	30, 40
C	With bowl guard	20
J (Note 4)	Drain guide 1/8	20
J	Drain guide 1/4	30, 40
R	Flow direction: Right to left	20 to 40
Z (Note 5)	Name plate and caution plate for bowl in imperial units (PSI, °F)	20 to 40

Note 1) Drain guide is NPT1/8 (applicable to size 20), and NPT1/4 (applicable to size 30 and 40).
 Note 2) Drain guide is G1/8 (applicable to size 20), and G1/4 (applicable to size 30 and 40).
 Note 3) Bracket is not assembled and is supplied loose at the time of shipment.
 Note 4) Without a valve function.
 Note 5) For NPT thread type. This product is for overseas use only according to the new Measurement Law. (The SI unit type is provided for use in Japan.).



Accessory/Optional Specifications Combinations

⊙Combination available ⊠Combination not available
 ○Varies depending on the model △Available only with NPT thread

Accessory/Optional specifications	Combination Symbol	Optional specifications							Applicable to micro mist separator		
		B	2	6	8	C	J	R	Z	10-/21-AFD20	10-/21-AFD30 and 40
Accessory/Optional specifications											
With bracket	B	⊙	⊙	⊙	○	○	⊙	⊙	△	⊙	⊙
Metal bowl	-2	⊙	⊙	⊙	⊙	⊙	⊙	⊙	△	⊙	⊙
Nylon bowl	-6	⊙	⊙	⊙	⊙	⊙	⊙	⊙	△	⊙	⊙
Metal bowl with level gauge	-8	⊙	⊙	⊙	⊙	⊙	⊙	⊙	△	⊙	⊙
With bowl guard	-C	⊙	⊙	⊙	⊙	⊙	⊙	⊙	△	⊙	⊙
Drain guide	-J	⊙	⊙	⊙	○	○	⊙	⊙	△	⊙	⊙
Flow direction: Right to left	-R	⊙	⊙	⊙	○	○	⊙	⊙	△	⊙	⊙
Name plate and caution plate for bowl in imperial units (PSI, °F)	-Z	△	△	△	△	△	△	△	△	△	△

Standard Specifications

Model	10-/21-AFD20	10-/21-AFD30	10-/21-AFD40	10-/21-AFD40-06
Port size	1/8, 1/4	1/4, 3/8	1/4, 3/8, 1/2	3/4
Fluid	Air			
Proof pressure	1.5 MPa			
Maximum operating pressure	1.0 MPa			
Minimum operating pressure	0.05 MPa			
Ambient & fluid temperature	-5 to 60°C (No freezing)			
Nominal filtration rating	0.01 μm (95% filtered particle size)			
Outlet side oil mist concentration	Max. 0.1 mg/m ³ (ANR) (Before saturated with oil: 0.01 mg/m ³ (ANR) or less, approx. 0.008 ppm) (Note 6)			
Rated flow (L/min (ANR)) (Note 7)	120	240	600	600
Drain capacity (cm ³)	8	25	45	45
Drain guide port size	1/8	1/4	1/4	1/4
Grease	10-: Fluorine grease 21-: Lithium soap based grease			
Cleanliness class (ISO class)	10-: Class 3 21-: Class 3			

Note 6) When the compressor oil mist discharge concentration is 30 mg/m³ (ANR).

Note 7) When the inlet pressure is 0.7 MPa. The flow rate varies depending on the inlet pressure.

Accessory Part No.

Accessory	Applicable model	10-/21-AFD20	10-/21-AFD30	10-/21-AFD40	10-/21-AFD40-06
Bracket assembly (Note 8)		AF20P-050AS	AF30P-050AS	AF40P-050AS	AF40P-070AS

Note 8) Assembly includes a bracket and 2 mounting screws.

Dimensions

10-21-AFD20

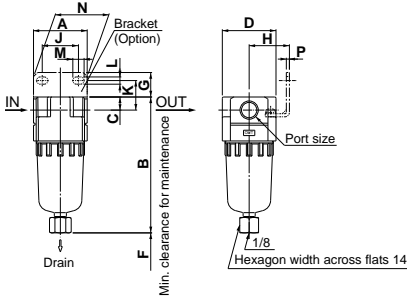

10-21-AFD30 to 40-06

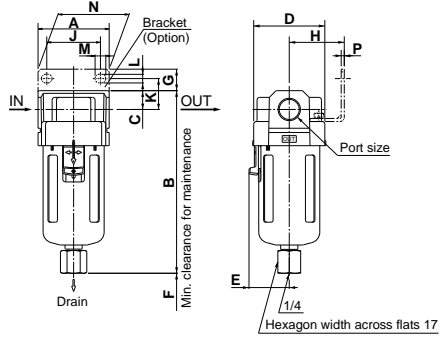

Applicable model	10-21-AFD20			10-21-AFD30 to 40-06			
Optional specifications	With bowl guard	Metal bowl		Metal bowl		Metal bowl with level gauge	
Dimensions							

Model	Port size	Standard specifications														Accessory specifications				Optional specifications		
																Bracket mounting size						
		A	B	C	D	E	F	G	H	J	K	L	M	N	P	With bowl guard		Metal bowl	Metal bowl with level gauge			
10-21-AFD20	1/8, 1/4	40	101	10	40	—	45	18	30	27	22	5.4	8.4	40	2.3	101		104	—			
10-21-AFD30	1/4, 3/8	53	136	14	53	30	50	16	41	40	23	6.5	8	53	2.3	—		136	156			
10-21-AFD40	1/4, 3/8, 1/2	70	172	18	70	38	75	17	50	54	26	8.5	10.5	70	2.3	—		172	192			
10-21-AFD40-06	3/4	75	176	20	70	38	75	14	50	54	25	8.5	10.5	70	2.3	—		176	196			

Directional Control Valves
Air Cylinders
Rotary Actuators
Air Grippers
Air Preparation Equipment
Modular F. R.
Pressure Control Equipment
Fittings & Tubing
Flow Control Equipment
Pressure Switches/ Pressure Sensors

Series 10-21-AR Regulator

Series 10-21-AR□K Regulator with Backflow Function



How to Order

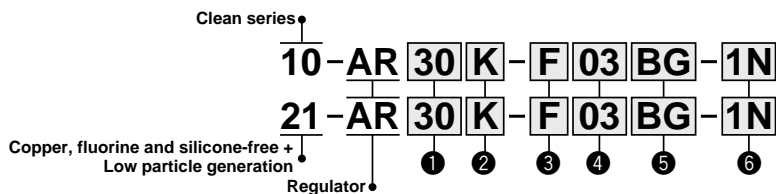

- Option/Semi-standard: Select one each for a to g.
- Option/Semi-standard symbol: When more than one specification is required, indicate in alphanumeric order.

	Symbol	Description	1							
			Body size							
			20	25	30	40	50	60		
2	With backflow function	Nil	Without backflow function							
	K (Note 1)	With backflow function								
3	Thread type	+								
		Nil	Rc							
		N	NPT							
		F	G							
4	Port size	+								
		01	1/8							
		02	1/4							
		03	3/8							
		04	1/2							
		06	3/4							
5	a	Mounting	Nil	Without mounting option						
			B (Note 3)	With bracket						
			H	With set nut (for panel mounting)						
			+							
b	Pressure gauge	Nil	Without pressure gauge							
		G	Round type pressure gauge (without limit indicator)							
6	Semi-standard	c	Set pressure	Nil	0.05 to 0.85 MPa setting					
				1 (Note 4)	0.02 to 0.2 MPa setting					
		d	Exhaust mechanism	Nil	Relieving type					
				N	Non-relieving type					
		e	Flow direction	Nil	Flow direction: Left to right					
				R	Flow direction: Right to left					
		f	Knob	+						
				Y	Upward					
		g	Pressure unit	Nil	Name plate and pressure gauge in imperial units: MPa					
				Z (Note 5)	Name plate and pressure gauge in imperial units: psi					

Note 1) When using a non-relieving type with a backflow function, if the inlet pressure is increased slowly, the inlet pressure may continue to the outlet side.

Note 2) Option B, G, H are not assembled and supplied loose at the time of shipment.

Note 3) Assembly of a bracket and set nuts (10-/21-AR20(K) to AR40(K))

Including 2 mounting screws for the 10-/21-AR50(K), AR60(K)

Note 4) The only difference from the standard specifications is the adjusting spring for the regulator. It does not restrict the setting of 0.2 MPa or more.

When the pressure gauge is attached, a 0.2 MPa pressure gauge will be fitted.

Note 5) For thread type: NPT. This product is for overseas use only according to the new Measurement Law. (The SI unit type is provided for use in Japan.)

Note 6) ○: For thread type: NPT only

Standard Specifications

Model	10-/21-AR20(K)	10-/21-AR25(K)	10-/21-AR30(K)	10-/21-AR40(K)	10-/21-AR40(K)-06	10-/21-AR50(K)	10-/21-AR60(K)
Port size	1/8, 1/4	1/4, 3/8	1/4, 3/8	1/4, 3/8, 1/2	3/4	3/4, 1	1
Pressure gauge port size	1/8			1/4			
Fluid	Air						
Ambient and fluid temperature	-5 to 60°C (with no freezing)						
Proof pressure	1.5 MPa						
Maximum operating pressure	1.0 MPa						
Set pressure range	0.05 to 0.85 MPa						
Relief pressure	Set pressure + 0.05 MPa [at relief flow rate of 0.1 L/min (ANR)]						
Construction	Relieving type						
Grease	10:- Fluorine grease 21:- Lithium soap based grease						
Cleanliness class (ISO class)	10:- Class 3 21:- Class 3						

Options/Part No.

Option	Model	10-/21-AR20(K)	10-/21-AR25(K)	10-/21-AR30(K)	10-/21-AR40(K)	10-/21-AR40(K)-06	10-/21-AR50(K)	10-/21-AR60(K)
Bracket assembly ^{Note 1)}		AR20P-270AS	AR25P-270AS	AR30P-270AS	AR40P-270AS		AR50P-270AS ^{Note 2)}	
Set nut		AR20P-260S	AR25P-260S	AR30P-260S	AR40P-260S		— ^{Note 3)}	— ^{Note 3)}
Pressure gauge ^{Note 4)}	Standard	10: G49-10-□01, 21: G49-10-□01-MS-X3			10: G49-10-□02, 21: G49-10-□02-MS-X3			
	0.02 to 0.2 MPa setting	10: G49-2-□01, 21: G49-2-□01-MS-X3			10: G49-2-□02, 21: G49-2-□02-MS-X3			

Note 1) Assembly of a bracket and set nuts

Note 2) Assembly of a bracket and 2 mounting screws

Note 3) Please consult with SMC regarding the set nuts for the 10-/21-AR50(K), AR60(K).

Note 4) □ in part numbers for a round pressure gauge indicates a type of connection thread. No indication is necessary for R; however, indicate N for NPT.

Please contact SMC regarding the connection thread NPT and pressure gauge supply for psi unit specifications.

Dimensions

10-21-AR20 to 40-06

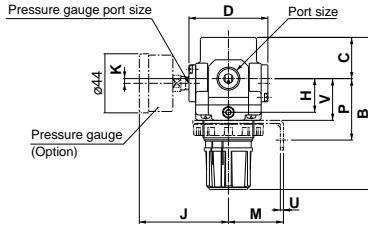
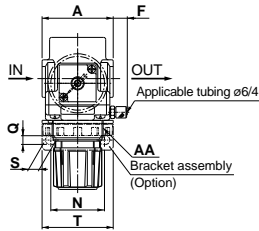

Panel fitting dimension

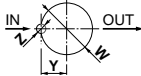
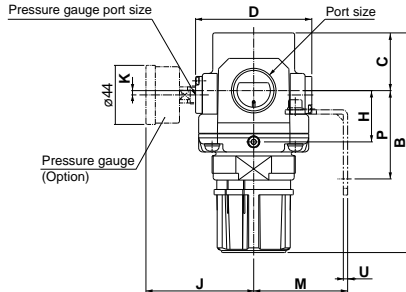
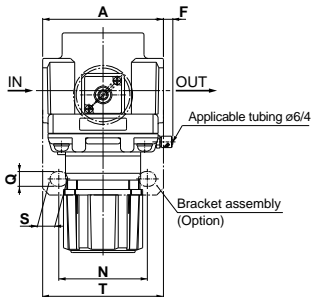

Plate thickness
 10-/21-AR20/30: Max. 3.5
 10-/21-AR40: Max. 5

10-21-AR50/60



Model	Port size	Pressure gauge port size	Standard specifications																	Accessory specifications														
																				With pressure gauge					Bracket mounting size					Panel mount				
			A	B	C	D	F	H	J	K	M	N	P	Q	S	T	U	V	W	Y	Z	AA												
10-/21-AR20	1/8, 1/4	1/8	40	94	26.5	57	11	20	66	2 ^{Note)}	30	34	44	5.4	15.4	55	2.3	25	28.5	14	6	M28 x 1												
10-/21-AR25	1/4, 3/8	1/8	53	101	28	55	10	20.5	65	0	30	34	44	5.4	15.4	55	2.3	26	32.5	16	6	M32 x 1.5												
10-/21-AR30	1/4, 3/8	1/8	53	116	31	59	10.5	25	67	3.5	41	40	46	6.5	8	53	2.3	31	38.5	19	7	M38 x 1.5												
10-/21-AR40	1/4, 3/8, 1/2	1/4	70	128	36	68	10.5	29	71	3.5	50	54	54	8.5	10.5	70	2.3	35.5	42.5	21	7	M42 x 1.5												
10-/21-AR40-06	3/4	1/4	75	129	36	68	8	30.5	71	3	50	54	56	8.5	10.5	70	2.3	37	42.5	21	7	M42 x 1.5												
10-/21-AR50	3/4, 1	1/4	90	169	43	87	7	38	81	3.3	70	66	65.8	11	13	90	3.2	—	—	—	—	—												
10-/21-AR60	1	1/4	95	176	46	87	4.5	42.5	81	3.3	70	66	65.8	11	13	90	3.2	—	—	—	—	—												

Note) For 10-/21-AR20 only, the position of the pressure gauge is above the center of the piping.

Dimensions

10-21-AR20K to 40K-06

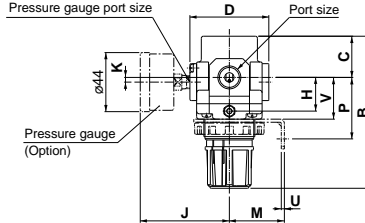
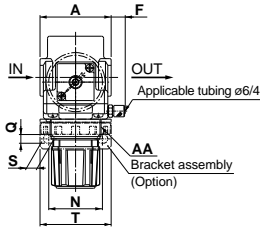

Panel fitting dimension

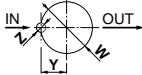
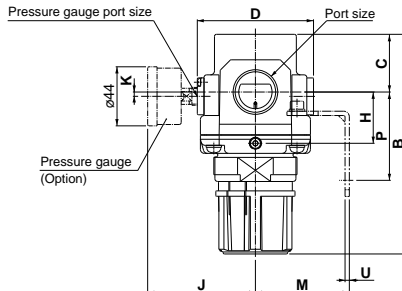
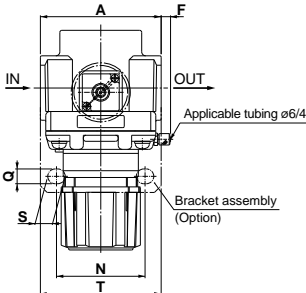

Plate thickness
 10-21-AR20K, 30K: Max. 3.5
 10-21-AR40K: Max. 5

10-21-AR50K/60K



Model	Port size	Pressure gauge connection port size	Standard specifications																			
			With pressure gauge														Panel mount					
			A	B	C	D	F	H	J	K	M	N	P	Q	S	T	U	V	W	Y	Z	AA
10-21-AR20K	1/8, 1/4	1/8	40	94	26.5	57	11	20	66	2 ^(Note)	30	34	44	5.4	15.4	55	2.3	25	28.5	14	6	M28 x 1
10-21-AR25K	1/4, 3/8	1/8	53	101	28	55	10	20.5	65	0	30	34	44	5.4	15.4	55	2.3	26	32.5	16	6	M32 x 1.5
10-21-AR30K	1/4, 3/8	1/8	53	116	31	59	10.5	25	67	3.5	41	40	46	6.5	8	53	2.3	31	38.5	19	7	M38 x 1.5
10-21-AR40K	1/4, 3/8, 1/2	1/4	70	128	36	68	10.5	29	71	3.5	50	54	54	8.5	10.5	70	2.3	35.5	42.5	21	7	M42 x 1.5
10-21-AR40K-06	3/4	1/4	75	129	36	68	8	30.5	71	3	50	54	56	8.5	10.5	70	2.3	37	42.5	21	7	M42 x 1.5
10-21-AR50K	3/4, 1	1/4	90	169	43	87	7	38	81	3.3	70	66	65.8	11	13	90	3.2	—	—	—	—	—
10-21-AR60K	1	1/4	95	176	46	87	4.5	42.5	81	3.3	70	66	65.8	11	13	90	3.2	—	—	—	—	—

Note) For 10/21-AR20K only, the position of the pressure gauge is above the center of the piping.

Directional Control Valves
 Air Cylinders
 Rotary Actuators
 Air Grippers
 Air Preparation Equipment
 Modular F. R.
 Pressure Control Equipment
 Fittings & Tubing
 Flow Control Equipment
 Pressure Switches/Pressure Sensors

Series 10-21-AW Filter Regulator

Series 10-21-AW K Filter Regulator with Backflow Function

How to Order

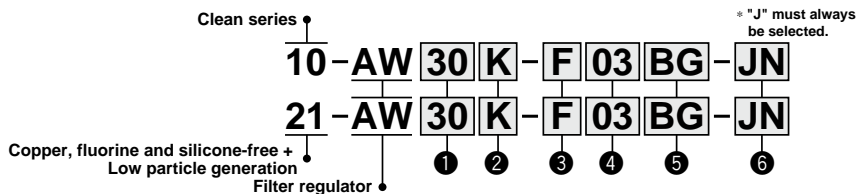

- Option/Semi-standard: Select one each for a to g.
- Option/Semi-standard symbol: When more than one specification is required, indicate in alphanumeric order.

	Symbol	Description	①				
			Body size				
			20	30	40	60	
②	With backflow function	Nil	Without backflow function				
		K <small>Note 1)</small>	With backflow function				
③		+					
	Thread type	Nil	Rc				
		N <small>Note 2)</small>	NPT				
	F <small>Note 3)</small>	G					
④	Port size	+					
		01	1/8				
		02	1/4				
		03	3/8				
		04	1/2				
		06	3/4				
		10	1				
⑤	a	Mounting	Nil	Without mounting option			
			B <small>Note 5)</small>	With bracket			
			H	With set nut (for panel mounting)			
			+				
	b	Pressure gauge	Nil	Without pressure gauge			
G			Round type pressure gauge (without limit indicator)				

	Symbol	Description	①				
			Body size				
			20	30	40	60	
Semi-standard ⑥	c	Set pressure	Nil	0.05 to 0.85 MPa setting			
			1 <small>Note 6)</small>	0.02 to 0.2 MPa setting			
	d	Bowl	Nil	Polycarbonate bowl			
			2	Metal bowl			
			6	Nylon bowl			
			8	Metal bowl with level gauge			
			C	With bowl guard			
			6C	Nylon bowl with bowl guard			
	e	Drain port <small>Note 7)</small>	J	Drain guide 1/8			
				Drain guide 1/4			
	f	Exhaust mechanism	Nil	Relieving type			
			N	Non-relieving type			
	g	Flow direction	Nil	Flow direction: Left to right			
			R	Flow direction: Right to left			
	h	Pressure unit	Nil	Name plate, caution plate for bowl, and pressure gauge in imperial units: MPa			
Z <small>Note 8)</small>			Name plate, caution plate for bowl, and pressure gauge in imperial units: psi				

Note 1) When using a non-relieving type with a backflow function, if the inlet pressure is increased slowly, the inlet pressure may continue to the outlet side.
 Note 2) Drain guide is NPT 1/8 (applicable to the 10-21-AW20(K)) and NPT 1/4 (applicable to the 10-21-AW30(K) to AW60(K)).
 Note 3) Drain guide is G 1/8 (applicable to the 10-21-AW20(K)) and G 1/4 (applicable to the 10-21-AW30(K) to AW60(K)).
 Note 4) Option B, G, H are not assembled and supplied loose at the time of shipment.
 Note 5) Assembly of a bracket and set nuts (10-21-AW20(K) to AW40(K)) including 2 mounting screws for the 10-21-AW60(K)
 Note 6) The only difference from the standard specifications is the adjusting spring for the regulator. It does not restrict the setting of 0.2 MPa or more. When the pressure gauge is attached, a 0.2 MPa pressure gauge will be fitted.
 Note 7) Be sure to select "J" drain guide. Without a valve function.
 Note 8) For thread type: NPT. This product is for overseas use only according to the new Measurement Law. (The SI unit type is provided for use in Japan.)
 Note 9) ○: For thread type: NPT only

Standard Specifications

Model	10-21-AW20(K)	10-21-AW30(K)	10-21-AW40(K)	10-21-AW40(K)-06	10-21-AW60(K)
Port size	1/8, 1/4	1/4, 3/8	1/4, 3/8, 1/2	3/4	3/4, 1
Pressure gauge port size	1/8		1/4		
Fluid	Air				
Ambient and fluid temperature	-5 to 60°C (with no freezing)				
Proof pressure	1.5 MPa				
Maximum operating pressure	1.0 MPa				
Set pressure range	0.05 to 0.85 MPa				
Relief pressure	Set pressure + 0.05 MPa [at relief flow rate of 0.1 L/min (ANR)]				
Nominal filtration rating	5 μm				
Drain capacity (cm ³)	8	25	45	45	45
Drain guide port size	1/8	1/4			
Construction	Relieving type				
Grease	10: Fluorine grease 21: Lithium soap based grease				
Cleanliness class (ISO class)	10-: Class 3 21-: Class 3				

Options/Part No.

Model	10-21-AW20(K)	10-21-AW30(K)	10-21-AW40(K)	10-21-AW40(K)-06	10-21-AW60(K)
Option					
Bracket assembly <small>Note 1)</small>	AW20P-270AS	AR30P-270AS	AR40P-270AS	AW60P-270AS <small>Note 2)</small>	
Set nut	AR20P-260S	AR30P-260S	AR40P-260S	— <small>Note 3)</small>	
Pressure gauge <small>Note 4)</small>	Standard	10: G49-10-□01, 21: G49-10-□01-MS-X3		10: G49-10-□02, 21: G49-10-□02-MS-X3	
	0.02 to 0.2 MPa setting	10: G49-2-□01, 21: G49-2-□01-MS-X3		10: G49-2-□02, 21: G49-2-□02-MS-X3	

Note 1) Assembly of a bracket and set nuts
 Note 2) Assembly of a bracket and 2 mounting screws
 Note 3) Please consult SMC regarding the set nuts for the 10-21-AW60(K).
 Note 4) □ in part numbers for a round pressure gauge indicates a type of connection thread. No indication is necessary for R; however, indicate N for NPT.
 Please contact SMC regarding the connection thread NPT and pressure gauge supply for psi unit specifications.

Dimensions

10-21-AW20

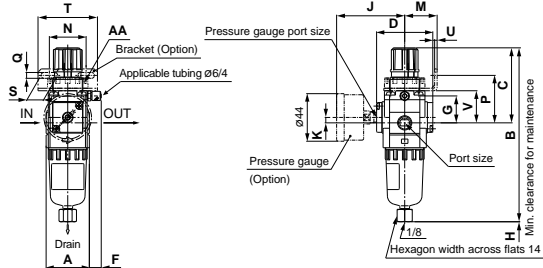

Panel fitting dimension



Plate thickness
10-/21-AW20: Max. 3.5

10-21-AW30 to 40-06

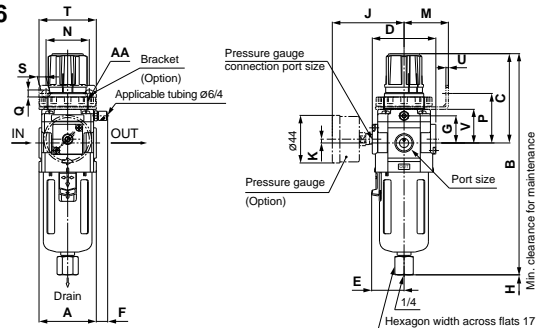

Panel fitting dimension



Plate thickness
10-/21-AW30: Max. 3.5
10-/21-AW40: Max. 5

10-21-AW60

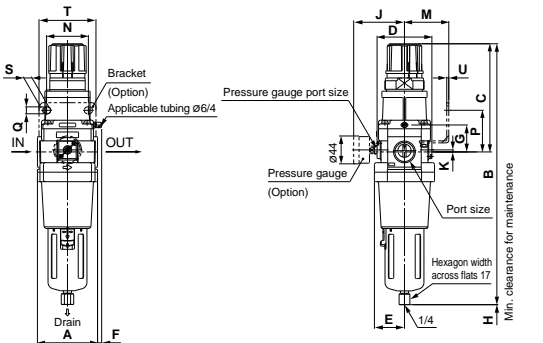

Applicable model	10-/21-AW20		10-/21-AW30 to 60	
Optional specifications	With bowl guard	Metal bowl	Metal bowl	Metal bowl with level gauge
Dimensions				

Model	Optional specifications		
	With bowl guard	Metal bowl	Metal bowl with level gauge
	B	B	B
10-/21-AW20	164	167	—
10-/21-AW30	—	208	228
10-/21-AW40	—	246	266
10-/21-AW40-06	—	249	269
10-/21-AW60	—	416	436

Model	Port size	Pressure gauge port size	Standard specifications																	Accessory specifications										
			A	B	C	D	E	F	G	H	J	K	M	N	P	Q	S	T	U	V	W	Y	Z	AA						
10-/21-AW20	1/8, 1/4	1/8	40	164	73	52	—	11	25	40	63	5	30	34	44	5.4	15.4	55	2.3	30	28.5	14	6	M28 x 1.5						
10-/21-AW30	1/4, 3/8	1/8	53	208	86	59	30	10.5	25	55	67	3.5	41	40	46	6.5	8	53	2.3	31	38.5	19	7	M38 x 1.5						
10-/21-AW40	1/4, 3/8, 1/2	1/4	70	246	92	75	38	10.5	29	80	75	1.5	50	54	54	8.5	10.5	70	2.3	35.5	42.5	21	7	M42 x 1.5						
10-/21-AW40-06	3/4	1/4	75	249	93	75	38	8	30.5	80	75	1.2	50	54	56	8.5	10.5	70	2.3	37	42.5	21	7	M42 x 1.5						
10-/21-AW60	3/4, 1	1/4	95	416	175	87	47.5	6.5	43	20	80.5	3.2	70	66	66	11	13	90	3.2	—	—	—	—	—						

Dimensions

10-21-AW20K

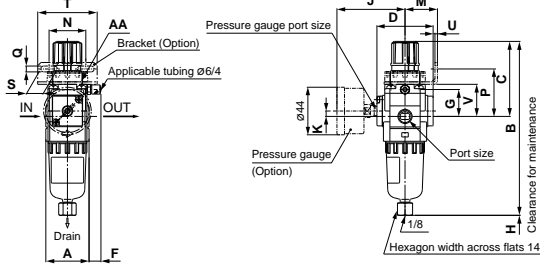

Panel fitting dimension



Plate thickness
10-21-AW20K: Max. 3.5

10-21-AW30K to 40K-06

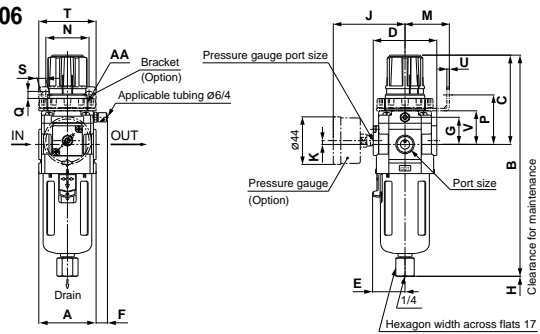

Panel fitting dimension



Plate thickness
10-21-AW30K: Max. 3.5
10-21-AW40K: Max. 5

10-21-AW60K

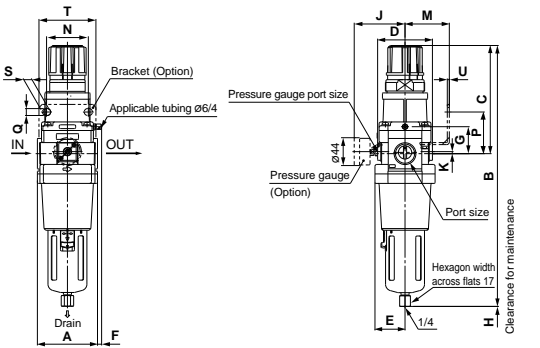

Applicable model	10-21-AW20K		10-21-AW30K to 60K	
Optional specifications	With bowl guard	Metal bowl	Metal bowl	Metal bowl with level gauge
Dimensions				

Model	Optional specifications											
	With bowl guard			Metal bowl			Metal bowl with level gauge					
	B			B			B					
10-21-AW20K	164			167			—					
10-21-AW30K	—			208			228					
10-21-AW40K	—			246			266					
10-21-AW40K-06	—			249			269					
10-21-AW60K	—			416			436					

Model	Port size	Pressure gauge port size	Standard specifications																	Accessory specifications											
																				Bracket mounting size						Panel mount					
			A	B	C	D	E	F	G	H	J	K	M	N	P	Q	S	T	U	V	W	Y	Z	AA							
10-21-AW20K	1/8, 1/4	1/8	40	164	73	52	—	11	25	40	63	5	30	34	44	5.4	15.4	55	2.3	30	28.5	14	6	M28 x 1							
10-21-AW30K	1/4, 3/8	1/4	53	208	86	59	30	10.5	25	55	67	3.5	41	40	46	6.5	8	53	2.3	31	38.5	19	7	M38 x 1.5							
10-21-AW40K	1/4, 3/8, 1/2	1/4	70	246	92	75	38	10.5	29	80	75	1.5	50	54	54	8.5	10.5	70	2.3	35.5	42.5	21	7	M42 x 1.5							
10-21-AW40K-06	3/4	1/4	75	249	93	75	38	8	30.5	80	75	1.2	50	54	56	8.5	10.5	70	2.3	37	42.5	21	7	M42 x 1.5							
10-21-AW60K	3/4, 1	1/4	95	416	175	87	47.5	6.5	43	20	80.5	3.2	70	66	66	11	13	90	3.2	—	—	—	—	—							

Directional Control Valves
Air Cylinders
Rotary Actuators
Air Grippers
Air Preparation Equipment
Modular F. R.
Pressure Control Equipment
Fittings & Tubing
Flow Control Equipment
Pressure Switches/Pressure Sensors

Series 10-21-AWM

Mist Separator Regulator

Series 10-21-AWD

Micro Mist Separator Regulator

How to Order

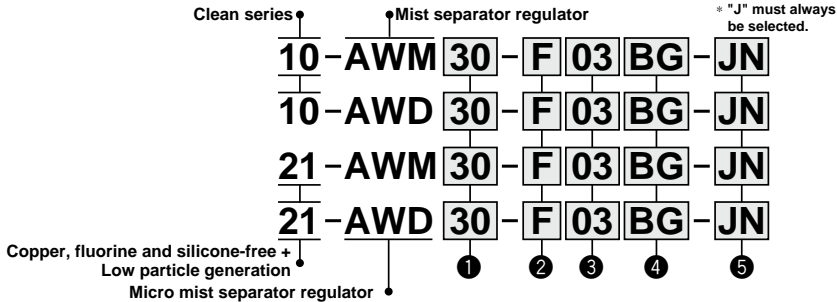

- Option/Semi-standard: Select one each for a to g.
- Option/Semi-standard symbol: When more than one specification is required, indicate in alphanumeric order.

	Symbol	Description	① Body size			
			20	30	40	
② Thread type	Nil	Rc	●	●	●	
	N <small>Note 1)</small>	NPT	●	●	●	
	F <small>Note 2)</small>	G	●	●	●	
	+					
③ Port size	01	1/8	●	—	—	
	02	1/4	●	●	●	
	03	3/8	—	●	●	
	04	1/2	—	—	●	
	+					
④ Option	a Mounting	Nil	Without mounting option	●	●	●
		B <small>Note 4)</small>	With bracket	●	●	●
		H	With set nut	●	●	●
	+					
b Pressure gauge	Nil	Without pressure gauge	●	●	●	
	G	Round type pressure gauge (without limit indicator)	●	●	●	
	+					
⑤ Semi-standard	c Set pressure	Nil	0.05 to 0.85 MPa setting	●	●	●
		1 <small>Note 5)</small>	0.05 to 0.2 MPa setting	●	●	●
	+					
	d Bowl	Nil	Polycarbonate bowl	●	●	●
		2	Metal bowl	●	●	●
6		Nylon bowl	●	●	●	
8		Metal bowl with level gauge	—	●	●	
C		With bowl guard	●	—	—	
6C	Nylon bowl with bowl guard	●	—	—		
+						
J Drain port <small>Note 6)</small>	Nil	Drain guide 1/8	●	—	—	
	J	Drain guide 1/4	—	●	●	

	Symbol	Description	①		
			Body size		
			20	30	40
5	e	+			
		Nil	Relieving type		
	N	Non-relieving type			
	f	+			
		Nil	Flow direction: Left to right		
	R	Flow direction: Right to left			
	g	+			
		Nil	Name plate, caution plate for bowl, and pressure gauge in imperial units: MPa		
	Z	Note 7)	Name plate, caution plate for bowl, and pressure gauge in imperial units: psi		
				●	●
			○	○	○

Note 1) Drain guide is NPT1/8 (applicable to the 10-21-AWM20, AWD20) and NPT1/4 (applicable to the 10-21-AWM30, AWM40, AWD30, AWD40).
 Note 2) Drain guide is G1/8 (applicable to the 10-21-AWM20, AWD20) and G1/4 (applicable to the 10-21-AWM30, AWM40, AWD30, AWD40).
 Note 3) Option B, G, H are not assembled and supplied loose at the time of shipment.
 Note 4) Assembly of a bracket and set nuts
 Note 5) The only difference from the standard specifications is the adjusting spring for the regulator. It does not restrict the setting of 0.2 MPa or more.
 When the pressure gauge is attached, a 0.2 MPa pressure gauge will be fitted.
 Note 6) Be sure to select "J" drain guide. Without a valve function
 Note 7) For thread type: NPT. This product is for overseas use only according to the new Measurement Law. (The SI unit type is provided for use in Japan.)
 Note 8) ○: For thread type: NPT only

Standard Specifications

Model	10-21-AWM20 10-21-AWD20	10-21-AWM30 10-21-AWD30	10-21-AWM40 10-21-AWD40
Port size	1/8, 1/4	1/4, 3/8	1/4, 3/8, 1/2
Pressure gauge port size	1/8		1/4
Fluid	Air		
Ambient and fluid temperature	-5 to 60°C (with no freezing)		
Proof pressure	1.5 MPa		
Maximum operating pressure	1.0 MPa		
Set pressure range	0.05 to 0.85 MPa		
Relief pressure	Set pressure + 0.05 MPa [at relief flow rate of 0.1 L/min (ANR)]		
Nominal filtration rating	10-21-AWM: 0.3 μm (99.9% filtered particle size)		
	10-21-AWD: 0.01 μm (99.9% filtered particle size)		
Outlet side oil mist concentration <small>Note 1)</small>	10-21-AWM: Max. 1.0 mg/m ³ (ANR) (= 0.8 ppm)		
	10-21-AWD: Max. 0.1 mg/m ³ (ANR) (Before saturated with oil 0.01 mg/m ³ (ANR) or less = 0.008 ppm)		
Rated flow (L/min (ANR)) <small>Note 2)</small>	10-21-AWM: 150	10-21-AWM: 330	10-21-AWM: 820
	10-21-AWD: 90	10-21-AWD: 180	10-21-AWD: 450
Drain capacity (cm³)	8	25	45
Drain guide port size	1/8	1/4	
Construction	Relieving type		
Grease	10-: Fluorine grease		
	21-: Lithium soap based grease		
Cleanliness class (ISO class)	10-: Class 3		
	21-: Class 3		

Note 1) When the compressor oil mist discharge concentration is 30 mg/m³ (ANR). Bowl O-ring and other O-rings are slightly lubricated.
 Note 2) Conditions: Mist separator inlet pressure: 0.7 MPa; outlet pressure: 0.5 MPa. The rated flow varies depending on the outlet pressure. Keep the air flow within the rated flow to prevent an outflow of lubricant to the outlet side.

Options/Part No.

Model	10-21-AWM20 10-21-AWD20	10-21-AWM30 10-21-AWD30	10-21-AWM40 10-21-AWD40
Option			
Bracket assembly <small>Note 3)</small>	AW20P-270AS	AR30P-270AS	AR40P-270AS
Set nut	AR20P-260S	AR30P-260S	AR40P-260S
Pressure gauge <small>Note 4)</small>	Standard		10: G49-10-□□01, 21: G49-10-□□01-MS-X3
	0.02 to 0.2 MPa setting		10: G49-2-□□01, 21: G49-2-□□01-MS-X3

Note 3) Assembly of a bracket and set nuts
 Note 4) □ in part numbers for a round pressure gauge indicates a type of connection thread. No indication is necessary for R; however, indicate N for NPT.
 Please contact SMC regarding the connection thread NPT and pressure gauge supply for psi unit specifications.

Dimensions

10-21-AWM20

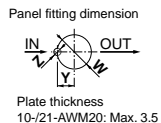
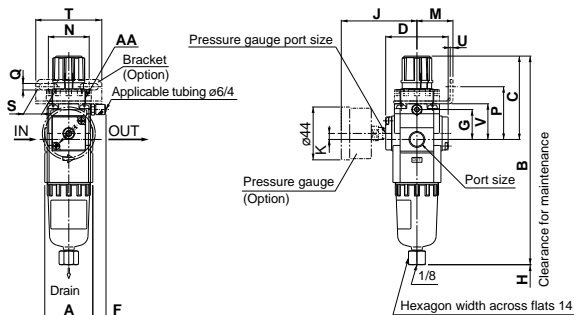

10-21-AWM30/40

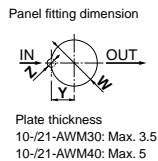
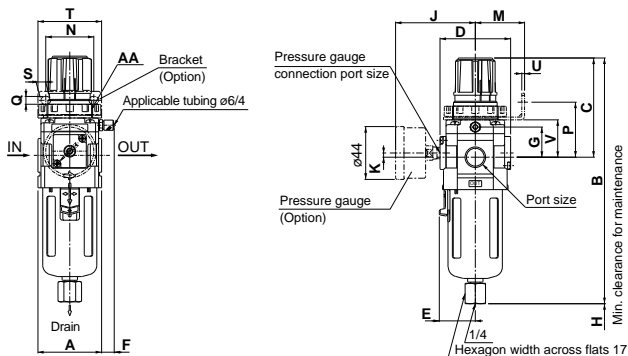

Applicable model	10-21-AWM20				10-21-AWM30/40			
Optional specifications	With bowl guard	Metal bowl	Metal bowl	Metal bowl with level gauge				
Dimensions								

Model	Port size	Pressure gauge connection port size	Standard specifications																	Accessory specifications				
			A	B	C	D	E	F	G	H	J	K	M	N	P	Q	S	T	U	V	W	Y	Z	AA
10-21-AWM20	1/8, 1/4	1/8	40	177	73	52	—	11	25	45	63	5	30	34	44	5.4	15.4	55	2.3	30	28.5	14	6	M28 x 1
10-21-AWM30	1/4, 3/8	1/8	53	208	86	59	30	10.5	25	50	67	3.5	41	40	46	6.5	8	53	2.3	31	38.5	19	7	M38 x 1.5
10-21-AWM40	1/4, 3/8, 1/2	1/4	70	246	92	75	38	10.5	29	70	75	1.5	50	54	54	8.5	10.5	70	2.3	35.5	42.5	21	7	M42 x 1.5

Model	Optional specifications		
	With bowl guard	Metal bowl	Metal bowl with level gauge
10-21-AWM20	B 177	B 180	B —
10-21-AWM30	—	208	228
10-21-AWM40	—	246	266

Dimensions

10-21-AWD20

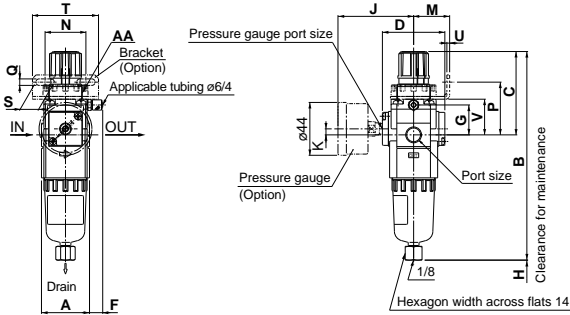

Panel fitting dimension

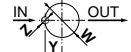
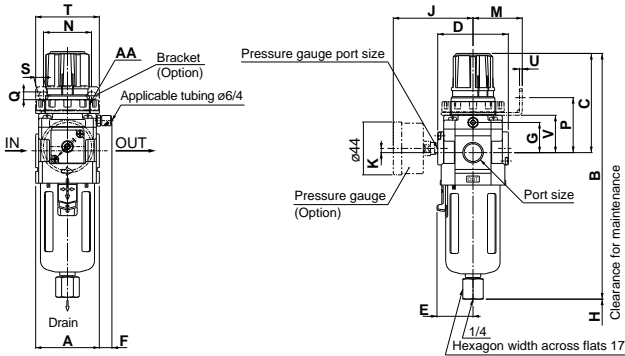

Plate thickness
10-/21-AWD20: Max. 3.5

10-21-AWD30/40



Panel fitting dimension



Plate thickness
10-/21-AWD30: Max. 3.5
10-/21-AWD40: Max. 5

Applicable model	10-/21-AWD20			10-/21-AWD30/40			
Optional specifications	With bowl guard	Metal bowl		Metal bowl	Metal bowl with level gauge		
Dimensions							

Model	Port size	Pressure gauge port size	Standard specifications																	Accessory specifications					
			A	B	C	D	E	F	G	H	J	K	M	N	P	Q	S	T	U	V	W	Y	Z	AA	
10-/21-AWD20	1/8, 1/4	1/8	40	177	73	52	—	11	25	45	63	5	30	34	44	5.4	15.4	55	2.3	30	28.5	14	6	M28 x 1	
10-/21-AWD30	1/4, 3/8	1/8	53	208	86	59	30	10.5	25	50	67	3.5	41	40	46	6.5	8	53	2.3	31	38.5	19	7	M38 x 1.5	
10-/21-AWD40	1/4, 3/8, 1/2	1/4	70	246	92	75	38	10.5	29	70	75	1.5	50	54	54	8.5	10.5	70	2.3	35.5	42.5	21	7	M42 x 1.5	

Model	Optional specifications		
	With bowl guard	Metal bowl	Metal bowl with level gauge
10-/21-AWD20	B	B	B
10-/21-AWD20	177	180	—
10-/21-AWD30	—	208	228
10-/21-AWD40	—	246	266

Directional Control Valves
Air Cylinders
Rotary Actuators
Air Grippers
Air Preparation Equipment
Modular F. R.
Pressure Control Equipment
Fittings & Tubing
Flow Control Equipment
Pressure Switches/Pressure Sensors



F.R.L. Units Precautions 1

Be sure to read this before handling.

Design / Selection

Warning

1. Check the specifications.

Products represented in this catalog are designed only for use in compressed air systems (including vacuum).

Do not operate at pressures or temperatures, etc., beyond the range of specifications, as this can cause damage or malfunction. (Refer to the specifications.)

Please contact SMC when using a fluid other than compressed air. We do not guarantee against any damage if the product is used outside of the specification range.

2. The standard bowl for the air filter, filter regulator, and lubricator, as well as the sight dome for the lubricator are made of polycarbonate. Do not use in an environment where they are exposed to or come in contact with organic solvents, chemicals, cutting oil, synthetic oil, alkali, and thread lock solutions.

Effects of atmosphere of organic solvents and chemicals, and where these elements are likely to adhere to the equipment. Chemical data for substances causing degradation (Reference)

Type	Chemical name	Application examples	Material	
			Polycarbonate	Nylon
Acid	Hydrochloric acid	Acid washing liquid for metals	△	×
	Sulfuric acid, Phosphoric acid Chromic acid			
Alkaline	Sodium hydroxide (Caucstic soda)	Degreasing of metals Industrial salts Water-soluble cutting oil	×	○
	Potash			
	Calcium hydroxide (Slack lime)			
	Ammonia water Carbonate of soda			
Inorganic salts	Sodium sulfide	—	×	△
	Sulfate of potash			
	Sulfate of soda			
Chlorine solvents	Carbon tetrachloride	Cleansing liquid for metals Printing ink Dilution	×	△
	Chloroform			
	Ethylene chloride			
	Methylene chloride			
Aromatic series	Benzene	Coatings Dry cleaning	×	△
	Toluene			
	Paint thinner			
Ketone	Acetone	Photographic film Dry cleaning Textile industries	×	×
	Methyl ethyl ketone			
	Cyclohexane			
Alcohol	Ethyl alcohol	Antifreeze Adhesives	△	×
	IPA			
	Methyl alcohol			
Oil	Gasoline	—	×	○
	Kerosene			
Ester	Phthalic acid dimethyl	Synthetic oil Anti-rust additives	×	○
	Phthalic acid dimethyl			
	Acetic acid			
Ether	Methyl ether	Brake oil additives	×	○
	Ethyl ether			
Amino	Methyl amino	Cutting oil Brake oil additives Rubber accelerator	×	×
Other	Thread-lock fluid	—	×	△
	Seawater			
	Leak tester			

○: Essentially safe △: Some effects may occur ×: Effects will occur

When the above factors are present, or there is some doubt, use a metal case for safety.

- Do not use in such a way as to frequently fill in or release the pressure from the standard bowls such as the air filter, filter regulator, lubricator, etc. Damage to the bowl may occur. A metal bowl is recommended in these cases.
- Please consult with SMC if the intended application calls for absolutely zero leakage due to special atmospheric requirements or if the use of a fluid other than air is required.
- The mineral grease used on internal sliding parts and seals may come in contact with outlet side components. Please consult with SMC if this is not desirable. Please contact SMC if the Material Safety Data Sheet (MSDS) of the grease is required.
- Do not disassemble the product or make any modifications, including additional machining. It may cause human injury and/or an accident.

Caution

- Select a model that is suitable for the desired air cleanliness by referring to SMC Best Pneumatics catalog.

Mounting

Warning

- Operation manual**
Install the products and operate them only after reading the operation manual carefully and understanding its contents. Also, keep the manual where it can be referred to as necessary.
- Ensure sufficient space for maintenance activities.**
When installing the products, allow access for maintenance.
- Tighten threads with the proper tightening torque.**
When installing the products, follow the listed torque specifications.

Caution

- To avoid reversed connections of the air inlet/outlet, make connections after confirming the “IN/OUT” mark or arrows that indicate the direction of air flow. Reversed connections can cause malfunction.
- Components with a bowl, e.g., air filter, filter regulator, lubricator, must be installed vertically with the bowl downward so that faulty drain discharge and dripping can be verified.
- Ensure sufficient top, bottom and front clearance for maintenance and operation of each component. Refer to the dimensions section for the minimum clearance of each component.



F.R.L. Units Precautions 2

Be sure to read this before handling.

Piping

⚠ Warning

1. To screw a piping material into a component, tighten with the recommended tightening torque while holding the female thread side.

If the tightening torque is not enough, looseness and seal failure can occur. On the other hand, excess tightening torque can cause damage to the threads. Furthermore, tightening without holding the female thread side can cause damage due to the excess force that is applied directly to the piping bracket.

Recommended Tightening Torque [N·m]

Connection thread	M5	1/8	1/4	3/8	1/2	3/4	1	1 1/4	1 1/2	2
Torque	1 to 1.5 ^{*1}	7 to 9	12 to 14	22 to 24	28 to 30	28 to 30	36 to 38	40 to 42	48 to 50	48 to 50

*1 After tightening by hand, use a tightening tool to tighten an additional 1/6 to 1/4 turn as a guideline.

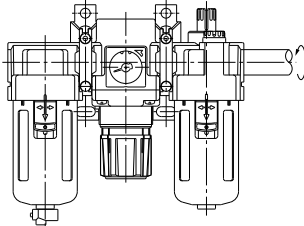

2. Avoid excessive torsional moment or bending moment other than those caused by the equipment's own weight as this can cause damage.

Support external piping separately.

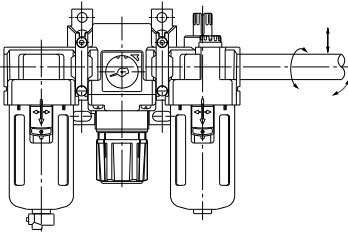

3. Piping materials without flexibility such as steel tube piping, are prone to be effected by excess moment load and vibration from the piping side. Use flexible tubing in between to avoid such an effect.

⚠ Caution

1. Preparation before piping

Before piping is connected, it should be thoroughly blown out with air (flushing) or washed to remove chips, cutting oil and other debris from inside the pipe.

⚠ Caution

2. Winding of sealant tape

When screwing piping or fittings into ports, ensure that chips from the pipe threads or sealing material do not enter the piping. Also, if sealant tape is used, leave 1.5 to 2 thread ridges exposed at the end of the threads.

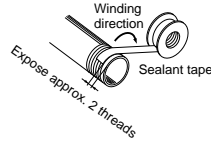

3. Refer to the Fittings and Tubing Precautions (pages 1237 to 1240) for handling One-touch fittings.

Air Supply

⚠ Warning

1. Type of fluids

Please consult with SMC when using the product in applications other than compressed air.

2. Take measures to ensure air quality, such as by installing an aftercooler, air dryer, or water separator.

Compressed air that contains a large amount of drainage can cause malfunction of pneumatic equipment such as filters, regulators, and lubricators. Therefore, take appropriate measures to ensure air quality, such as by providing an aftercooler, air dryer, or water separator.

3. Drain flushing

If condensation in the drain bowl is not emptied on a regular basis, the bowl will overflow and allow the condensation to enter the compressed air lines. It causes malfunction of pneumatic equipment.

If the drain bowl is difficult to check and remove, installation of a drain bowl with an auto drain option is recommended.

For compressed air quality, refer to Air Preparation Equipment Selection Guide (Best Pneumatics No. 5).

4. Use clean air.

Do not use compressed air that contains chemicals, synthetic oils including organic solvents, salt or corrosive gases, etc., as it can cause damage or malfunction.

When synthetic oil is used for the compressor oil, depending on the type of synthetic oil used, or on the conditions of use, there may be adverse effects on the resin of the pneumatic equipment or on the seals if the oil is flowed out to the outlet side, so the mounting of a main line filter is recommended.

Directional Control Valves

Air Cylinders

Rotary Actuators

Air Grippers

Air Preparation Equipment

Modular F. R.

Pressure Control Equipment

Fittings & Tubing

Flow Control Equipment

Pressure Switches/ Pressure Sensors



F.R.L. Units Precautions 3

Be sure to read this before handling.

Air Supply

Caution

1. **Ensure that the fluid and ambient temperature are within the specified range.**

When using at low temperatures, drain or moisture could solidify or freeze, causing damage to the seals and equipment malfunction. If the fluid temperature is less than 5°C, the moisture in the circuit could freeze, causing damage to the seals and equipment malfunction. Therefore, take appropriate measures to prevent freezing.

For compressed air quality, refer to Air Preparation Equipment Selection Guide (Best Pneumatics No. 5).

Operating Environment

Warning

1. **Do not use in an atmosphere having corrosive gases, chemicals, sea water, water, water steam, or where there is direct contact with any of these.**
Refer to each drawing on the F.R.L. units material.
2. **Do not expose the product to direct sunlight for an extended period of time.**
3. **Do not use in a place subject to heavy vibration and/or shock.**
4. **Do not mount the product in locations where it is exposed to radiant heat.**

Maintenance

Warning

1. **Perform maintenance inspection according to the procedures indicated in the operation manual.**

If handled improperly, malfunction and damage of machinery or equipment may occur.

2. **Maintenance work**

If handled improperly, compressed air can be dangerous. Assembly, handling, repair and element replacement of pneumatic systems should be performed by a knowledgeable and experienced person.

3. **Drain flushing**

Remove drainage from air filters regularly.

4. **Removal of equipment, and supply/exhaust of compressed air**

When components are removed, first confirm that measures are in place to prevent workpieces from dropping, run-away equipment, etc. Then, cut off the supply pressure and electric power, and exhaust all compressed air from the system using the residual pressure release function.

When machinery is restarted, proceed with caution after confirming that appropriate measures are in place to prevent cylinders from sudden movement.

5. **Perform periodical inspections to detect any cracks, scratches, or other deterioration of the transparent resin bowl of the air filter, filter regulator, and lubricator or the sight dome of the lubricator.**

Replace with a new bowl, sight dome, or metal bowl when any kind of deterioration is found. Otherwise, damage may occur.

6. **Perform periodical inspections to detect dirt on the transparent resin bowl of the air filter, filter regulator, and lubricator or the sight dome of the lubricator.**

When you find dirt on any of the above devices, clean with a mild household cleanser. Do not use other cleaning agents. Otherwise, this can cause damage.

Caution

1. **Perform periodical inspections of the filter element and replace it as necessary. Check the element whenever the outlet pressure drops below normal or air does not flow smoothly during operation.**



F.R.L. Units Precautions 4

Be sure to read this before handling.

Regulator / Filter Regulator Design / Selection

⚠ Warning

1. Attach a safety device if damage or malfunction of equipment and devices on the outlet side may result from the output pressure exceeding the set pressure.
2. Residual pressure release (outlet pressure release) is not complete by releasing the inlet pressure. To release residual pressure, select a model with a back flow mechanism. Using a model without a back flow mechanism causes unstable residual pressure release (i.e., residual pressure may or may not be released) depending upon the operating conditions.
3. Please contact SMC if air will not be consumed in the system for long periods of time, or if the outlet side will be used with a sealed circuit and a balanced circuit, since this may cause the set pressure of the outlet side to fluctuate.
4. Set the outlet pressure range for the regulator in a range that is 85% or less of the inlet pressure. If set above 85%, the inlet pressure will be easily effected by fluctuations in the flow rate and inlet pressure, and will become unstable.
5. Since a safety margin is calculated into the maximum regulating pressure value of set pressure range appearing in the catalog's specification table, the set pressure may exceed the range.
6. Please contact SMC when a circuit requires the use of a regulator having relief sensitivity with high precision and setting accuracy.

⚠ Caution

1. Air consumption is 0.1 L/min. (ANR) or less under standard operation specifications. Please consult with SMC if this value is not allowable.

Mounting

⚠ Caution

1. When adjusting the pressure, unlock the knob first, and lock it back after the pressure is set.

Adjustment

⚠ Warning

1. Set the regulator while verifying the displayed values of the inlet and outlet pressure gauges. Turning the knob excessively can cause damage to the internal parts.
2. Do not use a tool on the pressure regulator knob as this can cause damage. It must be operated by hand.

Regulator / Filter Regulator Adjustment

⚠ Caution

1. Check the inlet pressure before setting.
2. The pressure gauge included with products for 0.02 to 0.2 MPa setting is for up to 0.2 MPa only. Do not apply pressure exceeding 0.2 MPa. It can damage the pressure gauge.
3. To set the pressure using the knob, turn the knob in the direction that increases pressure and lock the knob after the pressure is set. If this is done in the direction that decreases pressure, the pressure may drop from the original set pressure. Turning the knob clockwise increases the outlet pressure, and turning it counterclockwise reduces the pressure.

Lubricator

Design / Selection

⚠ Warning

1. Select a lubricator with a fixed throttle when the lubricator is used in high frequency operations, such as in a press machine.
When selecting a model, it is necessary to select the passage area of the fixed throttle, so please consult with SMC.
2. Lubrication cannot be properly performed if the operating flow rate is too low. Select proper size lubricator by referring the minimum dripping flow rate provided in this catalog.
3. Mount a residual pressure removal 3-port valve on the inlet side, and avoid the use of a lubricator that causes back flow as this may cause damage to internal parts.
4. Use a check valve (Series AKM) to prevent the back flowing of lubricant when the piping is branched at the inlet side.

Piping

⚠ Caution

1. Avoid riser piping and branch lines on the outlet side to prevent inferior lubrication.

Maintenance

⚠ Warning

1. Use class 1 turbine oil (without additives) ISO VG32. Using other lubricant can cause damage to devices and result in malfunction.
2. For the AL10, 20 type, supply the lubricant after releasing the inlet pressure since the lubricant cannot be applied under pressurized condition.

⚠ Caution

1. Check the usage rate once a day. If the lubricant is not normally consumed, problems may occur to the lubricated objects.

Directional
Control Valves

Air Cylinders

Rotary Actuators

Air Grippers

Air Preparation
Equipment

Modular F. R.

Pressure Control
Equipment

Fittings & Tubing

Flow Control
Equipment

Pressure Switches/
Pressure Sensors



F.R.L. Units Precautions 5

Be sure to read this before handling.

Mist Separator / Micro Mist Separator

Design / Selection

⚠ Caution

1. Design the system so that a mist separator and a micro mist separator are installed where a pulsation is not likely to be generated. The pressure difference between the internal and external pressure inside the element should be kept within 0.1 MPa, since exceeding this value can cause damage.

Maintenance

⚠ Warning

1. To prevent damage to the filter element, replace it every 2 years or when the pressure drop becomes 0.1 MPa, whichever comes first.
2. Release accumulated condensation inside of an air filter bowl periodically and before the accumulation reaches the maximum capacity. If accumulated condensation flows out to the outlet side, it can cause malfunction.

Air Filter

Maintenance

⚠ Warning

1. To prevent damage to the element, replace the element every 2 years or when the pressure drop becomes 0.1 MPa, whichever comes first.
2. Release accumulated condensation inside of an air filter case periodically and before the accumulation reaches the maximum capacity. If accumulated condensation flows out to the outlet side, it can cause malfunction.

Air Combination

Design / Selection

⚠ Caution

1. When using a 2-unit combination such as the AC□0A, AC□0B and AC□0D, secure the top and bottom of the bracket. For 3-unit, securing the bottom side of the bracket is recommended.
2. The bracket position varies depending on the attachment (T-interface or pressure switch) mounting.
3. The standard mounting position for a bracket is OUT side of each component (the AF, AR, AL, AW and AFM). For the standard mounting position dimension for a bracket by mounting an attachment, refer to Best Pneumatics No. 5.
4. A bracket cannot be mounted on both sides of a T-interface or a pressure switch.
5. Please contact SMC if you wish to change the bracket mounting position.

Float Type Auto Drain

Design / Selection

⚠ Warning

1. Use an auto drain under the following conditions to avoid malfunction.

<N.O. type>

- Operating compressor: 0.75 kW (100 L/min. (ANR)) or more
When using 2 or more auto drains, multiply the above value by the number of auto drains to find the minimum capacity of the required compressors.
Selecting a model with a minimum or larger required capacity is recommended. For example, when using 2 auto drains, a compressor capacity of at least 1.5 kW (200 L/min. (ANR)) is required.
- Operating pressure: 0.1 MPa or more

<N.C. type>

- Operating pressure for AD17/27: 0.1 MPa or more
Operating pressure for AD37/47: 0.15 MPa or more

Piping

⚠ Caution

1. Float type auto drain

Drain piping should be performed under the following conditions to avoid malfunction.

<N.O. type>

- Use piping whose I.D. is $\phi 6.5$ or larger, and whose length is 5 m or less. Avoid riser piping.

<N.C. type>

- AD17/27: Use piping with an I.D. of $\phi 2.5$ or larger.
AD37/47: Use piping with an I.D. of $\phi 4$ or larger.
Length is 5 m or less. Avoid riser piping.

Maintenance

⚠ Caution

1. Turn the knob counterclockwise to release the drainage manually. Avoid applying excessive torque to the knob, such as by using a tool, as this can damage an auto drain.

After releasing the condensation, turn the knob clockwise until it stops.

2. Air leakage or other performance malfunction can occur if premature clogging of the element or pressure drop causes the pressure inside the bowl to deviate from the specified pressure range parameters.

Check the pressure whenever such an irregularity occurs.

For Clean Room

Pressure Control Equipment

Contents	Series	Page
Direct Operated Precision Regulator	10- 21 -ARP	P.1093
Direct Operated Precision Regulator with Backflow Function	10- 21 -ARP□K	P.1093
Precision Regulator	10-IR1000/2000/3000	P.1101
Vacuum Regulator	10-IRV10/20	P.1106
Clean Regulator	SRH	P.1114
Precision Clean Regulator	SRP	P.1118

Directional
Control Valves

Air Cylinders

Rotary Actuators

Air Grippers

Air Preparation
Equipment

Modular F. R.

Pressure Control
Equipment

Fittings & Tubing

Flow Control
Equipment

Pressure Switches/
Pressure Sensors

Series 10-21-ARP20 to 10-21-ARP40 Direct Operated Precision Regulator

Series 10-21-ARP20K to 10-21-ARP40K Direct Operated Precision Regulator with Backflow Function



- Clean room compliant (10-ARP).
- Clean room compliant, copper-free, fluorine-free, silicone-free (21-ARP).
- With the backflow function it incorporates a mechanism to exhaust the air pressure in the outlet side reliably and quickly.

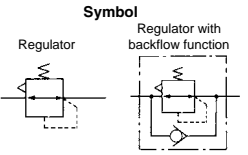
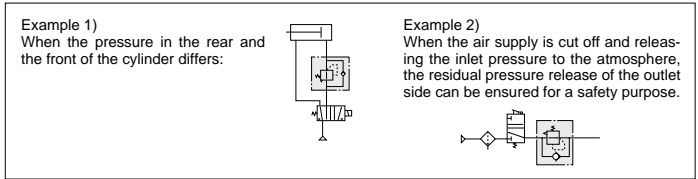

How to Order

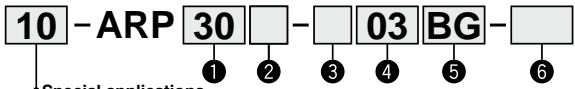

Special applications

10	Clean room compliant
21	Clean room compliant, copper-free, fluorine-free, silicone-free

• Option / Semi-standard: Select one each for a to f.
 • Option / Semi-standard symbol: Enter them alphanumerically.
 Example) 10-ARP30K-03BG-1RY

Clean room compliant	<ul style="list-style-type: none"> • Less particle generation in a clean room • Grease: Fluorine type • Packaging: Double packaging
Clean room compliant, copper-free, fluorine-free, silicone-free	<ul style="list-style-type: none"> • Less particle generation in a clean room • Wetted parts: Aluminum die-cast • Stainless steel, HNBR, NBR • Grease: Lithium soap based type

	Symbol	Description	①			①		
			Body size			Body size		
			20	30	40	20	30	40
② With backflow function	Nil	Without backflow function	●	●	●	●	●	●
	K	With backflow function	●	●	●	●	●	●
③ Thread type	Nil	Rc	●	●	●	●	●	●
	N	NPT	●	●	●	●	●	●
	F	G	●	●	●	●	●	●
④ Port size	01	1/8	●	—	—	●	—	—
	02	1/4	—	●	—	—	●	—
	03	3/8	—	●	●	—	●	●
	04	1/2	—	—	●	—	—	●
a Mounting	Nil	Without mounting option	●	●	●	●	●	●
	B <small>Note 2)</small>	With bracket	●	●	●	●	●	●
	H	With set nut (For panel mount)	●	●	●	●	●	●
⑤ Option 1) Digital pressure switch	Nil	Without pressure gauge	●	●	●	●	●	●
	G	Round type pressure gauge (Without limit indicator)	●	●	●	●	●	●
	E1 <small>Note 3)</small>	Output: NPN output / Electrical entry: Wiring bottom entry	●	●	●	—	—	—
	E2 <small>Note 3)</small>	Output: NPN output / Electrical entry: Wiring top entry	●	●	●	—	—	—
	E3 <small>Note 3)</small>	Output: PNP output / Electrical entry: Wiring bottom entry	●	●	●	—	—	—
E4 <small>Note 3)</small>	Output: PNP output / Electrical entry: Wiring top entry	●	●	●	—	—	—	





¹⁰⁻₂₁₋ARP20/ARP20K ¹⁰⁻₂₁₋ARP30/ARP30K ¹⁰⁻₂₁₋ARP40/ARP40K

Directional Control Valves
Air Cylinders
Rotary Actuators
Air Grippers
Air Preparation Equipment
Modular F. R.
Pressure Control Equipment
Fittings & Tubing
Flow Control Equipment
Pressure Switches/ Pressure Sensors

	Symbol	Description	①			①				
			Body size			Body size				
			20	30	40	20	30	40		
⑥ Semi-standard	c	Set pressure	Nil	0.005 to 0.4 MPa setting	●	●	●	●	●	●
			1 ^{Note 4)}	0.005 to 0.2 MPa setting	●	●	●	●	●	●
			3 ^{Note 4)}	0.008 to 0.6 MPa setting	●	●	●	●	●	●
		+								
	d	Flow direction	R	Flow direction: Left to right	●	●	●	●	●	●
			R	Flow direction: Right to left	●	●	●	●	●	●
		+								
	e	Knob	Nil	Downward facing knob	●	●	●	●	●	●
			Y	Upward facing knob	●	●	●	●	●	●
		+								
	f	Pressure unit	Nil	Name plate and pressure gauge in imperial units: MPa	●	●	●	●	●	●
			Z ^{Note 5)}	Name plate and pressure gauge in imperial units: psi	○ ^{Note 7)}	○ ^{Note 7)}	○ ^{Note 7)}	○ ^{Note 7)}	○ ^{Note 7)}	○ ^{Note 7)}
ZA ^{Note 6)}			Digital pressure switch: With unit conversion function	△ ^{Note 8)}	△ ^{Note 8)}	△ ^{Note 8)}	—	—	—	

Note 1) Options B, G, H are shipped together, (but not assembled).
 Note 2) Set nut is included for bracket.
 Note 3) When choosing with H (panel mount), the installation space for lead wires will not be secured. In this case, select "wiring top entry" for the lead wire entry. (Select "wiring bottom entry" when the semi-standard Y is chosen simultaneously.)
 Note 4) The only difference from the standard specifications is the pressure regulator spring.
 It does not restrict the setting of 0.2 MPa/0.6 MPa or more.
 When the pressure gauge is attached, a 0.2 MPa pressure gauge for 0.2 MPa setting will be fitted, and a 0.7 MPa pressure gauge for 0.6 MPa setting will be fitted.

Note 5) For thread type: NPT. This product is for overseas use only according to the new Measurement Law. (The SI unit type is provided for use in Japan.) The digital pressure switch will be equipped with the unit conversion function, setting to psi initially.
 Note 6) For options: E1, E2, E3, E4. This product is for overseas use only according to the new Measurement Law. (The SI unit is provided for use in Japan.)
 Note 7) ○ : For thread type, NPT only.
 Note 8) △ : Combination available for options : E1, E2, E3, E4.

Direct Operated Precision Regulator Series 10-~~21~~-ARP20 to 10-~~21~~-ARP40

Direct Operated Precision Regulator with Backflow Function Series 10-~~21~~-ARP20K to 10-~~21~~-ARP40K

Specifications

Model			10-ARP20 (K)	10-ARP30 (K)	10-ARP40 (K)
Port size			1/8, 1/4	1/4, 3/8	1/4, 3/8, 1/2
Fluid			Air		
Proof pressure			1.2 MPa		
Maximum operating pressure			0.7 MPa		
Set pressure range ^{Note 1)}	0.4 MPa setting	(Ex.)10-ARP30-02BG	0.005 to 0.4 MPa		
	0.2 MPa setting	(Ex.)10-ARP30-02BG-1	0.005 to 0.2 MPa		
	0.6 MPa setting	(Ex.)10-ARP30-02BG-3	0.008 to 0.6 MPa		
Setting sensitivity			Within 0.2% F.S.		
Repeatability ^{Note 2)}			Within ±1% F.S. (or ±3 kPa)		
Air consumption	0.4 MPa setting	(Ex.)10-ARP30-02BG	1 L/min [ANR] or less (at P2 = 0.4 MPa)		
	0.2 MPa setting	(Ex.)10-ARP30-02BG-1	0.6 L/min [ANR] or less (at P2 = 0.2 MPa)		
	0.6 MPa setting	(Ex.)10-ARP30-02BG-3	1.4 L/min [ANR] or less (at P2 = 0.6 MPa)		
Pressure gauge port size			1/8	1/8	1/4
Ambient and fluid temperature			-5 to 60°C (No freezing)		
	With a digital pressure switch	(Ex.)10-ARP30-02BE1	-5 to 50°C (No freezing)		
Construction			Bleed type		
Weight (kg) ^{Note 3)}			0.2	0.3	0.5

Note 1) When a product with backflow function (10-ARP20K to 40K) is chosen, set the inlet pressure 0.05 MPa or higher than the set pressure.

Note 2) For the type set to 0.2 MPa only, repeatability will be within ±3 kPa.

Note 3) Mass shown is for product without any options.

Optional Parts

Clean Room Compliant (10-)

Model			10-ARP20(K)	10-ARP30(K)	10-ARP40(K)	
Bracket assembly ^{Note 1)}			ARP20P-270AS	ARP30P-270AS	ARP40P-270AS	
Set nut			ARP20P-260S	ARP30P-260S	ARP40P-260S	
Pressure gauge	0.4 MPa	Round type ^{Note 2)}	G49-4-□01		G49-4-□02	
	0.2 MPa		G49-2-□01		G49-2-□02	
	0.7 MPa		G49-7-□01		G49-7-□02	
	Digital type ^{Note 3)}	NPN output / Wiring bottom entry		ISE35-N-25-MLA [ISE35-N-25-M (Switch body only)]		
		NPN output / Wiring top entry		ISE35-R-25-MLA [ISE35-R-25-M (Switch body only)]		
		PNP output / Wiring bottom entry		ISE35-N-65-MLA [ISE35-N-65-M (Switch body only)]		
		PNP output / Wiring top entry		ISE35-R-65-MLA [ISE35-R-65-M (Switch body only)]		

Copper, Fluorine and Silicone-free + Low Particle Generation (21-)

Model			21-ARP20(K)	21-ARP30(K)	21-ARP40(K)
Bracket assembly ^{Note 1)}			ARP20P-270AS	ARP30P-270AS	ARP40P-270AS
Set nut			ARP20P-260S	ARP30P-260S	ARP40P-260S
Pressure gauge	0.4 MPa	Round type ^{Note 2)}	G49-4-□01MS-X3		G49-4-□02MS-X3
	0.2 MPa		G49-2-□01MS-X3		G49-2-□02MS-X3
	0.7 MPa		G49-7-□01MS-X3		G49-7-□02MS-X3

Note 1) Assembly includes a bracket and set nuts.

Note 2) □ in part numbers for a round-type pressure gauge indicates a type of connection thread. No indication is necessary for R; however, indicate N for NPT. The G thread is unavailable. If it is required, select the R thread type (Nil) instead. Please contact SMC regarding the pressure gauge supply for psi unit specifications.

Note 3) Lead wire with connector (2 m), adapter, lock pin, O-ring (1 pc.), and mounting screws (2 pcs.) are included. []: Switch body only.

For how to order the digital pressure switch, refer to the following specific page for the digital pressure switch.

Condition:
Inlet pressure 0.7 MPa

Conditions: Inlet pressure 0.5 MPa Outlet pressure
0.2 MPa Flow rate 20 L/min (ANR)

Flow Rate Characteristics (Representative values)

Pressure Characteristics (Representative values)

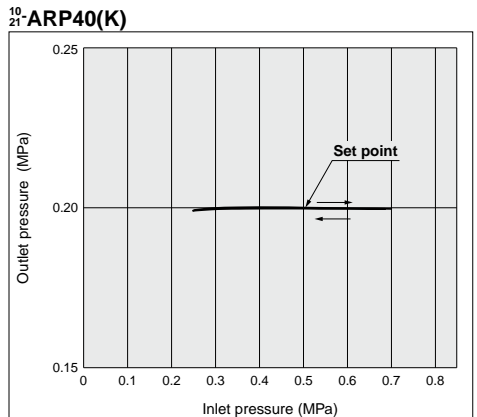
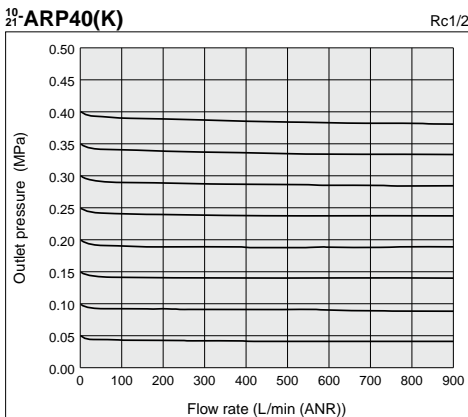
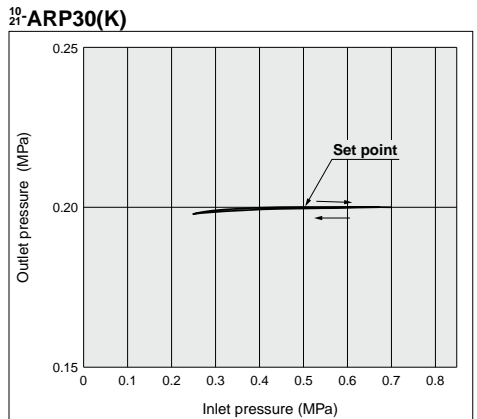
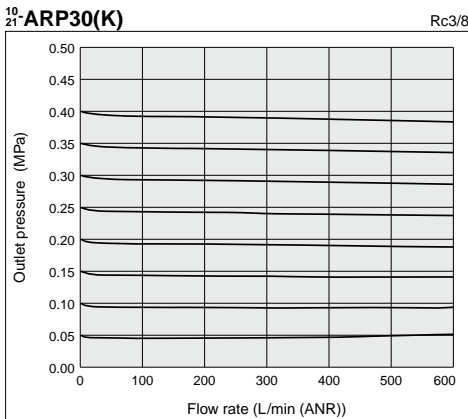
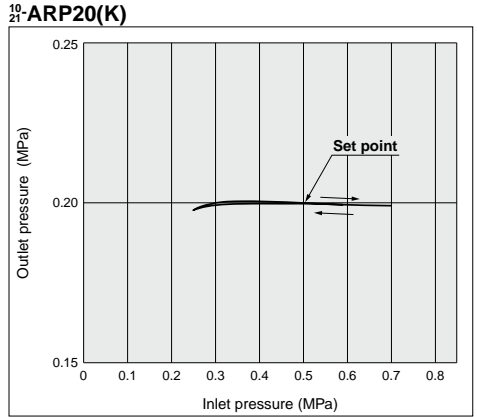
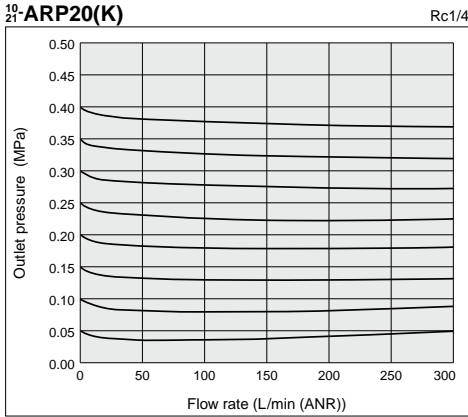

- Directional Control Valves
- Air Cylinders
- Rotary Actuators
- Air Grippers
- Air Preparation Equipment
- Modular F. R.
- Pressure Control Equipment
- Fittings & Tubing
- Flow Control Equipment
- Pressure Switches/ Pressure Sensors

Dimensions

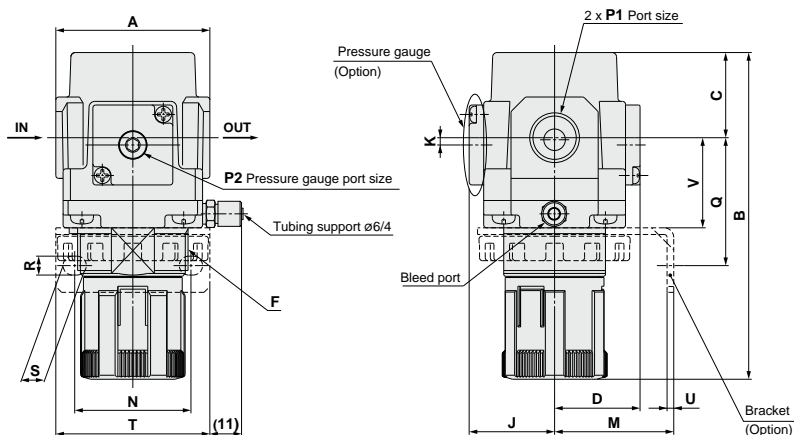

Panel fitting dimension

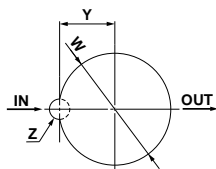
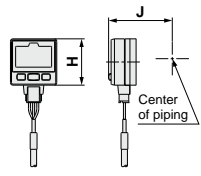
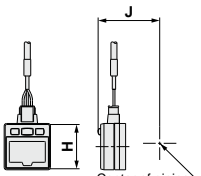
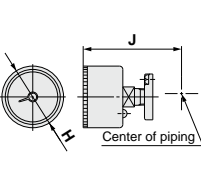

Plate thickness
¹⁰⁻ARP20(K), ARP30(K) : Max. 3.5
¹⁰⁻ARP40(K) : Max. 5

Pressure Gauge Option

Option	Digital pressure switch (Electrical entry: Wiring bottom entry)	Digital pressure switch (Electrical entry: Wiring top entry)	Round type pressure gauge
Dimensions			

Model	Standard specifications									
	P1	P2	A	B ^{Note 1)}	C	D	F	J	K	
¹⁰⁻ ARP20(K)	1/8, 1/4	1/8	40	98	27	28.5	M28 x 1	28.5	2 ^{Note 2)}	
¹⁰⁻ ARP30(K)	1/4, 3/8	1/8	53	117	29	29.5	M38 x 1.5	29.5	2.5	
¹⁰⁻ ARP40(K)	1/4, 3/8, 1/2	1/4	70	148	41	34	M42 x 1.5	34	1	

Model	Optional specifications														
	Digital pressure switch		Round type pressure gauge ^{Note 3)}		Bracket mount dimension						Panel mount				
	H	J	H	J	M	N	Q	R	S	T	U	V	W	Y	Z
¹⁰⁻ ARP20(K)	□27.8	40	ø44	69	30	34	47	5.4	15.4	55	2.3	28	28.5	14	6
¹⁰⁻ ARP30(K)	□27.8	41	ø44	70	41	40	44	6.5	8	53	2.3	31	38.5	19	7
¹⁰⁻ ARP40(K)	□27.8	45	ø44	74	50	54	54	8.5	10.5	70	2.3	35.5	42.5	21	7

Note 1) The total length of B direction is the length when the filter regulator knob is unlocked.
 Note 2) For¹⁰⁻ARP20(K) only, the position of pressure gauge is above the center of the piping.
 Note 3) For dimensions of round-type pressure gauge for special application, please contact SMC.

Options

Digital Pressure Switch



RoHS

ISE35-**N**-**25**-**M****L****A**

① ② ③ ④ ⑤

	Symbol	Description
① Electrical entry	N	Wiring bottom entry
	R	Wiring top entry
② Output	25	NPN output
	65	PNP output
③ Unit	Nil	With unit conversion function
	M	Fixed SI unit
	P	Pressure unit: psi (Initial value), with unit conversion function
④ Lead wire	Nil	Without lead wire
	L	Lead wire with connector (2 m)
⑤ Accessories	Nil	Without accessories (Switch body only)
	A	With accessories (Adapter, O-ring: 1 pc., Mounting screw: 2 pcs., Lock pin)

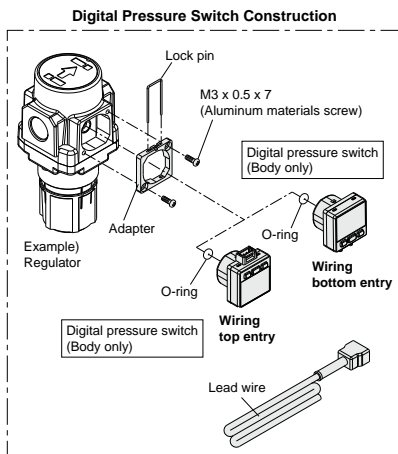

Note 1) Under the New Measurement Law, sales of switches with the unit switching function have not been allowed for use in Japan.
 Note 2) Unit name plate is attached.
 Note 3) Operation manual is included.
 Note 4) When ordering the body only, select the symbol from ① to ⑤ respectively.

Specifications

Rated pressure range	0 to 1 MPa
Set pressure range	-0.1 to 1 MPa
Withstand pressure	1.5 MPa
Set pressure resolution	0.01 MPa
Power supply voltage	12 to 24 VDC, Ripple (p-p) 10% or less (with power supply polarity protection)
Current consumption	55 mA or less (at no load)
Switch output	NPN or PNP open collector 1 output
Maximum load current	80 mA
Maximum applied voltage	30 V (at NPN output)
Residual voltage	1 V or less (with load current of 80 mA)
Response time	1 s
Anti-chattering function	(0.25, 0.5, 2, 3)
Short-circuit protection	Yes
Repeatability	±1% F.S. or less
Hysteresis	Hysteresis mode Window comparator mode
	Variable (0 or above)
Display	3-digit, 7-segment indicator, 2-color display (Red/Green) can be interlocked with the switch output.
Display accuracy	±2% F.S. ±1 digit (25°C ±3°C)
Indicator light	Light up when output is turned ON. (Green)
Environment resistance	Enclosure IP40
Lead wire with connector	ø3.4 3-wire 25AWG 2 m

Output Specifications

NPN open collector output

Max. 30 V, 80 mA
Residual voltage 1 V or less

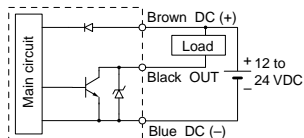

PNP open collector

Max. 80 mA
Residual voltage 1 V or less

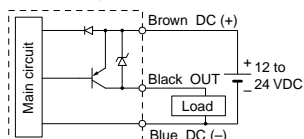

Directional Control Valves

Air Cylinders

Rotary Actuators

Air Grippers

Air Preparation Equipment

Modular F. R.

Pressure Control Equipment

Fittings & Tubing

Flow Control Equipment

Pressure Switches/Pressure Sensors



Series ¹⁰/₂₁ ARP20/30/40
Series ¹⁰/₂₁ ARP20K/30K/40K
Specific Product Precautions 1

Be sure to read this before handling. Refer to page 1382 for Safety Instructions.

Design

⚠ Warning

1. Be sure to install a safety device to prevent damage or malfunction of the outlet side components when the output pressure exceeds the set pressure value.
2. Please consult with SMC if the intended application calls for absolutely zero leakage due to special atmospheric requirements, or if the use of a fluid other than air is required.

⚠ Caution

1. Select a model that is suitable for the desired cleanliness by referring to the SMC's Best Pneumatics catalog.
2. Components cannot be used for applications that are outside the range of specifications.
Please consult with SMC when you anticipate using the component outside the range of its specifications (such as temperature and pressure).
3. Even when the product is used in the specified range, it may chatter depending on the operating conditions. Please contact SMC for the details of this chattering.

Selection

⚠ Warning

1. The mineral grease used on internal sliding parts and seals may run down to outlet side components.
Please consult with SMC if this is not desirable.
2. Residual pressure release (outlet pressure release) is not complete by releasing the inlet pressure.
To release residual pressure, select a model with a backflow function. Using a model without a backflow function makes for inconsistent residual pressure release (i.e., residual pressure may or may not be released) depending upon the operating conditions.
3. Please contact SMC if air will not be consumed in the system for a long period of time, or if the outlet side will be used with a sealed circuit and a balanced circuit, as this may cause the set pressure of the outlet side to fluctuate.
4. Set the regulating pressure range for the outlet pressure of the regulator in a range that is 90% or less of the inlet pressure.
If set to above 90%, the outlet pressure will be easily affected by fluctuations in the flow rate and inlet pressure, and become unstable.
5. A safety margin is calculated into the maximum regulating pressure range appearing in the catalog's specification table.
However, the outlet pressure may exceed the set pressure due to a delay in the valve's closing.
6. Please contact SMC when a circuit requires the use of a regulator having relief sensitivity with high precision and setting accuracy.

Mounting

⚠ Caution

1. To avoid reversed connections of the air inlet/outlet, make connections after confirming the "IN/OUT" mark or arrows that indicate the direction of air flow. Reversed connections can cause malfunction.
2. Leave a space of 100 mm or more for maintenance on the valve guide side (opposite side from the knob).
3. When the product is installed between a solenoid valve and an actuator, select a backflow function type.

Adjustment

⚠ Warning

1. Set the regulator while verifying the displayed values of the inlet and outlet pressure gauges.
Turning the knob excessively can cause damage to the internal parts.
2. Do not use a tool on the pressure regulator knob as this can cause damage. It must be operated manually.

⚠ Caution

1. Be sure to check the inlet pressure before setting the outlet pressure.
2. Be sure to unlock the knob before adjusting the pressure and lock it after setting the pressure.

Failure to follow this procedure can cause damage to the knob and the outlet pressure may fluctuate.

- Pull the pressure regulator knob to unlock. (You can visually verify this with the "orange mark" that appears in the gap.)
- Push the pressure regulator knob to lock. When the knob is not easily locked, turn it left and right a little and then push it (when the knob is locked, the "orange mark", i.e., the gap will disappear).

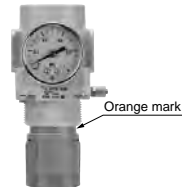

3. To set the pressure using the knob, turn the knob in the direction that increases pressure and lock the knob after the pressure is set.

If this is done in the direction that decreases pressure, the pressure may drop from the original set pressure. Turning the knob clockwise increases the outlet pressure, and turning it counterclockwise reduces the pressure.

4. Do not apply pressure exceeding the range of specifications.

It can damage the pressure gauge.



Series ¹⁰/₂₁ ARP20/30/40
 Series ¹⁰/₂₁ ARP20K/30K/40K
Specific Product Precautions 2

Be sure to read this before handling. Refer to page 1382 for Safety Instructions.

Adjustment

⚠ Caution

5. The product consumes a small amount of fluid from the bleed port.

The product is designed to have a bleed mechanism for highly accurate pressure adjustment, and consumes a small amount of fluid from the bleed port. This should not be considered abnormal.

Air Supply

⚠ Warning

1. Use a mist separator on the inlet side of the product.
 If the supplied air contains condensate or dust, the bleed mechanism can malfunction.
2. Do not use a lubricator on the inlet side of the product, as the bleed mechanism can malfunction.

Piping

⚠ Warning

1. To screw piping materials into components, tighten with a recommended tightening torque while holding the female thread side.

If the minimum tightening torque is not observed, this can cause a looseness and seal failure. On the other hand, excess tightening torque can cause damage to the threads. Furthermore, tightening without holding the female thread side can cause damage due to the excess force that is applied directly to the piping bracket.

Recommended Tightening Torque [N·m]

Connection thread	1/8	1/4	3/8	1/2
Torque	7 to 9	12 to 14	22 to 24	28 to 30

2. Avoid excessive torsional moment or bending moment other than those caused by the equipment's own weight as this can cause damage. Support external piping separately.
3. Piping materials without flexibility such as steel tube piping are prone to be affected by excess moment load and vibration from the piping side. Use flexible tubing in between to avoid such an effect.

Maintenance

⚠ Warning

1. When disassembly or installation is required during the maintenance, repair, or replacement of a device, be sure to follow the instructions provided in the operation manual or safety instructions in this catalog.
2. When using the regulator with backflow function between a solenoid valve and an actuator, check the pressure gauge periodically.

Sudden pressure fluctuations may shorten the durability of the pressure gauge. A digital pressure gauge is recommended for such situation or as deemed necessary.

⚠ Caution

1. For emergency action in the event of setting failure or leakage from the relief port, refer to "Troubleshooting" in the Operation Manual of the product.

Directional Control Valves

Air Cylinders

Rotary Actuators

Air Grippers

Air Preparation Equipment

Modular F. R.

Pressure Control Equipment

Fittings & Tubing

Flow Control Equipment

Pressure Switches/ Pressure Sensors

Series 10-IR1000/2000/3000

Precision Regulator

RoHS

How to Order

Clean series ↑

10-IR 2 0 0 0 - [] 02 [] - R

Precision regulator ↓

Body size ↓

1	IR1000 type
2	IR2000 type
3	IR3000 type

Type of setting ↓

0	Basic (Knob)
1	Air operated (Only for IR 2000/3000)

Set pressure range ↓

10-IR1000/2000

0	0.005 to 0.2 MPa
1	0.01 to 0.4 MPa
2	0.01 to 0.8 MPa

(Note) Air operated type is IR2120 only.

10-IR3000

0	0.01 to 0.2 MPa
1	0.01 to 0.4 MPa
2	0.01 to 0.8 MPa

(Note) Air operated type is IR3120 only.

Suffix ↓

Nil	—
R (Note)	Bracket, Name plate, Mounting on the opposite side

(Note) The standard mounting position of the name plate is on the front when viewing the regulator with the SUP side to the left and OUT side to the right. The bracket is attached to the back.

Port size ↓

Symbol	Port size	Application		
		10-IR1000	10-IR2000	10-IR3000
01	1/8	●		
02	1/4		●	●
03	3/8			●
04	1/2			●

Thread type ↓

Nil	Rc
N* (Note)	NPT
F*	G

* Semi-standard

(Note) For thread type NPT. This product is for overseas use only according to the new Measurement Law. (The SI unit type is provided for use in Japan.)

Accessory ↓

Nil	None
B	With bracket
G	With pressure gauge [†]

[†] Pressure gauge is included, (but not assembled).

Standard Specifications

Model	Basic type			Air operated type	
	10-IR10□0	10-IR20□0	10-IR30□0	10-IR2120	10-IR3120
Max. supply pressure	Max. 1.0 MPa				
Min. supply pressure (Note 1)	Set pressure + 0.05 MPa		Set pressure + 0.1 MPa	Set pressure + 0.05 MPa	Set pressure + 0.1 MPa
Set pressure range	10-IR1000: 0.005 to 0.2 MPa 10-IR1010: 0.01 to 0.4 MPa 10-IR1020: 0.01 to 0.8 MPa	10-IR2000: 0.005 to 0.2 MPa 10-IR2010: 0.01 to 0.4 MPa 10-IR2020: 0.01 to 0.8 MPa	10-IR3000: 0.01 to 0.2 MPa 10-IR3010: 0.01 to 0.4 MPa 10-IR3020: 0.01 to 0.8 MPa	0.01 to 0.8 MPa	0.01 to 0.8 MPa
Input signal pressure (Note 2)	—			0.01 to 0.8 MPa	0.01 to 0.8 MPa
Sensitivity (Note 3)	Within 0.2% of full span				
Repeatability (Note 3)	Within ±0.5% of full span				
Linearity (Note 4)	—			Within ±1% of full span	
Air consumption (Note 5) (Supply pressure: 1.0 MPa)	Within 4.4 L/min (ANR)	Within 4.4 L/min (ANR)	Within 11.5 L/min (ANR)	Within 4.4 L/min (ANR)	Within 11.5 L/min (ANR)
Port sizes	Rc1/8	Rc1/4	Rc1/4, 3/8, 1/2	Rc1/4	Rc1/4, 3/8, 1/2
Pressure gauge port	Rc1/8 (2 positions)				
Ambient & fluid temperatures	-5 to 60°C (with no freezing)				
Weight (kg)	0.16	0.32	0.66	0.37	0.73
Cleanliness class (ISO class)	Class 3				
Bleed port	With M5 fitting (applicable tubing O.D. ø6)				
EXH port	With M5 fitting (applicable tubing O.D. ø6)	Rc1/2 female thread	With M5 fitting (applicable tubing O.D. ø6)	Rc1/2 female thread	Rc1/2 female thread
Grease	Fluorine grease				

(Note 1) With the condition of no flow on the output side. Together with the set pressure, be sure to maintain a minimum differential pressure of 0.05 MPa for models IR1000 and IR2000, and 0.1 MPa for model IR3000.

(Note 2) Applicable only to air operated types IR2120 and IR3120. The basic type is excepted.

(Note 3) Characteristic values do not contain any secular change and temperature change.

(Note 4) Indicates the linearity of the output pressure with respect to the input signal pressure.

(Note 5) Air is normally being discharged to the atmosphere.

Dimensions

10-IR10□0-01□

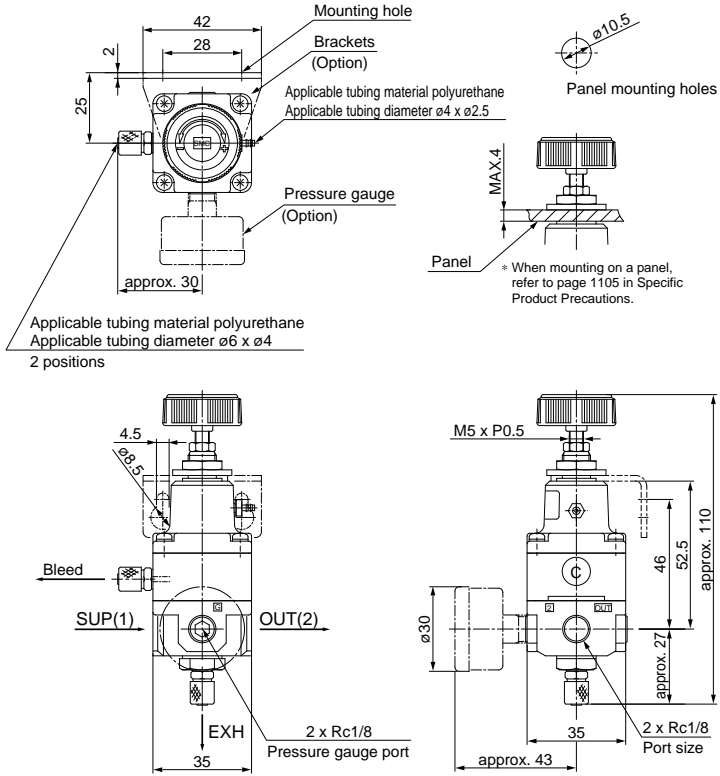

Directional Control Valves

Air Cylinders

Rotary Actuators

Air Grippers

Air Preparation Equipment

Modular F. R.

Pressure Control Equipment

Fittings & Tubing

Flow Control Equipment

Pressure Switches/
Pressure Sensors

Dimensions

10-IR30□0-0□□

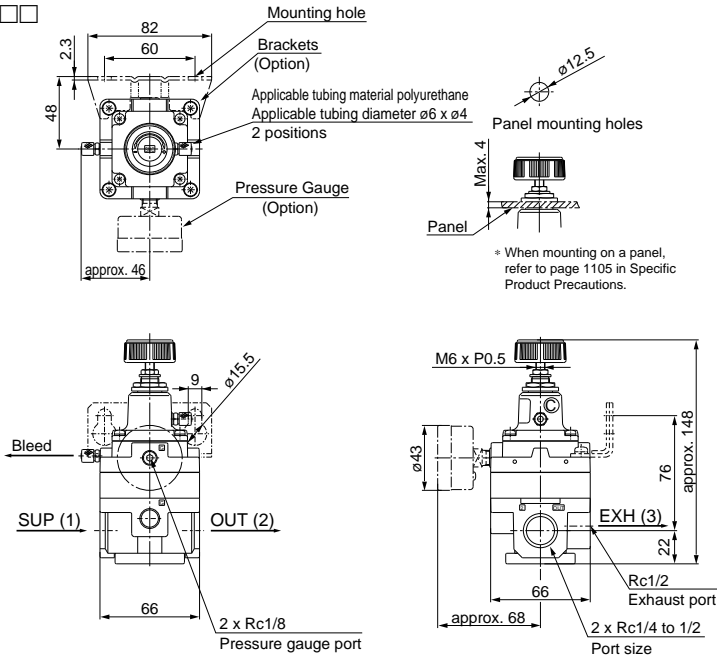

10-IR3120-0□□

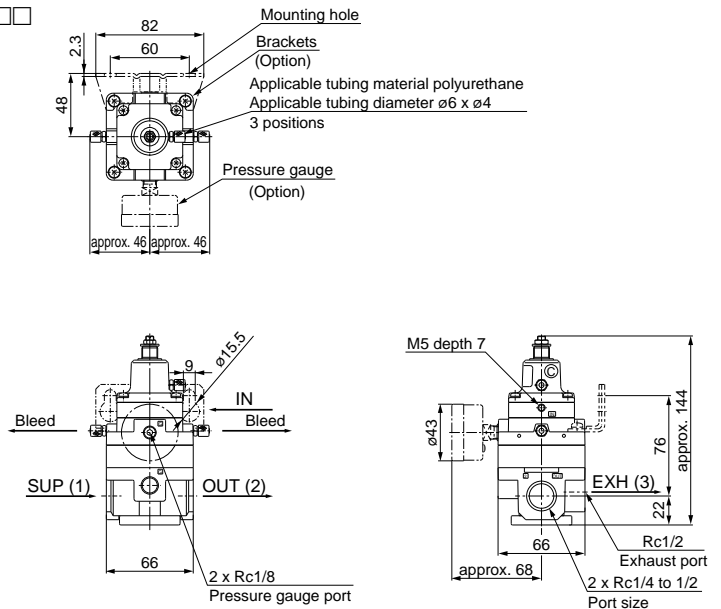

Directional Control Valves
Air Cylinders
Rotary Actuators
Air Grippers
Air Preparation Equipment
Modular F. R.
Pressure Control Equipment
Fittings & Tubing
Flow Control Equipment
Pressure Switches/Pressure Sensors

⚠ Specific Product Precautions

Air Supply

⚠ Warning

1. If the drain removal from air filter and mist separator is missed, drain will be blown out to the outlet side and may result in a malfunction of the pneumatic equipment.

When removing drain is difficult, use of a filter with an auto-drain is recommended.

⚠ Caution

1. If the supply pressure line contains drain or particulate, etc., the fixed throttle can become clogged, leading to malfunction*, and therefore, in addition to an air filter (SMC's AF series), be sure to use a mist separator (SMC's AM and AFM series).

Refer to SMC's Best Pneumatics catalog vol. 14 regarding air quality.

2. Never use a lubricator on the supply side of the regulator, as this will positively cause the fixed throttle to become clogged and result in a malfunction*. If lubrication is required for terminal devices, connect a lubricator on the output side of the regulator.

* The following may occur if the fixed throttle is clogged.

- No output
- Set pressure drops.
- Set pressure is unstable.
- Outlet pressure slowly rises.

Maintenance

⚠ Warning

1. When the valve guide is to be removed during maintenance, first reduce the set pressure to "0" and completely shut off the supply pressure.
2. When a pressure gauge is to be mounted, remove the plug after reducing the set pressure to "0".

Precautions for 10-IR10□0 only

⚠ Warning

1. When remounting the valve guide after removing it for maintenance, use a tightening torque of 0.6Nm or smaller.

Since the valve guide on this product is made of resin, there is a danger of damage if tightened with a torque exceeding the prescribed range.

Handling

⚠ Caution

1. Do not apply force when transferring, mounting and dropping the regulator with a pressure gauge. This may cause misalignment of the pressure gauge pointer.

Operation

⚠ Caution

1. Do not use a precision regulator outside of the specifications range as this can cause failure. (Refer to specifications.)

Operation

⚠ Caution

2. When mounting is performed, make connections while confirming port indications.
3. Screw a panel nut with the recommended proper torque when mounting onto a panel. Looseness or faulty sealing will occur if tightening torque is insufficient, while thread damage will occur if the torque is excessive.

Recommended Proper Torque [N·m]

10-IR1000	10-IR2000	10-IR3000
12.5	21	21

4. If a directional switching valve (solenoid valve, mechanical valve, etc.) is mounted on the supply side of the regulator and repeatedly switched ON and OFF, wear of the nozzle/flapper section will be accelerated and a discrepancy in the setting value may occur. Therefore, avoid using a directional switching valve on the supply side. In the event a directional switching valve will be used, install it on the output side of the regulator.
5. The accessory pressure gauge is supplied with the regulator in the unassembled status. Before using the regulator, be sure to install the pressure gauge at the gauge port of the regulator. At this time, the recommended tightening torque of the pressure gauge is 7 to 9 N·m.
6. Air is normally released from the bleed port (the hole on the side of the body's mid-section). This is a necessary consumption of air based on the construction of the precision regulator, and is not an abnormality.
7. When connecting the tubing to the M5 fitting, a buzzing noise may be generated from the regulator depending on the operating conditions. However, this does not affect the characteristics.
8. Make sure to tighten the lock nut after pressure adjustment.

Precautions for 10-IR30□0 and IR3120 only

⚠ Caution

1. When the supply pressure is relatively high (approx. 0.5 MPa or more), the set pressure is low (approx. 0.1MPa or less), and operated with the output side released to the atmosphere, there may be pulsations in the setting pressure. In this kind of situation, operate with the supply pressure reduced as much as possible, or increase the set pressure somewhat and restrict the output line (add and adjust a stop valve, etc.).
2. If the product is used for a relief function with a large capacity on the output side, there will be a large exhaust sound at the time of relief. Therefore, install a silencer (SMC AN series) on the exhaust port (EXH). The connection is Rc1/2.

Precautions for 10-IR2120 and IR3120 (air-operated types) only

⚠ Caution

1. Since the output types of IR2120 and IR3120 are the same pressure as the input signal pressure, select a type of regulator (general purpose or precision type) for input signal pressure adjustment according to the application.
2. The screw on the topmost section is a zero point adjustment screw which is locked at the factory and requires no adjustment for operation.

Series 10-IRV10/20 Vacuum Regulator

RoHS

How to Order

Standard connections

10-IRV [] - [] C08 [] []

Clean series

Body size

10	Max. flow 140 L/min (ANR)
20	Max. flow 240 L/min (ANR)

Fittings

Nil	Straight
L	Elbow

Accessory ②

Nil	None Note 1)	
G	With pressure gauge Note 2) Note 3) (10-IRV10: With GZ33-K-01-X5, 10-IRV20: With GZ43-K-01-X5)	
ZN	Note 3) NPN open collector 1 output	With ZSE30A-01-N-ML
ZP	With digital pressure switch PNP open collector 1 output	With ZSE30A-01-P-ML
ZA	PNP open collector 2 outputs	With ZSE30A-01-A-ML
ZB	PNP open collector 2 outputs	With ZSE30A-01-B-ML

Note 1) Two plug nuts are mounted.
Note 2) Pressure gauge accuracy: Within ±3% of full scale
Note 3) Plug nut and gauge nut are included. (For details, refer to back page 3 in CAT.ES60-20.) Accessories are included in the same container.



Straight



Elbow

Connection tubing O.D.

Symbol	Tubing O.D.	10-IRV10	10-IRV20
C06	Metric	ø6	●
C08		ø8	●
C10		ø10	—
N07		ø1/4"	●
N09	Inch	ø5/16"	●
N11		ø3/8"	●

Accessory ① Note 1)

Nil	None
B	With bracket
L	With bottom bracket

Note 1) Accessories are shipped together.

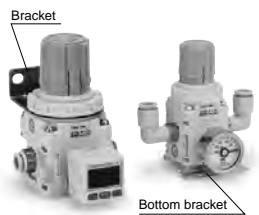

Bracket

Bottom bracket

Single sided connections

10-IRV 20 A - [] C08 [] []

Clean series

Body size

10	Max. flow 140 L/min (ANR)
20	Max. flow 240 L/min (ANR)

Single sided connections

A	Single sided connections
---	--------------------------

Fittings

Nil	Straight
L	Elbow

Accessory ②

Nil	None Note 1)	
G	With pressure gauge Note 2) Note 3) (10-IRV10A: With GZ33-K-01-X5, 10-IRV20A: With GZ43-K-01-X5)	
ZN	Note 3) NPN open collector 1 output	With ZSE30A-01-N-ML
ZP	With digital pressure switch PNP open collector 1 output	With ZSE30A-01-P-ML
ZA	PNP open collector 2 outputs	With ZSE30A-01-A-ML
ZB	PNP open collector 2 outputs	With ZSE30A-01-B-ML

Note 1) A plug nut is mounted.
Note 2) Pressure gauge accuracy: Within ±3% of full scale
Note 3) Gauge nut is included. Accessories are included in the same container.



Elbow



Straight

Connection tubing O.D.

Symbol	Tubing O.D.	10-IRV10A	10-IRV20A
C06	Metric	ø6	●
C08		ø8	●
C10		ø10	—
N07		ø1/4"	●
N09	Inch	ø5/16"	●
N11		ø3/8"	●

Accessory ① Note 1)

Nil	None
B	With bracket
L	With bottom bracket

Note 1) Accessories are shipped together.

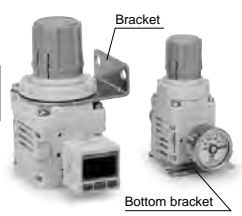

Bracket

Bottom bracket

Directional Control Valves

Air Cylinders

Rotary Actuators

Air Grippers

Air Preparation Equipment

Modular F. R.

Pressure Control Equipment

Fittings & Tubing

Flow Control Equipment

Pressure Switches/ Pressure Sensors

Standard Specifications

Model		10-IRV10	10-IRV20
Fluid		Air	
Set pressure range ^{Note 1)}		-100 to -1.3 kPa	
Atmospheric intake consumption ^{Note 2)}		0.6 L/min (ANR) or less	
Knob resolution		0.13 kPa or less	
Ambient and fluid temperature		5 to 60°C	
VAC side tubing O.D.		ø6, ø8 ø1/4", ø5/16"	ø6, ø8, ø10 ø1/4", ø5/16", ø3/8"
Weight (Without accessories)	Standard connections	135 g (10-IRV10-C08)	250 g (10-IRV20-C10)
	Single sided connections	125 g (10-IRV10A-C08)	250 g (10-IRV20A-C10)

Note 1) Use caution it varies depending on the pressure in vacuum pump side.

Note 2) Taking air from atmosphere all the time.

Conditions:
 Vacuum pump exhaust speed:
 2500 L/min
 VAC side pressure:
 -101 kPa (At initial setting)

Flow Rate Characteristics (Representative Value)

10-IRV10-C08 (One-touch fitting ø8)

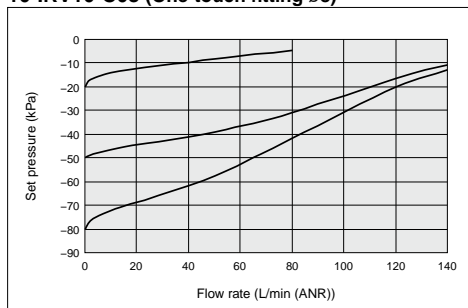

Pressure Characteristics (Representative Value)

10-IRV10

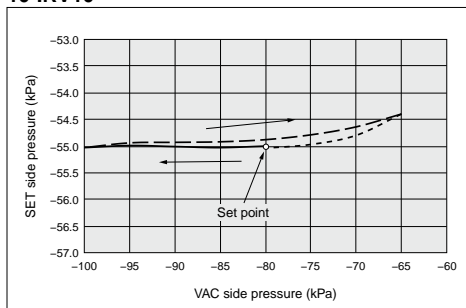

10-IRV20-C10 (One-touch fitting ø10)

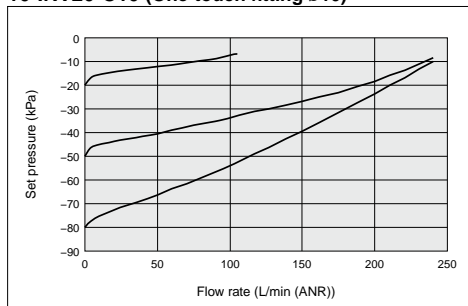

10-IRV20

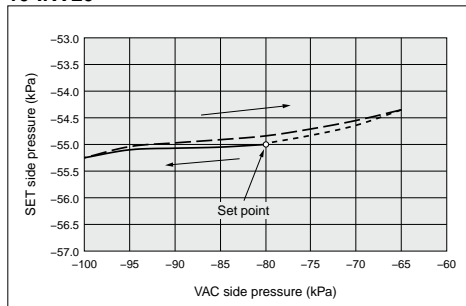

Construction

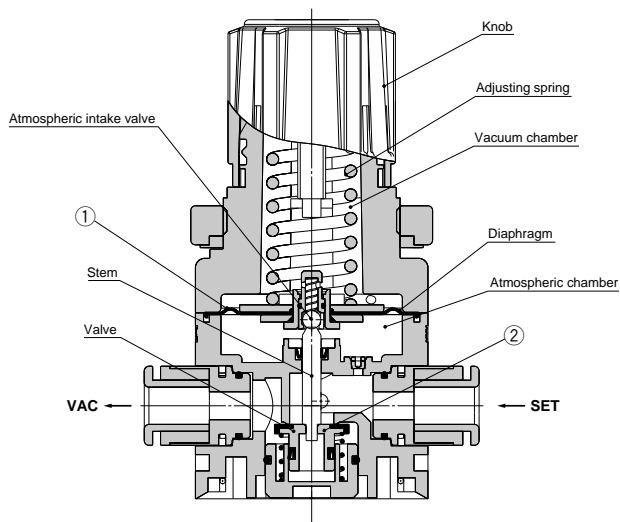

Working principle

When the knob is turned to the right (clockwise), the adjusting spring's generated force pushes down the diaphragm and the valve. This connects the VAC side and SET side, and the degree of vacuum on the SET side increases (becomes closer to an absolute vacuum). Furthermore, the SET side vacuum pressure moves through the air passage into the vacuum chamber, where it is applied to the top side of the diaphragm and counters the adjusting spring's compression force; and this adjusts the SET side pressure. When the degree of vacuum on the SET side is higher than the designated setting value (becomes closer to an absolute vacuum), the balance between the adjusting spring and the SET side pressure in the vacuum chamber is lost, and the diaphragm is pushed up. This causes the valve to close and the atmospheric intake valve to open, which lets atmospheric air into the SET side. When the adjusting spring's compression force and the SET side pressure are balanced, the SET side pressure is set. Also, when the degree of vacuum of the SET side pressure is lower than the designated setting value (becomes closer to the atmosphere), the balance between the adjusting spring and the vacuum chamber is lost, and the diaphragm is pushed down. This causes the atmospheric intake valve to close and the valve to open, which lets air into the VAC side. When the adjusting spring's compression force and the SET side pressure are balanced, the SET side pressure is set.

Replacement Parts

No.	Description	Material	Part no.	
			10-IRV10	10-IRV20
1	Diaphragm assembly	HNBR, etc.	P601010-2	P601020-2
2	Valve assembly	HNBR, etc.	P601010-3	P601020-3

Directional Control Valves

Air Cylinders

Rotary Actuators

Air Grippers

Air Preparation Equipment

Modular F. R.

Pressure Control Equipment

Fittings & Tubing

Flow Control Equipment

Pressure Switches/ Pressure Sensors

Dimensions/10-IRV10: Standard Connections

10-IRV10-□□□G: With pressure gauge

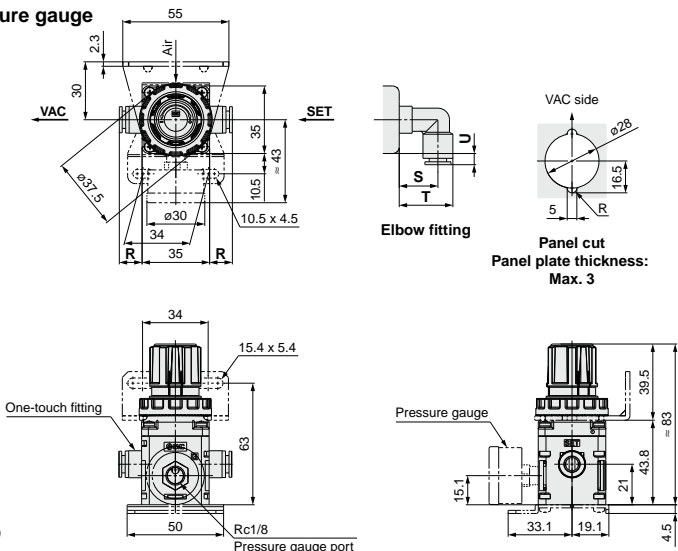

Fitting Part Dimensions (mm)

Fitting size	VAC/SET			
	Straight R	Elbow S	Elbow T	Elbow U
$\phi 6, \phi 1/4"$	10	19	26	3
$\phi 8, \phi 5/16"$	12	20	28	6

10-IRV10-□□□Z: With digital pressure switch

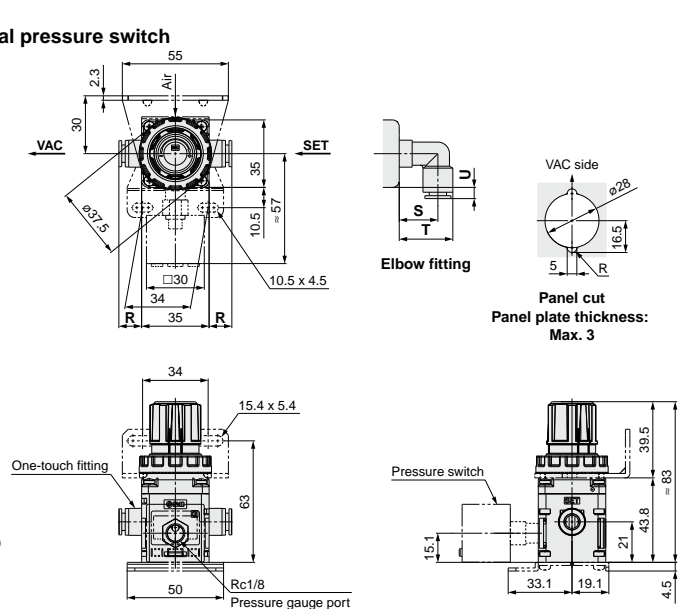

Fitting Part Dimensions (mm)

Fitting size	VAC/SET			
	Straight R	Elbow S	Elbow T	Elbow U
$\phi 6, \phi 1/4"$	10	19	26	3
$\phi 8, \phi 5/16"$	12	20	28	6

Dimensions/10-IRV10A: Single Sided Connections

10-IRV10A-□□□G: With pressure gauge

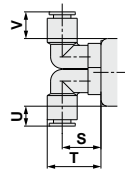
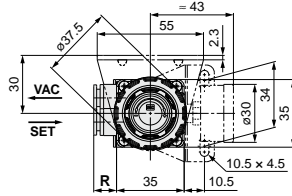

Elbow fitting

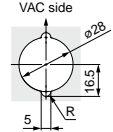

Panel cut
Panel plate thickness:
Max. 3

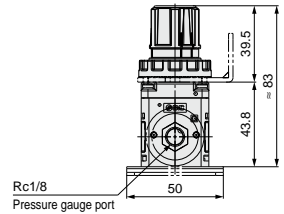
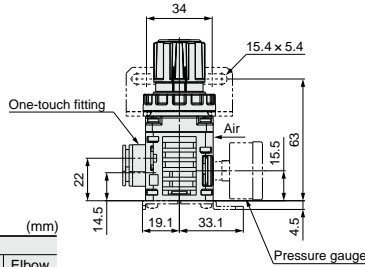

Fitting Part Dimensions

Fitting size	VAC/SET				
	Straight R	Elbow S	Elbow T	Elbow U	Elbow V
$\phi 6, \phi 1/4"$	10	19	26	7.5	11
$\phi 8, \phi 5/16"$	12	20	28	10.5	14

10-IRV10A-□□□Z^N□□□A_B: With digital pressure switch

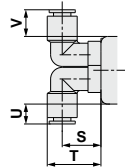
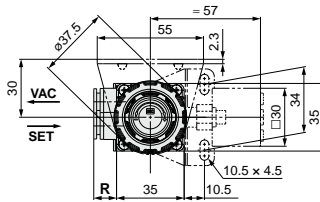

Elbow fitting

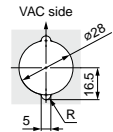

Panel cut
Panel plate thickness:
Max. 3

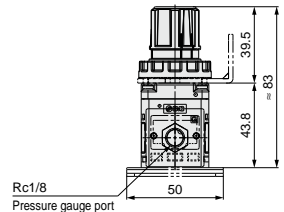
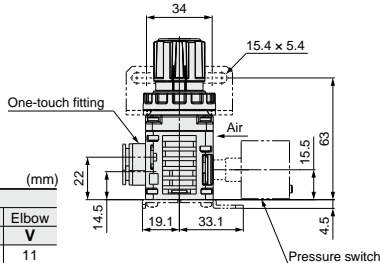

Fitting Part Dimensions

Fitting size	VAC/SET				
	Straight R	Elbow S	Elbow T	Elbow U	Elbow V
$\phi 6, \phi 1/4"$	10	19	26	7.5	11
$\phi 8, \phi 5/16"$	12	20	28	10.5	14

Directional Control Valves
Air Cylinders
Rotary Actuators
Air Grippers
Air Preparation Equipment
Modular F. R.
Pressure Control Equipment
Fittings & Tubing
Flow Control Equipment
Pressure Switches/
Pressure Sensors

Dimensions/10-IRV20: Standard Connections

10-IRV20-□□□G: With pressure gauge

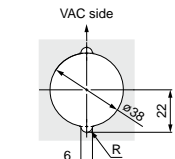
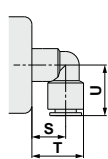
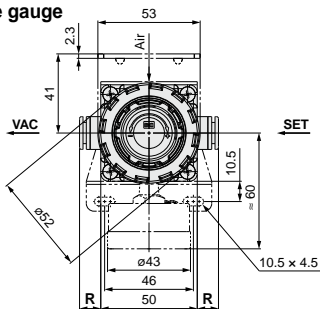

Elbow fitting

Panel cut
Panel plate thickness:
Max. 4

Fitting Part Dimensions (mm)

Fitting size	VAC/SET			
	Straight	Elbow	Elbow	Elbow
	R	S	T	U
ø6	10.5	21	27.5	21
ø1/4"	10.5	21	27.5	21.5
ø8, ø5/16"	10.5	21	28.5	24
ø10, ø3/8"	11	21	30.5	27

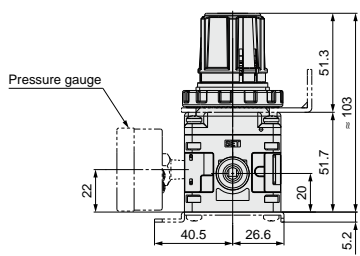
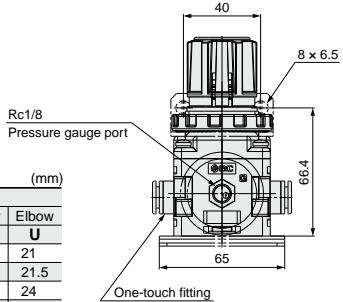

One-touch fitting

10-IRV20-□□□Z^N□□□A^P□□□B: With digital pressure switch

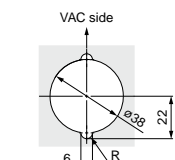
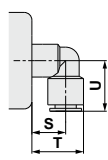
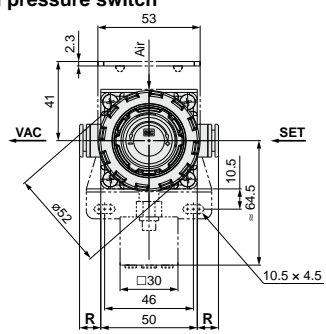

Elbow fitting

Panel cut
Panel plate thickness:
Max. 4

Fitting Part Dimensions (mm)

Fitting size	VAC/SET			
	Straight	Elbow	Elbow	Elbow
	R	S	T	U
ø6	10.5	21	27.5	21
ø1/4"	10.5	21	27.5	21.5
ø8, ø5/16"	10.5	21	28.5	24
ø10, ø3/8"	11	21	30.5	27

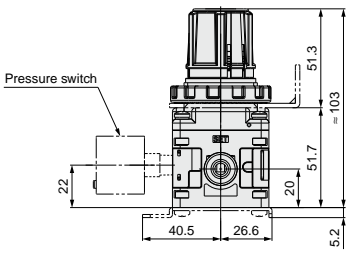
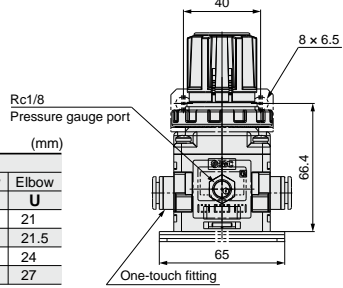

One-touch fitting

Dimensions/10-IRV20A: Single Sided Connections

10-IRV20A-□□□G: With pressure gauge

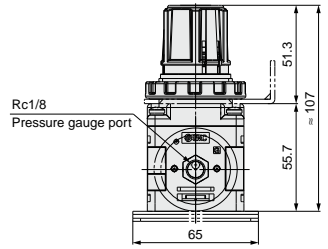
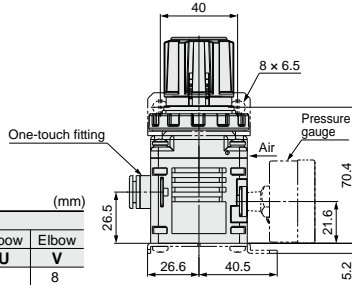
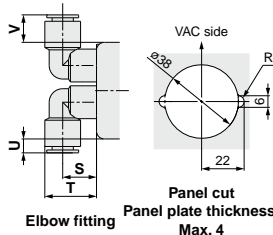
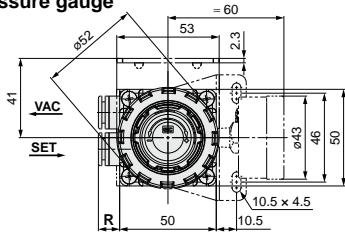

Fitting Part Dimensions

Fitting size	VAC/SET				
	R	S	T	U	V
ø6	10.5	21	27.5	1	8
ø1/4"	10.5	21	27.5	1.5	8.5
ø8, ø5/16"	10.5	21	28.5	4	11
ø10, ø3/8"	11	21	30.5	7	14

10-IRV20A-□□□Z^N□□□A^P□□□B: With digital pressure switch

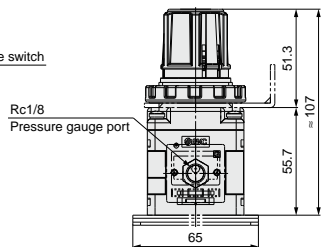
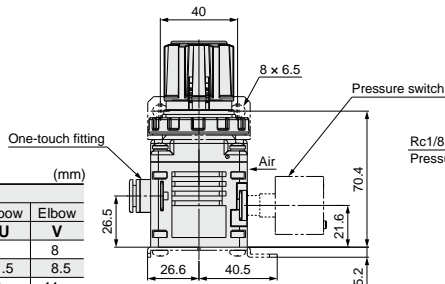
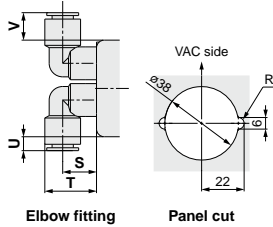
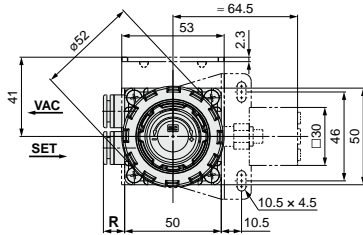

Fitting Part Dimensions

Fitting size	VAC/SET				
	R	S	T	U	V
ø6	10.5	21	27.5	1	8
ø1/4"	10.5	21	27.5	1.5	8.5
ø8, ø5/16"	10.5	21	28.5	4	11
ø10, ø3/8"	11	21	30.5	7	14

- Directional Control Valves
- Air Cylinders
- Rotary Actuators
- Air Grippers
- Air Preparation Equipment
- Modular F. R.
- Pressure Control Equipment
- Fittings & Tubing
- Flow Control Equipment
- Pressure Switches/Pressure Sensors



Series 10-IRV10/20 Specific Product Precautions

Be sure to read this before handling. Refer to page 1382 for Safety Instructions.

Handling

⚠ Warning

1. When a system hazard can be expected due to a drop in vacuum pressure caused by power loss or vacuum pump trouble, install a safety circuit and configure the system so that it can avoid the danger.
2. When a system hazard can be expected with trouble with the vacuum regulator, install a safety circuit and configure the system so that it can avoid the danger.

Operating Environment

⚠ Warning

1. Do not use in an atmosphere having corrosive gases, chemicals, sea water, water, water steam, or where there is direct contact with any of these.
2. Do not use in locations influenced by vibrations or impacts.
3. This vacuum regulator always uses atmospheric air, therefore, do not use in dusty environments.
4. In locations which receive direct sunlight, provide a protective cover etc.
5. In locations near heat sources, block off any radiated heat.

Vacuum Supply

⚠ Caution

1. This vacuum regulator is not to be used for adjusting vacuum pump pressures.
2. Note that an ejector's flow rate is smaller than that of the vacuum regulator, and therefore, it is not suitable as a "vacuum supply".

Air Supply

⚠ Caution

1. These products are designed for use with air. Please contact SMC if any other fluid will be used.
2. Do not use air which includes chemicals, synthetic oils containing organic solvents, salt, or corrosive gases, etc., as this can cause malfunction.

Precautions

⚠ Caution

1. Connect piping to the port with "VAC" indication for connection to the vacuum pump.
2. To adjust the pressure, turn the knob to the right (clockwise) for changing "atmospheric pressure to vacuum pressure" and to the left (counterclockwise) for changing "vacuum pressure to atmospheric pressure".
3. When adjusting pressure, do not touch the lateral hole (atmospheric intake hole) of the body.
4. When locking the knob after setting the pressure, press down the knob until the orange band is hidden and a click is heard. On the other hand, when unlocking the knob, pull it up until the orange band is visible and a click is heard.
5. This vacuum regulator is for use with vacuum pressure only. Be sure that positive pressure is not applied instead. In the event that positive pressure is applied, the vacuum regulator will not be damaged. However, the main valve of the pressure adjustment valve will open and positive pressure will enter the vacuum pump. This may cause trouble with the vacuum pump.
6. When the vacuum pump capacity is relatively small or when the inside diameter of the piping is small, a change in the set pressure (the pressure difference between the non-flow and flow conditions) may be large. In this case, change the vacuum pump or the inside diameter of the piping. When changing the vacuum pump is not possible, add a capacity tank (the capacity depends on the operating conditions) to the VAC side.
7. The pressure response time after opening and closing of valves (such as solenoid valves) is influenced in large and small measures by the internal capacity (includes piping capacity) of the set side. Since the vacuum pump capacity also affects the response time, consider all these points before operations.
8. When using a pressure gauge upside down like Fig. 1, it may result in a shifting of the zero point reading. Make sure to use it in the direction like Fig. 2.

10-IRV10

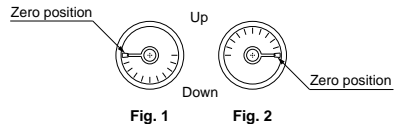

10-IRV20

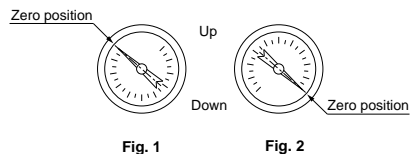

Series SRH Clean Regulator

How to Order



SRH 3 0 0 0 0 0 2 R

Body size	
3	1/4
4	3/8
Washing grade	
0	Grade A
1	Grade B
Set pressure	
0	0.02 to 0.2 MPa
1	0.05 to 0.7 MPa
Relief mechanism	
0	Non-relief
1	Relief

Gauge port orientation

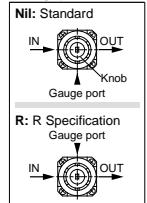

* There is only one gauge port.

Symbol	Port size	SRH3000	SRH4000
01	Rc1/8	●	—
02	Rc1/4	●	●
03	Rc3/8	—	●
04	Rc1/2	—	●
A2	With metal gasket seal fitting	URJF1/4	—
A3	With metal gasket seal fitting	—	URJF3/8

Note) Refer to option specifications for pressure gauges.

Production process

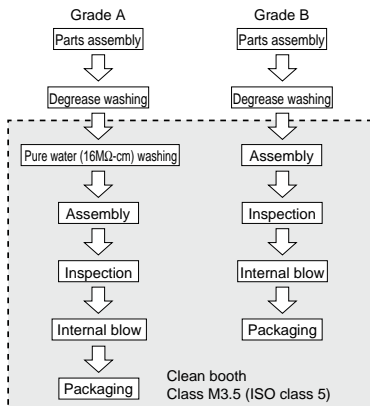

Specifications

Model	SRH3□□0	SRH4□□0	SRH3□□1	SRH4□□1
Relief mechanism	Non-relief		Relief	
Port size	Rc1/8, 1/4 URJF1/4	Rc1/4, 3/8, 1/2 URJF3/8	Rc1/8, 1/4	Rc1/4, 3/8, 1/2
Fluid	Grade A Clean air, N ₂ , Ar, CO ₂ , Pure water Grade B Air, N ₂ , Ar, CO ₂ , Water		Clean air, N ₂	
Proof pressure	1.5 MPa			
Max. operating pressure	1 MPa			
Set pressure	Low pressure type 0.02 to 0.2 MPa High pressure type 0.05 to 0.7 MPa			
Ambient and fluid temperature	0 to 60°C (with no freezing)			
Wetted part material (metal)	Stainless steel 316 (Body: Stainless steel 316L)			
Diaphragm material	Grade A PTFE Grade B Fluororubber			
Weight	360 g	730 g	360 g	730 g
Cleanliness class (ISO class)	Class 3			

Directional Control Valves
 Air Cylinders
 Rotary Actuators
 Air Grippers
 Air Preparation Equipment
 Modular F. R.
 Pressure Control Equipment
 Fittings & Tubing
 Flow Control Equipment
 Pressure Switches/Pressure Sensors

Dimensions

Rc thread type

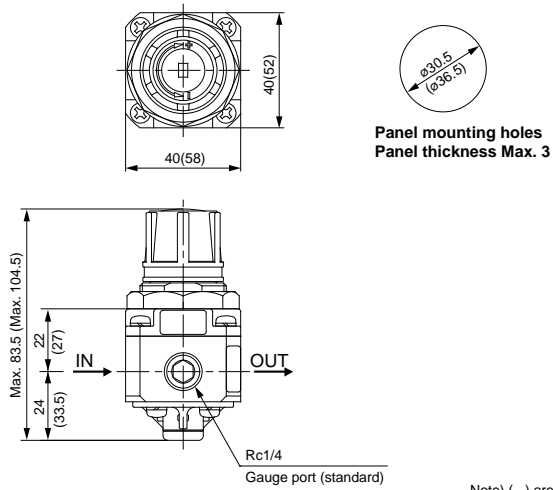

Metal gasket seal fitting type

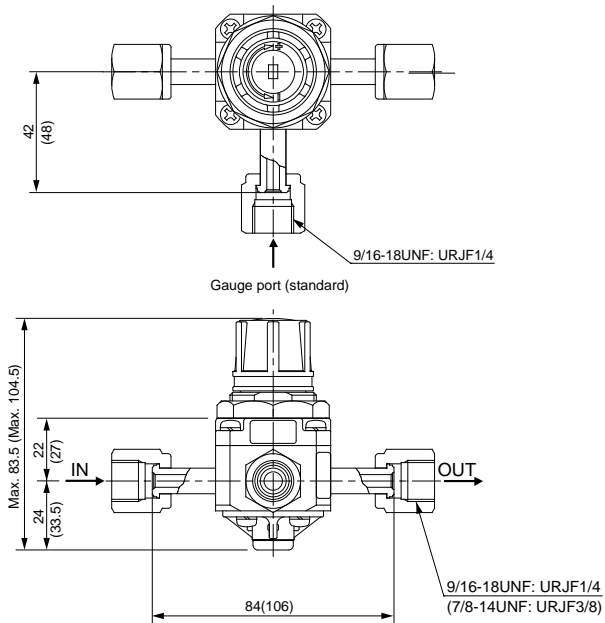

Options

Pressure gauge

Dimensions

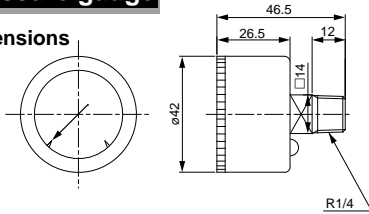

Specifications

Item	Model	G46-□-02-SRA	G46-□-02-SRB
Port size		R1/4	
Operating temperature range		0 to 60°C (with no freezing)	
Accuracy		±3% F.S.	
Scale range		270°	
Parts washing (wetted parts)		Precision washing	General degreasing
Assembly & adjustment environment		Clean room	General production line
Oil free / Water free		Oil free / Water free	
Materials	Wetted parts	Stainless steel 316	
	Case	Stainless steel 304 (Black melamine coating)	
	Clear cover	Polycarbonate (Hard coated) Part No. G46-00-00-2	
	Internal parts	Brass	
Weight		80 g	

Note) Please consult with SMC for the supply of models with fitting of metal gasket seal.

Model

Model	Pressure range	Display unit
	MPa	
G46-2-02-SRA	0 to 0.2	MPa
G46-2-02-SRB		
G46-4-02-SRA	0 to 0.4	
G46-4-02-SRB		
G46-7-02-SRA	0 to 0.7	
G46-7-02-SRB		
G46-10-02-SRA	0 to 1.0	
G46-10-02-SRB		

Procedure for setting the limit gauge indicator

- 1) Before setting the limit indicator (green), turn the cover counterclockwise (approximately 6 to 7 mm) until it stops. Then, pull the cover and remove it.

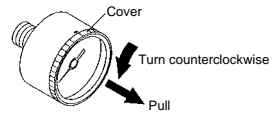

- 2) Use a flat head screwdriver (with a 2.9 mm blade width) to set the limit indicator. Be careful not to bend other needle or damage the dial plate.

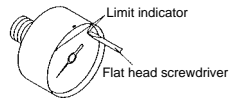

- 3) After completing the setting, fit the cover as before. Fit the cover by aligning the cutout in the cover to the groove on the top of the black case. Turn the cover clockwise (approximately 6 to 7 mm) and make sure that the matching mark on the cover is aligned with the groove on the top of the case.

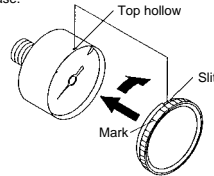

Bracket

	For SRH3000	For SRH4000
Part no.	B21-1-T1	1350112-T1
Materials	Rolled steel plate (Electroless nickel plated)	
Dimensions		

Directional Control Valves
Air Cylinders
Rotary Actuators
Air Grippers
Air Preparation Equipment
Modular F. R.
Pressure Control Equipment
Fittings & Tubing
Flow Control Equipment
Pressure Switches/Pressure Sensors

⚠ Specific Product Precautions

Be sure to read this before handling.

Design / Selection

⚠ Warning

1. Confirm the fluid.

Because the fluid to be used differs depending on the product, be certain to check the specifications. If an incompatible fluid is used, characteristics may change, which will cause malfunction.

2. Residual pressure relief is not possible without inlet side pressure.

For SRH series, if the inlet side pressure is cut off while pressure still remains on the outlet side, it is not possible to release the outlet side pressure (residual pressure relief). If pressure release from the outlet side is required, a circuit should be provided for residual pressure relief.

⚠ Caution

- Vibrations (noise) may be generated due to the operating conditions, etc., even if the regulator is used within the catalog specification range. If noise is generated, please consult with SMC.**

Pressure gauge

- Avoid use in locations subject to strong pulsation or vibration.
- Please consult with SMC regarding the operation at high frequency.

Mounting

⚠ Caution

1. Open the sealed package in a clean room.

These products are packaged in airtight double packaging in a clean room. It is recommended that the inside packaging be opened in a clean room or other clean environment.

2. Flush the piping.

Connect these products to piping only after it has been flushed and cleaned properly. If debris or scale etc. remains in the piping, this can cause malfunction or failure.

3. Be certain that sealing material does not get inside the piping.

When screwing in pipes and joints etc., take care that cutting dust from the pipe threads, sealing material, and the like do not get inside the piping. If debris or scale etc. remains in the piping, this can cause malfunction or failure. Also, when sealant tape is used, leave 1.5 or 2 threads exposed at the end of the pipe.

4. Confirm the mounting orientation of the product.

The side marked with an "IN" is the fluid supply port, and that marked with an "OUT" is the fluid exhaust port. If mounted backwards, the device will not operate properly.

Mounting

⚠ Caution

Pressure gauge

- Do not apply impacts to the regulator by dropping or hitting it during transfer or installation.
It may cause inaccuracy in indication.
- Do not install the regulator in an environment where it is exposed to high temperature or humidity.
It may cause malfunction or failure.
- When screwing in the pressure gauge, be sure to apply the wrench to the square wrench flats. If it is applied to other parts, it may cause air leakage or damage.

Pressure adjustment

⚠ Warning

1. Do not use tools when handling the pressure adjustment knob.

The pressure adjustment knob may be damaged if handled with tools. Handle this knob only by hand.

⚠ Caution

1. Release the lock to adjust the pressure.

When the pressure adjustment knob will not turn, it is locked. Pull the pressure adjustment knob to release the lock. The knob may be damaged when it is turned by force.
Push the knob to lock again after adjusting the pressure.

2. Adjust the pressure in an upward direction.

A correct pressure setting cannot be achieved by adjusting the pressure downward. The outlet side pressure increases when turning the knob clockwise, and decreases when turning it counterclockwise.

3. In the case of non-relief type, the pressure cannot be reduced by turning the knob counterclockwise.

In the case of the non-relief type regulator, the outlet side pressure will not decrease even if the knob is turned counterclockwise unless outlet side fluid is consumed. The knob will be damaged if it is turned by force.

In case the pressure setting is too high, reduce the pressure on the outlet side to less than the desired setting pressure by consuming fluid on the outlet side, and then reset to the desired pressure.

4. Confirm the inlet side pressure.

Set the outlet side pressure to no more than 85% of the inlet side pressure. If the supply pressure is too low, a correct setting pressure cannot be obtained.

5. Do not use fluid containing solid matter.

This will cause malfunction.

Series SRP Precision Clean Regulator

How to Order



SRP 1 1 0 1 — 01 — R

Set pressure

0	0.005 to 0.2 MPa
1	0.01 to 0.4 MPa

Port size

Symbol	Port size
M5	M5 x 0.8
01	Rc1/8

Gauge port orientation

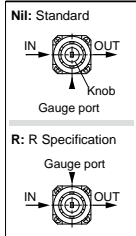

* The gauge port position is indicated with the knob on top.

(Note) The pressure gauge is optional. Please refer to "option specifications".

Production process

Parts assembly

Degrease washing

Assembly

Inspection

Internal blow

Packaging

Class M5.5
(ISO class 7)

Options

Description	Part no.	Material
Bracket	B21-1-T1	Rolled steel plate (Electroless nickel plated)

Specifications

Port sizes		M5, Rc1/8
Fluid		Air, N ₂ , CO ₂ , Ar
Proof pressure (MPa)		1.5
Max. operating pressure (MPa)		1
Set pressure range (MPa)	Low pressure type	0.005 to 0.2
	High pressure type	0.01 to 0.4
Ambient & fluid temperature (°C)		0 to 60°C (with no freezing)
Fluid consumption L/min (ANR)^(Note 1)		0.5 or less
Sensitivity		Within 0.3% of full span
Repeatability		Within ±1% of full span
Wetted part material	Metal	Stainless steel 316
	Resin	Fluoro resin
	Rubber	Fluororubber
	Other	Ceramics
Assembly environment		Clean room class 10000
Parts washing (wetted parts)		General degreasing
Cleanliness class (ISO class)		Class 5

Note 1) At set pressure of 0.2 MPa

Dimensions

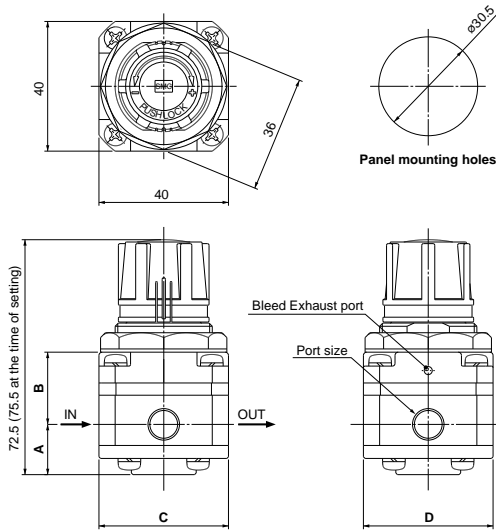

Bracket (B21-1-T1)

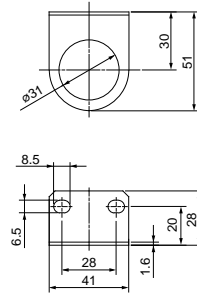

Model	Port size	A	B	C	D
SRP11□1-M5	M5 x 0.8	14	23.5	30	30
SRP11□1-01	Rc1/8	15	22.5	40	40

Options

Pressure gauge

Dimensions

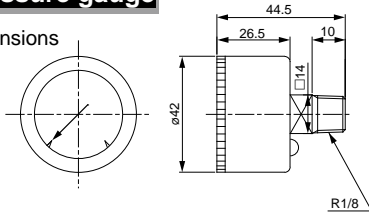

Specifications

Item	Model	G46-□-01-SRA	G46-□-01-SRB
Port size		R1/8	
Operating temperature range		0 to 60°C (with no freezing)	
Accuracy		±6% F.S.	
Scale range		270°	
Parts washing (wetted parts)		Precision wash	General degrease
Assembly & adjustment environment		Clean room	General production line
Oil free / Water free		Oil free / Water free	
Materials	Wetted parts	Stainless steel 316	
	Case	Stainless steel 304 (Black melamine coating)	
	Clear cover	Polycarbonate	
	Internal parts	Brass	
Weight		80g	

Model

Model	Pressure range	Display unit
	MPa	
G46-2-01-SRA	0 to 0.2	MPa
G46-2-01-SRB		
G46-4-01-SRA	0 to 0.4	
G46-4-01-SRB		

Procedure for setting the limit gauge indicator

- 1) Before setting the limit indicator, turn the cover counterclockwise (approximately 6 to 7 mm) until it stops. Then, pull the cover and remove it.

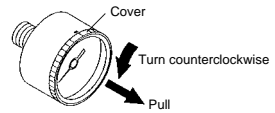

- 2) Use a flat head screwdriver (with a 2.9 mm blade width) to set the limit indicator. Be careful not to bend other needle or damage the dial plate.

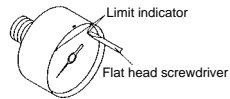

- 3) After completing the setting, mount the cover as before. Fit the cover by aligning the cutout in the cover to the groove on the top of the black case. Turn the cover clockwise (approximately 6 to 7 mm) and make sure that the matching mark on the cover is aligned with the groove on the top of the case.

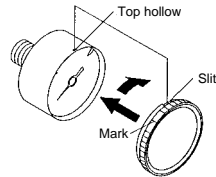

Directional Control Valves

Air Cylinders

Rotary Actuators

Air Grippers

Air Preparation Equipment

Modular F. R.

Pressure Control Equipment

Fittings & Tubing

Flow Control Equipment

Pressure Switches/ Pressure Sensors

⚠ Specific Product Precautions

Be sure to read this before handling.

Design / Selection

⚠ Warning

1. Types of fluid

Use with air, N₂, CO₂ or Ar as fluids. Please consult with SMC if the product is to be used with other fluids.

Do not use toxic or corrosive gases because the bleed mechanism is adopted to discharge fluids from the bleed port.

2. Do not use fluid containing solid matter.

To prevent malfunction caused by such substances, install a mist separator on the upstream side of the regulator.

3. When using air containing a large amount of drainage, install an air dryer or after cooler upstream of the regulator.

It will cause malfunction or failure.

4. Do not use in a place subject to heavy vibrations and/or shocks.

5. Install a protection cover if the product is exposed to direct sunlight.

6. Block off heat radiation with a cover if there is a heat source in close proximity.

⚠ Caution

1. SMC recommends the outlet side pressure be set within a 25 to 85% range of the inlet side pressure.

2. Vibrations (noise) may be generated due to the operating conditions, etc., even if the regulator is used within the catalog specification range. If noise is generated, please consult with SMC.

Pressure gauge

1. Avoid use in an environment where the regulator is exposed to strong pulsation or vibration.

2. Please consult with SMC regarding the operation at high frequency.

Mounting

⚠ Caution

1. Open the sealed package in a clean room.

These products are packaged in airtight double packaging in a clean room. It is recommended that the inside packaging be opened in a clean room or other clean environment.

2. Flush the piping.

Connect these products to piping only after it has been flushed and cleaned properly. If debris or scale etc. remains in the piping, this can cause malfunction or failure.

3. Be certain that sealing material does not get inside the piping.

When screwing in pipes and joints etc., take care that cutting dust from the pipe threads, sealing material, and the like do not get inside the piping. If debris or scale etc. remains in the piping, this can cause malfunction or failure. Also, when sealant tape is used, leave 1.5 or 2 threads exposed at the end of the pipe.

4. Confirm the mounting orientation of the product.

The side marked with an "IN" is the fluid supply port, and the side marked with an "OUT" is the fluid exhaust port. If mounted backwards, the device will not operate properly.

Mounting

⚠ Caution

5. Do not plug the bleed port.

If it is plugged, the product will not operate properly.

Pressure gauge

1. Do not apply impacts to the regulator by dropping or hitting it during transfer or installation.

It can cause inaccuracy in indication.

2. Do not install the regulator in an environment where it is exposed to high pressure or humidity.

It will cause malfunction or failure.

3. When screwing in the pressure gauge, be sure to apply the wrench to the square wrench flats. If it is applied to other parts, it may cause air leakage or damage.

Pressure Adjustment

⚠ Warning

1. Do not use tools when handling the pressure adjustment knob.

The pressure adjustment knob may be damaged if handled with tools. Handle this knob only by hand.

2. Set up the regulator while checking the pressure that is indicated on both of inlet and outlet sides pressure gauges.

If the knob is turned excessively, it may damage the internal parts.

⚠ Caution

1. Release the lock to adjust the pressure.

When the pressure adjustment knob will not turn, it is locked. Pull the pressure adjustment knob to release the lock. The knob may be damaged when it is turned by force.

Push the knob to lock again after adjusting the pressure.

2. Adjust the pressure in an upward direction.

A correct pressure setting cannot be achieved by adjusting the pressure downward. The outlet side pressure increases when turning the knob clockwise, and decreases when turning it counterclockwise.

3. Confirm the inlet side pressure.

Set the outlet side pressure to no more than 85% of the inlet side pressure. If the inlet side pressure is too low, a correct setting pressure cannot be obtained.

4. A small amount of fluid is consumed from the bleed port.

The bleed mechanism is adopted to achieve high precision pressure adjustment. Therefore, a small amount of fluid is constantly consumed from the bleed port but this is not abnormality.

For Clean Room

Fittings & Tubing

Contents	Series	Page
One-touch Fittings	10-KQ2	P.1124
Insert Fittings	10-KF	P.1190
Miniature Fittings	10-M	P.1196
Rectangular Multi-connector	10-KDM	P.1202
Stainless One-touch Fittings	10-KG	P.1206
Stainless Miniature Fittings	10-MS	P.1217
Clean One-touch Fittings for Blowing	KP	P.1221
Clean One-touch Fittings for Driving Air Piping	KPQ/KPG	P.1225
Polyurethane Tubing	10-TU	P.1232
Polyurethane Coil Tubing	10-TCU	P.1233
Polyurethane Flat Tubing	10-TFU	P.1234
Clean Tubing: Polyolefin	TPH	P.1235
Clean Tubing: Soft Polyolefin	TPS	P.1236
Precautions		P.1237

Directional
Control Valves

Air Cylinders

Rotary Actuators

Air Grippers

Air Preparation
Equipment

Modular F. R.

Pressure Control
Equipment

Fittings & Tubing

Flow Control
Equipment

Pressure Switches/
Pressure Sensors

Series 10-KQ2

Metric Size One-touch Fittings

Applicable Tubing: Metric Size, Connection Thread: M, R, Rc

RoHS

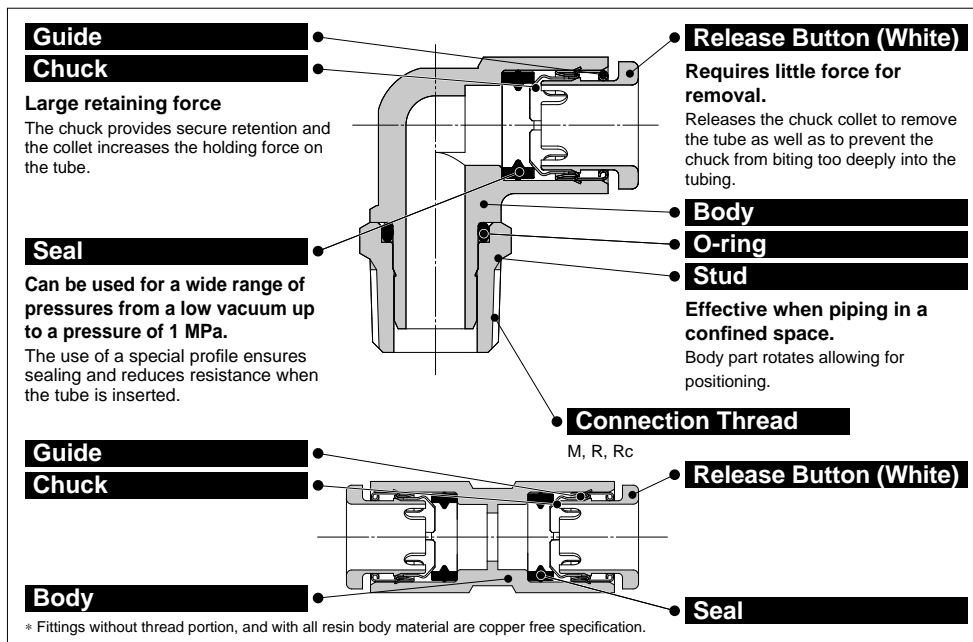

One-touch IN/OUT connection.
Possible to use in vacuum to -100 kPa

- Applicable tubing—Metric size
- Applicable tubing material
PFA, Polyurethane



Applicable Tubing

Tubing material ^{Note 1)}	PFA, Polyurethane
Tubing O.D.	ø2, ø3.2, ø4, ø6, ø8, ø10, ø12, ø16

Note 1) FEP, nylon and soft nylon tubing can also be used. However, the degree of clean performance will be reduced.

Color

Series	Body	Release button
Series 10-KQ2	White	White

Specifications

Fluid	Air, Water ^{Note 1)}	
Operating pressure range ^{Note 2)}	-100 kPa to 1 MPa	
Proof pressure (at 23°C)	3 MPa	
Ambient and fluid temperature	-5 to 60°C, Water: 0 to 40°C (No freezing)	
Thread	Mounting section	JIS B0203 (Taper thread for piping) JIS B0205 (Metric coarse thread)
	Nut section	JIS B0205 (Metric fine thread)
Seal on the threads	With seal or none	
Grease	Fluorine based grease	
Cleanliness class (ISO class)	Class 5	

Note 1) The surge pressure must be under the maximum operating pressure.

Note 2) Do not use the fittings with a leak tester or for vacuum retention because they are not guaranteed for zero leakage.

Principal Parts Material

Body	C3604 Electroless nickel plated, PBT, PP, Stainless steel 303
Stud	C3604 (Thread portion) Electroless nickel plated, Stainless steel 303 (Thread portion)
Chuck	Stainless steel 304
Guide	Stainless steel 304
Release button	POM
Seal, O-ring	NBR
Gasket	Stainless steel 304, NBR

Directional Control Valves

Air Cylinders

Rotary Actuators

Air Grippers

Air Preparation Equipment

Modular F. R.

Pressure Control Equipment

Fittings & Tubing

Flow Control Equipment

Pressure Switches/ Pressure Sensors

Metric Size One-touch Fittings

Variations

Hexagon socket head male connector

10-KQ2S P.1129



Internal hexagon socket allows tightening with a hexagon wrench in confined spaces.



Universal male elbow

10-KQ2V P.1134



Hexagon head of the body allows tightening with a box wrench in confined spaces.

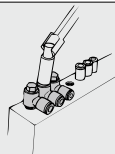

45° male elbow

10-KQ2K P.1133



Use to pipe a female thread at a 45° angle. The model between the male connector and male elbow.

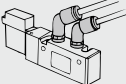

Extended male elbow

10-KQ2W P.1140



Basically, it is used together with male elbow. Different point is that it is used for fittings to avoid interfering with each other by making the piping multi-level.

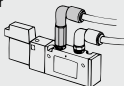

Bulkhead union

10-KQ2E P.1150



Use to connect tubing through a panel, etc.

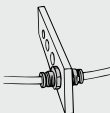

Bulkhead connector

10-KQ2E P.1150



Use to connect male thread and tubing through a panel, etc.

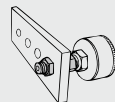

Nipple

10-KQN P.1152



Use to connect One-touch fittings.



Reducer nipple

10-KQN P.1152



Use to connect One-touch fittings of different sizes.

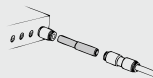

Universal female elbow

10-KQ2VF P.1135



Use to branch a male or female thread at a 90° angle. Multiple connections possible.

Branch universal female elbow

10-KQ2ZF P.1137



Use to two-branch a male or female thread at a 90° angle. Multiple connections possible.

Male connector

10-KQ2H P.1127



Use to pipe a female thread. Most general model.

Cross

10-KQ2TW P.1143



Use to four-branch line.

Reducer elbow

10-KQ2L P.1131



Use to change the tube direction from One-touch fittings by 90° and to reduce size.

Female connector

10-KQ2F P.1128



Use to pipe a male thread of a pressure gauge, etc.

Male elbow

10-KQ2L P.1130



Use to pipe a female thread at right angles. Most general model.

Different diameter cross

10-KQ2TX P.1143



Use to branch tubing with size reduced at both 90° angles.

Straight union

10-KQ2H P.1127



Use to connect tubing in the same direction.

Union elbow

10-KQ2L P.1131



Use to connect tubing at right angles.

Male branch tee

10-KQ2T P.1141



Use to branch a female thread at both 90° angles.

Different diameter straight

10-KQ2H P.1128



Use to connect tubing of different sizes.

Plug-in elbow

10-KQ2L P.1131



Use to change the tube direction from One-touch fittings by 90°.

Union tee

10-KQ2T P.1142



Use to branch tubing at both 90° angles.

Different diameter tee

10-KQ2T P.1142



Use to connect tubing for branching at both 90° angles with size reduced.

Different diameter tee

10-KQ2T P.1142



Use to connect tubing for branching at 90° angle with size reduced from the same piping.

Different diameter cross

10-KQ2TY P.1143



Use to connect tubing for branching in three directions with size reduced.

Hexagon socket head universal male elbow

10-KQ2VS P.1134



Hexagon socket on the top allows tightening with a hexagon wrench in confined spaces.

Male branch connector

10-KQ2LU P.1132



Use to branch a female thread at right angles.

Female elbow

10-KQ2LF P.1139



Use to pipe a male thread at right angles.

Double universal male elbow

10-KQ2VD P.1136



Use to branch a female thread at right angles. Two individual parts rotate 360°.

Triple universal male elbow

10-KQ2VT P.1136



Use to three-branch a female thread at right angles. Three individual parts rotate 360°.

Branch universal male elbow

10-KQ2ZZ P.1137



Hexagon head of the body allows tightening with a box wrench. Use for branch connections.

Double branch universal male elbow

10-KQ2ZD P.1138



Use to four-branch a female thread at right angles. Two individual parts rotate 360°.

Male run tee

10-KQ2Y P.1144



Use to branch a female thread at a 90° angle.

Triple branch universal male elbow

10-KQ2ZT P.1138



Use to six-branch a female thread at right angles. Three individual parts rotate 360°.

Branch union elbow

10-KQ2LU P.1131



Use to branch tubing at right angles.

Extended plug-in elbow

10-KQ2W P.1139



Use to change the tube direction of One-touch fittings by 90°. Multi-level piping is also possible with the plug-in elbow.

Male delta union

10-KQ2D P.1145



Use to branch a female thread at two right angles.

Delta union

10-KQ2D P.1146



Use to branch tubing at three right angles.

Union "Y"

10-KQ2U P.1147



Use to branch tubing in the same direction.

Different diameter union "Y"

10-KQ2U P.1147



Use to connect tubing for branching with size reduced.

Plug-in "Y"

10-KQ2U P.1147



Use to branch One-touch fittings.

Branch "Y"

10-KQ2U P.1146



Use to branch a female thread.

Plug-in reducer

10-KQ2R P.1150



Use to change size of One-touch fittings.

Bulkhead male elbow

10-KQ2LE P.1151



Use to connect tubing through a panel, etc. and to change the tube direction by 90°.

Adapter

10-KQ2N P.1151



Use to connect One-touch fittings and R female thread.

Tube cap

10-KQ2C P.1152



Use to plug unused tubing.

Color cap

10-KQ2C P.1152



Mount onto the release button and use different colors for piping according to applications.

Plug

10-KQP P.1151



Use to plug unused One-touch fittings.

Directional Control Valves

Air Cylinders

Rotary Actuators

Air Grippers

Air Preparation Equipment

Modular F. R.

Pressure Control Equipment

Fittings & Tubing

Flow Control Equipment

Pressure Switches/ Pressure Sensors

Dimensions

Male Connector: 10-KQ2H (Gasket seal)



Applicable tubing O.D. (mm)	Connection thread M	Model	H (Width across flats)	øD	L	A	M	Effective area (mm ²) Urethane	Min. port size	Weight (g)
ø2	M3 x 0.5	10-KQ2H02-M3G	7	5.5	15.6	13	11.9	0.9	1.2	1.5
	M5 x 0.8	10-KQ2H02-M5N	7	5.5	13.8	10.8	11.9	0.9	1.4	2
ø3.2	M3 x 0.5	10-KQ2H23-M3G	7	6.7	17	14.4	13.3	0.9	1.2	2.4
	M5 x 0.8	10-KQ2H23-M5N	7	6.7	17.3	14.3	13.3	2.5	2.5	2.7
ø4	M3 x 0.5	10-KQ2H04-M3G	8	7.7	17.1	14.5	13.3	0.9	1.2	2.9
	M5 x 0.8	10-KQ2H04-M5N	8	7.7	17.7	14.7	13.3	4	2.5	3.3
ø6	M6 x 1.0	10-KQ2H04-M6N	8	7.7	18.7	14.7	13.3	5.6	3	3.6
	M5 x 0.8	10-KQ2H06-M5N	10	9.7	17.7	14.7	13.3	4	2.5	4.1
ø6	M6 x 1.0	10-KQ2H06-M6N	10	9.7	18.8	14.8	13.3	5.6	3	4.4

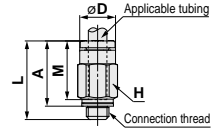

Male Connector: 10-KQ2H (Sealant)



Applicable tubing O.D. (mm)	Connection thread R	Model	H (Width across flats)	øD	L	A*	M	Effective area (mm ²) Urethane	Min. port size	Weight (g)
ø3.2	1/8	10-KQ2H23-01NS	10	6.7	14	10.9	13.3	2.9	2.5	6
	1/4	10-KQ2H23-02NS	14	6.7	16.7	12	13.3	2.9	2.5	15.3
ø4	1/8	10-KQ2H04-01NS	10	7.7	14.3	11.2	13.3	4	3	5.6
	1/4	10-KQ2H04-02NS	14	7.7	16.7	12	13.3	4	3	14.6
ø6	1/8	10-KQ2H06-01NS	10	9.7	18.4	15.3	13.3	10.4	4.5	5.8
	1/4	10-KQ2H06-02NS	14	9.7	16.7	12	13.3	10.4	4.5	12.5
ø8	3/8	10-KQ2H06-03NS	17	9.7	18.1	13	13.3	10.4	4.5	24.5
	1/8	10-KQ2H08-01NS	14	13	22.5	19.4	14.2	18	6	11.9
ø8	1/4	10-KQ2H08-02NS	14	13	22	17.3	14.2	18	6	13.9
	3/8	10-KQ2H08-03NS	17	13	18.1	13	14.2	18	6	21
ø10	1/8	10-KQ2H10-01NS	17	15.6	23.8	20.7	15.6	26.1	6	16.9
	1/4	10-KQ2H10-02NS	17	15.6	27.3	22.6	15.6	29.5	7.5	22.1
ø10	3/8	10-KQ2H10-03NS	17	15.6	23.5	18.4	15.6	29.5	7.5	22.5
	1/2	10-KQ2H10-04NS	22	15.6	22.3	15.9	15.6	29.5	7.5	44.7
ø12	1/4	10-KQ2H12-02NS	19	18.2	28.7	24	17	46.1	9	24.3
	3/8	10-KQ2H12-03NS	19	18.2	25.9	20.8	17	46.1	9	25.2
ø12	1/2	10-KQ2H12-04NS	22	18.2	22.3	15.9	17	46.1	9	37.7
	3/8	10-KQ2H16-02NS	24	23.6	32.5	27.8	20.6	58.3	9	37.4
ø16	1/2	10-KQ2H16-03NS	24	23.6	33.1	28	20.6	67	11	42.4
	3/4	10-KQ2H16-04NS	24	23.6	32.1	25.7	20.6	67	13	44.6

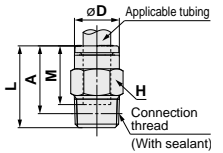

* Reference dimensions after installation of R thread

Straight Union: 10-KQ2H



Applicable tubing O.D. (mm)	Model	øD (Note)	L	M	Effective area (mm ²)	Min. port size	Weight (g)
					Urethane		
ø2	10-KQ2H02-00A	5.8	24.8	11.9	0.9	1.4	0.8
ø3.2	10-KQ2H23-00A	7.1	27.6	13.3	2.9	2.5	1.4
ø4	10-KQ2H04-00A	8.2	27.6	13.3	4	3	1.6
ø6	10-KQ2H06-00A	10.4	27.6	13.3	10.4	4.5	2.1
ø8	10-KQ2H08-00A	13.2	29.4	14.2	18	6	3.7
ø10	10-KQ2H10-00A	15.9	32.2	15.6	29.5	7.5	5.5
ø12	10-KQ2H12-00A	18.5	35	17	46.1	9	8.2
ø16	10-KQ2H16-00A	23.8	42.2	20.6	67	13	15.2

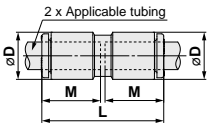

Note) øD is maximum diameter.

Dimensions

Different Diameter Straight: 10-KQ2H



Applicable tubing O.D. (mm)		Model	Note) ϕD_1	Note) ϕD_2	L	M1	M2	Effective area (mm ²) Urethane	Min. port size	Weight (g)
(a)	(b)									
$\phi 2$	$\phi 3.2$	10-KQ2H02-23A	5.8	7.1	26.2	11.9	13.3	0.9	1.4	1.1
$\phi 2$	$\phi 4$	10-KQ2H02-04A	5.8	8.2	26.2	11.9	13.3	0.9	1.4	1.2
$\phi 3.2$	$\phi 4$	10-KQ2H23-04A	7.1	8.2	27.6	13.3	13.3	2.9	2.5	1.5
$\phi 3.2$	$\phi 6$	10-KQ2H23-06A	7.1	10.4	27.6	13.3	13.3	2.9	2.5	1.8
$\phi 4$	$\phi 6$	10-KQ2H04-06A	8.2	10.4	27.6	13.3	13.3	5.6	3	2
$\phi 6$	$\phi 8$	10-KQ2H06-08A	10.4	13.2	28.5	13.3	14.2	10.4	4.5	2.9
$\phi 8$	$\phi 10$	10-KQ2H08-10A	13.2	15.9	30.8	14.2	15.6	18	6	4.9
$\phi 10$	$\phi 12$	10-KQ2H10-12A	15.9	18.5	33.6	15.6	17	29.5	7.5	7.2
$\phi 12$	$\phi 16$	10-KQ2H12-16A	18.5	23.8	38.6	17	20.6	46.1	9	12.4

Note) ϕD_1 , ϕD_2 are maximum diameters.

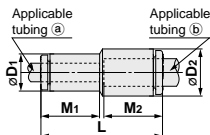

Female Connector: 10-KQ2F



Applicable tubing O.D. (mm)	Connection thread Rc	Model	H (Width across flats)	Note) ϕD	L1	L2	M	Effective area (mm ²) Urethane	Min. port size	Weight (g)
$\phi 3.2$	M3 x 0.5	10-KQ2F23-M3N	7	6.9	17.3	5.7	13.3	2.5	2.5	3.1
	M5 x 0.8	10-KQ2F23-M5N	7	6.9	19.7	5.7	13.3	2.5	2.5	3.3
$\phi 4$	M3 x 0.5	10-KQ2F04-M3N	8	7.9	17.3	5.7	13.3	4	2.5	4.1
	M5 x 0.8	10-KQ2F04-M5N	8	7.9	19.6	5.7	13.3	4	3	4.5
	1/8	10-KQ2F04-01N	14	7.9	24.1	8.5	13.3	4	3	12
	1/4	10-KQ2F04-02N	17	7.9	29	12.9	13.3	4	3	21.5
$\phi 6$	M5 x 0.8	10-KQ2F06-M5N	10	9.9	17.6	5.7	13.3	10	4.1	5.5
	1/8	10-KQ2F06-01N	14	9.9	23.6	8.5	13.3	10.4	4.5	12.2
	1/4	10-KQ2F06-02N	17	9.9	28.5	12.9	13.3	10.4	4.5	21.6
	3/8	10-KQ2F06-03N	19	9.9	29.9	12.7	13.3	10.4	4.5	22.7
$\phi 8$	1/8	10-KQ2F08-01N	14	13	24.1	8.5	14.2	18	6	12.9
	1/4	10-KQ2F08-02N	17	13	29	12.2	14.2	18	6	22.1
$\phi 10$	3/8	10-KQ2F08-03N	19	13	30.4	13.4	14.2	18	6	30.7
	1/4	10-KQ2F10-02N	17	15.6	30	12.9	15.6	29.5	7.5	24.2
$\phi 12$	3/8	10-KQ2F10-03N	19	15.6	31.3	13.3	15.6	29.5	7.5	25.5
	1/4	10-KQ2F12-02N	19	18.2	30.9	12.1	17	46.1	9	32.6
$\phi 16$	3/8	10-KQ2F12-03N	19	18.2	32.3	13.3	17	46.1	9	27.6
	1/2	10-KQ2F12-04N	24	18.2	36.3	15.9	17	46.1	9	46.3
$\phi 16$	3/8	10-KQ2F16-03N	24	23.6	34.7	12.6	20.6	67	13	53.8
	1/2	10-KQ2F16-04N	24	23.6	38.7	15.9	20.6	67	13	51.6

Note) ϕD is maximum diameter.

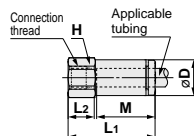

Dimensions

Hexagon Socket Head Male Connector: 10-KQ2S (Gasket seal)



Applicable tubing O.D. (mm)	Connection thread M	Model	H (Width across flats)	Note) ϕD	L1	L2	A	M	Effective area (mm ²) Urethane	Min. port size	Weight (g)
$\phi 3.2$	M3 x 0.5	10-KQ2S23-M3G	1.5	7	17.1	16.1	14.5	13.3	1.4	1.5	2.2
	M5 x 0.8	10-KQ2S23-M5N	2	7	17.5	16.3	14.5	13.3	2.5	2	2.6
$\phi 4$	M3 x 0.5	10-KQ2S04-M3G	1.5	8	17.1	16.1	14.5	13.3	1.4	1.5	2.3
	M5 x 0.8	10-KQ2S04-M5N	2	8	17.6	16.3	14.6	13.3	2.5	2	3
	M6 x 1.0	10-KQ2S04-M6N	3	8	20.6	19.6	16.6	13.3	4	3.1	4.1
$\phi 6$	M5 x 0.8	10-KQ2S06-M5N	2	10	17.6	16.3	14.6	13.3	2.5	2	3.5
	M6 x 1.0	10-KQ2S06-M6N	3	10	20.6	19.6	16.6	13.3	4	3.1	5.1

Note) ϕD is maximum diameter.

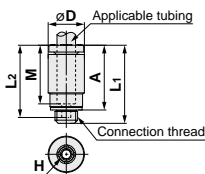

Hexagon Socket Head Male Connector: 10-KQ2S (Sealant)



Applicable tubing O.D. (mm)	Connection thread R	Model	H (Width across flats)	Note) ϕD	L1	L2	A*	M	Effective area (mm ²) Urethane	Min. port size	Weight (g)
$\phi 6$	1/8	10-KQ2S06-01NS	4	10	20.3	18.8	17.2	13.3	9.9	4.1	6.5
	1/4	10-KQ2S06-02NS	4	14	19.8	18.8	15.1	13.3	10	4.1	13.4
$\phi 8$	1/8	10-KQ2S08-01NS	5	13	22.9	19.7	19.8	14.2	16.2	5.1	10.2
	1/4	10-KQ2S08-02NS	6	14	23.2	19.5	18.5	14.2	16.2	6.1	14.3
	3/8	10-KQ2S08-03NS	6	17	20.7	19.7	15.6	14.2	16.2	6.1	21.1
$\phi 10$	1/8	10-KQ2S10-01NS	5	15.6	24.3	21.1	21.2	15.6	16.2	5.1	12
	1/4	10-KQ2S10-02NS	8	15.6	24.6	20.1	19.9	15.6	26.6	8.1	12.4
	3/8	10-KQ2S10-03NS	8	17	25.1	20.1	20	15.6	26.6	8.1	23.2
	1/2	10-KQ2S10-04NS	8	22	21.1	20.1	14.7	15.6	26.6	8.1	37.4
$\phi 12$	1/4	10-KQ2S12-02NS	8	18.2	29	21.5	24.3	17	44.5	8.1	21
	3/8	10-KQ2S12-03NS	10	18.2	26.4	21.8	21.3	17	44.5	10.1	21.2
$\phi 16$	1/2	10-KQ2S12-04NS	10	22	22.8	21.8	16.4	17	44.5	10.1	30.5
	^{New} 1/4	10-KQ2S16-02NS	8	23.6	32.5	25.1	27.8	20.6	46	8.1	25.7
	3/8	10-KQ2S16-03NS	10	23.6	33.5	25.4	28.4	20.6	67	10.1	38.3
	1/2	10-KQ2S16-04NS	12	23.6	33.4	26.1	27	20.6	67	12.1	43.5

* Reference dimensions after installation of R thread
Note) ϕD is maximum diameter.

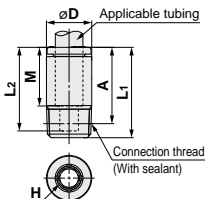

Dimensions

Male Elbow: 10-KQ2L (Gasket seal)



Applicable tubing O.D. (mm)	Connection thread M	Model	H (Width across flats)	Note) ϕD_1	ϕD_2	L ₁	L ₂	A	M	Effective area (mm ²) Urethane	Min. port size	Weight (g)
$\phi 2$	M3 x 0.5	10-KQ2L02-M3G	5.5	5.8	5.5	12.6	12.5	12.8	11.9	0.8	1.2	1.6
	M5 x 0.8	10-KQ2L02-M5N	7	5.8	5.5	12.6	13	12.9	11.9	0.8	1.4	2.7
$\phi 3.2$	M3 x 0.5	10-KQ2L23-M3G	7	7.1	7	15.3	13.8	14.8	13.3	0.8	1.2	2.7
	M5 x 0.8	10-KQ2L23-M5N	7	7.1	7	15.3	14.3	14.9	13.3	2.2	2.5	3.1
$\phi 4$	M3 x 0.5	10-KQ2L04-M3G	7	8.2	7	15.4	14.3	15.8	13.3	0.8	1.2	2.7
	M5 x 0.8	10-KQ2L04-M5N	7	8.2	7	15.4	14.8	15.9	13.3	3.5	2.5	3.1
$\phi 6$	M6 x 1.0	10-KQ2L04-M6N	8	8.2	7	15.4	15.8	15.9	13.3	3.5	2.5	4.2
	M5 x 0.8	10-KQ2L06-M5N	7	10.4	7	14.5	16.5	16.7	13.3	3.5	2.5	3.2
	M6 x 1.0	10-KQ2L06-M6N	8	10.4	7	14.5	17.5	18.7	13.3	3.5	2.5	4.3

Note) ϕD_1 is maximum diameter.

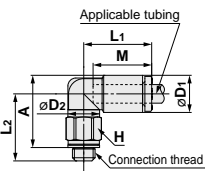

Male Elbow: 10-KQ2L (Sealant)



Applicable tubing O.D. (mm)	Connection thread R	Model	H (Width across flats)	Note) ϕD_1	ϕD_2	L ₁	L ₂	A*	M	Effective area (mm ²) Urethane	Min. port size	Weight (g)
$\phi 3.2$	1/8	10-KQ2L23-01NS	10	7.1	10	14.5	16.7	17.2	13.3	2.5	2.5	4.6
	1/4	10-KQ2L23-02NS	14	7.1	10	14.5	21.2	20.1	13.3	2.5	2.5	14.1
$\phi 4$	1/8	10-KQ2L04-01NS	10	8.2	10	14.8	16.2	17.2	13.3	4.2	3	4.8
	1/4	10-KQ2L04-02NS	14	8.2	10	14.8	21.7	21.1	13.3	4.2	3	14.3
$\phi 6$	1/8	10-KQ2L06-01NS	10	10.4	10	15.5	17.3	19.4	13.3	9	4.5	5.2
	1/4	10-KQ2L06-02NS	14	10.4	10	15.5	22.8	23.3	13.3	9	4.5	14.7
$\phi 8$	3/8	10-KQ2L06-03NS	17	10.4	10	15.5	24.1	24.2	13.3	9	4.5	26.5
	1/8	10-KQ2L08-01NS	10	13.2	10	16.4	18.7	22.2	14.2	11.4	4.5	6.1
$\phi 10$	1/4	10-KQ2L08-02NS	14	13.2	12	17.2	25.4	27.3	14.2	14.9	6	17.7
	3/8	10-KQ2L08-03NS	17	13.2	12	17.2	25.5	27.0	14.2	14.9	6	24.7
$\phi 12$	1/8	10-KQ2L10-01NS	12	15.9	12	18.6	23.6	28.4	15.6	14.9	6	11.1
	1/4	10-KQ2L10-02NS	17	15.9	17	19.3	28.7	31.9	15.6	25	7.5	21.7
$\phi 16$	3/8	10-KQ2L10-03NS	17	15.9	17	19.3	29.6	32.4	15.6	25	7.5	22.2
	1/2	10-KQ2L10-04NS	22	15.9	17	19.3	33.6	35.1	15.6	25	7.5	44.6
$\phi 12$	1/4	10-KQ2L12-02NS	17	18.5	17	21.5	30.0	34.5	17	39.7	9	23.5
	3/8	10-KQ2L12-03NS	17	18.5	17	21.5	30.9	35.0	17	39.7	9	24.1
$\phi 16$	1/2	10-KQ2L12-04NS	22	18.5	17	21.5	34.9	37.7	17	39.7	9	46.5
	3/8	10-KQ2L16-02NS	17	23.8	17	25.1	32.6	39.8	20.6	50.2	9	27.8
$\phi 16$	3/8	10-KQ2L16-03NS	22	23.8	21	27.1	35.4	42.2	20.6	58.9	11	40.8
	1/2	10-KQ2L16-04NS	22	23.8	21	27.1	34.1	39.6	20.6	58.9	13	44.5

* Reference dimensions after installation of R thread
Note) ϕD_1 is maximum diameter.

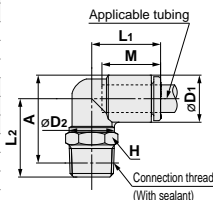

Directional Control Valves

Air Cylinders

Rotary Actuators

Air Grippers

Air Preparation Equipment

Modular F. R.

Pressure Control Equipment

Fittings & Tubing

Flow Control Equipment

Pressure Switches/ Pressure Sensors

Dimensions

Union Elbow: 10-KQ2L



Applicable tubing O.D. (mm)	Model	Note) ϕD	L	Q	M	ϕO	ϕN	Effective area (mm ²) Urethane	Min. port size	Weight (g)
$\phi 3.2$	10-KQ2L23-00A	7.1	14.9	5.4	13.3	6	3.2	2.5	2.5	1.6
$\phi 4$	10-KQ2L04-00A	8.2	15.3	5.7	13.3	6	3.2	4.2	3	1.9
$\phi 6$	10-KQ2L06-00A	10.4	16.3	6.8	13.3	6	3.2	9	4.5	2.7
$\phi 8$	10-KQ2L08-00A	13.2	18.2	8.4	14.2	8	4.2	14.9	6	4.7
$\phi 10$	10-KQ2L10-00A	15.9	20.6	9.6	15.6	8	4.2	25	7.5	7.1
$\phi 12$	10-KQ2L12-00A	18.5	23	10.7	17	8	4.2	39.7	9	10.3
$\phi 16$	10-KQ2L16-00A	23.8	28.6	13.4	20.6	8	4.2	58.9	13	19.7

Note) ϕD is maximum diameter.

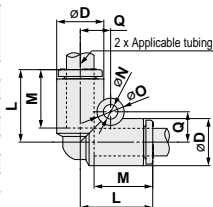

Plug-in Elbow: 10-KQ2L



Applicable tubing O.D. (mm)	Applicable fitting size ϕd	Model	Note) ϕD_1	ϕD_2	L ₁	L ₂	A	M	Effective area (mm ²) Urethane	Min. port size	Weight (g)
$\phi 3.2$	$\phi 3.2$	10-KQ2L23-99A	7.1	6.4	14.4	20.9	11.1	13.3	2.5	2.2	0.9
$\phi 4$	$\phi 4$	10-KQ2L04-99A	8.2	7.2	14.5	21.1	11.9	13.3	4.2	2.5	1.2
$\phi 6$	$\phi 6$	10-KQ2L06-99A	10.4	8	15.3	22.3	14.2	13.3	9	4	1.8
$\phi 8$	$\phi 8$	10-KQ2L08-99A	13.2	10	17.2	26.2	18.6	14.2	14.9	6	3
$\phi 10$	$\phi 10$	10-KQ2L10-99A	15.9	12	19.3	28.2	20.5	15.6	25	7.5	4.7
$\phi 12$	$\phi 12$	10-KQ2L12-99A	18.5	14	21.5	31	23.2	17	39.7	9	7
$\phi 16$	$\phi 16$	10-KQ2L16-99A	23.8	20	27.1	36.8	28.1	20.6	58.9	13	13.7

Note) ϕD_1 is maximum diameter.

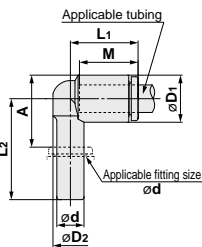

Reducer Elbow: 10-KQ2L



Applicable tubing O.D. (mm)	Applicable fitting size ϕd	Model	Note) ϕD_1	ϕD_2	L ₁	L ₂	A	M	Effective area (mm ²) Urethane	Min. port size	Weight (g)
$\phi 3.2$	$\phi 4$	10-KQ2L23-04A	7.1	6.4	14.5	23.9	14.1	13.3	2.5	2.5	1.1
	$\phi 6$	10-KQ2L23-06A	7.1	6.4	14.5	24.1	14.3	13.3	2.5	2.5	1.3
$\phi 4$	$\phi 6$	10-KQ2L04-06A	8.2	7.2	14.8	24.6	15.4	13.3	4.2	3	1.5
	$\phi 8$	10-KQ2L04-08A	8.2	7.2	14.8	29.5	19.4	13.3	4.2	3	1.8
$\phi 6$	$\phi 8$	10-KQ2L06-08A	10.4	9	15.5	24.2	15.2	13.3	9	4.5	2.1
	$\phi 10$	10-KQ2L06-10A	10.4	9	15.5	31.6	21.2	13.3	9	4.5	2.7
$\phi 8$	$\phi 10$	10-KQ2L08-10A	13.2	10	18.8	27.1	18.1	14.2	14.9	6	3.5
	$\phi 12$	10-KQ2L08-12A	13.2	10	18.8	34	23.6	14.2	14.9	6	4.9
$\phi 10$	$\phi 12$	10-KQ2L10-12A	15.9	12	19.3	35.6	26.5	15.6	25	7.5	5.6
	$\phi 16$	10-KQ2L12-16A	18.5	14	21.5	42.6	31.2	17	39.7	9	8.7

Note) ϕD_1 is maximum diameter.

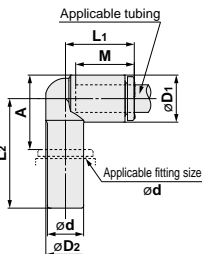

Branch Union Elbow: 10-KQ2LU



Applicable tubing O.D. (mm)	Model	Note) ϕD	L ₁	L ₂	Q ₁	Q ₂	M	P	ϕO	ϕN	Effective area (mm ²) Urethane	Min. port size	Weight (g)
$\phi 4$	10-KQ2LU04-00A	8.2	15.8	19.9	15.8	7.9	13.3	8.2	6	3.2	4.1	3	3.1
$\phi 6$	10-KQ2LU06-00A	10.4	16.5	21.7	16.5	10	13.3	10.4	6	3.2	11	4.5	4.4
$\phi 8$	10-KQ2LU08-00A	13.2	18.2	24.8	18.2	13.1	14.2	13.2	8	4.2	18.2	6	8
$\phi 10$	10-KQ2LU10-00A	15.9	20.3	28.3	20.3	15.9	15.6	15.9	8	4.2	29	7.5	12.2
$\phi 12$	10-KQ2LU12-00A	18.5	22.5	31.7	22.5	17.9	17	18.5	8	4.2	45.2	9	18.1

Note) ϕD is maximum diameter.

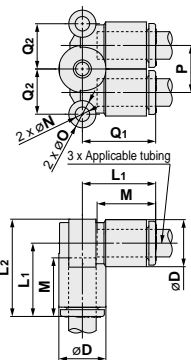

Dimensions

Male Branch Connector: 10-KQ2LU (Gasket seal)



Applicable tubing O.D. (mm)	Connection thread M	Model	H (Width across flats)	Note) ϕD	L1	L2	L3	A	M	P	ϕO	ϕN	Q1	Q2	Effective area (mm ²) Urethane	Min. port size	Weight (g)
$\phi 4$	M5 x 0.8	10-KQ2LU04-M5N	10	8.2	15.8	20.7	24.8	21.8	13.3	8.2	6	3.2	15.8	7.9	4.1	1.8	6.9
	M6 x 1.0	10-KQ2LU04-M6N	10	8.2	15.8	21.7	25.8	21.8	13.3	8.2	6	3.2	15.8	7.9	4.1	3	6.8
$\phi 6$	M5 x 0.8	10-KQ2LU06-M5N	12	10.4	16.5	21.4	26.6	23.6	13.3	10.4	6	3.2	16.5	10	4.3	1.8	10.3
	M6 x 1.0	10-KQ2LU06-M6N	12	10.4	16.5	22.4	27.6	23.6	13.3	10.4	6	3.2	16.5	10	4.3	3	10.3

Note) ϕD is maximum diameter.

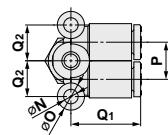

2 x Applicable tubing

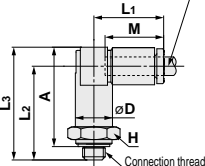

Directional Control Valves
Air Cylinders
Rotary Actuators

Male Branch Connector: 10-KQ2LU (Sealant)



Applicable tubing O.D. (mm)	Connection thread R	Model	H (Width across flats)	Note) ϕD	L1	L2	L3	A*	M	P	ϕO	ϕN	Q1	Q2	Effective area (mm ²) Urethane	Min. port size	Weight (g)
$\phi 4$	1/8	10-KQ2LU04-01NS	10	8.2	15.8	23.3	27.4	24.3	13.3	8.2	6	3.2	15.8	7.9	4.1	3	9.5
	1/4	10-KQ2LU04-02NS	14	8.2	15.8	27.7	31.8	27.1	13.3	8.2	6	3.2	15.8	7.9	4.1	3	19.3
$\phi 6$	1/8	10-KQ2LU06-01NS	12	10.4	16.5	24	29.2	26.1	13.3	10.4	6	3.2	16.5	10	11	4.5	10.6
	1/4	10-KQ2LU06-02NS	14	10.4	16.5	28.4	33.6	28.9	13.3	10.4	6	3.2	16.5	10	11	4.5	19.5
$\phi 8$	3/8	10-KQ2LU06-03NS	17	10.4	16.5	29.8	35	29.9	13.3	10.4	6	3.2	16.5	10	11	4.5	31.5
	1/2	10-KQ2LU06-04NS	17	10.4	16.5	32.2	40.2	35.5	15.6	15.9	8	4.2	20.3	15.9	29	7.5	26.6
$\phi 10$	3/8	10-KQ2LU10-03NS	17	15.9	20.3	33.6	41.6	36.5	15.6	15.9	8	4.2	20.3	15.9	29	7.5	34.4
	1/2	10-KQ2LU10-04NS	22	15.9	20.3	37.8	45.8	39.4	15.6	15.9	8	4.2	20.3	15.9	29	7.5	62.3
$\phi 12$	1/4	10-KQ2LU12-02NS	19	18.5	22.5	34.4	43.6	38.9	17	18.5	8	4.2	22.5	17.9	45.2	9	37.7
	3/8	10-KQ2LU12-03NS	19	18.5	22.5	35.8	45	39.9	17	18.5	8	4.2	22.5	17.9	45.2	9	40.6
	1/2	10-KQ2LU12-04NS	22	18.5	22.5	40	49.2	42.8	17	18.5	8	4.2	22.5	17.9	45.2	9	62.7

* Reference dimensions after installation of R thread
Note) ϕD is maximum diameter.

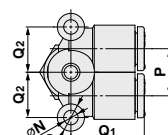

2 x Applicable tubing

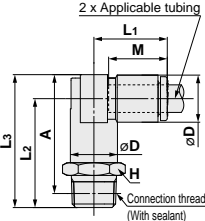

Air Grippers
Air Preparation Equipment
Modular F. R.

Pressure Control Equipment
Fittings & Tubing
Flow Control Equipment
Pressure Switches/ Pressure Sensors

Dimensions

45° Male Elbow: 10-KQ2K (Gasket seal)



Applicable tubing O.D. (mm)	Connection thread M	Model	H (Width across flats)	Note) ϕD_1	ϕD_2	L ₁	L ₂	A	M	Effective area (mm ²) Urethane	Min. port size	Weight (g)
	M6 x 1.0	10-KQ2K04-M6N	8	8.2	7	14.4	14.1	22.8	13.3	3.4	2.5	4.1
$\phi 6$	M5 x 0.8	10-KQ2K06-M5N	7	10.4	7	14.4	17	27.4	13.3	3.4	2.5	3.5
	M6 x 1.0	10-KQ2K06-M6N	8	10.4	7	14.4	18	27.4	13.3	3.4	2.5	4.5

Note) ϕD_1 is maximum diameter.

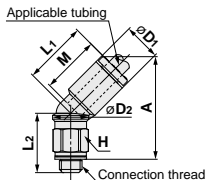

45° Male Elbow: 10-KQ2K (Sealant)



Applicable tubing O.D. (mm)	Connection thread R	Model	H (Width across flats)	Note) ϕD_1	ϕD_2	L ₁	L ₂	A*	M	Effective area (mm ²) Urethane	Min. port size	Weight (g)
	1/4	10-KQ2K04-02NS	14	8.2	10	14.4	17.2	25.2	13.3	3.4	3	14.1
	3/8	10-KQ2K06-01NS	10	10.4	10	14.7	14.8	25.3	13.3	6.9	4.5	5
$\phi 6$	1/4	10-KQ2K06-02NS	14	10.4	10	14.7	19.3	28.2	13.3	6.9	4.5	14.5
	3/8	10-KQ2K06-03NS	17	10.4	10	14.7	20.6	29.1	13.3	6.9	4.5	26.2
$\phi 8$	1/8	10-KQ2K08-01NS	10	13.2	10	16	15.7	28	14.2	8.7	4.5	6
	1/4	10-KQ2K08-02NS	14	13.2	12	16	22.4	33.1	14.2	19.7	6	17.5
	3/8	10-KQ2K08-03NS	17	13.2	12	16	22.5	32.8	14.2	19.7	6	24.5
	1/8	10-KQ2K10-01NS	12	15.9	12	18.2	21.5	36.2	15.6	23.2	6	11.1
$\phi 10$	1/4	10-KQ2K10-02NS	17	15.9	17	17.6	29.1	41.8	15.6	23.2	7.5	21.8
	3/8	10-KQ2K10-03NS	17	15.9	17	17.6	24.3	36.6	15.6	23.2	7.5	21.7
	1/2	10-KQ2K10-04NS	22	15.9	17	17.6	28.3	39.3	15.6	23.2	7.5	44.1
$\phi 12$	1/4	10-KQ2K12-02NS	17	18.5	17	19.4	29	43.8	17	35.1	9	23.3
	3/8	10-KQ2K12-03NS	17	18.5	17	19.4	24.2	38.6	17	35.1	9	23.2
	1/2	10-KQ2K12-04NS	22	18.5	17	19.4	28.2	41.3	17	35.1	9	45.7
$\phi 16$	^{1/2} 1/4	10-KQ2K16-02NS	17	23.8	17	24.3	29.6	49.2	20.6	44.5	9	27.7
	3/8	10-KQ2K16-03NS	22	23.8	21	23.8	31.4	50.2	20.6	58	11	39.2
	1/2	10-KQ2K16-04NS	22	23.8	21	23.8	30.1	47.6	20.6	58	13	42.9

* Reference dimensions after installation of R thread
Note) ϕD_1 is maximum diameter.

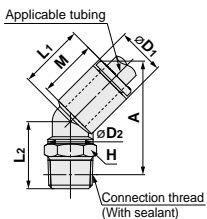

Dimensions

Universal Male Elbow: 10-KQ2V (Gasket seal)



Applicable tubing O.D. (mm)	Connection thread M	Model	H (Width across flats)	Note) ϕD_1	ϕD_2	L ₁	L ₂	L ₃	A	M	Effective area (mm ²) Urethane	Min. port size	Weight (g)
$\phi 4$	M5 x 0.8	10-KQ2V04-M5N	8	8.2	9.8	17.5	10.9	18.4	14.9	13.3	2.9	2.5	5.4
$\phi 6$	M5 x 0.8	10-KQ2V06-M5N	8	10.4	9.8	18.3	10.9	18.4	14.9	13.3	3.8	2.5	5.7

(Note) ϕD_1 is maximum diameter.

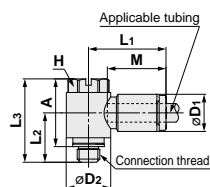

Universal Male Elbow: 10-KQ2V (Sealant)



Applicable tubing O.D. (mm)	Connection thread R	Model	H (Width across flats)	Note) ϕD_1	ϕD_2	L ₁	L ₂	L ₃	A*	M	Effective area (mm ²) Urethane	Min. port size	Weight (g)
$\phi 4$	1/8	10-KQ2V04-01NS	8	8.2	13.4	19.3	13.7	25.6	22.5	13.3	2.9	3	13.2
	1/8	10-KQ2V06-01NS	8	10.4	13.4	20.5	13.7	25.6	22.5	13.3	5.9	4.5	13.5
$\phi 6$	1/4	10-KQ2V06-02NS	10	10.4	15.3	19.9	17.9	30.5	25.8	13.3	5.9	4.5	24.9
	1/8	10-KQ2V08-01NS	12	13.2	17.6	23.5	15.1	27.6	24.5	14.2	11.2	6	22.6
$\phi 8$	1/4	10-KQ2V08-02NS	12	13.2	17.6	23.5	18.5	31	26.3	14.2	11.2	6	29.1
	3/8	10-KQ2V08-03NS	14	13.2	20.6	23.1	19.5	35.3	30.2	14.2	11.2	6	44.4
$\phi 10$	1/4	10-KQ2V10-02NS	14	15.9	20.6	25.9	19.9	34.9	30.2	15.6	20.3	7.5	38.1
	3/8	10-KQ2V10-03NS	14	15.9	20.6	25.9	20.3	35.3	30.2	15.6	20.3	7.5	45.7
$\phi 12$	3/8	10-KQ2V12-03NS	17	18.5	25.2	28.5	21.4	37.6	32.5	17	30.8	9	59.6
	1/2	10-KQ2V12-04NS	17	18.5	25.2	28.5	24.6	40.8	34.4	17	30.8	9	78.2
$\phi 16$	3/8	10-KQ2V16-03NS	21	23.8	32.3	34.2	25.1	45.4	40.3	20.6	46	11	99.5
	1/2	10-KQ2V16-04NS	21	23.8	32.3	34.2	28.3	48.6	42.2	20.6	46	13	107.9

* Reference dimensions after installation of R thread
(Note) ϕD_1 is maximum diameter.

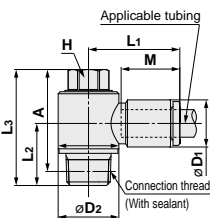

Hexagon Socket Head Universal Male Elbow: 10-KQ2VS (Gasket seal)



Applicable tubing O.D. (mm)	Connection thread M	Model	H (Width across flats)	Note) ϕD_1	ϕD_2	L ₁	L ₂	L ₃	A	M	Effective area (mm ²) Urethane	Min. port size	Weight (g)
$\phi 4$	M5 x 0.8	10-KQ2VS04-M5N	4	8.2	9.8	17.5	10.4	18.2	15.2	13.3	2.9	2.5	5.3
$\phi 6$	M5 x 0.8	10-KQ2VS06-M5N	4	10.4	9.8	18.3	10.4	18.2	15.2	13.3	3.8	2.5	5.6

(Note) ϕD_1 is maximum diameter.

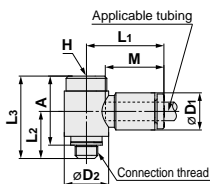

Hexagon Socket Head Universal Male Elbow: 10-KQ2VS (Sealant)



Applicable tubing O.D. (mm)	Connection thread R	Model	H (Width across flats)	Note) ϕD_1	ϕD_2	L ₁	L ₂	L ₃	A*	M	Effective area (mm ²) Urethane	Min. port size	Weight (g)
$\phi 4$	1/8	10-KQ2VS04-01NS	6	8.2	13.4	19.3	13.7	25.8	22.7	13.3	2.9	3	13.2
	1/8	10-KQ2VS06-01NS	6	10.4	13.4	20.5	13.7	25.8	22.7	13.3	5.9	4.5	13.5
$\phi 6$	1/4	10-KQ2VS06-02NS	6	10.4	15.3	19.9	17.9	26.5	21.8	13.3	5.9	4.5	20.8
	1/8	10-KQ2VS08-01NS	8	13.2	17.6	23.5	15.1	26	22.9	14.2	11.2	6	19.2
$\phi 8$	1/4	10-KQ2VS08-02NS	8	13.2	17.6	23.5	18.5	29.5	24.8	14.2	11.2	6	25.7
	3/8	10-KQ2VS08-03NS	8	13.2	20.6	23.1	19.5	31.4	26.3	14.2	11.2	6	37
$\phi 10$	1/4	10-KQ2VS10-02NS	8	15.9	20.6	25.9	19.7	30.8	26.1	15.6	20.3	7.5	30.4
	3/8	10-KQ2VS10-03NS	8	15.9	20.6	25.9	20.3	31.4	26.3	15.6	20.3	7.5	38.3
$\phi 12$	3/8	10-KQ2VS12-03NS	10	18.5	25.2	28.5	21.4	35.1	30	17	30.8	9	51.4
	1/2	10-KQ2VS12-04NS	10	18.5	25.2	28.5	24.6	38.3	31.9	17	30.8	9	70

* Reference dimensions after installation of R thread
(Note) ϕD_1 is maximum diameter.

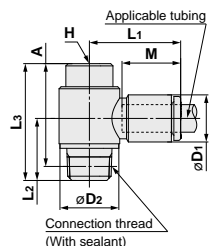

Dimensions

Universal Female Elbow: 10-KQ2VF (Gasket seal)



Applicable tubing O.D. (mm)	Connection thread M	Model	H (Width across flats)	Note) ϕD_1	ϕD_2	L ₁	L ₂	L ₃	A	M	Effective area (mm ²) Urethane	Min. port size	Weight (g)
$\phi 4$	M5 x 0.8	10-KQ2VF04-M5N	8	8.2	9.8	17.5	10.2	19.2	16.2	13.3	2.9	2.5	5.5
$\phi 6$	M5 x 0.8	10-KQ2VF06-M5N	8	10.4	9.8	18.3	10.2	19.2	16.2	13.3	3.8	2.5	5.8

Note) ϕD_1 is maximum diameter.

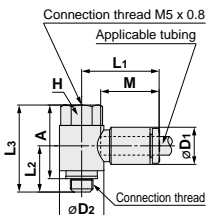

Universal Female Elbow: 10-KQ2VF (Sealant)



Applicable tubing O.D. (mm)	Connection thread R, Rc	Model	H (Width across flats)	Note) ϕD_1	ϕD_2	L ₁	L ₂	L ₃	A*	M	Effective area (mm ²) Urethane	Min. port size	Weight (g)
$\phi 4$	1/8	10-KQ2VF04-01NS	14	8.2	13.4	19.3	14.4	28.5	25.4	13.3	2.9	3	17.3
$\phi 4$	1/8	10-KQ2VF06-01NS	14	10.4	13.4	20.5	14.4	28.5	25.4	13.3	5.9	4.5	17.6
$\phi 6$	1/4	10-KQ2VF06-02NS	17	10.4	17.6	21.2	19.4	37.9	33.2	13.3	5.9	4.5	37
$\phi 8$	1/8	10-KQ2VF08-01NS	17	13.2	17.6	23.5	15.5	30	26.9	14.2	11.2	6	27.5
$\phi 8$	1/4	10-KQ2VF08-02NS	17	13.2	17.6	23.5	18.9	37.9	33.2	14.2	11.2	6	38.1
$\phi 8$	3/8	10-KQ2VF08-03NS	22	13.2	25.2	24.9	24	44	38.9	14.2	11.2	6	64.5
$\phi 10$	1/4	10-KQ2VF10-02NS	19	15.9	20.6	25.9	20.4	40.3	35.6	15.6	20.3	7.5	46.4
$\phi 10$	3/8	10-KQ2VF10-03NS	22	15.9	25.2	26.3	23.2	44	38.9	15.6	20.3	7.5	65.3
$\phi 12$	3/8	10-KQ2VF12-03NS	22	18.5	25.2	28.5	22.5	44	38.9	17	30.8	9	67.2
$\phi 12$	1/2	10-KQ2VF12-04NS	24	18.5	27	29.9	24.4	48.9	42.5	17	30.8	9	95.6

* Reference dimensions after installation of R thread
Note) ϕD_1 is maximum diameter.

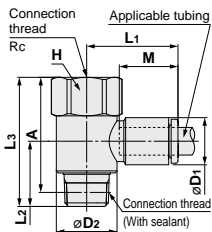

Dimensions

Triple Universal Male Elbow: 10-KQ2VT (Sealant)



Applicable tubing O.D. (mm)	Connection thread R	Model	H (Width across flats)	Note) ϕD_1	ϕD_2	L1	L2	L3	A*	M	P	Effective area (mm ²) Urethane	Min. port size	Weight (g)
$\phi 4$	1/8	10-KQ2VT04-01NS	14	8.2	13.4	19.3	16.3	52.5	49.4	13.3	13.4	2.9	3	25.3
	1/4	10-KQ2VT04-02NS	14	8.2	13.4	19.3	20.7	56.9	52.2	13.3	13.4	2.9	3	32.9
	3/8	10-KQ2VT04-03NS	17	8.2	13.4	19.3	22.1	58.3	53.2	13.3	13.4	2.9	3	44.8
$\phi 6$	1/8	10-KQ2VT06-01NS	14	10.4	13.4	20.5	16.3	52.5	49.4	13.3	13.4	5.9	4.5	26.2
	1/4	10-KQ2VT06-02NS	14	10.4	13.4	20.5	20.7	56.9	52.2	13.3	13.4	5.9	4.5	33.9
	3/8	10-KQ2VT06-03NS	17	10.4	13.4	20.5	22.1	58.3	53.2	13.3	13.4	5.9	4.5	45.8
$\phi 8$	1/8	10-KQ2VT08-01NS	19	13.2	17.6	23.7	19	61.8	58.7	14.2	15.9	11.2	6	58.6
	1/4	10-KQ2VT08-02NS	19	13.2	17.6	23.7	22.4	65.2	60.5	14.2	15.9	11.2	6	58.8
	3/8	10-KQ2VT08-03NS	19	13.2	17.6	23.7	23	65.8	60.7	14.2	15.9	11.2	6	64.9
$\phi 10$	1/2	10-KQ2VT10-02NS	22	13.2	17.6	23.7	27.2	70	63.6	14.2	15.9	11.2	6	91.5
	1/4	10-KQ2VT10-03NS	21	15.9	20.6	25.7	24.3	75.5	70.8	15.6	19.2	20.3	7.5	82
	3/8	10-KQ2VT10-04NS	21	15.9	20.6	25.7	24.7	75.9	70.8	15.6	19.2	20.3	7.5	81.9
$\phi 12$	1/2	10-KQ2VT12-04NS	26	18.5	25.2	28.9	26.5	84.1	79.4	17	21.6	30.8	9	139.3
	3/8	10-KQ2VT12-03NS	26	18.5	25.2	28.9	26.9	84.5	79.4	17	21.6	30.8	9	129.7
	1/2	10-KQ2VT12-04NS	26	18.5	25.2	28.9	30.1	87.7	81.3	17	21.6	30.8	9	142.2

* Reference dimensions after installation of R thread
Note) ϕD_1 is maximum diameter.

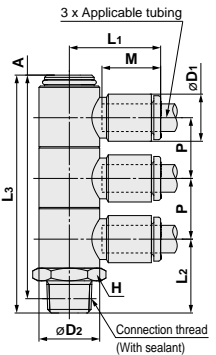

Directional Control Valves
Air Cylinders
Rotary Actuators

Double Universal Male Elbow: 10-KQ2VD (Sealant)



Applicable tubing O.D. (mm)	Connection thread R	Model	H (Width across flats)	Note) ϕD_1	ϕD_2	L1	L2	L3	A*	M	P	Effective area (mm ²) Urethane	Min. port size	Weight (g)
$\phi 4$	1/8	10-KQ2VD04-01NS	14	8.2	13.4	19.3	16.3	39	35.9	13.3	13.4	2.9	3	19.7
	1/4	10-KQ2VD04-02NS	14	8.2	13.4	19.3	20.7	43.4	38.7	13.3	13.4	2.9	3	27.4
	3/8	10-KQ2VD04-03NS	17	8.2	13.4	19.3	22.1	44.8	39.7	13.3	13.4	2.9	3	39.3
$\phi 6$	1/8	10-KQ2VD06-01NS	14	10.4	13.4	20.5	16.3	39	35.9	13.3	13.4	5.9	4.5	20.3
	1/4	10-KQ2VD06-02NS	14	10.4	13.4	20.5	20.7	43.4	38.7	13.3	13.4	5.9	4.5	28
	3/8	10-KQ2VD06-03NS	17	10.4	13.4	20.5	22.1	44.8	39.7	13.3	13.4	5.9	4.5	39.9
$\phi 8$	1/8	10-KQ2VD08-01NS	19	13.2	17.6	23.7	19	45.8	42.7	14.2	15.9	11.2	6	45.1
	1/4	10-KQ2VD08-02NS	19	13.2	17.6	23.7	22.4	49.2	44.5	14.2	15.9	11.2	6	44.3
	3/8	10-KQ2VD08-03NS	19	13.2	17.6	23.7	23	49.8	44.7	14.2	15.9	11.2	6	52.3
$\phi 10$	1/2	10-KQ2VD10-04NS	22	13.2	17.6	23.7	27.2	54	47.6	14.2	15.9	11.2	6	78.4
	1/4	10-KQ2VD10-02NS	21	15.9	20.6	25.7	24.3	56.2	51.5	15.6	19.2	20.3	7.5	65.1
	3/8	10-KQ2VD10-03NS	21	15.9	20.6	25.7	24.7	56.6	51.5	15.6	19.2	20.3	7.5	65.1
$\phi 12$	1/2	10-KQ2VD12-04NS	26	18.5	25.2	28.9	28.7	60	53.6	15.6	19.2	20.3	7.5	87
	1/4	10-KQ2VD12-02NS	26	18.5	25.2	28.9	26.5	62.4	57.7	17	21.6	30.8	9	107
	3/8	10-KQ2VD12-03NS	26	18.5	25.2	28.9	26.9	62.8	57.7	17	21.6	30.8	9	102.1
1/2	10-KQ2VD12-04NS	26	18.5	25.2	28.9	30.1	66	59.6	17	21.6	30.8	9	116.1	

* Reference dimensions after installation of R thread
Note) ϕD_1 is maximum diameter.

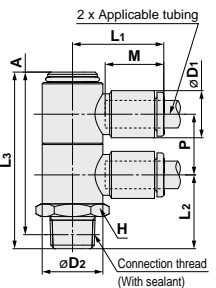

Air Grippers
Air Preparation Equipment
Modular F. R.
Pressure Control Equipment

Fittings & Tubing
Flow Control Equipment
Pressure Switches/ Pressure Sensors

Dimensions

Branch Universal Male Elbow: 10-KQ2Z (Gasket seal)



Applicable tubing O.D. (mm)	Connection thread M	Model	H (Width across flats)	Note) ϕD_1	ϕD_2	L1	L2	L3	A	M	P	Effective area (mm ²) Urethane	Min. port size	Weight (g)
$\phi 4$	M5 x 0.8	10-KQ2Z04-M5N	8	8.2	9.8	16.5	10.9	18.4	14.9	13.3	8.2	3.4	2.5	6.2

Note) ϕD_1 is maximum diameter.

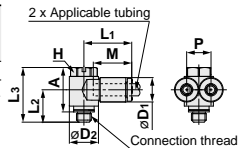

Branch Universal Male Elbow: 10-KQ2Z (Sealant)



Applicable tubing O.D. (mm)	Connection thread R	Model	H (Width across flats)	Note) ϕD_1	ϕD_2	L1	L2	L3	A*	M	P	Effective area (mm ²) Urethane	Min. port size	Weight (g)	
$\phi 4$	1/8	10-KQ2Z04-01NS	8	8.2	13.4	18.5	13.7	25.6	22.5	13.3	8.2	4.7	3	14	
	1/8	10-KQ2Z06-01NS	8	10.4	13.4	18.4	13.7	25.6	22.5	13.3	10.4	8.6	4.5	14.6	
$\phi 6$	1/4	10-KQ2Z06-02NS	14	10.4	20.6	21.5	19.1	34.9	30.2	13.3	10.4	8.6	4.5	37	
	3/8	10-KQ2Z06-03NS	14	10.4	20.6	21.5	19.5	35.3	30.2	13.3	10.4	8.6	4.5	44.6	
$\phi 8$	1/2	10-KQ2Z08-01NS	12	13.2	17.6	21.2	15.1	27.6	24.5	14.2	13.2	14.2	6	24.3	
	1/4	10-KQ2Z08-02NS	12	13.2	17.6	21.2	18.5	31	26.3	14.2	13.2	14.2	6	30.8	
$\phi 10$	3/8	10-KQ2Z08-03NS	14	13.2	20.6	22.3	19.5	35.3	30.2	14.2	13.2	14.2	6	46.3	
	1/4	10-KQ2Z10-02NS	14	15.9	21.6	23.6	19.9	34.9	30.2	15.6	15.9	22.6	7.5	41.7	
$\phi 12$	3/8	10-KQ2Z10-03NS	14	15.9	21.6	23.6	20.3	35.3	30.2	15.6	15.9	22.6	7.5	49.3	
	1/2	10-KQ2Z12-04NS	17	18.5	24.1	26.9	21.2	37.6	32.5	17	18.5	35.3	9	63.4	
					18.5	24.1	26.9	24.4	40.8	34.4	17	18.5	35.3	9	82

* Reference dimensions after installation of R thread
Note) ϕD_1 is maximum diameter.

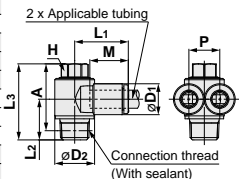

Branch Universal Female Elbow: 10-KQ2ZF (Gasket seal)



Applicable tubing O.D. (mm)	Connection thread M	Model	H (Width across flats)	Note) ϕD_1	ϕD_2	L1	L2	L3	A	M	P	Effective area (mm ²) Urethane	Min. port size	Weight (g)
$\phi 4$	M5 x 0.8	10-KQ2ZF04-M5N	8	8.2	9.8	16.5	10.2	19.2	16.2	13.3	8.2	3.4	2.5	6.3

Note) ϕD_1 is maximum diameter.

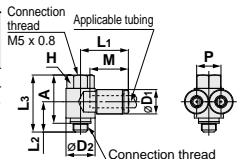

Branch Universal Female Elbow: 10-KQ2ZF (Sealant)



Applicable tubing O.D. (mm)	Connection thread R, Rc	Model	H (Width across flats)	Note) ϕD_1	ϕD_2	L1	L2	L3	A*	M	P	Effective area (mm ²) Urethane	Min. port size	Weight (g)
$\phi 4$	1/8	10-KQ2ZF04-01NS	14	8.2	13.4	18.5	14.4	28.5	25.4	13.3	8.2	4.7	3	18.1
	1/8	10-KQ2ZF06-01NS	14	10.4	13.4	18.4	14.4	28.5	25.4	13.3	10.4	8.6	4.5	18.7
$\phi 6$	1/4	10-KQ2ZF06-02NS	19	10.4	20.6	21.5	21.2	40.3	35.6	13.3	10.4	8.6	4.5	45.3
	3/8	10-KQ2ZF06-03NS	19	10.4	20.6	21.5	21.2	40.3	35.6	13.3	10.4	8.6	4.5	45.3
$\phi 8$	1/2	10-KQ2ZF08-01NS	17	13.2	17.6	21.2	15.5	30	26.9	14.2	13.2	14.2	6	29.3
	1/4	10-KQ2ZF08-02NS	19	13.2	20.6	22.3	21.2	40.3	35.6	14.2	13.2	14.2	6	47
$\phi 10$	3/8	10-KQ2ZF10-02NS	19	15.9	21.6	23.6	20.4	40.3	35.6	15.6	15.9	22.6	7.5	49.9
	1/2	10-KQ2ZF10-03NS	22	15.9	25.2	25.5	23.2	44	38.9	15.6	15.9	22.6	7.5	68.4
$\phi 12$	3/8	10-KQ2ZF12-03NS	22	18.5	24.1	26.9	22.7	44	38.9	17	18.5	35.3	9	71
	1/2	10-KQ2ZF12-04NS	24	18.5	27	29.9	24.4	48.9	42.5	17	18.5	35.3	9	100.5

* Reference dimensions after installation of R thread
Note) ϕD_1 is maximum diameter.

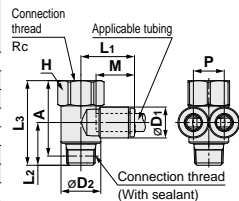

Dimensions

Double Branch Universal Male Elbow: 10-KQZ2D (Sealant)



Applicable tubing O.D. (mm)	Connection thread R	Model	H (Width across flats)	Note) ϕD_1	ϕD_2	L ₁	L ₂	L ₃	A*	M	P ₁	P ₂	Effective area (mm ²) Urethane	Min. port size	Weight (g)														
$\phi 4$	1/8	10-KQZ2D04-01NS	14	8.2	13.4	18.5	16.3	39	35.9	13.3	13.4	8.2	4.7	3	21.3														
	1/4	10-KQZ2D04-02NS	14	8.2	13.4	18.5	20.7	43.4	38.7	13.3	13.4	8.2	4.7	3	29														
	3/8	10-KQZ2D04-03NS	17	8.2	13.4	18.5	22.1	44.8	39.7	13.3	13.4	8.2	4.7	3	40.9														
$\phi 6$	1/8	10-KQZ2D06-01NS	14	10.4	13.4	18.4	16.3	39	35.9	13.3	13.4	10.4	8.6	4.5	22.5														
	1/4	10-KQZ2D06-02NS	14	10.4	13.4	18.4	20.7	43.4	38.7	13.3	13.4	10.4	8.6	4.5	30.2														
	3/8	10-KQZ2D06-03NS	17	10.4	13.4	18.4	22.1	44.8	39.7	13.3	13.4	10.4	8.6	4.5	42.1														
$\phi 8$	1/8	10-KQZ2D08-01NS	19	13.2	17.6	21.2	19	45.8	42.7	14.2	15.9	13.2	14.2	6	48.7														
	1/4	10-KQZ2D08-02NS	19	13.2	17.6	21.2	22.4	49.2	44.5	14.2	15.9	13.2	14.2	6	48														
	3/8	10-KQZ2D08-03NS	19	13.2	17.6	21.2	23	49.8	44.7	14.2	15.9	13.2	14.2	6	55.9														
$\phi 10$	1/2	10-KQZ2D10-02NS	22	13.2	17.6	21.2	27.2	54	47.6	14.2	15.9	13.2	14.2	6	82.1														
	3/4	10-KQZ2D10-02NS	21	15.9	20.6	23.6	24.3	56.2	51.5	15.6	19.2	15.9	21.6	7.5	69														
	1/4	10-KQZ2D10-03NS	21	15.9	20.6	23.6	24.7	56.6	51.5	15.6	19.2	15.9	21.6	7.5	71														
$\phi 12$	1/2	10-KQZ2D10-04NS	22	15.9	20.6	23.6	28.7	60	53.6	15.6	19.2	15.9	21.6	7.5	92.9														
	3/8	10-KQZ2D12-02NS	26	18.5	25.2	26.8	26.5	62.4	57.7	17	21.6	18.5	35.3	9	115.6														
	1/2	10-KQZ2D12-03NS	26	18.5	25.2	26.8	26.9	62.8	57.7	17	21.6	18.5	35.3	9	110.7														
															1/2	10-KQZ2D12-04NS	26	18.5	25.2	26.8	30.1	66	59.6	17	21.6	18.5	35.3	9	124.7

* Reference dimensions after installation of R thread
Note) ϕD_1 is maximum diameter.

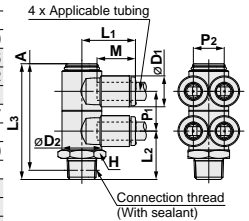

Triple Branch Universal Male Elbow: 10-KQZ2T (Sealant)



Applicable tubing O.D. (mm)	Connection thread R	Model	H (Width across flats)	Note) ϕD_1	ϕD_2	L ₁	L ₂	L ₃	A*	M	P ₁	P ₂	Effective area (mm ²) Urethane	Min. port size	Weight (g)
$\phi 4$	1/8	10-KQZ2T04-01NS	14	8.2	13.4	18.5	16.3	52.5	49.4	13.3	13.4	8.2	4.7	3	27.7
	1/4	10-KQZ2T04-02NS	14	8.2	13.4	18.5	20.7	56.9	52.2	13.3	13.4	8.2	4.7	3	35.3
	3/8	10-KQZ2T04-03NS	17	8.2	13.4	18.5	22.1	58.3	53.2	13.3	13.4	8.2	4.7	3	47.2
$\phi 6$	1/8	10-KQZ2T06-01NS	14	10.4	13.4	18.4	16.3	52.5	49.4	13.3	13.4	10.4	8.6	4.5	29.5
	1/4	10-KQZ2T06-02NS	14	10.4	13.4	18.4	20.7	56.9	52.2	13.3	13.4	10.4	8.6	4.5	37.2
	3/8	10-KQZ2T06-03NS	17	10.4	13.4	18.4	22.1	58.3	53.2	13.3	13.4	10.4	8.6	4.5	49.1
$\phi 8$	1/8	10-KQZ2T08-01NS	19	13.2	17.6	21.2	19	61.8	58.7	14.2	15.9	13.2	14.2	6	65.1
	1/4	10-KQZ2T08-02NS	19	13.2	17.6	21.2	22.4	65.2	60.5	14.2	15.9	13.2	14.2	6	62.3
	3/8	10-KQZ2T08-03NS	19	13.2	17.6	21.2	23	65.8	60.7	14.2	15.9	13.2	14.2	6	70.4
$\phi 10$	1/2	10-KQZ2T10-04NS	22	13.2	17.6	21.2	27.2	70	63.6	14.2	15.9	13.2	14.2	6	97
	3/4	10-KQZ2T10-02NS	21	15.9	20.6	23.6	24.3	75.5	70.8	15.6	19.2	15.9	21.6	7.5	90.9
	1/2	10-KQZ2T10-03NS	21	15.9	20.6	23.6	24.7	75.9	70.8	15.6	19.2	15.9	21.6	7.5	90.7
$\phi 12$	3/8	10-KQZ2T12-02NS	26	18.5	25.2	26.8	26.5	84.1	79.4	17	21.6	18.5	35.3	9	152.2
	1/2	10-KQZ2T12-03NS	26	18.5	25.2	26.8	26.9	84.5	79.4	17	21.6	18.5	35.3	9	142.6
	1/2	10-KQZ2T12-04NS	26	18.5	25.2	26.8	30.1	87.7	81.3	17	21.6	18.5	35.3	9	155.1

* Reference dimensions after installation of R thread
Note) ϕD_1 is maximum diameter.

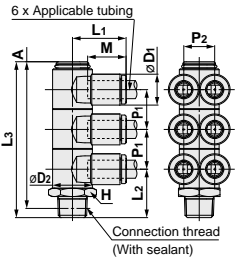

Directional Control Valves

Air Cylinders

Rotary Actuators

Air Grippers

Air Preparation Equipment

Modular F. R.

Pressure Control Equipment

Fittings & Tubing

Flow Control Equipment

Pressure Switches/ Pressure Sensors

Dimensions

Female Elbow: 10-KQ2LF



Applicable tubing O.D. (mm)	Connection thread M, Rc	Model	H (Width across flats)	Note) ϕD_1	ϕD_2	L ₁	L ₂	M	Effective area (mm ²) Urethane	Min. port size	Weight (g)
$\phi 4$	M5 x 0.8	10-KQ2LF04-M5N	8	8.2	7	15.4	15.3	13.3	3.5	2.5	4.7
	M6 x 1.0	10-KQ2LF04-M6N	8	8.2	7	15.4	16.1	13.3	3.5	2.5	4.6
	1/8	10-KQ2LF04-01N	14	8.2	10	14.8	22.4	13.3	4.2	3	17.6
$\phi 6$	1/4	10-KQ2LF04-02N	17	8.2	10	14.8	26.9	13.3	4.2	3	29.6
	M5 x 0.8	10-KQ2LF06-M5N	8	10.4	7	14.5	17	13.3	3.5	2.5	4.8
	M6 x 1.0	10-KQ2LF06-M6N	8	10.4	7	14.5	17.8	13.3	3.5	2.5	4.7
$\phi 8$	1/8	10-KQ2LF06-01N	14	10.4	10	15.5	23.5	13.3	9	4.5	18
	1/4	10-KQ2LF06-02N	17	10.4	10	15.5	28	13.3	9	4.5	30.1
	3/8	10-KQ2LF06-03N	19	10.4	10	15.5	28.5	13.3	9	4.5	34
$\phi 10$	1/8	10-KQ2LF08-01N	14	13.2	10	16.4	24.9	14.2	11.4	4.5	18.8
	1/4	10-KQ2LF08-02N	17	13.2	12	17.2	28.8	14.2	14.9	6	28.7
	3/8	10-KQ2LF08-03N	19	13.2	12	17.2	29.3	14.2	14.9	6	32.3
$\phi 12$	1/4	10-KQ2LF10-02N	17	15.9	17	19.3	27.4	15.6	14.9	7.5	26.4
	3/8	10-KQ2LF10-03N	19	15.9	17	19.3	33.5	15.6	25	7.5	31
	1/2	10-KQ2LF10-04N	24	15.9	17	19.3	36.5	15.6	25	7.5	57.6
$\phi 12$	1/4	10-KQ2LF12-02N	17	18.5	17	21.5	28.7	17	39.7	9	28.2
	3/8	10-KQ2LF12-03N	19	18.5	17	21.5	34.8	17	39.7	9	32.9
	1/2	10-KQ2LF12-04N	24	18.5	17	21.5	37.8	17	39.7	9	59.5

Note) ϕD_1 is maximum diameter.

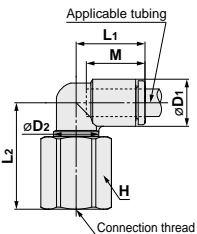

Extended Plug-in Elbow: 10-KQ2W



Applicable tubing O.D. (mm)	Applicable fitting size ϕd	Model	Note) ϕD_1	ϕD_2	L ₁	L ₂	A	M	Effective area (mm ²) Urethane	Min. port size	Weight (g)
$\phi 3.2$	$\phi 3.2$	10-KQ2W23-99A	7.1	6.4	14.4	30.5	20.8	13.3	2.5	2.5	1
$\phi 4$	$\phi 4$	10-KQ2W04-99A	8.2	7.2	14.5	31.8	22.6	13.3	4.2	3	1.3
$\phi 6$	$\phi 6$	10-KQ2W06-99A	10.4	8	15.3	35.2	27.1	13.3	9	4	2
$\phi 8$	$\phi 8$	10-KQ2W08-99A	13.2	10	17.2	41.9	34.3	14.2	14.9	6	3.5
$\phi 10$	$\phi 10$	10-KQ2W10-99A	15.9	12	19.3	46.6	38.9	15.6	25	7.5	5.5
$\phi 12$	$\phi 12$	10-KQ2W12-99A	18.5	14	21.5	52	44.2	17	39.7	9	8.4

Note) ϕD_1 is maximum diameter.

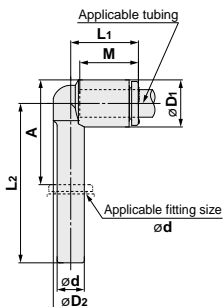

Dimensions

Extended Male Elbow: 10-KQ2W (Gasket seal)



Applicable tubing O.D. (mm)	Connection thread M	Model	H (Width across flats)	Note) ϕD_1	ϕD_2	L ₁	L ₂	A	M	Effective area (mm ²) Urethane	Min. port size	Weight (g)
$\phi 2$	M3 x 0.5	10-KQ2W02-M3G	5.5	5.8	5.5	12.6	18.8	19.1	11.9	0.8	1.2	2.6
	M5 x 0.8	10-KQ2W02-M5N	7	5.8	5.5	12.6	19.3	19.2	11.9	0.8	1.2	4.6
$\phi 3.2$	M3 x 0.5	10-KQ2W23-M3G	7	7.1	7	15.3	22.5	23.4	13.3	0.8	1.2	4.8
	M5 x 0.8	10-KQ2W23-M5N	7	7.1	7	15.3	25.2	25.7	13.3	2.4	2.5	5.8
$\phi 4$	M3 x 0.5	10-KQ2W04-M3G	7	8.2	7	15.4	23	24.5	13.3	0.8	1.2	4.9
	M5 x 0.8	10-KQ2W04-M5N	7	8.2	7	15.4	25.7	26.8	13.3	3	2.5	5.8
$\phi 6$	M5 x 0.8	10-KQ2W06-M5N	7	10.4	7	14.5	27.4	29.6	13.3	3	2.5	5.9

(Note) ϕD_1 is maximum diameter.

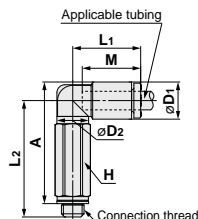

Extended Male Elbow: 10-KQ2W (Sealant)



Applicable tubing O.D. (mm)	Connection thread R	Model	H (Width across flats)	Note) ϕD_1	ϕD_2	L ₁	L ₂	A*	M	Effective area (mm ²) Urethane	Min. port size	Weight (g)
$\phi 3.2$	1/8	10-KQ2W23-01NS	10	7.1	10	14.5	30.3	30.8	13.3	2.4	2.5	10.8
	1/4	10-KQ2W23-02NS	14	7.1	10	14.5	32.8	31.7	13.3	2.4	2.5	27.3
$\phi 4$	1/8	10-KQ2W04-01NS	10	8.2	10	14.8	29.9	30.9	13.3	4	3	11
	1/4	10-KQ2W04-02NS	14	8.2	10	14.8	33.3	32.7	13.3	4	3	27.5
$\phi 6$	1/8	10-KQ2W06-01NS	10	10.4	10	15.5	31	33.1	13.3	8.6	4.5	11.4
	1/4	10-KQ2W06-02NS	14	10.4	10	15.5	34.4	34.9	13.3	8.6	4.5	28
	3/8	10-KQ2W06-03NS	17	10.4	10	15.5	35.7	35.8	13.3	8.6	4.5	47.4
$\phi 8$	1/8	10-KQ2W08-01NS	10	13.2	10	16.4	32.4	35.9	14.2	10.9	4.5	12.2
	1/4	10-KQ2W08-02NS	14	13.2	12	17.2	39.1	41	14.2	14.2	6	40
$\phi 10$	3/8	10-KQ2W08-03NS	17	13.2	12	17.2	39.2	40.7	14.2	14.2	6	47
	1/4	10-KQ2W10-02NS	17	15.9	17	19.3	52.9	56.2	15.6	23.8	7.5	59
	3/8	10-KQ2W10-03NS	17	15.9	17	19.3	48.5	51.4	15.6	23.8	7.5	51.3
$\phi 12$	1/2	10-KQ2W10-04NS	22	15.9	17	19.3	52.5	54.1	15.6	23.8	7.5	92
	1/4	10-KQ2W12-02NS	17	18.5	17	21.5	54.2	58.8	17	37.7	9	60.7
$\phi 16$	3/8	10-KQ2W12-03NS	17	18.5	17	21.5	49.8	54	17	37.7	9	53.2
	1/2	10-KQ2W12-04NS	22	18.5	17	21.5	53.8	56.7	17	37.7	9	93.9
	Now 1/4	10-KQ2W16-02NS	17	23.8	21	25.1	59	66.2	20.6	47.7	9	67.4
$\phi 16$	3/8	10-KQ2W16-03NS	22	23.8	21	27.1	59.7	66.5	20.6	58.9	11	105.5
	1/2	10-KQ2W16-04NS	22	23.8	21	27.1	58.4	63.9	20.6	58.9	13	101.7

* Reference dimensions after installation of R thread
Note) ϕD_1 is maximum diameter.

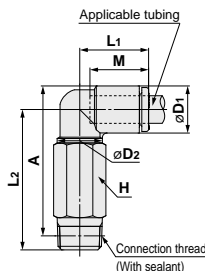

Directional Control Valves
Air Cylinders
Rotary Actuators
Air Grippers
Air Preparation Equipment
Modular F. R.
Pressure Control Equipment
Fittings & Tubing
Flow Control Equipment
Pressure Switches/ Pressure Sensors

Dimensions

Male Branch Tee: 10-KQ2T (Gasket seal)



Applicable tubing O.D. (mm)	Connection thread M	Model	H (Width across flats)	Note) ϕD_1	ϕD_2	L ₁	L ₂	A	M	Effective area (mm ²) Urethane	Min. port size	Weight (g)
$\phi 3.2$	M3 x 0.5 M5 x 0.8	10-KQ2T23-M3G 10-KQ2T23-M5N	7 7	7.1 7.1	7 7	15.3 15.3	13.8 14.3	14.7 14.8	13.3 13.3	0.9 2.7	1.2 2.5	3.1 3.5
	M3 x 0.5 M5 x 0.8	10-KQ2T04-M3G 10-KQ2T04-M5N	7 7	8.2 8.2	7 7	15.4 15.4	14.3 14.8	15.8 15.9	13.3 13.3	0.9 4.5	1.2 2.5	3.4 4.9
$\phi 4$	M3 x 0.5 M5 x 0.8	10-KQ2T04-M3G 10-KQ2T04-M5N	7 7	8.2 8.2	7 7	15.4 15.4	14.3 14.8	15.8 15.9	13.3 13.3	0.9 4.5	1.2 2.5	3.4 4.9
	M6 x 1.0 M6 x 1.0	10-KQ2T04-M6N 10-KQ2T06-M6N	8 8	8.2 10.4	7 7	15.4 14.5	15.8 16.5	15.9 18.7	13.3 13.3	4.5 4.5	2.5 2.5	4.9 5.4
$\phi 6$	M5 x 0.8 M6 x 1.0	10-KQ2T06-M5N 10-KQ2T06-M6N	7 8	10.4 10.4	7 7	14.5 17.5	16.5 18.7	18.7 18.7	13.3 13.3	4.5 4.5	2.5 2.5	5.4 5.4

Note) ϕD_1 is maximum diameter.

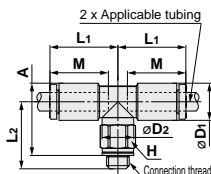

Male Branch Tee: 10-KQ2T (Sealant)



Applicable tubing O.D. (mm)	Connection thread R	Model	H (Width across flats)	Note) ϕD_1	ϕD_2	L ₁	L ₂	A*	M	Effective area (mm ²) Urethane	Min. port size	Weight (g)
$\phi 4$	1/8 1/4	10-KQ2T04-01NS 10-KQ2T04-02NS	10 14	8.2 8.2	10 10	14.8 14.8	16.2 21.1	17.2 21.1	13.3 13.3	4.1 4.1	3 3	5.5 15
	1/8 1/4	10-KQ2T06-01NS 10-KQ2T06-02NS	10 14	10.4 10.4	10 10	15.5 15.5	17.3 22.8	19.4 23.3	13.3 13.3	11 11	4.5 4.5	6.1 15.6
$\phi 6$	3/8 1/2	10-KQ2T06-03NS 10-KQ2T06-04NS	14 17	10.4 13.2	10 10	15.5 16.4	24.1 22.2	24.2 14.2	13.3 14	11 14	4.5 4.5	27.4 7.9
	1/4 3/8	10-KQ2T08-02NS 10-KQ2T08-03NS	14 17	13.2 15.9	12 12	17.2 17.2	25.4 25.5	27.3 27	14.2 14.2	18.2 18.2	6 6	19.4 26.5
$\phi 8$	1/8 1/4	10-KQ2T10-01NS 10-KQ2T10-02NS	12 14	15.9 13.2	12 12	18.6 18.6	23.5 28.4	28.4 15.6	15.6 15.6	14.9 6	13.9 6	13.9 19.4
	3/8 1/2	10-KQ2T10-03NS 10-KQ2T10-04NS	17 22	15.9 15.9	17 17	19.3 19.3	29.5 33.5	32.4 35.1	15.6 15.6	25 25	7.5 7.5	24.8 47.3
$\phi 10$	1/4 3/8	10-KQ2T12-02NS 10-KQ2T12-03NS	17 17	18.5 18.5	17 17	21.5 21.5	29.9 30.8	34.5 35	17 17	45.2 45.2	9 9	27.3 28
	1/2 3/8	10-KQ2T12-04NS 10-KQ2T16-02NS	22 17	18.5 23.8	17 17	21.5 25.1	34.8 32.6	37.7 39.8	17 20.6	45.2 57.2	9 9	50.4 35.5
$\phi 12$	1/4 3/8	10-KQ2T12-02NS 10-KQ2T12-03NS	17 17	18.5 18.5	17 17	21.5 21.5	30.8 30.8	35 35	17 17	45.2 45.2	9 9	27.3 28
	1/2 3/8	10-KQ2T12-04NS 10-KQ2T16-03NS	22 22	18.5 23.8	17 21	21.5 27.1	34.8 35.4	37.7 42.2	17 20.6	45.2 58.9	9 11	50.4 47.7
$\phi 16$	1/2	10-KQ2T16-04NS	22	23.8	21	27.1	34.1	39.6	20.6	58.9	13	51.4

* Reference dimensions after installation of R thread
Note) ϕD_1 is maximum diameter.

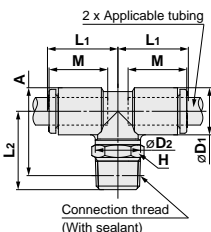

Dimensions

Union Tee: 10-KQ2T



Applicable tubing O.D. (mm)	Model	Note) ϕD	L_1	L_2	M	Q	ϕO	ϕN	Effective area (mm ²) Urethane	Min. port size	Weight (g)
$\phi 3.2$	10-KQ2T23-00A	7.1	14.9	18.5	13.3	5.4	6	3.2	2.9	2.5	2.3
$\phi 4$	10-KQ2T04-00A	8.2	15.3	19.4	13.3	5.7	6	3.2	4.4	3	2.8
$\phi 6$	10-KQ2T06-00A	10.4	16.3	21.5	13.3	6.8	6	3.2	10.6	4.5	3.8
$\phi 8$	10-KQ2T08-00A	13.2	18.2	24.8	14.2	8.4	8	4.2	17.7	6	7
$\phi 10$	10-KQ2T10-00A	15.9	20.6	28.6	15.6	9.6	8	4.2	28.4	7.5	11
$\phi 12$	10-KQ2T12-00A	18.5	23	32.3	17	10.7	8	4.2	45.4	9	15.7
$\phi 16$	10-KQ2T16-00A	23.8	28.6	40.5	20.6	13.4	8	4.2	58.9	13	29.8

Note) ϕD is maximum diameter.

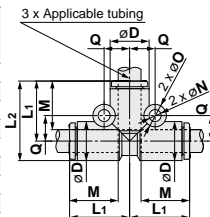

Directional Control Valves
Air Cylinders

Different Diameter Tee: 10-KQ2T



Applicable tubing O.D. (mm)		Model	Note) ϕD_1	ϕD_2	L_1	L_2	L_3	M_1	M_2	Q_1	Q_2	ϕO	ϕN	Effective area (mm ²) Urethane	Min. port size	Weight (g)
a	b															
$\phi 3.2$	$\phi 4$	10-KQ2T23-04A	8.2	7.1	14.9	15.3	18.5	13.3	13.3	5.4	5.8	6	3.2	3.5	2.5	2.6
$\phi 4$	$\phi 6$	10-KQ2T04-06A	10.4	8.2	15.3	16.3	19.4	13.3	13.3	5.7	6.8	6	3.2	6.6	3	3.3
$\phi 6$	$\phi 8$	10-KQ2T06-08A	13.2	10.4	17.2	17.3	22.4	14.2	13.3	7.3	8.4	8	4.2	16.4	4.5	5.3
$\phi 8$	$\phi 10$	10-KQ2T08-10A	15.9	13.2	19.6	19.2	26.2	15.6	14.2	8.4	9.6	8	4.2	27.2	6	8.3
$\phi 10$	$\phi 12$	10-KQ2T10-12A	18.5	15.9	22	21.6	30	17	15.6	9.6	10.7	8	4.2	44.5	7.5	12.2
$\phi 12$	$\phi 16$	10-KQ2T12-16A	23.8	18.5	26.6	25	35.9	20.6	17	10.7	13.4	8	4.2	74	9	20.1

Note) ϕD_1 is maximum diameter.

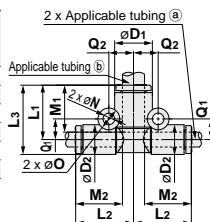

Rotary Actuators
Air Grippers
Air Preparation Equipment

Different Diameter Tee: 10-KQ2T



Applicable tubing O.D. (mm)		Model	Note) ϕD_1	ϕD_2	L_1	L_2	L_3	M_1	M_2	Q_1	Q_2	ϕO	ϕN	Effective area (mm ²) Urethane	Min. port size	Weight (g)
a	b															
$\phi 6$	$\phi 4$	10-KQ2T06-04A	8.2	10.4	16.3	15.3	21.5	13.3	13.3	6.8	5.7	6	3.2	4.4	3	3.5
$\phi 8$	$\phi 6$	10-KQ2T08-06A	10.4	13.2	17.3	17.2	23.9	13.3	14.2	8.4	7.3	8	4.2	10.6	4.5	6
$\phi 10$	$\phi 8$	10-KQ2T10-08A	13.2	15.9	19.2	19.6	27.2	14.2	15.6	9.6	8.4	8	4.2	17.7	6	9.5
$\phi 12$	$\phi 10$	10-KQ2T12-10A	15.9	18.5	21.6	22	30.9	15.6	17	10.7	9.6	8	4.2	28.4	7.5	13.4

Note) ϕD_1 is maximum diameter.

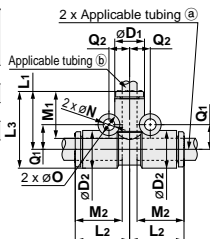

Modular F. R.
Pressure Control Equipment

Fittings & Tubing
Flow Control Equipment
Pressure Switches/ Pressure Sensors

Dimensions

Cross: 10-KQ2TW



Applicable tubing O.D. (mm)	Model	Note) ϕD	L	Q	M	ϕO	ϕN	Effective area (mm ²)	Min. port size	Weight (g)
								Urethane		
$\phi 4$	10-KQ2TW04-00A	8.2	15.3	5.7	13.3	6	3.2	4.4	3	3.5
$\phi 6$	10-KQ2TW06-00A	10.4	16.3	6.8	13.3	6	3.2	10.6	4.5	4.9
$\phi 8$	10-KQ2TW08-00A	13.2	18.2	8.4	14.2	8	4.2	17.7	6	8.5
$\phi 10$	10-KQ2TW10-00A	15.9	20.6	9.6	15.6	8	4.2	28.4	7.5	12.7
$\phi 12$	10-KQ2TW12-00A	18.5	23	10.7	17	8	4.2	45.4	9	18.4

Note) ϕD is maximum diameter.

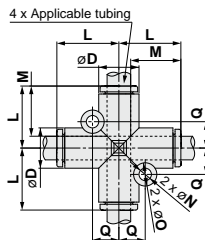

Different Diameter Cross: 10-KQ2TX



Applicable tubing O.D. (mm)		Model	Note) ϕD_1	Note) ϕD_2	L ₁	L ₂	Q	M ₁	M ₂	ϕO	ϕN	Effective area (mm ²) Urethane	Min. port size	Weight (g)
(a)	(b)													
$\phi 6$	$\phi 8$	10-KQ2TX06-08A	10.4	13.2	17.2	17.3	8.4	13.3	14.2	8	4.2	10.6	4.5	7.1
$\phi 8$	$\phi 10$	10-KQ2TX08-10A	13.2	15.9	19.6	19.2	9.6	14.2	15.6	8	4.2	17.7	6	10.9
$\phi 10$	$\phi 12$	10-KQ2TX10-12A	15.9	18.5	22	21.6	10.7	15.6	17	8	4.2	28.4	7.5	15.9

Note) ϕD_1 , ϕD_2 are maximum diameters.

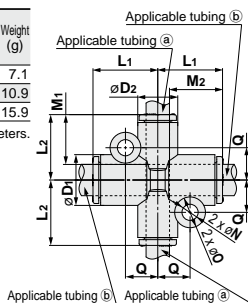

Different Diameter Cross: 10-KQ2TY



Applicable tubing O.D. (mm)		Model	Note) ϕD_1	Note) ϕD_2	L ₁	L ₂	Q	M ₁	M ₂	ϕO	ϕN	Effective area (mm ²) Urethane	Min. port size	Weight (g)
(a)	(b)													
$\phi 6$	$\phi 8$	10-KQ2TY06-08A	10.4	13.2	17.3	17.2	8.4	13.3	14.2	8	4.2	10.6	4.5	6.5
$\phi 8$	$\phi 10$	10-KQ2TY08-10A	13.2	15.9	19.2	19.6	9.6	14.2	15.6	8	4.2	17.7	6	10.2
$\phi 10$	$\phi 12$	10-KQ2TY10-12A	15.9	18.5	21.6	22	10.7	15.6	17	8	4.2	28.4	7.5	14.9

Note) ϕD_1 , ϕD_2 are maximum diameters.

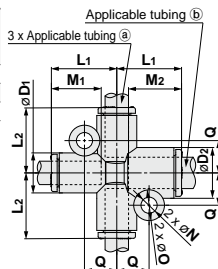

Dimensions

Male Run Tee: 10-KQ2Y (Gasket seal)



Applicable tubing O.D. (mm)	Connection thread M	Model	H (Width across flats)	Note) ϕD_1	ϕD_2	L ₁	L ₂	L ₃	A	M	Effective area (mm ²) Urethane	Min. port size	Weight (g)
$\phi 2$	M3 x 0.5	10-KQ2Y02-M3G	5.5	5.8	5.5	12.9	12.5	12.9	22.8	11.9	0.9	1.2	2
	M5 x 0.8	10-KQ2Y02-M5N	7	5.8	5.5	12.9	13	12.9	22.9	11.9	0.9	1.4	3.1
$\phi 3.2$	M3 x 0.5	10-KQ2Y23-M3G	7	7.1	7	15.3	13.8	15.3	26.5	13.3	0.9	1.2	3.1
	M5 x 0.8	10-KQ2Y23-M5N	7	7.1	7	15.3	14.3	15.3	26.6	13.3	2.7	2.5	3.5
$\phi 4$	M3 x 0.5	10-KQ2Y04-M3G	7	8.2	7	15.4	14.3	15.4	27.1	13.3	0.9	1.2	3.4
	M5 x 0.8	10-KQ2Y04-M5N	7	8.2	7	15.4	14.8	15.4	27.2	13.3	4.5	2.5	3.9
$\phi 6$	M6 x 1.0	10-KQ2Y04-M6N	8	8.2	7	15.4	15.8	15.4	27.2	13.3	4.5	2.5	4.6
	M5 x 0.8	10-KQ2Y06-M5N	7	10.4	7	16.3	16.5	16.3	29.8	13.3	4.5	2.5	4.9
	M6 x 1.0	10-KQ2Y06-M6N	8	10.4	7	16.3	17.5	16.3	29.8	13.3	4.5	2.5	5.7

Note) ϕD_1 is maximum diameter.

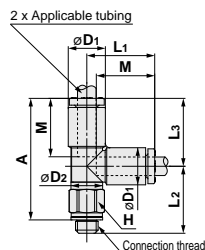

Male Run Tee: 10-KQ2Y (Sealant)



Applicable tubing O.D. (mm)	Connection thread R	Model	H (Width across flats)	Note) ϕD_1	ϕD_2	L ₁	L ₂	L ₃	A*	M	Effective area (mm ²) Urethane	Min. port size	Weight (g)
$\phi 3.2$	1/8	10-KQ2Y23-01NS	10	7.1	10	14.9	16.6	14.9	28.5	13.3	2.9	2.5	5.3
	1/4	10-KQ2Y23-02NS	14	7.1	10	14.9	21.1	14.9	31.4	13.3	2.9	2.5	14.7
$\phi 4$	1/8	10-KQ2Y04-01NS	10	8.2	10	15.3	16.2	15.3	28.4	13.3	4.4	3	5.6
	1/4	10-KQ2Y04-02NS	14	8.2	10	15.3	21.7	15.3	32.3	13.3	4.4	3	15
$\phi 6$	1/8	10-KQ2Y06-01NS	10	10.4	10	16.3	17.3	16.3	30.5	13.3	10.6	4.5	6.2
	1/4	10-KQ2Y06-02NS	14	10.4	10	16.3	22.8	16.3	34.4	13.3	10.6	4.5	15.8
$\phi 8$	3/8	10-KQ2Y06-03NS	17	10.4	10	16.3	24.1	16.3	35.3	13.3	10.6	4.5	27.5
	1/8	10-KQ2Y08-01NS	10	13.2	10	18.2	18.7	18.2	33.8	14.2	13.4	4.5	8
$\phi 10$	1/4	10-KQ2Y08-02NS	14	13.2	12	18.2	25.4	18.2	38.9	14.2	17.7	6	19.5
	3/8	10-KQ2Y08-03NS	17	13.2	12	18.2	25.5	18.2	38.6	14.2	17.7	6	26.5
$\phi 12$	1/8	10-KQ2Y10-01NS	12	15.9	12	20.6	23.5	20.6	41.1	15.6	28.4	6	14
	1/4	10-KQ2Y10-02NS	17	15.9	17	20.6	28.6	20.6	44.6	15.6	28.4	7.5	24.5
$\phi 16$	3/8	10-KQ2Y10-03NS	17	15.9	17	20.6	29.5	20.6	45.1	15.6	28.4	7.5	25
	1/2	10-KQ2Y10-04NS	22	15.9	17	20.6	33.5	20.6	47.8	15.6	28.4	7.5	47.4
$\phi 12$	1/4	10-KQ2Y12-02NS	17	18.5	17	23	29.9	23	48.3	17	45.4	9	27.6
	3/8	10-KQ2Y12-03NS	17	18.5	17	23	30.8	23	48.8	17	45.4	9	28.2
$\phi 16$	1/2	10-KQ2Y12-04NS	22	18.5	17	23	34.8	23	51.5	17	45.4	9	50.7
	New 1/4	10-KQ2Y16-02NS	17	23.8	17	28.6	32.6	28.6	56.5	20.6	45.4	9	36
$\phi 16$	3/8	10-KQ2Y16-03NS	22	23.8	21	28.6	35.4	28.6	58.9	20.6	60	11	48.3
	1/2	10-KQ2Y16-04NS	22	23.8	21	28.6	34.1	28.6	56.3	20.6	60	13	52

* Reference dimensions after installation of R thread Note) ϕD_1 is maximum diameter.

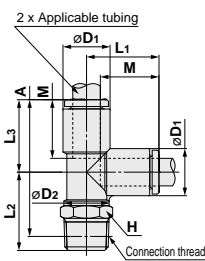

Directional Control Valves

Air Cylinders

Rotary Actuators

Air Grippers

Air Preparation Equipment

Modular F. R.

Pressure Control Equipment

Fittings & Tubing

Flow Control Equipment

Pressure Switches/ Pressure Sensors

Dimensions

Male Delta Union: 10-KQ2D (Gasket seal)



Applicable tubing O.D. (mm)	Connection thread M	Model	H (Width across flats)	Note) ϕD	L1	L2	A	M	Q	ϕO	ϕN	Effective area (mm ²) Urethane	Min. port size	Weight (g)
$\phi 4$	M5 x 0.8	10-KQ2D04-M5N	10	8.2	15.8	20.7	21.8	13.3	5.7	6	3.2	2.2	1.8	6.6
	M6 x 1.0	10-KQ2D04-M6N	10	8.2	15.8	21.7	21.8	13.3	5.7	6	3.2	4.3	3	6.4
$\phi 6$	M5 x 0.8	10-KQ2D06-M5N	12	10.4	16.8	21.7	23.9	13.3	6.7	6	3.2	4.3	1.8	9.8
	M6 x 1.0	10-KQ2D06-M6N	12	10.4	16.8	22.7	23.9	13.3	6.7	6	3.2	4.3	3	9.7

Note) ϕD is maximum diameter.

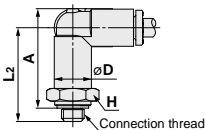
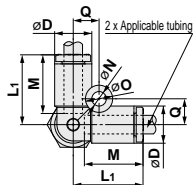

Male Delta Union: 10-KQ2D (Sealant)



Applicable tubing O.D. (mm)	Connection thread R	Model	H (Width across flats)	Note) ϕD	L1	L2	A*	M	Q	ϕO	ϕN	Effective area (mm ²) Urethane	Min. port size	Weight (g)
$\phi 4$	1/8	10-KQ2D04-01NS	10	8.2	15.8	23.3	24.3	13.3	5.7	6	3.2	6	3.6	9.2
	1/4	10-KQ2D04-02NS	14	8.2	15.8	27.7	27.1	13.3	5.7	6	3.2	6	3.6	19
$\phi 6$	1/8	10-KQ2D06-01NS	12	10.4	16.8	24.3	26.4	13.3	6.7	6	3.2	11	5.4	10.2
	1/4	10-KQ2D06-02NS	14	10.4	16.8	28.7	29.2	13.3	6.7	6	3.2	11	5.4	19.1
$\phi 8$	3/8	10-KQ2D08-03NS	17	10.4	16.8	30.1	30.2	13.3	6.7	6	3.2	11	5.4	31
	1/8	10-KQ2D08-01NS	14	13.2	18.8	26.3	29.8	14.2	8.4	8	4.2	18.2	6	15.3
$\phi 10$	1/4	10-KQ2D10-02NS	14	13.2	18.8	30.7	32.6	14.2	8.4	8	4.2	18.2	7.3	20.4
	3/8	10-KQ2D10-03NS	17	13.2	18.8	32.1	33.6	14.2	8.4	8	4.2	18.2	7.3	32.1
$\phi 12$	1/2	10-KQ2D12-04NS	22	15.9	21.2	33.1	36.3	15.6	9.6	8	4.2	29	9	24.9
	3/8	10-KQ2D10-03NS	17	15.9	21.2	34.5	37.3	15.6	9.6	8	4.2	29	9.4	32.7
$\phi 10$	1/2	10-KQ2D10-04NS	22	15.9	21.2	38.7	40.2	15.6	9.6	8	4.2	29	9.4	60.6
	1/4	10-KQ2D12-02NS	19	18.5	23.6	35.5	40	17	10.7	8	4.2	45.2	9	35
$\phi 12$	3/8	10-KQ2D12-03NS	19	18.5	23.6	36.9	41	17	10.7	8	4.2	45.2	11	38
	1/2	10-KQ2D12-04NS	22	18.5	23.6	41.1	43.9	17	10.7	8	4.2	45.2	11.6	60

* Reference dimensions after installation of R thread
Note) ϕD is maximum diameter.

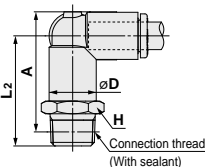
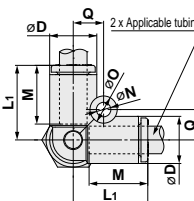

Dimensions

Branch "Y": 10-KQ2U (Gasket seal)



Applicable tubing O.D. (mm)	Connection thread M	Model	H (Width across flats)	Note) ϕD	L	A	M	P	Q	ϕO	ϕN	Effective area (mm ²) Urethane	Min. port size	Weight (g)
$\phi 3.2$	M5 x 0.8	10-KQ2U23-M5N	10	7.1	33.8	30.8	13.3	7.1	5.2	6	3.2	2.2	1.8	5.8
$\phi 4$	M5 x 0.8	10-KQ2U04-M5N	10	8.2	33.9	30.9	13.3	8.2	5.7	6	3.2	2.2	1.8	6.7
	M6 x 1.0	10-KQ2U04-M6N	10	8.2	34.9	30.9	13.3	8.2	5.7	6	3.2	2.2	3	6.6
$\phi 6$	M5 x 0.8	10-KQ2U06-M5N	12	10.4	35	32	13.3	10.4	6.8	6	3.2	2.2	1.8	10
	M6 x 1.0	10-KQ2U06-M6N	12	10.4	36	32	13.3	10.4	6.8	6	3.2	2.2	3	9.8

Note) ϕD is maximum diameter.

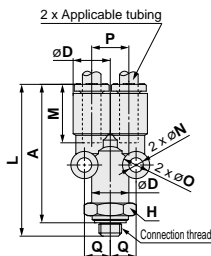

Directional Control Valves

Air Cylinders

Rotary Actuators

Branch "Y": 10-KQ2U (Sealant)



Applicable tubing O.D. (mm)	Connection thread R	Model	H (Width across flats)	Note) ϕD	L	A*	M	P	Q	ϕO	ϕN	Effective area (mm ²) Urethane	Min. port size	Weight (g)
$\phi 3.2$	1/8	10-KQ2U23-01NS	10	7.1	36.4	33.3	13.3	7.1	5.2	6	3.2	2.9	2.7	8.6
	1/4	10-KQ2U23-02NS	14	7.1	40.8	36.1	13.3	7.1	5.2	6	3.2	2.9	2.7	19
$\phi 4$	1/8	10-KQ2U04-01NS	10	8.2	36.5	33.4	13.3	8.2	5.7	6	3.2	4.2	3.6	9.3
	1/4	10-KQ2U04-02NS	14	8.2	40.9	36.2	13.3	8.2	5.7	6	3.2	4.2	3.6	19.1
$\phi 6$	1/8	10-KQ2U06-01NS	12	10.4	37.6	34.5	13.3	10.4	6.8	6	3.2	10.6	5.4	10.3
	1/4	10-KQ2U06-02NS	14	10.4	42	37.3	13.3	10.4	6.8	6	3.2	10.6	5.4	19.2
$\phi 8$	3/8	10-KQ2U06-03NS	17	10.4	43.4	38.3	13.3	10.4	6.8	6	3.2	10.6	5.4	31.2
	1/2	10-KQ2U08-01NS	14	13.2	40.7	37.6	14.2	13.2	8.7	8	4.2	17.7	6	15.8
$\phi 10$	1/4	10-KQ2U08-02NS	14	13.2	45.1	40.4	14.2	13.2	8.7	8	4.2	17.7	7.3	20.9
	3/8	10-KQ2U08-03NS	17	13.2	46.5	41.4	14.2	13.2	8.7	8	4.2	17.7	7.3	32.7
$\phi 12$	1/4	10-KQ2U10-02NS	17	15.9	49	44.3	15.6	15.9	10.1	8	4.2	28.4	9	25.6
	3/8	10-KQ2U10-03NS	17	15.9	50.4	45.3	15.6	15.9	10.1	8	4.2	28.4	9.4	33.4
$\phi 16$	1/2	10-KQ2U10-04NS	22	15.9	54.6	48.2	15.6	15.9	10.1	8	4.2	28.4	9.4	61.3
	3/8	10-KQ2U12-03NS	19	18.5	53	48.3	17	18.5	11.4	8	4.2	45.4	9	36
$\phi 16$	1/2	10-KQ2U12-04NS	19	18.5	54.4	49.3	17	18.5	11.4	8	4.2	45.4	11	38.9
	3/8	10-KQ2U16-03NS	24	23.8	62.4	57.7	20.6	23.8	14	8	4.2	45.4	9	67.6
$\phi 16$	1/2	10-KQ2U16-04NS	24	23.8	63.8	58.7	20.6	23.8	14	8	4.2	60	11	71.5
	3/8	10-KQ2U16-04NS	24	23.8	68	61.6	20.6	23.8	14	8	4.2	60	13	82.6

* Reference dimensions after installation of R thread
Note) ϕD is maximum diameter.

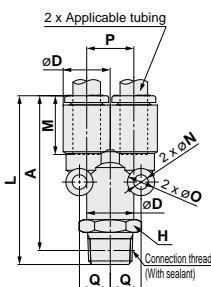

Air Grippers

Air Preparation Equipment

Modular F. R.

Delta Union: 10-KQ2D



Applicable tubing O.D. (mm)	Model	Note) ϕD	L	M	Q	ϕO	ϕN	Effective area (mm ²) Urethane	Min. port size	Weight (g)
$\phi 4$	10-KQ2D04-00A	8.2	15.8	13.3	5.7	6	3.2	4.1	3	2.7
$\phi 6$	10-KQ2D06-00A	10.4	16.8	13.3	6.7	6	3.2	11	4.5	3.8
$\phi 8$	10-KQ2D08-00A	13.2	18.8	14.2	8.4	8	4.2	18.2	6	6.8
$\phi 10$	10-KQ2D10-00A	15.9	21.2	15.6	9.6	8	4.2	29	7.5	10.3
$\phi 12$	10-KQ2D12-00A	18.5	23.6	17	10.7	8	4.2	45.2	9	15.2

Note) ϕD is maximum diameter.

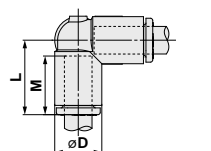
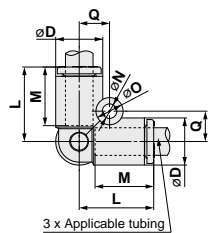

Pressure Control Equipment

Fittings & Tubing

Flow Control Equipment

Pressure Switches/ Pressure Sensors

Dimensions

Union "Y": 10-KQ2U



Applicable tubing O.D. (mm)	Model	Note) ϕD	L1	L2	P	M	Q	ϕO	ϕN	Effective area (mm ²) Urethane	Min. port size	Weight (g)
$\phi 2$	10-KQ2U02-00A	5.8	25.8	16.1	5.8	11.9	4.5	6	3.2	0.9	1.2	1.6
$\phi 3.2$	10-KQ2U23-00A	7.1	28.9	18	7.1	13.3	5.2	6	3.2	2.9	2.5	2.4
$\phi 4$	10-KQ2U04-00A	8.2	29	18.2	8.2	13.3	5.7	6	3.2	4.2	3	2.9
$\phi 6$	10-KQ2U06-00A	10.4	30.1	19.4	10.4	13.3	6.8	6	3.2	10.6	4.5	4.1
$\phi 8$	10-KQ2U08-00A	13.2	33.2	22.3	13.2	14.2	8.7	8	4.2	17.7	6	7.4
$\phi 10$	10-KQ2U10-00A	15.9	37.1	25	15.9	15.6	10.1	8	4.2	28.4	7.5	11.2
$\phi 12$	10-KQ2U12-00A	18.5	41.1	27.8	18.5	17	11.4	8	4.2	45.4	9	16.4
$\phi 16$	10-KQ2U16-00A	23.8	51.5	35	23.8	20.6	14	8	4.2	60	13	30.6

Note) ϕD is maximum diameter.

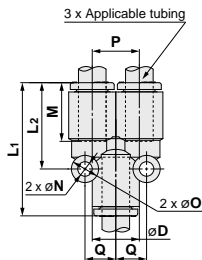

Plug-in "Y": 10-KQ2U



Applicable tubing O.D. (mm)	Applicable fitting size ϕd	Model	Note) ϕD	L1	L2	P	A	M	Q	ϕN	Effective area (mm ²) Urethane	Min. port size	Weight (g)	
$\phi 3.2$	$\phi 3.2$	10-KQ2U23-99A	7.1	45.1	18	7.1	31.8	13.3	5.2	6	3.2	2.9	2	2.5
$\phi 4$	$\phi 4$	10-KQ2U04-99A	8.2	44.8	18.2	8.2	31.5	13.3	5.7	6	3.2	4.2	2.5	3.1
$\phi 6$	$\phi 6$	10-KQ2U06-99A	10.4	46.3	19.4	10.4	33	13.3	6.8	6	3.2	10.6	4	4.5
$\phi 8$	$\phi 8$	10-KQ2U08-99A	13.2	52.1	22.3	13.2	37.9	14.2	8.7	8	4.2	17.7	6	8
$\phi 10$	$\phi 10$	10-KQ2U10-99A	15.9	57.3	25	15.9	41.7	15.6	10.1	8	4.2	28.4	7.5	12.3
$\phi 12$	$\phi 12$	10-KQ2U12-99A	18.5	63	27.8	18.5	46	17	11.4	8	4.2	45.4	9	18.3
$\phi 16$	$\phi 16$	10-KQ2U16-99A	23.8	75.9	35	23.8	55.3	20.6	14	8	4.2	60	13	33.5

Note) ϕD is maximum diameter.

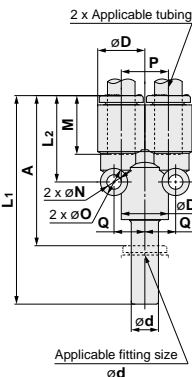

Different Diameter Union "Y": 10-KQ2U



Applicable tubing O.D. (mm)	Model	Note) $\phi D1$	Note) $\phi D2$	L1	L2	P	M1	M2	Q	ϕO	ϕN	Effective area (mm ²) Urethane	Min. port size	Weight (g)	
$\phi 2$	$\phi 3.2$	10-KQ2U02-23A	5.8	7.1	28.2	16.6	5.8	11.9	13.3	5.2	6	3.2	0.9	1.2	1.9
$\phi 2$	$\phi 4$	10-KQ2U02-04A	5.8	8.2	27.6	15.7	5.8	11.9	13.3	5.7	6	3.2	0.9	1.2	2.1
$\phi 3.2$	$\phi 4$	10-KQ2U23-04A	7.1	8.2	28.9	18	7.1	13.3	13.3	5.7	6	3.2	2.7	2.5	2.7
$\phi 4$	$\phi 6$	10-KQ2U04-06A	8.2	10.4	29	18	8.2	13.3	13.3	6.8	6	3.2	4.2	3	3.3
$\phi 6$	$\phi 8$	10-KQ2U06-08A	10.4	13.2	31	19.3	10.4	13.3	14.2	8.2	6	3.2	10.6	4.5	5
$\phi 8$	$\phi 10$	10-KQ2U08-10A	13.2	15.9	34.6	22.3	13.2	14.2	15.6	10.1	8	4.2	17.7	6	8.6
$\phi 10$	$\phi 12$	10-KQ2U10-12A	15.9	18.5	38.5	25	15.9	15.6	17	11.4	8	4.2	28.4	7.5	12.7
$\phi 12$	$\phi 16$	10-KQ2U12-16A	18.5	23.8	47.9	31	18.5	17	20.6	14	8	4.2	45.4	9	21.2

Note) $\phi D1$, $\phi D2$ are maximum diameters.

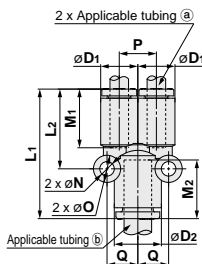

Dimensions

Double Branch “Y”: 10-KQ2UD (Sealant)



Applicable tubing O.D. (mm)	Connection thread R	Model	H (Width across flats)	Note) ϕD_1	ϕD_2	L	I	A*	M	P	Q	ϕO	ϕN	Effective area (mm ²) Urethane	Min. port size	Weight (g)
$\phi 4$	1/8	10-KQ2UD04-01NS	12	8.2	10.4	36.7	16.6	33.6	13.3	8.2	6.8	6	3.2	4.2	5.4	11.7
	1/4	10-KQ2UD04-02NS	14	8.2	10.4	41.1	16.6	36.4	13.3	8.2	6.8	6	3.2	4.2	5.4	20.6
$\phi 6$	1/8	10-KQ2UD06-01NS	14	10.4	13.2	39.5	21	36.4	13.3	10.4	8.2	6	3.2	10.6	6	16.4
	1/4	10-KQ2UD06-02NS	14	10.4	13.2	43.9	21	39.2	13.3	10.4	8.2	6	3.2	10.6	7.3	21.6

* Reference dimensions after installation of R thread
Note) ϕD_1 is maximum diameter.

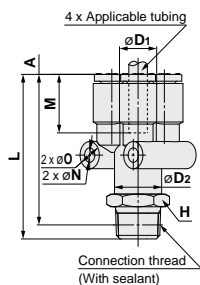
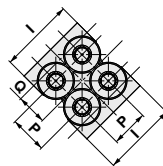

Different Diameter Double Union “Y”: 10-KQ2UD



Applicable tubing O.D. (mm)		Model	Note) ϕD_1	Note) ϕD_2	L ₁	L ₂	P	I	M ₁	M ₂	Q	ϕO	ϕN	Effective area (mm ²) Urethane	Min. port size	Weight (g)
(a)	(b)															
$\phi 4$	$\phi 6$	10-KQ2UD04-06A	8.2	10.4	29.2	18.2	8.2	16.6	13.3	13.3	6.8	6	3.2	4.2	3	5.4
$\phi 6$	$\phi 8$	10-KQ2UD06-08A	10.4	13.2	32	20.5	10.4	21	13.3	14.2	8.2	6	3.2	10.6	4.5	8.1

Note) ϕD_1 , ϕD_2 are maximum diameters.

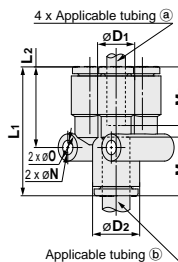
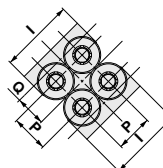

Directional Control Valves

Air Cylinders

Rotary Actuators

Air Grippers

Air Preparation Equipment

Modular F. R.

Pressure Control Equipment

Fittings & Tubing

Flow Control Equipment

Pressure Switches/ Pressure Sensors

Dimensions

Double Plug-in “Y”: 10-KQ2XD



Applicable tubing O.D. (mm)	Applicable fitting size ϕd	Model	Note) $\phi D1$	$\phi D2$	L1	L2	A	I	P	M	Q	ϕO	ϕN	Effective area (mm ²) Urethane	Min. port size	Weight (g)
$\phi 4$	$\phi 6$	10-KQ2XD04-06A	8.2	10.4	45.4	18.2	32.1	16.6	8.2	13.3	6.8	6	3.2	4.2	3	5.9
$\phi 6$	$\phi 8$	10-KQ2XD06-08A	10.4	13.2	50.9	20.5	36.7	21	10.4	13.3	8.2	6	3.2	10.6	4.5	8.6

Note) $\phi D1$ is maximum diameter.

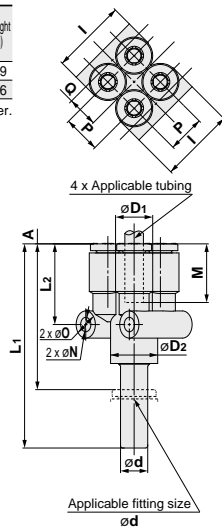

Different Diameter Plug-in “Y”: 10-KQ2X



Applicable tubing O.D. (mm)	Applicable fitting size ϕd	Model	Note) $\phi D1$	Note) $\phi D2$	L1	L2	A	P	M	Q	ϕO	ϕN	Effective area (mm ²) Urethane	Min. port size	Weight (g)
$\phi 3.2$	$\phi 4$	10-KQ2X23-04A	7.1	8.2	44.7	18	31.4	7.1	13.3	5.7	6	3.2	2.7	2.5	2.8
$\phi 4$	$\phi 6$	10-KQ2X04-06A	8.2	10.4	45.2	18	31.9	8.2	13.3	6.8	6	3.2	4.2	3	3.8
$\phi 6$	$\phi 8$	10-KQ2X06-08A	10.4	13.2	49.9	19.3	35.7	10.4	13.3	8.2	6	3.2	10.6	4.5	5.5
$\phi 8$	$\phi 10$	10-KQ2X08-10A	13.2	15.9	54.8	22.3	39.2	13.2	14.2	10.1	8	4.2	17.7	6	9.8
$\phi 10$	$\phi 12$	10-KQ2X10-12A	15.9	18.5	60.4	25	43.4	15.9	15.6	11.4	8	4.2	28.4	7.5	14.6

Note) $\phi D1$, $\phi D2$ are maximum diameters.

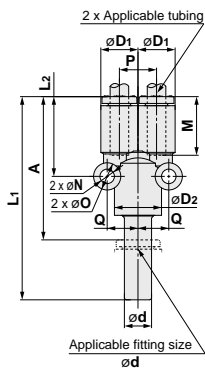

Dimensions

Plug-in Reducer: 10-KQ2R



Applicable tubing O.D. (mm)	Applicable fitting size ϕ d	Model	Note) ϕ D	L	A	M	Effective area (mm ²) Urethane	Min. port size	Weight (g)
ϕ 3.2	ϕ 4	10-KQ2R23-04A	7.1	28.6	15.3	13.3	2.9	2.5	0.8
	ϕ 6	10-KQ2R23-06A	7.1	29.1	15.8	13.3	2.9	2.5	1
ϕ 4	ϕ 6	10-KQ2R04-06A	8.2	28.6	15.3	13.3	4	3	1.1
	ϕ 8	10-KQ2R04-08A	8.2	29.6	15.4	13.3	4	3	1.3
ϕ 10	ϕ 10	10-KQ2R04-10A	10.4	31.7	16.1	13.3	4	3	2.2
	ϕ 4	10-KQ2R06-04A	10.4	33.6	20.3	13.3	4	2.5	1.4
ϕ 6	ϕ 8	10-KQ2R06-08A	10.4	31.6	17.4	13.3	10.4	4.5	1.7
	ϕ 10	10-KQ2R06-10A	10.4	33.9	18.3	13.3	10.4	4.5	2.1
	ϕ 12	10-KQ2R06-12A	12	35.7	18.7	13.3	10.4	4.5	3.2
ϕ 8	ϕ 10	10-KQ2R08-10A	13.2	35.1	19.5	14.2	18	6	2.9
	ϕ 12	10-KQ2R08-12A	13.2	36.5	19.5	14.2	18	6	3.4
ϕ 10	ϕ 12	10-KQ2R10-12A	15.9	39.2	22.2	15.6	32.8	7.5	4.5
	ϕ 16	10-KQ2R10-16A	16	44.7	24.1	15.6	32.8	7.5	6
ϕ 12	ϕ 16	10-KQ2R12-16A	18.5	45.7	25.1	17	46.1	9	7

Note) ϕ D is maximum diameter.

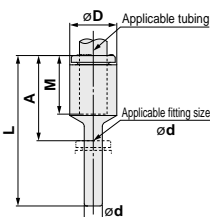

Bulkhead Union: 10-KQ2E (Interchangeable with KQ)



Applicable tubing O.D. (mm)	Model	T (M)	H (Width across flats)	L	Mounting hole	M	Effective area (mm ²) Urethane	Min. port size	Weight (g)
ϕ 3.2	10-KQ2E23-00N	M12 x 1	14	27.3	13	13.3	2.9	2.5	24.1
ϕ 4	10-KQ2E04-00N	M12 x 1	14	27.3	13	13.3	4	3	22.9
ϕ 6	10-KQ2E06-00N	M14 x 1	17	27.3	15	13.3	10.4	4.5	28
ϕ 8	10-KQ2E08-00N	M16 x 1	19	29.1	17	14.2	18	6	34
ϕ 10	10-KQ2E10-00N	M20 x 1	24	31.9	21	15.6	29.5	7.5	64.4
ϕ 12	10-KQ2E12-00N	M22 x 1	27	34.7	23	17	46.1	9	63.8
ϕ 16	10-KQ2E16-00N	M28 x 1.5	32	41.9	29	20.6	67	13	120.1

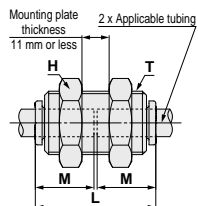

Bulkhead Union: 10-KQ2E (Interchangeable with KJ)



Applicable tubing O.D. (mm)	Model	T (M)	H (Width across flats)	L	Mounting hole	M	Effective area (mm ²) Urethane	Min. port size	Weight (g)
ϕ 2	10-KQ2E02-00NJ	M7 x 0.75	9	24.5	8	11.9	0.9	1.4	5.2
ϕ 3.2	10-KQ2E23-00NJ	M8 x 0.75	10	27.3	9	13.3	2.5	2.5	6.9
ϕ 4	10-KQ2E04-00NJ	M8 x 0.75	11	27.3	10	13.3	4	3	8.3
ϕ 6	10-KQ2E06-00NJ	M11 x 0.75	14	27.3	12	13.3	10	4.5	11.2

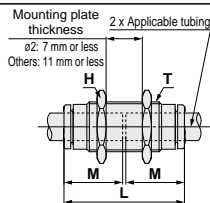

Bulkhead Connector: 10-KQ2E



Applicable tubing O.D. (mm)	Connection thread Rc	Model	T (M)	H1 (Width across flats)	H2 (Width across flats)	L1	L2	Mounting hole	M	Effective area (mm ²) Urethane	Min. port size	Weight (g)
ϕ 3.2	1/4	10-KQ2E23-02N	M12 x 1	17	14	28.7	14.3	13	13.3	2.9	2.5	31.2
ϕ 4	1/8	10-KQ2E04-01N	M12 x 1	14	14	24.4	10	13	13.3	4	3	21.2
	1/4	10-KQ2E04-02N	M12 x 1	17	14	29	14.6	13	13.3	4	3	30.9
ϕ 6	1/8	10-KQ2E06-01N	M14 x 1	17	17	23.6	9.2	15	13.3	10.4	4.5	28.9
	1/4	10-KQ2E06-02N	M14 x 1	17	17	28.4	14	15	13.3	10.4	4.5	32.4
ϕ 8	3/8	10-KQ2E06-03N	M14 x 1	19	17	30.7	16.3	15	13.3	10.4	4.5	35.9
	1/4	10-KQ2E08-01N	M16 x 1	17	19	24.1	6.7	17	14.2	18	6	30.5
ϕ 10	1/4	10-KQ2E08-02N	M16 x 1	17	19	28.4	11	17	14.2	18	6	33.1
	3/8	10-KQ2E08-03N	M16 x 1	19	19	31.7	14.3	17	14.2	18	6	37.4
ϕ 12	1/4	10-KQ2E10-02N	M20 x 1	22	24	29.3	9.9	21	15.6	29.5	7.5	63.8
	3/8	10-KQ2E10-03N	M20 x 1	22	24	31.4	12	21	15.6	29.5	7.5	71.6
ϕ 16	3/8	10-KQ2E12-03N	M22 x 1	24	27	32.3	11.9	23	17	46.1	9	69.3
	1/2	10-KQ2E12-04N	M22 x 1	24	27	37.7	17.3	23	17	46.1	9	72.7
ϕ 16	3/8	10-KQ2E16-03N	M28 x 1.5	30	32	34.4	11.5	29	20.6	67	13	122.2
	1/2	10-KQ2E16-04N	M28 x 1.5	30	32	38.8	15.9	29	20.6	67	13	132.1

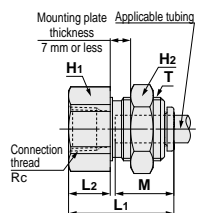

Dimensions

Bulkhead Male Elbow: 10-KQ2LE



Applicable tubing O.D. (mm)	Model	T (M)	H ₁ (Width across flats)	H ₂ (Width across flats)	B	E	Note) øD	Mouring hole	M	Effective area (mm ²) Urethane	Min. port size	Weight (g)
ø4	10-KQ2LE04-00N	M12 x 1	14	14	14.8	28.5	8.2	13	13.3	4.2	3	21.2
ø6	10-KQ2LE06-00N	M14 x 1	17	17	15.5	29.6	10.4	15	13.3	9	4.5	29.4
ø8	10-KQ2LE08-00N	M16 x 1	17	19	17.2	32.3	13.2	17	14.2	14.9	6	30.4
ø10	10-KQ2LE10-00N	M20 x 1	22	24	19.3	37.9	15.9	21	15.6	25	7.5	53.5
ø12	10-KQ2LE12-00N	M22 x 1	24	27	21.5	40.8	18.5	23	17	39.7	9	61

Note) øD is maximum diameter.

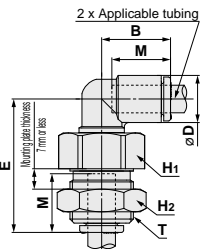

Plug: 10-KQP



Applicable fitting size ød	Model	øD	L	A	Weight (g)
ø2	10-KJP-02	3	17	5.1	0.1
ø3.2	10-KQP-23	5	31.5	18.2	1
ø4	10-KQP-04	6	32	18.7	1
ø6	10-KQP-06	8	35	21.7	1
ø8	10-KQP-08	10	39	24.8	2
ø10	10-KQP-10	12	43	27.4	3.5
ø12	10-KQP-12	14	45.5	28.5	5
ø16	10-KQP-16	20.9	47	26.4	8

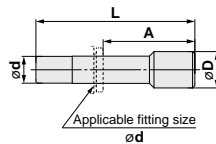

Adapter: 10-KQ2N (Gasket seal)



Applicable fitting size ød	Connection thread M	Model	H (Width across flats)	L	A	M	Min. port size	Weight (g)
ø4	M5 x 0.8	10-KQ2N04-M5N	7	29.7	26.7	13.4	2.5	2.4
ø6	M5 x 0.8	10-KQ2N06-M5N	7	29.7	26.7	13.4	2.5	2.6

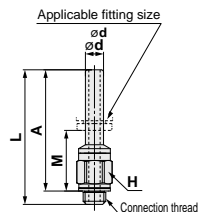

Adapter: 10-KQ2N (Sealant)



Applicable fitting size ød	Connection thread R	Model	H (Width across flats)	L	A*	M	Min. port size	Weight (g)
ø4	1/8	10-KQ2N04-01NS	10	28.3	25.2	11.9	2.5	4
ø6	1/8	10-KQ2N06-01NS	10	28.3	25.2	11.9	4	4.1
	1/4	10-KQ2N06-02NS	14	32.8	28.1	14.8	4	13.6
ø8	1/4	10-KQ2N08-02NS	14	35.9	31.2	17	6	15.7
	3/8	10-KQ2N08-03NS	17	36	30.9	16.7	6	22.7
ø10	3/8	10-KQ2N10-03NS	17	40.6	35.5	19.9	7.5	19.1

* Reference dimensions after installation of R thread

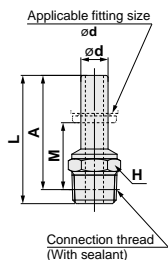

Dimensions

Tube Cap: 10-KQ2C



Applicable tubing O.D. (mm)	Model	øD (Note)	L	M	Weight (g)
ø4	10-KQ2C04-00A	8.2	14.5	13.3	0.8
ø6	10-KQ2C06-00A	10.4	14.6	13.3	1.1
ø8	10-KQ2C08-00A	13.2	15.7	14.2	2
ø10	10-KQ2C10-00A	15.9	17.3	15.6	2.9
ø12	10-KQ2C12-00A	18.5	18.9	17	4.5
ø16	10-KQ2C16-00A	23.8	23	20.6	8.4

Note) øD is maximum diameter.

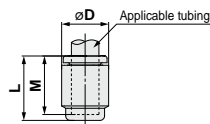

Nipple: 10-KQN



Applicable fitting øD	Model	L	M	ød	Min. port size	Weight (g)
ø4	10-KQN04-99	37	13.3	2.5	2.5	1
ø6	10-KQN06-99	39	13.3	4	4	2
ø8	10-KQN08-99	43	14.2	6	6	2
ø10	10-KQN10-99	49	15.6	7.5	7.5	4
ø12	10-KQN12-99	52	17	9	9	3.3
ø16	10-KQN16-99	57	20.6	13	13	4.8

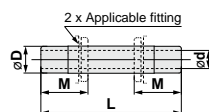

Reducer Nipple: 10-KQN



Applicable fitting (a)	Applicable fitting (b)	Model	L	M1	M2	ød Min. port size	Weight (g)
ø4	ø6	10-KQN04-06	38	13.3	13.3	2.5	2
ø6	ø8	10-KQN06-08	42	14.2	13.3	4	2
ø8	ø10	10-KQN08-10	47	15.6	14.2	6	2
ø10	ø12	10-KQN10-12	51	17	15.6	7.5	3.1
ø12	ø16	10-KQN12-16	55	20.6	17	9	4.9

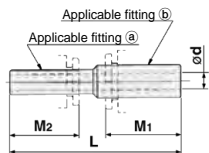

Color Cap: 10-KQ2C

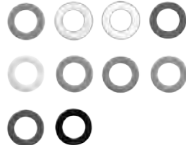

Applicable tubing O.D. (mm)	Model	øD1	øD2	L	Weight (g)	Note
ø2	10-KQ2C-02□A	6.1	3.2	2.6	0.1	Applicable for products with enlarged outside diameter of release button
ø3.2	10-KQ2C-23□A	7.3	4.3	2.6	0.1	
ø4	10-KQ2C-04□A	8.3	5.2	2.6	0.1	
ø6	10-KQ2C-06□A	10.3	7.2	2.6	0.1	
ø8	10-KQ2C-08□B	13.6	9.2	2.6	0.1	
ø10	10-KQ2C-10□B	16.2	11.2	2.7	0.1	
ø12	10-KQ2C-12□B	18.8	13.2	2.7	0.2	
ø16	10-KQ2C-16□B	24.2	17.2	3.2	0.3	

□: B (Black), R (Red), YR (Orange), BR (Brown), Y (Yellow), G (Green), CB (Sky blue), GR (Gray), W (White), BU (Blue)

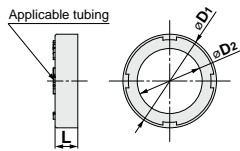

! In order to improve the operability, the outside diameter of the release button has been enlarged for the New KQ2 series. Along with this change, the usable color caps differ before and after the change. For details, refer to "Notes when Ordering Color Caps" in the standard products KQ2 series (**WEB catalog**). Additionally, when ordering the color cap, add "10-" at the beginning of the part number. Example) 10-KQ2C-06BA

Series 10-KQ2

Inch Size One-touch Fittings

Applicable Tubing: Inch Size, Connection Thread: UNF, NPT

RoHS

Guide Chuck
Large retaining force
The chuck provides secure retention and the collet increases the holding force on the tube.

Seal
Can be used for a wide range of pressures from a low vacuum up to a pressure of 1 MPa.
The use of a special profile ensures sealing and reduces resistance when the tube is inserted.

Release Button (White)
Requires little force for removal.
Releases the chuck collet to remove the tube as well as to prevent the chuck from biting too deeply into the tubing.

Body
O-ring
Stud
Effective when piping in a confined space.
Body part rotates allowing for positioning.

Connection Thread
UNF, NPT

Guide Chuck
Release Button (White)
Seal

* Fittings without thread portion, and with all resin body material are copper free specification.

One-touch IN/OUT connection.
Possible to use in vacuum to -100 kPa

- Applicable tubing—Inch size
- Applicable tubing material PFA, Polyurethane



Applicable Tubing

Tubing material (Note)	PFA, Polyurethane
Tubing O.D.	ø1/8", ø5/32", ø3/16", ø1/4", ø5/16", ø3/8", ø1/2"

Note) FEP, nylon and soft nylon tubing can also be used. However, the degree of clean performance will be reduced.

Color

Series	Body	Release button
Series 10-KQ2	White	White

Specifications

Fluid		Air, Water (Note 1)
Operating pressure range (Note 2)		-100 kPa to 1 MPa
Proof pressure (at 23°C)		3 MPa
Ambient and fluid temperature		-5 to 60°C, Water: 0 to 40°C (No freezing)
Thread	Mounting section	ANSI/ASME1.20.1 (NPT thread) JIS B0208 (UNF thread)
	Nut section	JIS B0208 (UNF thread)
Seal on the threads		With seal or none
Grease		Fluorine based grease
Cleanliness class (ISO class)		Class 5

Note 1) The surge pressure must be under the maximum operating pressure.

Note 2) Do not use the fittings with a leak tester or for vacuum retention because they are not guaranteed for zero leakage.

Principal Parts Material

Body	C3604 Electroless nickel plated, PBT, PP
Stud	C3604 (Thread portion) Electroless nickel plated
Chuck	Stainless steel 304
Guide	Stainless steel 304
Release button	POM
Seal, O-ring	NBR
Gasket	Stainless steel 304, NBR

Directional Control Valves

Air Cylinders

Rotary Actuators

Air Grippers

Air Preparation Equipment

Modular F. R.

Pressure Control Equipment

Fittings & Tubing

Flow Control Equipment

Pressure Switches/ Pressure Sensors

Inch Size One-touch Fittings

Variations

Hexagon socket head male connector

10-KQ2S P.1159



Internal hexagon socket allows tightening with a hexagon wrench in confined spaces.

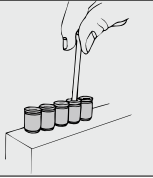

Universal male elbow

10-KQ2V P.1162



Hexagon head of the body allows tightening with a box wrench in confined spaces.

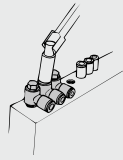

45° male elbow

10-KQ2K P.1162



Use to pipe a female thread at a 45° angle. The model between the male connector and male elbow.

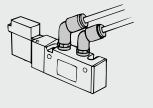

Extended male elbow

10-KQ2W P.1167



Basically, it is used together with male elbow. Different point is that it is used for fittings to avoid interfering with each other by making the piping multi-level.

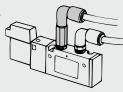

Bulkhead union

10-KQ2E P.1173



Use to connect tubing through a panel, etc.

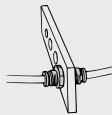

Bulkhead connector

10-KQ2E P.1174



Use to connect male thread and tubing through a panel, etc.

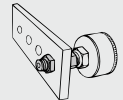

Nipple

10-KQN P.1175



Use to connect One-touch fittings.



Reducer nipple

10-KQN P.1175



Use to connect One-touch fittings of different sizes.

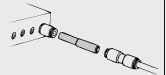

Male connector

10-KQ2H P.1157



Use to pipe a female thread. Most general model.

Hexagon socket head universal male elbow

10-KQ2VS P.1163



Hexagon socket on the top allows tightening with a hexagon wrench in confined spaces.

Branch universal male elbow

10-KQ2Z P.1166



Hexagon head of the body allows tightening with a box wrench. Use for branch connections.

Female connector

10-KQ2F P.1158



Use to pipe a male thread of a pressure gauge, etc.

Universal female elbow

10-KQ2VF P.1163



Use to branch a male or female thread at a 90° angle. Multiple connections possible.

Double branch universal male elbow

10-KQ2ZD P.1166



Use to four-branch a female thread at right angles. Two individual parts rotate 360°.

Straight union

10-KQ2H P.1158



Use to connect tubing in the same direction.

Female elbow

10-KQ2LF P.1161



Use to pipe a male thread at right angles.

Triple branch universal male elbow

10-KQ2ZT P.1167



Use to six-branch a female thread at right angles. Three individual parts rotate 360°.

Different diameter straight

10-KQ2H P.1158



Use to connect tubing of different sizes.

Double universal male elbow

10-KQ2VD P.1164



Use to branch a female thread at right angles. Two individual parts rotate 360°.

Union elbow

10-KQ2L P.1161



Use to connect tubing at right angles.

Male elbow

10-KQ2L P.1160



Use to pipe a female thread at right angles. Most general model.

Triple universal male elbow

10-KQ2VT P.1165



Use to three-branch a female thread at right angles. Three individual parts rotate 360°.

Plug-in elbow

10-KQ2L P.1161



Use to change the tube direction from One-touch fittings by 90°.

Reducer elbow

10-KQ2L P.1161



Use to change the tube direction from One-touch fittings by 90° and to reduce size.

Male branch tee

10-KQ2T P.1168



Use to branch a female thread at both 90° angles.

Union tee

10-KQ2T P.1169



Use to branch tubing at both 90° angles.

Different diameter tee

10-KQ2T P.1169



Use to connect tubing for branching at 90° angle with size reduced from the same piping.

Cross

10-KQ2TW P.1169



Use to four-branch line.

Male run tee

10-KQ2Y P.1170



Use to branch a female thread at a 90° angle.

Branch "Y"

10-KQ2U P.1171



Use to branch a female thread.

Union "Y"

10-KQ2U P.1172



Use to branch tubing in the same direction.

Different diameter union "Y"

10-KQ2U P.1172



Use to connect tubing for branching with size reduced.

Plug-in "Y"

10-KQ2U P.1172



Use to branch One-touch fittings.

Different diameter plug-in "Y"

10-KQ2X P.1173



Use to branch One-touch fittings with size reduced.

Plug-in reducer

10-KQ2R P.1173



Use to change size of One-touch fittings.

Bulkhead male elbow

10-KQ2LE P.1174



Use to connect tubing through a panel, etc. and to change the tube direction by 90°.

Tube cap

10-KQ2C P.1175



Use to plug unused tubing.

Plug

10-KQP P.1174



Use to plug unused One-touch fittings.

Color cap

10-KQ2C P.1175



Mount onto the release button and use different colors for piping according to applications.

Directional Control Valves

Air Cylinders

Rotary Actuators

Air Grippers

Air Preparation Equipment

Modular F. R.

Pressure Control Equipment

Fittings & Tubing

Flow Control Equipment

Pressure Switches/ Pressure Sensors

Dimensions

Male Connector: 10-KQ2H (Gasket seal)



Applicable tubing O.D. (inch)	Connection thread UNF	Model	H (Width across flats)	øD	L	A	M	Effective area (mm ²) Urethane	Min. port size	Weight (g)
ø1/8	10-32UNF	10-KQ2H01-32N	7	6.7	17.4	13.9	13.3	2.5	2.3	2.7
ø5/32	10-32UNF	10-KQ2H03-32N	8	7.7	17.6	14.1	13.3	3.3	2.3	3.3
ø3/16	10-32UNF	10-KQ2H05-32N	8	8.3	17.7	14.2	13.3	3.4	2.3	3.4
ø1/4	10-32UNF	10-KQ2H07-32N	11.11	10.9	18	14.5	13.3	3.4	2.3	5.2

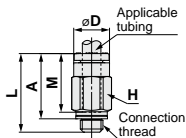

Male Connector: 10-KQ2H (Sealant)



Applicable tubing O.D. (inch)	Connection thread NPT	Model	H (Width across flats)	øD	L	A*	M	Effective area (mm ²) Urethane	Min. port size	Weight (g)
ø1/8	1/16	10-KQ2H01-33NS	9.5	6.7	19.3	15.2	13.3	2.5	2.5	6
	1/8	10-KQ2H01-34NS	11.11	6.7	14	10.8	13.3	2.5	2.5	7.1
	1/4	10-KQ2H01-35NS	14.29	6.7	16.7	12.3	13.3	2.9	2.5	16.2
ø5/32	1/16	10-KQ2H03-33NS	9.5	7.7	20	15.9	13.3	4	3	6.1
	1/8	10-KQ2H03-34NS	11.11	7.7	14	10.8	13.3	4	3	6.5
	1/4	10-KQ2H03-35NS	14.29	7.7	16.7	12.3	13.3	4	3	15.6
ø3/16	1/8	10-KQ2H05-34NS	11.11	8.3	17.4	14.2	13.3	6.5	3.5	7.4
	1/4	10-KQ2H05-35NS	14.29	8.3	16.7	12.3	13.3	6.5	3.5	14.9
	1/16	10-KQ2H07-33NS	11.11	10.9	22.5	18.4	13.3	11.5	4.6	7.6
ø1/4	1/8	10-KQ2H07-34NS	11.11	10.9	18	14.8	13.3	11.5	4.6	6.5
	1/4	10-KQ2H07-35NS	14.29	10.9	16.7	12.3	13.3	11.5	4.6	13.1
	3/8	10-KQ2H07-36NS	17.46	10.9	18.1	13.4	13.3	11.5	4.6	25.7
ø5/16	1/8	10-KQ2H09-34NS	14.29	13	22.2	19	14.2	18	6	12.6
	1/4	10-KQ2H09-35NS	14.29	13	22.1	17.7	14.2	18	6	15.2
	3/8	10-KQ2H09-36NS	17.46	13	18.1	13.4	14.2	18	6	22.5
ø3/8	1/8	10-KQ2H11-34NS	17.46	15.1	24.1	20.9	15.6	26	6	19.5
	1/4	10-KQ2H11-35NS	17.46	15.1	25.1	20.7	15.6	29.1	7	21
	3/8	10-KQ2H11-36NS	17.46	15.1	22.7	18	15.6	29.1	7	23.5
ø1/2	1/2	10-KQ2H11-37NS	22.23	15.1	22.3	15.9	15.6	29.1	7	49.1
	1/4	10-KQ2H13-35NS	22.23	19	28.8	24.4	17	51.7	9	34.4
	3/8	10-KQ2H13-36NS	22.23	19	27.5	22.8	17	51.7	9.6	36.2
	1/2	10-KQ2H13-37NS	22.23	19	28	21.6	17	51.7	9.6	47.1

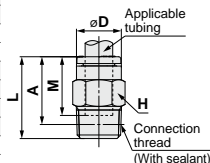

* Reference dimensions after installation of NPT thread

Dimensions

Straight Union: 10-KQ2H



Applicable tubing O.D. (inch)	Model	øD (Note)	L	M	Effective area (mm ²)	Min. port size	Weight (g)
					Urethane		
ø1/8	10-KQ2H01-00A	7.1	27.6	13.3	2.9	2.5	1.4
ø5/32	10-KQ2H03-00A	8.2	27.6	13.3	4	3	1.6
ø3/16	10-KQ2H05-00A	9.1	27.6	13.3	6.5	3.5	1.9
ø1/4	10-KQ2H07-00A	11.1	27.6	13.3	11.5	4.6	2.4
ø5/16	10-KQ2H09-00A	13.2	29.4	14.2	18	6	3.7
ø3/8	10-KQ2H11-00A	15.4	32.2	15.6	29.1	7	5.2
ø1/2	10-KQ2H13-00A	19.3	35	17	51.7	9.6	8.7

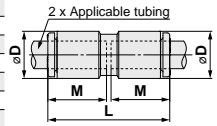

(Note) øD is maximum diameter.

Different Diameter Straight: 10-KQ2H



Applicable tubing O.D. (inch)		Model	Note) øD1	Note) øD2	L	M1	M2	Effective area (mm ²)	Min. port size	Weight (g)
(a)	(b)							Urethane		
ø1/8	ø5/32	10-KQ2H01-03A	7.1	8.2	27.6	13.3	13.3	2.9	2.5	1.5
	ø1/4	10-KQ2H01-07A	7.1	11.1	27.6	13.3	13.3	2.9	2.5	2
ø5/32	ø3/16	10-KQ2H03-05A	8.2	9.1	27.6	13.3	13.3	5.6	3	1.8
	ø1/4	10-KQ2H03-07A	8.2	11.1	27.6	13.3	13.3	5.6	3	2.1
ø3/16	ø1/4	10-KQ2H05-07A	9.1	11.1	27.6	13.3	13.3	6.5	3.5	2.2
	ø5/16	10-KQ2H07-09A	11.1	13.2	28.5	13.3	14.2	11.5	4.6	3.2
ø1/4	ø3/8	10-KQ2H07-11A	11.1	15.4	29.9	13.3	15.6	11.5	4.6	4.1
	ø3/8	10-KQ2H09-11A	13.2	15.4	30.8	14.2	15.6	18	6	4.7
ø5/16	ø1/2	10-KQ2H09-13A	13.2	19.3	32.2	14.2	17	18	6	6.6
	ø3/8	10-KQ2H11-13A	15.4	19.3	33.6	15.6	17	29.1	7	7.3

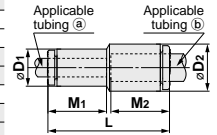

(Note) øD1, øD2 are maximum diameters.

Female Connector: 10-KQ2F



Applicable tubing O.D. (inch)	Connection thread UNF, NPT	Model	H (Width across flats)	Note) øD	L1	L2	M	Effective area (mm ²)	Min. port size	Weight (g)
								Urethane		
ø1/8	10-32UNF	10-KQ2F01-32N	7	6.9	19.7	5.7	13.3	2.5	2.5	3.4
	1/8	10-KQ2F01-34N	14.29	6.9	25	9.5	13.3	2.5	2.5	13.4
	1/4	10-KQ2F01-35N	17.46	6.9	29.8	13.3	13.3	2.5	2.5	24.4
ø5/32	10-32UNF	10-KQ2F03-32N	8	7.9	19.5	5.7	13.3	4	3	4.5
	1/8	10-KQ2F03-34N	14.29	7.9	24.8	9.5	13.3	4	3	13.7
	1/4	10-KQ2F03-35N	17.46	7.9	29.7	13.3	13.3	4	3	24.7
ø1/4	10-32UNF	10-KQ2F07-32N	11.11	10.9	17.7	5.5	13.3	10.1	3.9	6.7
	1/8	10-KQ2F07-34N	14.29	10.9	24.4	9.5	13.3	11.5	4.6	14.2
	1/4	10-KQ2F07-35N	17.46	10.9	29.2	13.3	13.3	11.5	4.6	25.1
	3/8	10-KQ2F07-36N	22.23	10.9	30.5	13.2	13.3	11.5	4.6	38.7
ø5/16	1/8	10-KQ2F09-34N	14.29	13	24.8	9.2	14.2	18	6	15.2
	1/4	10-KQ2F09-35N	17.46	13	29.7	11.8	14.2	18	6	26.2
	3/8	10-KQ2F09-36N	22.23	13	31	12.4	14.2	18	6	39.8
ø3/8	1/4	10-KQ2F11-35N	17.46	15.1	30.5	11.8	15.6	29.1	8	27.2
	3/8	10-KQ2F11-36N	22.23	15.1	31.8	12.4	15.6	29.1	8	40.7
	1/2	10-KQ2F11-37N	23.81	15.1	34.9	15.8	15.6	29.1	8	45.6
ø1/2	3/8	10-KQ2F13-36N	22.23	19	32.6	12.4	17	51.7	10	43.8
	1/2	10-KQ2F13-37N	23.81	19	35.7	15.8	17	51.7	10	48.6

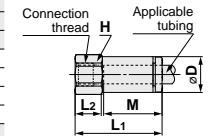

(Note) øD is maximum diameter.

Directional Control Valves
Air Cylinders
Rotary Actuators
Air Grippers
Air Preparation Equipment
Modular F. R.
Pressure Control Equipment
Fittings & Tubing
Flow Control Equipment
Pressure Switches/ Pressure Sensors

Dimensions

Hexagon Socket Head Male Connector: 10-KQ2S (Gasket seal)



Applicable tubing O.D. (inch)	Connection thread UNF	Model	H (Width across flats)	Note) øD	L1	L2	A	M	Effective area (mm ²) Urethane	Min. port size	Weight (g)
ø1/8	10-32UNF	10-KQ2S01-32N	2	7	17.5	16.3	14.5	13.3	2.5	2	2.6
ø5/32	10-32UNF	10-KQ2S03-32N	2	8	17.8	16.3	14.8	13.3	2.5	2	3
ø1/4	10-32UNF	10-KQ2S07-32N	2	11	17.8	16.3	14.8	13.3	2.5	2	3.7

Note) øD is maximum diameter.

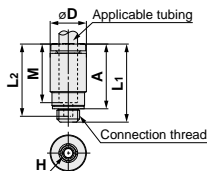

Hexagon Socket Head Male Connector: 10-KQ2S (Sealant)



Applicable tubing O.D. (inch)	Connection thread NPT	Model	H (Width across flats)	Note) øD	L1	L2	A*	M	Effective area (mm ²) Urethane	Min. port size	Weight (g)
ø5/32	1/16	10-KQ2S03-33NS	2.78	8	19.8	18.8	15.7	13.3	3.6	2.8	4.5
	1/8	10-KQ2S03-34NS	2.78	11	17.3	16.3	14.1	13.3	3.6	2.8	6
ø3/16	1/8	10-KQ2S05-34NS	3.57	11	19.8	18.8	16.6	13.3	6.5	3.6	7.5
	1/16	10-KQ2S07-33NS	3.57	11	20.9	18.8	16.8	13.3	8.4	3.6	6.3
ø1/4	1/8	10-KQ2S07-34NS	4.76	11	19.8	18.8	16.6	13.3	11.5	4.8	7.4
	1/4	10-KQ2S07-35NS	4.76	14	19.8	18.8	15.4	13.3	11.5	4.8	13.2
	3/8	10-KQ2S07-36NS	4.76	18	20.8	19.8	16.1	13.3	11.5	4.8	24
ø5/16	1/8	10-KQ2S09-34NS	5.56	13	22.3	19.7	19.1	14.2	16.2	5.6	9.7
	1/4	10-KQ2S09-35NS	6.35	14	21.2	20.1	16.8	14.2	16.2	6.4	12.6
	3/8	10-KQ2S09-36NS	6.35	18	20.7	19.7	16	14.2	16.2	6.4	21
ø3/8	1/8	10-KQ2S11-34NS	5.56	15.1	23.7	21.1	20.5	15.6	22.7	5.6	12.1
	1/4	10-KQ2S11-35NS	6.35	15.1	24.4	21.1	20	15.6	29.1	6.4	15.2
	3/8	10-KQ2S11-36NS	6.35	18	22.1	21.1	17.4	15.6	29.1	6.4	22.7
ø1/2	1/2	10-KQ2S11-37NS	6.35	22	22.1	21.1	15.7	15.6	29.1	6.4	40.6
	1/4	10-KQ2S13-35NS	8	19	28.5	22.5	24.1	17	48	8.1	18.9
	3/8	10-KQ2S13-36NS	9.53	19	26.3	22.5	21.6	17	51.7	9.6	20.7
	1/2	10-KQ2S13-37NS	9.53	22	23.5	22.5	17.1	17	51.7	9.6	33.3

* Reference dimensions after installation of NPT thread
Note) øD is maximum diameter.

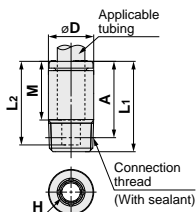

Dimensions

Male Elbow: 10-KQ2L (Gasket seal)



Applicable tubing O.D. (inch)	Connection thread UNF	Model	H (Width across flats)	Note) ϕD_1	ϕD_2	L1	L2	A	M	Effective area (mm ²) Urethane	Min. port size	Weight (g)
$\phi 1/8$	10-32UNF	10-KQ2L01-32N	7	7.1	7	15.3	14.2	14.3	13.3	2.2	2.5	3
$\phi 5/32$	10-32UNF	10-KQ2L03-32N	7	8.2	7	15.4	14.7	15.3	13.3	3.5	2.5	3.1
$\phi 3/16$	10-32UNF	10-KQ2L05-32N	7	9.1	7	14.5	15.8	16.9	13.3	3.5	2.5	3.2
$\phi 1/4$	10-32UNF	10-KQ2L07-32N	7	11.1	7	15.4	16	18.1	13.3	3.5	2.5	3.5

Note) ϕD_1 is maximum diameter.

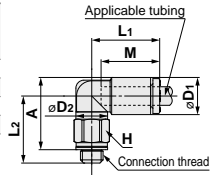

Male Elbow: 10-KQ2L (Sealant)



Applicable tubing O.D. (inch)	Connection thread NPT	Model	H (Width across flats)	Note) ϕD_1	ϕD_2	L1	L2	A*	M	Effective area (mm ²) Urethane	Min. port size	Weight (g)
$\phi 1/8$	1/16	10-KQ2L01-33NS	11.11	7.1	10	14.5	24.3	23.8	13.3	2.5	2.5	9.1
	1/8	10-KQ2L01-34NS	11.11	7.1	10	14.5	16.7	17.1	13.3	2.5	2.5	5.5
	1/4	10-KQ2L01-35NS	14.29	7.1	10	14.5	21.1	20.3	13.3	2.5	2.5	15
$\phi 5/32$	1/16	10-KQ2L03-33NS	11.11	8.2	10	14.8	23.8	23.8	13.3	4.2	3	9.3
	1/8	10-KQ2L03-34NS	11.11	8.2	10	14.8	16.2	17.1	13.3	4.2	3	5.6
	1/4	10-KQ2L03-35NS	14.29	8.2	10	14.8	21.6	21.3	13.3	4.2	3	15.2
$\phi 3/16$	1/8	10-KQ2L05-34NS	11.11	9.1	10	15	16.7	18.1	13.3	5.6	3.5	5.8
	1/4	10-KQ2L05-35NS	14.29	9.1	10	15	22.1	22.3	13.3	5.6	3.5	15.4
	1/16	10-KQ2L07-33NS	11.11	11.1	10	15.6	25.3	26.8	13.3	6.8	3.5	9.8
$\phi 1/4$	1/8	10-KQ2L07-34NS	11.11	11.1	10	15.6	17.7	20.1	13.3	10	4.5	6.1
	1/4	10-KQ2L07-35NS	14.29	11.1	10	15.6	23.1	24.3	13.3	10	4.5	15.7
	3/8	10-KQ2L07-36NS	17.46	11.1	10	15.6	24.5	25.4	13.3	10	4.5	28
$\phi 5/16$	1/8	10-KQ2L09-34NS	11.11	13.2	10	16.4	18.7	22.1	14.2	11.4	4.5	6.9
	1/4	10-KQ2L09-35NS	14.29	13.2	12	17.2	24.1	26.3	14.2	14.9	6	14.1
	3/8	10-KQ2L09-36NS	17.46	13.2	12	17.2	25.5	27.4	14.2	14.9	6	26.2
$\phi 3/8$	1/8	10-KQ2L11-34NS	12.7	15.4	12	18.6	23.2	27.7	15.6	21.2	6	11.8
	1/4	10-KQ2L11-35NS	17.46	15.4	17	19.3	28.6	31.9	15.6	23.8	7.5	21.7
	3/8	10-KQ2L11-36NS	17.46	15.4	17	19.3	29.2	32.2	15.6	23.8	7.5	19.8
$\phi 1/2$	1/2	10-KQ2L11-37NS	22.23	15.4	17	19.3	33.4	34.7	15.6	23.8	7.5	46.2
	1/4	10-KQ2L13-35NS	17.46	19.3	17	21.5	30.5	35.7	17	44.4	9	24
	3/8	10-KQ2L13-36NS	17.46	19.3	17	21.8	26.3	31.2	17	44.4	9.5	20.3
	1/2	10-KQ2L13-37NS	22.23	19.3	17	21.8	30.5	33.7	17	44.4	9.5	46.3

* Reference dimensions after installation of NPT thread
Note) ϕD_1 is maximum diameter.

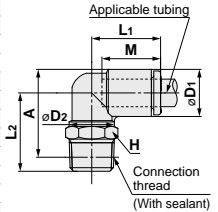

Directional Control Valves

Air Cylinders

Rotary Actuators

Air Grippers

Air Preparation Equipment

Modular F. R.

Pressure Control Equipment

Fittings & Tubing

Flow Control Equipment

Pressure Switches/ Pressure Sensors

Dimensions

Union Elbow: 10-KQ2L



Applicable tubing O.D. (inch)	Model	Note) ϕD	L	Q	M	ϕO	ϕN	Effective area (mm ²) Urethane	Min. port size	Weight (g)
$\phi 1/8$	10-KQ2L01-00A	7.1	14.9	5.4	13.3	6	3.2	2.5	2.5	1.6
$\phi 5/32$	10-KQ2L03-00A	8.2	15.3	5.7	13.3	6	3.2	4.2	3	1.9
$\phi 3/16$	10-KQ2L05-00A	9.1	15.7	6.2	13.3	6	3.2	5.6	3.5	2.2
$\phi 1/4$	10-KQ2L07-00A	11.1	16.5	7.2	13.3	6	3.2	10	4.6	2.9
$\phi 5/16$	10-KQ2L09-00A	13.2	18.2	8.4	14.2	8	4.2	14.9	6	4.7
$\phi 3/8$	10-KQ2L11-00A	15.4	20.4	9.9	15.6	8	4.2	23.8	7	6.7
$\phi 1/2$	10-KQ2L13-00A	19.3	23.4	11.8	17	8	4.2	44.4	9.6	10.8

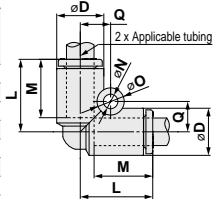

Note) ϕD is maximum diameter.

Plug-in Elbow: 10-KQ2L



Applicable tubing O.D. (inch)	Applicable fitting size ϕd (inch)	Model	Note) $\phi D1$	$\phi D2$	L ₁	L ₂	A	M	Effective area (mm ²) Urethane	Min. port size	Weight (g)
$\phi 1/8$	$\phi 1/8$	10-KQ2L01-99A	7.1	6.4	14.5	20.9	11.1	13.3	2.5	2.2	0.9
$\phi 5/32$	$\phi 5/32$	10-KQ2L03-99A	8.2	7.2	14.5	21.1	11.9	13.3	4.2	2.5	1.2
$\phi 3/16$	$\phi 3/16$	10-KQ2L05-99A	9.1	8	15	22.2	13.4	13.3	5.6	3.5	1.4
$\phi 1/4$	$\phi 1/4$	10-KQ2L07-99A	11.1	8	15.6	22.8	15	13.3	10	4.6	1.9
$\phi 5/16$	$\phi 5/16$	10-KQ2L09-99A	13.2	10	17.2	26.2	18.6	14.2	14.9	6	3
$\phi 3/8$	$\phi 3/8$	10-KQ2L11-99A	15.4	12	19.1	28	20.1	15.6	23.8	7	4.5
$\phi 1/2$	$\phi 1/2$	10-KQ2L13-99A	19.3	14	21.8	38.7	31.3	17	44.4	9.6	7.8

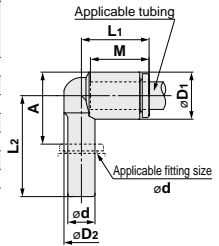

Note) $\phi D1$ is maximum diameter.

Reducer Elbow: 10-KQ2L



Applicable tubing O.D. (inch)	Applicable fitting size ϕd (inch)	Model	Note) $\phi D1$	$\phi D2$	L ₁	L ₂	A	M	Effective area (mm ²) Urethane	Min. port size	Weight (g)
$\phi 1/8$	$\phi 5/32$	10-KQ2L01-03A	7.1	6.4	14.5	23.9	14.1	13.3	2.5	2.5	1.1
	$\phi 3/16$	10-KQ2L01-05A	7.1	6.4	14.5	28.4	18.6	13.3	2.5	2.5	1.1
	$\phi 1/4$	10-KQ2L01-07A	7.1	6.4	14.5	24.5	14.7	13.3	2.5	2.5	1.1
$\phi 5/32$	$\phi 3/16$	10-KQ2L03-05A	8.2	7.2	14.8	29.1	19.9	13.3	4.2	3	1.3
	$\phi 1/4$	10-KQ2L03-07A	8.2	7.2	14.8	21.1	11.9	13.3	4.2	3	1.4
	$\phi 1/4$	10-KQ2L05-07A	9.1	8	15	21.6	12.8	13.3	5.6	3.5	1.5
$\phi 3/16$	$\phi 5/16$	10-KQ2L05-09A	9.1	8	15	30	20.3	13.3	5.6	3.5	1.9
	$\phi 5/16$	10-KQ2L07-09A	11.1	8	15.6	30.7	22	13.3	10	4.6	2.3
	$\phi 3/8$	10-KQ2L07-11A	11.1	8	15.6	31.1	21	13.3	10	4.6	3
$\phi 5/16$	$\phi 3/8$	10-KQ2L09-11A	13.2	10	18.8	34.1	25.1	14.2	14.9	6	3.7
	$\phi 1/2$	10-KQ2L09-13A	13.2	10	18.8	35.6	25.2	14.2	14.9	6	4.6
	$\phi 3/8$	10-KQ2L11-13A	15.4	12	19.1	36.5	27.2	15.6	23.8	7	5.6

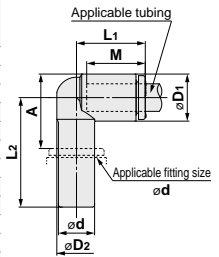

Note) $\phi D1$ is maximum diameter.

Female Elbow: 10-KQ2LF



Applicable tubing O.D. (inch)	Connection thread NPT	Model	H (Width across flats)	Note) $\phi D1$	$\phi D2$	L ₁	L ₂	M	Effective area (mm ²) Urethane	Min. port size	Weight (g)
$\phi 1/8$	1/8	10-KQ2LF01-34N	14.29	7.1	10	14.5	22.8	13.3	2.5	2.5	18.2
	1/4	10-KQ2LF01-35N	17.46	7.1	10	14.5	26.3	13.3	2.5	2.5	31.7
$\phi 5/32$	1/8	10-KQ2LF03-34N	14.29	8.2	10	14.8	22.4	13.3	4.2	3	18.3
	1/4	10-KQ2LF03-35N	17.46	8.2	10	14.8	26.9	13.3	4.2	3	31.9
$\phi 1/4$	1/8	10-KQ2LF07-34N	14.29	11.1	10	15.6	23.9	13.3	10	4.5	18.9
	1/4	10-KQ2LF07-35N	17.46	11.1	10	15.6	28.4	13.3	10	4.5	32.4
	3/8	10-KQ2LF07-36N	22.23	11.1	10	15.6	28.9	13.3	10	4.5	53.1
$\phi 3/8$	1/4	10-KQ2LF11-35N	17.46	15.4	17	19.3	27.1	15.6	23.8	7	28
	3/8	10-KQ2LF11-36N	22.23	15.4	17	19.3	33.3	15.6	23.8	7	49.6
	1/2	10-KQ2LF11-37N	23.81	15.4	17	19.3	36.3	15.6	23.8	7	56.9
$\phi 1/2$	3/8	10-KQ2LF13-36N	22.23	19.3	17	21.8	30.4	17	44.4	9.5	51.4
	1/2	10-KQ2LF13-37N	23.81	19.3	17	21.8	33.4	17	44.4	9.5	58

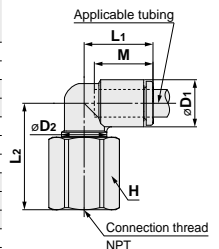

Note) $\phi D1$ is maximum diameter.

Dimensions

45° Male Elbow: 10-KQ2K (Gasket seal)



Applicable tubing O.D. (inch)	Connection thread UNF	Model	H (Width across flats)	Note) $\phi D1$	$\phi D2$	L1	L2	A	M	Effective area (mm ²) Urethane	Min. port size	Weight (g)
$\phi 1/8$	10-32UNF	10-KQ2K01-32N	7	7.1	7	14.4	13	21.9	13.3	2.5	2.5	2.8
$\phi 5/32$	10-32UNF	10-KQ2K03-32N	7	8.2	7	14.4	13	22.2	13.3	3.4	2.5	3
$\phi 1/4$	10-32UNF	10-KQ2K07-32N	7	11.1	7	14.9	16.5	26.8	13.3	3.5	2.5	3.6

Note) $\phi D1$ is maximum diameter.

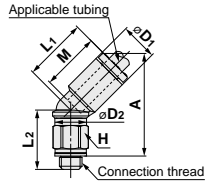

45° Male Elbow: 10-KQ2K (Sealant)



Applicable tubing O.D. (inch)	Connection thread NPT	Model	H (Width across flats)	Note) $\phi D1$	$\phi D2$	L1	L2	A*	M	Effective area (mm ²) Urethane	Min. port size	Weight (g)
$\phi 1/8$	1/8	10-KQ2K01-34NS	11.11	7.1	10	14.3	12.7	21.8	13.3	2.5	2.5	5.3
$\phi 5/32$	1/8	10-KQ2K03-34NS	11.11	8.2	10	14.4	12.7	22.2	13.3	4.2	3	5.5
$\phi 3/16$	1/8	10-KQ2K05-34NS	11.11	9.1	10	14.5	13.2	23.1	13.3	5.6	3.5	5.6
$\phi 1/4$	1/8	10-KQ2K07-34NS	11.11	11.1	10	14.8	15.2	25.8	13.3	10	4.5	6
	3/8	10-KQ2K07-36NS	17.46	11.1	10	14.8	21	30.1	13.3	10	4.5	27.8
$\phi 5/16$	1/8	10-KQ2K09-36NS	11.11	13.2	10	16	15.7	27.9	14.2	11.3	4.5	6.8
	3/8	10-KQ2K09-36NS	17.46	13.2	12	16	22.5	33.2	14.2	19.7	6	26
$\phi 3/8$	1/8	10-KQ2K11-34NS	12.7	15.4	12	18.1	21.1	35.5	15.6	21.2	6	11.7
	1/4	10-KQ2K11-35NS	17.46	15.4	17	17.7	28.6	41.5	15.6	23.8	7	21.8
$\phi 1/2$	3/8	10-KQ2K11-36NS	17.46	15.4	17	17.7	23.5	36.1	15.6	23.8	7	19.2
	1/2	10-KQ2K11-37NS	22.23	15.4	17	17.7	27.7	38.6	15.6	23.8	7	45.7
$\phi 1/2$	1/4	10-KQ2K13-35NS	17.46	19.3	17	19.4	28.7	44.1	17	44.4	9	23.8
	3/8	10-KQ2K13-36NS	17.46	19.3	17	19.4	23.6	38.7	17	44.4	9.5	19.9
	1/2	10-KQ2K13-37NS	22.23	19.3	17	19.4	27.8	41.2	17	44.4	9.5	46

* Reference dimensions after installation of NPT thread
Note) $\phi D1$ is maximum diameter.

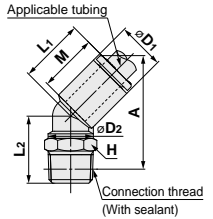

Universal Male Elbow: 10-KQ2V (Gasket seal)



Applicable tubing O.D. (inch)	Connection thread UNF	Model	H (Width across flats)	Note) $\phi D1$	$\phi D2$	L1	L2	L3	A	M	Effective area (mm ²) Urethane	Min. port size	Weight (g)
$\phi 1/8$	10-32UNF	10-KQ2V01-32N	8	7.1	9.8	17.5	10.4	17.9	14.4	13.3	1.9	2.5	5.2
$\phi 5/32$	10-32UNF	10-KQ2V03-32N	8	8.2	9.8	17.5	10.4	17.9	14.4	13.3	2.9	2.5	5.3
$\phi 1/4$	10-32UNF	10-KQ2V07-32N	8	11.1	13.4	20.6	12.1	24	20.5	13.3	2.9	2.5	12.2

Note) $\phi D1$ is maximum diameter.

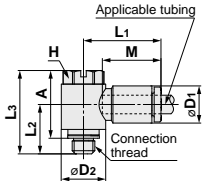

Universal Male Elbow: 10-KQ2V (Sealant)



Applicable tubing O.D. (inch)	Connection thread NPT	Model	H (Width across flats)	Note) $\phi D1$	$\phi D2$	L1	L2	L3	A*	M	Effective area (mm ²) Urethane	Min. port size	Weight (g)
$\phi 1/8$	1/8	10-KQ2V01-34NS	8	7.1	13.4	19.3	13.7	25.6	22.4	13.3	1.9	2.5	13.5
$\phi 5/32$	1/8	10-KQ2V03-34NS	8	8.2	13.4	19.3	13.7	25.6	22.4	13.3	2.9	3	13.6
$\phi 3/16$	1/8	10-KQ2V05-34NS	8	9.1	13.4	19.6	13.7	25.6	22.4	13.3	3.7	3.5	13.7
$\phi 1/4$	1/8	10-KQ2V07-34NS	8	11.1	13.4	20.6	13.7	25.6	22.4	13.3	6.6	4.5	14.1
	1/4	10-KQ2V07-35NS	8	11.1	15.3	19.9	18.7	32.1	27.7	13.3	6.6	4.5	25.6
$\phi 5/16$	1/8	10-KQ2V09-34NS	11.11	13.2	17.6	23.5	15.1	27.6	24.4	14.2	11.2	6	22.3
	1/4	10-KQ2V09-35NS	11.11	13.2	17.6	23.5	18.5	31	26.6	14.2	11.2	6	29.2
$\phi 3/8$	1/8	10-KQ2V09-36NS	12.7	13.2	20.6	23.1	19.5	35.3	30.6	14.2	11.2	6	44.1
	1/4	10-KQ2V11-35NS	12.7	15.4	20.6	25.8	19.6	34.9	30.5	15.6	19.3	7	37.5
$\phi 1/2$	3/8	10-KQ2V11-36NS	12.7	15.4	20.6	25.8	20	35.3	30.6	15.6	19.3	7	45.2
	1/2	10-KQ2V13-36NS	17.46	19.3	27	30.5	20.2	35.1	30.4	17	34.3	9	64
	1/2	10-KQ2V13-37NS	17.46	19.3	27	30.5	23.4	38.3	31.9	17	34.3	9	82.6

* Reference dimensions after installation of NPT thread
Note) $\phi D1$ is maximum diameter.

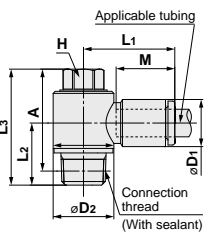

- Directional Control Valves
- Air Cylinders
- Rotary Actuators
- Air Grippers
- Air Preparation Equipment
- Modular F. R.
- Pressure Control Equipment
- Fittings & Tubing
- Flow Control Equipment
- Pressure Switches/ Pressure Sensors

Dimensions

Hexagon Socket Head Universal Male Elbow: 10-KQ2VS (Gasket seal)



Applicable tubing O.D. (inch)	Connection thread UNF	Model	H (Width across flats)	Note øD1	øD2	L1	L2	L3	A	M	Effective area (mm ²) Urethane	Min. port size	Weight (g)
ø1/8	10-32UNF	10-KQ2VS01-32N	4	7.1	9.8	17.5	10.4	18.2	14.7	13.3	1.9	2.3	5.3
ø5/32	10-32UNF	10-KQ2VS03-32N	4	8.2	9.8	17.5	10.4	18.2	14.7	13.3	2.9	2.3	5.4
ø1/4	10-32UNF	10-KQ2VS07-32N	6.35	11.1	13.4	20.6	11.1	23.2	19.7	13.3	2.9	2.5	11.3

Note) øD1 is maximum diameter.

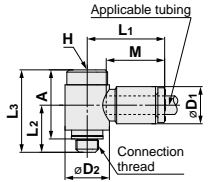

Hexagon Socket Head Universal Male Elbow: 10-KQ2VS (Sealant)



Applicable tubing O.D. (inch)	Connection thread NPT	Model	H (Width across flats)	Note øD1	øD2	L1	L2	L3	A*	M	Effective area (mm ²) Urethane	Min. port size	Weight (g)
ø1/8	1/8	10-KQ2VS01-34NS	6.35	7.1	13.4	19.3	13.7	25.8	22.6	13.3	1.9	2.5	13.1
ø5/32	1/8	10-KQ2VS03-34NS	6.35	8.2	13.4	19.3	13.7	25.8	22.6	13.3	2.9	3	13.2
ø3/16	1/8	10-KQ2VS05-34NS	6.35	9.1	13.4	19.6	13.7	25.8	22.6	13.3	3.7	3.5	13.3
ø1/4	1/8	10-KQ2VS07-34NS	6.35	11.1	13.4	20.6	13.7	25.8	22.6	13.3	6.6	4.6	13.7
	1/4	10-KQ2VS07-35NS	6.35	11.1	15.3	19.9	18.7	28.1	23.7	13.3	6.6	4.6	20.8
ø5/16	1/8	10-KQ2VS09-34NS	8	13.2	17.6	23.5	15.1	26	22.8	14.2	11.2	6	19.3
	1/4	10-KQ2VS09-35NS	8	13.2	17.6	23.5	18.5	29.5	25.1	14.2	11.2	6	24.6
	3/8	10-KQ2VS09-36NS	8	13.2	20.6	23.1	19.5	31.4	26.7	14.2	11.2	6	37.6
ø3/8	1/4	10-KQ2VS11-35NS	8	15.4	20.6	25.8	19.6	30.8	26.4	15.6	19.3	7	29
	3/8	10-KQ2VS11-36NS	8	15.4	20.6	25.8	20	31.4	26.7	15.6	19.3	7	38.6
ø1/2	3/8	10-KQ2VS13-36NS	9.53	19.3	27	30.5	20.2	33.6	28.9	17	34.3	9	59.2
	1/2	10-KQ2VS13-37NS	9.53	19.3	27	30.5	23.4	36.8	30.4	17	34.3	9	78.3

* Reference dimensions after installation of NPT thread
Note) øD1 is maximum diameter.

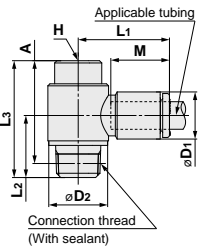

Universal Female Elbow: 10-KQ2VF (Gasket seal)



Applicable tubing O.D. (inch)	Connection thread UNF	Model	H (Width across flats)	Note øD1	øD2	L1	L2	L3	A	M	Effective area (mm ²) Urethane	Min. port size	Weight (g)
ø1/8	10-32UNF	10-KQ2VF01-32N	8	7.1	9.8	17.5	10.4	19.4	15.9	13.3	1.9	2.5	5.4
ø5/32	10-32UNF	10-KQ2VF03-32N	8	8.2	9.8	17.5	10.4	19.4	15.9	13.3	2.9	2.5	5.5
ø1/4	10-32UNF	10-KQ2VF07-32N	14.29	11.1	13.4	20.6	12.8	22.4	18.9	13.3	2.9	2.5	14.2

Note) øD1 is maximum diameter.

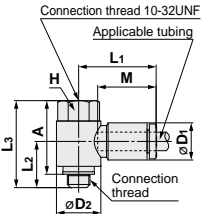

Universal Female Elbow: 10-KQ2VF (Sealant)



Applicable tubing O.D. (inch)	Connection thread NPT	Model	H (Width across flats)	Note øD1	øD2	L1	L2	L3	A*	M	Effective area (mm ²) Urethane	Min. port size	Weight (g)
ø1/8	1/8	10-KQ2VF01-34NS	14.29	7.1	13.4	19.3	14.4	28.5	25.3	13.3	1.9	2.5	18
ø5/32	1/8	10-KQ2VF03-34NS	14.29	8.2	13.4	19.3	14.4	28.5	25.3	13.3	2.9	3	18.1
ø3/16	1/8	10-KQ2VF05-34NS	14.29	9.1	13.4	19.6	14.4	28.5	25.3	13.3	3.7	3.5	18.2
ø1/4	1/8	10-KQ2VF07-34NS	14.29	11.1	13.4	20.6	14.4	28.5	25.3	13.3	6.6	4.6	18.5
	1/4	10-KQ2VF07-35NS	17.46	11.1	17.6	21.3	19.4	37.9	33.5	13.3	6.6	4.6	38.4
ø5/16	1/8	10-KQ2VF09-34NS	17.46	13.2	17.6	23.5	15.5	30	26.8	14.2	11.2	6	28.7
	1/4	10-KQ2VF09-35NS	17.46	13.2	17.6	23.5	18.9	37.9	33.5	14.2	11.2	6	39.3
	3/8	10-KQ2VF09-36NS	22.23	13.2	25.2	24.9	24	44	39.3	14.2	11.2	6	67.2
ø3/8	1/4	10-KQ2VF11-35NS	22.23	15.4	20.6	25.8	20.7	40.3	35.9	15.6	19.3	7	58.7
	3/8	10-KQ2VF11-36NS	22.23	15.4	25.2	26.3	23.2	44	39.3	15.6	19.3	7	67.9
ø1/2	3/8	10-KQ2VF13-36NS	25.4	19.3	27	30.5	21.2	40.7	36	17	34.3	9	69.8
	1/2	10-KQ2VF13-37NS	25.4	19.3	27	30.5	24.4	48.9	42.5	17	34.3	9	105.7

* Reference dimensions after installation of NPT thread
Note) øD1 is maximum diameter.

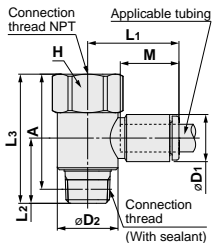

Dimensions

Double Universal Male Elbow: 10-KQ2VD (Gasket seal)



Applicable tubing O.D. (inch)	Connection thread UNF	Model	H (Width across flats)	Note) ϕD_1	ϕD_2	L ₁	L ₂	L ₃	A	M	P	Effective area (mm ²) Urethane	Min. port size	Weight (g)
$\phi 1/8$	10-32UNF	10-KQ2VD01-32N	14.29	7.1	13.4	19.3	15.2	37.9	34.4	13.3	13.4	1.9	2.3	24.4
$\phi 5/32$	10-32UNF	10-KQ2VD03-32N	14.29	8.2	13.4	19.3	15.2	37.9	34.4	13.3	13.4	2.5	2.3	24.6
$\phi 1/4$	10-32UNF	10-KQ2VD07-32N	14.29	11.1	13.4	20.6	15.6	38.7	35.2	13.3	13.8	2.5	2.3	26.9

Note) ϕD_1 is maximum diameter.

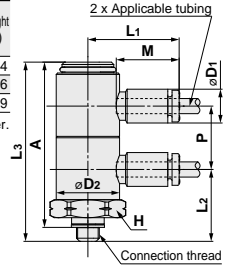

Double Universal Male Elbow: 10-KQ2VD (Sealant)



Applicable tubing O.D. (inch)	Connection thread NPT	Model	H (Width across flats)	Note) ϕD_1	ϕD_2	L ₁	L ₂	L ₃	A*	M	P	Effective area (mm ²) Urethane	Min. port size	Weight (g)
$\phi 1/8$	1/8	10-KQ2VD01-34NS	14.29	7.1	13.4	19.3	16.3	39	35.8	13.3	13.4	1.9	2.5	20
$\phi 5/32$	1/8	10-KQ2VD03-34NS	14.29	8.2	13.4	19.3	16.3	39	35.8	13.3	13.4	2.9	3	20.2
$\phi 3/16$	1/8	10-KQ2VD05-34NS	14.29	9.1	13.4	19.6	16.3	39	35.8	13.3	13.4	3.7	3.5	23.3
	1/8	10-KQ2VD07-34NS	14.29	11.1	13.4	20.6	17.7	40.8	37.6	13.3	13.8	6.6	4.6	23.3
$\phi 1/4$	1/4	10-KQ2VD07-35NS	14.29	11.1	13.4	20.6	21.1	44.2	39.8	13.3	13.8	6.6	4.6	30.1
	3/8	10-KQ2VD07-36NS	17.46	11.1	13.4	20.6	22.5	45.6	40.9	13.3	13.8	6.6	4.6	42.5
	1/4	10-KQ2VD09-35NS	19	13.2	17.6	23.7	22.4	49.2	44.8	14.2	15.9	11.2	6	45
$\phi 5/16$	3/8	10-KQ2VD09-36NS	19	13.2	17.6	23.7	23	49.8	45.1	14.2	15.9	11.2	6	53.2
	1/2	10-KQ2VD09-37NS	22.23	13.2	17.6	23.7	27.2	54	47.6	14.2	15.9	11.2	6	79.7
	1/4	10-KQ2VD11-35NS	22.23	15.4	20.6	25.3	24.4	56.3	51.9	15.6	19.2	19.3	7	65.5
$\phi 3/8$	3/8	10-KQ2VD11-36NS	22.23	15.4	20.6	25.3	24.8	56.7	52	15.6	19.2	19.3	7	67.6
	1/2	10-KQ2VD11-37NS	22.23	15.4	20.6	25.3	28.7	60.6	54.2	15.6	19.2	19.3	7	87.7
	3/8	10-KQ2VD13-36NS	25.4	19.3	27	30.5	29.6	64.4	59.7	17	22.3	34.3	9.6	128.6
$\phi 1/2$	1/2	10-KQ2VD13-37NS	25.4	19.3	27	30.5	32.8	67.6	61.2	17	22.3	34.3	9.6	146.3

* Reference dimensions after installation of NPT thread
Note) ϕD_1 is maximum diameter.

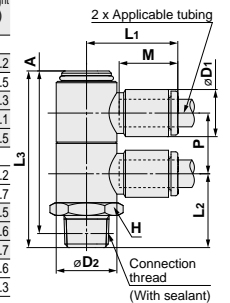

- Directional Control Valves
- Air Cylinders
- Rotary Actuators
- Air Grippers
- Air Preparation Equipment
- Modular F. R.
- Pressure Control Equipment
- Fittings & Tubing
- Flow Control Equipment
- Pressure Switches/ Pressure Sensors

Dimensions

Triple Universal Male Elbow: 10-KQ2VT (Gasket seal)



Applicable tubing O.D. (inch)	Connection thread	Model	H (Width across flats)	(Note) ϕD_1	ϕD_2	L1	L2	L3	A	M	P	Effective area (mm ²) Urethane	Min. port size	Weight (g)
$\phi 1/8$	10-32UNF	10-KQ2VT01-32N	14.29	7.1	13.4	19.3	15.7	51.9	48.4	13.3	13.4	1.9	2.5	32.4
$\phi 5/32$	10-32UNF	10-KQ2VT03-32N	14.29	8.2	13.4	19.3	15.7	51.9	48.4	13.3	13.4	2.9	2.5	32.7
$\phi 1/4$	10-32UNF	10-KQ2VT07-32N	14.29	11.1	13.4	20.6	16.1	53	49.5	13.3	13.8	2.3	2.5	35.4

(Note) ϕD_1 is maximum diameter.

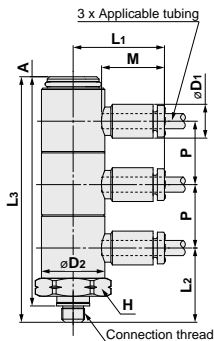

Triple Universal Male Elbow: 10-KQ2VT (Sealant)



Applicable tubing O.D. (inch)	Connection thread	Model	H (Width across flats)	(Note) ϕD_1	ϕD_2	L1	L2	L3	A*	M	P	Effective area (mm ²) Urethane	Min. port size	Weight (g)
$\phi 1/8$	1/8	10-KQ2VT01-34NS	14.29	7.1	13.4	19.3	16.3	52.5	49.3	13.3	13.4	1.9	2.5	25.5
$\phi 5/32$	1/8	10-KQ2VT03-34NS	14.29	8.2	13.4	19.3	16.3	52.5	49.3	13.3	13.4	2.9	3	25.8
$\phi 3/16$	1/8	10-KQ2VT05-34NS	14.29	9.1	13.4	19.6	16.3	52.5	49.3	13.3	13.4	3.7	3.5	26.2
$\phi 1/4$	1/8	10-KQ2VT07-34NS	14.29	11.1	13.4	20.6	17.7	54.6	51.4	13.3	13.8	6.6	4.6	29.7
	3/8	10-KQ2VT07-35NS	14.29	11.1	13.4	20.6	21.1	58	53.6	13.3	13.8	6.6	4.6	36.6
$\phi 5/16$	1/4	10-KQ2VT07-36NS	17.46	11.1	13.4	20.6	22.5	59.4	54.7	13.3	13.8	6.6	4.6	49
	3/8	10-KQ2VT09-36NS	17.46	13.2	17.6	23.7	22.4	65.2	60.8	14.2	15.9	11.2	6	55.4
$\phi 3/8$	1/2	10-KQ2VT09-37NS	19	13.2	17.6	23.7	23	65.8	61.1	14.2	15.9	11.2	6	65.3
	3/4	10-KQ2VT11-35NS	22.23	13.2	17.6	23.7	27.2	70	63.6	14.2	15.9	11.2	6	91.8
$\phi 1/2$	1/4	10-KQ2VT11-36NS	22.23	15.4	20.6	25.3	24.4	75.6	71.2	15.6	19.2	19.3	7	84.2
	3/8	10-KQ2VT11-36NS	22.23	15.4	20.6	25.3	24.8	76	71.3	15.6	19.2	19.3	7	91.8
$\phi 3/4$	1/2	10-KQ2VT11-37NS	22.23	15.4	20.6	25.3	28.7	79.9	73.5	15.6	19.2	19.3	7	104.4
	3/4	10-KQ2VT13-36NS	25.4	19.3	27	30.5	29.6	86.8	82.1	17	22.3	34.3	9.6	169.3
$\phi 1$	1/2	10-KQ2VT13-37NS	25.4	19.3	27	30.5	32.8	90	83.6	17	22.3	34.3	9.6	187

* Reference dimensions after installation of NPT thread
 (Note) ϕD_1 is maximum diameter.

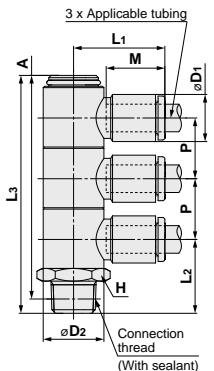

Dimensions

Branch Universal Male Elbow: 10-KQZ2 (Gasket seal)



Applicable tubing O.D. (inch)	Connection thread UNF	Model	H (Width across flats)	Note) ϕD_1	ϕD_2	L1	L2	L3	A	M	P	Effective area (mm ²) Urethane	Min. port size	Weight (g)
$\phi 1/8$	10-32UNF	10-KQZ201-32N	8	7.1	9.8	16.5	10.4	17.9	14.4	13.3	7.1	1.9	2.5	5.9
$\phi 5/32$	10-32UNF	10-KQZ203-32N	8	8.2	9.8	16.5	10.4	17.9	14.4	13.3	8.2	2.9	2.5	6.2
$\phi 1/4$	10-32UNF	10-KQZ207-32N	8	11.1	13.4	18.4	12.1	24	20.5	13.3	11.1	2.9	2.5	13.4

Note) ϕD_1 is maximum diameter.

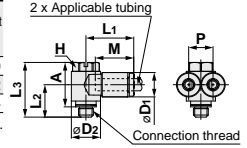

Branch Universal Male Elbow: 10-KQZ2 (Sealant)



Applicable tubing O.D. (inch)	Connection thread NPT	Model	H (Width across flats)	Note) ϕD_1	ϕD_2	L1	L2	L3	A*	M	P	Effective area (mm ²) Urethane	Min. port size	Weight (g)
$\phi 1/8$	1/8	10-KQZ201-34NS	8	7.1	13.4	18.5	13.7	25.6	22.4	13.3	7.1	1.9	2.5	14.1
$\phi 5/32$	1/8	10-KQZ203-34NS	8	8.2	13.4	18.5	13.7	25.6	22.4	13.3	8.2	2.9	3	14.4
$\phi 3/16$	1/8	10-KQZ207-34NS	8	9.1	13.4	18.4	13.7	25.6	22.4	13.3	9.1	3.7	3.5	14.7
$\phi 1/4$	1/8	10-KQZ207-34NS	8	11.1	13.4	18.4	13.7	25.6	22.4	13.3	11.1	6.6	4.5	15.2
	1/4	10-KQZ207-35NS	11.1	11.1	17.6	20.4	18	31	26.6	13.3	11.1	6.6	4.5	29.5
$\phi 5/16$	1/8	10-KQZ209-34NS	11.1	13.2	17.6	21.2	15.1	27.6	24.4	14.2	13.2	14.2	6	24.1
	1/4	10-KQZ209-35NS	11.1	13.2	17.6	21.2	18.5	31	26.6	14.2	13.2	14.2	6	31
$\phi 3/8$	3/8	10-KQZ209-36NS	12.7	13.2	20.6	22.3	19.5	35.3	30.6	14.2	13.2	14.2	6	46
	1/4	10-KQZ211-35NS	12.7	15.4	20.6	25.9	19.1	34.9	30.5	15.6	15.4	19.3	7	40.7
$\phi 3/8$	3/8	10-KQZ211-36NS	12.7	15.4	20.6	25.9	19.5	35.3	30.6	15.6	15.4	19.3	7	48.4
	3/8	10-KQZ213-36NS	17.46	19.3	27	30.1	20.2	35.1	30.4	17	19.3	34.3	9	69.5
$\phi 1/2$	1/2	10-KQZ213-37NS	17.46	19.3	27	30.1	23.4	38.3	31.9	17	19.3	34.3	9	88.1

* Reference dimensions after installation of NPT thread
Note) ϕD_1 is maximum diameter.

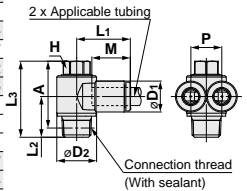

Double Branch Universal Male Elbow: 10-KQZ2D (Sealant)



Applicable tubing O.D. (inch)	Connection thread NPT	Model	H (Width across flats)	Note) ϕD_1	ϕD_2	L1	L2	L3	A*	M	P1	P2	Effective area (mm ²) Urethane	Min. port size	Weight (g)
$\phi 1/8$	1/8	10-KQZ2D01-34NS	14.29	7.1	13.4	18.5	16.3	39	35.8	13.3	13.4	7.1	1.9	2.5	21.2
$\phi 5/32$	1/8	10-KQZ2D03-34NS	14.29	8.2	13.4	18.5	16.3	39	35.8	13.3	13.4	8.2	2.9	3	21.8
$\phi 3/16$	1/8	10-KQZ2D05-34NS	14.29	9.1	13.4	18.4	16.3	39	35.8	13.3	13.4	9.1	3.7	3.5	22.4
	1/8	10-KQZ2D07-34NS	14.29	11.1	13.4	18.3	17.7	40.8	37.6	13.3	13.8	11.1	6.6	4.6	25.5
$\phi 1/4$	1/4	10-KQZ2D07-35NS	14.29	11.1	13.4	18.3	21.1	44.2	39.8	13.3	13.8	11.1	6.6	4.6	32.4
	3/8	10-KQZ2D07-36NS	17.46	11.1	13.4	18.3	22.5	45.6	40.9	13.3	13.8	11.1	6.6	4.6	44.8
$\phi 5/16$	1/4	10-KQZ2D09-35NS	19	13.2	17.6	21.95	22.4	49.2	44.8	14.2	15.9	13.2	14.2	6	48.7
	3/8	10-KQZ2D09-36NS	19	13.2	17.6	21.95	23	49.8	45.1	14.2	15.9	13.2	14.2	6	56.8
$\phi 3/8$	1/2	10-KQZ2D09-37NS	22.23	13.2	17.6	21.95	27.2	54	47.6	14.2	15.9	13.2	14.2	6	83.3
	1/4	10-KQZ2D11-35NS	22.23	15.4	20.6	23.6	24.4	56.3	51.9	15.6	19.2	15.4	19.3	7	71.1
$\phi 3/8$	3/8	10-KQZ2D11-36NS	22.23	15.4	20.6	23.6	24.8	56.7	52	15.6	19.2	15.4	19.3	7	73.2
	1/2	10-KQZ2D11-37NS	22.23	15.4	20.6	23.6	28.7	60.6	54.2	15.6	19.2	15.4	19.3	7	93.3
$\phi 1/2$	3/8	10-KQZ2D13-36NS	25.4	19.3	27	27.9	29.6	64.4	59.7	17	22.3	19.3	34.3	9.6	137.2
	1/2	10-KQZ2D13-37NS	25.4	19.3	27	27.9	32.8	67.6	61.2	17	22.3	19.3	34.3	9.6	155

* Reference dimensions after installation of NPT thread
Note) ϕD_1 is maximum diameter.

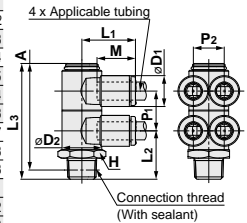

Dimensions

Triple Universal Male Elbow: 10-KQ2ZT (Sealant)



Applicable tubing O.D. (inch)	Connection thread	Model	H (Width across flats)	Note) øD1	øD2	L1	L2	A*	M	P1	P2	Effective area (mm ²) Urethane	Min. port size	Weight (g)	
ø1/8	1/8	10-KQ2ZT01-34NS	14.29	7.1	13.4	18.5	16.3	52.5	49.3	13.3	13.4	7.1	1.9	2.5	27.3
ø5/32	1/8	10-KQ2ZT03-34NS	14.29	8.2	13.4	18.5	16.3	52.5	49.3	13.3	13.4	8.2	2.9	3	28.2
ø3/16	1/8	10-KQ2ZT05-34NS	14.29	9.1	13.4	18.4	16.3	52.5	49.3	13.3	13.4	9.1	3.7	3.5	29
ø1/4	1/8	10-KQ2ZT07-34NS	14.29	11.1	13.4	18.3	17.7	54.6	51.4	13.3	13.8	11.1	6.6	4.6	33.1
	1/4	10-KQ2ZT07-35NS	14.29	11.1	13.4	18.3	21.1	58	53.6	13.3	13.8	11.1	6.6	4.6	40
	3/8	10-KQ2ZT07-36NS	17.46	11.1	13.4	18.3	22.5	59.4	54.7	13.3	13.8	11.1	6.6	4.6	52.4
ø5/16	1/4	10-KQ2ZT09-35NS	17.46	13.2	17.6	21.2	22.4	65.2	60.8	14.2	15.9	13.2	14.2	6	60.9
	3/8	10-KQ2ZT09-36NS	19	13.2	17.6	21.2	23	65.8	61.1	14.2	15.9	13.2	14.2	6	70.8
	1/2	10-KQ2ZT09-37NS	22.23	13.2	17.6	21.2	27.2	70	63.6	14.2	15.9	13.2	14.2	6	97.3
ø3/8	1/4	10-KQ2ZT11-35NS	22.23	15.4	20.6	23.6	24.4	75.6	71.2	15.6	19.2	15.4	19.3	7	100.2
	3/8	10-KQ2ZT11-36NS	22.23	15.4	20.6	23.6	24.8	76	71.3	15.6	19.2	15.4	19.3	7	100.2
	1/2	10-KQ2ZT11-37NS	22.23	15.4	20.6	23.6	28.7	79.9	73.5	15.6	19.2	15.4	19.3	7	100.2
ø1/2	3/8	10-KQ2ZT13-36NS	25.4	19.3	27	27.9	29.6	86.8	82.1	17	22.3	19.3	34.3	9.6	182.3
	1/2	10-KQ2ZT13-37NS	25.4	19.3	27	27.9	32.8	90	83.6	17	22.3	19.3	34.3	9.6	200

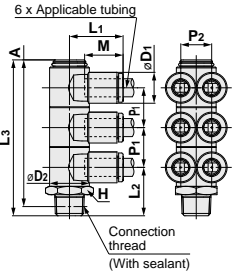

* Reference dimensions after installation of NPT thread
Note) øD1 is maximum diameter.

Extended Male Elbow: 10-KQ2W (Gasket seal)



Applicable tubing O.D. (inch)	Connection thread	Model	H (Width across flats)	Note) øD1	øD2	L1	L2	A	M	Effective area (mm ²) Urethane	Min. port size	Weight (g)
ø1/8	10-32UNF	10-KQ2W01-32N	7	7.1	7	15.3	25.8	25.9	13.3	2.4	2.5	5.9
ø5/32	10-32UNF	10-KQ2W03-32N	7	8.2	7	15.4	26.3	26.9	13.3	3	2.5	6
ø1/4	10-32UNF	10-KQ2W07-32N	7	11.1	7	15.4	27.6	29.7	13.3	3.5	2.5	6.4

Note) øD1 is maximum diameter.

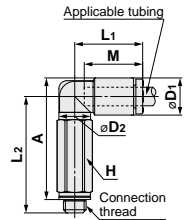

Extended Male Elbow: 10-KQ2W (Sealant)



Applicable tubing O.D. (inch)	Connection thread	Model	H (Width across flats)	Note) øD1	øD2	L1	L2	A*	M	Effective area (mm ²) Urethane	Min. port size	Weight (g)
ø1/8	1/16	10-KQ2W01-33NS	11.11	7.1	10	14.5	35.9	35.4	13.3	2.4	2.5	16.6
	1/8	10-KQ2W01-34NS	11.11	7.1	10	14.5	30.3	30.7	13.3	2.4	2.5	13.9
	1/4	10-KQ2W01-35NS	14.29	7.1	10	14.5	32.7	31.9	13.3	2.4	2.5	27.3
ø5/32	1/16	10-KQ2W03-33NS	11.11	8.2	10	14.8	35.4	35.4	13.3	4	3	16.7
	1/8	10-KQ2W03-34NS	11.11	8.2	10	14.8	29.9	30.8	13.3	4	3	14.1
	1/4	10-KQ2W03-35NS	14.29	8.2	10	14.8	33.2	32.9	13.3	4	3	27.5
ø3/16	1/8	10-KQ2W05-34NS	11.11	9.1	10	15	30.4	31.7	13.3	5.6	3.5	14.3
	1/4	10-KQ2W05-35NS	14.29	9.1	10	15	33.7	33.9	13.3	5.6	3.5	27.7
	1/16	10-KQ2W07-33NS	11.11	11.1	10	15.6	36.9	38.4	13.3	6.8	3.5	17.3
ø1/4	1/8	10-KQ2W07-34NS	11.11	11.1	10	15.6	31.4	33.7	13.3	10	4.5	14.6
	1/4	10-KQ2W07-35NS	14.29	11.1	10	15.6	34.7	35.9	13.3	10	4.5	28
	3/8	10-KQ2W07-36NS	17.46	11.1	10	15.6	36.1	37	13.3	10	4.5	50.2
ø5/16	1/8	10-KQ2W09-34NS	11.11	13.2	10	16.4	32.4	35.8	14.2	11.3	4.5	15.4
	1/4	10-KQ2W09-35NS	14.29	13.2	12	17.2	37.8	40	14.2	14.2	6	26.5
	3/8	10-KQ2W09-36NS	17.46	13.2	12	17.2	39.2	41.1	14.2	14.2	6	50
ø3/8	1/4	10-KQ2W11-36NS	17.46	15.4	17	19.3	48.3	51.6	15.6	23.8	7.5	54.3
	3/8	10-KQ2W11-36NS	17.46	15.4	17	19.3	45.1	48.1	15.6	23.8	7.5	37.8
	1/2	10-KQ2W11-37NS	22.23	15.4	17	19.3	49.3	50.6	15.6	23.8	7.5	86.5
ø1/2	1/4	10-KQ2W13-35NS	17.46	19.3	17	21.5	50.2	55.5	17	44.4	9	56.6
	3/8	10-KQ2W13-36NS	17.46	19.3	17	21.8	46	51	17	44.4	9.5	42.8
	1/2	10-KQ2W13-37NS	22.23	19.3	17	21.8	50.2	53.5	17	44.4	9.5	95.5

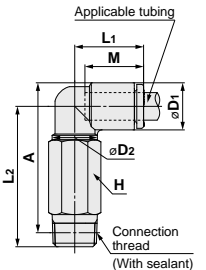

* Reference dimensions after installation of NPT thread
Note) øD1 is maximum diameter.

Dimensions

Male Branch Tee: 10-KQ2T (Gasket seal)



Applicable tubing O.D. (inch)	Connection thread UNF	Model	H (Width across flats)	Note) ϕD_1	ϕD_2	L ₁	L ₂	A	M	Effective area (mm ²) Urethane	Min. port size	Weight (g)
$\phi 1/8$	10-32UNF	10-KQ2T01-32N	7	7.1	7	15.3	14.2	14.2	13.3	2.7	2.5	3.5
$\phi 5/32$	10-32UNF	10-KQ2T03-32N	7	8.2	7	15.4	14.7	15.3	13.3	4.5	2.5	3.8
$\phi 1/4$	10-32UNF	10-KQ2T07-32N	7	11.1	7	15.4	16	18	13.3	4.5	2.5	4.7

Note) ϕD_1 is maximum diameter.

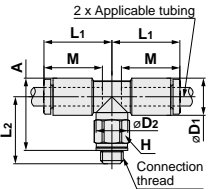

Male Branch Tee: 10-KQ2T (Sealant)



Applicable tubing O.D. (inch)	Connection thread NPT	Model	H (Width across flats)	Note) ϕD_1	ϕD_2	L ₁	L ₂	A*	M	Effective area (mm ²) Urethane	Min. port size	Weight (g)
$\phi 1/8$	1/16	10-KQ2T01-33NS	11.11	7.1	10	14.5	24.2	23.7	13.3	2.9	2.5	9.7
	1/8	10-KQ2T01-34NS	11.11	7.1	10	14.5	16.6	17	13.3	2.9	2.5	6
	1/4	10-KQ2T01-35NS	14.29	7.1	10	14.5	21	20.2	13.3	2.9	2.5	15.6
$\phi 5/32$	1/16	10-KQ2T03-33NS	11.11	8.2	10	14.8	23.8	23.8	13.3	4.1	3	10
	1/8	10-KQ2T03-34NS	11.11	8.2	10	14.8	16.2	17.1	13.3	4.1	3	6.3
$\phi 3/16$	1/4	10-KQ2T03-35NS	14.29	8.2	10	14.8	21.6	21.3	13.3	4.1	3	15.9
	1/8	10-KQ2T05-34NS	11.11	9.1	10	15	16.7	18	13.3	7	3.5	6.6
	1/4	10-KQ2T05-35NS	14.29	9.1	10	15	22.1	22.2	13.3	7	3.5	16.2
$\phi 1/4$	1/16	10-KQ2T07-33NS	11.11	11.1	10	15.6	25.3	26.8	13.3	8.5	3.5	11
	1/8	10-KQ2T07-34NS	11.11	11.1	10	15.6	17.7	20	13.3	12.4	4.5	7.3
	1/4	10-KQ2T07-35NS	14.29	11.1	10	15.6	23.1	24.2	13.3	12.4	4.5	16.9
	3/8	10-KQ2T07-36NS	17.46	11.1	10	15.6	24.5	25.3	13.3	12.4	4.5	29.2
$\phi 5/16$	1/8	10-KQ2T09-34NS	11.11	13.2	10	16.4	18.7	22.1	14.2	14	4.5	8.7
	1/4	10-KQ2T09-35NS	14.29	13.2	12	17.2	24.1	26.3	14.2	18.2	6	15.9
	3/8	10-KQ2T09-36NS	17.46	13.2	12	17.2	25.5	27.4	14.2	18.2	6	27.9
$\phi 3/8$	1/8	10-KQ2T11-34NS	12.7	15.4	12	18.6	23.1	27.6	15.6	21.2	6	14.4
	1/4	10-KQ2T11-35NS	17.46	15.4	17	19.3	28.5	31.8	15.6	23.8	7.5	24.1
	3/8	10-KQ2T11-36NS	17.46	15.4	17	19.3	29.1	32.1	15.6	23.8	7.5	22.2
$\phi 1/2$	1/2	10-KQ2T11-37NS	22.23	15.4	17	19.3	33.3	34.6	15.6	23.8	7.5	48.7
	1/4	10-KQ2T13-35NS	17.46	19.3	17	21.5	30.4	35.7	17	50.6	9	28.1
	3/8	10-KQ2T13-36NS	17.46	19.3	17	21.8	26.2	31.2	17	50.6	9.5	24.4
	1/2	10-KQ2T13-37NS	22.23	19.3	17	21.8	30.4	33.7	17	50.6	9.5	50.5

* Reference dimensions after installation of NPT thread
Note) ϕD_1 is maximum diameter.

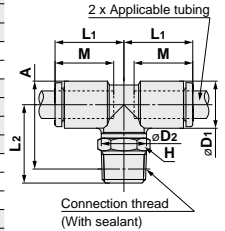

Directional Control Valves
Air Cylinders
Rotary Actuators
Air Grippers
Air Preparation Equipment
Modular F. R.
Pressure Control Equipment
Flow Control Equipment
Fittings & Tubing
Pressure Switches/ Pressure Sensors

Dimensions

Union Tee: 10-KQ2T



Applicable tubing O.D. (inch)	Model	Note) ϕD	L ₁	L ₂	M	Q	ϕO	ϕN	Effective area (mm ²) Urethane	Min. port size	Weight (g)
$\phi 1/8$	10-KQ2T01-00A	7.1	14.9	18.5	13.3	5.4	6	3.2	2.9	2.5	2.3
$\phi 5/32$	10-KQ2T03-00A	8.2	15.3	19.4	13.3	5.7	6	3.2	4.4	3	2.8
$\phi 3/16$	10-KQ2T05-00A	9.1	15.7	20.3	13.3	6.2	6	3.2	7	3.5	3.2
$\phi 1/4$	10-KQ2T07-00A	11.1	16.5	22.1	13.3	7.2	6	3.2	12.4	4.6	4.3
$\phi 5/16$	10-KQ2T09-00A	13.2	18.2	24.8	14.2	8.4	8	4.2	17.7	6	7
$\phi 3/8$	10-KQ2T11-00A	15.4	20.4	28.1	15.6	9.9	8	4.2	23.8	7	10.2
$\phi 1/2$	10-KQ2T13-00A	19.3	23.4	33	17	11.8	8	4.2	50.6	9.6	16.9

Note) ϕD is maximum diameter.

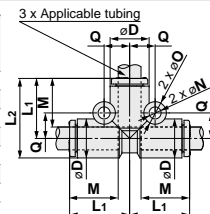

Different Diameter Tee: 10-KQ2T



Applicable tubing O.D. (inch)	Model	Note) ϕD_1	ϕD_2	L ₁	L ₂	L ₃	M ₁	M ₂	Q ₁	Q ₂	ϕO	ϕN	Effective area (mm ²) Urethane	Min. port size	Weight (g)
(a) (b)															
$\phi 1/8$	$\phi 5/32$ 10-KQ2T01-03A	8.2	7.1	14.9	15.3	18.5	13.3	13.3	5.4	5.8	6	3.2	3.5	3	2.6
	$\phi 1/4$ 10-KQ2T01-07A	11.1	7.1	14.9	16.5	18.5	13.3	13.3	5.3	7.2	6	3.2	3.5	3.2	2.8
	$\phi 3/16$ 10-KQ2T03-05A	9.1	8.2	15.3	15.7	19.4	13.3	13.3	5.7	6.2	6	3.2	6.6	3.5	2.6
$\phi 5/32$	$\phi 1/4$ 10-KQ2T03-07A	11.1	8.2	15.3	16.5	19.4	13.3	13.3	5.7	7.2	6	3.2	6.6	4.1	3
$\phi 3/16$	$\phi 1/4$ 10-KQ2T05-07A	11.1	9.1	15.7	16.5	20.3	13.3	13.3	6.2	7.2	6	3.2	7	4.6	3.7
	$\phi 5/16$ 10-KQ2T05-09A	13.2	11.1	17.4	17.3	23	14.2	13.3	7.4	8.4	8	4.2	12.4	6	5.6
$\phi 1/4$	$\phi 3/8$ 10-KQ2T07-09A	15.4	11.1	18.8	18.1	24.4	15.6	13.3	7.7	9.9	8	4.2	12.4	6.4	6.8
	$\phi 3/8$ 10-KQ2T07-11A	15.4	11.1	18.8	18.1	24.4	15.6	13.3	7.7	9.9	8	4.2	12.4	6.4	6.8
	$\phi 3/8$ 10-KQ2T09-11A	15.4	13.2	19.6	19	26.2	15.6	14.2	8.7	9.9	8	4.2	18.3	7	8.2
$\phi 5/16$	$\phi 1/2$ 10-KQ2T09-13A	19.3	13.2	21	20.6	27.6	17	14.2	8.7	11.8	8	4.2	18.3	8.1	10.6
$\phi 3/8$	$\phi 1/2$ 10-KQ2T11-13A	19.3	15.4	21.8	22	29.5	17	15.6	9.9	11.8	8	4.2	23.8	9.6	12.4

Note) ϕD_1 is maximum diameter.

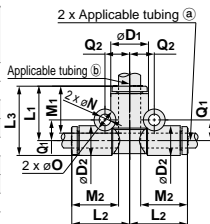

Cross: 10-KQ2TW



Applicable tubing O.D. (inch)	Model	Note) ϕD	L	Q	M	ϕO	ϕN	Effective area (mm ²) Urethane	Min. port size	Weight (g)
$\phi 5/32$	10-KQ2TW03-00A	8.2	15.3	5.7	13.3	6	3.2	4.4	3	3.5
$\phi 1/4$	10-KQ2TW07-00A	11.1	16.5	7.2	13.3	6	3.2	12.4	4.6	5.4
$\phi 5/16$	10-KQ2TW09-00A	13.2	18.2	8.4	14.2	8	4.2	17.7	6	8.5
$\phi 3/8$	10-KQ2TW11-00A	15.4	20.4	9.9	15.6	8	4.2	23.8	7	12
$\phi 1/2$	10-KQ2TW13-00A	19.3	23.4	11.8	17	8	4.2	50.6	9.6	19.7

Note) ϕD is maximum diameter.

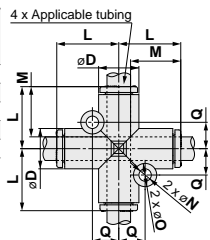

Dimensions

Male Run Tee: 10-KQ2Y (Gasket seal)



Applicable tubing O.D. (inch)	Connection thread UNF	Model	H (Width across flats)	Note) ϕD_1	ϕD_2	L ₁	L ₂	L ₃	A	M	Effective area (mm ²) Urethane	Min. port size	Weight (g)
$\phi 1/8$	10-32UNF	10-KQ2Y01-32N	7	7.1	7	15.3	14.2	15.3	26	13.3	2.7	2.5	3.5
$\phi 5/32$	10-32UNF	10-KQ2Y03-32N	7	8.2	7	15.4	14.7	15.4	26.6	13.3	4.5	2.5	3.8
$\phi 1/4$	10-32UNF	10-KQ2Y07-32N	7	11.1	7	16.5	16	16.5	29	13.3	4.5	2.5	4.7

Note) ϕD_1 is maximum diameter.

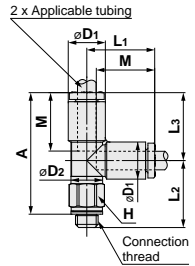

Male Run Tee: 10-KQ2Y (Sealant)



Applicable tubing O.D. (inch)	Connection thread NPT	Model	H (Width across flats)	Note) ϕD_1	ϕD_2	L ₁	L ₂	L ₃	A*	M	Effective area (mm ²) Urethane	Min. port size	Weight (g)
$\phi 1/8$	1/16	10-KQ2Y01-33NS	11.11	7.1	10	14.9	24.2	14.9	35.1	13.3	2.9	2.5	9.8
	1/8	10-KQ2Y01-34NS	11.11	7.1	10	14.9	16.6	14.9	28.4	13.3	2.9	2.5	6.1
	1/4	10-KQ2Y01-35NS	14.29	7.1	10	14.9	21	14.9	31.6	13.3	2.9	2.5	15.6
$\phi 5/32$	1/16	10-KQ2Y03-33NS	11.11	8.2	10	15.3	23.8	15.3	35	13.3	4.4	3	10.1
	1/8	10-KQ2Y03-34NS	11.11	8.2	10	15.3	16.2	15.3	28.3	13.3	4.4	3	6.4
$\phi 1/4$	1/4	10-KQ2Y03-35NS	14.29	8.2	10	15.3	21.6	15.3	32.5	13.3	4.4	3	15.9
	1/8	10-KQ2Y05-34NS	11.11	9.1	10	15.7	16.7	15.7	29.2	13.3	7	3.5	6.7
$\phi 3/16$	1/4	10-KQ2Y05-35NS	14.29	9.1	10	15.7	22.1	15.7	33.4	13.3	7	3.5	16.3
	1/16	10-KQ2Y07-33NS	11.11	11.1	10	16.5	25.3	16.5	37.7	13.3	8.5	3.5	11
$\phi 1/4$	1/8	10-KQ2Y07-34NS	11.11	11.1	10	16.5	17.7	16.5	31	13.3	12.4	4.5	7.3
	1/4	10-KQ2Y07-35NS	14.29	11.1	10	16.5	23.1	16.5	35.2	13.3	12.4	4.5	16.9
	3/8	10-KQ2Y07-36NS	17.46	11.1	10	16.5	24.5	16.5	36.3	13.3	12.4	4.5	29.2
$\phi 5/16$	1/8	10-KQ2Y09-34NS	11.11	13.2	10	18.2	18.7	18.2	33.7	14.2	14	4.5	8.8
	1/4	10-KQ2Y09-35NS	14.29	13.2	12	18.2	24.1	18.2	37.9	14.2	17.7	6	16
	3/8	10-KQ2Y09-36NS	17.46	13.2	12	18.2	25.5	18.2	39	14.2	17.7	6	28
$\phi 3/8$	1/4	10-KQ2Y11-35NS	17.46	15.4	17	20.4	28.5	20.4	44.5	15.6	23.8	7.5	24.3
	3/8	10-KQ2Y11-36NS	17.46	15.4	17	20.4	29.1	20.4	44.8	15.6	23.8	7.5	22.3
$\phi 1/2$	1/4	10-KQ2Y13-35NS	22.23	15.4	17	20.4	33.3	20.4	47.3	15.6	23.8	7.5	48.8
	3/8	10-KQ2Y13-36NS	17.46	19.3	17	23.4	30.4	23.4	49.4	17	50.6	9	28.5
$\phi 1/2$	3/8	10-KQ2Y13-36NS	17.46	19.3	17	23.4	26.2	23.4	44.9	17	50.6	9.5	24.7
	1/2	10-KQ2Y13-37NS	22.23	19.3	17	23.4	30.4	23.4	47.4	17	50.6	9.5	50.7

* Reference dimensions after installation of NPT thread
Note) ϕD_1 is maximum diameter.

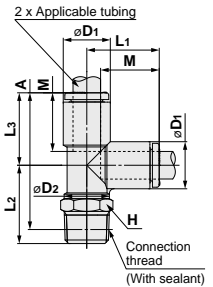

Directional Control Valves

Air Cylinders

Rotary Actuators

Air Grippers

Air Preparation Equipment

Modular F. R.

Pressure Control Equipment

Fittings & Tubing

Flow Control Equipment

Pressure Switches/ Pressure Sensors

Dimensions

Branch "Y": 10-KQ2U (Gasket seal)



Applicable tubing O.D. (inch)	Connection thread UNF	Model	H (Width across flats)	Note) ϕD	L	P	A	M	Q	ϕN	ϕO	Effective area (mm ²) Urethane	Min. port size	Weight (g)
$\phi 1/8$	10-32UNF	10-KQ2U01-32N	8	7.1	33.8	7.1	30.3	13.3	5.2	6	3.2	2.2	1.8	5
$\phi 5/32$	10-32UNF	10-KQ2U03-32N	10	8.2	33.9	8.2	30.4	13.3	5.7	6	3.2	2.2	1.8	6.6
$\phi 1/4$	10-32UNF	10-KQ2U07-32N	12	11.1	35.2	11.1	31.7	13.3	7.6	8	4	2.2	1.8	11.2

Note) ϕD is maximum diameter.

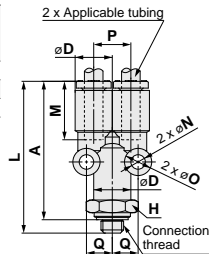

Branch "Y": 10-KQ2U (Sealant)



Applicable tubing O.D. (inch)	Connection thread NPT	Model	H (Width across flats)	Note) ϕD	L	P	A*	M	Q	ϕN	ϕO	Effective area (mm ²) Urethane	Min. port size	Weight (g)
$\phi 1/8$	1/16	10-KQ2U01-33NS	9	7.1	37.3	7.1	33.2	13.3	5.2	6	3.2	2.9	2.5	7.1
	1/8	10-KQ2U01-34NS	11.11	7.1	36.4	7.1	33.2	13.3	5.2	6	3.2	2.9	2.7	9.5
	1/4	10-KQ2U01-35NS	14.29	7.1	40.8	7.1	36.4	13.3	5.2	6	3.2	2.9	2.7	20
$\phi 5/32$	1/16	10-KQ2U03-33NS	9	8.2	37.4	8.2	33.3	13.3	5.7	6	3.2	4.2	3.6	7.3
	1/8	10-KQ2U03-34NS	11.11	8.2	36.5	8.2	33.3	13.3	5.7	6	3.2	4.2	3.6	9.8
	1/4	10-KQ2U03-35NS	14.29	8.2	40.9	8.2	36.5	13.3	5.7	6	3.2	4.2	3.6	20.1
$\phi 3/16$	1/8	10-KQ2U05-34NS	11.11	9.1	37.1	9.1	33.9	13.3	6.2	6	3.2	7	4.1	10.2
	1/4	10-KQ2U05-35NS	14.29	9.1	41.5	9.1	37.1	13.3	6.2	6	3.2	7	4.1	20.5
	1/16	10-KQ2U07-33NS	12.7	11.1	38.7	11.1	34.6	13.3	7.6	8	4	12.4	4.6	11.6
$\phi 1/4$	1/8	10-KQ2U07-34NS	12.7	11.1	37.8	11.1	34.6	13.3	7.6	8	4	12.4	5.6	12
	1/4	10-KQ2U07-35NS	14.29	11.1	42.2	11.1	37.8	13.3	7.6	8	4	12.4	5.6	21.1
	3/8	10-KQ2U07-36NS	17.46	11.1	43.6	11.1	38.9	13.3	7.6	8	4	12.4	5.6	33.5
$\phi 5/16$	1/8	10-KQ2U09-34NS	14.29	13.2	40.7	13.2	37.5	14.2	8.7	8	4.2	17.7	6	16.4
	1/4	10-KQ2U09-35NS	14.29	13.2	45.1	13.2	40.7	14.2	8.7	8	4.2	17.7	7.3	21.9
	3/8	10-KQ2U09-36NS	17.46	13.2	46.5	13.2	41.8	14.2	8.7	8	4.2	17.7	7.3	34.1
$\phi 3/8$	1/4	10-KQ2U11-35NS	17.46	15.4	48.6	15.4	44.2	15.6	9.9	8	4.2	23.8	8.9	25.7
	3/8	10-KQ2U11-36NS	17.46	15.4	50	15.4	45.3	15.6	9.9	8	4.2	23.8	8.9	35
	1/2	10-KQ2U11-37NS	22.23	15.4	54.2	15.4	47.8	15.6	9.9	8	4.2	23.8	8.9	62.8
$\phi 1/2$	1/4	10-KQ2U13-35NS	22	19.3	53.4	19.3	49	17	11.8	8	4.2	50.6	9	42
	3/8	10-KQ2U13-36NS	22	19.3	54.8	19.3	50.1	17	11.8	8	4.2	50.6	11	45.8
	1/2	10-KQ2U13-37NS	22.23	19.3	59	19.3	52.6	17	11.8	8	4.2	50.6	12.1	62.1

* Reference dimensions after installation of NPT thread
Note) ϕD is maximum diameter.

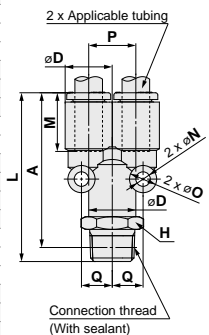

Dimensions

Union "Y": 10-KQ2U



Applicable tubing O.D. (inch)	Model	Note) ϕD	L1	L2	P	M	Q	ϕO	ϕN	Effective area (mm ²) Urethane	Min. port size	Weight (g)
$\phi 1/8$	10-KQ2U01-00A	7.1	28.9	18	7.1	13.3	5.2	6	3.2	2.9	3.2	2.4
$\phi 5/32$	10-KQ2U03-00A	8.2	29	18.2	8.2	13.3	5.7	6	3.2	4.2	4.1	2.9
$\phi 3/16$	10-KQ2U05-00A	9.1	29.6	18.9	9.1	13.3	6.2	6	3.2	7	4.8	3.5
$\phi 1/4$	10-KQ2U07-00A	11.1	30.3	20.2	11.1	13.3	7.6	8	4	12.4	6.4	5
$\phi 5/16$	10-KQ2U09-00A	13.2	33.2	22.3	13.2	14.2	8.7	8	4.2	17.7	8.1	7.4
$\phi 3/8$	10-KQ2U11-00A	15.4	36.7	24.6	15.4	15.6	9.9	8	4.2	23.8	9.6	10.4

Note) ϕD is maximum diameter.

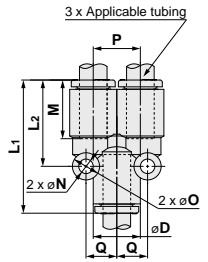

Plug-in "Y": 10-KQ2U



Applicable tubing O.D. (inch)	Applicable fitting size ϕd (inch)	Model	Note) ϕD	L1	L2	P	A	M	Q	ϕO	ϕN	Effective area (mm ²) Urethane	Min. port size	Weight (g)
$\phi 1/8$	$\phi 1/8$	10-KQ2U01-99A	7.1	45.1	18	7.1	31.8	13.3	5.2	6	3.2	2.9	2	2.5
$\phi 5/32$	$\phi 5/32$	10-KQ2U03-99A	8.2	44.8	18.2	8.2	31.5	13.3	5.7	6	3.2	4.2	2.5	3.1
$\phi 3/16$	$\phi 3/16$	10-KQ2U05-99A	9.1	46.1	18.9	9.1	32.8	13.3	6.2	6	3.2	7	3.5	3.6
$\phi 1/4$	$\phi 1/4$	10-KQ2U07-99A	11.1	46.8	20.2	11.1	33.5	13.3	7.6	8	4	12.4	4.6	5.5
$\phi 5/16$	$\phi 5/16$	10-KQ2U09-99A	13.2	52.1	22.3	13.2	37.9	14.2	8.7	8	4.2	17.7	6	8

Note) ϕD is maximum diameter.

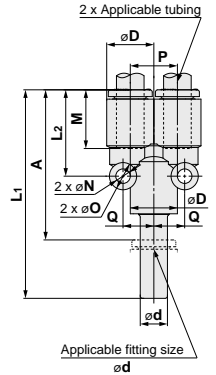

Different Diameter Union "Y": 10-KQ2U



Applicable tubing O.D. (inch)	Model	Note) $\phi D1$	Note) $\phi D2$	L1	L2	P	M1	M2	Q	ϕO	ϕN	Effective area (mm ²) Urethane	Min. port size	Weight (g)	
$\phi 1/8$	$\phi 5/32$	10-KQ2U01-03A	7.1	8.2	28.9	18	7.1	13.3	13.3	5.7	6	3.2	2.7	3.3	2.7
	$\phi 1/4$	10-KQ2U01-07A	7.1	11.1	30.3	18.5	7.1	13.3	13.3	7.2	6	3.2	2.7	3.3	3.3
$\phi 5/32$	$\phi 3/16$	10-KQ2U03-05A	8.2	9.1	29.6	18.8	8.2	13.3	13.3	6.2	6	3.2	4.2	4.1	3.2
	$\phi 1/4$	10-KQ2U03-07A	8.2	11.1	30.3	19	8.2	13.3	13.3	7.2	6	3.2	4.2	4.1	3.6
$\phi 3/16$	$\phi 1/4$	10-KQ2U05-07A	9.1	11.1	30.6	19.8	9.1	13.3	13.3	7.2	6	3.2	7	4.8	3.9
	$\phi 5/16$	10-KQ2U07-09A	11.1	13.2	32.3	21.3	11.1	13.3	14.2	8.6	8	4	12.4	6.4	6
$\phi 1/4$	$\phi 3/8$	10-KQ2U07-11A	11.1	15.4	34.4	21.7	11.1	13.3	15.6	9.8	8	4	12.4	6.4	7.2
	$\phi 5/16$	10-KQ2U09-11A	13.2	15.4	35.3	23	13.2	14.2	15.6	9.9	8	4.2	18.3	8.1	8.5
$\phi 5/16$	$\phi 1/2$	10-KQ2U09-13A	13.2	19.3	38.7	24.2	13.2	14.2	17	11.8	8	4.2	18.3	8.1	11.2
	$\phi 3/8$	10-KQ2U11-13A	15.4	19.3	40.1	26.6	15.4	15.6	17	11.8	8	4.2	23.8	9.6	13

Note) $\phi D1, \phi D2$ are maximum diameters.

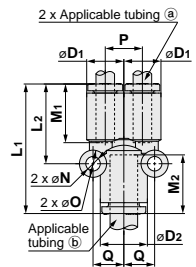

- Directional Control Valves
- Air Cylinders
- Rotary Actuators
- Air Grippers
- Air Preparation Equipment
- Modular F. R.
- Pressure Control Equipment
- Fittings & Tubing
- Flow Control Equipment
- Pressure Switches/ Pressure Sensors

Dimensions

Bulkhead Connector: 10-KQ2E



Applicable tubing O.D. (inch)	Connection thread NPT	Model	T (UNF)	H ₁ (Width across flats)	H ₂ (Width across flats)	L ₁	L ₂	Mounting hole	M	Effective area (mm ²) Urethane	Min. port size	Weight (g)
ø1/8	1/4	10-KQ2E01-35N	1/2-20UNF	17.46	17.46	28.7	13.3	13.5	13.3	2.9	2.5	33.3
ø5/32	1/4	10-KQ2E03-35N	1/2-20UNF	17.46	17.46	29	13.6	13.5	13.3	4	3	33.3
ø3/16	1/8	10-KQ2E05-34N	9/16-18UNF	17.46	17.46	25.6	9.2	15	13.3	6.5	3.5	36.6
ø1/4	1/4	10-KQ2E07-35N	9/16-18UNF	17.46	17.46	29.9	13.5	15	13.3	11.5	4.6	38.8
ø5/16	3/8	10-KQ2E09-36N	3/4-16UNF	22.23	22.23	31	13.6	20	14.2	18	6	61.8
ø3/8	3/8	10-KQ2E11-36N	7/8-14UNF	25.4	25.4	31.4	12	23	15.6	29.1	7	83.8
ø1/2	3/8	10-KQ2E13-36N	1-12UNF	28.57	28.57	32	11.6	26	17	51.7	9.6	108.6
	1/2	10-KQ2E13-37N	1-12UNF	28.57	28.57	36.1	15.7	26	17	51.7	9.6	114.3

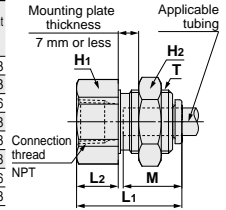

Bulkhead Male Elbow: 10-KQ2LE



Applicable tubing O.D. (inch)	Model	T (UNF)	H ₁ (Width across flats)	H ₂ (Width across flats)	B	E	Note) øD	Mounting hole	M	Effective area (mm ²) Urethane	Min. port size	Weight (g)
ø1/8	10-KQ2LE01-00N	1/2-20UNF	17.46	17.46	14.5	28.9	7.1	13.5	13.3	2.5	2.5	27.5
ø5/32	10-KQ2LE03-00N	1/2-20UNF	17.46	17.46	14.8	28.5	8.2	13.5	13.3	4.2	3	27.1
ø3/16	10-KQ2LE05-00N	9/16-18UNF	17.46	17.46	15	29.7	9.1	15	13.3	5.6	3.5	34.1
ø1/4	10-KQ2LE07-00N	9/16-18UNF	17.46	17.46	15.6	30.7	11.1	15	13.3	10	4.5	32.8
ø5/16	10-KQ2LE09-00N	3/4-16UNF	22.23	22.23	17.2	34.2	13.2	20	14.2	14.9	6	56.6
ø3/8	10-KQ2LE11-00N	7/8-14UNF	25.4	25.4	19.3	32.6	15.4	23	15.6	23.8	7	67.7
ø1/2	10-KQ2LE13-00N	1-12UNF	28.57	28.57	21.8	43.2	19.3	26	17	44.4	9.5	121.5

Note) øD is maximum diameter.

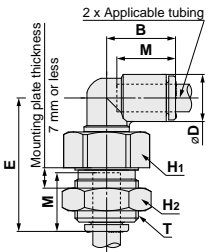

Plug: 10-KQP



Applicable fitting size ød (inch)	Model	Note) øD	L	A	Weight (g)
ø1/8	10-KQP-01	5	31.5	18.2	1
ø5/32	10-KQP-03	6	32	18.7	1
ø3/16	10-KQP-05	6.8	34	20.7	1
ø1/4	10-KQP-07	8.5	35	21.7	1
ø5/16	10-KQP-09	10	39	24.8	2
ø3/8	10-KQP-11	11.5	43	27.4	3.5
ø1/2	10-KQP-13	15	45.5	28.5	5

Note) øD is maximum diameter.

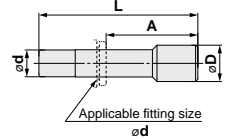

Dimensions

Tube Cap: 10-KQ2C



Applicable tubing O.D. (inch)	Model	Note) ϕD	L	M	Weight (g)
$\phi 5/32$	10-KQ2C03-00A	8.2	14.5	13.3	0.8
$\phi 1/4$	10-KQ2C07-00A	11.1	14.8	13.3	1.3
$\phi 5/16$	10-KQ2C09-00A	13.2	15.7	14.2	2
$\phi 3/8$	10-KQ2C11-00A	15.4	17.3	15.6	2.8

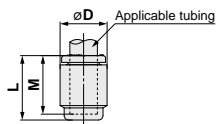

Note) ϕD is maximum diameter.

Nipple: 10-KQN



Applicable fitting ϕD	Model	L	M	ϕd Min. port size	Weight (g)
$\phi 1/8$	10-KQN1-99	36	13.3	2.1	0.2
$\phi 3/16$	10-KQN5-99	38	13.3	3.4	0.4
$\phi 1/4$	10-KQN7-99	39	13.3	4.6	1
$\phi 3/8$	10-KQN11-99	49	15.6	7	2
$\phi 1/2$	10-KQN13-99	51	17	9.5	3.5

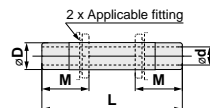

Reducer Nipple: 10-KQN



Applicable fitting	Model		L	M ₁	M ₂	ϕd Min. port size	Weight (g)
	(a)	(b)					
$\phi 1/8$	$\phi 5/32$	10-KQN01-03	36.5	13.3	13.3	2.1	0.2
	$\phi 3/16$	10-KQN01-05	37	13.3	13.3	2.1	0.4
$\phi 5/32$	$\phi 3/16$	10-KQN03-05	37.5	13.3	13.3	2.5	0.4
	$\phi 1/4$	10-KQN03-07	38	13.3	13.3	2.5	0.6
$\phi 3/16$	$\phi 1/4$	10-KQN05-07	38.5	13.3	13.3	3.4	0.6
	$\phi 5/16$	10-KQN05-09	41	13.3	13.3	3.4	1
$\phi 1/4$	$\phi 5/16$	10-KQN07-09	41.5	13.3	13.3	4.6	1
	$\phi 3/8$	10-KQN07-11	45	15.6	13.3	4.6	1
$\phi 5/16$	$\phi 3/8$	10-KQN09-11	46.5	15.6	14.2	6	1.8
	$\phi 1/2$	10-KQN09-13	47.5	17	14.2	6	2.6
$\phi 3/8$	$\phi 1/2$	10-KQN11-13	50	17	15.6	7	3.2

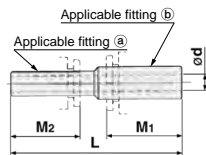

Color Cap: 10-KQ2C

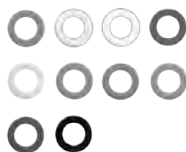

Applicable tubing O.D. (inch)	Model	ϕD_1	ϕD_2	L	Weight (g)	Note
$\phi 1/8$	10-KQ2C-01□A	7.3	4.3	2.6	0.1	—
$\phi 3/16$	10-KQ2C-05□A	9	5.9	2.6	0.1	
$\phi 1/4$	10-KQ2C-07□B	11.5	7.5	2.6	0.1	
$\phi 3/8$	10-KQ2C-11□B	15.7	10.7	2.7	0.1	
$\phi 1/2$	10-KQ2C-13□B	19.6	13.9	2.7	0.2	

□: B (Black), R (Red), YR (Orange), BR (Brown), Y (Yellow), G (Green), CB (Sky blue), GR (Gray), W (White), BU (Blue)

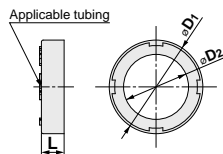

In order to improve the operability, the outside diameter of the release button has been enlarged for the New KQ2 series. Along with this change, the usable color caps differ before and after the change. For details, refer to "Notes when Ordering Color Caps" in the standard products KQ2 series (**WEB catalog**). Additionally, when ordering the color cap, add "10-" at the beginning of the part number. Example) 10-KQ2C-05BA



Series 10-KQ2

Inch Size One-touch Fittings
Applicable Tubing: Inch Size, Connection Thread: M, R, Rc

RoHS

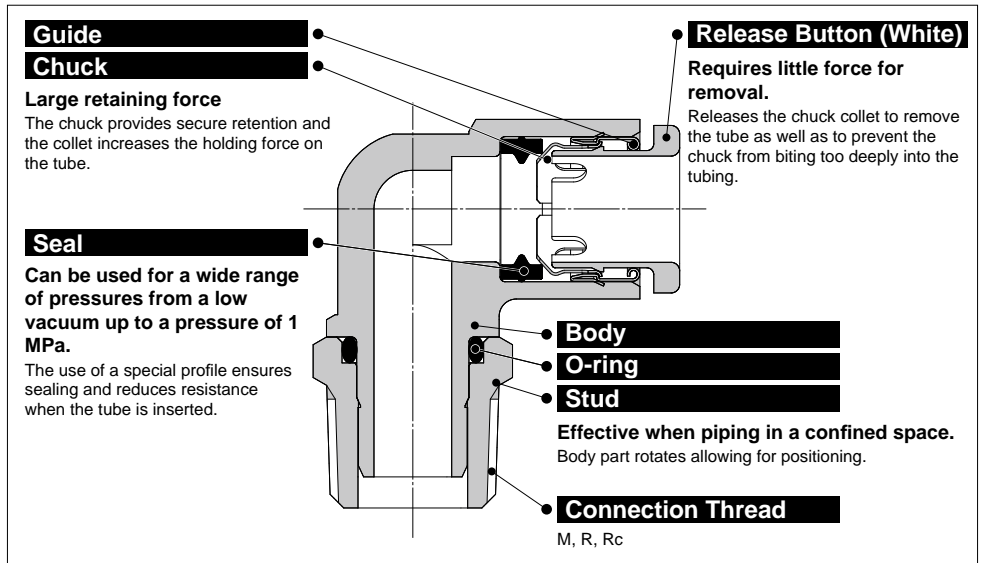

One-touch IN/OUT connection.
Possible to use in vacuum to -100 kPa

- Applicable tubing—Inch size
- Applicable tubing material PFA, Polyurethane



Applicable Tubing

Tubing material ^{Note)}	PFA, Polyurethane
Tubing O.D.	ø1/8", ø3/16", ø1/4", ø5/16", ø3/8", ø1/2"

Note) FEP, nylon and soft nylon tubing can also be used. However, the degree of clean performance will be reduced.

Color

Series	Body	Release button
Series 10-KQ2	White	White

Specifications

Fluid		Air, Water ^{Note 1)}
Operating pressure range ^{Note 2)}		-100 kPa to 1 MPa
Proof pressure (at 23°C)		3 MPa
Ambient and fluid temperature		-5 to 60°C, Water: 0 to 40°C (No freezing)
Thread	Mounting section	JIS B0203 (Taper thread for piping) JIS B0205 (Metric coarse thread)
	Nut section	JIS B0205 (Metric fine thread)
Seal on the threads		With seal or none
Grease		Fluorine based grease
Cleanliness class (ISO class)		Class 5

Note 1) The surge pressure must be under the maximum operating pressure.

Note 2) Do not use the fittings with a leak tester or for vacuum retention because they are not guaranteed for zero leakage.

Principal Parts Material

Body	C3604 Electroless nickel plated, PBT, PP, Stainless steel 303
Stud	C3604 (Thread portion) Electroless nickel plated, Stainless steel 303 (Thread portion)
Chuck	Stainless steel 304
Guide	Stainless steel 304
Release button	POM
Seal, O-ring	NBR
Gasket	Stainless steel 304, NBR

Directional Control Valves

Air Cylinders

Rotary Actuators

Air Grippers

Air Preparation Equipment

Modular F. R.

Pressure Control Equipment

Fittings & Tubing

Flow Control Equipment

Pressure Switches/ Pressure Sensors

Inch Size One-touch Fittings

Variations

Extended male elbow

10-KQ2W P.1179



Basically, it is used together with male elbow. Different point is that it is used for fittings to avoid interfering with each other by making the piping multi-level.

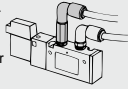

Bulkhead union

10-KQ2E P.1180



Use to connect tubing through a panel, etc.

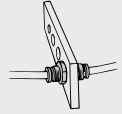

Bulkhead connector

10-KQ2E P.1180



Use to connect male thread and tubing through a panel, etc.

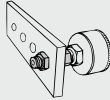

Male connector

10-KQ2H P.1178



Use to pipe a female thread. Most general model.

Male branch tee

10-KQ2T P.1179



Use to branch a female thread at both 90° angles.

Branch "Y"

10-KQ2U P.1180



Use to branch a female thread.

Male elbow

10-KQ2L P.1178



Use to pipe a female thread at right angles. Most general model.

Male run tee

10-KQ2Y P.1179



Use to branch a female thread at a 90° angle.

Dimensions

Male Connector: 10-KQ2H (Gasket seal)



Applicable tubing O.D. (inch)	Connection thread M	Model	H (Width across flats)	øD	L	A	M	Effective area (mm ²) Urethane	Min. port size	Weight (g)
ø1/8	M5 x 0.8	10-KQ2H01-M5N	7	6.7	17.3	14.3	13.3	2.5	2.5	2.7
ø3/16	M5 x 0.8	10-KQ2H05-M5N	10	8.3	17.6	14.6	13.3	4.0	2.5	4.6
ø1/4	M5 x 0.8	10-KQ2H07-M5N	12	10.9	18.4	15.4	13.3	4.0	2.5	6.5

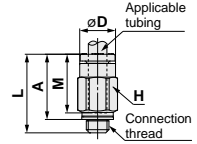

Male Connector: 10-KQ2H (Sealant)



Applicable tubing O.D. (inch)	Connection thread R	Model	H (Width across flats)	øD	L	A*	M	Effective area (mm ²) Urethane	Min. port size	Weight (g)
ø1/8	1/8	10-KQ2H01-01NS	10	6.7	14	10.9	13.3	2.9	2.5	6
	1/4	10-KQ2H01-02NS	14	6.7	16.7	12	13.3	2.9	2.5	15.3
ø3/16	1/8	10-KQ2H05-01NS	10	8.3	17.9	14.8	13.3	6.5	3.5	6.4
	1/4	10-KQ2H05-02NS	14	8.3	16.7	12	13.3	6.5	3.5	13.9
ø1/4	1/8	10-KQ2H07-01NS	12	10.9	18.2	15.1	13.3	11.5	4.6	7.1
	1/4	10-KQ2H07-02NS	14	10.9	16.7	12	13.3	11.5	4.6	12.1
ø5/16	3/8	10-KQ2H07-03NS	17	10.9	18.1	13	13.3	11.5	4.6	24
	1/8	10-KQ2H09-01NS	14	13	22.5	19.4	14.2	18	6	11.9
ø3/8	1/4	10-KQ2H09-02NS	14	13	22	17.3	14.2	18	6	13.9
	3/8	10-KQ2H09-03NS	17	13	18.1	13	14.2	18	6	21
ø1/2	1/4	10-KQ2H11-02NS	17	15.1	26.9	22.2	15.6	29.1	7	22.5
	3/8	10-KQ2H11-03NS	17	15.1	23.2	18.1	15.6	29.1	7	22.9
ø1/2	1/2	10-KQ2H11-04NS	22	15.1	22.3	15.9	15.6	29.1	7	45.9
	3/8	10-KQ2H13-02NS	19	19	28.7	24	17	51.7	9	23.3
ø1/2	3/8	10-KQ2H13-03NS	19	19	27.2	22.1	17	51.7	9.6	26.2
	1/2	10-KQ2H13-04NS	22	19	22.3	15.9	17	51.7	9.6	35.4

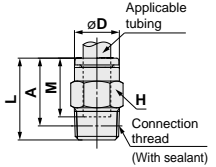

* Reference dimensions after installation of R thread

Male Elbow: 10-KQ2L (Gasket seal)



Applicable tubing O.D. (inch)	Connection thread M	Model	H (Width across flats)	Note) øD1	øD2	L1	L2	A	M	Effective area (mm ²) Urethane	Min. port size	Weight (g)
ø1/8	M5 x 0.8	10-KQ2L01-M5N	7	7.1	7	15.3	14.3	14.9	13.3	2.2	2.5	3.1
ø1/4	M5 x 0.8	10-KQ2L07-M5N	7	11.1	7	15.4	16.1	18.7	13.3	3.5	2.5	3.6

Note) øD1 is maximum diameter.

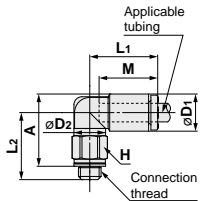

Male Elbow: 10-KQ2L (Sealant)



Applicable tubing O.D. (inch)	Connection thread R	Model	H (Width across flats)	Note) øD1	øD2	L1	L2	A*	M	Effective area (mm ²) Urethane	Min. port size	Weight (g)
ø3/16	1/8	10-KQ2L05-01NS	10	9.1	10	15	16.7	18.2	13.3	5.6	3.5	5
	1/4	10-KQ2L05-02NS	14	9.1	10	15	22.2	22.1	13.3	5.6	3.5	14.5
ø1/4	1/8	10-KQ2L07-01NS	10	11.1	10	15.6	17.7	20.2	13.3	10	4.5	5.3
	1/4	10-KQ2L07-02NS	14	11.1	10	15.6	23.2	24.1	13.3	10	4.5	14.8
ø5/16	3/8	10-KQ2L07-03NS	17	11.1	10	15.6	24.5	25.0	13.3	10	4.5	26.5
	1/8	10-KQ2L09-01NS	10	13.2	10	16.4	18.7	22.2	14.2	11.4	4.5	6.1
ø3/8	1/4	10-KQ2L09-02NS	14	13.2	12	17.2	25.4	27.3	14.2	14.9	6	17.7
	3/8	10-KQ2L09-03NS	17	13.2	12	17.2	25.5	27.0	14.2	14.9	6	24.7
ø1/2	1/4	10-KQ2L11-02NS	17	15.4	17	19.3	28.5	31.5	15.6	23.8	7.5	21.5
	3/8	10-KQ2L11-03NS	17	15.4	17	19.3	29.4	32.0	15.6	23.8	7.5	22
ø1/2	1/2	10-KQ2L11-04NS	22	15.4	17	19.3	33.4	34.7	15.6	23.8	7.5	44.4
	1/4	10-KQ2L13-02NS	17	19.3	17	21.5	30.4	35.3	17	44.4	9	23.8
ø1/2	3/8	10-KQ2L13-03NS	17	19.3	17	21.8	28.5	33.0	17	44.4	9.5	23.2
	1/2	10-KQ2L13-04NS	22	19.3	17	21.8	30.5	33.7	17	44.4	9.5	44.6

* Reference dimensions after installation of R thread Note) øD1 is maximum diameter.

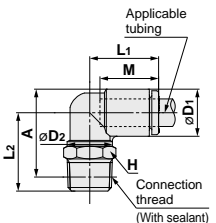

Dimensions

Extended Male Elbow: 10-KQ2W (Sealant)



Applicable tubing O.D. (inch)	Connection thread R	Model	H (Width across flats)	Note	øD1	øD2	L1	L2	A*	M	Effective area (mm ²) Urethane	Min. port size	Weight (g)
ø3/16	1/8	10-KQ2W05-01NS	10	9.1	10	15	30.4	31.8	13.3	5.6	3.5	11.2	
	1/4	10-KQ2W05-02NS	14	9.1	10	15	33.8	33.7	13.3	5.6	3.5	27.7	
ø1/4	1/8	10-KQ2W07-01NS	10	11.1	10	15.6	31.4	33.8	13.3	10.0	4.5	11.5	
	1/4	10-KQ2W07-02NS	14	11.1	10	15.6	34.8	35.7	13.3	10.0	4.5	28	
ø1/2	3/8	10-KQ2W07-03NS	17	11.1	10	15.6	36.1	36.6	13.3	10.0	4.5	47.4	
	1/8	10-KQ2W09-01NS	10	13.2	10	16.4	32.4	35.9	14.2	11.6	4.5	12.2	
ø5/16	1/4	10-KQ2W09-02NS	14	13.2	12	17.2	39.1	41	14.2	14.9	6	40	
	3/8	10-KQ2W09-03NS	17	13.2	12	17.2	39.2	40.7	14.2	14.9	6	47	
ø3/8	1/4	10-KQ2W11-02NS	17	15.4	17	19.3	52.7	55.7	15.6	23.8	7	58.8	
	3/8	10-KQ2W11-03NS	17	15.4	17	19.3	48.3	50.9	15.6	23.8	7	51.1	
ø1/2	1/2	10-KQ2W11-04NS	22	15.4	17	19.3	52.3	53.6	15.6	23.8	7	91.8	
	1/4	10-KQ2W13-02NS	17	19.3	17	21.5	54.6	59.6	17	44.4	9	61	
ø1/2	3/8	10-KQ2W13-03NS	17	19.3	17	21.8	48.2	52.8	17	44.4	9.5	48.4	
	1/2	10-KQ2W13-04NS	22	19.3	17	21.8	50.2	53.5	17	44.4	9.5	92.3	

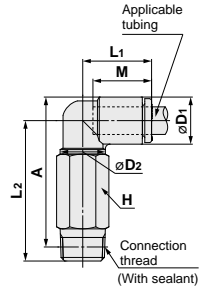

* Reference dimensions after installation of R thread
Note) øD1 is maximum diameter.

Male Branch Tee: 10-KQ2T (Sealant)



Applicable tubing O.D. (inch)	Connection thread R	Model	H (Width across flats)	Note	øD1	øD2	L1	L2	A*	M	Effective area (mm ²) Urethane	Min. port size	Weight (g)
ø3/16	1/8	10-KQ2T05-01NS	10	9.1	10	15	16.7	18.1	13.3	7.0	3.5	5.8	
	1/4	10-KQ2T05-02NS	14	9.1	10	15	22.2	22	13.3	7.0	3.5	15.3	
ø1/4	1/8	10-KQ2T07-01NS	10	11.1	10	15.6	17.7	20.1	13.3	12.4	4.5	6.5	
	1/4	10-KQ2T07-02NS	14	11.1	10	15.6	23.2	24	13.3	12.4	4.5	17	
ø1/2	3/8	10-KQ2T07-03NS	17	11.1	10	15.6	24.5	24.9	13.3	12.4	4.5	27.7	
	1/8	10-KQ2T09-01NS	10	13.2	10	16.4	18.7	22.2	14.2	14.4	4.5	7.9	
ø5/16	1/4	10-KQ2T09-02NS	14	13.2	12	17.2	25.4	27.3	14.2	18.2	6	19.4	
	3/8	10-KQ2T09-03NS	17	13.2	12	17.2	25.5	27	14.2	18.2	6	26.5	
ø3/8	1/4	10-KQ2T11-02NS	17	15.4	17	19.3	28.4	31.4	15.6	23.8	7.5	23.9	
	3/8	10-KQ2T11-03NS	17	15.4	17	19.3	29.3	31.9	15.6	23.8	7.5	24.4	
ø1/2	1/2	10-KQ2T11-04NS	22	15.4	17	19.3	33.3	34.6	15.6	23.8	7.5	46.9	
	1/4	10-KQ2T13-02NS	17	19.3	17	21.5	30.3	35.3	17	50.6	9	27.9	
ø1/2	3/8	10-KQ2T13-03NS	17	19.3	17	21.8	28.4	33	17	50.6	9.5	27.4	
	1/2	10-KQ2T13-04NS	22	19.3	17	21.8	30.4	33.7	17	50.6	9.5	48.8	

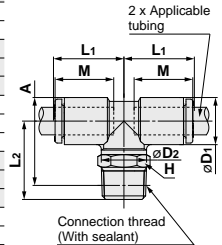

* Reference dimensions after installation of R thread
Note) øD1 is maximum diameter.

Male Run Tee: 10-KQ2Y (Sealant)



Applicable tubing O.D. (inch)	Connection thread R	Model	H (Width across flats)	Note	øD1	øD2	L1	L2	L3	A*	M	Effective area (mm ²) Urethane	Min. port size	Weight (g)
ø3/16	1/8	10-KQ2Y05-01NS	10	9.1	10	15.7	16.7	15.7	29.3	13.3	7.0	3.5	5.9	
	1/4	10-KQ2Y05-02NS	14	9.1	10	15.7	22.2	15.7	33.2	13.3	7.0	3.5	15.4	
ø1/4	1/8	10-KQ2Y07-01NS	10	11.1	10	16.5	17.7	16.5	31.1	13.3	12.4	4.5	6.5	
	1/4	10-KQ2Y07-02NS	14	11.1	10	16.5	23.2	16.5	35	13.3	12.4	4.5	16	
ø1/2	3/8	10-KQ2Y07-03NS	17	11.1	10	16.5	24.5	16.5	35.9	13.3	12.4	4.5	27.7	
	1/8	10-KQ2Y09-01NS	10	13.2	10	18.2	18.7	18.2	33.8	14.2	14.0	4.5	8	
ø5/16	1/4	10-KQ2Y09-02NS	14	13.2	12	18.2	25.4	18.2	38.9	14.2	18.3	6	19.5	
	3/8	10-KQ2Y09-03NS	17	13.2	12	18.2	25.5	18.2	38.6	14.2	18.3	6	26.5	
ø3/8	1/4	10-KQ2Y11-02NS	17	15.4	17	20.4	28.4	20.4	44.1	15.6	23.8	7.5	24.1	
	3/8	10-KQ2Y11-03NS	17	15.4	17	20.4	29.3	20.4	44.6	15.6	23.8	7.5	24.5	
ø1/2	1/2	10-KQ2Y11-04NS	22	15.4	17	20.4	33.3	20.4	47.3	15.6	23.8	7.5	47	
	1/4	10-KQ2Y13-02NS	17	19.3	17	23.4	30.3	23.4	49	17	50.6	9	28.3	
ø1/2	3/8	10-KQ2Y13-03NS	17	19.3	17	23.4	28.4	23.4	46.7	17	50.6	9.5	27.6	
	1/2	10-KQ2Y13-04NS	22	19.3	17	23.4	30.4	23.4	47.4	17	50.6	9.5	49	

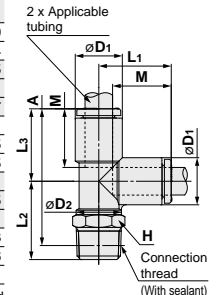

* Reference dimensions after installation of R thread
Note) øD1 is maximum diameter.

Dimensions

Branch "Y": 10-KQ2U (Sealant)



Applicable tubing O.D. (inch)	Connection thread R	Model	H (Width across flats)	Note øD	L	P	A*	M	Q	øO	øN	Effective area (mm ²) Urethane	Min. port size	Weight (g)
ø3/16	1/8	10-KQ2U05-01NS	12	9.1	37.1	9.1	34	13.3	6.2	6	3.2	7.0	3.5	10.3
	1/4	10-KQ2U05-02NS	14	9.1	41.5	9.1	36.8	13.3	6.2	6	3.2	7.0	3.5	19.5
ø1/4	1/8	10-KQ2U07-01NS	12	11.1	37.8	11.1	34.7	13.3	7.6	8	4	12.4	4.6	11.3
	1/4	10-KQ2U07-02NS	14	11.1	42.2	11.1	37.5	13.3	7.6	8	4	12.4	4.6	20.1
ø5/16	1/8	10-KQ2U09-01NS	14	13.2	40.7	13.2	37.6	14.2	8.7	8	4.2	18.3	6	15.8
	1/4	10-KQ2U09-02NS	14	13.2	45.1	13.2	40.4	14.2	8.7	8	4.2	18.3	6	20.9
ø3/8	3/8	10-KQ2U09-03NS	17	13.2	46.5	13.2	41.4	14.2	8.7	8	4.2	18.3	6	32.7
	1/4	10-KQ2U11-02NS	17	15.4	48.6	15.4	43.9	15.6	9.9	8	4.2	23.8	7	24.5
ø1/2	3/8	10-KQ2U11-03NS	17	15.4	50	15.4	44.9	15.6	9.9	8	4.2	23.8	7	33.5
	1/2	10-KQ2U11-04NS	22	15.4	54.2	15.4	47.8	15.6	9.9	8	4.2	23.8	7	61.6
ø1/2	1/4	10-KQ2U13-02NS	21	19.3	53.4	19.3	48.7	17	11.8	8	4.2	50.6	9	40.4
	3/8	10-KQ2U13-03NS	21	19.3	54.8	19.3	49.7	17	11.8	8	4.2	50.6	9.6	43.9
	1/2	10-KQ2U13-04NS	22	19.3	59	19.3	52.6	17	11.8	8	4.2	50.6	9.6	61

* Reference dimensions after installation of R thread
Note) øD is maximum diameter.

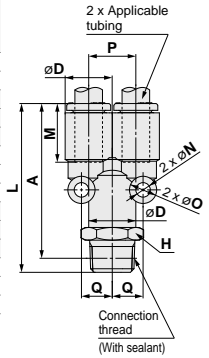

Bulkhead Union: 10-KQ2E



Applicable tubing O.D. (inch)	Model	T (M)	H (Width across flats)	L	Mounting hole	M	Effective area (mm ²) Urethane	Min. port size	Weight (g)
ø3/16	10-KQ2E05-00MN	M14 x 1	17	27.3	15	13.3	6.5	3.5	30.5
ø1/4	10-KQ2E07-00MN	M14 x 1	17	27.3	15	13.3	11.5	4.6	27.2
ø5/16	10-KQ2E09-00MN	M16 x 1	19	29.1	17	14.2	18	6	34
ø3/8	10-KQ2E11-00MN	M20 x 1	24	31.9	21	15.6	29.1	7	66.1
ø1/2	10-KQ2E13-00MN	M22 x 1	27	34.7	23	17	51.7	9.6	59.9

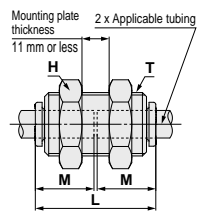

Bulkhead Connector: 10-KQ2E



Applicable tubing O.D. (inch)	Connection thread Rc	Model	T (M)	H ₁ (Width across flats)	H ₂ (Width across flats)	L ₁	L ₂	Mounting hole	M	Effective area (mm ²) Urethane	Min. port size	Weight (g)
ø3/16	1/8	10-KQ2E05-01N	M14 x 1	17	17	23.9	9.5	15	13.3	6.5	3.5	30.8
ø1/4	1/4	10-KQ2E07-02N	M14 x 1	17	17	28.4	14	15	13.3	11.5	4.6	32
ø5/16	3/8	10-KQ2E09-03N	M16 x 1	19	19	31.7	14.3	17	14.2	18	6	59.2
ø3/8	3/8	10-KQ2E11-03N	M20 x 1	22	24	31.5	12.1	21	15.6	29.1	7	62.7
ø1/2	3/8	10-KQ2E13-03N	M22 x 1	24	27	32.1	11.7	23	17	51.7	9.6	66.7
	1/2	10-KQ2E13-04N	M22 x 1	24	27	37.7	17.3	23	17	51.7	9.6	70.6

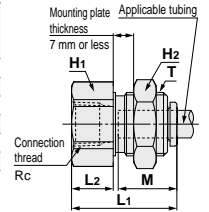

Series 10-KQ2

Metric Size Uni One-touch Fittings

Applicable Tubing: Metric Size, Connection Thread*: Rc, G, NPT, NPTF

RoHS

* A ridge shape has been created as a Uni thread for common applications for Rc, G, NPT and NPTF.

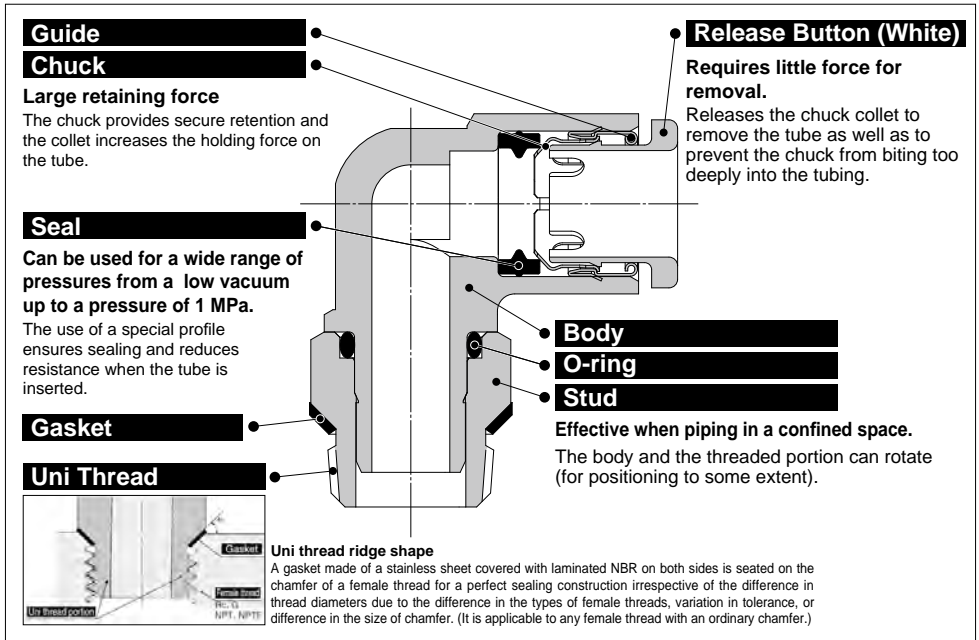

One-touch IN/OUT connection.
Possible to use in vacuum to -100 kPa

- Applicable tubing—Metric size
- Applicable tubing material
PFA, Polyurethane
- The male thread for piping
drastically cuts piping work-hours.



Applicable Tubing

Tubing material <small>Note</small>	PFA, Polyurethane
Tubing O.D.	ø4, ø6, ø8, ø10, ø12, ø16

Note) FEP, nylon and soft nylon tubing can also be used. However, the degree of clean performance will be reduced.

Specifications

Fluid	Air, Water <small>Note 1</small>
Operating pressure range <small>Note 2</small>	-100 kPa to 1 MPa
Proof pressure (at 23°C)	3 MPa
Ambient and fluid temperature	-5 to 60°C, Water: 0 to 40°C (No freezing)
Grease	Fluorine based grease
Cleanliness class (ISO class)	Class 5

Note 1) The surge pressure must be under the maximum operating pressure.

Note 2) Do not use the fittings with a leak tester or for vacuum retention because they are not guaranteed for zero leakage.

Principal Parts Material

Body	C3604 Electroless nickel plated, PBT
Stud	C3604 (Thread portion) Electroless nickel plated
Chuck	Stainless steel 304
Guide	Stainless steel 304
Release button	POM
Seal, O-ring	NBR
Gasket	Stainless steel 304, NBR

Metric Size Uni One-touch Fittings

Variations

Hexagon socket head male connector

10-KQ2S P.1183



Internal hexagon socket allows tightening with a hexagon wrench in confined spaces.

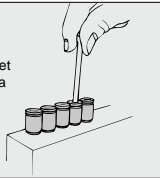

Universal male elbow

10-KQ2V P.1184



Hexagon head of the body allows tightening with a box wrench in confined spaces.

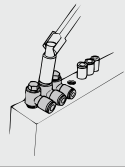

45° male elbow

10-KQ2K P.1184



Use to pipe a female thread at a 45° angle. The model between the male connector and male elbow.

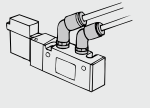

Extended male elbow

10-KQ2W P.1184



Basically, it is used together with male elbow. Different point is that it is used for fittings to avoid interfering with each other by making the piping multi-level.

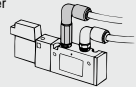

Male connector

10-KQ2H P.1183



Use to pipe a female thread. Most general model.

Male elbow

10-KQ2L P.1183



Use to pipe a female thread at right angles. Most general model.

Male branch tee

10-KQ2T P.1185



Use to branch a female thread at both 90° angles.

Branch "Y"

10-KQ2U P.1185



Use to branch a female thread.

Male run tee

10-KQ2Y P.1185



Use to branch a female thread at a 90° angle.

Directional Control Valves

Air Cylinders

Rotary Actuators

Air Grippers

Air Preparation Equipment

Modular F. R.

Pressure Control Equipment

Fittings & Tubing

Flow Control Equipment

Pressure Switches/ Pressure Sensors

Dimensions

Male Connector: 10-KQ2H (Gasket seal)



Applicable tubing O.D. (mm)	Connection thread Uni	Model	H (Width across flats)	øD	L	A*	M	Effective area (mm ²) Urethane	Min. port size	Weight (g)
ø4	1/8	10-KQ2H04-U01N	10	7.7	15.9	11.1	13.3	4	3	6.6
	1/4	10-KQ2H04-U02N	14	7.7	15.3	8.9	13.3	4	3	12.7
ø6	1/8	10-KQ2H06-U01N	12	9.7	16.7	11.9	13.3	10.4	4.5	6.2
	1/4	10-KQ2H06-U02N	14	9.7	17	10.6	13.3	10.4	4.5	12.8
ø6	3/8	10-KQ2H06-U03N	17	9.7	14.9	8.5	13.3	10.4	4.5	18.1
	1/8	10-KQ2H08-U01N	14	13	20.6	15.8	14.2	18	6	7
ø8	1/4	10-KQ2H08-U02N	14	13	18.5	12.1	14.2	18	6	10.1
	3/8	10-KQ2H08-U03N	17	13	14.9	8.5	14.2	18	6	15
ø10	1/8	10-KQ2H10-U01N	17	15.6	22.4	17.6	15.6	18	6	13.9
	1/4	10-KQ2H10-U02N	17	15.6	23.7	17.3	15.6	29.5	7.5	17.6
ø10	3/8	10-KQ2H10-U03N	17	15.6	19.5	13.1	15.6	29.5	7.5	15.6
	1/2	10-KQ2H10-U04N	22	15.6	17	8.4	15.6	29.5	7.5	29.5
ø12	1/4	10-KQ2H12-U02N	19	18.2	24.8	18.4	17	46.1	9	13.8
	3/8	10-KQ2H12-U03N	19	18.2	21.8	15.4	17	46.1	9	17.9
ø12	1/2	10-KQ2H12-U04N	22	18.2	17.7	9.1	17	46.1	9	25.4
	3/8	10-KQ2H16-U03N	24	23.6	29.2	22.8	20.6	67	11	33.9
ø16	1/2	10-KQ2H16-U04N	24	23.6	26.8	18.2	20.6	67	13	31.5

* Reference dimensions after installation of Uni thread

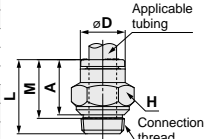

Hexagon Socket Head Male Connector: 10-KQ2S (Gasket seal)



Applicable tubing O.D. (mm)	Connection thread Uni	Model	H (Width across flats)	Note) øD	L1	L2	A*	M	Effective area (mm ²) Urethane	Min. port size	Weight (g)
ø4	1/8	10-KQ2S04-U01N	3	10	20.6	19.6	15.8	13.3	3.6	3.1	8
	1/8	10-KQ2S06-U01N	4	12	19.8	18.8	15	13.3	9.9	4.1	8.2
ø6	1/4	10-KQ2S06-U02N	4	14	19.8	18.8	13.4	13.3	10	4.1	12.3
	1/8	10-KQ2S08-U01N	5	14	20.7	19.7	15.9	14.2	16.2	5.1	9.4
ø8	1/4	10-KQ2S08-U02N	6	14	20.5	19.5	14.1	14.2	16.2	6.1	10.9
	3/8	10-KQ2S08-U03N	6	17	20.7	19.7	14.3	14.2	16.2	6.1	19.8
ø10	1/8	10-KQ2S10-U01N	5	15.6	22.4	21.9	16.8	15.6	16.2	5.1	10.5
	1/4	10-KQ2S10-U02N	8	17	23.7	20.1	17.3	15.6	26.6	8.1	15.4
ø10	3/8	10-KQ2S10-U03N	8	17	21.1	20.1	14.7	15.6	26.6	8.1	16.4
	1/2	10-KQ2S10-U04N	8	21	21.1	20.1	12.5	15.6	26.6	8.1	29.7
ø12	1/4	10-KQ2S12-U02N	8	18.2	27.8	21.5	21.4	17	44.5	8.1	20.7
	3/8	10-KQ2S12-U03N	10	18.2	22.8	21.8	16.4	17	44.5	10.1	16.1
ø12	1/2	10-KQ2S12-U04N	10	21	22.8	21.8	14.2	17	44.5	10.1	28.1

* Reference dimensions after installation of Uni thread
Note) øD is maximum diameter.

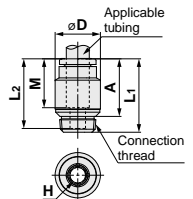

Male Elbow: 10-KQ2L (Gasket seal)



Applicable tubing O.D. (mm)	Connection thread Uni	Model	H (Width across flats)	Note) øD1	Note) øD2	L1	L2	A*	M	Effective area (mm ²) Urethane	Min. port size	Weight (g)
ø4	1/8	10-KQ2L04-U01N	10	8.2	10	14.8	16.4	15.7	13.3	4.2	3	4.8
	1/4	10-KQ2L04-U02N	14	8.2	10	14.8	19.2	16.9	13.3	4.2	3	11.5
ø6	1/8	10-KQ2L06-U01N	10	10.4	10	15.5	17.5	17.9	13.3	9	4.5	5.3
	1/4	10-KQ2L06-U02N	14	10.4	10	15.5	20.3	19.1	13.3	9	4.5	12
ø6	3/8	10-KQ2L06-U03N	17	10.4	10	15.5	21.4	20.2	13.3	9	4.5	21.4
	1/8	10-KQ2L08-U01N	10	13.2	10	16.4	18.9	20.7	14.2	11.4	4.5	6.1
ø8	1/4	10-KQ2L08-U02N	14	13.2	12	17.2	21.7	21.9	14.2	14.9	6	10.9
	3/8	10-KQ2L08-U03N	17	13.2	12	17.2	22.8	23.0	14.2	14.9	6	20.2
ø10	1/8	10-KQ2L10-U01N	14	15.9	12	18.6	21.5	24.6	15.6	14.9	6	12.3
	1/4	10-KQ2L10-U02N	17	15.9	17	19.3	24.3	25.8	15.6	25	7.5	16.9
ø10	3/8	10-KQ2L10-U03N	17	15.9	17	19.3	26.9	28.4	15.6	25	7.5	17.9
	1/2	10-KQ2L10-U04N	22	15.9	17	19.3	34.5	33.8	15.6	25	7.5	48.2
ø12	1/4	10-KQ2L12-U02N	17	18.5	17	21.5	25.6	28.4	17	39.7	9	18.7
	3/8	10-KQ2L12-U03N	17	18.5	17	21.5	28.2	31.0	17	39.7	9	19.8
ø12	1/2	10-KQ2L12-U04N	22	18.5	17	21.5	35.8	36.4	17	39.7	9	50
	3/8	10-KQ2L16-U03N	22	23.8	21	27.1	32.4	37.9	20.6	58.9	11	37.4
ø16	1/2	10-KQ2L16-U04N	22	23.8	21	27.1	35.0	38.3	20.6	58.9	13	47.9

* Reference dimensions after installation of Uni thread
Note) øD1, øD2 are maximum diameters.

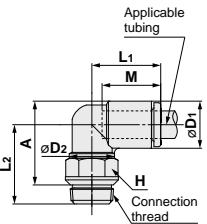

Dimensions

45° Male Elbow: 10-KQ2K (Gasket seal)



Applicable tubing O.D. (mm)	Connection thread Uni	Model	H (Width across flats)	Note) ϕD_1	ϕD_2	L ₁	L ₂	A*	M	Effective area (mm ²) Urethane	Min. port size	Weight (g)
$\phi 4$	1/8	10-KQ2K04-U01N	10	8.2	10	14.4	12.9	20.8	13.3	3.4	4.5	4.7
	1/4	10-KQ2K04-U02N	14	8.2	10	14.4	14.7	21	13.3	3.4	4.5	11.3
$\phi 6$	1/8	10-KQ2K06-U01N	10	10.4	10	14.7	15	23.8	13.3	6.9	4.5	5.1
	1/4	10-KQ2K06-U02N	14	10.4	10	14.7	16.8	24	13.3	6.9	4.5	11.7
$\phi 8$	3/8	10-KQ2K08-U03N	17	15.9	10	14.7	17.9	25.7	13.3	6.9	4.5	21.2
	1/2	10-KQ2K08-U04N	22	15.9	10	14.7	19.9	26.5	14.2	8.7	4.5	6
$\phi 10$	3/8	10-KQ2K10-U03N	17	15.9	12	16	18.7	27.7	14.2	19.7	6	10.7
	1/2	10-KQ2K10-U04N	22	15.9	12	16	19.8	28.8	14.2	19.7	6	20.2
$\phi 12$	3/8	10-KQ2K12-U03N	17	18.5	17	19.4	21.5	34.6	17	35.1	9	18.9
	1/2	10-KQ2K12-U04N	22	18.5	17	19.4	29.1	40	17	35.1	9	49.2

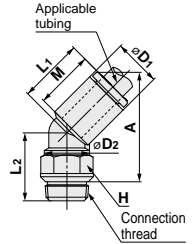

* Reference dimensions after installation of Uni thread
Note) ϕD_1 is maximum diameter.

Universal Male Elbow: 10-KQ2V (Gasket seal)



Applicable tubing O.D. (mm)	Connection thread Uni	Model	H (Width across flats)	Note) ϕD_1	ϕD_2	L ₁	L ₂	L ₃	A*	M	Effective area (mm ²) Urethane	Min. port size	Weight (g)
$\phi 4$	1/8	10-KQ2V04-U01N	8	8.2	13.4	19.3	13.6	25.5	20.7	13.3	2.9	4.5	13.5
	1/4	10-KQ2V04-U02N	8	10.4	13.4	20.5	13.6	25.5	20.7	13.3	5.9	4.5	13.9
$\phi 6$	1/4	10-KQ2V06-U02N	10	10.4	15.3	19.9	15.4	28	21.6	13.3	5.9	4.5	21.8
	1/2	10-KQ2V06-U01N	12	13.2	17.6	23.5	15	27.5	22.7	14.2	11.2	6	23.7
$\phi 8$	1/4	10-KQ2V08-U02N	12	13.2	17.6	23.5	17	29.5	23.1	14.2	11.2	6	28
	3/8	10-KQ2V08-U03N	14	13.2	20.6	23.1	18.2	34	27.6	14.2	14.3	7.5	43.1
$\phi 10$	1/4	10-KQ2V10-U02N	14	15.9	20.6	25.9	19	34	27.6	15.6	20.3	7.5	38.9
	3/8	10-KQ2V10-U03N	14	15.9	20.6	25.9	19	34	27.6	15.6	20.3	7.5	44.4
$\phi 12$	3/8	10-KQ2V12-U03N	17	18.5	25.2	28.5	20.2	36.4	30	17	30.8	9	60.5
	1/2	10-KQ2V12-U04N	17	18.5	25.2	28.5	22.9	39.1	30.5	17	30.8	9	74.5

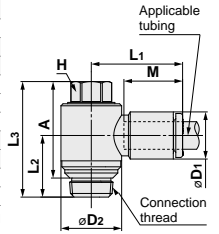

* Reference dimensions after installation of Uni thread
Note) ϕD_1 is maximum diameter.

Extended Male Elbow: 10-KQ2W (Gasket seal)



Applicable tubing O.D. (mm)	Connection thread Uni	Model	H (Width across flats)	Note) ϕD_1	ϕD_2	L ₁	L ₂	A*	M	Effective area (mm ²) Urethane	Min. port size	Weight (g)
$\phi 4$	1/8	10-KQ2W04-U01N	10	8.2	10	14.8	24.1	23.4	13.3	4	3	8.3
	1/4	10-KQ2W04-U02N	14	8.2	10	14.8	30.1	27.8	13.3	4	3	23.9
$\phi 6$	1/8	10-KQ2W06-U01N	10	10.4	10	15.5	31.2	31.6	13.3	8.6	4.5	11.5
	1/4	10-KQ2W06-U02N	14	10.4	10	15.5	31.2	30	13.3	8.6	4.5	24.3
$\phi 8$	3/8	10-KQ2W08-U03N	17	10.4	10	15.5	32.3	31.1	13.3	8.6	4.5	41
	1/2	10-KQ2W08-U01N	17	13.2	10	16.4	32.6	34.4	14.2	10.9	4.5	12.3
$\phi 10$	3/8	10-KQ2W10-U03N	17	13.2	12	17.2	35.4	35.6	14.2	14.2	6	24.1
	1/2	10-KQ2W10-U04N	22	13.2	12	17.2	36.5	36.7	14.2	14.2	6	42.5
$\phi 12$	3/8	10-KQ2W12-U03N	17	15.9	17	19.3	48.5	50.1	15.6	23.8	7.5	54.2
	1/2	10-KQ2W12-U04N	22	15.9	17	19.3	45.8	47.4	15.6	23.8	7.5	97.4

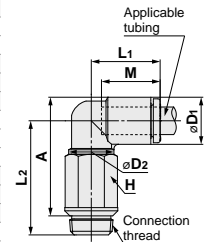

* Reference dimensions after installation of Uni thread
Note) ϕD_1 is maximum diameter.

Directional Control Valves
Air Cylinders
Rotary Actuators
Air Grippers
Air Preparation Equipment
Modular F. R.
Pressure Control Equipment
Fittings & Tubing
Flow Control Equipment
Pressure Switches/ Pressure Sensors

Dimensions

Male Branch Tee: 10-KQ2T (Gasket seal)



Applicable tubing O.D. (mm)	Connection thread Uni	Model	H (Width across flats)	Note	øD1	øD2	L1	L2	A*	M	Effective area (mm ²) Urethane	Min. port size	Weight (g)
ø4	1/8	10-KQ2T04-U01N	10	8.2	10	14.8	16.4	15.7	13.3	4.1	3	5.5	
	1/4	10-KQ2T04-U02N	14	8.2	10	14.8	19.2	16.9	13.3	4.1	3	12.2	
ø6	1/8	10-KQ2T06-U01N	10	10.4	10	15.5	17.5	17.9	13.3	11	4.5	6.2	
	1/4	10-KQ2T06-U02N	14	10.4	10	15.5	20.3	19.1	13.3	11	4.5	12.9	
ø8	3/8	10-KQ2T08-U03N	17	15.9	17	19.3	24.2	25.8	13.3	11	4.5	22.3	
	1/8	10-KQ2T08-U01N	10	13.2	10	16.4	18.9	20.7	14.2	13.9	4.5	7.9	
ø10	1/4	10-KQ2T08-U02N	14	13.2	12	17.2	21.7	21.9	14.2	18.2	6	12.6	
	3/8	10-KQ2T08-U03N	17	13.2	12	17.2	22.8	23	14.2	18.2	6	21.9	
ø12	1/8	10-KQ2T10-U01N	14	15.9	12	18.6	21.4	24.6	15.6	14.9	6	15.1	
	1/4	10-KQ2T10-U02N	17	15.9	17	19.3	24.2	25.8	15.6	25	7.5	19.5	
ø16	3/8	10-KQ2T10-U03N	17	15.9	17	19.3	26.8	28.4	15.6	25	7.5	20.5	
	1/2	10-KQ2T10-U04N	22	15.9	17	19.3	34.4	33.8	15.6	25	7.5	50.8	
ø12	1/4	10-KQ2T12-U02N	17	18.5	17	21.5	25.5	28.4	17	45.2	9	22.5	
	3/8	10-KQ2T12-U03N	17	18.5	17	21.5	28.1	31	17	45.2	9	23.6	
ø16	1/2	10-KQ2T12-U04N	22	18.5	17	21.5	35.7	36.4	17	45.2	9	53.9	
	3/8	10-KQ2T16-U03N	22	23.8	21	27.1	32.4	37.9	20.6	58.9	11	44.3	
ø16	1/2	10-KQ2T16-U04N	22	23.8	21	27.1	35	38.3	20.6	58.9	13	54.8	

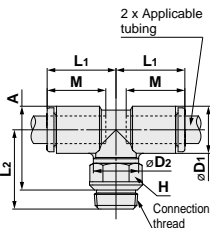

* Reference dimensions after installation of Uni thread
Note) øD1 is maximum diameter.

Male Run Tee: 10-KQ2Y (Gasket seal)



Applicable tubing O.D. (mm)	Connection thread Uni	Model	H (Width across flats)	Note	øD1	L1	L2	L3	A*	M	Effective area (mm ²) Urethane	Min. port size	Weight (g)
ø4	1/8	10-KQ2Y04-U01N	10	8.2	10	15.3	16.4	15.3	26.9	13.3	4	3	5.6
	1/4	10-KQ2Y04-U02N	14	8.2	10	15.3	19.2	15.3	28.1	13.3	4	3	12.2
ø6	1/8	10-KQ2Y06-U01N	10	10.4	10	16.3	17.5	16.3	29	13.3	10.6	4.5	6.3
	1/4	10-KQ2Y06-U02N	14	10.4	10	16.3	20.3	16.3	30.2	13.3	10.6	4.5	13
ø8	3/8	10-KQ2Y06-U03N	17	10.4	10	16.3	21.4	16.3	31.3	13.3	10.6	4.5	22.5
	1/8	10-KQ2Y08-U01N	10	13.2	10	18.2	18.9	18.2	32.3	14.2	13.4	4.5	8
ø10	1/4	10-KQ2Y08-U02N	14	13.2	12	18.2	21.7	18.2	33.5	14.2	17.7	6	12.7
	3/8	10-KQ2Y08-U03N	17	13.2	12	18.2	22.8	18.2	34.6	14.2	17.7	6	22
ø12	1/8	10-KQ2Y10-U01N	14	15.9	12	20.6	21.4	20.6	37.3	15.6	28.4	6	15.2
	1/4	10-KQ2Y10-U02N	17	15.9	17	20.6	24.2	20.6	38.5	15.6	28.4	7.5	19.7
ø16	3/8	10-KQ2Y10-U03N	17	15.9	17	20.6	26.8	20.6	41.1	15.6	28.4	7.5	20.7
	1/2	10-KQ2Y10-U04N	22	15.9	17	20.6	34.4	20.6	46.5	15.6	28.4	7.5	50.9
ø12	1/4	10-KQ2Y12-U02N	17	18.5	17	23	25.5	23	42.2	17	45.4	9	22.8
	3/8	10-KQ2Y12-U03N	17	18.5	17	23	28.1	23	44.8	17	45.4	9	23.9
ø16	1/2	10-KQ2Y12-U04N	22	18.5	17	23	35.7	23	50.2	17	45.4	9	54.2
	3/8	10-KQ2Y16-U03N	22	23.8	21	28.6	32.4	28.6	54.6	20.6	60	11	44.9
ø16	1/2	10-KQ2Y16-U04N	22	23.8	21	28.6	35	28.6	55	20.6	60	13	55.4

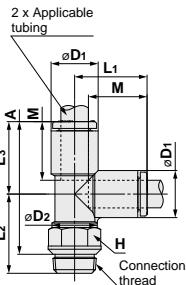

* Reference dimensions after installation of Uni thread
Note) øD1 is maximum diameter.

Branch "Y": 10-KQ2U (Gasket seal)



Applicable tubing O.D. (mm)	Connection thread Uni	Model	H (Width across flats)	Note	øD	L	P	A*	M	Q	øN	Effective area (mm ²) Urethane	Min. port size	Weight (g)
ø4	1/8	10-KQ2U04-U01N	11	8.2	35.4	8.2	30.6	13.3	5.7	6	3.2	4.2	3.6	8.6
	1/4	10-KQ2U04-U02N	14	8.2	37.4	8.2	31	13.3	5.7	6	3.2	4.2	3.6	14.6
ø6	1/8	10-KQ2U06-U01N	12	10.4	36.8	10.4	32	13.3	6.8	6	3.2	10.6	5.4	10
	1/4	10-KQ2U06-U02N	14	10.4	38.5	10.4	32.1	13.3	6.8	6	3.2	10.6	5.4	15
ø8	3/8	10-KQ2U06-U03N	17	10.4	39.3	10.4	32.9	13.3	6.8	6	3.2	10.6	5.4	23.3
	1/8	10-KQ2U08-U01N	14	13.2	41.6	13.2	36.8	14.2	8.7	8	4.2	17.7	6	17.6
ø10	1/4	10-KQ2U08-U02N	14	13.2	42.6	13.2	36.2	14.2	8.7	8	4.2	17.7	7.3	18.3
	3/8	10-KQ2U08-U03N	17	13.2	42.4	13.2	36	14.2	8.7	8	4.2	17.7	7.3	25.5
ø12	1/4	10-KQ2U10-U02N	17	15.9	47.5	15.9	41.2	15.6	10.1	8	4.2	28.4	9	25.3
	3/8	10-KQ2U10-U03N	19	15.9	47.5	15.9	41.1	15.6	10.1	8	4.2	28.4	9.4	31.6
ø16	1/2	10-KQ2U10-U04N	22	15.9	49.4	15.9	40.8	15.6	10.1	8	4.2	28.4	9.4	47.6
	1/4	10-KQ2U12-U02N	22	18.5	52.1	18.5	45.7	17	11.4	8	4.2	45.4	9	42.6
ø12	3/8	10-KQ2U12-U03N	22	18.5	52	18.5	45.6	17	11.4	8	4.2	45.4	11	41.2
	1/2	10-KQ2U12-U04N	22	18.5	53.4	18.5	44.8	17	11.4	8	4.2	45.4	11.6	48.8

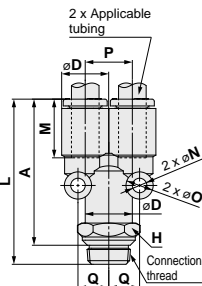

* Reference dimensions after installation of Uni thread
Note) øD is maximum diameter.

Series 10-KQ2

Inch Size Uni One-touch Fittings

Applicable Tubing: Inch Size, Connection Thread*: Rc, G, NPT, NPTF

RoHS

* A ridge shape has been created as a Uni thread for common applications for Rc, G, NPT and NPTF.

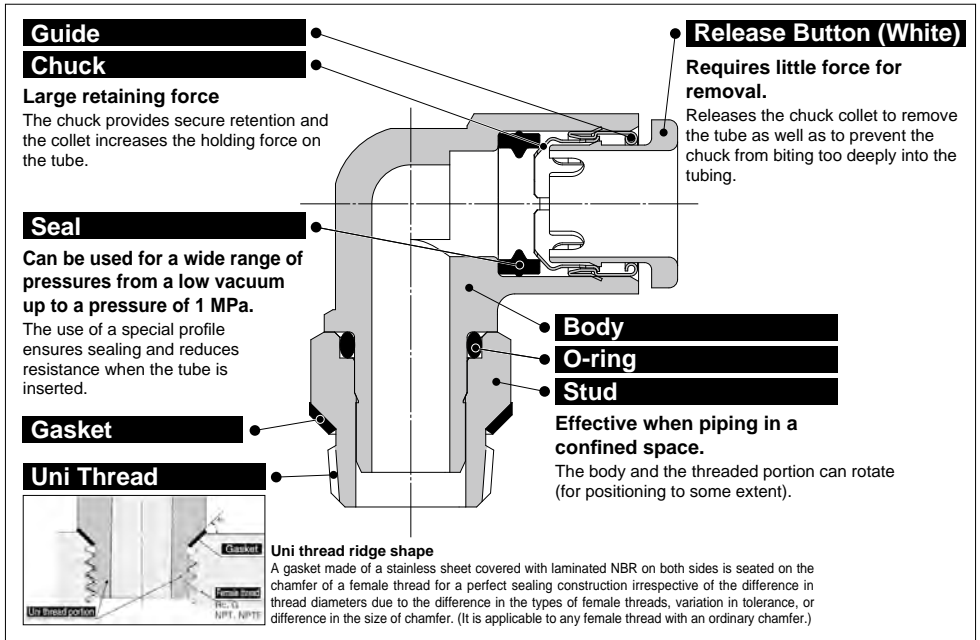

One-touch IN/OUT connection.
Possible to use in vacuum to -100 kPa

- Applicable tubing—Inch size
- Applicable tubing material
PFA, Polyurethane
- The male thread for piping
drastically cuts piping work-hours.



Applicable Tubing

Tubing material (Note)	PFA, Polyurethane
Tubing O.D.	ø1/8", ø5/32", ø3/16", ø1/4", ø5/16", ø3/8", ø1/2"

Note) FEP, nylon and soft nylon tubing can also be used. However, the degree of clean performance will be reduced.

Specifications

Fluid	Air, Water (Note 1)
Operating pressure range (Note 2)	-100 kPa to 1 MPa
Proof pressure (at 23°C)	3 MPa
Ambient and fluid temperature	-5 to 60°C, Water: 0 to 40°C (No freezing)
Grease	Fluorine based grease
Cleanliness class (ISO class)	Class 5

Note 1) The surge pressure must be under the maximum operating pressure.

Note 2) Do not use the fittings with a leak tester or for vacuum retention because they are not guaranteed for zero leakage.

Principal Parts Material

Body	C3604 Electroless nickel plated, PBT
Stud	C3604 (Thread portion) Electroless nickel plated
Chuck	Stainless steel 304
Guide	Stainless steel 304
Release button	POM
Seal, O-ring	NBR
Gasket	Stainless steel 304, NBR

Directional Control Valves

Air Cylinders

Rotary Actuators

Air Grippers

Air Preparation Equipment

Modular F. R.

Pressure Control Equipment

Fittings & Tubing

Flow Control Equipment

Pressure Switches/ Pressure Sensors

Inch Size Uni One-touch Fittings

Variations

Male connector

10-KQ2H P.1188



Use to pipe a female thread. Most general model.

Male elbow

10-KQ2L P.1188



Use to pipe a female thread at right angles. Most general model.

Male branch tee

10-KQ2T P.1189



Use to branch a female thread at both 90° angles.

Male run tee

10-KQ2Y P.1189



Use to branch a female thread at a 90° angle.

Branch "Y"

10-KQ2U P.1189



Use to branch a female thread.

Extended male elbow

10-KQ2W P.1188



Basically, it is used together with male elbow. Different point is that it is used for fittings to avoid interfering with each other by making the piping multi-level.

Dimensions

Male Connector: 10-KQ2H (Gasket seal)



Applicable tubing O.D. (inch)	Connection thread Uni	Model	H (Width across flats)	øD	L	A*	M	Effective area (mm ²)	Min. port size	Weight (g)
								Urethane		
ø1/8	1/8	10-KQ2H01-U01N	11.11	6.7	15.2	10.4	13.3	2.9	2.5	7.9
	1/4	10-KQ2H01-U02N	14.29	6.7	15.3	8.9	13.3	2.9	2.5	13.7
ø5/32	1/8	10-KQ2H03-U01N	11.11	7.7	15.7	10.9	13.3	4	3	7.7
	1/4	10-KQ2H03-U02N	14.29	7.7	15.3	8.9	13.3	4	3	13
ø3/16	1/8	10-KQ2H05-U01N	12.7	8.3	16	11.2	13.3	5.6	3.5	7.7
	1/4	10-KQ2H05-U02N	14.29	8.3	15.3	8.9	13.3	5.6	3.5	12.4
ø1/4	1/8	10-KQ2H07-U01N	12.7	10.9	18.9	14.1	13.3	10	4.6	8.7
	1/4	10-KQ2H07-U02N	14.29	10.9	15.3	8.9	13.3	10	4.6	10.7
ø5/16	3/8	10-KQ2H07-U03N	17.46	10.9	14.9	8.5	13.3	10	4.6	18.4
	1/8	10-KQ2H09-U01N	14.29	13	20.6	15.8	14.2	18	6	10.5
ø1/2	1/4	10-KQ2H09-U02N	14.29	13	18.5	12.1	14.2	18	6	10.7
	3/8	10-KQ2H09-U03N	17.46	13	14.9	8.5	14.2	18	6	15.5
ø3/8	1/4	10-KQ2H11-U02N	17.46	15.1	22.2	15.8	15.6	23.8	7	16.6
	3/8	10-KQ2H11-U03N	17.46	15.1	18.9	12.5	15.6	23.8	7	16.2
ø1/2	1/2	10-KQ2H11-U04N	22.23	15.1	17	8.4	15.6	23.8	7	30.9
	1/4	10-KQ2H13-U02N	22.23	19	25.2	18.8	17	44.4	9	24.9
ø1/2	3/8	10-KQ2H13-U03N	22.23	19	23.5	17.1	17	44.4	9.6	27
	1/2	10-KQ2H13-U04N	22.23	19	21.7	13.1	17	44.4	9.6	29.8

* Reference dimensions after installation of Uni thread

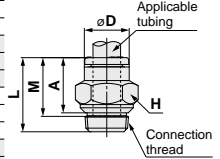

Male Elbow: 10-KQ2L (Gasket seal)



Applicable tubing O.D. (inch)	Connection thread Uni	Model	H (Width across flats)	Note) øD1	øD2	L1	L2	A*	M	Effective area (mm ²)	Min. port size	Weight (g)
										Urethane		
ø1/8	1/8	10-KQ2L01-U01N	11.11	7.1	10	14.5	17.9	16.7	13.3	2.5	2.5	6
	1/4	10-KQ2L01-U02N	14.29	7.1	10	14.5	19.2	16.4	13.3	2.5	2.5	12.1
ø5/32	1/8	10-KQ2L03-U01N	11.11	8.2	10	14.8	17.4	16.7	13.3	4.2	3	6.2
	1/4	10-KQ2L03-U02N	14.29	8.2	10	14.8	19.7	17.4	13.3	4.2	3	12.3
ø3/16	1/8	10-KQ2L05-U01N	11.11	9.1	10	15	17.9	17.7	13.3	5.6	3.5	6.4
	1/4	10-KQ2L05-U02N	14.29	9.1	10	15	20.2	18.4	13.3	5.6	3.5	12.5
ø1/4	1/8	10-KQ2L07-U01N	11.11	11.1	10	15.6	18.9	19.7	13.3	10	4.5	6.7
	1/4	10-KQ2L07-U02N	14.29	11.1	10	15.6	21.2	20.4	13.3	10	4.5	12.9
ø5/16	3/8	10-KQ2L07-U03N	17.46	11.1	10	15.6	22.3	21.5	13.3	10	4.5	23.1
	1/8	10-KQ2L09-U01N	11.11	13.2	10	16.4	19.9	21.7	14.2	11.4	4.5	7.4
ø1/2	1/4	10-KQ2L09-U02N	14.29	13.2	12	17.2	22.2	22.4	14.2	14.9	6	11.6
	3/8	10-KQ2L09-U03N	17.46	13.2	12	17.2	23.3	23.5	14.2	14.9	6	21.7
ø3/8	1/4	10-KQ2L11-U02N	17.46	15.4	17	19.3	24.4	25.7	15.6	23.8	7.5	18
	3/8	10-KQ2L11-U03N	17.46	15.4	17	19.3	27.0	28.3	15.6	23.8	7.5	18.7
ø1/2	1/2	10-KQ2L11-U04N	22.23	15.4	17	19.3	34.8	33.9	15.6	23.8	7.5	50
	1/4	10-KQ2L13-U02N	17.46	19.3	17	21.5	26.3	29.5	17	44.4	9	20.3
ø1/2	3/8	10-KQ2L13-U03N	17.46	19.3	17	21.8	28.9	32.1	17	44.4	9.5	25.1
	1/2	10-KQ2L13-U04N	22.23	19.3	17	21.8	31.9	32.9	17	44.4	9.5	56

* Reference dimensions after installation of Uni thread Note) øD1 is maximum diameter.

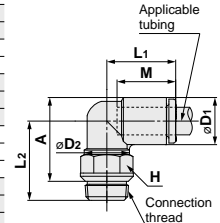

Extended Male Elbow: 10-KQ2W (Gasket seal)



Applicable tubing O.D. (inch)	Connection thread Uni	Model	H (Width across flats)	Note) øD1	øD2	L1	L2	A*	M	Effective area (mm ²)	Min. port size	Weight (g)
										Urethane		
ø1/8	1/8	10-KQ2W01-U01N	11.11	7.1	10	14.5	31.5	30.3	13.3	2.4	2.5	14.5
	1/4	10-KQ2W01-U02N	14.29	7.1	10	14.5	30.8	28	13.3	2.4	2.5	26
ø5/32	1/8	10-KQ2W03-U01N	11.11	8.2	10	14.8	31.1	30.4	13.3	4	3	14.6
	1/4	10-KQ2W03-U02N	14.29	8.2	10	14.8	31.3	29	13.3	4	3	26.2
ø3/16	1/8	10-KQ2W05-U01N	11.11	9.1	10	15	31.6	31.3	13.3	5.6	3.5	14.8
	1/4	10-KQ2W05-U02N	14.29	9.1	10	15	31.8	30	13.3	5.6	3.5	26.4
ø1/4	1/8	10-KQ2W07-U01N	11.11	11.1	10	15.6	32.6	33.3	13.3	10	4.5	15.1
	1/4	10-KQ2W07-U02N	14.29	11.1	10	15.6	32.8	32	13.3	10	4.5	26.8
ø5/16	3/8	10-KQ2W07-U03N	17.46	11.1	10	15.6	33.9	33.1	13.3	10	4.5	45.3
	1/8	10-KQ2W09-U01N	11.11	13.2	10	16.4	33.6	35.4	14.2	11.3	4.5	15.9
ø1/2	1/4	10-KQ2W09-U02N	14.29	13.2	12	17.2	35.9	36.1	14.2	14.2	6	25.7
	3/8	10-KQ2W09-U03N	17.46	13.2	12	17.2	37	37.2	14.2	14.2	6	45.5
ø3/8	1/4	10-KQ2W11-U02N	17.46	15.4	17	19.3	44.1	45.4	15.6	23.8	7.5	50.6
	3/8	10-KQ2W11-U03N	17.46	15.4	17	19.3	42.9	44.2	15.6	23.8	7.5	45
ø1/2	1/2	10-KQ2W11-U04N	22.23	15.4	17	19.3	50.7	49.8	15.6	23.8	7.5	90.9
	1/4	10-KQ2W13-U02N	17.46	19.3	17	21.5	46	49.3	17	44.4	9	52.9
ø1/2	3/8	10-KQ2W13-U03N	17.46	19.3	17	21.8	48.6	51.9	17	44.4	9.5	52.6
	1/2	10-KQ2W13-U04N	22.23	19.3	17	21.8	51.6	52.7	17	44.4	9.5	114.1

* Reference dimensions after installation of Uni thread Note) øD1 is maximum diameter.

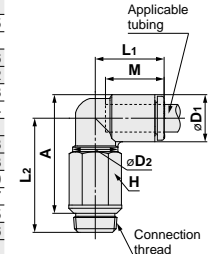

Dimensions

Male Branch Tee: 10-KQ2T (Gasket seal)



Applicable tubing O.D. (inch)	Connection thread Uni	Model	H (Width across flats)	Note	øD1	øD2	L1	L2	A*	M	Effective area (mm ²) Urethane	Min. port size	Weight (g)
ø1/8	1/8	10-KQ2T01-U01N	11.11	7.1	10	14.5	17.8	16.6	13.3	2.9	2.5	6.6	
	1/4	10-KQ2T01-U02N	14.29	7.1	10	14.5	19.1	16.3	13.3	2.9	2.5	12.7	
ø5/32	1/8	10-KQ2T03-U01N	11.11	8.2	10	14.8	17.4	16.7	13.3	4.1	3	6.9	
	1/4	10-KQ2T03-U02N	14.29	8.2	10	14.8	19.7	17.4	13.3	4.1	3	13	
ø3/16	1/8	10-KQ2T05-U01N	11.11	9.1	10	15	17.9	17.6	13.3	5.6	3.5	7.1	
	1/4	10-KQ2T05-U02N	14.29	9.1	10	15	20.2	18.3	13.3	5.6	3.5	13.3	
ø1/4	1/8	10-KQ2T07-U01N	11.11	11.1	10	15.6	18.9	19.6	13.3	10	4.5	7.8	
	1/4	10-KQ2T07-U02N	14.29	11.1	10	15.6	21.2	20.3	13.3	10	4.5	14.1	
ø3/8	1/8	10-KQ2T07-U03N	17.46	11.1	10	15.6	22.3	21.4	13.3	10	4.5	24.3	
	1/8	10-KQ2T09-U01N	11.11	13.2	10	16.4	19.9	21.7	14.2	13.9	4.5	9.3	
ø5/16	1/4	10-KQ2T09-U02N	14.29	13.2	12	17.2	22.2	22.4	14.2	18.2	6	13.4	
	3/8	10-KQ2T09-U03N	17.46	13.2	12	17.2	23.3	23.5	14.2	18.2	6	23.4	
ø3/8	1/4	10-KQ2T11-U02N	17.46	15.4	17	19.3	24.3	25.6	15.6	23.8	7.5	20.4	
	3/8	10-KQ2T11-U03N	17.46	15.4	17	19.3	26.9	28.2	15.6	23.8	7.5	21.2	
ø1/2	1/2	10-KQ2T11-U04N	22.23	15.4	17	19.3	34.7	33.8	15.6	23.8	7.5	52.5	
	1/4	10-KQ2T13-U02N	17.46	19.3	17	21.5	26.2	29.5	17	44.4	9	24.4	
ø1/2	3/8	10-KQ2T13-U03N	17.46	19.3	17	21.8	28.8	32.1	17	44.4	9.5	29.3	
	1/2	10-KQ2T13-U04N	22.23	19.3	17	21.8	31.8	32.9	17	44.4	9.5	60.2	

* Reference dimensions after installation of Uni thread Note) øD1 is maximum diameter.

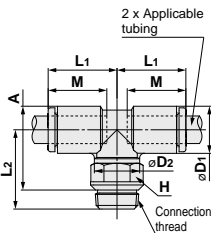

Male Run Tee: 10-KQ2Y (Gasket seal)



Applicable tubing O.D. (inch)	Connection thread Uni	Model	H (Width across flats)	Note	øD1	øD2	L1	L2	L3	A*	M	Effective area (mm ²) Urethane	Min. port size	Weight (g)
ø1/8	1/8	10-KQ2Y01-U01N	11.11	7.1	10	14.9	17.8	14.9	28	13.3	2.9	2.5	6.6	
	1/4	10-KQ2Y01-U02N	14.29	7.1	10	14.9	19.1	14.9	27.7	13.3	2.9	2.5	12.8	
ø5/32	1/8	10-KQ2Y03-U01N	11.11	8.2	10	15.3	17.4	15.3	27.9	13.3	4.4	3	6.9	
	1/4	10-KQ2Y03-U02N	14.29	8.2	10	15.3	19.7	15.3	28.6	13.3	4.4	3	13.1	
ø3/16	1/8	10-KQ2Y05-U01N	11.11	9.1	10	15.7	17.9	15.7	28.8	13.3	5.6	3.5	7.2	
	1/4	10-KQ2Y05-U02N	14.29	9.1	10	15.7	20.2	15.7	29.5	13.3	5.6	3.5	13.4	
ø1/4	1/8	10-KQ2Y07-U01N	11.11	11.1	10	16.5	18.9	16.5	30.6	13.3	10	4.5	7.9	
	1/4	10-KQ2Y07-U02N	14.29	11.1	10	16.5	21.2	16.5	31.3	13.3	10	4.5	14.1	
ø3/8	3/8	10-KQ2Y07-U03N	17.46	11.1	10	16.5	22.3	16.5	32.4	13.3	10	4.5	24.3	
	1/8	10-KQ2Y09-U01N	11.11	13.2	10	18.2	19.9	18.2	33.3	14.2	13.4	4.5	9.3	
ø5/16	1/4	10-KQ2Y09-U02N	14.29	13.2	12	18.2	22.2	18.2	34	14.2	17.7	6	13.4	
	3/8	10-KQ2Y09-U03N	17.46	13.2	12	18.2	23.3	18.2	35.1	14.2	17.7	6	23.5	
ø3/8	1/4	10-KQ2Y11-U02N	17.46	15.4	17	20.4	24.3	20.4	38.3	15.6	23.8	7.5	20.5	
	3/8	10-KQ2Y11-U03N	17.46	15.4	17	20.4	26.9	20.4	40.9	15.6	23.8	7.5	21.3	
ø1/2	1/2	10-KQ2Y11-U04N	22.23	15.4	17	20.4	34.7	20.4	46.5	15.6	23.8	7.5	52.6	
	1/4	10-KQ2Y13-U02N	17.46	19.3	17	23.4	26.2	23.4	43.2	17	44.4	9	24.7	
ø1/2	3/8	10-KQ2Y13-U03N	17.46	19.3	17	23.4	28.8	23.4	45.8	17	44.4	9.5	29.5	
	1/2	10-KQ2Y13-U04N	22.23	19.3	17	23.4	31.8	23.4	46.6	17	44.4	9.5	60.4	

* Reference dimensions after installation of Uni thread Note) øD1 is maximum diameter.

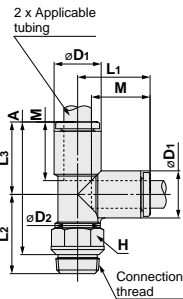

Branch "Y": 10-KQ2U (Gasket seal)



Applicable tubing O.D. (inch)	Connection thread Uni	Model	H (Width across flats)	Note	øD	L	P	A*	M	Q	øO	øN	Effective area (mm ²) Urethane	Min. port size	Weight (g)
ø1/8	1/8	10-KQ2U01-U01N	11.11	7.1	35.1	7.1	30.3	13.3	5.2	6	3.2	2.9	2.7	8.2	
	1/4	10-KQ2U01-U02N	14.29	7.1	37.4	7.1	31	13.3	5.2	6	3.2	2.9	2.7	14.6	
ø5/32	1/8	10-KQ2U03-U01N	11.11	8.2	35.4	8.2	30.6	13.3	5.7	6	3.2	4.2	3.6	8.7	
	1/4	10-KQ2U03-U02N	14.29	8.2	37.4	8.2	31	13.3	5.7	6	3.2	4.2	3.6	14.8	
ø3/16	1/8	10-KQ2U05-U01N	11.11	9.1	35.8	9.1	31	13.3	6.2	6	3.2	5.6	4.1	9	
	1/4	10-KQ2U05-U02N	14.29	9.1	38.1	9.1	31.7	13.3	6.2	6	3.2	5.6	4.1	15.3	
ø1/4	1/8	10-KQ2U07-U01N	12.7	11.1	37.7	11.1	32.9	13.3	7.6	8	4	10	5.6	12	
	1/4	10-KQ2U07-U02N	14.29	11.1	38.8	11.1	32.4	13.3	7.6	8	4	10	5.6	16.3	
ø3/8	3/8	10-KQ2U07-U03N	17.46	11.1	39.7	11.1	33.3	13.3	7.6	8	4	10	5.6	25.1	
	1/8	10-KQ2U09-U01N	14.29	13.2	41.6	13.2	36.8	14.2	8.7	8	4.2	17.7	6	17.9	
ø5/16	1/4	10-KQ2U09-U02N	14.29	13.2	42.6	13.2	36.2	14.2	8.7	8	4.2	17.7	7.3	18.6	
	3/8	10-KQ2U09-U03N	17.46	13.2	42.4	13.2	36	14.2	8.7	8	4.2	17.7	7.3	26.1	
ø3/8	1/4	10-KQ2U11-U02N	17.46	15.4	47.2	15.4	40.8	15.6	9.9	8	4.2	23.8	8.9	24.8	
	3/8	10-KQ2U11-U03N	19	15.4	47.1	15.4	40.7	15.6	9.9	8	4.2	23.8	8.9	31.5	
ø1/2	1/2	10-KQ2U11-U04N	22.23	15.4	49.3	15.4	40.7	15.6	9.9	8	4.2	23.8	8.9	48.9	
	1/4	10-KQ2U13-U02N	22.23	19.3	52.5	19.3	46.1	17	11.8	8	4.2	50.6	9	44.3	
ø1/2	3/8	10-KQ2U13-U03N	22.23	19.3	52.4	19.3	46	17	11.8	8	4.2	50.6	11	43	
	1/2	10-KQ2U13-U04N	22.23	19.3	54	19.3	45.4	17	11.8	8	4.2	50.6	12.1	50	

* Reference dimensions after installation of Uni thread Note) øD is maximum diameter.

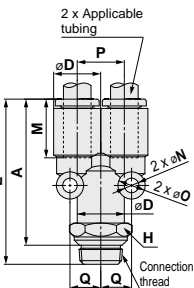

Series 10-KF

Insert Fittings

RoHS

Construction

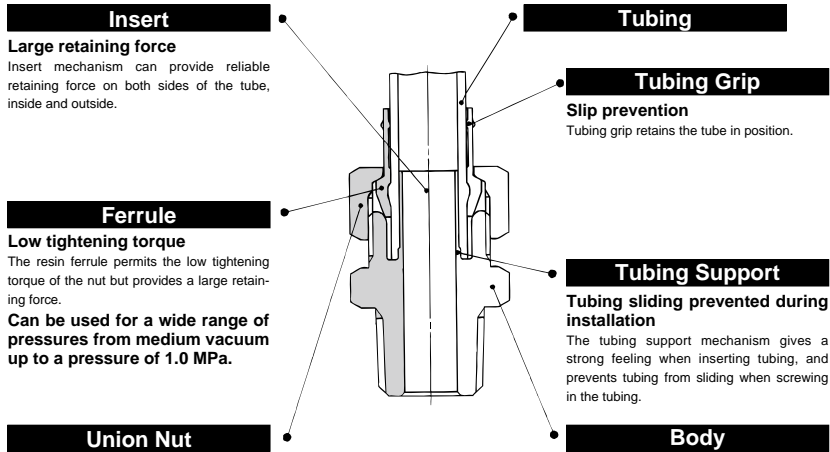

Specifications

Fluid	Air, Water ^{Note 3)}
Operating pressure range ^{Note 1)}	-101.3 kPa to 1.0 MPa
Proof pressure	7.0 MPa
Ambient and fluid temperature	-5 to 60°C (No freezing)
Seal (Thread portion) ^{Note 2)}	None or with sealant
Cleanliness class (ISO class)	Class 3

Note 1) Do not use the fittings with a leak tester or for vacuum retention because they are not guaranteed for zero leakage.

Note 2) Male elbow, Male branch tee and Male run tee with seal are manufactured upon receipt of order.

Note 3) Swivel type is not compatible with water.

Applicable Tubing

Tubing size	O.D.	4	6	8	10	12
	I.D.	2.5	4	5	6.5	8
Material	Polyurethane tubing	●	●	●	●	●

Principal Parts Material

Body	Electroless nickel plated C3371BE, C3604BD
Nut	Electroless nickel plated C360BD
Ferrule	Nylon 66

Directional Control Valves

Air Cylinders

Rotary Actuators

Air Grippers

Air Preparation Equipment

Modular F. R.

Pressure Control Equipment

Fittings & Tubing

Flow Control Equipment

Pressure Switches/ Pressure Sensors

Model

Male connector

10-KFH



Use to connect tubes in the same direction from female thread.
Most general model.

Female connector

10-KFF



Use to pipe from male thread such as pressure gauge.

Straight union

10-KFH



Use to connect tubes in the same direction.

Bulkhead connector

10-KFE



Use to connect male thread and tube through a panel.

Male elbow

10-KFL



Use to pipe at right angles to female thread.
Most general model.

Bulkhead union

10-KFE



Use to connect tubes through a panel.

Union tee

10-KFT



Use to connect tubes in both 90° directions.

Male run tee

10-KFY



Use to branch line in the same direction from female thread and in 90° direction.

Male branch tee

10-KFT



Use to branch line from female thread in both 90° directions.

Plug

10-KFP



Use to plug unused fittings.

Swivel elbow

10-KFV



Use to pipe at right angles to female thread.
Swiveled at any direction.

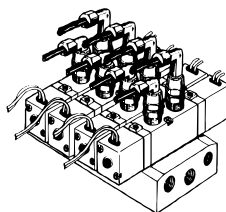

Swivel extended elbow

10-KFW



Use to pipe at right angles to female thread.
Swiveled at any direction.
Solid piece moves fittings up from workpiece.

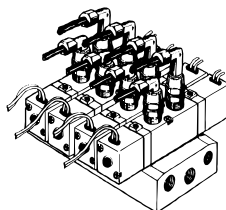

Male Connector: 10-KFH

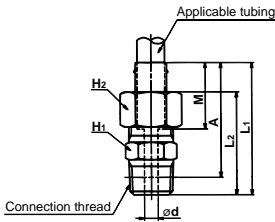

Applicable tubing size (mm)		Connection thread R	Model	H ₁ (width across flats)	H ₂ (width across flats)	L ₁	L ₂	M	d	A *	Effective area (mm ²)	Weight (g)
O.D.	I.D.											
4	2.5	1/8	10-KFH04-01	10	29.6	22.9	17	15.5	1.5	26.5	1.6	13
		1/4	10-KFH04-02	14	34	27.3						
6	4	1/8	10-KFH06-01	10	29.3	22.6	12	15.2	3	26.2	6	25
		1/4	10-KFH06-02	14	33.7	27						
		3/8	10-KFH06-03	17	34.1	27.4						
8	5	1/8	10-KFH08U-01	12	29.3	22.6	14	16.2	4	26.2	11	25
		1/4	10-KFH08U-02	14	33.7	27						
		3/8	10-KFH08U-03	17	34.1	27.4						
10	6.5	1/4	10-KFH10U-02	17	35.3	28	17	18.8	5.5	29.8	21	40
		3/8	10-KFH10U-03	17	35.7	28.4						
		1/2	10-KFH10U-04	22	38.9	31.6						
12	8	1/4	10-KFH12U-02	17	35.8	29	19	19.3	7	30.3	35	41
		3/8	10-KFH12U-03	17	36.2	29.4						
		1/2	10-KFH12U-04	22	39.4	32.6						

* Reference dimensions after R thread installation.

Straight Union: 10-KFH

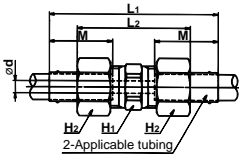

Applicable tubing size (mm)		Model	H ₁ (width across flats)	H ₂ (width across flats)	L ₁	L ₂	M	d	Effective area (mm ²)	Weight (g)
O.D.	I.D.									
4	2.5	10-KFH04-00	8	10	40.9	27.6	15.5	1.5	1.6	13
6	4	10-KFH06-00	10	12	40.3	27	15.2	3	6	17
8	5	10-KFH08U-00	12	14	41.3	28	16.2	4	11	23
10	6.5	10-KFH10U-00	17	17	44.6	30	18.8	5.5	21	36
12	8	10-KFH12U-00	17	19	45.5	32	19.3	7	35	42

Male Elbow: 10-KFL

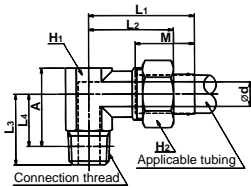

Applicable tubing size (mm)		Connection thread R	Model	H ₁ (width across flats)	H ₂ (width across flats)	L ₁	L ₂	L ₃	L ₄ *	M	d	A *	Effective area (mm ²)	Weight (g)	
O.D.	I.D.														
4	2.5	1/8	10-KFL04-01	10	10	27.5	20.8	17	13	15.5	1.5	19.3	1.6	21	
		1/4	10-KFL04-02												19
6	4	1/8	10-KFL06-01	10	12	27.2	20.5	17	13	15.2	3	19.3	6	22	
		1/4	10-KFL06-02												19
		3/8	10-KFL06-03												20
8	5	1/8	10-KFL08U-01	12	14	28.2	21.5	18	14	16.2	4	21.3	9.5	30	
		1/4	10-KFL08U-02												21
		3/8	10-KFL08U-03												20
10	6.5	1/4	10-KFL10U-02	12	17	31.8	24.5	22	16	18.8	5.5	23.3	18	38	
		3/8	10-KFL10U-03												21
		1/2	10-KFL10U-04												25
12	8	1/4	10-KFL12U-02	14	19	34.3	27.5	23	17	19.3	7	25.5	24	53	
		3/8	10-KFL12U-03												22
		1/2	10-KFL12U-04												25

* Reference dimensions after R thread installation.

Insert Fittings 10-KF

Bulkhead Connector: 10-KFE

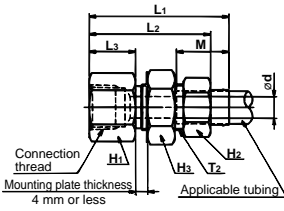

Applicable tubing size (mm)		Connection thread Rc	Model	H ₁	H ₂	H ₃	L ₁	L ₂	L ₃	M	d	T ₂	Mounting hole	Effective area (mm ²)	Weight (g)
O.D.	I.D.			(width across flats)	(width across flats)	(width across flats)									
6	4	1/4	10-KFE06-02	17	12	17	44.2	37.5	16	15.2	3	M10 x 1	11	6	41
8	5	3/8	10-KFE08U-03	19	14	19	46.2	39.5	17	16.2	4	M12 x 1	13	11	49
10	6.5	3/8	10-KFE10U-03	19	17	22	48.8	41.5	17	18.8	5.5	M15 x 1	16	21	63
12	8	3/8	10-KFE12U-03	22	19	24	51.3	44.5	17	19.3	7	M17 x 1	18	35	93

Bulkhead Union: 10-KFE

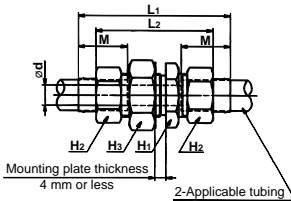

Applicable tubing size (mm)		Model	H ₁	H ₂	H ₃	L ₁	L ₂	M	d	Mounting hole	Effective area (mm ²)	Weight (g)
O.D.	I.D.		(width across flats)	(width across flats)	(width across flats)							
4	2.5	10-KFE04-00	12	10	13	50.9	37.6	15.5	1.5	9	1.6	23
6	4	10-KFE06-00	14	12	17	51.3	38	15.2	3	11	6	34
8	5	10-KFE08U-00	17	14	19	52.3	39	16.2	4	13	11	47
10	6.5	10-KFE10U-00	19	17	22	56.6	42	18.8	5.5	16	21	67
12	8	10-KFE12U-00	22	19	24	59.5	46	19.3	7	18	35	87

Male Run Tee: 10-KFY

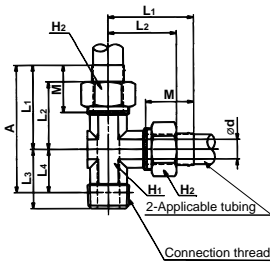

Applicable tubing size (mm)		Connection thread R	Model	H ₁	H ₂	L ₁	L ₂	L ₃	L ₄ *	M	d	A*	Effective area (mm ²)	Weight (g)						
O.D.	I.D.			(width across flats)	(width across flats)															
4	2.5	1/8	10-KFY04-01	10	10	27.5	20.8	17	13	15.5	1.5	40.5	3.5	28						
	1/4		10-KFY04-02												17	31				
6	4	1/8	10-KFY06-01	10	12	27.2	20.5	17	13	15.2	3	40.2	11	37						
			1/4												10-KFY06-02	19	37			
	3/8	10-KFY06-03	30.2												23.5	22	15.7	45.8	13	51
		10-KFY08U-01	20												16	47.2	15	48		
8	5	1/4	10-KFY08U-02	12	14	30.2	23.5	23	17	16.2	4	46.2	21	50						
			10-KFY08U-03												22	15.7	48.8	21	55	
	3/8	10-KFY10U-02	23												17	48.8	21	58		
10	6.5	3/8	10-KFY10U-03	12	17	31.8	24.5	22	15.7	18.8	5.5	47.4	30	89						
			10-KFY10U-04												27	18.8	52.6	38	89	
	1/2	10-KFY12U-02	25												19	53.3	34	79		
	1/4	10-KFY12U-03	24												17.7	51.9	49	79		
12	8	3/8	10-KFY12U-03	14	19	34.3	27.5	24	17.7	19.3	7	51.9	49	79						
			10-KFY12U-04												27	18.8	53.1	49	93	

* Reference dimensions after R thread installation.

Plug: 10-KFP



Applicable fitting size (mm)	Model	L	D	Weight (g)
4	10-KFP-04	12	6.5	0.3
6	10-KFP-06	12	8.5	0.5
8	10-KFP-08	12	10.4	0.7
10	10-KFP-10	13.5	13	1.0
12	10-KFP-12	14	15	1.4

Union Tee: 10-KFT

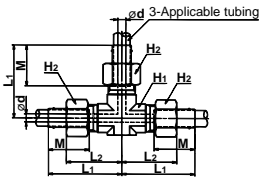

Applicable tubing size (mm)		Model	H ₁	H ₂	L ₁	L ₂	M	d	Effective area (mm ²)	Weight (g)
O.D.	I.D.		(width across flats)	(width across flats)						
4	2.5	10-KFT04-00	10	10	27.5	20.8	15.5	1.5	1.6	33
6	4	10-KFT06-00		12	27.2	20.5	15.2	3	6	37
8	5	10-KFT08U-00	12	14	30.2	23.5	16.2	4	11	54
10	6.5	10-KFT10U-00	12	17	31.8	24.5	18.8	5.5	21	65
12	8	10-KFT12U-00	14	19	34.3	27.5	19.3	7	35	89

Directional Control Valves
Air Cylinders

Male Branch Tee: 10-KFT

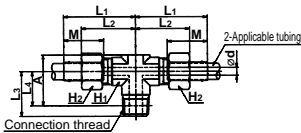

Applicable tubing size (mm)		Connection thread R	Model	H ₁	H ₂	L ₁	L ₂	L ₃	L ₄ *	M	d	A*	Effective area (mm ²)	Weight (g)						
O.D.	I.D.			(width across flats)	(width across flats)															
4	2.5	1/8	10-KFT04-01	10	10	27.5	20.8	17	13	15.5	1.5	19.3	3	29						
		1/4	10-KFT04-02												19	3	34			
6	4	1/8	10-KFT06-01	10	12	27.2	20.5	17	13	15.2	3	19.3	10	37						
		1/4	10-KFT06-02												19	3	53			
8	5	3/8	10-KFT06-03	12	14	30.2	23.5	22	15.7	16.2	4	23	12	57						
		1/8	10-KFT08U-01												20	16	23.3	14	49	
		1/4	10-KFT08U-02												23	17	24.3	19	50	
		3/8	10-KFT08U-03												23	17	23	19	56	
10	6.5	1/4	10-KFT10U-02	12	17	31.8	24.5	23	17	18.8	5.5	24.3	27	46						
		3/8	10-KFT10U-03												22	15.7	18.8	23	34	63
		1/2	10-KFT10U-04												33.8	26.5	27	18.8	27.3	31
12	8	1/4	10-KFT12U-02	14	19	34.3	27.5	25	19	19.3	7	26.2	44	81						
		3/8	10-KFT12U-03												24	17.7	27.3	31	79	
		1/2	10-KFT12U-04												27	18.8	27.3	44	94	

* Reference dimensions after R thread installation.

Rotary Actuators
Air Grippers
Air Preparation Equipment

Female Connector: 10-KFF

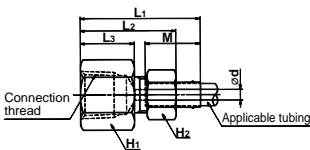

Applicable tubing size (mm)		Connection thread Rc	Model	H ₁	H ₂	L ₁	L ₂	L ₃	M	d	Effective area (mm ²)	Weight (g)
O.D.	I.D.			(width across flats)	(width across flats)							
4	2.5	1/4	10-KFF04-02	17	10	33.5	26.8	15	15.5	1.5	1.6	25
6	4	1/4	10-KFF06-02	17	12	33.2	26.5	15	15.2	3	6	27
		3/8	10-KFF06-03									
8	5	1/4	10-KFF08U-02	17	14	33.2	26.5	15	16.2	4	11	28
10	6.5	1/4	10-KFF10U-02	17	17	34.8	27.5	15	18.8	5.5	21	32
12	8	1/4	10-KFF12U-02	17	19	35.3	28.5	15	19.3	7	35	35

Modular F. R.
Pressure Control Equipment
Fittings & Tubing

Flow Control Equipment
Pressure Switches/ Pressure Sensors

Swivel Elbow: 10-KFV

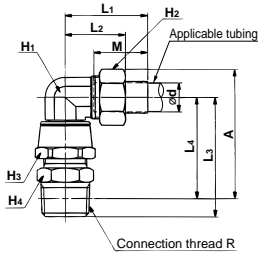

Applicable tubing size (mm) O.D., I.D.	Connection thread R	Model	H1 (inch)	H2 (inch)	H3 (inch)	H4 (inch)	L1	L2	L3	L4 *	M	d	A *	Effective area (mm ²)	Weight (g)	
4 2.5	1/8	10-KFV04-01	10	10	14	10	26	19.3	32.8	29.7	15.5	1.5	35.5	1.4	40	
	1/4	10-KFV04-02				14			37.2	31.7						37.5
6 4	1/8	10-KFV06-01	10	12	14	10	25.7	19	32.8	29.7	15.2	3	36.6	5	42	
	1/4	10-KFV06-02				14			37.2	31.7						38.6
	3/8	10-KFV06-03				17			37.6	32.4						39.3
8 5	1/8	10-KFV08U-01	12	14	17	12	27.2	20.5	33.8	30.7	16.2	4	40.8	9.4	52	
	1/4	10-KFV08U-02				14			38.2	32.7						41.5
	3/8	10-KFV08U-03				17			38.6	33.4						41.5
10 6.5	1/4	10-KFV10U-02	14	17	19	17	28.8	21.5	40.2	34.7	18.8	5.5	44.5	18	81	
	3/8	10-KFV10U-03				22			40.6	35.4						45.2
	1/2	10-KFV10U-04				22			43.8	36.5						46.3
12 8	1/4	10-KFV12U-02	17	19	22	17	30.3	23.5	41.2	35.7	19.3	7	47.4	30	100	
	3/8	10-KFV12U-03				22			41.6	36.4						48.5
	1/2	10-KFV12U-04				22			44.8	37.5						48.5

* Reference dimensions after R thread installation.

Swivel Extended Elbow: 10-KFW

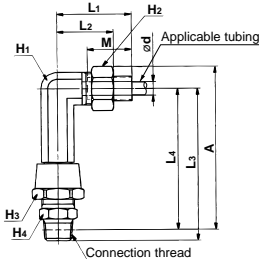

Applicable tubing size (mm) O.D., I.D.	Connection thread R	Model	H1 (inch)	H2 (inch)	H3 (inch)	H4 (inch)	L1	L2	L3	L4 *	M	d	A *	Effective area (mm ²)	Weight (g)	
4 2.5	1/8	10-KFW04-01	10	10	14	10	26	19.3	52.8	49.7	15.5	1.5	55.5	1.4	58	
	1/4	10-KFW04-02				14			57.2	51.7						57.5
6 4	1/8	10-KFW06-01	10	12	14	10	25.7	19	53.8	50.7	15.2	3	57.6	5	61	
	1/4	10-KFW06-02				14			58.2	52.7						59.6
	3/8	10-KFW06-03				17			58.6	53.4						60.3
8 5	1/8	10-KFW08U-01	12	14	17	12	27.2	20.5	54.8	51.7	16.2	4	59.8	9.4	83	
	1/4	10-KFW08U-02				14			59.2	53.7						62.5
	3/8	10-KFW08U-03				17			59.6	54.4						62.5
10 6.5	1/4	10-KFW10U-02	14	17	19	17	28.8	21.5	61.2	55.7	18.8	5.5	65.5	18	106	
	3/8	10-KFW10U-03				22			61.6	56.4						66.2
	1/2	10-KFW10U-04				22			64.8	57.5						67.3
12 8	1/4	10-KFW12U-02	17	19	22	17	30.3	23.5	64.2	58.7	19.3	7	70.4	30	146	
	3/8	10-KFW12U-03				22			64.6	59.4						71.5
	1/2	10-KFW12U-04				22			67.8	60.5						71.5

* Reference dimensions after R thread installation.

Series 10-M

Miniature Fittings

RoHS

Construction



Hose nipple

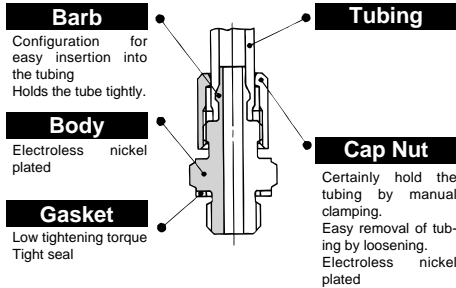

Barb fitting

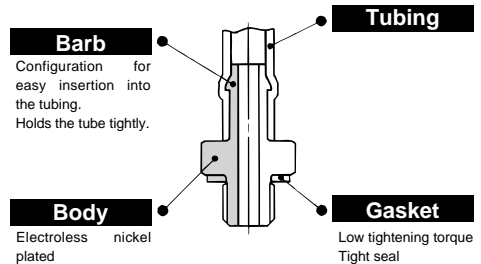

Specifications

Tubing material		Polyurethane
Fluid		Air, Water ^{Note}
Applicable tubing	M3	ø3.18/ø2, ø4/ø2.5
	M5-R1/8	ø3.18/ø2 ø4/ø2.5, ø6/ø4
Max. operating pressure (at 20°C)		0.8 MPa
Ambient and fluid temperature		-5 to 60°C, Water: 0 to 40°C (No freezing)
Connection size		M3, M5, R1/8
Grease		Fluorine grease (10-M-5UN only)
Cleanliness class (ISO class)		Class 3

Note) Barb fitting, barb elbow, barb elbow (H) are not compatible with water.

Principal Parts Materials

Material	Body	Electroless nickel plated C3604BD (Nipple 10-M-3N, 10-M-5N: Stainless steel 303)
	Gasket	Nylon 66, GF30%, Stainless steel 304 + NBR

Directional Control Valves

Air Cylinders

Rotary Actuators

Air Grippers

Air Preparation Equipment

Modular F. R.

Pressure Control Equipment









Fittings & Tubing





Flow Control Equipment

Pressure Switches/
Pressure Sensors

















Miniature Fittings 10-M











Series M3, R1/8

Series	Model	Description	Application	Note
M3	10-M-3AU-3	Barb fitting for polyurethane tubing 	For piping polyurethane tubing	ø3.18/2 x M3
	10-M-3AU-4			ø4/2.5 x M3
	10-M-3ALU-3	Barb elbow for polyurethane tubing 	Body rotates at 360° around the stud axis. For piping polyurethane tubing	ø3.18/2 x M3
	10-M-3ALU-4			ø4/2.5 x M3
	10-M-3UL	Universal elbow 	Body rotates at 360° around the stud axis.	M3 female x M3 male
	10-M-3UT	Universal tee 	Body rotates at 360° around the stud axis.	M3 female x M3 female x M5 male
	10-M-3N	Nipple 	Connection for fitting to workpiece and fitting to fitting	M3 male x M5 male
	10-M-3P	Plug 	Use to plug unused M3 port	
	10-M-3G2	Gasket 	To seal M3 thread	Material: Stainless steel 304 + NBR

Series	Model	Description	Application	Note
R 1/8	10-M-01AU-4	Barb fitting for polyurethane tubing 	For polyurethane tubing	ø4/2.5 x R1/8
	10-M-01AU-6			ø6/4 x R1/8
	10-M-01H-4	Hose nipple 		ø4/2.5 x R1/8
	10-M-01H-6			ø6/4 x R1/8

Series M5

Series	Model	Description	Application	Note
M5	10-M-5AU-3	Barb fitting for polyurethane tubing 	For piping polyurethane tubing	ø3.18/2 x M5
	10-M-5AU-4			ø4/2.5 x M5
	10-M-5AU-6			ø6/4 x M5
	10-M-5ALU-3	Barb elbow for polyurethane tubing 	Body rotates at 360° around the stud axis. For piping polyurethane tubing	ø3.18/2 x M5
	10-M-5ALU-4			ø4/2.5 x M5
	10-M-5ALU-6			ø6/4 x M5
	10-M-5ALHU-3	Barb elbow (H) for polyurethane tubing 	Body rotates at 360° around the stud axis. For piping polyurethane tubing	ø3.18/2 x M5
	10-M-5ALHU-4			ø4/2.5 x M5
	10-M-5ALHU-6			ø6/4 x M5
	10-M-5H-4	Hose nipple 	For piping polyurethane tubing	ø4/2.5 x M5
10-M-5H-6		ø6/4 x M5		
10-M-5HL-4	Hose elbow 	For piping polyurethane tubing	ø4/2.5 x M5	
10-M-5HL-6			ø6/4 x M5	
10-M-5HLH-4	Hose elbow (H) 		Body rotates at 360° around the stud axis.	ø4/2.5 x M5
10-M-5HLH-6			ø6/4 x M5	
10-M-5L	Elbow 	One-sided 90° elbow	M5 female x M5 female	

Series	Model	Description	Application	Note
M5	10-M-5T	Tee 	Both sides allow 90° connection	M5 female x M5 female
	10-M-5UL	Universal elbow 	Body rotates at 360° around the stud axis.	M5 female x M5 male
	10-M-5UT	Universal tee 	Body rotates at 360° around the stud axis.	M5 female x M5 male
	10-M-5J	Extension fitting 	Solid piece moves fitting up from workpiece	M5 male x M5 female
	10-M-5N	Nipple 	Connection for fitting to workpiece and fitting to fitting	M5 male x M5 male
	10-M-5UN	Universal nipple 	Body rotates at 360° around the center of axis.	M5 male x M5 male PAT.
	10-M-5B	Bushing 	For reducing R1/8 female to M5	R1/8 x M5 female
	10-M-5P	Plug 	Use to plug unused M5 port	
	10-M-5G2	Gasket 	To seal M5 thread	Material: Stainless steel 304 + NBR
	10-M-5GH	Gasket (H) 	10-M-5ALU-6 10-M-5ALHU-6 10-M-5HL-4, 6 10-M-5HLH-4, 6	Material: Nylon 66, GF30%

Series M3

Barb Fitting for Polyurethane Tubing: 10-M-3AU-3

Effective area: 0.9 mm²
Weight: 0.6 g

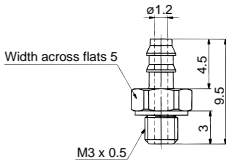

Barb Fitting for Polyurethane Tubing: 10-M-3AU-4

Effective area: 0.9 mm²
Weight: 0.7 g

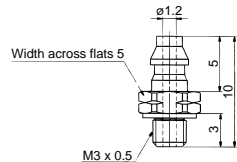

Barb Elbow for Polyurethane Tubing: 10-M-3ALU-3

Effective area: 0.6 mm²
Weight: 0.8 g

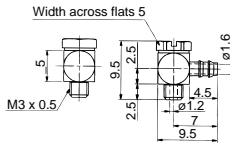

Barb Elbow for Polyurethane Tubing: 10-M-3ALU-4

Effective area: 0.6 mm²
Weight: 0.9 g

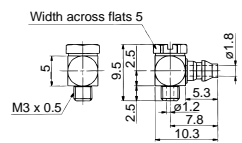

Universal Elbow: 10-M-3UL

Effective area: 0.6 mm²
Weight: 1.6 g

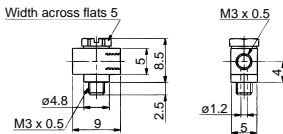

Universal Tee: 10-M-3UT

Effective area: 0.6 mm²
Weight: 1.4 g

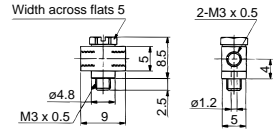

Nipple: 10-M-3N

Effective area: 0.9 mm²
Weight: 0.6 g

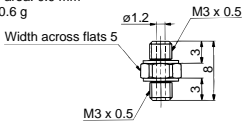

Gasket: 10-M-3G2

Weight: 0.03 g



Plug: 10-M-3P

Weight: 0.5 g

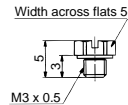

Series R1/8

Barb Fitting for Polyurethane Tubing: 10-M-01AU-4, -6

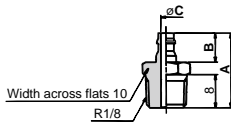

Model	A	B	C	Effective area (mm ²)	Weight (g)
10-M-01AU-4	15.1	5	1.8	2.1	6.5
10-M-01AU-6	17.1	7	2.5	4.0	6.7

Hose Nipple: 10-M-01H-4, -6

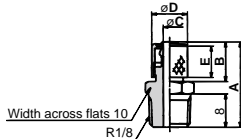

Model	A	B	C	D	E	Effective area (mm ²)	Weight (g)
10-M-01H-4	18.6	8.5	1.8	6.5	7	2.1	7.1
10-M-01H-6	19.6	9.5	3	8.5	8	5.5	7.7

Directional Control Valves

Air Cylinders

Rotary Actuators

Air Grippers

Air Preparation Equipment

Modular F. R.

Pressure Control Equipment

Fittings & Tubing

Flow Control Equipment

Pressure Switches/ Pressure Sensors

Series M5

Barb Fitting for Polyurethane Tubing: 10-M-5AU-3, -4, -6

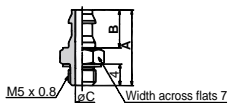

Model	A	B	C	Effective area (mm ²)	Weight (g)
10-M-5AU-3	11.5	4.5	1.6	1.7	1.5
10-M-5AU-4	12	5	1.8	2.1	1.6
10-M-5AU-6	14	7	2.5	4.0	1.8

Barb Elbow for Polyurethane Tubing: 10-M-5ALU-3, -4, -6

10-M-5ALU-3,-4

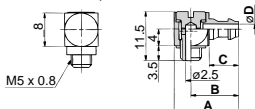

10-M-5ALU-6

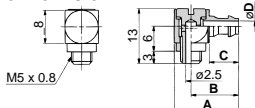

Model	A	B	C	D	Effective area (mm ²)	Weight (g)
10-M-5ALU-3	13	9	4.5	1.6	1.1	4.0
10-M-5ALU-4	13.5	9.5	5	1.8	1.4	4.1
10-M-5ALU-6	15.5	11.5	7	2.5	2.4	4.5

Barb Elbow for Polyurethane Tubing: 10-M-5ALHU-3, -4, -6

10-M-5ALHU-3,-4

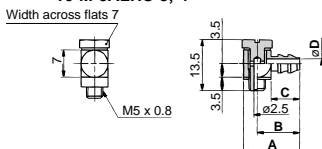

10-M-5ALHU-6

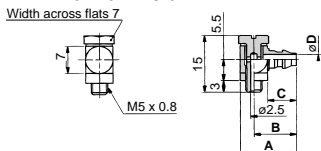

Model	A	B	C	D	Effective area (mm ²)	Weight (g)
10-M-5ALHU-3	12	8.5	4.5	1.6	1.1	3.2
10-M-5ALHU-4	12.5	9	5	1.8	1.4	3.3
10-M-5ALHU-6	14.5	11	7	2.5	2.4	3.9

Hose Nipple: 10-M-5H-4, -6

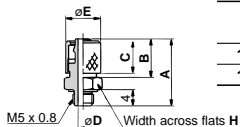

Model	A	B	C	D	E	H	Effective area (mm ²)	Weight (g)
10-M-5H-4	15.5	8.5	7	1.8	6.5	7	2.1	2.7
10-M-5H-6	16.5	9.5	8	2.5	8.5	8	4.0	3.9

Series M5

Bushing: 10-M-5B

Weight: 5.8 g

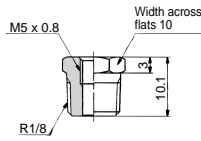

Plug: 10-M-5P

Weight: 1.3 g

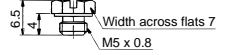

Gasket: 10-M-5G2

Weight: 0.04 g



Gasket: 10-M-5GH

Weight: 0.04 g



Series 10-KDM

Rectangular Multi-connector
Number of Connecting Tubes: 10, 20

RoHS

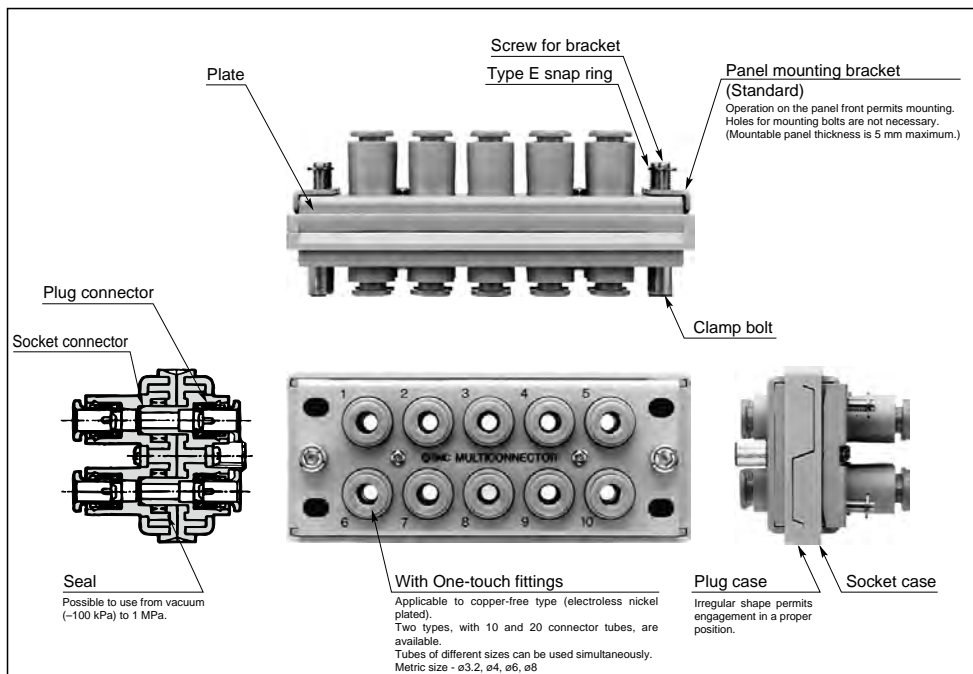

Directional Control Valves

Air Cylinders

Rotary Actuators

Air Grippers

Air Preparation Equipment

Modular F. R.

Model

Number of connecting tubes		Tubing O.D.	Model	Weight	Color of release button
10	Metric size	ø3.2	10-KDM10-23	300 g	White
		ø4	10-KDM10-04		
		ø6	10-KDM10-06		
20	Metric size	ø8	10-KDM10-08	520 g	White
		ø3.2	10-KDM20-23	520 g	
		ø4	10-KDM20-04		
		ø6	10-KDM20-06		
		ø8	10-KDM20-08	950 g	

Applicable Tubing Material

Tubing material		Polyurethane
Tubing O.D.	Metric size	ø3.2, ø4, ø6, ø8

Specifications

Fluid	Air
Operating pressure range (Note)	-100 kPa to 1 MPa
Proof pressure	1.5 MPa
Ambient and fluid temperature	-5 to 60°C (No freezing)
Grease	Fluorine grease
Cleanliness class (ISO class)	Class 5

Note) Do not use the S couplers with a leak tester or for vacuum retention because they are not guaranteed for zero leakage.

Pressure Control Equipment

Fittings & Tubing

Flow Control Equipment

Pressure Switches/ Pressure Sensors

Rectangular Multi-connector 10-KDM

Principal Parts Material

Plug case, socket case		POM
Plate, bracket		SPCC plated
Plug connector, socket connector	Body	PBT, C3604BD electroless nickel plated ($\phi 8$, $\phi 5/16$)
	Chuck	Stainless steel 304
	Guide	PBT ($\phi 8$, $\phi 5/16$), Stainless steel 304
	Collet, Release button	POM
	Seal	NBR
Clamp bolt, Screw for bracket, Cross-recessed round head screw		SWRM nickel plated
Type E snap ring		Stainless steel 304

Part No.

Number of connection tubes	Tubing O.D.	Part no.		Color of release button
		Plug	Socket	
10	$\phi 3.2$	10-KDM10P-23	10-KDM10S-23	White
	$\phi 4$	10-KDM10P-04	10-KDM10S-04	
	$\phi 6$	10-KDM10P-06	10-KDM10S-06	
	$\phi 8$	10-KDM10P-08	10-KDM10S-08	
20	$\phi 3.2$	10-KDM20P-23	10-KDM20S-23	
	$\phi 4$	10-KDM20P-04	10-KDM20S-04	
	$\phi 6$	10-KDM20P-06	10-KDM20S-06	
	$\phi 8$	10-KDM20P-08	10-KDM20S-08	

Mixed Sizes of Plug Connectors and Socket Connectors

The rectangular multi-connector permits connector exchange in any desired position, thus allowing use of different sizes of tubes.

Part No.

Connector	Tubing O.D.	Part no.	Color of release button
Plug connector	$\phi 3.2$	10-KDMP-23	White
	$\phi 4$	10-KDMP-04	
	$\phi 6$	10-KDMP-06	
	$\phi 8$	10-KDMP-08	
Socket connector (with seal)	$\phi 3.2$	10-KDMS-23	
	$\phi 4$	10-KDMS-04	
	$\phi 6$	10-KDMS-06	
	$\phi 8$	10-KDMS-08	

(1) Loosen the cross-recessed round head screws using a Phillips screwdriver to remove the plate from the case.

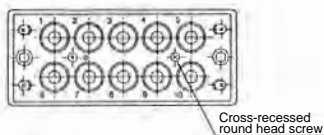

(2) After exchanging connectors in desired places, fix the plate to the case by using a Phillips screwdriver.

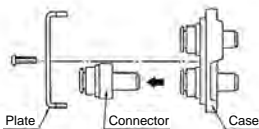

⚠ Specific Product Precautions

Be sure to read this before handling.

How to Use

⚠ Caution

1. Separation

Loosen the clamp bolt to separate the plug side from the socket side.

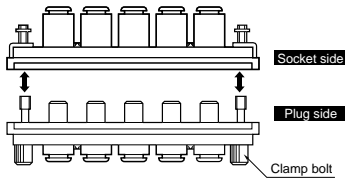

2. Connection

Put together the irregular faces for engagement and connect the plug case to the socket. After tightening the clamp bolt by hand, tighten it further with an Allen wrench (nominal width across flats: 4).

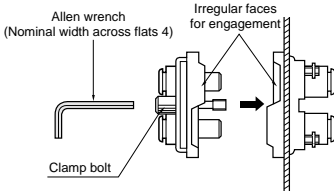

3. Panel mounting

1) Loosen 4 screws for bracket on the socket side using a Phillips screwdriver (JIS nominal No. 2) until the bracket touches the snap ring.

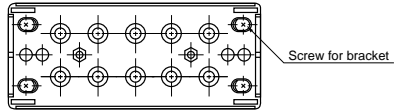

2) Shift the panel mounting bracket to the inside (move the screw for bracket in the longitudinal direction of the slot) and put the connector in the panel mounting hole. (Please refer to the panel mounting hole "Dimensions".)

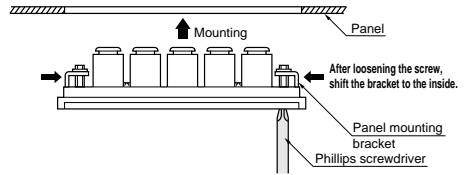

3) After shifting the bolt for bracket to the outside, tighten the bolt by a Phillips screwdriver to fix the socket case.

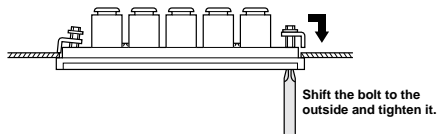

4) Loosen the screw for bracket until the bracket touches the snap ring and shift the bracket to the inside to remove the connector from the panel.

Directional Control Valves

Air Cylinders

Rotary Actuators

Air Grippers

Air Preparation Equipment

Modular F. R.

Pressure Control Equipment

Fittings & Tubing

Flow Control Equipment

Pressure Switches/ Pressure Sensors

Rectangular Multi-connector 10-KDM

Dimensions

10-KDM10

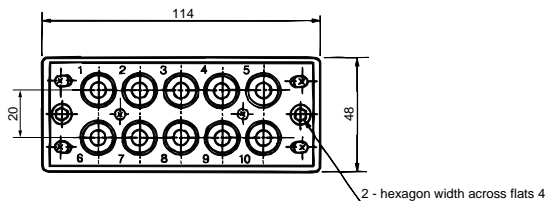
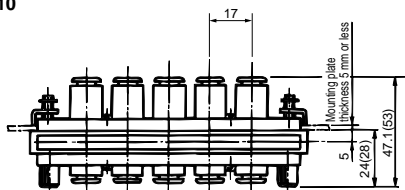

() : Dimensions for 10-KDM10-08.

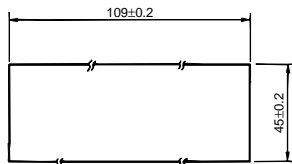

Panel mounting hole

10-KDM20

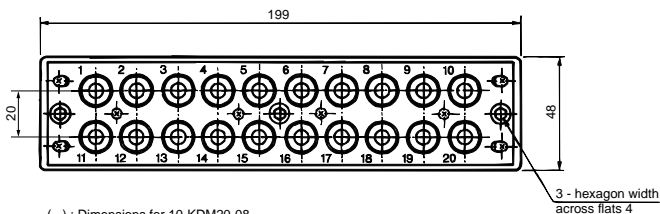
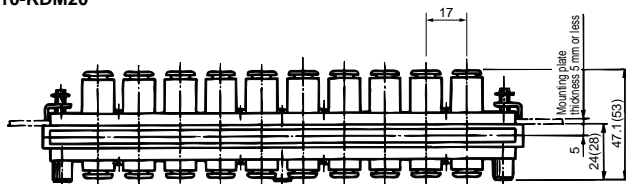

() : Dimensions for 10-KDM20-08.

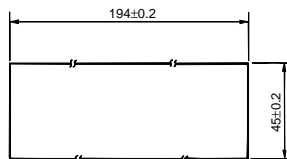

Panel mounting hole

Made to Order

Please contact SMC for specifications in detail, dimensions and delivery.

■ Mixed tubing sizes

Please contact SMC when mixed tube size manifolds are required since it is Made to Order.

Series 10-KG Stainless One-touch Fittings

RoHS

Construction

Guide
Collet
Chuck

Large retaining force

Has large retaining force while holding force is increased by the collet.

Seal

Can be used for a wide range of pressures from a low vacuum up to a pressure of 1.0 MPa

The use of a special profile ensures sealing and reduces resistance when the tube is inserted.

Stainless specifications applicable to corrosive environments

Stainless steel 303 adopted for metal elements

Suitable for use in CRT production lines where contact with copper must be avoided, food processing machines where water or salt water splashes and clean room where discoloration of copper material and corrosion must be avoided.

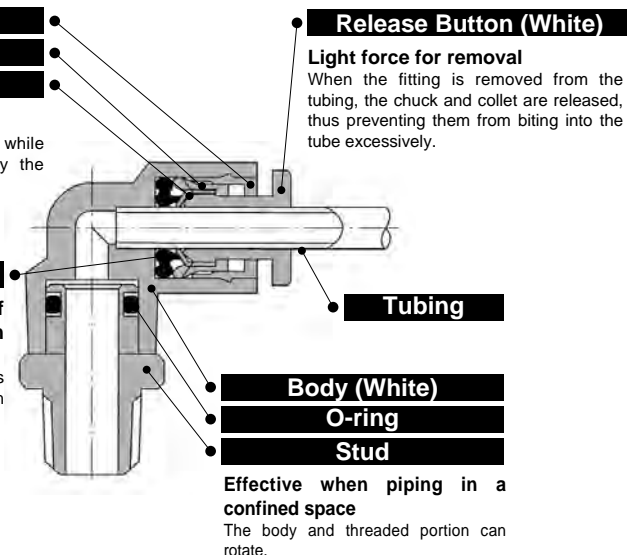

Applicable Tubing

Tubing material	Polyurethane
Tubing O.D.	ø4, ø6, ø8, ø10, ø12, ø16

Specifications

Fluid	Air, Water ^{Note 1)}	
Maximum operating pressure	1.0 MPa	
Operating vacuum pressure	-100 kPa	
Proof pressure	3.0 MPa	
Ambient and fluid temperature	-5 to 60°C, Water: 0 to 40°C (No freezing)	
Thread	Mounting section	JIS B0203 (Taper thread for piping)
	Nut section	JIS B0211 Class 2 (Metric fine thread)
Seal (Thread portion)	With seal or none ^{Note 2)}	
Grease	Fluorine grease	
Cleanliness class (ISO class)	Class 5	

Note 1) Applicable for general industrial water. Please consult with SMC if using for other kinds of fluid.

Also, the surge pressure must be under the maximum operating pressure.

Note 2) Suffix "S" to the part number, if w/ seal is desired.

Principal Parts Material

Body	Stainless steel 303, PBT
Stud	Stainless steel 303 (Thread portion)
Chuck	Stainless steel 304
Guide	Stainless steel 304, POM
Collet, Release button	POM
Seal, O-ring	NBR

Directional Control Valves

Air Cylinders

Rotary Actuators

Air Grippers

Air Preparation Equipment

Modular F. R.

Pressure Control Equipment

Fittings & Tubing

Flow Control Equipment

Pressure Switches/ Pressure Sensors

Model

Hex. socket head male connector
10-KGS

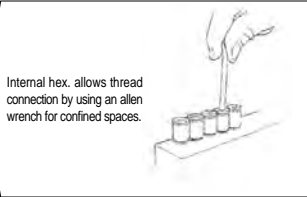

Internal hex. allows thread connection by using an allen wrench for confined spaces.

Universal male elbow
10-KGV

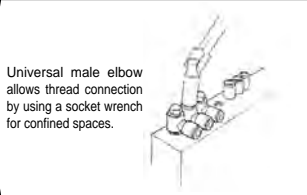

Universal male elbow allows thread connection by using a socket wrench for confined spaces.

Bulkhead union
10-KGE

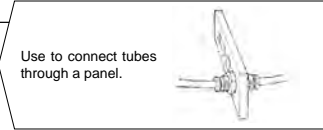

Use to connect tubes through a panel.

Extended male elbow
10-KGW

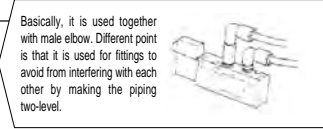

Basically, it is used together with male elbow. Different point is that it is used for fittings to avoid from interfering with each other by making the piping two-level.

Bulkhead connector
10-KGE

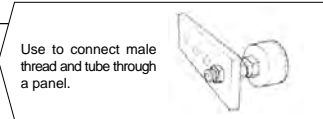

Use to connect male thread and tube through a panel.

Male connector
10-KGH



Use to pipe in the same direction from female thread. Most general model.

Male elbow
10-KGL



Use to pipe at right angles to female thread. Most general model.

Male branch tee
10-KGT



Use to branch line from female thread in both 90° directions.

Female connector
10-KGF



Use to pipe from male thread such as pressure gauge.

Union elbow
10-KGL



Use to connect tubes at right angles.

Union tee
10-KGT



Use to connect tubes in both 90° directions.

Straight union
10-KGH



Use to connect tubes in the same direction.

Plug-in elbow
10-KGL



Use to change by 90° in a tube fetching direction from One-touch fittings.

Different diameter tee
10-KGT



Use to connect tubes with size down in both 90° directions.

Different diameter straight
10-KGH



Use to connect different size tubes.

Male delta union
10-KGD



Use to branch line in 90° direction from female thread.

Male run tee
10-KGY



Use to branch line in the same direction from female thread and in 90° direction.

Male branch connector
10-KGLU



Use to branch line at right angles to female thread.

Delta union
10-KGD



Use to branch line in triple 90° direction.

Different diameter double union "Y"
10-KGUD



Use to four-branch line in the same direction.

Branch union elbow
10-KGLU



Use to branch line at right angles.

Double branch "Y"
10-KGUD



Use to four-branch line in the same direction from female thread.

Union "Y"
10-KGU



Use to branch line in the same direction.

Model

Different diameter union "Y"

10-KGU



Use to connect tubes in the same direction, reducing the size of tubes.

Plug-in reducer

10-KGR



Use to change size of One-touch fittings.

Tube cap

10-KGC



Use to plug unused tubing.

Branch "Y"

10-KGU



Use to branch line in the same direction from the female thread.



Male Connector: 10-KGH

M5

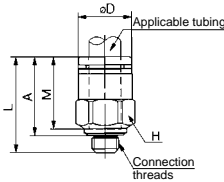

R

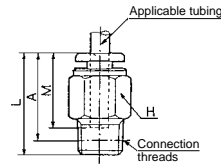

Applicable tubing O.D. (mm)	Connection thread R	Model	H (width across flats)	øD ^(Note 1)	L	A *	M	Effective area (mm ²)		Weight (g)
								Urethane		
4	M5 x 0.8	10-KGH04-M5	8	8	17	13.9	12.7	4	2.4	
	1/8	10-KGH04-01	10	—	21.1	18	16	4	9	
	1/4	10-KGH04-02	14	—	19	13.5	16	4	16	
6	M5 x 0.8	10-KGH06-M5	10	10	17.8	14.7	13.5	4	3.4	
	1/8	10-KGH06-01	12	—	21.6	18.5	17	10.4	16	
	1/4	10-KGH06-02	14	—	22.5	17	17	10.4	14	
	3/8	10-KGH06-03	17	—	20.9	15.5	17	10.4	27	
8	1/8	10-KGH08-01	14	—	27.1	24	18.5	18.0	21	
	1/4	10-KGH08-02	17	—	26	20.5	18.5	18.0	19	
	3/8	10-KGH08-03	17	—	20.9	15.5	18.5	18.0	26	
10	1/8	10-KGH10-01	17	—	29.1	26	21	29.5	19	
	1/4	10-KGH10-02	17	—	33	27.5	21	29.5	30	
	3/8	10-KGH10-03	17	—	27.9	22.5	21	29.5	30	
	1/2	10-KGH10-04	22	—	26.1	19	21	29.5	53	
12	1/4	10-KGH12-02	19	—	34	28.5	22	46.1	42	
	3/8	10-KGH12-03	19	—	28.9	23.5	22	46.1	34	
	1/2	10-KGH12-04	22	—	29.1	22	22	46.1	51	
16	3/8	10-KGH16-03	24	—	38.4	33	25	80.6	68	
	1/2	10-KGH16-04	24	—	34.6	27.5	25	80.6	61	

* Reference dimensions after R thread installation.
Note 1) øD indicates the maximum diameter.

Hexagon Socket Head Male Connector: 10-KGS

M5

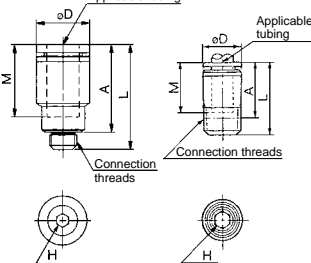

Applicable tubing O.D. (mm)	Connection thread R	Model	H (width across flats)	øD ^(Note 1)	L	A *	M	Effective area (mm ²)		Weight (g)
								Urethane		
4	M5 x 0.8	10-KGS04-M5	2.5	8	18.7	15.6	12.7	4	2.6	
	1/8	10-KGS04-01	3	9.8	23	19	16	3.6	8	
6	M5 x 0.8	10-KGS06-M5	2.5	10	19.5	16.4	13.5	4	3.2	
	1/8	10-KGS06-01	4	11.8	24	20	17	9.9	9	
	1/4	10-KGS06-02	4	13.8	18	18	17	10.0	15	
8	1/8	10-KGS08-01	5	—	28	24	18.5	16.2	12	
	1/4	10-KGS08-02	6	14	25.5	19.5	18.5	16.2	11	
	3/8	10-KGS08-03	6	14	27.5	21.5	18.5	16.2	24	
10	1/8	10-KGS10-01	5	—	30	26	21	16.2	18	
	1/4	10-KGS10-02	8	17	27.5	21.5	21	26.6	12	
	3/8	10-KGS10-03	8	17	27.5	21.5	21	26.6	19	
	1/2	10-KGS10-04	8	22	28	20	21	26.6	35	
12	1/4	10-KGS12-02	8	19	33.5	27.5	22	44.5	23	
	3/8	10-KGS12-03	10	19	29	22.5	22	44.5	18	
	1/2	10-KGS12-04	10	22	28	20	22	44.5	30	

* Reference dimensions after R thread installation.
Note 1) øD indicates the maximum diameter.

Directional Control Valves

Air Cylinders

Rotary Actuators

Air Grippers

Air Preparation Equipment

Modular F. R.

Pressure Control Equipment

Fittings & Tubing

Flow Control Equipment

Pressure Switches/ Pressure Sensors

Female Connector: 10-KGF

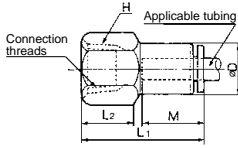

Applicable tubing O.D. (mm)	Connection thread Rc	Model	H (width across flats)	øD ^(Note)	L ₁	L ₂	M	Effective area (mm ²)	Weight (g)	
								Urethane		
4	1/8	10-KGF04-01	14	10	27	11	16	4	15	
	1/4	10-KGF04-02	17		31	14			23	
6	1/8	10-KGF06-01	14	12	27.5	11	17	10.4	15	
	1/4	10-KGF06-02	17		31	13			22	
	3/8	10-KGF06-03	19		33.5	15			25	
8	1/8	10-KGF08-01	14	14	29	11	18.5	18.0	17	
	1/4	10-KGF08-02	17		32.5	13			24	
	3/8	10-KGF08-03	19		33.5	14			24	
10	1/4	10-KGF10-02	17	17	34.5	14	21	29.5	27	
	3/8	10-KGF10-03	19		36.5	15			30	
	1/2	10-KGF10-04	22		37	14			31	
12	1/4	10-KGF12-02	19	19	35	14	22	46.1	36	
	3/8	10-KGF12-03	19		37				14	31
	1/2	10-KGF12-04	24		41				18	52

Note) øD indicates the maximum diameter.

Straight Union: 10-KGH

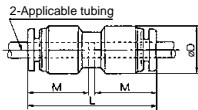

Applicable tubing O.D. (mm)	Model	øD ^(Note)	L	M	Effective area (mm ²)	Weight (g)
					Urethane	
4	10-KGH04-00	10.4	32.5	16	4	3
6	10-KGH06-00	12.8	34.5	17	10.4	4
8	10-KGH08-00	15.2	38.5	18.5	18.0	6
10	10-KGH10-00	18.5	42.5	21	29.5	11
12	10-KGH12-00	20.9	44.5	22	46.1	14

Note) øD indicates the maximum diameter.

Different Diameter Straight: 10-KGH

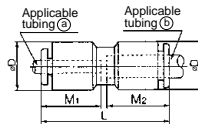

Applicable tubing O.D. (mm)		Model	øD ^(Note)	L	M ₁	M ₂	Effective area (mm ²)	Weight (g)
(A)	(B)							
4	6	10-KGH04-06	12.8	34.5	16	17	4	5
6	8	10-KGH06-08	15.2	38.5	17	18.5	10.4	6
8	10	10-KGH08-10	18.5	42	18.5	21	18.0	11
10	12	10-KGH10-12	20.9	44.5	21	22	29.5	14

Note) øD indicates the maximum diameter.

Male Elbow: 10-KGL



M5

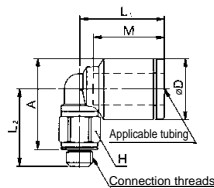

R

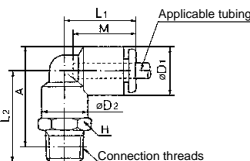

Applicable tubing O.D. (mm)	Connection thread R	Model	H (width across flats)	øD ₁ ^(M)	øD ₂	L ₁	L ₂	A *	M	Effective area (mm ²)	Weight (g)
										Urethane	
4	M5 x 0.8	10-KGL04-M5	7	9.3	—	15.6	13.7	15.3	12.7	3.5	2.7
	1/8	10-KGL04-01	10	10.4	10	18	21.1	23	16	4.2	10
	1/4	10-KGL04-02	14				25.5	25		19	
6	M5 x 0.8	10-KGL06-M5	7	11.6	—	16.1	14.7	17.4	13.5	3.5	3.1
	1/8	10-KGL06-01	10	12.8	10	20	22.1	25.5	17	9.0	12
	1/4	10-KGL06-02	14				26.5	27.5		10	
	3/8	10-KGL06-03	17				27.9	29		33	
	1/8	10-KGL08-01	12				23.6	28		13	
1/4	10-KGL08-02	14	28				30	14.9		21	
8	3/8	10-KGL08-03	17	15.2	12	23	29.4	31.5	18.5	35	
	1/8	10-KGL10-01	10				26.1	32		25	
	1/4	10-KGL10-02	14				29.5	33		26	
	3/8	10-KGL10-03	17				30.9	34.5		36	
	1/2	10-KGL10-04	22				35.1	37		63	
10	1/4	10-KGL12-02	17	18.5	17	26.5	30.5	35.5	21	14.9	25
	3/8	10-KGL12-03	19				31.9	37		26	
	1/2	10-KGL12-04	22				36.1	39.5		36	
12	1/4	10-KGL12-03	17	20.9	17	28.5	30.5	35.5	22	28	
	3/8	10-KGL12-03	19				31.9	37		38	
	1/2	10-KGL12-04	22				36.1	39.5		65	
16	3/8	10-KGL16-03	19	26.5	20.9	34	36.9	44.5	25	59.6	101
	1/2	10-KGL16-04	22				40.1	46		70.6	105

* Reference dimensions after R thread installation.
Note 1) øD₂ indicates the maximum diameter.



Male Branch Connector: 10-KGLU

M5

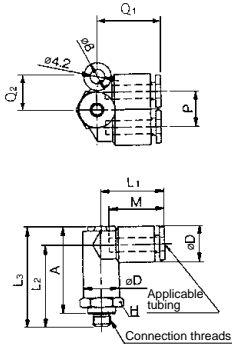

Applicable tubing O.D. (mm)	Connection thread R	Model	H (width across flats)	ϕD ^(mm)	L1	L2	L3	A *	M	P	Q1	Q2	Effective area (mm ²) Urethane	Weight (g)
4	M5 x 0.8	10-KGLU04-M5	11	10.4	18.5	24	28.5	25.5	16	10.4	18.5	10	4.1	10
	1/8	10-KGLU04-01	14			25.6	31.1	27.5					4.1	12
	1/4	10-KGLU04-02	14			30	35.5	30					4.1	21
6	M5 x 0.8	10-KGLU06-M5	13	12.8	21	26.5	33	28.5	17	12.8	20.5	12	4.3	13
	1/8	10-KGLU06-01	14			28.6	35.1	32					15	
	1/4	10-KGLU06-02	17			32.5	39	33.5					11.0	22
	3/8	10-KGLU06-03	17			33.9	40.4	35					35	
8	1/8	10-KGLU08-01	17	15.2	24	33.1	40.6	38	18.5	15.2	24.5	14	18.2	27
	1/4	10-KGLU08-02				36.5	44	38.5					35	
	3/8	10-KGLU08-03				36.9	44.4	39					35	
10	1/4	10-KGLU10-02	19	18.5	27	39.5	49	43.5	21	18.5	28	16	29.0	41
	3/8	10-KGLU10-03				39.9	49.4	44					42	
	1/2	10-KGLU10-04				22	43.6	53.1					45.5	64
12	1/4	10-KGLU12-02	22	20.9	29	42	52.5	47	22	20.9	30	18	45.2	58
	3/8	10-KGLU12-03				42.4	52.9	47.5					65	
	1/2	10-KGLU12-04				45.6	56.1	49					65	

* Reference dimensions after R thread installation.
Note) ϕD indicates the maximum diameter.

R

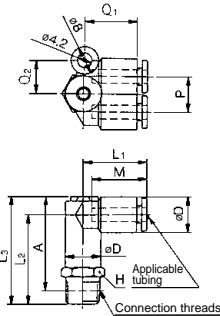

Universal Male Elbow: 10-KGV

M5

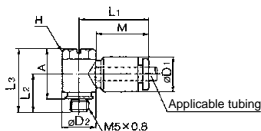

Applicable tubing O.D. (mm)	Connection thread R	Model	H (width across flats)	ϕD ^(mm)	ϕD ₂	L1	L2	L3	A *	M	Effective area (mm ²) Urethane	Weight (g)	
4	M5 x 0.8	10-KGV04-M5	8	10.4	9.8	20.5	11	18.5	15	16	2.9	6	
	1/8	10-KGV04-01			13.4	22	13.6	25.6	22.5			14	
	M5 x 0.8	10-KGV06-M5			8	9.8	23.5	12	18.5			15	3.8
6	1/8	10-KGV06-01	10	12.8	13.4	24	13.6	25.6	22.5	17	5.9	15	
	1/4	10-KGV06-02			15.3	23.5	18	30.5	25			26	
	1/8	10-KGV08-01			12	17.6	28.5	14.6	27.6			24.5	11.2
8	1/4	10-KGV08-02	14	15.2	18	31	25.5	18.5	18.5	14.3	47	30	
	3/8	10-KGV08-03			20.6	27.5	19.4	35.4				30	47
	1/4	10-KGV10-02			14	18.5	20.6	31				19	35
10	3/8	10-KGV10-03	17	20.9	19.4	35.4	30	22	30.8	80	49	63	
	3/8	10-KGV12-03			20.9	37.4	32					80	
	1/2	10-KGV12-04			24.1	40.6	33.5					80	

* Reference dimensions after R thread installation.
Note) ϕD₁ indicates the maximum diameter.

R

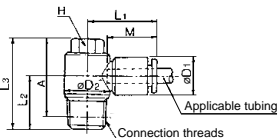

- Directional Control Valves
- Air Cylinders
- Rotary Actuators
- Air Grippers
- Air Preparation Equipment
- Modular F. R.
- Pressure Control Equipment
- Fittings & Tubing
- Flow Control Equipment
- Pressure Switches/ Pressure Sensors



Union Elbow: 10-KGL

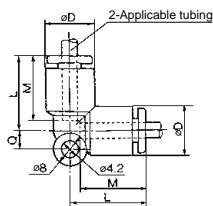

Applicable tubing O.D. (mm)	Model	ϕD ^{Note 1)}	L	Q	M2	Effective area (mm ²) Urethane	Weight (g)
4	10-KGL04-00	10.4	18	4.5	16	4.2	6
6	10-KGL06-00	12.8	20	5.3	17	9.0	6
8	10-KGL08-00	15.2	23	6	18.5	14.9	10
10	10-KGL10-00	18.2	26.5	6.8	21	25.0	17
12	10-KGL12-00	20.9	28.5	7.5	22	39.7	21
16	10-KGL16-00	26.5	34	10	25	70.6	29

Note 1) ϕD indicates the maximum diameter.



Branch Union Elbow: 10-KGLU

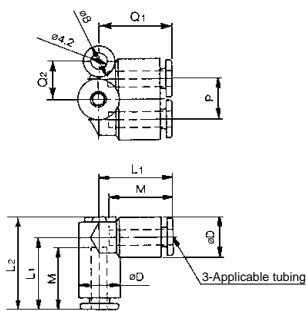

Applicable tubing O.D. (mm)	Model	ϕD ^{Note 1)}	L1	L2	Q1	Q2	M	P	Effective area (mm ²) Urethane	Weight (g)
4	10-KGLU04-00	10.4	18.5	24	18.5	10	16	10.4	4.1	6
6	10-KGLU06-00	12.8	21	27.5	20.5	12	17	12.8	11.0	8
8	10-KGLU08-00	15.2	24	32	24.5	14	18.5	15.2	18.2	15
10	10-KGLU10-00	18.5	27	36.5	28	16	21	18.5	29.0	25
12	10-KGLU12-00	20.9	29	40	30	18	22	20.9	45.2	32

Note 1) ϕD indicates the maximum diameter.



Plug-in Elbow: 10-KGL

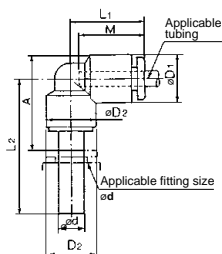

Applicable tubing O.D. (mm)	Applicable fitting size ϕd	Model	ϕD ^{Note 1)}	ϕD_2	L1	L2	A	M	Effective area (mm ²) Urethane	Weight (g)
4	4	10-KGL04-99	10.4	8	18	25	14.5	16	4.2	8
6	6	10-KGL06-99	12.8	10	20	27.5	17	17	9.0	10
8	8	10-KGL08-99	15.2	12	22.5	31.5	21	18.5	14.9	14
10	10	10-KGL10-99	18.5	14	25.5	35.5	23.5	21	25.0	25
12	12	10-KGL12-99	20.9	16	27	37.5	26	22	39.7	28

Note 1) ϕD_1 indicates the maximum diameter.



Extended Male Elbow: 10-KGW

M5

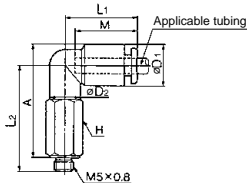

R

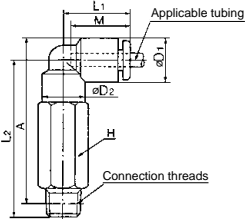

Applicable tubing O.D. (mm)	Connection thread R	Model	H (width across flats)	$\phi D_1^{(Note\ 1)}$	ϕD_2	L ₁	L ₂	A *	M	Effective area (mm ²) Urethane	Weight (g)
4	M5 x 0.8	10-KGW04-M5	8	10.4	8	18	30	32	16	3.0	11
	1/8	10-KGW04-01	10								23
	1/4	10-KGW04-02	14								38
6	M5 x 0.8	10-KGW06-M5	8	12.8	8	20	30.5	33.5	17	3.0	11
	1/8	10-KGW06-01	10								26
	1/4	10-KGW06-02	14								41
8	1/8	10-KGW06-03	17	15.2	12	23	46.9	48	18.5	8.6	67
	1/4	10-KGW08-01	12								30
	3/8	10-KGW08-02	14								47
10	1/4	10-KGW08-03	17	18.5	17	26.5	50.4	52.5	21	14.2	74
	3/8	10-KGW10-02	17								66
	1/2	10-KGW10-04	22								145
12	1/4	10-KGW12-02	17	20.9	17	28.5	57	62	22	23.8	68
	3/8	10-KGW12-03	17								78
	1/2	10-KGW12-04	22								147

* Reference dimensions after R thread installation. Note 1) ϕD_1 indicates the maximum diameter.

Directional Control Valves

Air Cylinders

Rotary Actuators

Air Grippers



Male Branch Tee: 10-KGT

M5

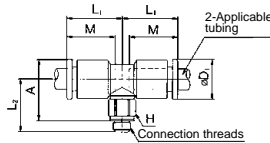

R

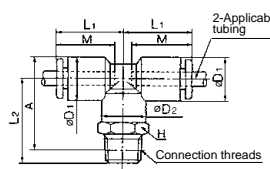

Applicable tubing O.D. (mm)	Connection thread R	Model	H (width across flats)	$\phi D_1^{(Note\ 1)}$	ϕD_2	L ₁	L ₂	A *	M	Effective area (mm ²) Urethane	Weight (g)
4	M5 x 0.8	10-KGT04-M5	7	9.3	—	15.6	13.7	15.3	12.7	4.5	3.5
	1/8	10-KGT04-01	10								13
	1/4	10-KGT04-02	14								19
6	M5 x 0.8	10-KGT06-M5	7	11.6	—	16.1	14.7	17.4	13.5	4.5	4.4
	1/8	10-KGT06-01	10								12
	1/4	10-KGT06-02	14								20
8	1/8	10-KGT06-03	17	12.8	10	20	26.5	27.5	17	11.0	20
	1/4	10-KGT08-01	12								34
	3/8	10-KGT08-02	14								41
10	1/4	10-KGT08-03	17	15.2	12	23	28	30	18.5	18.2	22
	3/8	10-KGT10-01	17								36
	1/2	10-KGT10-02	22								66
12	1/4	10-KGT10-03	17	18.5	17	26.5	29.4	31.5	21	29.0	31
	3/8	10-KGT12-01	17								39
	1/2	10-KGT12-02	22								66
16	1/2	10-KGT12-04	22	20.9	17	28.5	35.1	37	22	45.2	41
	3/8	10-KGT16-03	22								68
	1/2	10-KGT16-04	22								116

* Reference dimensions after R thread installation. Note 1) ϕD_1 indicates the maximum diameter.

Air Preparation Equipment

Modular F. R.

Pressure Control Equipment

Fittings & Tubing



Union Tee: 10-KGT

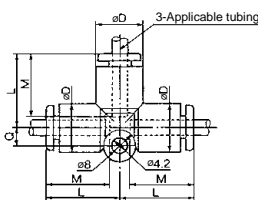

Applicable tubing O.D. (mm)	Model	$\phi D^{(Note\ 1)}$	L	Q	M	Effective area (mm ²) Urethane	Weight (g)
4	10-KGT04-00	10.4	18	4.5	16	4.4	7
6	10-KGT06-00	12.8	20	5.3	17	10.6	10
8	10-KGT08-00	15.2	23	6	18.5	17.7	15
10	10-KGT10-00	18.5	26.5	6.8	21	28.4	25
12	10-KGT12-00	20.9	28.5	7.5	22	45.4	29
16	10-KGT16-00	26.5	34	10	25	70.6	40

Note 1) ϕD indicates the maximum diameter.

Flow Control Equipment

Pressure Switches/ Pressure Sensors



Different Diameter Tee: 10-KGT

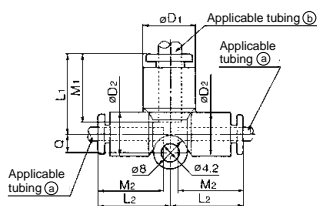

Applicable tubing O.D. (mm)		Model	ϕD_1^{Nom}	ϕD_2	L ₁	L ₂	Q	M ₁	M ₂	Effective area (mm ²) Urethane	Weight (g)
(A)	(B)										
4	6	10-KGT04-06	12.8	10.4	19.5	18	4.5	17	16	6.5	5
6	8	10-KGT06-08	15.2	12.8	22.5	20	5.3	18.5	17	16.4	8
8	10	10-KGT08-10	18.5	15.2	26.5	23	6	21	18.5	27.2	14
10	12	10-KGT10-12	20.9	18.5	28.5	26.5	6.8	22	21	44.5	21

Note) ϕD_1 indicates the maximum diameter.



Male Run Tee: 10-KGY

M5

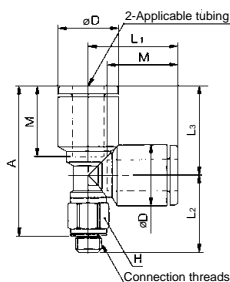

R

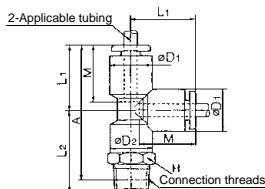

Applicable tubing O.D. (mm)	Connection thread R	Model	H (width across flats)	ϕD_1^{Nom}	ϕD_2	L ₁	L ₂	L ₃	A *	M	Effective area (mm ²) Urethane	Weight (g)
4	M5 x 0.8	10-KGY04-M5	7	9.3	—	15.6	13.7	14.8	25.4	12.7	4.5	3.5
	1/8	10-KGY04-01	10	10	18	21.1	—	36	16	4.4	13	
	1/4	10-KGY04-02	14	10.4	10	25.5	—	38	16	4.4	19	
6	M5 x 0.8	10-KGY06-M5	7	11.6	—	17.1	14.7	17.1	28.7	13.5	4.5	4.3
	1/8	10-KGY06-01	10	10	20	22.1	—	39	17	10.6	12	
	1/4	10-KGY06-02	14	12.8	10	26.5	—	41	17	10.6	20	
8	3/8	10-KGY06-03	17	10	20	27.9	—	42.5	17	10.6	34	
	1/8	10-KGY08-01	12	12	23	23.6	—	43.5	17	10.6	14	
	1/4	10-KGY08-02	14	15.2	12	28	—	45.5	18.5	17.7	22	
10	3/8	10-KGY08-03	17	10	20	29.4	—	47	18.5	17.7	36	
	1/8	10-KGY10-01	10	10	20	26.1	—	49.5	21	28.4	31	
	1/4	10-KGY10-02	14	18.5	17	29.5	—	50.5	21	28.4	29	
12	3/8	10-KGY10-03	17	10	20	30.9	—	52	21	28.4	39	
	1/2	10-KGY10-04	22	20.9	17	35.1	—	54.5	25	45.4	66	
	1/4	10-KGY12-02	17	10	20	30.5	—	53.5	22	45.4	31	
16	3/8	10-KGY12-03	17	20.9	17	31.9	—	55	22	45.4	41	
	1/2	10-KGY12-04	22	26.5	20.9	36.1	—	57.5	25	68	68	
	3/8	10-KGY16-03	22	26.5	20.9	36.9	—	65.5	25	68	112	
	1/2	10-KGY16-04	22	26.5	20.9	40.1	—	67	25	94.9	116	

* Reference dimensions after R thread installation.
Note 1) ϕD_1 indicates the maximum diameter.



Male Delta Union: 10-KGD

M5

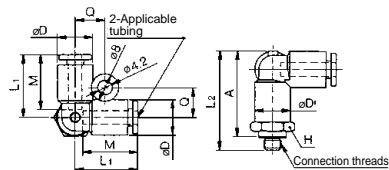

R

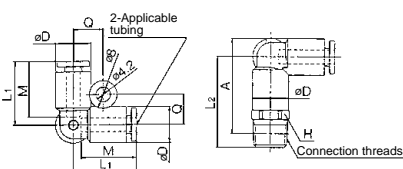

Applicable tubing O.D. (mm)	Connection thread R	Model	H (width across flats)	ϕD^{Nom}	L ₁	L ₂	A *	M	Q	Effective area (mm ²) Urethane	Weight (g)
4	M5 x 0.8	10-KGD04-M5	11	10.4	18.5	24	25.5	16	8.7	4.3	10
	1/8	10-KGD04-01	14	10.4	18.5	25.6	27.5	16	8.7	6.0	12
	1/4	10-KGD04-02	14	10.4	18.5	30	30	16	8.7	6.0	21
6	M5 x 0.8	10-KGD06-M5	13	12.8	20.5	26	28.5	17	9.9	4.3	12
	1/8	10-KGD06-01	13	12.8	20.5	28.1	31.5	17	9.9	11.0	14
	1/4	10-KGD06-02	14	12.8	20.5	32	33.5	17	9.9	11.0	21
8	3/8	10-KGD06-03	17	12.8	20.5	33.4	34.5	17	9.9	11.0	34
	1/8	10-KGD08-01	10	10	20	32.6	37	17	9.9	11.0	26
	1/4	10-KGD08-02	14	15.2	23.5	36	38	18.5	11.1	18.2	35
10	3/8	10-KGD08-03	17	15.2	23.5	36.4	38.5	18.5	11.1	18.2	35
	1/4	10-KGD10-02	14	10	20	39	43	21	12.8	29.0	39
	3/8	10-KGD10-03	17	18.5	26.5	39.4	43.5	21	12.8	29.0	40
12	1/2	10-KGD10-04	22	20.9	28.5	43.1	45	22	13.9	45.2	62
	1/4	10-KGD12-02	14	10	20	41.5	46.5	22	13.9	45.2	55
	3/8	10-KGD12-03	17	20.9	28.5	41.9	47	22	13.9	45.2	56
	1/2	10-KGD12-04	22	20.9	28.5	45.1	48.5	22	13.9	45.2	63

* Reference dimensions after R thread installation.
Note) ϕD indicates the maximum diameter.



Delta Union: 10-KGD

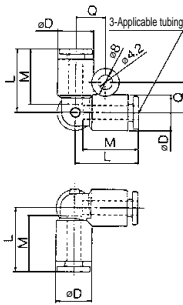

Applicable tubing O.D. (mm)	Model	ϕD ^(Note)	L	Q	M	Effective area (mm ²)		Weight (g)
						Urethane		
4	10-KGD04-00	10.4	18.5	8.7	16	4.1	5	
6	10-KGD06-00	12.8	20.5	9.9	17	11.0	7	
8	10-KGD08-00	15.2	23.5	11.1	18.5	18.2	11	
10	10-KGD10-00	18.5	26.5	12.8	21	29.0	19	
12	10-KGD12-00	20.9	28.5	13.9	22	45.2	24	

Note) ϕD indicates the maximum diameter.

Directional Control Valves

Air Cylinders

Rotary Actuators



Branch "Y": 10-KGU

M5

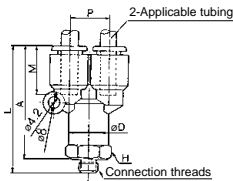

R

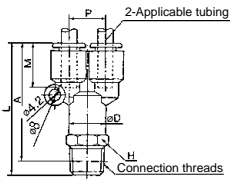

Applicable tubing O.D. (mm)	Connection thread R	Model	H (width across flats)	ϕD ^(Note)	L	P	A *	M	Effective area (mm ²)		Weight (g)		
									Urethane				
4	M5 x 0.8	10-KGU04-M5	11	10.4	39.5	36	10.4	38	16	2.2	4		
	1/8	10-KGU04-01	14							45.5	40	4.2	11
	1/4	10-KGU04-02	14							45.5	40	20	
6	M5 x 0.8	10-KGU06-M5	13	12.8	44.6	39	12.8	41.5	17	2.2	12		
	1/8	10-KGU06-01	14							48.5	43	10.6	11
	1/4	10-KGU06-02	14							48.5	43	21	
	3/8	10-KGU06-03	17							49.9	44.5	34	
	1/2	10-KGU06-04	17							51.6	48.5	15	
8	1/4	10-KGU08-02	17	15.2	55	50	15.2	49.5	18.5	17.7	23		
	3/8	10-KGU08-03	17							55.4	50	35	
	1/2	10-KGU10-02	19							60.5	55	30	
10	3/8	10-KGU10-03	19	18.5	60.9	55.5	18.5	55.5	21	28.4	40		
	1/2	10-KGU10-04	22							64.1	57	65	
	3/4	10-KGU12-02	22							64	58.5	32	
12	3/8	10-KGU12-03	22	20.9	64.4	20.9	59	59	22	45.4	40		
	1/2	10-KGU12-04	22							67.6	60.5	65	

* Reference dimensions after R thread installation. Note) ϕD indicates the maximum diameter.

Air Grippers

Air Preparation Equipment

Modular F. R.



Double Branch "Y": 10-KGUD

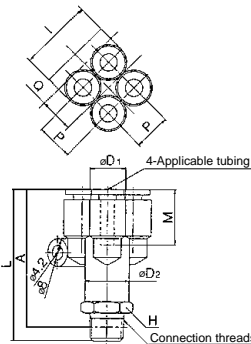

Applicable tubing O.D. (mm)	Connection thread R	Model	H (width across flats)	$\phi D1$ ^(Note)	$\phi D2$	L	I	A *	Q	M	P	Effective area (mm ²)		Weight (g)
												Urethane		
4	1/8	10-KGUD04-01	13	10.4	12.8	42.6	21	39.5	9.7	16	10.4	4.2	17	
	1/4	10-KGUD04-02	14									46.5	41	25
6	1/8	10-KGUD06-01	17	12.8	15.2	49.6	26	46.5	11.7	17	12.8	10.6	29	
	1/4	10-KGUD06-02	17									53	47.5	

* Reference dimensions after R thread installation. Note) ϕD indicates the maximum diameter.

Pressure Control Equipment

Fittings & Tubing

Flow Control Equipment

Pressure Switches/ Pressure Sensors



Union "Y": 10-KGU

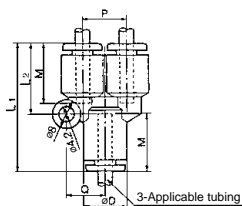

Applicable tubing O.D. (mm)	Model	Note)		L ₁	L ₂	P	Q	M	Effective area (mm ²)	Weight (g)
		øD	øD						Urethane	
4	10-KGU04-00	10.4	34	18	10.4	9.7	16		4.2	7
6	10-KGU06-00	12.8	37	20	12.8	11.7	17		10.6	9
8	10-KGU08-00	15.2	42.5	24.5	15.2	13.7	18.5		17.7	11
10	10-KGU10-00	18.5	48	27.5	18.5	16.1	21		28.4	16
12	10-KGU12-00	20.9	51	30	20.9	18.1	22		45.4	23

Note) øD indicates the maximum diameter.



Different Diameter Union "Y": 10-KGU

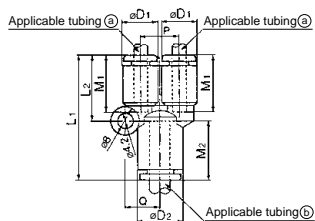

Applicable tubing O.D. (mm)	Model	Note)		L ₁	L ₂	P	Q	M ₁	M ₂	Effective area (mm ²)	Weight (g)		
		øD1	øD2							Urethane			
(a) (b)	10-KGU04-06	10.4	12.8	35	18	10.4	9.7	16	17		4.2	6	
6	8	10-KGU06-08	12.8	15.2	39.5	20	12.8	11.7	17	18.5		10.6	11
8	10	10-KGU08-10	15.2	18.5	45	24.5	15.2	13.7	18.5	21		17.7	18
10	12	10-KGU10-12	18.5	20.9	49	27.5	18.5	16.1	21	22		28.4	27

Note) øD1 and øD2 indicate the maximum diameter.



Different Diameter Double Union "Y": 10-KGUD

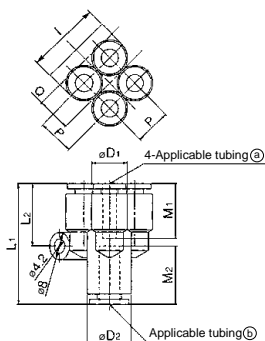

Applicable tubing O.D. (mm)	Model	Note)		L ₁	L ₂	P	I	Q	M ₁	M ₂	Effective area (mm ²)	Weight (g)		
		øD1	øD2								Urethane			
(a) (b)	10-KGUD04-06	10.4	12.8	35.5	18.2	10.4	21	9.7	16	17		4.2	10	
6	8	10-KGUD06-08	12.8	15.2	40.5	20.3	12.8	26	11.7	17	18.5		10.6	17

Note) øD1 and øD2 indicate the maximum diameter.

Plug-in Reducer: 10-KGR

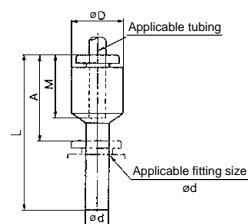

Applicable tubing O.D. (mm)	Applicable fitting size ød	Model	Note 1) øD	L	A	M	Effective area (mm ²)	Weight (g)
							Urethane	
4	6	10-KGR04-06	10.4	34.5	17.5	16	4	1.8
	8	10-KGR04-08						2.0
	10	10-KGR04-10						3.3
6	4	10-KGR06-04	12.8	37	21	17	4	3
	8	10-KGR06-08						2.5
	10	10-KGR06-10						3
	12	10-KGR06-12						4.7
8	10	10-KGR08-10	15.2	41	20	18.5	18.0	4.0
	12	10-KGR08-12						4.6
	16	10-KGR08-16						21
10	12	10-KGR10-12	18.5	44.5	23	21	18.0	33
	16	10-KGR10-16						42
12	16	10-KGR12-16	20.9	50.5	25.5	22	38.7	37

Note) øD indicates the maximum diameter.





Bulkhead Union: 10-KGE

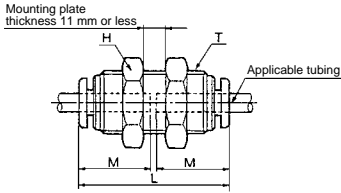

Applicable tubing O.D. (mm)	Model	T (M)	H (width across flats)	L	Mounting hole		M	Effective area (mm ²) Urethane	Weight (g)
4	10-KGE04-00	M12 x 1	14	32.5	13	16		4	26
6	10-KGE06-00	M14 x 1	17	34.5	15	17		10.4	33
8	10-KGE08-00	M16 x 1	19	38	17	18.5		18.0	52
10	10-KGE10-00	M20 x 1	24	42.5	21	21		29.5	70
12	10-KGE12-00	M22 x 1	27	44	23	22		46.1	90
16	10-KGE16-00	M28 x 1.5	32	51	29	25		80.6	115

Bulkhead Connector: 10-KGE

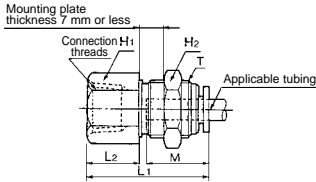

Applicable tubing O.D. (mm)	Connection thread Rc	Model	T (M)	H ₁	H ₂	L ₁	L ₂	Mounting hole	M	Effective area (mm ²) Urethane	Weight (g)
				(width across flats)	(width across flats)						
4	1/8	10-KGE04-01	M12 x 1	14	27.5	11	13	16	16	4	16
	1/4	10-KGE04-02		17	31	15					
6	1/8	10-KGE06-01	M14 x 1	17	28	11	15	17	17	10.4	30
	1/4	10-KGE06-02			31.5	15					
	3/8	10-KGE06-03			33.5	7.5					
8	1/8	10-KGE08-01	M16 x 1	17	27.5	7.5	15	17	18.5	18.0	48
	1/4	10-KGE08-02			33	13					
	3/8	10-KGE08-03			35	15					
10	1/4	10-KGE10-02	M20 x 1	22	34.5	12.5	14	21	21	29.5	53
	3/8	10-KGE10-03			36.5	14					
	1/2	10-KGE10-04			41	18					
12	3/8	10-KGE12-03	M22 x 1	24	37	14	18	23	22	46.1	92
	1/2	10-KGE12-04			41	18					
16	3/8	10-KGE16-03	M28 x 1.5	30	40	14	18	29	25	80.6	129
	1/2	10-KGE16-04			44	18					

Tube Cap: 10-KGC

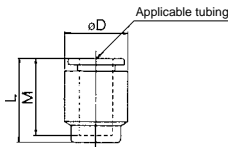

Applicable tubing O.D. (mm)	Model	(Note) øD	L	M	Weight (g)
4	10-KGC04-00	10.4	17	16	3
6	10-KGC06-00	12.8	18.5	17	3
8	10-KGC08-00	15.2	20.5	18.5	4
10	10-KGC10-00	18.5	23	21	6
12	10-KGC12-00	20.9	24	22	8
16	10-KGC16-00	26.5	28	25	13

Note) øD indicates the maximum diameter.

Directional Control Valves

Air Cylinders

Rotary Actuators

Air Grippers

Air Preparation Equipment

Modular F. R.

Pressure Control Equipment

Fittings & Tubing

Flow Control Equipment

Pressure Switches/ Pressure Sensors

Series 10-MS

Stainless Miniature Fittings

Construction

RoHS



Hose nipple

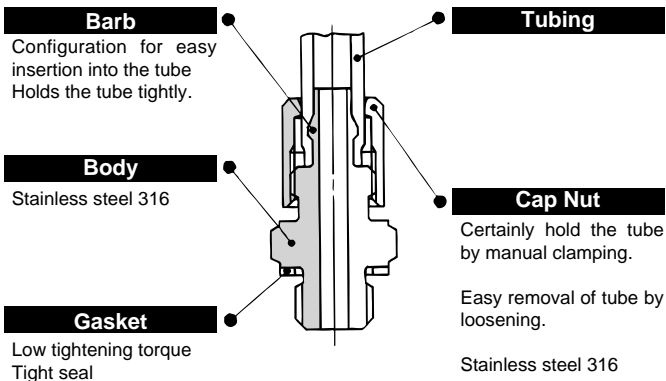

Barb fitting

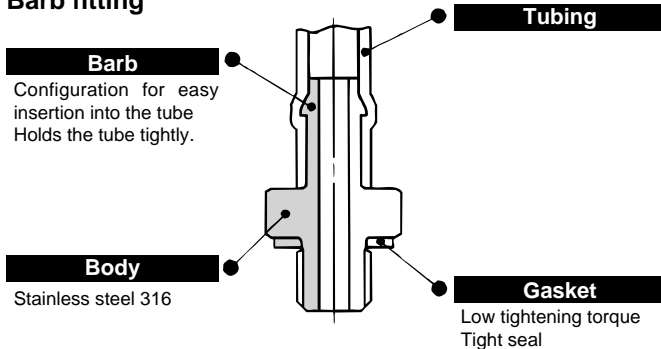











Specifications

Applicable tubing material	Polyurethane	
Applicable tubing diameter	ø3.18/ø2, ø4/ø2.5, ø6/ø4	
Fluid	Air, Water (Note)	
Max. operating pressure (at 20°C)	0.8 MPa	
Ambient and fluid temperature	-5 to 60°C, Water: 0 to 40°C (No freezing)	
Connection size	M5	
Material	Body	Stainless steel 316
	Gasket	PVC, Nylon 66, GF30%
Grease	Fluorine grease (10-MS-5UN only)	
Cleanliness class (ISO class)	Class 3	

Note) Barb fitting, barb elbow and barb tee are not compatible with water.

Model

Model	Description	Application	Note	Model	Description	Application	Note			
10-MS-5AU-3	Barb fittings for polyurethane tube	For polyurethane tube	ø3.18/ø2 x M5	10-MS-5UL	Universal elbow	Body rotates at 360° around the stud axis.	M5 female x M5 male			
10-MS-5AU-4			ø4/ø2.5 x M5							
10-MS-5AU-6			ø6/ø4 x M5							
10-MS-5ALHU-3	Barb elbow for polyurethane tube	For polyurethane tube Body rotates at 360° around the stud axis.	ø3.18/ø2 x M5	10-MS-5B	Bushing	For reducing R (PT) 1/8 to M5	R1/8 x M5 female			
10-MS-5ALHU-4			ø4/ø2.5 x M5							
10-MS-5ALHU-6			ø6/ø4 x M5		10-MS-5P			Plug	Use to plug unused M5 port	
10-MS-5H-4	Hose nipple	For polyurethane tube	ø4/ø2.5 x M5	10-MS-5J		Extension fitting	Solid piece moves fitting up from workpiece.	M5 male x M5 female		
10-MS-5H-6			ø6/ø4 x M5			10-MS-5N				
10-MS-5HLH-4	Hose elbow	For polyurethane tube Body rotates at 360° around the stud axis.	ø4/ø2.5 x M5	10-MS-5UN	Universal nipple		Body rotates at 360° around the stud axis.	M5 male x M5 male PAT.		
10-MS-5HLH-6			ø6/ø4 x M5		10-MS-5ATHU-3	10-MS-5ATHU-4			Barb tee for polyurethane tube	ø3.18/ø2 x M5
10-M-5G1	Gasket	To seal M5 thread	Material: PVC	10-MS-5ATHU-6				ø6/ø4 x M5		
10-M-5GH	Gasket (H)	To seal M5 thread	Material: Nylon 66, GF30% only							

Directional Control Valves

Air Cylinders

Rotary Actuators

Air Grippers

Air Preparation Equipment

Modular F. R.

Pressure Control Equipment

Fittings & Tubing

Flow Control Equipment

Pressure Switches/ Pressure Sensors

Barb Fittings for Polyurethane Tube: 10-MS-5AU-3, -4, -6

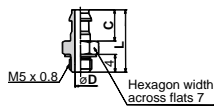

Model	C	D	L	Effective area (mm ²)	Weight (g)
10-MS-5AU-3	4.5	1.6	11.5	1.7	1.4
10-MS-5AU-4	5	1.8	12	2.1	1.5
10-MS-5AU-6	7	2.5	14	4.0	1.7

Barb Elbow for Polyurethane Tube: 10-MS-5ALHU-3, -4, -6

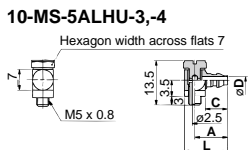

Model	A	C	D	L	Effective area (mm ²)	Weight (g)
10-MS-5ALHU-3	8	4.5	1.6	11.8	1.1	3.0
10-MS-5ALHU-4	8.8	5.0	1.8	12.6	1.4	3.1
10-MS-5ALHU-6	10.8	7.0	2.5	14.6	2.4	3.7

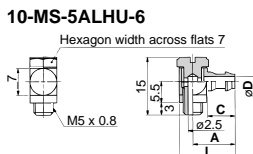

Hose Nipple: 10-MS-5H-4, -6

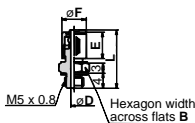

Model	B	D	L	E	F	Effective area (mm ²)	Weight (g)
10-MS-5H-4	7	1.8	15.5	7	6.5	2.1	2.5
10-MS-5H-6	8	2.5	16.5	8	8.5	4.0	3.7

Hose Elbow: 10-MS-5HLH-4, -6

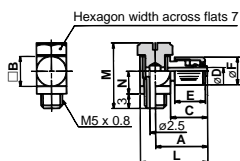

Model	A	B	C	D	E	F	L	M	N	Effective area (mm ²)	Weight (g)
10-MS-5HLH-4	12	7	8.5	1.8	7	6.5	15.8	15	5.5	1.4	4.2
10-MS-5HLH-6	13.5	8	9.5	2.5	8	8.5	17.8	16	6	2.4	6.2

Universal Elbow: 10-MS-5UL

Effective area: 2.4 mm²
Weight: 4.5 g

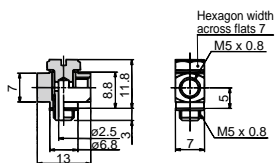

Universal Tee: 10-MS-5UT

Effective area: 2.4 mm²
Weight: 4.5 g

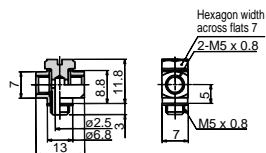

Bushing: 10-MS-5B

Effective area: 12 mm²
Weight: 5.5 g

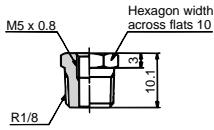

Plug: 10-MS-5B

Weight: 1.2 g

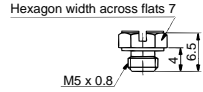

Extension Fitting: 10-MS-5J

Effective area: 4.0 mm²
Weight: 3.4 g

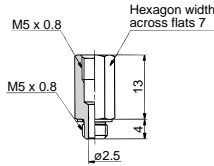

Nipple: 10-MS-5N

Effective area: 4.0 mm²
Weight: 1.4 g

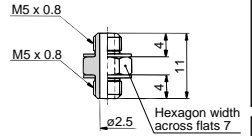

Barb Tee for Polyurethane Tube: 10-MS-5ATHU-3, -4, -6

10-MS-5ATHU-3, -4

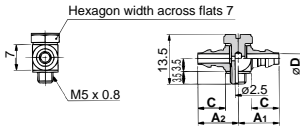

10-MS-5ATHU-6

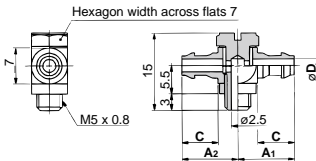

Model	A ₁	A ₂	C	D	Effective area (mm ²)	Weight (g)
10-MS-5ATHU-3	8	8.3	4.5	1.6	1.1	3.4
10-MS-5ATHU-4	8.8	8.8	5.0	1.8	1.4	3.6
10-MS-5ATHU-6	10.8	10.8	7.0	2.5	2.4	4.2

Universal Nipple: 10-MS-5UN

Effective area: 4.0 mm²
Weight: 3.7 g

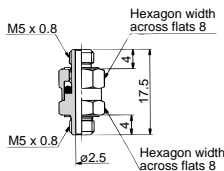

Gasket: 10-M-5G1, 10-M-5GH

Weight: 0.01 g

Weight: 0.04 g



Directional Control Valves
Air Cylinders
Rotary Actuators
Air Grippers
Air Preparation Equipment
Modular F. R.
Pressure Control Equipment
Fittings & Tubing
Flow Control Equipment
Pressure Switches/ Pressure Sensors

Series **KP** Clean One-touch Fittings For Blowing

RoHS



⚠ Caution

The KP series is a line of special One-touch fittings for use in clean room blowing and washing lines. Please consult with SMC regarding other types of applications.

Seal material: The durability of EPDM with respect to mineral oils is inferior, which makes it unsuitable for piping in general pneumatic equipment.

Applicable Tubing

Tubing material	PFA, Polyolefin Soft polyolefin, Polyurethane
Tubing O.D.	ø4, ø6, ø8, ø10, ø12

Note 1) FEP, nylon and soft nylon tubing, and tubing not compatible with the clean series can also be used. However, the degree of clean performance will be reduced.

Note 2) Due to the softness of polyurethane tubing, it may fold when being inserted. Hold the end of the tubing and insert it all the way in.

Specifications

Cleanliness class (ISO class)	Class 3 ^{Note 1)}
Fluid	Air, Nitrogen gas, Water (Deionized water) ^{Note 2)}
Maximum operating pressure (20°C)	1 MPa ^{Note 3)}
Operating vacuum pressure	-100 kPa (10 Torr)
Proof pressure (20°C)	3 MPa
Ambient and fluid temperature	-20°C to 80°C
Threads	JIS B0203 (Taper thread for piping)

Note 1) Refer to particle generation classifications.

Note 2) The surge pressure must be under the maximum operating pressure.

Note 3) The maximum operating pressure is the value at 20°C. Refer to the operating pressure curve for other temperatures.

Note 4) Do not use the fittings with a leak tester or for vacuum retention because they are not guaranteed for zero leakage.



Made to Order
(Refer to page 1222 for details.)

Particulate Generation Classifications

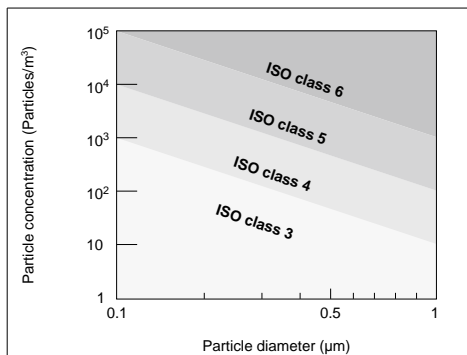

Note) Refer to page 17 for details.

Relation between Operating Temperature and Maximum Operating Pressure

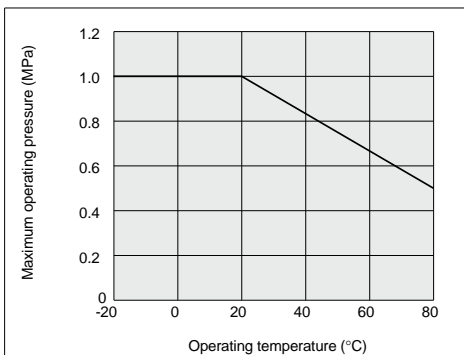

How to Order

Clean One-touch fittings (for blowing)

Model

H	Male connector, Straight union
L	Union elbow, Male elbow
T	Male branch tee, Union tee
Y	Male run tee
U	Male branch, Union "Y"
R	Plug-in reducer

Applicable tubing O.D.

04	ø4
06	ø6
08	ø8
10	ø10
12	ø12

Thread connection

01	R1/8
02	R1/4
03	R3/8
04	R1/2

Tubing (rod) connection

00	Same dia. tubing
04	ø4
06	ø6
08	ø8
10	ø10
12	ø12

Different dia. tubing (plug-in reducer)

Made to Order

X53 With sealant tape

Port size/Applicable tubing O.D.

Applicable fitting size

04	ø4
06	ø6
08	ø8
10	ø10
12	ø12

Plug

Clean One-touch fittings

Construction

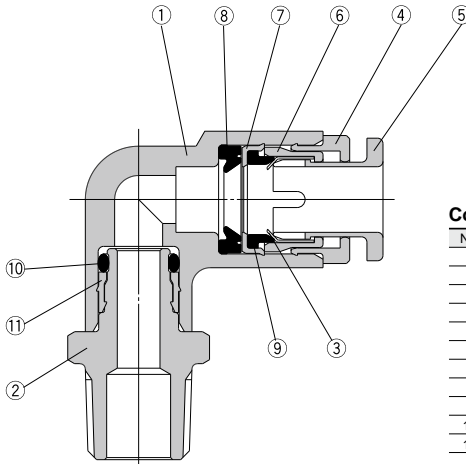

Component Parts

No.	Description	Material
1	Body	PP
2	Stud	PP
3	Chuck	Stainless steel 304
4	Guide	Stainless steel 304
5	Release button	PP (Color: Light green)
6	Collet	PP
7	Stopper	Stainless steel 304
8	Seal	EPDM (Fluorine-coated)
9	Bumper	EPDM (Fluorine-coated)
10	O-ring	EPDM (Fluorine-coated)
11	Drive bushing	Stainless steel 304

Directional Control Valves
Air Cylinders
Rotary Actuators
Air Grippers
Air Preparation Equipment
Modular F. R.
Pressure Control Equipment
Fittings & Tubing
Flow Control Equipment
Pressure Switches/Pressure Sensors

Dimensions

Male Connector: KPH



Applicable tubing O.D. (mm)	Connection thread R	Model	H (width across flats)	L	A*	M	Effective area (mm ²)		Weight (g)
							TPH	TPS	
4	1/8	KPH04-01	12	24.4	20.5	17	4	4	3
	1/4	KPH04-02			18.5				4
6	1/8	KPH06-01	14	24.9	21	18.5	10	10	4
	1/4	KPH06-02			19.5				5
8	1/8	KPH08-01	17	31.3	27.5	20.5	26	18	6
	1/4	KPH08-02			23.5				7
10	1/4	KPH10-02	19	32	26	23	41	29	11
	3/8	KPH10-03			27				12
12	3/8	KPH12-03	22	33	27	24	58	46	13
	1/2	KPH12-04			26				13

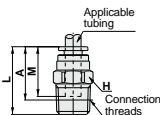

* Reference dimension for R threads after installation

Male Elbow: KPL



Applicable tubing O.D. (mm)	Connection thread R	Model	H (width across flats)	Note 1) ϕD_1	ϕD_2	L ₁	L ₂	A*	M	Effective area (mm ²)		Weight (g)
										TPH	TPS	
4	1/8	KPL04-01	12	10.4	10	19.7	23.2	24.5	17	3.5	3.5	4
	1/4	KPL04-02					27.2	26.5				5
6	1/8	KPL06-01	12	12.8	10	21.8	24.4	27	18.5	9	9	5
	1/4	KPL06-02					28.4	29				6
8	1/8	KPL08-01	14	15.2	12	25.3	26.6	30	20.5	22	15	8
	1/4	KPL08-02					29.4	31.5				9
10	1/4	KPL10-02	17	18.5	17	28.4	32.1	35.5	23	35	25	13
	3/8	KPL10-03					33.1	36.5				14
12	3/8	KPL12-03	22	20.9	22	30.4	34.3	38.5	24	50	40	15
	1/2	KPL12-04					38.3	41.5				18

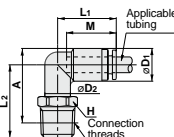

* Reference dimension for R threads after installation Note 1) ϕD_1 indicates the maximum diameter.

Male Branch Tee: KPT



Applicable tubing O.D. (mm)	Connection thread R	Model	H (width across flats)	Note 1) ϕD_1	ϕD_2	L ₁	L ₂	A*	M	Effective area (mm ²)		Weight (g)
										TPH	TPS	
4	1/8	KPT04-01	12	10.4	10	19.7	23.2	24.5	17	4.1	4.1	6
	1/4	KPT04-02					27.2	26.5				7
6	1/8	KPT06-01	12	12.8	10	21.8	24.4	27	18.5	11	11	8
	1/4	KPT06-02					28.4	29				9
8	1/8	KPT08-01	14	15.2	12	25.3	26.6	30	20.5	26.3	18.2	12
	1/4	KPT08-02					29.4	31.5				13
10	1/4	KPT10-02	17	18.5	17	28.4	32.1	35.5	23	40.8	29	20
	3/8	KPT10-03					33.1	36.5				21
12	3/8	KPT12-03	22	20.9	22	30.4	34.3	38.5	24	57.2	45.2	24
	1/2	KPT12-04					38.3	41.5				27

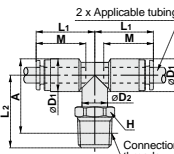

* Reference dimension for R threads after installation Note 1) ϕD_1 indicates the maximum diameter.

Male Run Tee: KPY



Applicable tubing O.D. (mm)	Connection thread R	Model	H (width across flats)	Note 1) ϕD_1	ϕD_2	L ₁	L ₂	A*	M	Effective area (mm ²)		Weight (g)
										TPH	TPS	
4	1/8	KPY04-01	12	10.4	10	19.7	23.2	39	17	7.5	7.5	6
	1/4	KPY04-02					27.2	41				7
6	1/8	KPY06-01	12	12.8	10	21.8	24.4	42	18.5	11	11	8
	1/4	KPY06-02					28.4	44.5				9
8	1/8	KPY08-01	14	15.2	12	25.3	26.6	48	20.5	21	21	12
	1/4	KPY08-02					29.4	49				13
10	1/4	KPY10-02	17	18.5	17	28.4	32.1	55	23	45	45	19
	3/8	KPY10-03					33.1	55.5				20
12	3/8	KPY12-03	22	20.9	22	30.4	34.3	58.5	24	57	52	21
	1/2	KPY12-04					38.3	61.5				24

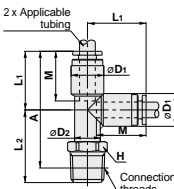

* Reference dimension for R threads after installation Note 1) ϕD_1 indicates the maximum diameter.

Male Branch "Y": KPU



Applicable tubing O.D. (mm)	Connection thread R	Model	H (width across flats)	Note 1) ϕD	L	P	A*	M	Effective area (mm ²)		Weight (g)
									TPH	TPS	
4	1/8	KPU04-01	12	10.4	44.4	10.4	40.5	17	7.5	7.5	7
	1/4	KPU04-02					42.5				8
6	1/8	KPU06-01	14	12.8	48.6	12.8	44.5	18.5	18	18	9
	1/4	KPU06-02					45.5				10
8	1/8	KPU08-01	17	15.2	55.7	15.2	51.5	20.5	26	26	15
	1/4	KPU08-02					54.5				17
10	1/4	KPU10-02	19	18.5	63.5	18.5	58	23	45	45	23
	3/8	KPU10-03					60.5				20
12	3/8	KPU12-03	22	20.9	68.7	20.9	62.5	24	70	70	29
	1/2	KPU12-04					64.5				30

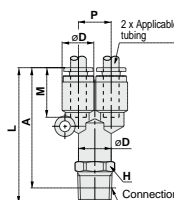

* Reference dimension for R threads after installation Note 1) ϕD indicates the maximum diameter.

Dimensions

Straight Union: KPH



Applicable tubing O.D. (mm)	Model	Note 1) ϕD	L	M	Effective area (mm ²)		Weight (g)
					TPH	TPS	
4	KPH04-00	10.4	35.4	17	4	4	4
6	KPH06-00	12.8	37.6	18.5	10	10	6
8	KPH08-00	15.2	42.4	20.5	26	18	10
10	KPH10-00	18.5	46.6	23	41	29	15
12	KPH12-00	20.9	48.6	24	58	46	18

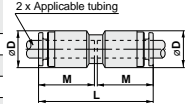

Note 1) ϕD indicates the maximum diameter.

Union Elbow: KPL



Applicable tubing O.D. (mm)	Model	Note 1) ϕD	L	Q	M	Effective area (mm ²)		Weight (g)
						TPH	TPS	
4	KPL04-00	10.4	19.7	4.5	17	3.5	3.5	3
6	KPL06-00	12.8	21.8	5.3	18.5	9	9	7
8	KPL08-00	15.2	25.3	6	20.5	22	15	11
10	KPL10-00	18.5	28.4	6.8	23	35	25	16
12	KPL12-00	20.9	30.4	7.5	24	50	40	20

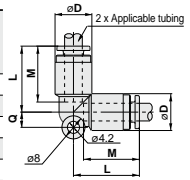

Note 1) ϕD indicates the maximum diameter.

Union Tee: KPT



Applicable tubing O.D. (mm)	Model	Note 1) ϕD	L	Q	M	Effective area (mm ²)		Weight (g)
						TPH	TPS	
4	KPT04-00	10.4	19.7	4.5	17	4	4	7
6	KPT06-00	12.8	21.8	5.3	18.5	10	10	9
8	KPT08-00	15.2	25.3	6	20.5	26	18	16
10	KPT10-00	18.5	28.4	6.8	23	41	29	25
12	KPT12-00	20.9	30.4	7.5	24	58	46	29

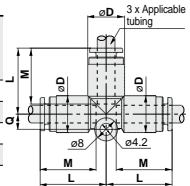

Note 1) ϕD indicates the maximum diameter.

Union "Y": KPU



Applicable tubing O.D. (mm)	Model	Note 1) ϕD	L ₁	L ₂	P	Q	M	Effective area (mm ²)		Weight (g)
								TPH	TPS	
4	KPU04-00	10.4	36.8	19.6	10.4	9.7	17	4	4	7
6	KPU06-00	12.8	40.1	21.8	12.8	11.7	18.5	10	10	10
8	KPU08-00	15.2	46.7	26.5	15.2	13.7	20.5	26	18	17
10	KPU10-00	18.5	52	29.7	18.5	16.1	23	41	29	26
12	KPU12-00	20.9	55.2	31.9	20.9	18.1	24	58	46	32

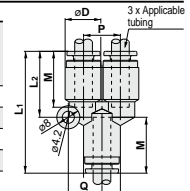

Note 1) ϕD indicates the maximum diameter.

Plug-in Reducer: KPR



Applicable tubing O.D. (mm)	Applicable fitting size ϕd	Model	Note 1) ϕD	L	A	M	Effective area (mm ²)		Weight (g)
							TPH	TPS	
4	6	KPR04-06	10.4	38.4	19.1	17	4	4	3
	8	KPR04-08		40.9	19.2				4
6	8	KPR06-08	12.8	41.5	19.8	18.5	10	10	4
				44	20.2				5
8	10	KPR08-10	15.2	46	22.2	20.5	26	18	5
				47					6
10	12	KPR10-12	18.5	49.5	24.7	23	41	29	9

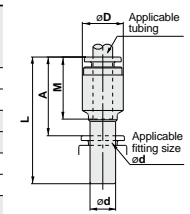

Note 1) ϕD indicates the maximum diameter.

Plug: KPP



Applicable fitting size ϕd	Model	ϕD	L	A	Weight (g)
4	KPP-04	6	32	13.8	0.4
6	KPP-06	8	35	15.7	0.7
8	KPP-08	10	39	17.3	1.1
10	KPP-10	12	43	19.2	1.7
12	KPP-12	14	45.5	20.7	2.5

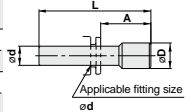

Note 1) ϕD indicates the maximum diameter.

Directional Control Valves

Air Cylinders

Rotary Actuators

Air Grippers

Air Preparation Equipment

Modular F. R.

Pressure Control Equipment

Fittings & Tubing

Flow Control Equipment

Pressure Switches/ Pressure Sensors

Series KPQ/KPG

Clean One-touch Fittings
For Driving Air Piping

RoHS



Series KPQ

Brass (electroless nickel plated)
Release button: Light gray



Series KPG

Stainless steel 304
Release button: Light blue



Made to Order
(Refer to page 1226 for details.)

Particulate Generation Classifications

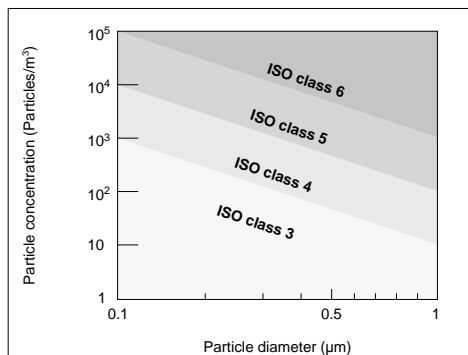

Note) Refer to page 17 for details.

Applicable Tubing

Tubing material	PFA, Polyurethane
Tubing O.D.	ø4, ø6, ø8, ø10, ø12

FEP, nylon and soft nylon tubing, and tubing not compatible with the clean series can also be used. However, the degree of clean performance will be reduced.

Specifications

Cleanliness class (ISO class)	Class 3 Note 1)
Fluid	Air
Maximum operating pressure (20°C)	1 MPa Note 2)
Operating vacuum pressure	-100 kPa
Proof pressure (20°C)	3 MPa
Ambient and fluid temperature	-5°C to 60°C
Threads	JIS B0203 (Taper thread for piping)
Oil	Fluorine-based grease

Note 1) Refer to particle generation classifications

This falls outside of the grade because fluorine grease is applied to the internal seal materials.

Note 2) The maximum operating pressure is the value at 20°C. Refer to the operating pressure curve for other temperatures.

Note 3) Do not use the fittings with a leak tester or for vacuum retention because they are not guaranteed for zero leakage.

Relation between Operating Temperature and Maximum Operating Pressure

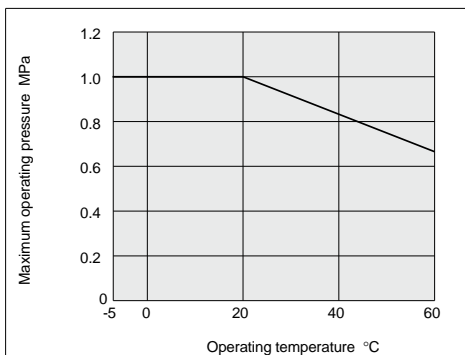

How to Order

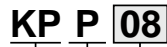
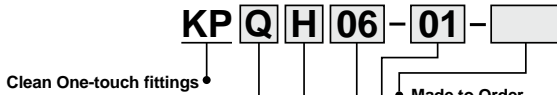

Specifications

Symbol	Specifications (metal part materials)
Q	Brass (electroless nickel plated)
G	Stainless steel 304

Model

H	Male connector, Straight union
L	Union elbow, Male elbow
T	Male branch tee, Union tee
Y	Male run tee
U	Male branch, Union "Y"
R	Plug-in reducer

Applicable tubing O.D.

04	ø4
06	ø6
08	ø8
10	ø10
12	ø12

Made to Order

X53	With sealant tape Grease-free
X193 (Note 1)	Rubber material: EPDM (Fluorine-coated) Gasket: M-SG3 (Stainless steel 316, Special FK(M) (Note 2)) Release button guide color: Natural

Note 1) Series KPG: Compatible with products with threads only
Note 2) M5 thread

Port size/Applicable tubing O.D.

Thread connection	M5	M5 x 0.8
	01	R1/8
	02	R1/4
	03	R3/8
	04	R1/2
Tubing (rod) connection	00	Same dia. tubing
	04	ø4
	06	ø6
	08	ø8
	10	ø10
	12	ø12

Different dia. tubing (plug-in reducer)

Applicable fitting size

04	ø4
06	ø6
08	ø8
10	ø10
12	ø12

Plug

Clean One-touch fittings

Construction

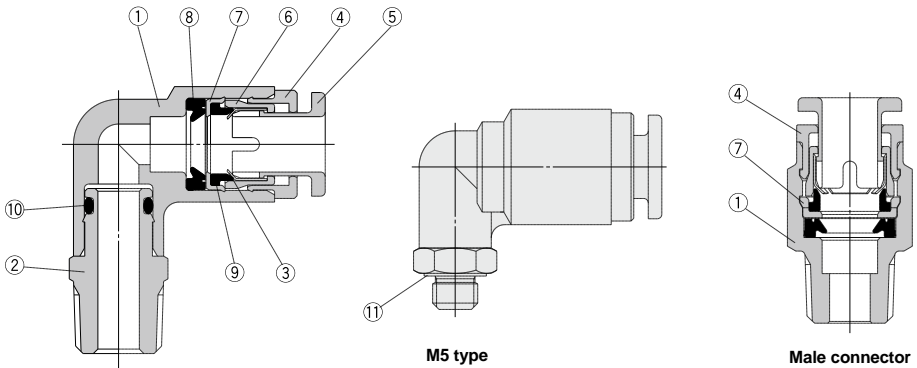

Component Parts

No.	Description	Material	
		Series KPQ	Series KPG
1	Body	With male connector	
2	Stud	C3604 (Electroless nickel plated)	Stainless steel 304
3	Chuck		Stainless steel 304
4	Guide	C3604 (Electroless nickel plated)	Stainless steel 304
5	Release button	PP (Color: Light gray)	PP (Color: Light blue)
6	Collet		PP
7	Stopper		Stainless steel 304
8	Seal	With male connector	PP
9	Bumper		NBR
10	O-ring		NBR
11	Gasket		Stainless steel 304, NBR

Directional Control Valves
Air Cylinders
Rotary Actuators
Air Grippers
Air Preparation Equipment
Modular F. R.
Pressure Control Equipment
Flow Control Equipment
Pressure Switches/Pressure Sensors

Dimensions

Male Connector: KPQH, KPGH

(M5)	Applicable tubing O.D. (mm)	Connection thread R M	Model		H (width across flats)	øD	L	A*	M	Effective area (mm ²)		Weight (g)	(M5)		
										TPH	TPS				
4	M5 x 0.8		KPQH04-M5	—	8	10	24.4	21.5	17	4	4	4			
			—	KPGH04-M5			24.9								
			1/8	KPQH04-01	KPGH04-01	10	—	23.5						18.5	7
			1/4	KPQH04-02	KPGH04-02	14	—	21.4						16	12
6	M5 x 0.8		KPQH06-M5	—	8	12	25.3	22	18.5	10	10	5			
			—	KPGH06-M5			25.8								
			1/8	KPQH06-01	KPGH06-01	12	—	23.7						18.5	7
			1/4	KPQH06-02	KPGH06-02	14	—	24.6						19	14
8	1/8		KPQH08-01	KPGH08-01	14	—	30.7	25.5	20.5	26	18	14			
			—	KPGH08-01			29.1							23.5	
			1/4	KPQH08-02	KPGH08-02	17	—	36.1						30.5	24
			3/8	KPQH10-03	KPGH10-03	19	—	30.9						25.5	23
12	3/8		KPQH12-03	KPGH12-03	17	—	32	26.5	24	58	46	23			
			1/2	KPQH12-04			KPGH12-04							22	—

* Reference dimension for R threads after installation

Male Elbow: KPQL, KPGL

(M5)	Applicable tubing O.D. (mm)	Connection thread R M	Model		H (width across flats)	Note 1)		L ₁	L ₂	A*	M	Effective area (mm ²)		Weight (g)	(M5)						
						øD ₁	øD ₂					TPH	TPS								
4	M5 x 0.8		KPQL04-M5	KPGL04-M5	8	10	10.4	19.7	15.3	17	17	4	4	4							
			—	KPGL04-01					21.1	21											
			1/4	KPQL04-02	KPGL04-02	14	—	25.5	25	19											
			1/2	KPQL06-M5	KPGL06-M5	8	—	15.8	18.5	16											
6	M5 x 0.8		KPQL06-01	KPGL06-01	10	12.8	10	21.8	22.3	23.5	18.5	10	10	12							
			—	KPGL06-01					26.7	27.5											
			1/8	KPQL08-01	KPGL08-01	12	15.2	12	25.3	23.5						26	20.5	26	18	13	
			1/4	KPQL08-02	KPGL08-02	14				27.9						30					21
10	1/4		KPQL10-02	KPGL10-02	17	—	17	28.4	29.4	33	23	41	29	26							
			—	KPGL10-03					30.8	34.5											
			3/8	KPQL12-03	KPGL12-03	17	20.9	—	17	30.4						32	37	24	58	46	36
			1/2	KPQL12-04	KPGL12-04	22										36.2	39.5				

* Reference dimension for R threads after installation Note 1) øD₁ indicates the maximum diameter.

Union Tee: KPQT, KPGT

(M5)	Applicable tubing O.D. (mm)	Connection thread R M	Model		H (width across flats)	Note 1)		L ₁	L ₂	A*	M	Effective area (mm ²)		Weight (g)	(M5)						
						øD ₁	øD ₂					TPH	TPS								
4	M5 x 0.8		KPQT04-M5	KPGT04-M5	8	10	10.4	19.7	15.3	17	17	4	4	6							
			—	KPGT04-01					21.1	21											
			1/8	KPQT04-01	KPGT04-01	10	—	25.5	25	13											
			1/4	KPQT04-02	KPGT04-02	14	—	25.5	25	19											
6	M5 x 0.8		KPQT06-M5	KPGT06-M5	8	10	12.8	10	15.8	18.5	18.5	10	10	7							
			—	KPGT06-01					22.3	23.5											
			1/8	KPQT06-01	KPGT06-01	12	15.2	12	25.3	23.5						26	20.5	26	18	14	
			1/4	KPQT06-02	KPGT06-02	14				27.9						30					22
10	1/4		KPQT10-02	KPGT10-02	17	—	17	28.4	29.4	33	23	41	29	29							
			—	KPGT10-03					30.8	34.5											
			3/8	KPQT12-03	KPGT12-03	17	20.9	—	17	30.4						32	37	24	58	46	31
			1/2	KPQT12-04	KPGT12-04	22										36.2	39.5				

* Reference dimension for R threads after installation Note 1) øD₁ indicates the maximum diameter.

Dimensions

Male Run Tee: KPQY, KPGY

(M5)	Applicable tubing O.D. (mm)	Connection thread R M	Model		H (width across flats)	Note 1) ϕD_1	ϕD_2	L ₁	L ₂	A*	M	Effective area (mm ²)		Weight (g)		
												TPH	TPS			
4	M5 x 0.8	1/8	KPQY04-M5	KPGY04-M5	8	10.4	8	19.7	15.3	31.5	17	4	4	6		
			KPQY04-01	KPGY04-01	10									21.1	35.5	13
			KPQY04-02	KPGY04-02	14									25.5	39.5	19
6	M5 x 0.8	1/8	KPQY06-M5	KPGY06-M5	8	10.8	8	10	21.8	15.8	18.5	10	10	7		
			KPQY06-01	KPGY06-01	10									22.3	39	14
			KPQY06-02	KPGY06-02	14									26.7	43	20
8	1/8	1/8	KPQY08-01	KPGY08-01	12	15.2	12	25.3	23.5	43.5	20.5	26	18	14		
			KPQY08-02	KPGY08-02	14									27.9	47.5	22
			KPQY10-02	KPGY10-02	12									29.4	52.5	29
10	3/8	3/8	KPQY10-03	KPGY10-03	17	18.5	17	28.4	30.8	54	23	41	29	39		
			KPQY12-03	KPGY12-03	17									32	57	41
			KPQY12-04	KPGY12-04	22									30.4	59.5	68
12	1/2	1/2	KPQY12-04	KPGY12-04	22	20.9	17	30.4	36.2	59.5	24	58	46	68		

* Reference dimension for R threads after installation Note 1) ϕD_1 indicates the maximum diameter.

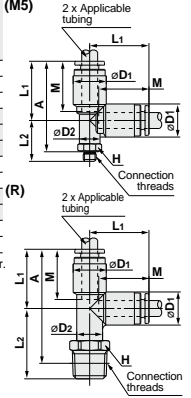

Male Branch: KPQU, KPGU

(M5)	Applicable tubing O.D. (mm)	Connection thread R M	Model		H (width across flats)	Note 1) ϕD	L	P	A*	M	Effective area (mm ²)		Weight (g)		
											TPH	TPS			
4	M5 x 0.8	1/8	KPQU04-M5	KPGU04-M5	11	10.4	10.4	37	42.3	17	4	4	10		
			KPQU04-01	KPGU04-01	14								46.7	41	11
			KPQU04-02	KPGU04-02	14								46.7	41	20
6	M5 x 0.8	1/8	KPQU06-M5	KPGU06-M5	13	12.8	12.8	40.5	44.5	18.5	10	10	11		
			KPQU06-01	KPGU06-01	13								43.9	44.5	12
			KPQU06-02	KPGU06-02	14								49.9	44.5	21
8	1/8	1/8	KPQU08-01	KPGU08-01	17	15.2	15.2	48.5	53.5	20.5	26	18	15		
			KPQU08-02	KPGU08-02	17								59.1	53.5	23
			KPQU10-02	KPGU10-02	19								62.3	57	30
10	3/8	3/8	KPQU10-03	KPGU10-03	19	18.5	18.5	57	54	23	41	29	40		
			KPQU12-03	KPGU12-03	22								59.5	62.5	40
			KPQU12-04	KPGU12-04	22								64.9	62.5	65
12	1/2	1/2	KPQU12-04	KPGU12-04	22	20.9	20.9	59.5	62.5	24	58	46	60		

* Reference dimension for R threads after installation Note 1) ϕD indicates the maximum diameter.

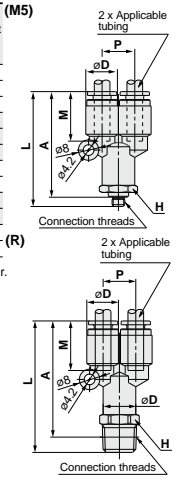

Straight Union: KPQH, KPGH

(M5)	Applicable tubing O.D. (mm)	Model		Note 1) ϕD	L	M	Effective area (mm ²)		Weight (g)
							TPH	TPS	
4	KPQH04-00	KPGH04-00	10.4	35.4	17	4	4	4	
6	KPQH06-00	KPGH06-00	12.8	37.6	18.5	10	10	6	
8	KPQH08-00	KPGH08-00	15.2	42.4	20.5	26	18	10	
10	KPQH10-00	KPGH10-00	18.5	46.6	23	41	29	15	
12	KPQH12-00	KPGH12-00	20.9	48.6	24	58	46	18	

Note 1) ϕD indicates the maximum diameter.

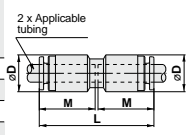

Directional Control Valves
Air Cylinders
Rotary Actuators
Air Grippers
Air Preparation Equipment
Modular F. R.
Pressure Control Equipment
Fittings & Tubing
Flow Control Equipment
Pressure Switches/ Pressure Sensors

Dimensions

Union Elbow: KPQL, KPGL



Applicable tubing O.D. (mm)	Model		Note 1) ϕD		L	Q	M	Effective area (mm ²)		Weight (g)
			ϕD	L				TPH	TPS	
4	KPQL04-00	KPGL04-00	10.4	19.7	4.5	17	3.5	3.5	3	
6	KPQL06-00	KPGL06-00	12.8	21.8	5.3	18.5	9	9	7	
8	KPQL08-00	KPGL08-00	15.2	25.3	6	20.5	22	15	11	
10	KPQL10-00	KPGL10-00	18.5	28.4	6.8	23	35	25	16	
12	KPQL12-00	KPGL12-00	20.9	30.4	7.5	24	50	40	20	

Note 1) ϕD indicates the maximum diameter.

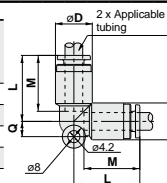

Union Tee: KPQT, KPGT



Applicable tubing O.D. (mm)	Model		Note 1) ϕD		L	Q	M	Effective area (mm ²)		Weight (g)
			ϕD	L				TPH	TPS	
4	KPQT04-00	KPGT04-00	10.4	19.7	4.5	17	4	4	7	
6	KPQT06-00	KPGT06-00	12.8	21.8	5.3	18.5	10	10	9	
8	KPQT08-00	KPGT08-00	15.2	25.3	6	20.5	26	18	16	
10	KPQT10-00	KPGT10-00	18.5	28.4	6.8	23	41	29	25	
12	KPQT12-00	KPGT12-00	20.9	30.4	7.5	24	58	46	29	

Note 1) ϕD indicates the maximum diameter.

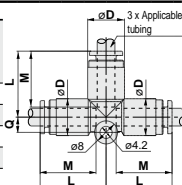

Union "Y": KPQU, KPGU



Applicable tubing O.D. (mm)	Model		Note 1) ϕD		L ₁	L ₂	P	Q	M	Effective area (mm ²)		Weight (g)
			ϕD	L ₁						TPH	TPS	
4	KPQU04-00	KPGU04-00	10.4	36.8	19.6	10.4	9.7	17	4	4	7	
6	KPQU06-00	KPGU06-00	12.8	40.1	21.8	12.8	11.7	18.5	10	10	10	
8	KPQU08-00	KPGU08-00	15.2	46.7	26.5	15.2	13.7	20.5	26	18	17	
10	KPQU10-00	KPGU10-00	18.5	52	29.7	18.5	16.1	23	41	29	26	
12	KPQU12-00	KPGU12-00	20.9	55.2	31.9	20.9	18.1	24	58	46	32	

Note 1) ϕD indicates the maximum diameter.

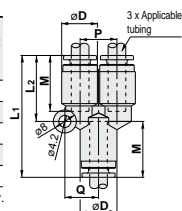

Plug-in Reducer: KPQR, KPGR



Applicable tubing O.D. (mm)	Applicable fitting size ϕd	Model		Note 1) ϕD		L	A	M	Effective area (mm ²)		Weight (g)
				ϕD	L				TPH	TPS	
4	6	KPQR04-06	KPGR04-06	10.4	38.4	19.1	17	4	4	3	
						19.2					
6	8	KPQR06-08	KPGR06-08	12.8	41.5	19.8	18.5	10	10	4	
						20.2					
8	10	KPQR08-10	KPGR08-10	15.2	44	22.2	20.5	26	18	5	
						24.7					
10	12	KPQR10-12	KPGR10-12	18.5	49.5	24.7	23	41	29	9	

Note 1) ϕD indicates the maximum diameter.

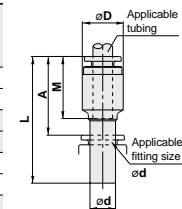

Plug: KPP



Applicable fitting size ϕd	Model	ϕD	L	A	Weight (g)
4	KPP-04	6	32	13.8	0.4
6	KPP-06	8	35	15.7	0.7
8	KPP-08	10	39	17.3	1.1
10	KPP-10	12	43	19.2	1.7
12	KPP-12	14	45.5	20.7	2.5

* The plug is common for series KPQ, KPG and KP.

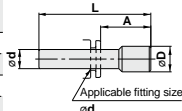



Series KP/KPQ/KPG Specific Product Precautions 1

Be sure to read this before handling.
Refer to page 1382 for Safety Instructions and pages 1237 to 1240 for Fittings and Tubing Precautions.

Selection

⚠ Caution

1. Please consult with SMC regarding fluids other than air, water and nitrogen gas.

Handling

⚠ Caution

1. Store away from direct sunlight at 40°C or less.
2. Open the inner package of double packaging in a clean room or other clean environment.

Installation of Threads

⚠ Caution

Be sure to wind sealant tape around the taper threads for both resin and metal threads.
If used without sealant tape, air leakage can occur.

1. **Series KP (with resin thread)**
 - 1) Winding of sealant tape
Wind the sealant tape 2 to 3 times around the threads, leaving 1.5 to 2 thread ridges exposed at the end of the threads.
 - 2) Tightening
After tightening by hand, tighten an additional 2 to 3 turns using a tightening tool.
2. **Series KPQ/KPG (with metal thread)**
 - 1) For M5
After tightening by hand, tighten approximately 1/6 turn further using a tightening tool. Reference values for the tightening torque are 1 to 1.5 N·m. Excessive tightening can cause air leakage due to thread damage or deformation of the gasket, etc. Insufficient tightening can cause loose threads and air leakage, etc.

Installation of Threads

⚠ Caution

- 2) Taper thread
 - (1) Winding of sealant tape
Wind the sealant tape 2 to 3 times around the threads, leaving 1 thread ridge exposed at the end of the threads.
 - (2) When installing, tighten with the proper torque shown in the table below. As a rule, this corresponds to two or three turns with a tool after tightening by hand.

Connection thread size	Proper tightening torque (N·m)
R1/8	7 to 9
R1/4	12 to 14
R3/8	22 to 24
R1/2	28 to 30

3. Tightening tools

Tighten with an appropriate wrench using the hexagon wrench flats on the body.
Position the wrench on the base as close as possible to the threads. If the size of the wrench is not suitable for the hexagon wrench flats, the wrench flats may be crushed.

Installation and Removal of Tubing

⚠ Caution

1. **Installation of tubing**
 - 1) Grease is not used due to the KP series oil-free specifications. For this reason, greater insertion force is required when tubing is installed. In particular, polyurethane tubing may fold when inserted due to its softness. Hold the end of the tubing, and insert it all the way in slowly and securely. Refer to dimension "M" in the dimension drawings for guidance on the insertion depth of tubing.
2. **Removal of tubing**
 - 1) The outside diameter of tubes that have been used at high temperatures or for long periods of time will expand, and in some cases pipe fittings cannot be reattached. Tubes that cannot be attached should be discarded and replaced with new ones.

Directional
Control Valves

Air Cylinders

Rotary Actuators

Air Grippers

Air Preparation
Equipment

Modular F. R.

Pressure Control
Equipment

Fittings & Tubing

Flow Control
Equipment

Pressure Switches/
Pressure Sensors



Series KP/KPQ/KPG

Specific Product Precautions 2

Be sure to read this before handling.
Refer to page 1382 for Safety Instructions and pages 1237 to 1240
for Fittings and Tubing Precautions.

Operating Environment

Warning

1. Do not use in environments or locations where there is a danger of damage to fittings and tubing.
For fitting and tubing materials, refer to specifications and construction drawings, etc.
2. Provide shade in locations which receive direct sunlight.

Caution

1. The KP series are special One-touch fittings for use on clean blowing and washing lines.
Please consult with SMC regarding other types of applications.

Seal material: The durability of EPDM with respect to mineral oils is inferior, making it unsuitable for piping in general pneumatic equipment.
Use the KPQ and KPG series for piping to general pneumatic equipment.

Maintenance

Caution

1. Tightening of blow fittings (resin taper threads for piping)
Since the KP series taper threads are made of resin, minute leakage may gradually occur due to stress relaxation. Perform periodic inspections, and if leakage is detected correct the problem by further tightening. If additional tightening becomes ineffective, replace the fitting with a new product.
2. Check for the following during regular maintenance, and replace components as necessary.
 - a) Scratches, gouges, abrasion, corrosion
 - b) Leakage, refer to item 3 regarding taper thread leakage.
 - c) Twisting, flattening or distortion of tubing
 - d) Hardening, deterioration or softness of tubing
3. Do not repair or patch the replaced tubing or fittings for reuse.

Series 10-TU Polyurethane Tubing

RoHS

How to Order

For general pneumatic tubing
Flexible
Polyurethane tubing



10 - TU0425 BU - 20

Clean series | Tubing model | Color
B — Black
W — White
R — Red
BU — Blue
Y — Yellow
G — Green
C — Clear
YR — Orange

Length per roll
20 — 20 m roll

Burst Pressure Characteristics Curve and Operating pressure

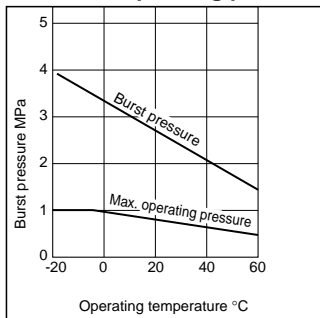

Model

● — 20 m roll

Model	Tubing size						
	Inch size (Series TIUB)	Metric size (Series TU)					
	10-TIUB01	10-TU0212	10-TU0425	10-TU0604	10-TU0805	10-TU1065	10-TU1208
O.D. (mm)	3.2	2	4	6	8	10	12
I.D. (mm)	2	1.2	2.5	4	5	6.5	8
Black (B)	●	●	●	●	●	●	●
White (W)	●	●	●	●	●	●	●
Red (R)	●	●	●	●	●	●	●
Blue (BU)	●	●	●	●	●	●	●
Yellow (Y)	●	●	●	●	●	●	●
Green (G)	●	●	●	●	●	●	●
Clear (C)	●	●	●	●	●	●	●
Orange (YR)	●	●	●	●	●	●	●

Specifications

Fluid	Air, Water					
Max. operating pressure (20°C)	0.8 MPa					
Burst pressure	Refer to the burst pressure characteristics curve.					
Recommended fittings	Clean series fittings 10-KQ2, 10-KF, 10-KDM, 10-KG 10-M, 10-MS, KP, KPQ, KPG					
Min. bending radius (mm)	10	4	15	20	27	35
Operating temperature	-20 to 60°C, Water: 0 to 40°C (No freezing)					
Material	Polyurethane					
Cleanliness class (ISO class)	Class 3					

⚠ Precautions

Be sure to read this before handling.
Refer to page 1382 for Safety Instructions and pages 1237 to 1240 for Fittings and Tubing Precautions.

⚠ Caution

- Applicable for general industrial water. Please consult with SMC if using for the other kind of fluid. Also, the surge voltage pressure must be under the maximum operating pressure. If the surge pressure exceeds the maximum operating pressure, it will result in damage to fittings and tubes.
- The value of the max. operating pressure is at a temperature of 20°C. Refer to the burst pressure characteristics curve for other temperatures. Furthermore, abnormal temperature rises caused by adiabatic compression may result in the burst of the tube.
- The value of the minimum bending radius is measured at the temperature of 20°C as shown in the figure on the right.

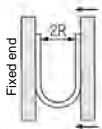

Bend the tube into U-form at a temperature of 20°C. Fix one end and close loop gradually. Measure 2R when the tube breaks or is crushed.

Directional Control Valves

Air Cylinders

Rotary Actuators

Air Grippers

Air Preparation Equipment

Modular F. R.

Pressure Control Equipment

Fittings & Tubing

Flow Control Equipment

Pressure Switches/Pressure Sensors

Series 10-TCU

Polyurethane Coil Tubing

RoHS

For flexible tubing
Compact piping possible



Burst Pressure Characteristics Curve and Operating Pressure

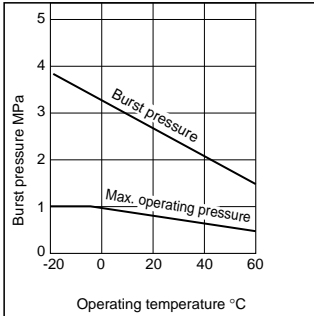

Specifications

Model	10-TCU	10-TCU	10-TCU	10-TCU	10-TCU	10-TCU	10-TCU
	0425B-1	0425B-2	0425B-3	0604B-1	0604B-2	0604B-3	0805B-1
Number of cores	1	2	3	1	2	3	1
Tubing O.D. (mm)	4			6			8
Tubing I.D. (mm)	2.5			4			5
Fluid	Air						
Max. operating pressure (20°C)	0.8 MPa						
Burst pressure	Refer to the burst pressure characteristics curve.						
Recommended fittings	Clean series fittings 10-KQ2, 10-KF, 10-KDM, 10-KG, 10-M, 10-MS, KP, KPQ, KPG						
Operating temperature	-20 to 60°C						
Material	Polyurethane						
Color	Black						
Cleanliness class (ISO class)	Class 3						

⚠ Precautions

Be sure to read this before handling.
Refer to page 1382 for Safety Instructions and pages 1237 to 1240 for Fittings and Tubing Precautions.

⚠ Caution

- Please consult with SMC regarding use with any fluids other than air.
- The value of the max. operating pressure is at a temperature of 20°C. Refer to the burst pressure characteristics curve for other temperatures. Furthermore, abnormal temperature rises caused by adiabatic compression may result in the burst of the tube.
- Please do not cut the coil and insert it into the fitting. This may cause air leakage, or tubing to come out after installation.

Dimensions

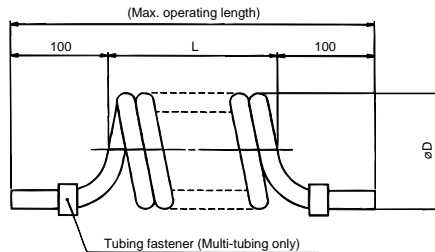

Specifications Model	Tubing size (mm)		Coil (mm)		Number of cores	No. of coil windings per tubing length	Max. operating length (m)
	O.D.	I.D.	L	D			
10-TCU0425B-1	4	2.5	210	18	1	52±2	1.5
10-TCU0425B-2			280	28	2	35±1	
10-TCU0425B-3			265		3	22±1	
10-TCU0604B-1	6	4	325	24	1	54±2	2
10-TCU0604B-2			37	2	27±1	1.5	
10-TCU0604B-3			305		3	17±1	1
10-TCU0805B-1	8	5	330	31	1	41±2	2

* The number of coil windings per tube length and dimensions are changeable due to material.

Series 10-TFU

Polyurethane Flat Tubing

RoHS

Compact piping possible



Burst Pressure Characteristics Curve and Operating Pressure

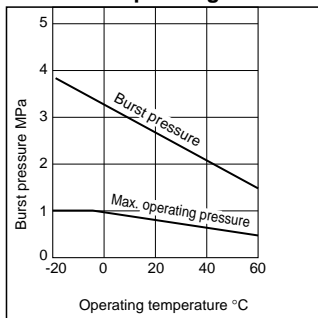

⚠ Precautions

Be sure to read this before handling.
 Refer to page 1382 for Safety Instructions and pages 1237 to 1240 for Fittings and Tubing Precautions.

⚠ Caution

- Please consult with SMC regarding use with any fluids other than air.
- The value of the max. operating pressure is at a temperature of 20°C. Refer to the burst pressure characteristics curve for other temperatures. Furthermore, abnormal temperature rises caused by adiabatic compression may result in the burst of the tube.
- The value of the minimum bending radius is measured at the temperature of 20°C as shown in the figure on the right.
- As a result of product design characteristics, there are cases of very slight leakage.

Specifications

Model	10-TFU 0425B-2	10-TFU 0425B-3	10-TFU 0604B-2	10-TFU 0604B-3	10-TCU 0805B-2	10-TCU 0805B-3
Number of cores	2	3	2	3	2	3
Tubing O.D. (mm)	4		6		8	
Tubing I.D. (mm)	2.5		4		5	
Fluid	Air					
Max. operating pressure (20°C)	0.8 MPa					
Burst pressure	Refer to the burst pressure characteristics curve.					
Recommended fittings	Clean series fittings 10-KQ2, 10-KF, 10-KDM, 10-KG 10-M, 10-MS, KP, KPQ, KPG					
Operating temperature	-20 to 60°C					
Material	Polyurethane					
Color	Black					
Min. bending radius (mm)	10		15		20	
Tubing length per roll (m)	10					
Cleanliness class (ISO class)	Class 3					

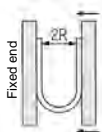

Bend the tube into U-form at a temperature of 20°C. Fix one end and close loop gradually. Measure 2R when the tube breaks or is crushed.

Directional Control Valves

Air Cylinders

Rotary Actuators

Air Grippers

Air Preparation Equipment

Modular F. R.

Pressure Control Equipment

Fittings & Tubing

Flow Control Equipment

Pressure Switches/ Pressure Sensors

Series TPH Clean Tubing Polyolefin Tubing



How to Order



TPH0604 B 20

• **Tubing model**

• **Color**

Symbol	Color
W	White
B	Black
R	Red
BU	Blue
Y	Yellow
G	Green

• **Length per roll**

Symbol	Length
20	20 m roll
100	100 m reel

Burst Pressure Characteristics Curve and Operating Pressure

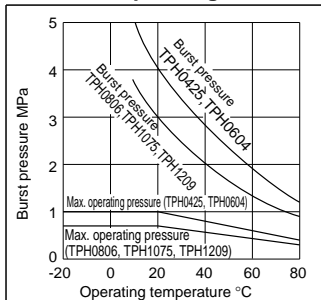

Model

● -20 m roll □ -100 m reel

Model	TPH0425	TPH0604	TPH0806	TPH1075	TPH1209
O.D. (mm)	4	6	8	10	12
I.D. (mm)	2.5	4	6	7.5	9
White (W)	●	●	●	●	●
Black (B)	●	●	●	●	●
Red (R)	●	●	●	●	●
Blue (BU)	●	●	●	●	●
Yellow (Y)	●	●	●	●	●
Green (G)	●	●	●	●	●

Specifications

Fluid	Air, Nitrogen gas, Water (Deionized water) ^{Note 1)}				
Max. operating pressure (20°C)	1.0 MPa ^{Note 2)}		0.7 MPa ^{Note 2)}		
Min. bending radius (mm)	15	25	35	45	55
Burst pressure	Refer to the burst pressure characteristics curve.				
Operating temperature	-20 to 80°C, for water 5 to 80°C (No freezing)				
Material	Polyolefin resin				
Cleanliness class (ISO class)	Class 3				

Note 1) Please consult with SMC regarding other fluids.

Note 2) The maximum operating pressure is the value at 20°C. Refer to the burst pressure characteristics curve for other temperatures. Furthermore, an abnormal temperature rise due to adiabatic compression can cause tubing to burst.

Note 3) The minimum bending radius indicates the value at a temperature of 20°C with an outside diameter change rate of 10% or less. At higher temperatures, the outside diameter change rate may exceed 10% within the minimum bending radius.

Caution

The TPH series was specially designed for clean blowing and washing lines. Please consult with SMC for use in other applications.
Materials: The durability of polyolefin resin against mineral oils is inferior. Because of this, it is unsuitable for general pneumatic equipment lines.

Series **TPS** Clean Tubing Soft Polyolefin Tubing

RoHS

How to Order



TPS0604 B 20

Tubing model

Color

Symbol	Color
W	White
B	Black
R	Red
BU	Blue
Y	Yellow
G	Green

Length per roll

Symbol	Length
20	20 m roll
100	100 m reel

Burst Pressure Characteristics Curve and Operating Pressure

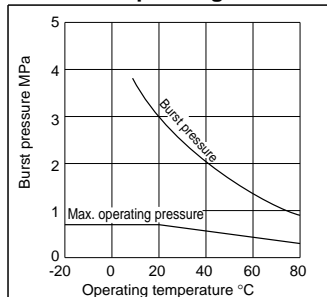

Model

● -20 m roll □ -100 m reel

Model	TPS0425	TPS0604	TPS0805	TPS1065	TPS1208
O.D. (mm)	4	6	8	10	12
I.D. (mm)	2.5	4	5	6.5	8

White (W)	●	●	●	●	●
Black (B)	●	●	●	●	●
Red (R)	●	●	●	●	●
Blue (BU)	●	●	●	●	●
Yellow (Y)	●	●	●	●	●
Green (G)	●	●	●	●	●

Specifications

Fluid	Air, Nitrogen gas, Water (Deionized water) ^{Note 1)}				
Max. operating pressure (20°C)	0.7 MPa ^{Note 2)}				
Min. bending radius (mm)	10	20	25	30	40
Burst pressure	Refer to the burst pressure characteristics curve.				
Operating temperature	-20 to 80°C, for water 0 to 80°C (No freezing)				
Material	Polyolefin resin				
Cleanliness class (ISO class)	Class 3				

Note 1) Please consult with SMC regarding other fluids.

Note 2) The maximum operating pressure is the value at 20°C. Refer to the burst pressure characteristics curve for other temperatures. Furthermore, an abnormal temperature rise due to adiabatic compression can cause tubing to burst.

Note 3) The minimum bending radius indicates the value at a temperature of 20°C with an outside diameter change rate of 10% or less. At higher temperatures, the outside diameter change rate may exceed 10% within the minimum bending radius.

Caution

The TPS series was specially designed for clean blowing and washing lines. Please consult with SMC for use in other applications.

Materials: The durability of polyolefin resin against mineral oils is inferior. Because of this, it is unsuitable for general pneumatic equipment lines.

Directional Control Valves

Air Cylinders

Rotary Actuators

Air Grippers

Air Preparation Equipment

Modular F. R.

Pressure Control Equipment

Fittings & Tubing

Flow Control Equipment

Pressure Switches/Pressure Sensors



Fittings & Tubing Precautions 1

Be sure to read this before handling.

Design / Selection

⚠ Warning

1. Check the specifications.

The products in this catalog are designed to be used in compressed air systems (including vacuum) only. If the products are used in an environment where pressure or temperature is out of the specified range, damage and/or malfunction may result. Do not use under such conditions. (Refer to the specifications.) Please consult with SMC when using a fluid other than compressed air (including vacuum). We do not guarantee against any damage if the product is used outside of the specification range.

2. Do not disassemble the product or make any modifications, including additional machining.

It may cause human injury and/or an accident.

3. Check if PTFE can be used in application.

PTFE powder (Polytetrafluoroethylene resin) is included in the seal material. Confirm that the use of it will not cause any adverse affect on the system.

⚠ Caution

1. Keep the connection part of fittings and tubing from rotating or oscillating movement. Use Rotary One-touch Fittings Series KS or KX in these cases.

The fittings may be damaged if they are used in the above manner.

2. The tubing bending radius in the vicinity of the fitting should be at least the minimum bending radius of the tubing.

If the bending radius is less than the min. value, fittings may damage, or tubing may crack or be crushed. The minimum bending radius of the FR soft nylon tubing (Series TRS), FR double layer tubing (Series TRB), antistatic soft nylon tubing (Series TAS), polyolefin tubing (Series TPH), soft polyolefin tubing (Series TPS) is measured as following in accordance with JIS B8381.

Tubing deformation ratio at the minimum bending radius is obtained through the following formula, based on tubing diameter and mandrel diameter by wrapping the same radius mandrel tube.

$$\eta = \left(1 - \frac{L-D}{2d}\right) \times 100$$

Here, η : Deformation ratio (%)
d: Tubing diameter (mm)
L: Measured length (mm)
D: Mandrel diameter (mm)
(Twice against the minimum bending radius)
Test temperature: 20 ±5°C
Relative humidity: 65 ±5%

Tube deformation ratio at the minimum bending radius

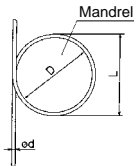

3. Do not use fluids other than listed on the specifications.

Applicable fluids are air and water. Please consult with SMC if using other fluids.

4. When it is used with water, the fittings or tubing may be damaged depending on the surge pressure.

Mounting / Piping

⚠ Warning

1. Operation manual

Install the products and operate them only after reading the operation manual carefully and understanding its contents. Also, keep the manual where it can be referred to as necessary.

2. Ensure sufficient space for maintenance activities.

When installing the products, allow access for maintenance.

3. Tightening the threaded portion of the thread.

When installing the products, refer to "Tightening the threaded portion of the connection thread".

4. There may be cases of the tubing detaching from the fitting and thrashing around uncontrollably due to tubing degradation or fitting breakage.

To prevent the situation from becoming uncontrollable, fit the tubing with a protective cover or fix it in place.

⚠ Caution

1. Preparation before piping

Before piping is connected, it should be thoroughly blown out with air (flushing) or washed to remove chips, cutting oil and other debris from inside the pipe.

2. Winding of sealant tape

When screwing together pipes and fittings, etc., be certain that chips from the pipe threads and sealing material do not get inside the pipe. Also, when the sealant tape is used, leave approx. 1 thread ridge exposed at the end of the threads.

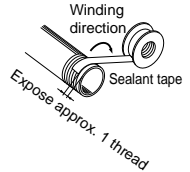

3. Check the model, type and size before installation.

Also, confirm that there is no scratches, gouges or cracks on the product.

4. When connecting the tubing, take pressure or possible changes to the tubing length into account, and allow a sufficient margin.

Failure to do so may result in fitting breakage or detachment of the tubing. Refer to the recommended piping conditions.

5. Do not apply unnecessary forces such as twisting, pulling, moment loads, vibration and impact, etc. on fittings or tubing.

This will cause damage to fittings and will crush, burst or release tubing.

6. Tubing, with the exception of coiled tubing, requires stationary installation. Do not use standard tubing (non-coiled) in applications where tubing is required to travel inside the flexible protection tube. Tubing that travels may sustain abrasion, extension, or severance due to tensile force, or may result in removal of tubing from fitting. Use caution prior to use for proper application.

7. To install the fitting, screw the fitting into the hexagonal face of the body, and tighten with an appropriate wrench.

Affix the wrench at the base of the thread. If the size of hexagonal face and wrench do not match, or tightening takes place near the tube side, it may cause collapse or deformation of the hexagonal face, or damage to the equipment. After installing, confirm that there is no damage to the fitting, etc.



Fittings & Tubing Precautions 2

Be sure to read this before handling.

Air Supply

Warning

1. Type of fluids

Please consult with SMC when using the product in applications other than compressed air.

Regarding products for general fluids, please contact SMC concerning applicable fluids.

2. When there is a large amount of drainage.

Compressed air containing a large amount of drainage can cause malfunction of pneumatic equipment. An air dryer or water separator should be installed upstream from filters.

3. Drain flushing

If condensation in the drain bowl is not emptied on a regular basis, the bowl will overflow and allow the condensation to enter the compressed air lines. It causes malfunction of pneumatic equipment.

If the drain bowl is difficult to check and remove, installation of a drain bowl with an auto drain option is recommended.

For details on the above compressed air quality, refer to SMC Best Pneumatics catalog.

4. Use clean air.

Do not use compressed air that contains chemicals, synthetic oils including organic solvents, salt or corrosive gases, etc., as it can cause damage or malfunction.

Caution

1. Install an air filter.

Install an air filter at the upstream side of valve.
Select an air filter with a filtration degree of 5 µm or finer.

2. Install an after-cooler, air dryer or water droplet separator, etc.

Compressed air that contains a large amount of drainage can cause malfunction of pneumatic equipment. Therefore, take appropriate measures to ensure air quality, such as by providing an aftercooler, air dryer, or water droplet separator.

3. Ensure that the fluid and ambient temperature are within the specified range.

If the fluid temperature is 5°C or less, the moisture in the circuit could freeze, causing damage to the seals and leading to equipment malfunction. Therefore, take appropriate measures to prevent freezing.

For details on the above compressed air quality, refer to SMC Best Pneumatics catalog.

Operating Environment

Warning

1. Do not use in an atmosphere having corrosive gases, chemicals, sea water, water, water steam, or where there is direct contact with any of these.

Refer to each construction drawing on the fittings and tubing material.

2. Do not expose the product to direct sunlight for an extended period of time.

3. Do not use in a place subject to heavy vibration and/or shock.

4. Do not mount the product in locations where it is exposed to radiant heat.

Operating Environment

Warning

5. Do not use the ordinary fittings and tubing in locations where static electricity would be problematic.

It may result in the system failure and trouble. In such places, use of antistatic fittings (Series KA) and antistatic tubing (Series TA) are recommended.

6. Do not use the ordinary fittings and tubing in locations where spatter is generated.

Spattering may result in a fire hazard. In such a place, use of flame resistant fittings (Series KR/KRM) and flame resistant tubing (Series TRS/TRB/TRBU/TRTU) are recommended.

7. Do not use in an environment where the product is directly exposed to cutting oil, lubricant, coolant oil, etc.

Please contact SMC if using for an environment exposed to cutting oil, lubricant or coolant oil, etc.

8. Take note that if nylon tubing, soft nylon tubing and antistatic tubing are used in a clean room.

The antioxidant on the surface of the soft nylon tubing may come off, thereby lowering the cleanliness level.

9. Do not use in environments where foreign matter may stick to the product or get mixed in the product's interior.

This may cause leakage or disconnection of the tubing.

Maintenance

Warning

1. Perform maintenance inspection according to the procedures indicated in the operation manual.

If handled improperly, malfunction and damage of machinery or equipment may occur.

2. Maintenance work

If handled improperly, compressed air can be dangerous. Assembly, handling, repair and element replacement of pneumatic systems should be performed by a knowledgeable and experienced person.

3. Drain flushing

Remove drainage from air filters regularly.

4. Removal of equipment, and supply/exhaust of compressed air

When components are removed, first confirm that measures are in place to prevent workpieces from dropping, run-away equipment, etc. Then, cut off the supply pressure and electric power, and exhaust all compressed air from the system using the residual pressure release function.

When machinery is restarted, proceed with caution after confirming that appropriate measures are in place to prevent cylinders from sudden movement.

Directional Control Valves

Air Cylinders

Rotary Actuators

Air Grippers

Air Preparation Equipment

Modular F. R.

Pressure Control Equipment

Fittings & Tubing

Flow Control Equipment

Pressure Switches/ Pressure Sensors



Fittings & Tubing Precautions 3

Be sure to read this before handling.

Maintenance

⚠ Caution

1. Be certain to wear safety glasses at all times during periodical inspections.
2. Replace fittings or tubing having the following problems.
 - 1) Cracks, gouges, wearing, corrosion
 - 2) Air leakage
 - 3) Twists or crushing of tubing
 - 4) Hardening, deterioration, softening of tubing
3. When replacing tubes or fittings, do not try to mend or repair and then reuse them.

One-touch Fittings Mounting / Piping

⚠ Caution

1. Installation and removal of tubing for One-touch fittings

1) Installation of tubing

- (1) Cut the tubing perpendicularly, being careful not to damage the outside surface. Use an SMC tube cutter "TK-1", "TK-2" or "TK-3". Do not cut the tubing with pliers, nippers, scissors, etc., otherwise, the tubing will be deformed and trouble may result.
- (2) The outside diameter of the polyurethane tubing swells when internal pressure is applied to it. Therefore, it may be possible that the tubing cannot be re-inserted into the One-touch fitting. Check the tubing outside diameter, and when the accuracy of the outside diameter is +0.07 mm or larger for $\phi 2$, +0.15 mm or larger for other sizes, insert into the One-touch fitting again, without cutting the tubing to use it. When the tubing is re-inserted into the One-touch fitting, confirm that the tubing goes through the release button smoothly.
- (3) Grasp the tubing, slowly push it straight (0 to 5°) into the One-touch fitting until it comes to a stop.
- (4) Pull the tubing back gently to make sure it has a positive seal. Insufficient installation may cause air to leak or the tubing to release.

2) Removal of tubing

- (1) Push the release button flange evenly and sufficiently to release the tube.
- (2) Pull out the tubing while keeping the release button depressed. If the release button is not held down sufficiently, the tubing cannot be withdrawn.
- (3) To reuse the tubing, remove the previously lodged portion of the tubing. If the lodged portion is left on without being removed, it may result in air leakage and removal of the tubing difficult.

2. Connecting products with metal rods

Products with metal rods (Series KC, old Series KQ, Series KN, and Series KM, etc.) cannot be connected to Series KQ2 One-touch fittings. If connected, the metal rod cannot be retained by the chuck of the One-touch fitting and products with metal rods may project during pressurization, causing serious personal injury or accident.

Even when products with metal rods can be connected to other One-touch fittings, do not use any tube, resin plug, or reducer after connection. This may cause releasing.

For details about One-touch fittings that can connect products with metal rods, contact SMC.

One-touch Fittings Mounting / Piping

⚠ Caution

3. When mounting tubes, resin plugs, reducers etc., do not press the release button.

Also, do not press the release button unnecessarily before mounting them. This may cause those parts to come off. In particular, when piping products, such as plug-in elbows or reducers, etc. the release button may be pressed easily due to product handling during piping work.

Tightening the threaded portion of the connection thread

1. Connection thread: M3

First, tighten by hand, then use a wrench appropriate for the hexagon flats of the body to tighten an additional 1/4 turn. A reference value for the tightening torque is 0.4 to 0.5 N·m.

2. Connection thread: M5 and 10-32UNF

First, tighten by hand, then use a wrench appropriate for the hexagon flats of the body to tighten an additional 1/6 to 1/4 turn. A reference value for the tightening torque is 1 to 1.5 N·m.

3. M6

First, tighten by hand, then use a wrench appropriate for the hexagon flats of the body to tighten an additional 1/6 to 1/4 turn. Note) Excessive tightening may damage the thread portion or deform the gasket and cause air leakage. Insufficient tightening may loosen the threads, or cause air leakage.

4. Fittings with sealant: R, NPT

1. First, tighten the fitting by hand, then use a wrench appropriate for the hexagon flats of the body to tighten it a further two or three turns. For a tightening torque guide, see the table below.

Connection thread size (R, NPT)	Tightening torque (N·m)
1/16, 1/8	3 to 5
1/4	8 to 12
3/8	15 to 20
1/2	20 to 25

2. If the fitting is tightened with excessive torque, a large amount of sealant will seep out. Remove the excess sealant.
3. Insufficient tightening may cause seal failure, or loosen the threads.
4. Reuse
 - 1) Normally, fittings with a sealant can be reused 2 to 3 times.
 - 2) To prevent air leakage through the sealant, remove any loose sealant stuck to the fitting by blowing air over the threaded portion.
 - 3) If the sealant no longer provides effective sealing, wrap sealing tape over the sealant before reusing. Do not use the sealant in any form other than a tape type.
 - 4) Once the fitting has been tightened, backing it out to its original position often causes the sealant to become defective. Air leakage will occur.



Fittings & Tubing Precautions 4

Be sure to read this before handling.

Tightening the threaded portion of the connection thread

5. Uni Thread Fittings

- 1) First, tighten the threaded portion by hand, then use a proper wrench, which could be suitable for the width across flats of the hexagon body, to tighten it further at a wrench tightening angle shown below. As a reference value for the tightening torque, refer to the table below.

Connection Female Thread: Rc, NPT, NPTF

Uni thread size	Wrench tightening angle after tightened by hand (deg)	Tightening torque (N·m)
1/8	30 to 60	3 to 5
1/4	30 to 60	8 to 12
3/8	15 to 45	14 to 16
1/2	15 to 30	20 to 22

Connection Female Thread: G

Uni thread size	Wrench tightening angle after tightened by hand (deg)	Tightening torque (N·m)
1/8	30 to 45	3 to 4
1/4	15 to 30	4 to 5
3/8	15 to 30	8 to 9
1/2	15 to 30	14 to 15

- 2) The gasket can be recycled up to 6 to 10 times. It can be replaced easily when it has sustained damage. A broken gasket can be removed by holding it and then turning it in the same direction as loosening the thread. If gasket is difficult to remove, cut it with nippers, etc. In such a case, use caution not to scratch the seat face because the seat face of 45° gasket of fitting is the sealing face.

Chamfer Dimension for Female Thread

⚠ Caution

1. Chamfer dimension for female thread of the connection thread M3, M5, 10-32UNF

Confirming to ISO 16030 (air pressure fluid dynamics – connection – ports and stud ends), the chamfer dimensions shown below are recommended. By chamfering as shown in the following table, machining of threads is easier and effective for burr prevention.

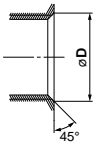

Connection thread size	Chamfer dimension ϕD (Recommended value) (mm)
M3	3.1 to 3.4
M5	5.1 to 5.4
10-32UNF	5.0 to 5.3

2. Chamfer dimension of R and NPT thread with sealant, and Uni thread

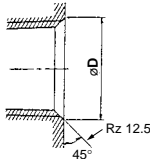

Connection thread size	Chamfer dimension ϕD (Recommended value)		
	G	Rc	NPT, NPTF
1/16	—	—	8.2 to 8.4
1/8	10.2 to 10.6	10.2 to 10.4	10.5 to 10.7
1/4	13.6 to 14.0	13.6 to 13.8	14.1 to 14.3
3/8	17.1 to 17.5	17.1 to 17.3	17.4 to 17.6
1/2	21.4 to 21.8	21.4 to 21.6	21.7 to 21.9

* For Uni thread, Rz 12.5 is necessary for sealing at the chamfered part.

Recommended Piping Conditions

1. When connecting piping to the One-touch fitting, use pipe length with sufficient margin, in accordance with the piping conditions shown in Fig. 1.

Also, when using a tying band, etc., to bind the piping together, make sure that external force does not come to bear on the fitting. (See Fig. 2.)

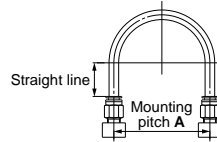

Fig. 1 Recommended piping

Unit: mm

Tubing size	Mounting pitch A			Straight line length
	Nylon tubing	Soft nylon tubing	Polyurethane tubing	
$\phi 2$	—	—	13 or more	10 or more
$\phi 3.2, 1/8"$	44 or more	35 or more	25 or more	16 or more
$\phi 4, 5/32"$	56 or more	44 or more	26 or more	20 or more
$\phi 3/16"$	67 or more	52 or more	38 or more	24 or more
$\phi 6$	84 or more	66 or more	39 or more	30 or more
$\phi 1/4"$	89 or more	70 or more	57 or more	32 or more
$\phi 8, 5/16"$	112 or more	88 or more	52 or more	40 or more
$\phi 10$	140 or more	110 or more	69 or more	50 or more
$\phi 3/8"$	134 or more	105 or more	69 or more	48 or more
$\phi 12$	168 or more	132 or more	88 or more	60 or more
$\phi 1/2"$	178 or more	140 or more	93 or more	64 or more
$\phi 16$	224 or more	176 or more	114 or more	80 or more

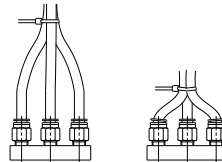

Fig. 2 When using a tying band to bind the piping together

Tubing Design / Selection

⚠ Caution

1. When using a tubing other than from SMC, be careful of the tolerance of the tubing O.D. and tubing material.

- 1) Nylon tubing Within ± 0.1 mm
- 2) Soft nylon tubing Within ± 0.1 mm
- 3) Polyurethane tubing Within $+0.15$ mm, Within -0.2 mm

Do not use the tubing which does not satisfy the specified tubing O.D. accuracy, or if the tubing has a different I.D., material, hardness, or surface roughness from those of SMC's tubing. Please consult SMC if there is anything unclear. It may cause difficulty in connecting the tubing, leakage, disconnection of the tubing, or fitting damage.

When used with tubing other than those from SMC, due to their properties, the products listed below are not subject to warranty.

KQG2, KQB2, KFG2, KF, $\phi 2$ MM

2. When using fittings other than those from SMC, be certain to confirm that operating conditions are such that no problems will arise.

For Clean Room

Flow Control Equipment

Contents	Series	Page
Push-lock Type Speed Controller with One-touch Fitting: Elbow Type/Universal Type	10-AS-F	P.1243
Push-lock Type Speed Controller with Indicator: Elbow Type	10-AS-FS	P.1249
Speed Controller with One-touch Fitting: Elbow Type/Universal Type	10-AS-F	P.1253
Speed Controller with One-touch Fitting: In-line Type	10-AS	P.1257
Dual Speed Controller with One-touch Fitting	10-ASD	P.1261
Push-lock Type Speed Controller with One-touch Fitting: Stainless Steel Type (Elbow/Universal)	10-AS-FG	P.1265
Push-lock Type Speed Controller with Indicator: Stainless Steel Type (Elbow)	10-AS-FSG	P.1271
Stainless Steel Speed Controller with One-touch Fittings (Elbow/Universal Type)	10-AS-FG	P.1275
Stainless Steel Speed Controller with One-touch Fittings (In-line Type)	10-AS-FG	P.1279
Stainless Steel Dual Speed Controller with One-touch Fittings	10-ASD-FG	P.1282
Speed Controller: Cylinder Direct Mount Type/Metal Elbow Type	10-AS1200 to 4200	P.1286
Speed Controller: In-line Type	10-AS1000 to 5000	P.1288
Clean Speed Controller with One-touch Fittings: Elbow Type	(21-)AS-FPQ/FPG	P.1291
Speed Controller for Low Speed Operation with One-touch Fittings: Elbow Type/Universal Type	10-AS-FM	P.1294
Speed Controller for Low Speed Operation with One-touch Fittings: In-line Type	10-AS-FM	P.1298
Dual Speed Controller for Low Speed Operation	10-ASD-FM	P.1301
Precautions		P.1305

Directional
Control Valves

Air Cylinders

Rotary Actuators

Air Grippers

Air Preparation
Equipment

Modular F. R.

Pressure Control
Equipment

Fittings & Tubing

Flow Control
Equipment

Pressure Switches/
Pressure Sensors

Series 10-AS-F

Push-lock Type

RoHS

Speed Controller with One-touch Fitting
Elbow Type/Universal Type

How to Order

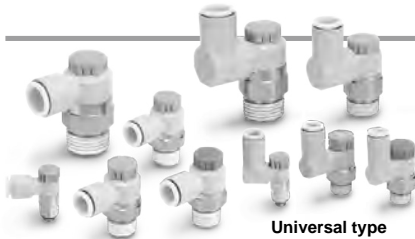

Elbow type

Universal type

Body size

1	M5 x 0.8 10-32UNF
---	----------------------

Width across flats (H)

E	8 mm
Nil	9 mm

Port size

M5	M5 x 0.8
U10/32	10-32UNF

Applicable tubing O.D. ^{Note 1)}

Metric size		Inch size	
02	ø2	01	ø1/8"
23	ø3.2 ^{Note 2)}	03	ø5/32"
04	ø4	07	ø1/4"
06	ø6		

Note 1) For selecting applicable tubing O.D., refer to the "Model" on the table below.

Metric size and inch size types can be visually identified by color of the release button.

Metric size: Light gray

Inch size: Orange

Note 2) Use ø1/8" tube.

Body size 1

10-AS 1 2 0 1 F - M5 E - 06 A

Body size 2/3/4

10-AS 2 2 0 1 F - 01 - 06 S A

Clean series

Body size

2	1/8, 1/4
3	3/8
4	1/2

Type

2	Elbow
3	Universal

Thread type

Nil	R
N	NPT

Control type ^{Note)}

0	Meter-out
1	Meter-in

Note) Meter-out and meter-in types can be visually identified by color of the knob.
Meter-out: Gray
Meter-in: Light blue

Port size

01	1/8
02	1/4
03	3/8
04	1/2

Applicable tubing O.D. ^{Note 1)}

Metric size		Inch size	
23	ø3.2 ^{Note 2)}	01	ø1/8"
04	ø4	03	ø5/32"
06	ø6	07	ø1/4"
08	ø8	09	ø5/16"
10	ø10	11	ø3/8"
12	ø12	13	ø1/2"
16	ø16		

Note 1) For selecting applicable tubing O.D., refer to the "Model" on page 5.

Note 2) Use ø1/8" tube.

Push-lock type

Seal method

Nil	Without sealant
S	With sealant

Model

Model		Port size	Seal method	Applicable tubing O.D.															
Elbow type	Universal type			Metric size						Inch size									
				2 ^{Note 2)}	3.2	4	6	8	10	12	16	1/8"	5/32"	1/4"	5/16"	3/8"	1/2"		
10-AS12□1F-M5□	10-AS13□1F-M5□	M5 x 0.8	Gasket seal	● ^{Note 3)}	●	●	●						●	●	●				
10-AS12□1F-U10/32□	10-AS13□1F-U10/32□	10-32UNF	Gasket seal	● ^{Note 3)}	●	●	●						●	●	●				
10-AS22□1F-01	10-AS23□1F-01	R NPT	Note 1) Sealant		●	●	●	●	● ^{Note 3)}				●	●	●	●			
10-AS22□1F-02	10-AS23□1F-02			1/8		●	●	●	●	●	●				●	●	●	●	
10-AS32□1F-03	10-AS33□1F-03			1/4		● ^{Note 3)}	●	●	●	●	●				● ^{Note 3)}	●	●	●	●
10-AS32□1F-04	10-AS33□1F-04			1/4			●	●	●	●	●					●	●	●	●
10-AS32□1F-03	10-AS33□1F-03	3/8			●	●	●	●	●					●	●	●	●		
10-AS42□1F-04	10-AS43□1F-04	1/2							●	●	● ^{Note 3)}					●	●	●	

Note 1) "Without sealant" type can be selected as a standard option.

Note 2) Only polyurethane tubing is applicable for ø2.

Note 3) Universal type is not available.

Specifications

Proof pressure	1.5 MPa
Max. operating pressure	1 MPa
Min. operating pressure	0.1 MPa
Ambient and fluid temperature	-5 to 60°C (No freezing)
Applicable tubing material	Polyurethane (Note 1)
Option (Note 2)	With seal
Grease	Fluorine grease
Cleanliness class (ISO class)	Class 5

Note 1) Use caution at the max. operating pressure when using polyurethane tubing. (Refer to the **WEB catalog** for details.)
 Note 2) M5 type port is not available with seal.

Flow Rate and Sonic Conductance

Model	10-AS12□1F-M5□ 10-AS13□1F-M5□		10-AS22□1F-□01 10-AS23□1F-□01		10-AS22□1F-□02 10-AS23□1F-□02			10-AS32□1F 10-AS33□1F			10-AS42□1F 10-AS43□1F	
	Metric size	ø2 ø3.2 ø4 ø6	ø3.2 ø4	ø4 ø6 ø8 ø10	ø3.2 ø4	ø6 ø8 ø10	ø3.2 ø4 ø6 ø8 ø10	ø6 ø8 ø10	ø6 ø8 ø10 ø12	ø10 ø12	ø10 ø16	ø10 ø12
Tubing O.D.	Inch size	— ø1/8" ø1/4" ø5/32"	ø1/8"	ø5/32" ø1/4" ø5/16"	ø1/8"	ø5/32"	— ø1/4" ø5/16" ø3/8"	ø1/4"	ø5/16"	ø3/8"	ø3/8"	ø1/2"
	C values: Sonic conductance (dm ³ /(s·bar))	Free flow Controlled flow	0.2 0.3 0.2 0.3	0.4 0.6 0.4 0.7	0.6 0.8 0.6 0.9	0.7 1.0 1.3 1.5	1.6 2.1 2.4 3.3	1.7 2.5 4.4 4.8	1.6 2.1 2.4 3.3	1.7 2.5 4.4 4.8	2.5 4.4 4.8	4.4 4.8
b values: Critical pressure ratio	Free flow	0.3 0.4	0.2 0.3	0.3 0.3	0.3 0.4	0.4 0.4	0.4 0.3	0.3 0.3				
	Controlled flow	0.2	0.2 0.3	0.3 0.3	0.3 0.3	0.3 0.3	0.3 0.3					

Note 1) 10-32UNF has the same specification as M5.
 Note 2) C and b values are for controlled flow with the needle fully open and free flow with the needle fully closed.

Needle Valve/Flow Rate Characteristics

10-AS1201F-M5□, 10-AS1211F-M5□
 10-AS1301F-M5□, 10-AS1311F-M5□

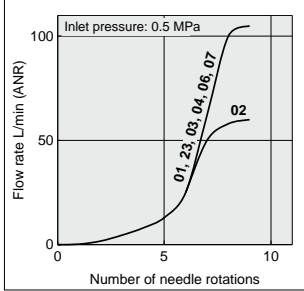

Note) -U10/32 has the same specification as M5.

10-AS2201F-01, 10-AS2211F-01
 10-AS2301F-01, 10-AS2311F-01

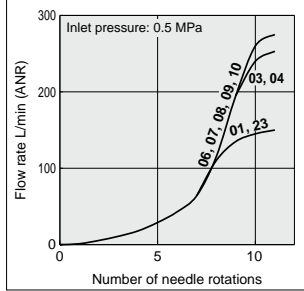

10-AS2201F-02, 10-AS2211F-02
 10-AS2301F-02, 10-AS2311F-02

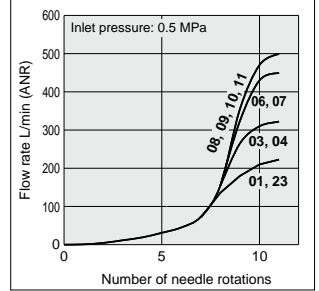

10-AS3201F, 10-AS3211F
 10-AS3301F, 10-AS3311F

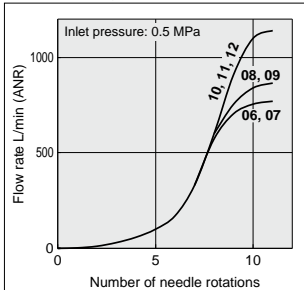

10-AS4201F, 10-AS4211F
 10-AS4301F, 10-AS4311F

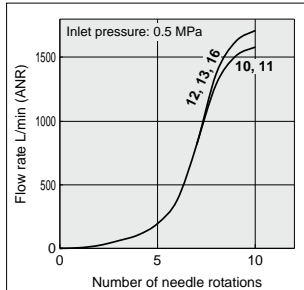

Note) The numbers above the flow rate characteristic curves in the charts show the applicable tubing outside diameter as defined by the product number.

Directional Control Valves
 Air Cylinders
 Rotary Actuators
 Air Grippers
 Air Preparation Equipment
 Modular F. R.
 Pressure Control Equipment
 Fittings & Tubing
 Flow Control Equipment
 Pressure Switches/ Pressure Sensors

Dimensions/ **Elbow type**

Seal method: Gasket seal
For M5, 10-32UNF

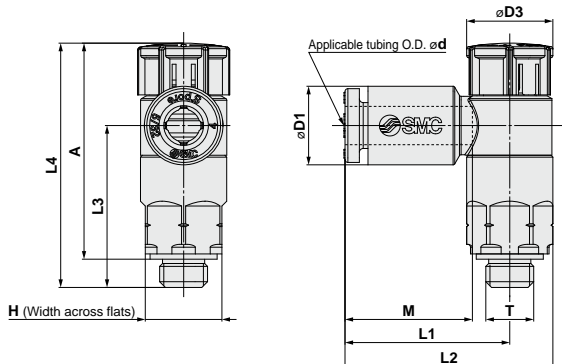

Metric Size

Model	d	T	H	D1	D3	L1	L2	L3	L4 Note 1)		A Note 2)		M	Weight [g]
									Unlocked	Locked	Unlocked	Locked		
10-AS12□1F-M5E-02A	2	M5 x 0.8 10/32UNF	8	5.8	9.4	15.8	20.3	16.9	26.5	25.4	23.5	22.4	11.9	5
10-AS12□1F-U10/32E-02A				7.2										
10-AS12□1F-M5E-23A	3.2			8.2		17.2	21.7	16.5					13.3	
10-AS12□1F-M5E-04A				8.2										
10-AS12□1F-U10/32E-04A	4			18.6		23.1	16.5	6						
10-AS12□1F-M5E-06A	6			11.2		18.6	23.1	16.5					6	
10-AS12□1F-U10/32E-06A		11.2	18.6	23.1	16.5	6								

Note 1) Reference dimensions

Note 2) Reference dimensions of threads after installation

Inch Size

Model	d	T	H	D1	D3	L1	L2	L3	L4 Note 1)		A Note 2)		M	Weight [g]
									Unlocked	Locked	Unlocked	Locked		
10-AS12□1F-M5E-01A	1/8"	M5 x 0.8 10/32UNF	8	7.2	9.4	17.2	21.7	16.9	26.5	25.4	23.5	22.4	13.3	5
10-AS12□1F-U10/32E-01A				8.2										
10-AS12□1F-M5E-03A	5/32"			11.2		18.6	23.1	16.5					6	
10-AS12□1F-U10/32E-03A				11.2										
10-AS12□1F-M5E-07A	1/4"			11.2		18.6	23.1	16.5					6	
10-AS12□1F-U10/32E-07A				11.2		18.6	23.1	16.5					6	

Note 1) Reference dimensions

Note 2) Reference dimensions of threads after installation

Dimensions/ Universal type

Seal method: Gasket seal
For M5, 10-32UNF

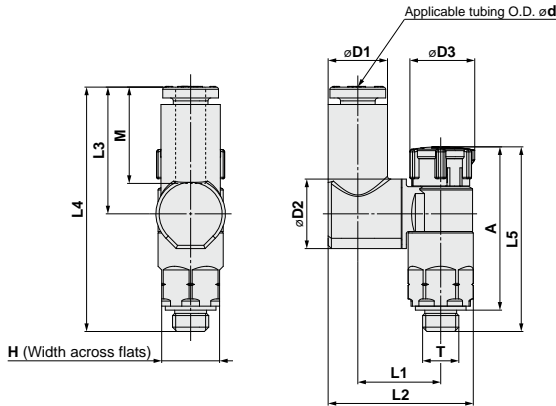

Metric Size

Model	d	T	H	D1	D2	D3	L1	L2	L3	L4	L5 Note 1)		A Note 2)		M	Weight [g]
											Unlocked	Locked	Unlocked	Locked		
10-AS13□1F-M5E-23A	3.2	M5 x 0.8 10/32UNF	8	7.2	9.6	9.4	11.6	19.4	17.5	33.8	26.5	25.4	23.5	22.4	13.3	6
10-AS13□1F-U10/32E-23A																
10-AS13□1F-M5E-04A	4			8.2			11.5	19.8								
10-AS13□1F-U10/32E-04A																
10-AS13□1F-M5E-06A	6	10.4	20.9	20.4	36.6											
10-AS13□1F-U10/32E-06A																

Note 1) Reference dimensions
Note 2) Reference dimensions of threads after installation

Inch Size

Model	d	T	H	D1	D2	D3	L1	L2	L3	L4	L5 Note 1)		A Note 2)		M	Weight [g]
											Unlocked	Locked	Unlocked	Locked		
10-AS13□1F-M5E-01A	1/8"	M5 x 0.8 10/32UNF	8	7.2	9.6	9.4	11.6	19.4	17.5	33.8	26.5	25.4	23.5	22.4	13.3	6
10-AS13□1F-U10/32E-01A																
10-AS13□1F-M5E-03A	5/32"			8.2			11.5	19.8								
10-AS13□1F-U10/32E-03A																
10-AS13□1F-M5E-07A	1/4"	11.2	21.3	20.2	36.5											
10-AS13□1F-U10/32E-07A																

Note 1) Reference dimensions
Note 2) Reference dimensions of threads after installation

- Directional Control Valves
- Air Cylinders
- Rotary Actuators
- Air Grippers
- Air Preparation Equipment
- Modular F. R.
- Pressure Control Equipment
- Fittings & Tubing
- Flow Control Equipment
- Pressure Switches/ Pressure Sensors

Dimensions/ Elbow type

Seal method: Sealant
For R, NPT thread

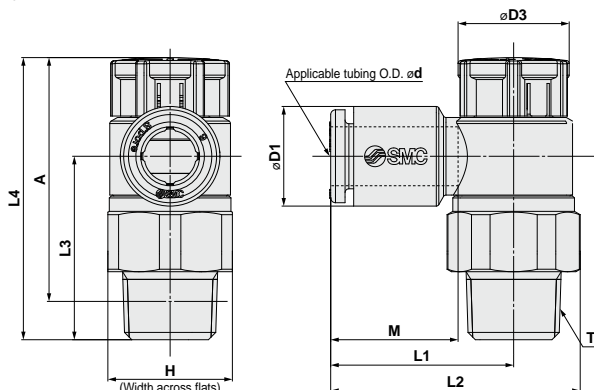

Metric Size

Model	d	T	H	D1	D3	L1	L2	L3	L4 Note 1)		A Note 2)		M	Weight [g]
									Unlocked	Locked	Unlocked	Locked		
10-AS22□1F-01-23(S)A	3.2	1/8	13 (12.7)	7.2	12	19.1	26.2	19.1	30.6	29.2	27.5	26.1	13.3	9 (9)
10-AS22□1F-01-04(S)A	4			8.2										10 (9)
10-AS22□1F-01-06(S)A	6			10.4										11 (10)
10-AS22□1F-01-08(S)A	8			13.2										12 (11)
10-AS22□1F-01-10(S)A	10	15.9	15.6	12 (11)										
10-AS22□1F-02-23(S)A	3.2	1/4	17 (17.5)	7.2	13	20.9	30.2 (30.3)	22.6	36.6	35	31.1	29.5	13.3	18 (19)
10-AS22□1F-02-04(S)A	4			8.2										18 (19)
10-AS22□1F-02-06(S)A	6			10.4										19 (20)
10-AS22□1F-02-08(S)A	8			13.2										20 (21)
10-AS22□1F-02-10(S)A	10	15.9	21 (22)											
10-AS32□1F-02-06(S)A	6	1/4	19	10.4	16.6	21.8	32.1	36.4	50	48.4	44.5	42.9	13.3	40 (40)
10-AS32□1F-02-08(S)A	8			13.2										41 (41)
10-AS32□1F-02-10(S)A	10			15.9										42 (42)
10-AS32□1F-02-12(S)A	12			18.5										43 (43)
10-AS32□1F-03-06(S)A	6	3/8	19	10.4	16.6	21.8	32.1	28.7	42.3	40.7	37.1	35.5	13.3	31 (32)
10-AS32□1F-03-08(S)A	8			13.2										32 (33)
10-AS32□1F-03-10(S)A	10			15.9										33 (33)
10-AS32□1F-03-12(S)A	12			18.5										34 (35)
10-AS42□1F-04-10(S)A	10	1/2	24 (23.8)	15.9	18.8	27.4	40.3 (40.2)	36.2	50.8	49.2	43.7	42.1	15.6	54 (53)
10-AS42□1F-04-12(S)A	12			18.5										55 (55)
10-AS42□1F-04-14(S)A	14			21.8										56 (56)
10-AS42□1F-04-16(S)A	16			24.4										60 (59)

Note 1) Reference dimensions Note 2) Reference dimensions of threads after installation Note 3) The values in () are for NPT thread.

Inch Size

Model	d	T	H	D1	D3	L1	L2	L3	L4 Note 1)		A Note 2)		M	Weight [g]
									Unlocked	Locked	Unlocked	Locked		
10-AS22□1F-01-01(S)A	1/8"	1/8	13 (12.7)	7.2	12	19.1	26.2	19.1	30.6	29.2	27.5	26.1	13.3	9 (9)
10-AS22□1F-01-03(S)A	5/32"			8.2										10 (9)
10-AS22□1F-01-07(S)A	1/4"			11.2										11 (10)
10-AS22□1F-01-09(S)A	5/16"			13.2										12 (11)
10-AS22□1F-02-01(S)A	1/8"	1/4	17 (17.5)	7.2	13	20.9	30.2 (30.3)	22.6	36.6	35	31.1	29.5	13.3	18 (19)
10-AS22□1F-02-03(S)A	5/32"			8.2										19 (19)
10-AS22□1F-02-07(S)A	1/4"			11.2										20 (20)
10-AS22□1F-02-09(S)A	5/16"			13.2										21 (21)
10-AS22□1F-02-11(S)A	3/8"	15.5	22 (22)											
10-AS32□1F-02-07(S)A	1/4"	1/4	19	11.2	16.6	21.8	32.1	36.4	50	48.4	44.5	42.9	13.3	40 (40)
10-AS32□1F-02-09(S)A	5/16"			13.2										41 (41)
10-AS32□1F-02-11(S)A	3/8"			15.5										42 (42)
10-AS32□1F-03-07(S)A	1/4"			11.2										43 (43)
10-AS32□1F-03-09(S)A	5/16"	3/8	19	13.2	16.6	22.7	33	28.7	42.3	40.7	37.1	35.5	13.3	31 (32)
10-AS32□1F-03-11(S)A	3/8"			15.5										32 (33)
10-AS42□1F-04-11(S)A	3/8"			17.8										33 (33)
10-AS42□1F-04-13(S)A	1/2"			20.9										34 (35)
10-AS42□1F-04-13(S)A	1/2"	1/2	24 (23.8)	15.5	18.8	27.4	40.3 (40.2)	36.2	50.8	49.2	43.7	42.1	15.6	54 (53)
10-AS42□1F-04-13(S)A	3/8"			19.3										55 (55)
10-AS42□1F-04-13(S)A	1/2"			20.9		27.4	40.3 (40.2)	36.2	50.8	49.2	43.7	42.1	15.6	56 (55)

Note 1) Reference dimensions Note 2) Reference dimensions of threads after installation Note 3) The values in () are for NPT thread.

Dimensions/ Universal type

Seal method: Sealant
For R, NPT thread

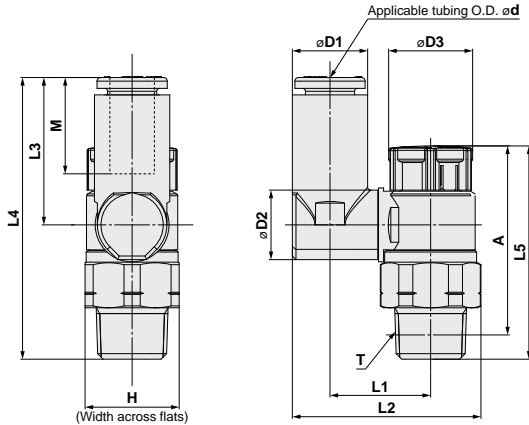

Metric Size

Model	d	T	H	D1	D2	D3	L1	L2	L3	L4	L5 Note 1)		A Note 2)		M	[mm]	
											Unlocked	Locked	Unlocked	Locked		Weight [g]	
10-AS23□1F-01-23(S)A	3.2	1/8	13 (12.7)	7.2	9.6	12	13.3	24	17.5	36	30.6	29.2	27.5	26.1	13.3	10 (10)	
10-AS23□1F-01-04(S)A	4			8.2			13.9	25.1								14.2	12 (12)
10-AS23□1F-01-06(S)A	6			10.4	16.4		26.2	20.4	38.8	11 (10)							
10-AS23□1F-01-08(S)A	8	1/4	17 (17.5)	13.2	10.2	13	16.4	30.1	21.5	40	36.6	35	31.1	29.5	13.3	19 (20)	
10-AS23□1F-02-04(S)A	4			8.2			19	33.8 (33.9)								21.4	43.9
10-AS23□1F-02-06(S)A	6			11.2	20.9		34.9 (35)	23.5	46	14.2						22 (22)	
10-AS23□1F-02-08(S)A	8	1/4	19	15.9	17.4	16.6	20.2	36	21.4	57.8	50	48.4	44.5	42.9	13.3	23 (24)	
10-AS23□1F-02-10(S)A	10			11.2			23	37.1								23.5	59.9
10-AS23□1F-02-06(S)A	6			15.9	20.2		41.2	26.1	62.5	15.6						46 (46)	
10-AS23□1F-02-08(S)A	8	1/4	19	18.5	17.4	16.6	23	42.5	28.3	64.7	42.3	40.7	37.1	35.5	13.3	48 (48)	
10-AS23□1F-02-12(S)A	12			18.5			23	42.5								26.1	54.8
10-AS23□1F-03-06(S)A	6			11.2	20.2		36	21.4	50.1	13.3						34 (35)	
10-AS23□1F-03-08(S)A	8	3/8	19	13.2	12.9	16.6	20.2	37.1	23.5	52.2	42.3	40.7	37.1	35.5	13.3	42 (42)	
10-AS23□1F-03-10(S)A	10			15.9			23	41.2								26.1	54.8
10-AS23□1F-03-12(S)A	12			18.5	23		42.5	28.3	57	15.6						38 (39)	
10-AS23□1F-04-10(S)A	10	1/2	24 (23.8)	15.9	17.4	18.8	25.6	46.4 (46.3)	26.1	61.2	50.8	49.2	43.7	42.1	15.6	61 (61)	
10-AS43□1F-04-13(S)A	12			18.5			26.2	48.3 (48.2)								28.3	63.4

Note 1) Reference dimensions Note 2) Reference dimensions of threads after installation Note 3) The values in () are for NPT thread.

Inch Size

Model	d	T	H	D1	D2	D3	L1	L2	L3	L4	L5 Note 1)		A Note 2)		M	[mm]	
											Unlocked	Locked	Unlocked	Locked		Weight [g]	
10-AS23□1F-01-01(S)A	1/8"	1/8	13 (12.7)	7.2	9.6	12	13.3	24	17.5	36	30.6	29.2	27.5	26.1	13.3	10 (10)	
10-AS23□1F-01-03(S)A	5/32"			8.2			13.9	25.1								14.2	12 (12)
10-AS23□1F-01-07(S)A	1/4"			11.2	16.4		29.1	20.2	38.7	11 (10)							
10-AS23□1F-01-09(S)A	5/16"	1/4	17 (17.5)	13.2	10.2	13	16.4	30.1	21.5	40	36.6	35	31.1	29.5	13.3	19 (20)	
10-AS23□1F-02-03(S)A	5/32"			8.2			19	33.8 (33.9)								21.4	43.9
10-AS23□1F-02-07(S)A	1/4"			11.2	20.9		34.9 (35)	23.5	46	14.2						22 (22)	
10-AS23□1F-02-09(S)A	5/16"	1/4	17 (17.5)	15.9	12.9	16.6	20.2	36	21.4	47.3	50	48.4	44.5	42.9	13.3	23 (24)	
10-AS23□1F-02-11(S)A	3/8"			11.2			23	37.1								23.5	57.8
10-AS23□1F-02-07(S)A	1/4"			13.2	20.2		41.2	26.1	62.5	15.6						46 (46)	
10-AS23□1F-02-09(S)A	5/16"	3/8	19	15.9	17.4	16.6	23	42.5	28.3	64.7	42.3	40.7	37.1	35.5	13.3	48 (48)	
10-AS23□1F-03-09(S)A	5/16"			11.2			23	41.2								26.1	54.8
10-AS23□1F-03-11(S)A	3/8"			13.2	23		42.5	28.3	57	15.6						38 (39)	
10-AS43□1F-04-11(S)A	3/8"	1/2	24 (23.8)	15.9	17.4	18.8	25.6	46.4 (46.3)	26.1	61.2	50.8	49.2	43.7	42.1	15.6	61 (61)	
10-AS43□1F-04-13(S)A	1/2"			18.5			26.2	48.3 (48.2)								28.3	63.4

Note 1) Reference dimensions Note 2) Reference dimensions of threads after installation Note 3) The values in () are for NPT thread.

Directional Control Valves
Air Cylinders
Rotary Actuators
Air Grippers
Air Preparation Equipment
Modular F. R.
Pressure Control Equipment
Fittings & Tubing
Flow Control Equipment
Pressure Switches/ Pressure Sensors

Series 10-AS-FS

Push-lock Type

RoHS

Speed Controller with Indicator
Elbow Type

How to Order



Applicable tubing O.D. (Note 1)

Metric size		Inch size	
02	ø2	01	ø1/8"
23	ø3.2 (Note 2)	03	ø5/32"
04	ø4	07	ø1/4"
06	ø6		

Note 1) For selecting applicable tubing O.D., refer to the "Model" on the table below. Metric size and inch size types can be visually identified by color of the release button.

Metric size: Light gray
Inch size: Orange

Note 2) Use ø1/8" tube.

Width across flats (H)

E	8 mm
Nil	9 mm

Port size

M5	M5 x 0.8
U10/32	10-32UNF

Body size

1	M5 x 0.8 10-32UNF
---	----------------------

Body size 1

10 - AS 1 2 0 1 F S [] - M5 E - 06

Body size 2/3/4

10 - AS 2 2 0 1 F S [] - [] 01 - 06 S

Clean series

Body size

2	1/8, 1/4
3	3/8
4	1/2

Type

2	Elbow
---	-------

Control type (Note)

0	Meter-out
1	Meter-in

Note) Meter-out and meter-in types can be visually identified by color of the handle.

Meter-out: Gray
Meter-in: Light blue

With indicator

Indicator direction

Nil	0°	
1	180°	

Note) Orientation of indicator direction is fixed when manufacturing, and cannot be changed by the user.

Seal method

Nil	Without sealant
S	With sealant

Applicable tubing O.D. (Note 1)

Metric size		Inch size	
23	ø3.2 (Note 2)	01	ø1/8"
04	ø4	03	ø5/32"
06	ø6	07	ø1/4"
08	ø8	09	ø5/16"
10	ø10	11	ø3/8"
12	ø12	13	ø1/2"
16	ø16		

Note 1) For selecting applicable tubing O.D., refer to the "Model" on the table below.

Note 2) Use ø1/8" tube.

Port size

01	1/8
02	1/4
03	3/8
04	1/2

Thread type

Nil	R
N	NPT

Model

Model	Port size	Seal method	Applicable tubing O.D.											Note 3) Max. number of rotations				
			Metric size						Inch size									
			2 (Note 2)	3.2	4	6	8	10	12	16	1/8"	5/32"	1/4"		5/16"	3/8"	1/2"	
10-AS12□1FS□-M5□	M5 x 0.8	Gasket seal	●	●	●	●							●	●	●			8
10-AS12□1FS□-U10/32□	10-32UNF		●	●	●								●	●	●			
10-AS22□1FS□-□01	R NPT	Sealant (Note 1)		●	●	●	●	●					●	●	●	●		10
10-AS22□1FS□-□02			1/8		●	●	●	●	●					●	●	●	●	
10-AS32□1FS□-□02			1/4		●	●	●	●	●					●	●	●	●	
10-AS32□1FS□-□03			3/8				●	●	●	●					●	●	●	
10-AS42□1FS□-□04			1/2						●	●	●					●	●	

Note 1) "Without sealant" type can be selected as a standard option.

Note 2) Only polyurethane tubing is applicable for ø2.

Note 3) There are differences in actual rate as by the indicator window over the maximum number of rotations depending on the individual product.

Specifications

Proof pressure	1.5 MPa
Max. operating pressure	1 MPa
Min. operating pressure	0.1 MPa
Ambient and fluid temperature	-5 to 60°C (No freezing)
Applicable tubing material	Polyurethane ^{Note 1)}
Option ^{Note 2)}	With seal
Grease	Fluorine grease
Cleanliness class (ISO class)	Class 5

Note 1) Use caution at the max. operating pressure when using polyurethane tubing. (Refer to the **WEB catalog** for details.)

Note 2) M5 type port is not available with seal.

Flow Rate and Sonic Conductance

Model	10-AS12□1FS-M5□			10-AS22□1FS-01			10-AS22□1FS-02				10-AS32□1FS			10-AS42□1FS	
	Metric size	ø2	ø3.2 ø4 ø6	ø3.2	ø4	ø6 ø8 ø10	ø3.2	ø4	ø6	ø8 ø10	ø6	ø8	ø10 ø12	ø10	ø12 ø16
Tubing O.D.	Inch size	—	ø1/8" ø1/4" ø5/32"	ø1/8"	ø5/32"	ø1/4" ø5/16"	ø1/8"	ø5/32"	—	ø1/4" ø5/16" ø3/8"	ø1/4"	ø5/16"	ø3/8"	ø3/8"	ø1/2"
	C values: Sonic conductance dm ³ /(s·bar)	Free flow	0.2	0.3	0.4	0.6	0.6	0.7	1.0	1.3	1.5	1.6	1.7	2.5	4.4
Controlled flow		0.2	0.3	0.4	0.7	0.8	0.6	0.9	—	1.3	2.1	2.4	3.3	4.4	4.9
b values: Critical pressure ratio	Free flow	0.3	0.4	—	0.2	0.3	0.3	—	0.4	—	0.4	0.3	—	0.3	—
	Controlled flow	—	0.2	—	0.2	0.3	—	0.3	—	—	0.3	—	—	0.3	—

Note 1) 10-32UNF has the same specification as M5.

Note 2) C and b values are for controlled flow with the needle fully open and free flow with the needle fully closed.

Needle Valve/Flow Rate Characteristics

10-AS1201FS□-M5□, 10-AS1211FS□-M5□

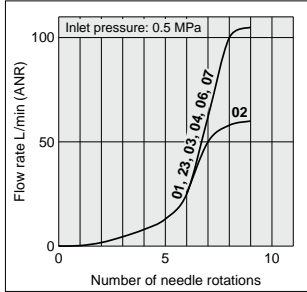

Note) -U10/32 has the same specification as M5.

10-AS2201FS□-01, 10-AS2211FS□-01

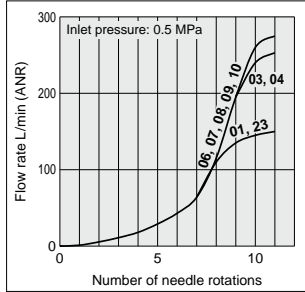

10-AS2201FS□-02, 10-AS2211FS□-02

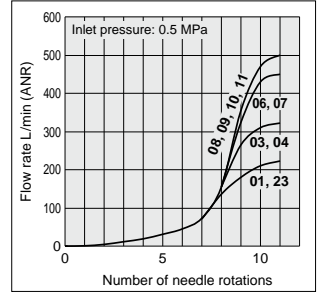

10-AS3201FS□, 10-AS3211FS□

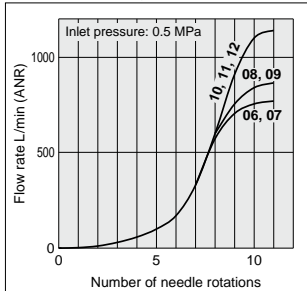

10-AS4201FS□, 10-AS4211FS□

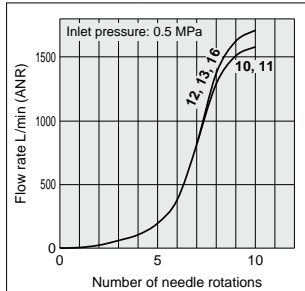

Note) The numbers above the flow rate characteristic curves in the charts show the applicable tubing outside diameter as defined by the product number.

Directional Control Valves
Air Cylinders
Rotary Actuators
Air Grippers
Air Preparation Equipment
Modular F. R.
Pressure Control Equipment
Fittings & Tubing
Flow Control Equipment
Pressure Switches/Pressure Sensors

Dimensions

Seal method: Gasket seal
For M5, 10-32UNF

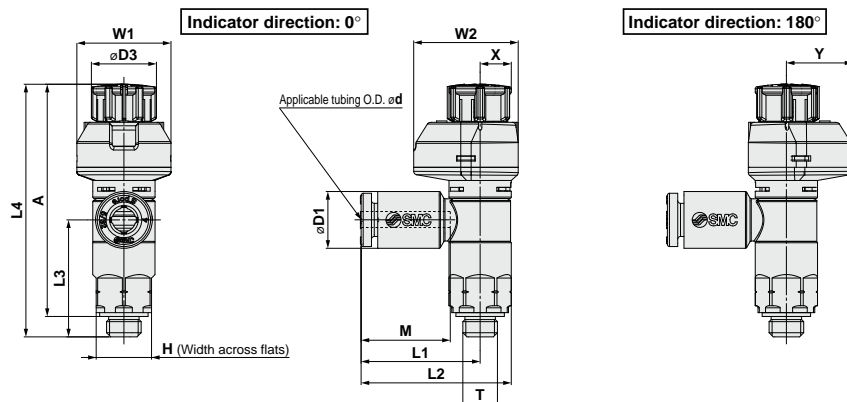

Metric Size

Model	d	T	H	D1	D3	L1	L2	L3	L4 Note 1)		A Note 2)		M	W1	W2	X	Y	Weight (g)
									Unlocked	Locked	Unlocked	Locked						
10-AS12□1FS□-M5E-02	2	M5 x 0.8 10/32UNF	8	5.8	15.8	20.3	16.9	39	36.5	35	33.5	11.9	13.6	15.1	5.5	9.6	7	
10-AS12□1FS□-U10/32E-02				7.2														
10-AS12□1FS□-M5E-23	3.2			9.4	17.2	21.7	16.5	13.3	8									
10-AS12□1FS□-U10/32E-23				8.2														
10-AS12□1FS□-M5E-04	4			10.4	18.6	23.1	16.5	8										
10-AS12□1FS□-U10/32E-04	6			10.4	18.6	23.1	16.5	8										
10-AS12□1FS□-M5E-06		10.4	18.6	23.1	16.5	8												
10-AS12□1FS□-U10/32E-06	6	10.4	18.6	23.1	16.5	8												

Note 1) Reference dimensions

Note 2) Reference dimensions of threads after installation

Inch Size

Model	d	T	H	D1	D3	L1	L2	L3	L4 Note 1)		A Note 2)		M	W1	W2	X	Y	Weight (g)
									Unlocked	Locked	Unlocked	Locked						
10-AS12□1FS□-M5E-01	1/8"	M5 x 0.8 10/32UNF	8	7.2	9.4	17.2	21.7	16.9	39.0	36.5	35	33.5	13.3	13.6	15.1	5.5	9.6	7
10-AS12□1FS□-U10/32E-01				8.2														
10-AS12□1FS□-M5E-03	5/32"			11.2	18.6	23.1	16.5	8										
10-AS12□1FS□-U10/32E-03				11.2	18.6	23.1	16.5	8										
10-AS12□1FS□-M5E-07	1/4"			11.2	18.6	23.1	16.5	8										
10-AS12□1FS□-U10/32E-07				11.2	18.6	23.1	16.5	8										

Note 1) Reference dimensions

Note 2) Reference dimensions of threads after installation



Dimensions

Seal method: Sealant
For R, NPT thread

Indicator direction: 0°

Indicator direction: 180°

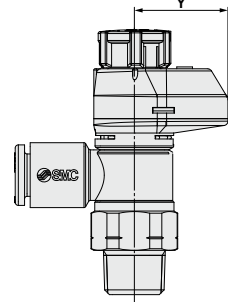
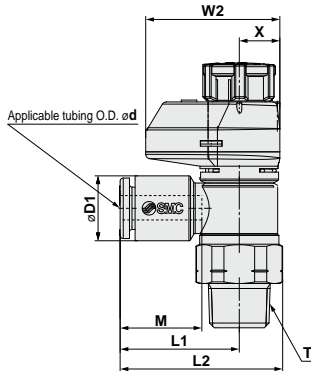
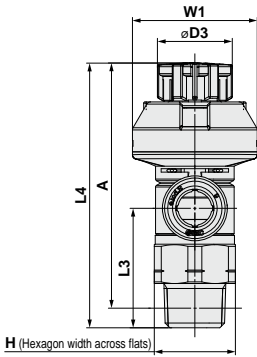

Metric Size

Model	d	T (R, NPT)	H	D1	D3	L1	L2	L3	L4 Note 1)		A Note 2)		M	W1	W2	X	Y	Weight (g)
									Unlocked	Locked	Unlocked	Locked						
10-AS22□1FS□-01-23(S)	3.2	1/8	13 (12.7)	7.2	12	19.1	26.1 (26)	19.1	43.9	42.4	40.8	39.3	13.3	20	21.5	6.5	15	13 (13)
10-AS22□1FS□-01-04(S)	4			8.2														14 (14)
10-AS22□1FS□-01-06(S)	6			10.4														15 (14)
10-AS22□1FS□-01-08(S)	8	13.2	22.4	29.4 (29.3)	16 (15)													
10-AS22□1FS□-01-10(S)	10	15.9	25.3	32.3 (32.2)														
10-AS22□1FS□-02-23(S)	3.2	1/4	17 (17.5)	7.2		13	20.9	30 (30.3)	22.6	49.7	48.3	44.2	42.8	13.3	21.5	24	7.8	16.2
10-AS22□1FS□-02-04(S)	4			8.2	24 (25)													
10-AS22□1FS□-02-06(S)	6			10.4	25 (26)													
10-AS22□1FS□-02-08(S)	8	13.2	23.9	33 (33.3)	25 (26)													
10-AS22□1FS□-02-10(S)	10	15.9	26.9	36 (36.3)														
10-AS32□1FS□-02-06(S)	6	10.4	21.8	32.1		36.4												
10-AS32□1FS□-02-08(S)	8	13.2	22.7	33														
10-AS32□1FS□-02-10(S)	10	15.9	26.7	37	35.7													
10-AS32□1FS□-02-12(S)	12	18.5	29.7	40	34.5	63.1	61.7	57.9	56.5	24.5	28.5	9.3	19.2	17	38 (39)			
10-AS32□1FS□-03-06(S)	6	10.4	21.8	32.1	28.7													
10-AS32□1FS□-03-08(S)	8	13.2	22.7	33	28.7													
10-AS32□1FS□-03-10(S)	10	15.9	26.7	37	28	55.4	54	50.2	48.8	24.5	28.5	9.3	19.2	17	29 (40)			
10-AS32□1FS□-03-12(S)	12	18.5	29.7	40	26.8													
10-AS42□1FS□-04-10(S)	10	15.9	27.4	40.3 (40.2)	36.2											64.1	62.5	57
10-AS42□1FS□-04-12(S)	12	18.5	30.8	43.7 (43.6)	35.1													
10-AS42□1FS□-04-16(S)	16	23.8	34.8	47.7 (47.6)	32.7													

Note 1) Reference dimensions Note 2) Reference dimensions of threads after installation Note 3) () are the dimensions of NPT thread.

Inch Size

Model	d	T (R, NPT)	H	D1	D3	L1	L2	L3	L4 Note 1)		A Note 2)		M	W1	W2	X	Y	Weight (g)
									Unlocked	Locked	Unlocked	Locked						
10-AS22□1FS□-01-01(S)	1/8"	1/8	13 (12.7)	7.2	12	19.1	26.1 (26)	19.1	43.8	42.4	40.7	39.3	13.3	20	21.5	6.5	15	13 (13)
10-AS22□1FS□-01-03(S)	5/32"			8.2														14 (13)
10-AS22□1FS□-01-07(S)	1/4"			11.2														20.8
10-AS22□1FS□-01-09(S)	5/16"	13.2	22.4	29.4 (29.3)	16 (15)													
10-AS22□1FS□-02-01(S)	1/8"	7.2	13	20.9		30 (30.3)	22.6	49.7	48.3	44.2	42.8	13.3	21.5	24	7.8	16.2	23 (24)	
10-AS22□1FS□-02-03(S)	5/32"	8.2																24 (24)
10-AS22□1FS□-02-07(S)	1/4"	11.2			23.4													32.5 (32.8)
10-AS22□1FS□-02-09(S)	5/16"	13.2	23.9	33 (33.3)	25 (26)													
10-AS22□1FS□-02-11(S)	3/8"	15.5	26.4	35.5 (35.8)														
10-AS32□1FS□-02-07(S)	1/4"	11.2	21.8	32.1		36.4												
10-AS32□1FS□-02-09(S)	5/16"	13.2	22.7	33														
10-AS32□1FS□-02-11(S)	3/8"	15.5	26.7	37	28.2													
10-AS32□1FS□-03-07(S)	1/4"	11.2	21.8	32.1	28.7	63.1	61.7	57.9	56.5	24.5	28.5	9.3	19.2	17	48 (49)			
10-AS32□1FS□-03-09(S)	5/16"	13.2	26.7	37														
10-AS32□1FS□-03-11(S)	3/8"	15.5	26.7	37														
10-AS32□1FS□-03-13(S)	7/16"	17.5	29.7	40	28.2	55.4	54	50.2	48.8	24.5	28.5	9.3	19.2	17	38 (39)			
10-AS42□1FS□-04-11(S)	3/8"	15.5	27.4	40.3 (40.2)	36.2													
10-AS42□1FS□-04-13(S)	1/2"	23.8	30.9	43.8 (43.7)	34.7													

Note 1) Reference dimensions Note 2) Reference dimensions of threads after installation Note 3) () are the dimensions of NPT thread.



Directional Control Valves
Air Cylinders
Rotary Actuators
Air Grippers
Air Preparation Equipment
Modular F. R.
Pressure Control Equipment
Fittings & Tubing
Flow Control Equipment
Pressure Switches/Pressure Sensors

Series 10-AS-F

Speed Controller with One-touch Fitting
(Elbow type/Universal type)

RoHS

How to Order

Clean series

Body size
 1 — M3, M5 standard
 2 — 1/8, 1/4 standard
 3 — 3/8 standard
 4 — 1/2 standard

Type
 2 — Elbow
 3 — Universal

Control type
 0 — Meter-out
 1 — Meter-in

With One-touch fittings

10 - AS 2 2 1 1 F - 01 - 06 (N) -

Port size
 M3 — M3 x 0.5
 M5 — M5 x 0.8
 01 — R1/8
 02 — R1/4
 03 — R3/8
 04 — R1/2

Applicable tubing O.D. (Note)
Metric size
 02 — ø2
 23 — ø3.2 *
 04 — ø4
 06 — ø6
 08 — ø8
 10 — ø10
 12 — ø12

Note) Refer to the following Model list for selection of applicable tubing O.D.
 * Use ø1/8" tubing.

Lock nut option
 Nil — Hexagon lock nut
 J — Round lock nut

Nickel plated specification
 Add "N" only for piping part size of R1/2.
 "N" is not necessary for M3, M5, R1/8, R1/4, and R3/8.

Option
 Nil — None
 S — With seal



Model

Elbow type	Universal type	Bore size	Applicable tubing O.D.							
			Metric size							
			2	3.2	4	6	8	10	12	
10-AS12□1F-M3	10-AS13□1F-M3	M3 x 0.5	● ^{Note 1)}	●	●	●	●	●	●	●
10-AS12□1F-M5	10-AS13□1F-M5	M5 x 0.8	● ^{Note 1)}	●	●	●	●	●	●	●
10-AS22□1F-01	10-AS23□1F-01	R1/8		●	●	●	●	●	● ^{Note 1)}	
10-AS22□1F-02	10-AS23□1F-02	R1/4			●	●	●	●	●	
10-AS32□1F-02	10-AS33□1F-02	R1/4				●	●	●	●	●
10-AS32□1F-03	10-AS33□1F-03	R3/8				●	●	●	●	●
10-AS42□1F-04	10-AS42□1F-04	R1/2					●	●	●	●

Note 1) Elbow type only

Note 2) Applicable tubing I.D. of 10-AS12□1F-M5-02 is 2.5, 4 and 6.

Note 3) Visual distinction between meter-out and meter-in types.

Meter-out and meter-in types can be visually differentiated by the lock nut.

The hexagon lock nut on the meter-out type is zinc chromated, while the meter-in type is black zinc chromated.

The round lock nut (J) on the meter-out type is electroless nickel plated, while the meter-in type is black zinc chromated.

Specifications

Proof pressure	1.5 MPa (1.05 MPa ^{Note 1)})
Max. operating pressure	1 MPa (0.7 MPa ^{Note 1)})
Min. operating pressure	0.1 MPa
Ambient and fluid temperature	-5 to 60 °C (No freezing)
Applicable tubing material	Polyurethane ^{Note 2)}
Option^{Note 3)}	With seal, round lock nut
Grease	Fluorine grease
Cleanliness class (ISO class)	Class 5

Note 1) 10-AS12□1F-M3-02 and 10-AS12□1F-M5-02 types

Note 2) The maximum operating pressure for polyurethane is 0.8 MPa (at 20°C). (Refer to the **WEB catalog** for details.)

Note 3) M3 and M5 type ports are not available with seal.

Flow Rate and Sonic Conductance

Model		10-AS12□1F-M3 10-AS13□1F-M3 10-AS12□1F-M5-02	10-AS12□1F-M5 10-AS13□1F-M5	10-AS22□1F-01 10-AS23□1F-01	10-AS22□1F-02 10-AS23□1F-02	10-AS32□1F 10-AS33□1F	10-AS42□1F 10-AS43□1F
Tubing O.D.	Metric size	ø2, ø3.2, ø4	ø3.2, ø4, ø6	ø3.2, ø4, ø6, ø8, ø10	ø4, ø6, ø8, ø10	ø6, ø8, ø10, ø12	ø10, ø12
Controlled flow	Flow rate L/min (ANR)	20	100	180 230	260 390 460	660 790 920	1580 1710
Free flow	Sonic conductance dm ³ /(s·bar)	0.06	0.28	0.5 0.64	0.72 1.1 1.3	1.8 2.2 2.6	4.4 4.8
Critical pressure ratio	Controlled flow	0.2	0.2	0.25	0.3	0.25	0.25
	Free flow	0.4	0.4	0.2	0.3	0.2	0.3

Note 1) Flow rate values are measured at 0.5 MPa and 20°C.

Note 2) U10/32 has the same specification as M5.

Needle Valve / Flow Rate Characteristics

10-AS1201F-M3, 10-AS1211F-M3
10-AS1201F-M5-02, 10-AS1211F-M5-02
10-AS1301F-M3, 10-AS1311F-M3

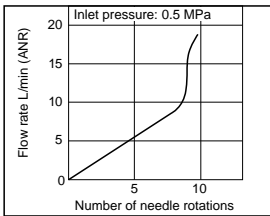

10-AS1201F-M5, 10-AS1211F-M5
10-AS1301F-M5, 10-AS1311F-M5

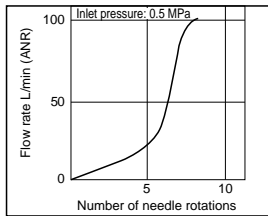

10-AS2201F-01, 10-AS2211F-01
10-AS2301F-01, 10-AS2311F-01

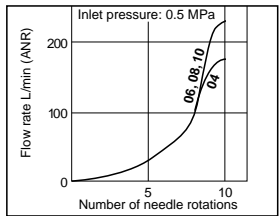

10-AS2201F-02, 10-AS2211F-02
10-AS2301F-02, 10-AS2311F-02

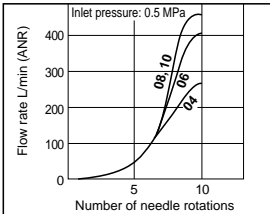

10-AS3201F, 10-AS3211F
10-AS3301F, 10-AS3311F

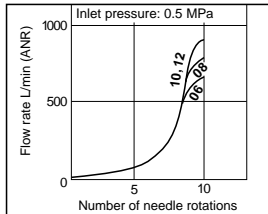

10-AS4201F, 10-AS4211F
10-AS4301F, 10-AS4311F

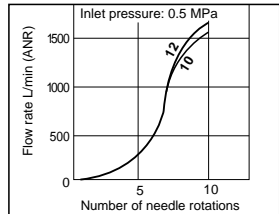

Directional Control Valves
 Air Cylinders
 Rotary Actuators
 Air Grippers
 Air Preparation Equipment
 Modular F. R.
 Pressure Control Equipment
 Fittings & Tubing
 Flow Control Equipment
 Pressure Switches/ Pressure Sensors

Elbow type

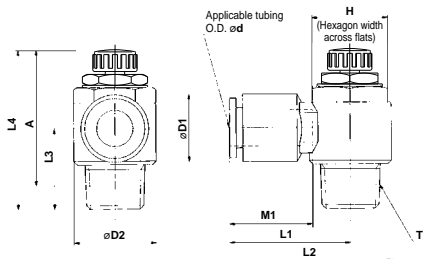

M3 port / M5 port

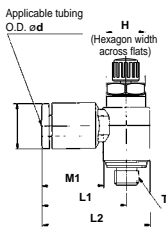
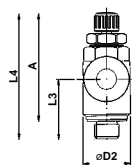

ø2 tubing type
10-AS12□1F-M3-02
10-AS12□1F-M5-02

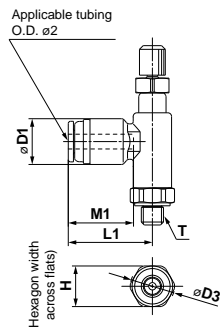
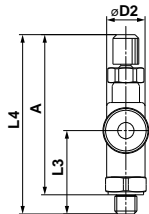

Model	Applicable tubing O.D. ød	T	H	D1	D2	D3	L1	L2	L3	L4		A*		M1	Weight (g)	
										MAX.	MIN.	MAX.	MIN.			
10-AS12□1F-M3-02	2	M3 x 0.5	5.5	6	5.2	6	11.4	—	11	26.8	24.3	24.3	21.8	8.8	2.4	
10-AS12□1F-M3-23	3.2			8.4	7.2	—	16.1	19.7	10.5	26.6	24.1	24	21.5	12.7	4	
10-AS12□1F-M3-04	4			9.3	—	—	—	—	10	—	—	—	—	—	—	—
10-AS12□1F-M5-02	2	M5 x 0.8	8	7	6	5.2	7.5	11.4	—	11.5	27.3	24.8	24.3	21.8	8.8	3
10-AS12□1F-M5-23	3.2			8.4	—	—	17.3	22.1	12.3	28.6	25.8	25	22.2	12.7	7	
10-AS12□1F-M5-04	4			9.3	9.6	—	—	—	18.1	22.9	11.7	—	—	—	13.5	—
10-AS12□1F-M5-06	6	R1/8	12	11.6	—	—	—	—	—	—	—	—	—	—	—	
10-AS22□1F-01-23	3.2			9.3	—	—	20.4	27.5	14.3	36.1	31.1	32.1	27.1	12.7	16	
10-AS22□1F-01-04	4			11.6	14.2	—	—	—	—	—	—	—	—	13.5	17	
10-AS22□1F-01-06	6	R1/4	17	15.2	—	—	25.3	32.4	—	—	—	—	—	18.5	19	
10-AS22□1F-01-10	8			18.5	—	—	33.1	40.2	15	—	—	—	—	21	21	
10-AS22□1F-02-04	4			10.4	—	—	25.2	34.4	—	—	—	—	—	16	32	
10-AS22□1F-02-06	6	R1/4	17	12.8	18.5	—	27.2	36.4	18.2	40.4	35.4	34.4	29.4	17	34	
10-AS22□1F-02-08	8			15.2	—	—	35.3	44.5	20	—	—	—	—	18.5	34	
10-AS22□1F-02-10	10			18.5	—	—	—	—	—	—	—	—	—	21	36	
10-AS32□1F-02-06	6	R1/4	19	12.8	23	—	27.8	39.3	—	—	—	—	—	17	60	
10-AS32□1F-02-08	8			15.2	—	—	29.5	41	21.8	48.8	43.8	42.8	37.8	18.5	63	
10-AS32□1F-02-10	10			18.5	—	—	31.8	43.3	—	—	—	—	—	21	67	
10-AS32□1F-02-12	12	R3/8	19	20.9	—	—	32.8	44.3	—	—	—	—	22	69		
10-AS32□1F-03-06	6			12.8	—	—	27.8	39.3	—	—	—	—	—	17	55	
10-AS32□1F-03-08	8			15.2	—	—	29.5	41	20.9	46.5	41.5	40.2	35.2	18.5	57	
10-AS32□1F-03-10	10	R3/8	19	18.5	—	—	31.8	43.3	—	—	—	—	21	59		
10-AS32□1F-03-12	12			20.9	—	—	32.8	44.3	—	—	—	—	—	22	61	
10-AS42□1F-04-10	10			R1/2	24	18.5	28.6	—	33.6	47.9	25.4	57.6	50.1	49.6	42.1	21
10-AS42□1F-04-12	12	21.7	—			—	34.6	48.9	—	—	—	—	—	22	101	

* Reference thread dimensions after installation.

Universal type

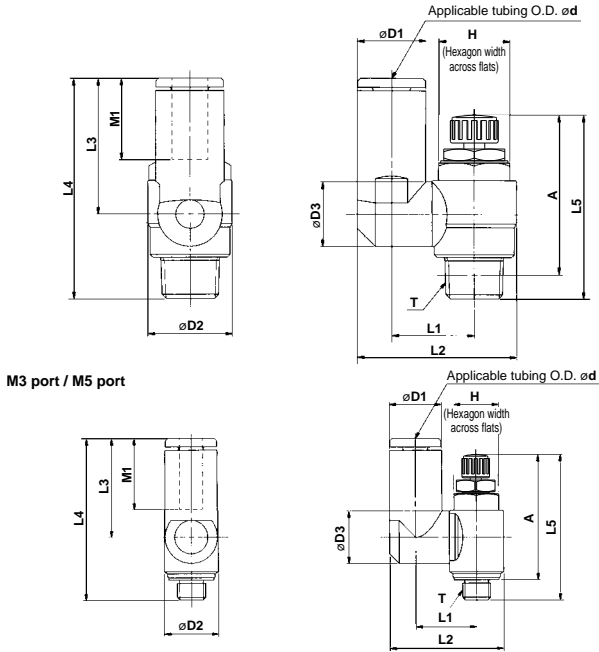

Model	Applicable tubing O.D. ød	T	H	D1	D2	D3	L1	L2	L3	L4	L5		A*		M1	Weight (g)	
											MAX.	MIN.	MAX.	MIN.			
10-AS13□1F-M3-23	3.2	M3 x 0.5	5.5	8.4	7.2	7.2	10.1	17.9	17.6	28.3	26.6	24.1	24	21.5	12.7	4	
10-AS13□1F-M3-04	4			9.3				18.3	17.9	28.6						5	
10-AS13□1F-M5-23	3.2			8.4				19.8	17.5	28.7						7	
10-AS13□1F-M5-04	4	M5 x 0.8	8	9.3	9.6	9.3	10.8	20.3	20.6	28.7	28.6	25.8	25	22.2	13.5	17	
10-AS23□1F-M5-06	6			11.6				21.4	20.6	18.5							
10-AS23□1F-M5-06	3.2			8.4				24.4	17.5	31.8						17	
10-AS23□1F-01-23	3.2	R1/8	12	9.3	14.2	10.9	14	26.9	22.9	37.2	36.1	31.1	32.1	27.1	13.5	21	
10-AS23□1F-01-04	4			11.6				30.9	28.2	41.7						18.5	
10-AS23□1F-01-06	6			15.2				16.2	26.9	22.9						37.2	18
10-AS23□1F-01-08	8	R1/4	17	10.4	18.5	10.9	16.2	30.6	21.9	40.1	40.4	35.4	34.4	29.4	16	32	
10-AS23□1F-02-04	4			12.8				34	25.2	42.6						17	
10-AS23□1F-02-06	6			15.2				18.3	35.2	28.2						45.6	33
10-AS23□1F-02-08	8	R1/4	17	18.5	12.9	10.9	20.2	38.7	31	48.4	48.8	43.8	42.8	37.8	18.5	36	
10-AS33□1F-02-06	6			12.8				20.6	38.5	25.2						47	60
10-AS33□1F-02-08	8			15.2				39.7	28.2	50						63	
10-AS33□1F-02-10	10	R1/4	19	18.5	16.2	23	43.7	32.6	54.4	54.4	46.5	41.5	40.2	35.2	21	67	
10-AS33□1F-02-12	12			20.9				44.9	34.4	56.2						69	
10-AS33□1F-03-06	6			12.8				20.6	38.5	25.2						46.1	56
10-AS33□1F-03-08	8	R3/8	19	15.2	12.9	20.6	39.7	28.2	49.1	49.1	46.5	41.5	40.2	35.2	17.5	59	
10-AS33□1F-03-10	10			18.5				43.7	32.6	53.5						63	
10-AS33□1F-03-12	12			20.9				44.9	34.4	55.3						65	
10-AS43□1F-04-10	10	R1/2	24	18.5	28.6	16.2	23	44.9	34.4	55.3	57.6	50.1	49.6	42.1	21	104	
10-AS43□1F-04-12	12			21.7				26.8	52	36.3						61.7	106

* Reference thread dimensions after installation.

Directional Control Valves
Air Cylinders
Rotary Actuators
Air Grippers
Air Preparation Equipment
Modular F. R.
Pressure Control Equipment
Fittings & Tubing
Flow Control Equipment
Pressure Switches/ Pressure Sensors

Series 10-AS

Speed Controller with One-touch Fitting (In-line type)

Series

Series	Applicable tube O.D.						
	Metric size						
	2	3.2	4	6	8	10	12
10-AS1002F	⊙	⊙	⊙	⊙			
10-AS2002F			⊙	⊙			
10-AS2052F				⊙	⊙		
10-AS3002F				⊙	⊙	⊙	⊙
10-AS4002F						⊙	⊙

Specifications

Fluid	Air
Proof pressure	1.5 MPa (1.05 MPa ^{Note 1)})
Max. operating pressure	1 MPa (0.7 MPa ^{Note 1)})
Min. operating pressure	0.1 MPa
Ambient and fluid temperature	-5 to 60°C (No freezing)
Applicable tube material	Polyurethane ^{Note 2)}
Option	Round lock nut
Grease	Fluorine grease
Cleanliness class (ISO class)	Class 5

Note 1) In case of 10-AS1002F-02

Note 2) The maximum operating pressure for polyurethane is 0.8 MPa (at 20°C).
(Refer to the **WEB catalog**.)

Note 3) Brass parts are all electroless nickel plated.

Flow Rate and Sonic Conductance

Tubing O.D.	Model	10-AS1002F						10-AS2002F		10-AS2052F		10-AS3002F		10-AS4002F	
		Metric size		⌀2	⌀3.2, ⌀4, ⌀6	⌀4	⌀6	⌀6	⌀8	⌀6	⌀8	⌀10, ⌀12	⌀10	⌀12	
Controlled flow	Flow rate L/min (ANR)	20	100	130	230	290	460	390	660	920	920	1390			
Free flow	Sonic conductance dm ³ /(s-bar)	0.06	0.28	0.36	0.64	0.81	1.3	1.1	1.8	2.6	2.6	3.9			
Critical pressure ratio	Controlled flow	0.2													
	Free flow	0.25													

Note) Flow rate values are measured at 0.5 MPa and 20°C.

How to Order

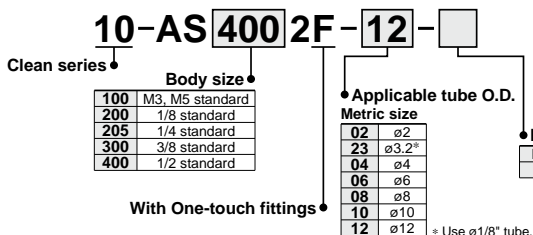

RoHS

Options

L-bracket

Part no.	Applicable series
AS-12L	10-AS1002F-02
AS-10L	10-AS1002F
AS-20L	10-AS2002F
AS-25L	10-AS2052F
AS-30L	10-AS3002F
AS-40L	10-AS4002F

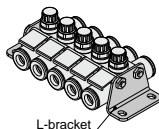

L-bracket

DIN rail mounting bracket

Part no.	Applicable series
AS-10D	10-AS1002F
AS-20D	10-AS2002F
AS-25D	10-AS2052F
AS-30D	10-AS3002F
AS-40D	10-AS4002F

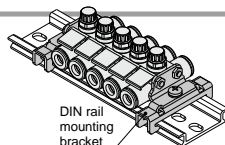

DIN rail mounting bracket

* Bracket for 10-AS1002F-02 is not available.

* Prepare DIN rail by user.

Part no. list of threaded stud kit for manifold

Model	4 stations	6 stations	8 stations	10 stations
Metric size				
10-AS1002F-02	AS-31B	AS-32B	AS-33B	AS-34B
10-AS1002F-23		AS-33B	AS-34B	AS-36B
10-AS1002F-04	AS-32B		AS-35B	
10-AS1002F-06		AS-34B	AS-36B	
10-AS2002F-04			AS-35B	AS-37B
10-AS2002F-06	AS-32B	AS-34B	AS-36B	
10-AS2052F-06				
10-AS2052F-08	AS-41B	AS-42B	AS-44B	AS-45B
10-AS3002F-06				
10-AS3002F-08	AS-42B	AS-44B	AS-45B	AS-47B
10-AS3002F-10			AS-46B	
10-AS3002F-12				
10-AS4002F-10				
10-AS4002F-12	AS-43B	AS-45B	AS-47B	AS-48B

Details of threaded stud kit for manifold

Part no.	Threaded stud		Accessories			
	Length	pcs.	Hexagon nut	Pcs.	Flat washer	Pcs.
AS-31B	38	2				
AS-32B	62	2				
AS-33B	72	2				
AS-34B	90	2				
AS-35B	104	2	M3	4	M3	4
AS-36B	114	2				
AS-37B	135	2				
AS-38B	140	2				
AS-41B	78	2				
AS-42B	111	2				
AS-43B	119	2				
AS-44B	147	2				
AS-45B	179	2	M4	4	M4	4
AS-46B	191	2				
AS-47B	236	2				
AS-48B	277	2				

* Precautions when options are ordered

Threaded studs for manifold are not included when L-bracket and DIN rail mounting bracket are ordered. Please order them according to the number of stations.

Ex.) 10-AS2002F-04	When connecting 4 pcs. and mounting L-brackets on both sides	
• Speed controller		10-AS2002F-044 pcs.
• L-bracket		AS-20L2 pcs.
• Threaded stud kit for manifold		AS-32B1 pc.

Needle Valve/Flow Rate Characteristics

10-AS1002F-02

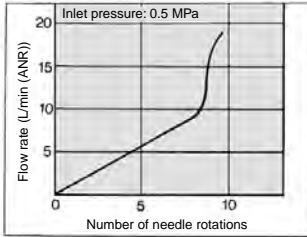

10-AS1002F

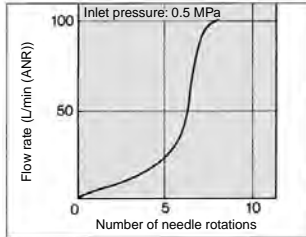

10-AS2002F

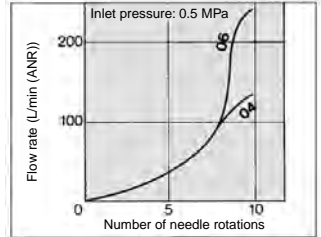

10-AS2052F

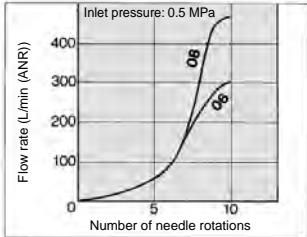

10-AS3002F

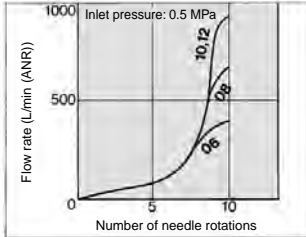

10-AS4002F

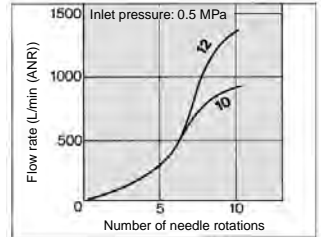

Construction

10-AS1002F, AS2002F, AS2052F

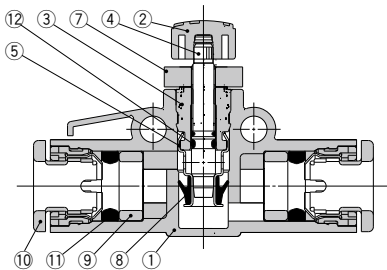

10-AS1002F-02, AS3002F, AS4002F

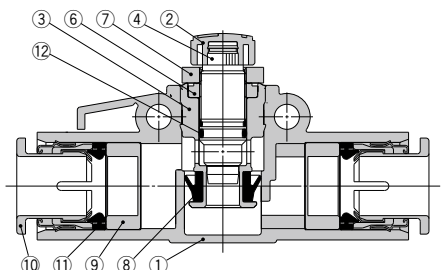

Component Parts

No.	Description	Material	Note
1	Body A	PBT	
2	Handle	PBT	
3	Body B	Brass	Electroless nickel plated
4	Needle	Brass	Electroless nickel plated
5	Seat ring	Brass	Electroless nickel plated
6	Needle guide	Brass	Electroless nickel plated

Note) AS2052F, AS3002F, AS4002F are made of PBT.

No.	Description	Material	Note
7	Lock nut	Steel wire	Zinc chromated
8	U-seal	HNBR	
9	Spacer	POM (Note)	
10	Cassette	—	
11	Seal	NBR	
12	O-ring	NBR	

L-bracket

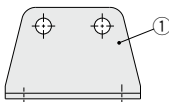

Component Part

No.	Description	Material
1	Bracket	Steel strip

DIN rail mounting bracket

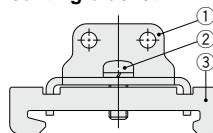

Component Parts

No.	Description	Material
1	Bracket	Steel strip
2	Cross recessed round head screw	Steel wire
3	Clasp	Steel strip

Caution

Be sure to read this before handling. Refer to page 1382 for Safety Instructions and pages 1305 to 1308 for Flow Control Equipment Precautions.

Directional Control Valves
Air Cylinders
Rotary Actuators
Air Grippers
Air Preparation Equipment
Modular F. R.
Pressure Control Equipment
Fittings & Tubing
Flow Control Equipment
Pressure Switches/Pressure Sensors

Dimensions

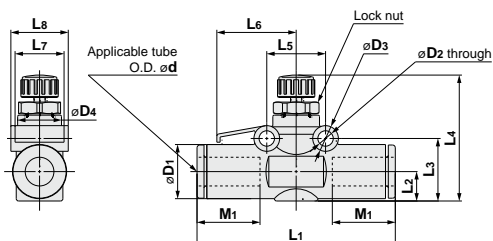

Metric Size

Model	Applicable tube O.D. ϕd	D1	D2	D3	D4	L1	L2	L3	L4 (Note)		L5	L6	L7	L8	M1	Weight (g)
									MAX.	MIN.						
10-AS1002F-02	2	6	3.2	5	6	25.4	3.4	7.9	20.9	18.4	11	9.8	5	6.7	8.8	3
10-AS1002F-23	3.2	8.4	3.3	5.5	9.1	36	4.4	11.1	23.8	21						
10-AS1002F-04	4	9.3				37	5.1	11.8	24.5	21.7	17	22.8	12	16.1	17	19
10-AS1002F-06	6	11.6	39.5	6.1	12.8	25.5	22.7	17	22.8	12						
10-AS2002F-04	4	9.3	40.7	5.2	12.3	28.9	25.4				17	22.8	12	16.1	17	19
10-AS2002F-06	6	11.6	42.5	6.3	13.4	30	26.5	17	22.8	12						
10-AS2052F-06	6	12.8	53.2	6.7	16.3	33.2	28.2				17	22.8	12	16.1	17	19
10-AS2052F-08	8	15.2	57.2	8	17.6	34.5	29.5	17	22.8	12						
10-AS3002F-06	6	13.2	59	7.4	19.3	38.6	33.6				17	22.8	12	16.1	17	19
10-AS3002F-08	8	15.2	65	8.2	20.1	39.4	34.4	17	22.8	12						
10-AS3002F-10	10	18.5	70.8	9.8	21.7	41	36				17	22.8	12	16.1	17	19
10-AS3002F-12	12	20.9	76	10.9	22.8	42.1	37.1	17	22.8	12						
10-AS4002F-10	10	18.5	76.9	10.3	22.7	51.6	44.1				17	22.8	12	16.1	17	19
10-AS4002F-12	12	21.7	81.3	11.3	23.7	52.6	45.1	17	22.8	12						

Note) Reference dimensions

The hexagon lock nut can be fastened by hand. When stronger tightening is required, please retighten using a tool. The recommended tightening torques for tools are shown in the table below. For standard installation, turn 15 to 30° using tool, after fastening by hand. Pay attention not to over torque the product.

Model	Recommended tightening torque (N·m)	Lock nut Hexagon width across flats
10-AS1002F-02	0.07	4.5
10-AS1002F	0.2	7
10-AS2002F	0.3	9
10-AS2052F	1	12
10-AS3002F	2	14
10-AS4002F	4	17

L-bracket

Bracket on a single side

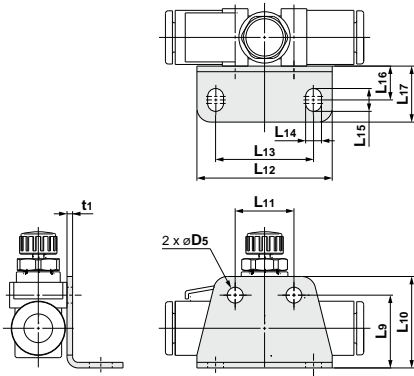

Part no.	Applicable series	D5	L9	L10	L11	L12	L13	L14	L15	L16	L17	t1
AS-12L	10-AS1002F-02		9.9	13.4	11	27.5	19.5					1
AS-10L	10-AS1002F	3.4	14.8	18.3				3.4	4.9	7.3	12	1.2
AS-20L	10-AS2002F		15.6	19.6	12.6	29	21					
AS-25L	10-AS2052F		19.6	24.6	17	38	28					1.4
AS-30L	10-AS3002F	4.5	24.8	29.8	22	43	33	4.5	6.5	9.5	15.5	
AS-40L	10-AS4002F		25.7	30.7	28	49	39					

Brackets on both sides

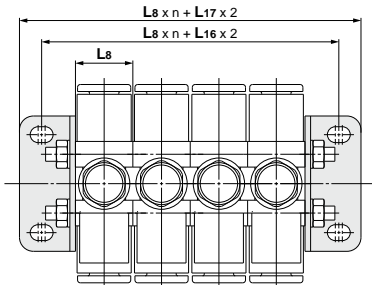

*1 Refer to page 1259 for L_s.
 *2 The above figure shows the manifold with controllers connected using two L-brackets and a threaded stud kit for manifold. Refer to page 1257 for threaded stud kits for manifold.

DIN rail mounting bracket

Bracket on a single side

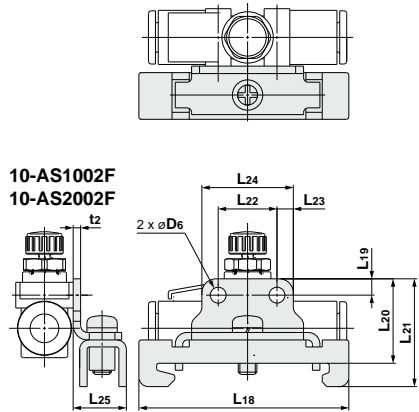

10-AS1002F
10-AS2002F

10-AS2052F
10-AS3002F
10-AS4002F

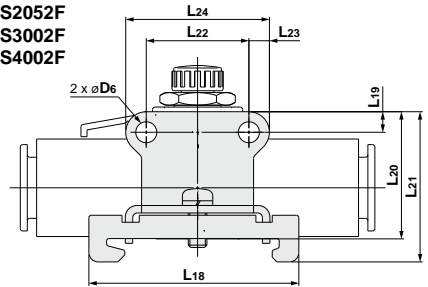

Part no.	Applicable series	D6	L18	L19	L20	L21	L22	L23	L24	L25	t2
AS-10D	10-AS1002F	3.4		3.5	18.2	23.2	11		3.5	18	
AS-20D	10-AS2002F			45	18.6	23.6	12.6			19.6	
AS-25D	10-AS2052F				22	27	17			25.8	
AS-30D	10-AS3002F	4.5	4.4		27.2	32.2	22	4.4		30.8	
AS-40D	10-AS4002F				28.1	33.1	28			36.8	

Brackets on both sides

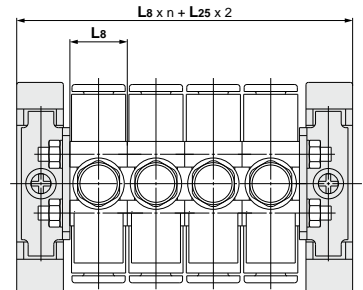

*1 Refer to page 1259 for L_s.
 *2 The above figure shows the manifold with controllers connected using two DIN rail mounting brackets and a threaded stud kit for manifold. Refer to page 1257 for threaded stud kits for manifold.

- Directional Control Valves
- Air Cylinders
- Rotary Actuators
- Air Grippers
- Air Preparation Equipment
- Modular F. R.
- Pressure Control Equipment
- Fittings & Tubing
- Flow Control Equipment
- Pressure Switches/ Pressure Sensors

Series 10-ASD

Dual Speed Controller with One-touch Fitting

How to Order



10 - ASD **3** **30** F - **01** - **06** S -

Clean series

Body size

2	M5 standard
3	1/8 standard
4	1/4 standard
5	3/8 standard
6	1/2 standard

Type

3	Universal
---	-----------

With One-touch fittings

Lock nut option

Nil	Hexagon lock nut
J	Round lock nut

With sealant

Applicable tubing O.D. (Note)

Metric size

04	ø4
06	ø6
08	ø8
10	ø10
12	ø12

Note) Refer to the following Model list for selection of applicable tubing O.D.

Port size

M5	M5 x 0.8
01	R1/8
02	R1/4
03	R3/8
04	R1/2



Model

Model	Port size	Applicable tubing O.D.				
		Metric size				
		ø4	ø6	ø8	ø10	ø12
10-ASD230F-M5	M5 x 0.8	●	●			
10-ASD330F-01	R1/8		●	●		
10-ASD430F-02	R1/4		●	●	●	
10-ASD530F-02	R1/4		●	●	●	●
10-ASD530F-03	R3/8		●	●	●	●
10-ASD630F-04	R1/2				●	●

Specifications

Proof pressure	1.5 MPa
Max. operating pressure	1 MPa
Min. operating pressure	0.1 MPa
Ambient and fluid temperature	-5 to 60°C (No freezing)
Applicable tubing material	Polyurethane ^{Note 1)}
Option	Round lock nut
Grease	Fluorine grease
Cleanliness class (ISO class)	Class 5

Note 1) The maximum operating pressure for polyurethane (at 20°C) is 0.8 MPa.
(Refer to the **WEB catalog** for details.)

Flow Rate and Sonic Conductance

Model		10-ASD230F	10-ASD330F	10-ASD430F		10-ASD530F			10-ASD630F	
Tubing O.D.	Metric size	ø4, ø6	ø6, ø8	ø6	ø8, ø10	ø6	ø8	ø10, ø12	ø10	ø12
Controlled flow	Flow rate L/min (ANR)	75	175	295	350	500	600	700	1200	1300
Free flow	Sonic conductance dm ³ /(s·bar)	0.21	0.49	0.82	0.97	1.4	1.7	1.9	3.3	3.6
Critical pressure ratio	Controlled flow	0.25	0.2	0.2		0.2			0.2	
	Free flow	0.3	0.15	0.15		0.15			0.15	

Note) Supply pressure: 0.5 MPa, Temperature: 20°C.

Needle Valve / Flow Rate Characteristics

10-ASD230F

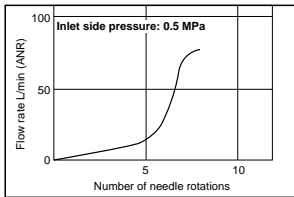

10-ASD330F

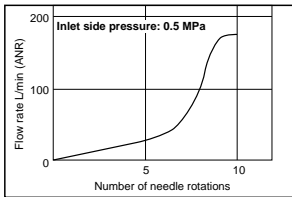

10-ASD430F

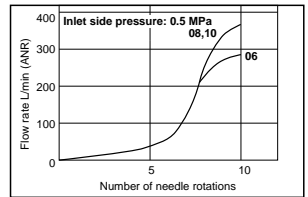

10-ASD530F

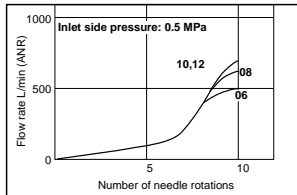

10-ASD630F

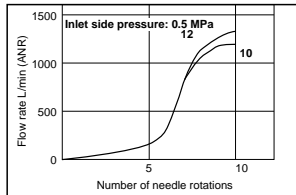

Directional Control Valves
 Air Cylinders
 Rotary Actuators
 Air Grippers
 Air Preparation Equipment
 Modular F. R.
 Pressure Control Equipment
 Fittings & Tubing
 Flow Control Equipment
 Pressure Switches/ Pressure Sensors

Dimensions

10-ASD230F

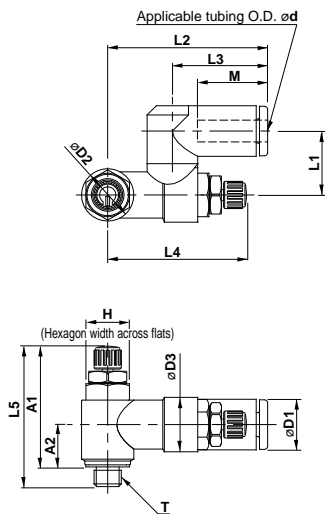

10-ASD330F/430F
10-ASD530F/630F

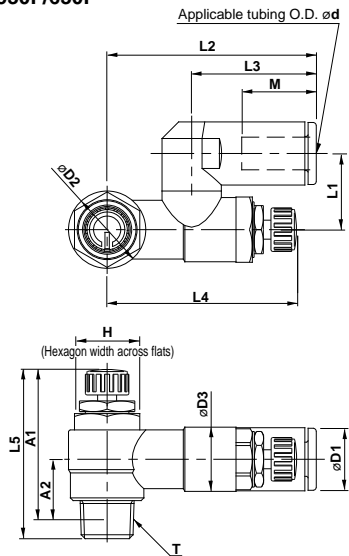

Model	d	T	H	D1	D2	D3	L1	L2		L3	L4		L5		A1 *		A2 †	M	Weight (g)
								MAX.	MIN.		MAX.	MIN.	MAX.	MIN.					
10-ASD230F-M5-04	4	M5 x 0.8	8	9.3	9.6	10	11.7	29.4	17.5	14	28.3	25.5	28.6	25.8	25	22.2	7.8	12.7	12
10-ASD230F-M5-06	6			11.6				32.5	20.6										13
10-ASD330F-01-06S	6	R1/8	12	11.6	14.2	11.8	14	38.5	22.9	15.8	39.6	34.6	36.1	31.1	32.1	27.1	10.6	13.5	29
10-ASD330F-01-08S	8			15.2				44.8	28.2										38.9
10-ASD430F-02-06S	6	R1/4	17	12.8	18.5	15	18	43.5	25.2	19.7	41.7	36.7	40.4	35.4	34.4	29.4	11	18.5	53
10-ASD430F-02-08S	8			15.2				46.5	28.2										41.7
10-ASD430F-02-10S	10	R1/4	17	18.5	18.5	15	19.7	49.3	31	20.3	46.9	41.9	48.8	43.8	42.8	37.8	15.4	21	58
10-ASD530F-02-06S	6			12.8				48.3	25.2										41.9
10-ASD530F-02-08S	8	R1/4	17	15.2	18.5	15	20.3	51.3	28.2	23.1	46.9	41.9	48.8	43.8	42.8	37.8	15.4	21	80
10-ASD530F-02-10S	10			18.5				54.1	32.6										41.9
10-ASD530F-02-12S	12	R1/4	19	20.9	23	19.8	20.3	55.9	34.4	23.1	46.9	41.9	48.8	43.8	42.8	37.8	15.4	22	83
10-ASD530F-03-06S	6			12.8				48.3	25.2										41.9
10-ASD530F-03-08S	8	R3/8	19	15.2	18.5	15	20.3	51.3	28.2	23.1	46.9	41.9	46.5	41.5	40	35	14	18.5	93
10-ASD530F-03-10S	10			18.5				54.1	32.6										41.9
10-ASD530F-03-12S	12	R3/8	19	20.9	23	19.8	23.1	55.9	34.4	23.1	46.9	41.9	46.5	41.5	40	35	14	22	101
10-ASD630F-04-10S	10			18.5				54.1	32.6										41.9
10-ASD630F-04-12S	12	R1/2	24	20.9	28.6	26.5	25.9	64.3	34.4	66.1	64.8	57.3	57.6	50.1	49.6	42.1	18.6	22	179
10-ASD630F-04-12S	12			20.9				66.1	34.4										64.8

* Reference dimensions of after M5 x 0.8, R thread being screwed in.



Series ASD Specific Product Precautions

Be sure to read this before handling. Refer to page 1382 for Safety Instructions and pages 1305 to 1308 for Flow Control Equipment Precautions.

Design / Selection

⚠ Caution

1. Single acting cylinder

When controlling a single acting cylinder, the cylinder's return speed will differ depending on the operating conditions. Operate referring to the maximum return speed shown in the table below.

Speed Controller	Cylinder	Solenoid valve	Tubing	Silencer	Maximum return speed (mm/s)		
					100	200	300
ASD230F	CJ2	SYJ500	TU0604 1m	AN110-01	ø6		
					ø10		
					ø16		
ASD330F	CM2	SYJ700	TU0604 1m	AN110-01	ø20		
					ø25		
					ø32		

* Values at 0.5 MPa and 20°C.

<Operating conditions>

- Cylinder extension speed: 100 mm/s
- Meter-out needle fully open

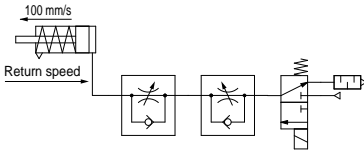

(Reference) Recommended circuit for high return speed
When low extension speed and high return speed are desired, the following circuit using 3-port is recommended.

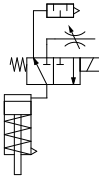

Note) Use the AS-F series with -X214 for the throttle valve.

Directional Control Valves

Air Cylinders

Rotary Actuators

Air Grippers

Air Preparation Equipment

Modular F. R.

Pressure Control Equipment

Fittings & Tubing

Flow Control Equipment

Pressure Switches/ Pressure Sensors

Series 10-AS-FG

Push-lock Type

RoHS

Speed Controller with One-touch Fitting
Stainless Steel Type (Elbow/Universal)

How to Order

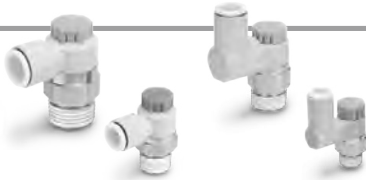

Elbow type

Universal type

• Applicable tubing O.D. ^{Note 1)}

Metric size		Inch size	
02	ø2	01	ø1/8"
23	ø3.2 ^{Note 2)}	03	ø5/32"
04	ø4	07	ø1/4"
06	ø6		

Note 1) For selecting applicable tubing O.D., refer to the "Model" on the table below.

The color of the release button is white (metric, inch).

Note 2) Use ø1/8" tube.

Body size

1	M5 x 0.8 10-32UNF
---	----------------------

Port size

M5	M5 x 0.8 10-32UNF
----	----------------------

Body size 1

10-AS 1 2 0 1 FG - M5 - 06 A

Body size 2/3/4

10-AS 2 2 0 1 FG - 01 - 06 S A

Clean series

Body size

2	1/8, 1/4
3	3/8
4	1/2

Type

2	Elbow
3	Universal

Control type ^{Note)}

0	Meter-out
1	Meter-in

Note) Meter-out and meter-in types can be visually identified by color of the knob.

Meter-out: Gray
Meter-in: Light blue

Stainless steel type
(Stainless steel 303)

Note 1) The material can be visually identified by color of the release button.

Stainless steel type: White

Note 2) White is also used for inch size.

Thread type

Nil	R
N	NPT

Port size

01	1/8
02	1/4
03	3/8
04	1/2

• Seal method

Nil	Without sealant
S	With sealant

• Applicable tubing O.D. ^{Note 1)}

Metric size		Inch size	
23	ø3.2 ^{Note 2)}	01	ø1/8"
04	ø4	03	ø5/32"
06	ø6	07	ø1/4"
08	ø8	09	ø5/16"
10	ø10	11	ø3/8"
12	ø12	13	ø1/2"
16	ø16		

Note 1) For selecting applicable tubing O.D., refer to the "Model" on the table below.

The color of the release button is white (metric, inch).

Note 2) Use ø1/8" tube.

Model

Model		Port size	Seal method	Applicable tubing O.D.														
Elbow type	Universal type			Metric size						Inch size								
				2 ^{Note 2)}	3.2	4	6	8	10	12	16	1/8"	5/32"	1/4"	5/16"	3/8"	1/2"	
10-AS12□1FG-M5	10-AS13□1FG-M5	M5 x 0.8	Gasket seal	● ^{Note 3)}	●	●	●						●	●	●			
10-AS12□1FG-U10/32	10-AS13□1FG-U10/32	10-32UNF		● ^{Note 3)}	●	●	●							●	●	●		
10-AS22□1FG-01	10-AS23□1FG-01	1/8	Sealant ^{Note 1)}		●	●	●	●	● ^{Note 3)}				●	●	●	●		
10-AS22□1FG-02	10-AS23□1FG-02	1/4			● ^{Note 3)}	●	●	●	●				● ^{Note 3)}	●	●	●	●	
10-AS32□1FG-02	10-AS33□1FG-02	1/4				●	●	●	●					●	●	●	●	
10-AS32□1FG-03	10-AS33□1FG-03	3/8				●	●	●	●					●	●	●	●	
10-AS42□1FG-04	10-AS43□1FG-04	1/2						●	●	●	● ^{Note 3)}					●	●	

Note 1) "Without sealant" type can be selected as a standard option.

Note 2) Only polyurethane tubing is applicable for ø2.

Note 3) Universal type is not available.

Specifications

Proof pressure	1.5 MPa
Max. operating pressure	1 MPa
Min. operating pressure	0.1 MPa
Ambient and fluid temperature	-5 to 60°C (No freezing)
Applicable tubing material	Polyurethane ^{Note)}
Grease	Fluorine grease
Cleanliness class (ISO class)	Class 5

Note) Use caution at the max. operating pressure when using polyurethane tubing. (Refer to the **WEB catalog** for details.)

Flow Rate and Sonic Conductance

Model	10-AS12□1FG-M5		10-AS22□1FG-□01		10-AS22□1FG-□02				10-AS32□1FG			10-AS42□1FG			
	10-AS13□1FG-M5		10-AS23□1FG-□01		10-AS23□1FG-□02				10-AS33□1FG			10-AS43□1FG			
Tubing O.D.	Metric size	ø2	ø3.2 ø4 ø6	ø3.2	ø4	ø6 ø8 ø10	ø3.2	ø4	ø6	ø8 ø10	ø6	ø8	ø10 ø12	ø10	ø12 ø16
	Inch size	—	ø1/8" ø1/4" ø5/32"	ø1/8"	ø5/32"	ø1/4" ø5/16"	ø1/8"	ø5/32"	—	ø1/4" ø5/16" ø3/8"	ø1/4"	ø5/16"	ø3/8"	ø3/8"	ø1/2"
C values: Sonic conductance dm ³ /(s·bar)	Free flow	0.2	0.3	0.4	0.6	0.6	0.7	1.0	1.3	1.5	1.6	1.7	2.5	4.4	4.8
	Controlled flow	0.2	0.3	0.4	0.7	0.8	0.6	0.9	1.3		2.1	2.4	3.3	4.4	4.9
b values: Critical pressure ratio	Free flow	0.3	0.4	0.2		0.3	0.3		0.4	0.4			0.3	0.3	
	Controlled flow	0.2		0.2		0.3	0.3			0.3			0.3	0.3	

Note 1) 10-32UNF has the same specification as M5.

Note 2) C and b values are for controlled flow with the needle fully open and free flow with the needle fully closed.

Needle Valve/Flow Rate Characteristics

**10-AS1201FG-M5, 10-AS1211FG-M5
10-AS1301FG-M5, 10-AS1311FG-M5**

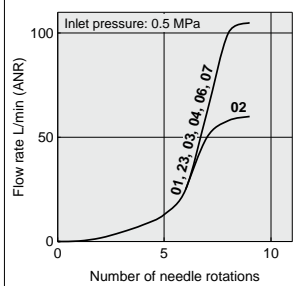

Note) -U10/32 has the same specification as M5.

**10-AS2201FG-01, 10-AS2211FG-01
10-AS2301FG-01, 10-AS2311FG-01**

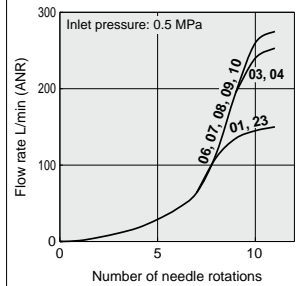

**10-AS2201FG-02, 10-AS2211FG-02
10-AS2301FG-02, 10-AS2311FG-02**

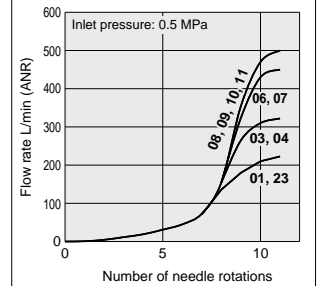

**10-AS3201FG, 10-AS3211FG
10-AS3301FG, 10-AS3311FG**

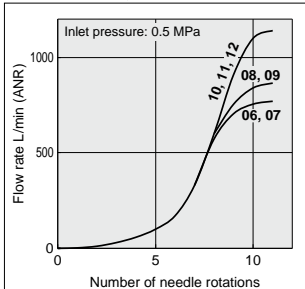

**10-AS4201FG, 10-AS4211FG
10-AS4301FG, 10-AS4311FG**

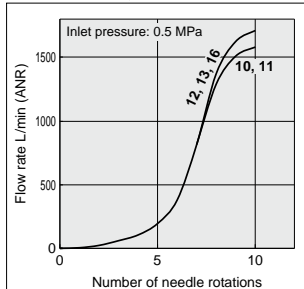

Note) The numbers above the flow rate characteristic curves in the charts show the applicable tubing outside diameter as defined by the product number.

Directional Control Valves
Air Cylinders
Rotary Actuators
Air Grippers
Air Preparation Equipment
Modular F. R.
Pressure Control Equipment
Fittings & Tubing
Flow Control Equipment
Pressure Switches/Pressure Sensors

Dimensions/ **Elbow type**

Seal method: Gasket seal
For M5, 10-32UNF

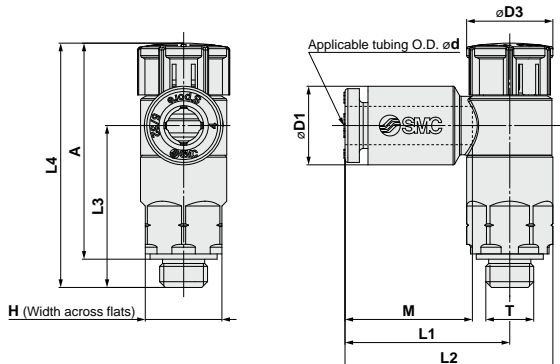

Metric Size

Model	d	T	H	D1	D3	L1	L2	L3	L4 Note 1)		A Note 2)		M	Weight [g]
									Unlocked	Locked	Unlocked	Locked		
10-AS12□1FG-M5-02A	2	M5 x 0.8 10/32UNF	8	5.8	9.4	15.8	20.3	16.9	26.5	25.4	23.5	22.4	11.9	5
10-AS12□1FG-U10/32-02A														
10-AS12□1FG-M5-23A	3.2			7.2										
10-AS12□1FG-U10/32-23A														
10-AS12□1FG-M5-04A	4			8.2										
10-AS12□1FG-U10/32-04A														
10-AS12□1FG-M5-06A	6	10.4	18.6	23.1	16.5									
10-AS12□1FG-U10/32-06A														

Note 1) Reference dimensions

Note 2) Reference dimensions of threads after installation

Inch Size

Model	d	T	H	D1	D3	L1	L2	L3	L4 Note 1)		A Note 2)		M	Weight [g]			
									Unlocked	Locked	Unlocked	Locked					
10-AS12□1FG-M5-01A	1/8"	M5 x 0.8 10/32UNF	8	7.2	9.4	17.2	21.7	16.9	26.5	25.4	23.5	22.4	13.3	5			
10-AS12□1FG-U10/32-01A																	
10-AS12□1FG-M5-03A	5/32"			8.2													
10-AS12□1FG-U10/32-03A																	
10-AS12□1FG-M5-07A	1/4"			11.2											18.6	23.1	16.5
10-AS12□1FG-U10/32-07A																	

Note 1) Reference dimensions

Note 2) Reference dimensions of threads after installation

Dimensions/ Universal type

Seal method: Gasket seal
For M5, 10-32UNF

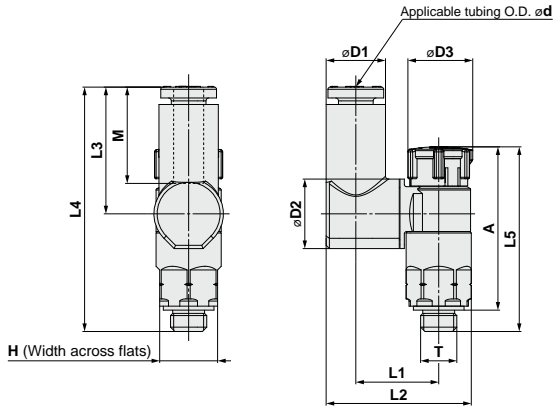

Metric Size

Model	d	T	H	D1	D2	D3	L1	L2	L3	L4	L5 Note 1)		A Note 2)		M	Weight [g]
											Unlocked	Locked	Unlocked	Locked		
10-AS13□1FG-M5-23A	3.2	M5 x 0.8 10/32UNF	8	7.2	9.6	9.4	11.6	19.7	17.5	33.8	26.5	25.4	23.5	22.4	13.3	6
10-AS13□1FG-U10/32-23A																
10-AS13□1FG-M5-04A	8.2			11.5			20.1									
10-AS13□1FG-U10/32-04A																
10-AS13□1FG-M5-06A	10.4	11.5	20.1													
10-AS13□1FG-U10/32-06A	11.5			20.4	36.6											

Note 1) Reference dimensions
Note 2) Reference dimensions of threads after installation

Inch Size

Model	d	T	H	D1	D2	D3	L1	L2	L3	L4	L5 Note 1)		A Note 2)		M	Weight [g]
											Unlocked	Locked	Unlocked	Locked		
10-AS13□1FG-M5-01A	1/8"	M5 x 0.8 10/32UNF	8	7.2	9.6	9.4	11.6	19.7	17.5	33.8	26.5	25.4	23.5	22.4	13.3	6
10-AS13□1FG-U10/32-01A																
10-AS13□1FG-M5-03A	8.2			11.5			20.1									
10-AS13□1FG-U10/32-03A																
10-AS13□1FG-M5-07A	11.2	11.5	20.1													
10-AS13□1FG-U10/32-07A	11.5			20.2	36.5											

Note 1) Reference dimensions
Note 2) Reference dimensions of threads after installation

Directional Control Valves

Air Cylinders

Rotary Actuators

Air Grippers

Air Preparation Equipment

Modular F. R.

Pressure Control Equipment

Fittings & Tubing

Flow Control Equipment

Pressure Switches/ Pressure Sensors

Dimensions/ Elbow type

Seal method: Sealant
For R, NPT thread

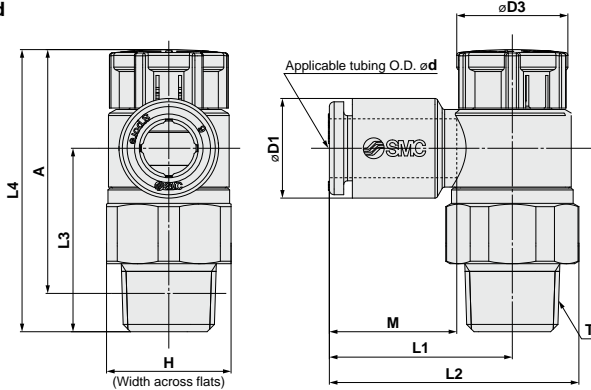

Metric Size

Model	d	T	H	D1	D3	L1	L2	L3	L4 Note 1)		A Note 1)		M	Weight [g]		
									Unlocked	Locked	Unlocked	Locked				
10-AS22□1FG-01-23(S)A	3.2	1/8	13 (12.7)	7.2	12	19.1	26.2	19.1	30.6	29.2	27.5	26.1	13.3	9 (9)		
10-AS22□1FG-01-04(S)A	4			10 (9)												
10-AS22□1FG-01-06(S)A	6			14.2										11 (10)		
10-AS22□1FG-01-08(S)A	8			15.6										12 (11)		
10-AS22□1FG-01-10(S)A	10			15.9		25.3	32.4									
10-AS22□1FG-02-23(S)A	3.2	1/4	17 (17.5)	7.2	13	20.9	30.2 (30.3)	22.6	36.6	35	31.1	29.5	13.3	17 (18)		
10-AS22□1FG-02-04(S)A	4			8.2										17 (18)		
10-AS22□1FG-02-06(S)A	6			10.4										23.4	32.7 (32.8)	
10-AS22□1FG-02-08(S)A	8			13.2										23.9	33.2 (33.3)	
10-AS22□1FG-02-10(S)A	10			15.9		26.9	36.2 (36.3)									
10-AS32□1FG-02-06(S)A	6	1/4	19	10.4	16.6	21.8	32.1	36.4	50	48.4	44.5	42.9	13.3	40 (40)		
10-AS32□1FG-02-08(S)A	8			13.2										22.7	33	
10-AS32□1FG-02-10(S)A	10			15.9										26.7	37	35.7
10-AS32□1FG-02-12(S)A	12			18.5										29.7	40	34.5
10-AS32□1FG-03-06(S)A	6	3/8	19	10.4	16.6	21.8	32.1	28.7	42.3	40.7	37.1	35.5	13.3	29 (30)		
10-AS32□1FG-03-08(S)A	8			13.2										22.7	33	
10-AS32□1FG-03-10(S)A	10			15.9										26.7	37	28
10-AS32□1FG-03-12(S)A	12			18.5										29.7	40	26.8
10-AS42□1FG-04-10(S)A	10	1/2	24 (23.8)	15.9	18.8	27.4	40.3 (40.2)	36.2	50.8	49.2	43.7	42.1	15.6	52 (51)		
10-AS42□1FG-04-12(S)A	12			18.5										30.8	43.7 (43.6)	35.1
10-AS42□1FG-04-16(S)A	16			23.8										34.8	47.7 (47.6)	32.7

Note 1) Reference dimensions Note 2) Reference dimensions of threads after installation Note 3) The values in () are for NPT thread.

Inch Size

Model	d	T	H	D1	D3	L1	L2	L3	L4 Note 1)		A Note 2)		M	Weight [g]		
									Unlocked	Locked	Unlocked	Locked				
10-AS22□1FG-01-01(S)A	1/8"	1/8	13 (12.7)	7.2	12	19.1	26.2	19.1	30.6	29.2	27.5	26.1	13.3	9 (9)		
10-AS22□1FG-01-03(S)A	5/32"			10 (9)												
10-AS22□1FG-01-07(S)A	1/4"			11.2										20.8	27.9	
10-AS22□1FG-01-09(S)A	5/16"			13.2										22.4	29.5	
10-AS22□1FG-02-01(S)A	1/8"	1/4	17 (17.5)	7.2	13	20.9	30.2 (30.3)	22.6	36.6	35	31.1	29.5	13.3	17 (18)		
10-AS22□1FG-02-03(S)A	5/32"			8.2										17 (18)		
10-AS22□1FG-02-07(S)A	1/4"			11.2										23.4	32.7 (32.8)	
10-AS22□1FG-02-09(S)A	5/16"			13.2										23.9	33.2 (33.3)	
10-AS22□1FG-02-11(S)A	3/8"			15.5		26.4	35.7 (35.8)									
10-AS32□1FG-02-07(S)A	1/4"	1/4	19	11.2	16.6	21.8	32.1	36.4	50	48.4	44.5	42.9	13.3	40 (40)		
10-AS32□1FG-02-09(S)A	5/16"			13.2										22.7	33	
10-AS32□1FG-02-11(S)A	3/8"			15.5										26.7	37	35.9
10-AS32□1FG-03-07(S)A	1/4"			11.2										21.8	32.1	28.7
10-AS32□1FG-03-09(S)A	5/16"	3/8	19	13.2	16.6	22.7	33	28.7	42.3	40.7	37.1	35.5	13.3	29 (30)		
10-AS32□1FG-03-11(S)A	3/8"			15.5										26.7	37	28.2
10-AS42□1FG-04-11(S)A	3/8"			15.5										27.4	40.3 (40.2)	36.2
10-AS42□1FG-04-13(S)A	1/2"			19.3										30.9	43.8 (43.7)	34.7

Note 1) Reference dimensions Note 2) Reference dimensions of threads after installation Note 3) The values in () are for NPT thread.

Dimensions/ Universal type

Seal method: Sealant
For R, NPT thread

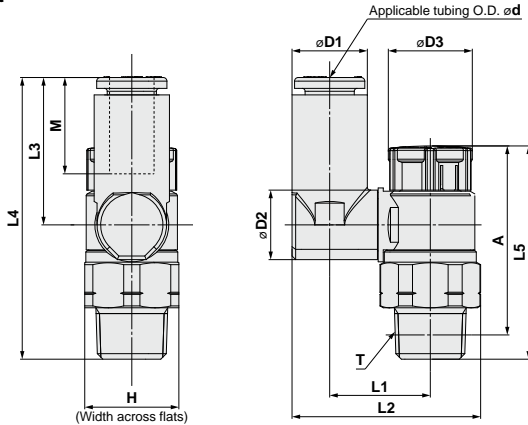

Metric Size

Model	d	T	H	D1	D2	D3	L1	L2	L3	L4	L5 Note 1)		A Note 2)		M	Weight			
											Unlocked	Locked	Unlocked	Locked		[g]			
10-AS23□1FG-01-23(S)A	3.2	1/8	13 (12.7)	7.2	9.6	12	13.3	24	17.5	36	30.6	29.2	27.5	26.1	13.3	10 (9)			
10-AS23□1FG-01-04(S)A	4			8.2			13.9	25.1								10 (10)			
10-AS23□1FG-01-06(S)A	6			10.4			26.2	20.4								38.8	14.2	12 (11)	
10-AS23□1FG-01-08(S)A	8	1/4	17 (17.5)	13.2	12.9	13	16.4	30.1	21.4	40.1	36.6	35	31.1	29.5	13.3	20 (21)			
10-AS23□1FG-02-04(S)A	4			8.2			16.5	29.9 (30)								17.5	40.1	18 (19)	
10-AS23□1FG-02-06(S)A	6			11.2			33.8 (33.9)	21.4								43.9	20 (21)		
10-AS23□1FG-02-08(S)A	8			13.2			34.9 (35)	23.5								46	14.2	21 (22)	
10-AS23□1FG-02-10(S)A	10			15.9			20.9	38.1 (38.2)								24.7	47.3	15.6	23 (23)
10-AS33□1FG-02-06(S)A	6			1/4			19	11.2								12.9	16.6	20.2	36
10-AS33□1FG-02-08(S)A	8	13.2	23		37.1	23.5		59.9	14.2	43 (43)									
10-AS33□1FG-02-10(S)A	10	15.9	41.2		26.1	62.5		15.6	46 (46)										
10-AS33□1FG-02-12(S)A	12	18.5	42.5		28.3	57		17	48 (48)										
10-AS33□1FG-03-06(S)A	6	11.2	20.2		36	21.4		50.1	13.3	32 (33)									
10-AS33□1FG-03-08(S)A	8	13.2	23		37.1	23.5		52.2	14.2	33 (34)									
10-AS33□1FG-03-10(S)A	10	15.9	23	41.2	26.1	54.8	15.6	37 (38)											
10-AS33□1FG-03-12(S)A	12	18.5	42.5	28.3	57	17	38 (39)												
10-AS43□1FG-04-10(S)A	10	1/2	24 (23.8)	15.9	17.4	18.8	25.6	46.4 (46.3)	26.1	61.2	50.8	49.2	43.7	42.1	15.6	58 (57)			
10-AS43□1FG-04-12(S)A	12			18.5			21	26.2								48.3 (48.2)	28.3	63.4	17

Note 1) Reference dimensions Note 2) Reference dimensions of threads after installation Note 3) The values in () are for NPT thread.

Inch Size

Model	d	T	H	D1	D2	D3	L1	L2	L3	L4	L5 Note 1)		A Note 2)		M	Weight			
											Unlocked	Locked	Unlocked	Locked		[g]			
10-AS23□1FG-01-01(S)A	1/8"	1/8	13 (12.7)	7.2	9.6	12	13.3	24	17.5	36	30.6	29.2	27.5	26.1	13.3	10 (9)			
10-AS23□1FG-01-03(S)A	5/32"			8.2			13.9	25.1								10 (10)			
10-AS23□1FG-01-07(S)A	1/4"			11.2			16.4	29.1								20.2	38.7	14.2	12 (11)
10-AS23□1FG-01-09(S)A	5/16"	1/4	17 (17.5)	13.2	12.9	13	16.4	30.1	21.5	40	36.6	35	31.1	29.5	13.3	18 (19)			
10-AS23□1FG-02-03(S)A	5/32"			8.2			16.5	29.9 (30)								17.5	40.1	20 (21)	
10-AS23□1FG-02-07(S)A	1/4"			11.2			33.8 (33.9)	21.4								43.9	20 (21)		
10-AS23□1FG-02-09(S)A	5/16"			13.2			34.9 (35)	23.5								46	14.2	21 (22)	
10-AS23□1FG-02-11(S)A	3/8"			15.9			20.9	38.1 (38.2)								24.7	47.3	15.6	23 (23)
10-AS33□1FG-02-07(S)A	1/4"			3/8			19	11.2								12.9	16.6	20.2	36
10-AS33□1FG-02-09(S)A	5/16"	13.2	23		37.1	23.5		59.9	14.2	43 (43)									
10-AS33□1FG-02-11(S)A	3/8"	15.9	41.2		26.1	62.5		15.6	46 (46)										
10-AS33□1FG-03-07(S)A	1/4"	11.2	20.2		36	21.4		50.1	13.3	32 (33)									
10-AS33□1FG-03-09(S)A	5/16"	13.2	23		37.1	23.5		52.2	14.2	33 (34)									
10-AS33□1FG-03-11(S)A	3/8"	15.9	23		41.2	26.1		54.8	15.6	37 (38)									
10-AS43□1FG-04-11(S)A	3/8"	1/2	24 (23.8)	15.9	17.4	18.8	25.6	46.4 (46.3)	26.1	61.2	50.8	49.2	43.7	42.1	15.6	58 (57)			
10-AS43□1FG-04-13(S)A	1/2"			18.5			21	26.2								48.3 (48.2)	28.3	63.4	17

Note 1) Reference dimensions Note 2) Reference dimensions of threads after installation Note 3) The values in () are for NPT thread.

Directional Control Valves
Air Cylinders
Rotary Actuators
Air Grippers
Air Preparation Equipment
Modular F. R.
Pressure Control Equipment
Fittings & Tubing
Flow Control Equipment
Pressure Switches/ Pressure Sensors

Series 10-AS-FSG

Push-lock Type

RoHS

Speed Controller with Indicator
Stainless Steel Type (Elbow)

How to Order



Applicable tubing O.D. Note 1)

Metric size		Inch size	
02	ø2	01	ø1/8"
23	ø3.2 <small>Note 2)</small>	03	ø5/32"
04	ø4	07	ø1/4"
06	ø6		

Note 1) For selecting applicable tubing O.D., refer to the "Model" on the table below.
Metric size and inch size types can be visually identified by color of the release button.

Stainless steel type: White
White is also used for inch size.

Note 2) Use ø1/8" tube.

Port size

M5	M5 x 0.8
U10/32	10-32UNF

Body size

1	M5 x 0.8 10-32UNF
---	----------------------

Body size 1 10 - AS 1 2 0 1 F S G [] - M5 - 06

Body size 2/3/4 10 - AS 2 2 0 1 F S G [] - [] - 01 - 06 S

Clean series

Body size

2	1/8, 1/4
3	3/8
4	1/2

Type

2	Elbow
---	-------

With indicator
Stainless steel type

Thread type

Nil	R
N	NPT

Seal method

Nil	Without sealant
S	With sealant

Applicable tubing O.D. Note 1)

Metric size		Inch size	
23	ø3.2 <small>Note 2)</small>	01	ø1/8"
04	ø4	03	ø5/32"
06	ø6	07	ø1/4"
08	ø8	09	ø5/16"
10	ø10	11	ø3/8"
12	ø12	13	ø1/2"
16	ø16		

Note 1) For selecting applicable tubing O.D., refer to the "Model" on the table below.

Note 2) Use ø1/8" tube.

Control type Note)

0	Meter-out
1	Meter-in

Note) Meter-out and meter-in types can be visually identified by color of the handle.

Meter-out: Gray
Meter-in: Light blue

Indicator direction

Nil	0°	
1	180°	

Note) Orientation of indicator direction is fixed when manufacturing, and cannot be changed by the user.

Model

Model	Port size	Seal method	Applicable tubing O.D.											<small>Note 3)</small> Max. number of rotations						
			Metric size						Inch size											
			2 <small>Note 2)</small>	3.2	4	6	8	10	12	16	1/8"	5/32"	1/4"		5/16"	3/8"	1/2"			
10-AS12□1FSG□-M5	M5 x 0.8	Gasket seal	●	●	●	●							●	●	●				8	
10-AS12□1FSG□-U10/32	10-32UNF		●	●	●	●							●	●	●					
10-AS22□1FSG□-01	R NPT	Sealant <small>Note 1)</small>		●	●	●	●	●	●				●	●	●	●			10	
10-AS22□1FSG□-02			1/8		●	●	●	●	●	●				●	●	●	●			
10-AS32□1FSG□-02			1/4		●	●	●	●	●	●				●	●	●	●			
10-AS32□1FSG□-03			3/8				●	●	●	●	●				●	●	●	●		
10-AS42□1FSG□-04			1/2						●	●	●	●					●	●		●

Note 1) "Without sealant" type can be selected as a standard option.

Note 2) Only polyurethane tubing is applicable for ø2.

Note 3) There are differences in actual rate as by the indicator window over the maximum number of rotations depending on the individual product.

Specifications

Proof pressure	1.5 MPa
Max. operating pressure	1 MPa
Min. operating pressure	0.1 MPa
Ambient and fluid temperature	-5 to 60°C (No freezing)
Applicable tubing material	Polyurethane ^{Note)}
Grease	Fluorine grease
Cleanliness class (ISO class)	Class 5

Note) Use caution at the max. operating pressure when using polyurethane tubing. (Refer to the **WEB catalog** for details.)

Flow Rate and Sonic Conductance

Model	10-AS12□1FSG□-M5		10-AS22□1FSG□-01		10-AS22□1FSG□-02			10-AS32□1FSG□		10-AS42□1FSG□			
	Metric size	ø2 ø3.2 ø4 ø6	ø3.2 ø4	ø4 ø6 ø8 ø10	ø3.2 ø4 ø6 ø8 ø10	ø3.2 ø4 ø6 ø8 ø10	ø4 ø6 ø8 ø10	ø6 ø8 ø10 ø12	ø6 ø8 ø10 ø12	ø10 ø12 ø16			
Tubing O.D.	Inch size	— ø1/8" ø1/4" ø5/32"	ø1/8"	ø5/32"	ø1/4" ø5/16"	ø1/8" ø5/32"	— ø1/4" ø5/16" ø3/8"	ø1/4" ø5/16"	ø3/8"	ø3/8" ø1/2"			
	C values: Sonic conductance dm ³ /(s·bar)	Free flow Controlled flow	0.2 0.3	0.4 0.7	0.6 0.8	0.7 0.6	1.0 0.9	1.3 1.3	1.5 2.1	1.7 2.4	2.5 3.3	4.4 4.4	4.8 4.9
b values: Critical pressure ratio	Free flow	0.3 0.4	0.2	0.3	0.3	0.3	0.4	0.4	0.4	0.3	0.3	0.3	0.3
	Controlled flow	0.2	0.2	0.3	0.3	0.3	0.3	0.3	0.3	0.3	0.3	0.3	0.3

Note 1) 10-32UNF has the same specification as M5.

Note 2) C and b values are for controlled flow with the needle fully open and free flow with the needle fully closed.

Needle Valve/Flow Rate Characteristics

10-AS1201FSG□-M5, 10-AS1211FSG□-M5

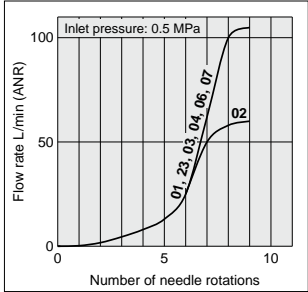

Note) -U10/32 has the same specification as M5.

10-AS2201FSG□-01, 10-AS2211FSG□-01

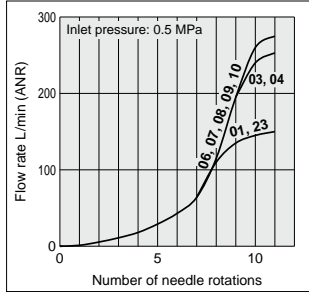

10-AS2201FSG□-02, 10-AS2211FSG□-02

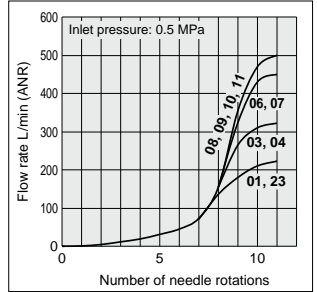

10-AS3201FSG□, 10-AS3211FSG□

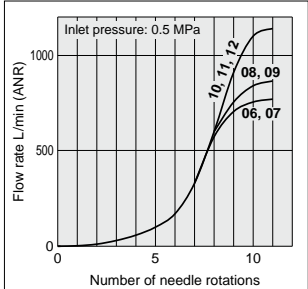

10-AS4201FSG□, 10-AS4211FSG□

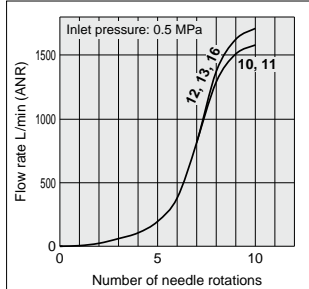

Note) The numbers above the flow rate characteristic curves in the charts show the applicable tubing outside diameter as defined by the product number.

Directional Control Valves
Air Cylinders
Rotary Actuators
Air Grippers
Air Preparation Equipment
Modular F. R.
Pressure Control Equipment
Fittings & Tubing
Flow Control Equipment
Pressure Switches/Pressure Sensors



Dimensions

Seal method: Gasket seal
For M5, 10-32UNF

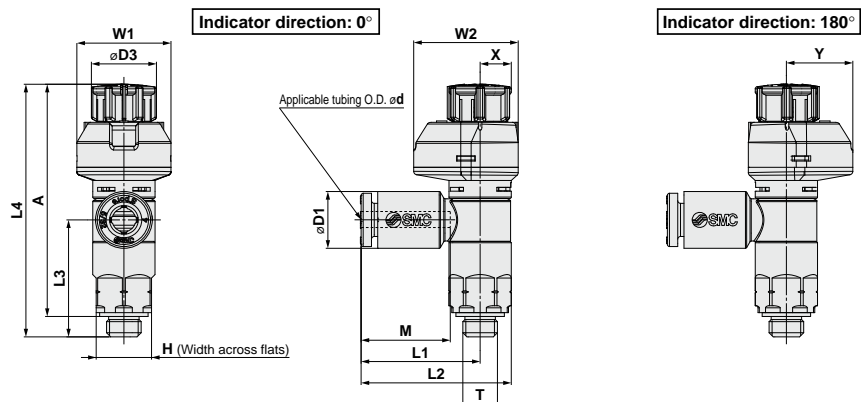

Metric Size

Model	d	T	H	D1	D3	L1	L2	L3	L4 Note 1)		A Note 2)		M	W1	W2	X	Y	Weight (g)
									Unlocked	Locked	Unlocked	Locked						
10-AS12□1FSG□-M5-02	2	M5 x 0.8 10/32UNF	8	5.8	15.8	20.3	16.9	39	36.5	35	33.5	11.9	13.6	15.1	5.5	9.6	7	
10-AS12□1FSG□-U10/32-02				7.2														
10-AS12□1FSG□-M5-23	3.2			9.4	17.2	21.7	16.9	39	36.5	35	33.5	11.9	13.6	15.1	5.5	9.6		
10-AS12□1FSG□-U10/32-23				8.2														
10-AS12□1FSG□-M5-04	4			10.4	18.6	23.1	16.5	39	36.5	35	33.5	13.3	13.6	15.1	5.5	9.6		
10-AS12□1FSG□-U10/32-04				8.2														
10-AS12□1FSG□-M5-06	6	10.4	18.6	23.1	16.5	39	36.5	35	33.5	13.3	13.6	15.1	5.5	9.6				
10-AS12□1FSG□-U10/32-06		8.2																

Note 1) Reference dimensions

Note 2) Reference dimensions of threads after installation

Inch Size

Model	d	T	H	D1	D3	L1	L2	L3	L4 Note 1)		A Note 2)		M	W1	W2	X	Y	Weight (g)
									Unlocked	Locked	Unlocked	Locked						
10-AS12□1FSG□-M5-01	1/8"	M5 x 0.8 10/32UNF	8	7.2	9.4	17.2	21.7	16.9	39.0	36.5	35	33.5	13.3	13.6	15.1	5.5	9.6	7
10-AS12□1FSG□-U10/32-01				8.2														
10-AS12□1FSG□-M5-03	5/32"			11.2	18.6	23.1	16.5	39.0	36.5	35	33.5	13.3	13.6	15.1	5.5	9.6		
10-AS12□1FSG□-U10/32-03				8.2														
10-AS12□1FSG□-M5-07	1/4"			11.2	18.6	23.1	16.5	39.0	36.5	35	33.5	13.3	13.6	15.1	5.5	9.6		
10-AS12□1FSG□-U10/32-07				8.2														

Note 1) Reference dimensions

Note 2) Reference dimensions of threads after installation



Dimensions

Seal method: Sealant
For R, NPT thread

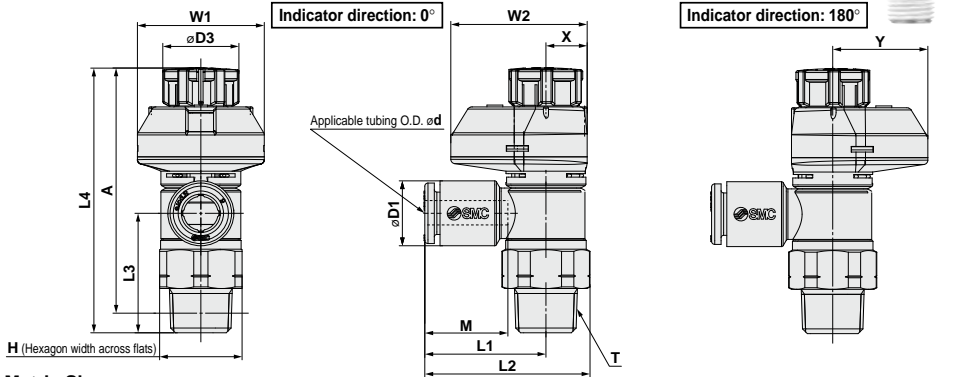

Metric Size

Model	d	T (R, NPT)	H	D1	D3	L1	L2	L3	L4 Note 1)		A Note 2)		M	W1	W2	X	Y	Weight (g)
									Unlocked	Locked	Unlocked	Locked						
10-AS22□1FSG□-01-23(S)	3.2	1/8 (12.7)	13	7.2	12	19.1	26.1 (26)	19.1	43.9	42.4	40.8	39.3	13.3	20	21.5	6.5	15	13 (13)
10-AS22□1FSG□-01-04(S)	4			8.2														14 (14)
10-AS22□1FSG□-01-06(S)	6			10.4														15 (14)
10-AS22□1FSG□-01-08(S)	8			13.2														16 (15)
10-AS22□1FSG□-01-10(S)	10	1/4 (17.5)	17	15.9	13	20.9	30 (30.3)	22.6	49.7	48.3	44.2	42.8	13.3	21.5	24	7.8	16.2	23 (24)
10-AS22□1FSG□-02-04(S)	4			8.2														24 (25)
10-AS22□1FSG□-02-06(S)	6			10.4														25 (26)
10-AS22□1FSG□-02-08(S)	8			13.2														26 (26)
10-AS22□1FSG□-02-10(S)	10	3/8	19	15.9	16.6	21.8	32.1	36.4	63.1	61.7	57.9	56.5	13.3	24.5	28.5	9.3	19.2	47 (48)
10-AS32□1FSG□-02-06(S)	6			10.4														50 (51)
10-AS32□1FSG□-02-08(S)	8			13.2														33
10-AS32□1FSG□-02-10(S)	10			15.9														35.7
10-AS32□1FSG□-02-12(S)	12	1/2 (23.8)	24	18.5	18.8	29.7	40	34.5	55.4	54	50.2	48.8	13.3	24.5	28.5	9.3	19.2	38 (39)
10-AS32□1FSG□-03-06(S)	6			10.4														28.7
10-AS32□1FSG□-03-08(S)	8			13.2														27.7
10-AS32□1FSG□-03-10(S)	10			15.9														26.7
10-AS32□1FSG□-03-12(S)	12	3/8	19	18.5	16.6	29.7	40	26.8	64.1	62.5	57	55.4	13.3	24.5	28.5	9.3	19.2	29 (40)
10-AS42□1FSG□-03-12(S)	12			15.9														27.4
10-AS42□1FSG□-04-11(S)	11			18.5														40.3 (40.2)
10-AS42□1FSG□-04-12(S)	12			23.8														36.2
10-AS42□1FSG□-04-16(S)	16	1/2 (23.8)	24	23.8	18.8	30.8	43.7 (43.6)	35.1	64.1	62.5	57	55.4	15.6	26	29	10	19	62 (61)
10-AS42□1FSG□-04-12(S)	12			17														64 (63)
10-AS42□1FSG□-04-16(S)	16			20.6														68 (67)

Note 1) Reference dimensions Note 2) Reference dimensions of threads after installation Note 3) () are the dimensions of NPT thread.

Inch Size

Model	d	T (R, NPT)	H	D1	D3	L1	L2	L3	L4 Note 1)		A Note 2)		M	W1	W2	X	Y	Weight (g)
									Unlocked	Locked	Unlocked	Locked						
10-AS22□1FSG□-01-01(S)	1/8"	1/8 (12.7)	13	7.2	12	19.1	26.1 (26)	19.1	43.8	42.4	40.7	39.3	13.3	20	21.5	6.5	15	13 (13)
10-AS22□1FSG□-01-03(S)	5/32"			8.2														14 (13)
10-AS22□1FSG□-01-07(S)	1/4"			11.2														15 (14)
10-AS22□1FSG□-01-09(S)	5/16"			13.2														16 (15)
10-AS22□1FSG□-02-01(S)	1/8"	1/4 (17.5)	17	7.2	13	20.9	30 (30.3)	22.6	49.7	48.3	44.2	42.8	13.3	21.5	24	7.8	16.2	23 (24)
10-AS22□1FSG□-02-03(S)	5/32"			8.2														24 (24)
10-AS22□1FSG□-02-07(S)	1/4"			11.2														25 (25)
10-AS22□1FSG□-02-09(S)	5/16"			13.2														26 (26)
10-AS22□1FSG□-02-11(S)	3/8"	3/8	19	15.5	16.6	21.8	32.1	28.7	63.1	61.7	57.9	56.5	13.3	24.5	28.5	9.3	19.2	47 (48)
10-AS32□1FSG□-02-07(S)	1/4"			11.2														33
10-AS32□1FSG□-02-09(S)	5/16"			13.2														37
10-AS32□1FSG□-02-11(S)	3/8"			15.5														28.2
10-AS32□1FSG□-03-07(S)	1/4"	3/8	19	11.2	16.6	21.8	32.1	28.7	55.4	54	50.2	48.8	13.3	24.5	28.5	9.3	19.2	38 (39)
10-AS32□1FSG□-03-09(S)	5/16"			13.2														33
10-AS32□1FSG□-03-11(S)	3/8"			15.5														37
10-AS42□1FSG□-04-11(S)	3/8"			18.5														40.3 (40.2)
10-AS42□1FSG□-04-13(S)	1/2"	1/2 (23.8)	24	19.3	18.8	30.9	43.8 (43.7)	34.7	64.1	62.5	57	55.4	15.6	26	29	10	19	62 (61)
10-AS42□1FSG□-04-13(S)	1/2"			17														64 (63)

Note 1) Reference dimensions Note 2) Reference dimensions of threads after installation Note 3) () are the dimensions of NPT thread.

Directional Control Valves
Air Cylinders
Rotary Actuators
Air Grippers
Air Preparation Equipment
Modular F. R.
Pressure Control Equipment
Fittings & Tubing
Flow Control Equipment
Pressure Switches/Pressure Sensors

Series 10-AS-FG

Stainless Steel Speed Controller with One-touch Fittings (Elbow/Universal type)

RoHS

How to Order

10 – **AS** **2** **3** **1** **1** **F** **G** **01** **06**

Clean series •

Body size •

1	M5 standard
2	1/8, 1/4 standard
3	3/8 standard
4	1/2 standard

Type •

2	Elbow
3	Universal

Control type •

0	Meter-out
1	Meter-in

With One-touch fitting •

Stainless steel specifications (Stainless steel 303) •

Lock nut option

Nil	Hexagon lock nut
J	Round lock nut

Applicable tubing O.D. (Note)

Metric size

23	ø3.2*
04	ø4
06	ø6
08	ø8
10	ø10
12	ø12

Note) Refer to the following Model list for selection of applicable tubing O.D.
* ø1/8" tubing should be used.

Port size

M5	M5 x 0.8
01	R1/8
02	R1/4
03	R3/8
04	R1/2



Model

Elbow type	Universal type	Port size	Applicable tubing O.D.					
			Metric size					
			3.2	4	6	8	10	12
10-AS12□1FG-M5	10-AS13□1FG-M5	M5 x 0.8	●	●	●			
10-AS22□1FG-01	10-AS23□1FG-01	R1/8	●	●	●	●	●*	
10-AS22□1FG-02	10-AS23□1FG-02	R1/4		●	●	●	●	
10-AS32□1FG-02	10-AS33□1FG-02	R1/4			●	●	●	●
10-AS32□1FG-03	10-AS33□1FG-03	R3/8			●	●	●	●
10-AS42□1FG-04	10-AS43□1FG-04	R1/2					●	●

Note 1) The meter-out and meter-in types can be visually determined by the flow direction symbol on the resin body.

Note 2) * Elbow type only.

Specifications

Proof pressure	1.5 MPa
Max. operating pressure	1 MPa
Min. operating pressure	0.1 MPa
Ambient and fluid temperature	-5 to 60°C (No freezing)
Applicable tubing material	Polyurethane ^{Note 1)}
Grease	Fluorine grease
Cleanliness class (ISO class)	Class 5

Note 1) The maximum operating pressure for polyurethane (at 20 °C) is 0.8 MPa.
(Refer to the **WEB catalog** for details.)

Directional Control Valves

Air Cylinders

Rotary Actuators

Air Grippers

Air Preparation Equipment

Modular F. R.

Pressure Control Equipment

Fittings & Tubing

Flow Control Equipment

Pressure Switches/ Pressure Sensors

Flow Rate and Sonic Conductance

Model		10-AS12□1FG 10-AS13□1FG	10-AS22□1FG-□01 10-AS23□1FG-□01	10-AS22□1FG-□02 10-AS23□1FG-□02			10-AS32□1FG 10-AS33□1FG			10-AS42□1FG 10-AS43□1FG		
Tubing O.D.	Metric size	ø3.2 ø4 ø6	ø3.2 ø4 ø6 ø8 ø10	ø4 ø6 ø8 ø10	ø4 ø6 ø8 ø10	ø6 ø8 ø10	ø6 ø8 ø10 ø12	ø6 ø8 ø10 ø12	ø6 ø8 ø10 ø12	ø10 ø12	ø12	
	Flow rate L/min (ANR)	100	180	230	260	390	460	660	790	920	1580	1710
Controlled flow Free flow	Sonic conductance dm ² /(s·bar)	0.28	0.50	0.64	0.72	1.1	1.3	1.8	2.2	2.6	4.4	4.8
	Critical pressure ratio	Controlled flow	0.2	0.25	0.3	0.3	0.3	0.25	0.25	0.25	0.25	0.25
	Free flow	0.4	0.2	0.3	0.3	0.3	0.2	0.2	0.2	0.2	0.3	

Note) Supply pressure: 0.5 MPa, Temperature: 20°C.

Needle Valve / Flow Rate Characteristics

**10-AS12□1FG
10-AS13□1FG**

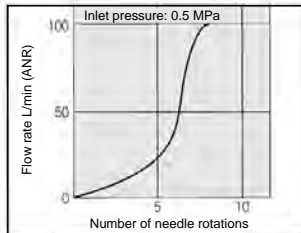

**10-AS22□1FG-01
10-AS23□1FG-01**

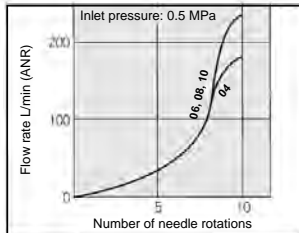

**10-AS22□1FG-02
10-AS23□1FG-02**

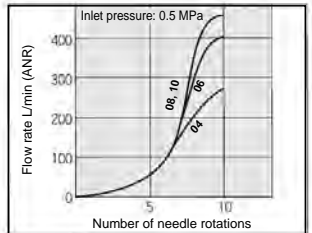

**10-AS32□1FG
10-AS33□1FG**

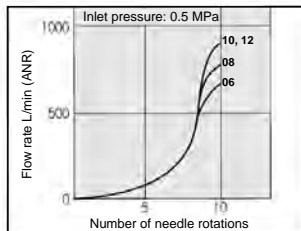

**10-AS42□1FG
10-AS43□1FG**

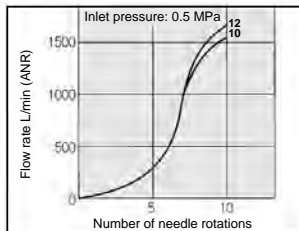

Dimensions / Elbow Type

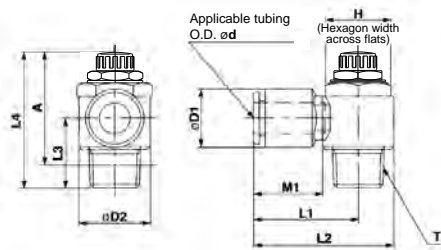

M5 type

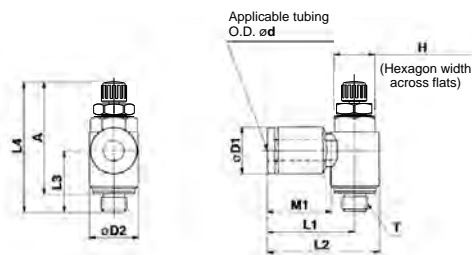

Model	d	T	H	D1	D2	L1	L2	L3	L4		A *		M1	Weight (g)	
									MAX.	MIN.	MAX.	MIN.			
10-AS12□1FG-M5-23	3.2	M5 x 0.8	8	8.4	9.6	17.3	22.1	12.3	28.6	25.8	25	22.2	12.7	7	
10-AS12□1FG-M5-04	4			9.3											
10-AS12□1FG-M5-06	6			11.6											
10-AS22□1FG-01-23	3.2	R1/8	12	9.3	14.2	20.4	27.5	14.3	36.1	31.1	32.1	27.1	12.7	16	
10-AS22□1FG-01-04	4			11.6									13.5	17	
10-AS22□1FG-01-06	6			15.2									18.5	19	
10-AS22□1FG-01-08	8			18.5		33.1	40.2	15					21	21	
10-AS22□1FG-02-04	4	R1/4	17	10.4	18.5	25.2	34.4	18.2	40.4	35.4	34.4	29.4	16	32	
10-AS22□1FG-02-06	6			12.8									17	34	
10-AS22□1FG-02-08	8			15.2									36.4	34	
10-AS22□1FG-02-10	10			18.5		35.3	44.5	20					21	36	
10-AS32□1FG-02-06	6	R1/4	19	12.8	23	27.8	39.3	21.8	48.8	43.8	42.8	37.8	17	60	
10-AS32□1FG-02-08	8			15.2									29.5	41	63
10-AS32□1FG-02-10	10			18.5									31.8	43.3	67
10-AS32□1FG-02-12	12			20.9		32.8	44.3						22	69	
10-AS32□1FG-03-06	6	R3/8	19	12.8	23	27.8	39.3	20.9	46.5	41.5	40.2	35.2	17	55	
10-AS32□1FG-03-08	8			15.2									29.5	41	57
10-AS32□1FG-03-10	10			18.5									31.8	43.3	59
10-AS32□1FG-03-12	12			20.9		32.8	44.3						22	61	
10-AS42□1FG-04-10	10	R1/2	24	18.5	28.6	33.6	47.9	25.4	57.6	50.1	49.6	42.1	21	100	
10-AS42□1FG-04-12	12			20.9									34.6	48.9	22

* Reference thread dimensions after being screwed in.

Dimensions / Universal Type

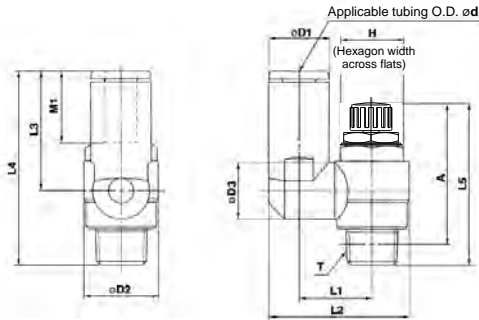

M5 type

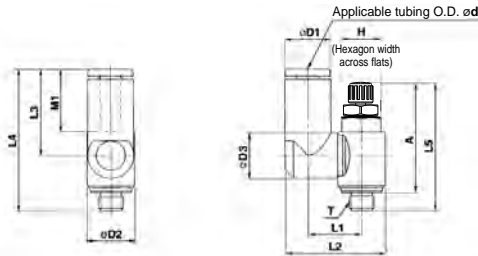

Model	d	T	H	D1	D2	D3	L1	L2	L3	L4	L5		A *		M1	Weight (g)			
											MAX.	MIN.	MAX.	MIN.					
10-AS13□1FG-M5-23	3.2	M5 x 0.8	8	8.4	9.6	9.3	10.8	19.8	17.5	28.7	28.6	25.8	25	22.2	12.7	7			
10-AS13□1FG-M5-04	4			9.3				20.3											
10-AS13□1FG-M5-06	6			11.6				21.4									20.6		
10-AS23□1FG-01-23	3.2	R1/8	12	8.4	14.2	10.9	14	24.4	17.5	31.8	36.1	31.1	32.1	27.1	12.7	17			
10-AS23□1FG-01-04	4			9.3				24.9											
10-AS23□1FG-01-06	6			11.6				26.9									22.9	37.2	
10-AS23□1FG-01-08	8	R1/4	17	15.2	18.5	12.9	16.2	30.9	28.2	41.7	40.4	35.4	34.4	29.4	18.5	21			
10-AS23□1FG-02-04	4			10.4				30.6									21.9	40.1	
10-AS23□1FG-02-06	6			12.8				34									25.2	42.6	
10-AS23□1FG-02-08	8	R1/4	19	15.2	23	16.2	20.6	18.3	35.2	28.2	45.6	48.8	43.8	42.8	37.8	17	33		
10-AS23□1FG-02-10	10			18.5				39.7										28.2	50
10-AS33□1FG-02-06	6			12.8				38.5										25.2	47
10-AS33□1FG-02-08	8	R3/8	19	15.2	23	12.9	20.6	43.7	32.6	54.4	46.5	41.5	40.2	35.2	18.5	63			
10-AS33□1FG-02-10	10			18.5				39.7									28.2	49.1	
10-AS33□1FG-02-12	12			20.9				44.9									34.4	56.2	
10-AS33□1FG-03-06	6	R1/2	24	12.8	28.6	16.2	25.8	38.5	25.2	46.1	57.6	50.1	49.6	42.1	17	56			
10-AS33□1FG-03-08	8			15.2				39.7									28.2	49.1	
10-AS33□1FG-03-10	10			18.5				43.7									32.6	53.5	
10-AS33□1FG-03-12	12	R1/2	24	20.9	28.6	16.2	23	44.9	34.4	55.3	57.6	50.1	49.6	42.1	22	65			
10-AS43□1FG-04-10	10			18.5				49.4									32.6	58	
10-AS43□1FG-04-12	12			20.9				19.4									26.8	52	36.3

* Reference thread dimensions after M5 x 0.8, R thread being screwed in.

Directional Control Valves
Air Cylinders
Rotary Actuators
Air Grippers
Air Preparation Equipment
Modular F. R.
Pressure Control Equipment
Fittings & Tubing
Flow Control Equipment
Pressure Switches/ Pressure Sensors

Series 10-AS-FG

Stainless Steel Speed Controller with One-touch Fittings (Inline type)

How to Order

10 — AS 200 1 F G — 06

Clean series •

Body size •

100	M5 standard
200	1/8 standard
205	1/4 standard
300	3/8 standard
400	1/2 standard

With One-touch fitting •

Stainless steel specifications (Stainless steel 303) •

Lock nut option

Nil	Hexagon lock nut
J	Round lock nut

Applicable tubing O.D. (Note)

Metric size

23	ø3.2*
04	ø4
06	ø6
08	ø8
10	ø10
12	ø12

Note) Refer to the following Model list for selection of applicable tubing O.D.
* ø1/8" tubing should be used.



Model

Model	Applicable tubing O.D.					
	Metric size					
	3.2	4	6	8	10	12
10-AS1001FG	●	●	●			
10-AS2001FG		●	●			
10-AS2051FG			●	●		
10-AS3001FG			●	●	●	●
10-AS4001FG					●	●

Specifications

Proof pressure	1.5 MPa
Max. operating pressure	1 MPa
Min. operating pressure	0.1 MPa
Ambient and fluid temperature	-5 to 60°C (No freezing)
Applicable tubing material	Polyurethane ^{Note 1)}
Grease	Fluorine grease
Cleanliness class (ISO class)	Class 5

Note 1) The maximum operating pressure for polyurethane (at 20°C) is 0.8 MPa.
(Refer to the **WEB catalog** for details.)

Flow Rate and Sonic Conductance

Model		10-AS1001FG	10-AS2001FG		10-AS2051FG		10-AS3001FG			10-AS4001FG	
Tubing O.D.	Metric size	ø3.2 ø4 ø6	ø4	ø6	ø6	ø8	ø6	ø8	ø10 ø12	ø10	ø12
Controlled flow	Flow rate L/min (ANR)	100	130	230	290	460	420	660	920	1050	1390
	Sonic conductance dm ³ /(s·bar)	0.28	0.36	0.64	0.8	1.3	1.2	1.8	2.6	2.9	3.9
Critical pressure ratio	Controlled flow	0.2	0.2	0.2	0.2	0.2	0.2	0.2	0.2	0.2	0.2
	Free flow	0.25	0.25	0.25	0.25	0.25	0.25	0.25	0.25	0.25	0.25

Note) Supply pressure: 0.5 MPa, Temperature: 20°C.

Needle Valve / Flow Rate Characteristics

10-AS1001FG

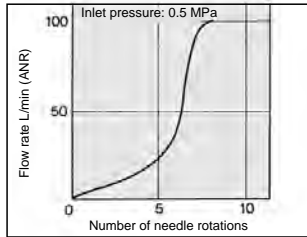

10-AS2001FG

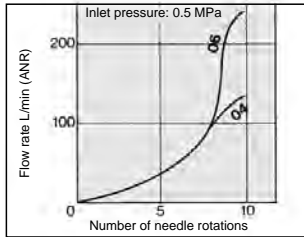

10-AS2051FG

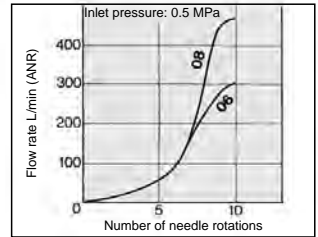

10-AS3001FG

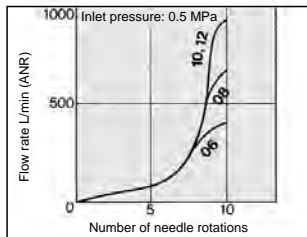

10-AS4001FG

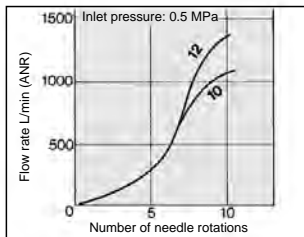

Directional Control Valves
 Air Cylinders
 Rotary Actuators
 Air Grippers
 Air Preparation Equipment
 Modular F. R.
 Pressure Control Equipment
 Fittings & Tubing
 Flow Control Equipment
 Pressure Switches/ Pressure Sensors

Dimensions

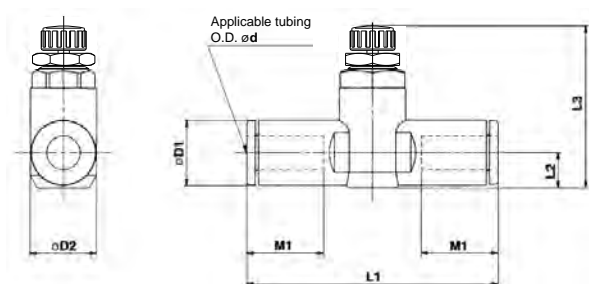

Model	d	D1	D2	L1	L2	L3		M1	Weight (g)
						MAX.	MIN.		
10-AS1001FG-23	3.2	8.4	10	38	4.5	23.5	20.7	12.7	6
10-AS1001FG-04	4	9.3		39.2	5.2	24.2	21.4		7
10-AS1001FG-06	6	11.6		40.7	6.2	25.2	22.4	13.5	8
10-AS2001FG-04	4	9.3	11.8	44.8	5.2	32.6	27.6	12.7	12
10-AS2001FG-06	6	11.6			6.3	33.7	28.7	13.5	13
10-AS2051FG-06			12.8	14.8	53.2	6.7	35.2	30.2	17
10-AS2051FG-08	8	15.2	59.8		8.1	32.6	27.6	18	31
10-AS3001FG-06	6	12.8	19.8	59	7.4	38.3	33.3	17	18
10-AS3001FG-08	8	15.2		64.4	8.2	39.1	34.1	18	21
10-AS3001FG-10	10	18.5		71.6	9.8	40.6	35.6	21	32
10-AS3001FG-12	12	20.9		76	11	41.8	36.8	22	33
10-AS4001FG-10	10	18.5	26.5	82	11.3	51.1	43.6	21	36
10-AS4001FG-12	12	20.9				52.1	44.6	22	40

Series 10-ASD-FG

Stainless Steel Dual Speed
Controller with One-touch Fittings

How to Order

RoHS

10 – ASD **3** **3** **0** **F** **G** – **01** – **06** **S** –

Clean series

Body size

2	M5 standard
3	1/8 standard
4	1/4 standard
5	3/8 standard
6	1/2 standard

Type

3	Universal
---	-----------

With One-touch fitting

Stainless steel specifications (Stainless steel 303)

Lock nut option

Nil	Hexagon lock nut
J	Round lock nut

With sealant
* Sealant is not available with the M5 type.

Applicable tubing O.D. (Note)
Metric size

04	ø4
06	ø6
08	ø8
10	ø10
12	ø12

Note) Refer to the following Model list for selection of applicable tubing O.D.
* ø1/8" tubing should be used.

Port size

M5	M5 x 0.8
01	1/8
02	1/4
03	3/8
04	1/2



Model

Model	Port size	Applicable tubing O.D.				
		Metric size				
		4	6	8	10	12
10-ASD230FG-M5	M5 x 0.8	●	●			
10-ASD330FG-01	R1/8		●	●		
10-ASD430FG-02	R1/4		●	●	●	
10-ASD530FG-02	R1/4		●	●	●	●
10-ASD530FG-03	R3/8		●	●	●	●
10-ASD630FG-04	R1/2				●	●

Directional Control Valves

Air Cylinders

Rotary Actuators

Air Grippers

Air Preparation Equipment

Modular F. R.

Pressure Control Equipment

Fittings & Tubing

Flow Control Equipment

Pressure Switches/ Pressure Sensors

Specifications

Proof pressure	1.5 MPa
Max. operating pressure	1 MPa
Min. operating pressure	0.1 MPa
Ambient and fluid temperature	-5 to 60°C (No freezing)
Applicable tubing material	Polyurethane ^{Note 1)}
Grease	Fluorine grease
Cleanliness class (ISO class)	Class 5

Note 1) The maximum operating pressure for polyurethane (at 20°C) is 0.8 MPa.
(Refer to the **WEB catalog** for details.)

Flow Rate and Sonic Conductance

Model		10-ASD230FG	10-ASD330FG	10-ASD430FG		10-ASD530FG			10-ASD630FG	
Tubing O.D.	Metric size	ø4, ø6	ø6, ø8	ø6	ø8, ø10	ø6	ø8	ø10, ø12	ø10	ø12
Controlled flow	Flow rate L/min (ANR)	75	175	295	350	500	600	700	1200	1300
Free flow	Sonic conductance dm ³ /(s·bar)	0.21	0.49	0.82	0.97	1.4	1.7	1.9	3.3	3.6
Critical pressure ratio	Controlled flow	0.25	0.2	0.2		0.2			0.2	
	Free flow	0.3	0.15	0.15		0.15			0.15	

Note) Supply pressure: 0.5 MPa, Temperature: 20°C.

Needle Valve / Flow Rate Characteristics

10-ASD230FG

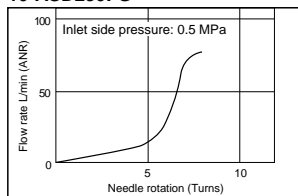

10-ASD330FG

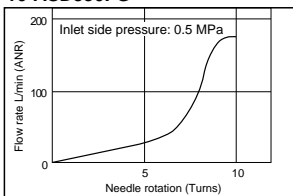

10-ASD430FG

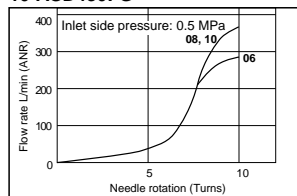

10-ASD530FG

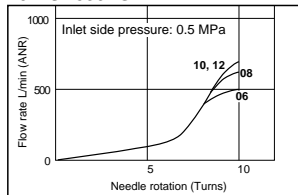

10-ASD630FG

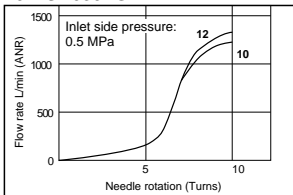

Dimensions

10-ASD230FG

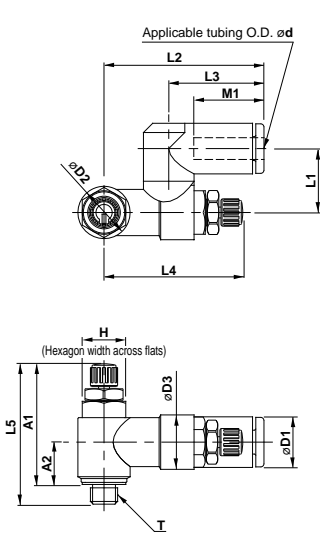

10-ASD330FG/430FG
10-ASD530FG/630FG

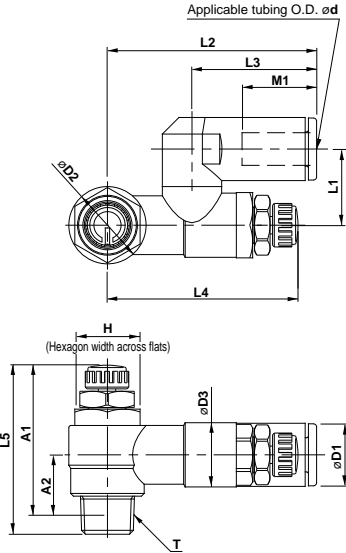

Model	d	T	H	D1	D2	D3	L1	L2	L3	L4		L5		A1*		A2*	M1
										MAX.	MIN.	MAX.	MIN.	MAX.	MIN.		
10-ASD230FG-M5-04	4	M5 x 0.8	8	9.3	9.6	10	11.7	29.4	17.5	28.3	25.5	28.6	25.8	25	22.2	7.8	12.7
10-ASD230FG-M5-06	6			11.6				20.6	13.5								
10-ASD330FG-01-06S	6	R1/8	12	15.2	14.2	11.8	14	38.5	22.9	39.6	34.6	36.1	31.1	32.1	27.1	10.6	18.5
10-ASD330FG-01-08S	8			15.2				28.2	18.5								
10-ASD430FG-02-06S	6	R1/4	17	12.8	18.5	15	18	43.5	25.2	41.7	36.7	40.4	35.4	34.4	29.4	11	17
10-ASD430FG-02-08S	8			15.2				28.2	18.5								
10-ASD430FG-02-10S	10			18.5			19.7	49.3	31								21
10-ASD530FG-02-06S	6	R1/4	19	12.8	23	19.8	20.3	48.3	25.2	46.9	41.9	48.8	43.8	42.8	37.8	15.4	17
10-ASD530FG-02-08S	8			15.2				28.2	18.5								
10-ASD530FG-02-10S	10			18.5			23.1	54.1	32.6								18.5
10-ASD530FG-02-12S	12			20.9			23.1	55.9	34.4								22
10-ASD530FG-03-06S	6	R3/8	19	12.8	23	19.8	20.3	48.3	25.2	46.9	41.9	48.8	43.8	42.8	37.8	15.4	17
10-ASD530FG-03-12S	8			15.2				28.2	18.5								
10-ASD530FG-03-08S	8			15.2			23.1	51.3	28.2					40	35	14	18.5
10-ASD530FG-03-10S	10			18.5			23.1	54.1	32.6								21
10-ASD530FG-03-12S	12			20.9			23.1	55.9	34.4								22
10-ASD630FG-04-10S	10	R1/2	24	18.5	28.6	26.5	25.9	64.3	32.6	64.8	57.3	57.6	50.1	49.6	42.1	18.6	21
10-ASD630FG-04-12S	12			20.9				34.4	18.6								

* Reference thread dimensions after R thread being screwed in.

Directional Control Valves

Air Cylinders

Rotary Actuators

Air Grippers

Air Preparation Equipment

Modular F. R.

Pressure Control Equipment

Fittings & Tubing

Flow Control Equipment

Pressure Switches/ Pressure Sensors



Series ASD-FG Specific Product Precautions

Be sure to read this before handling. Refer to page 1382 for Safety Instructions and pages 1305 to 1308 for Flow Control Equipment Precautions.

Design / Selection

⚠ Caution

1. Single acting cylinder

When controlling a single acting cylinder, the cylinder's return speed will differ depending on the operating conditions. Operate after confirming the maximum return speeds shown in the table below.

Speed Controller	Cylinder	Solenoid valve	Tubing	Silencer	Maximum return speed (mm/s)		
					100	200	300
ASD230FG	CJ2	SYJ500	TU0604 1 m	AN110-01	ø6		
					ø10		
					ø16		
ASD330FG	CM2	SYJ700	TU0604 1 m	AN110-01	ø20		
					ø25		
					ø32		

* Values at 0.5 MPa and 20°C.

<Operating conditions>

- Cylinder extension speed: 100 mm/s
- Meter-out needle fully open

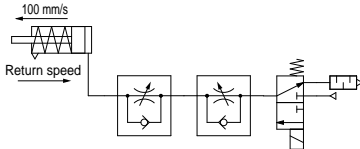

(Reference) Recommended circuit for high return speed

When low extension speed and high return speed are desired, the following circuit using 3-port is recommended.

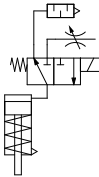

Note) Use the AS-FG series with -X214 for the throttle valve.

Series 10-AS

Speed Controller
Cylinder Direct Mount Type/Metal Elbow Type
10-AS1200, 2200, 3200, 4200

RoHS

How to Order

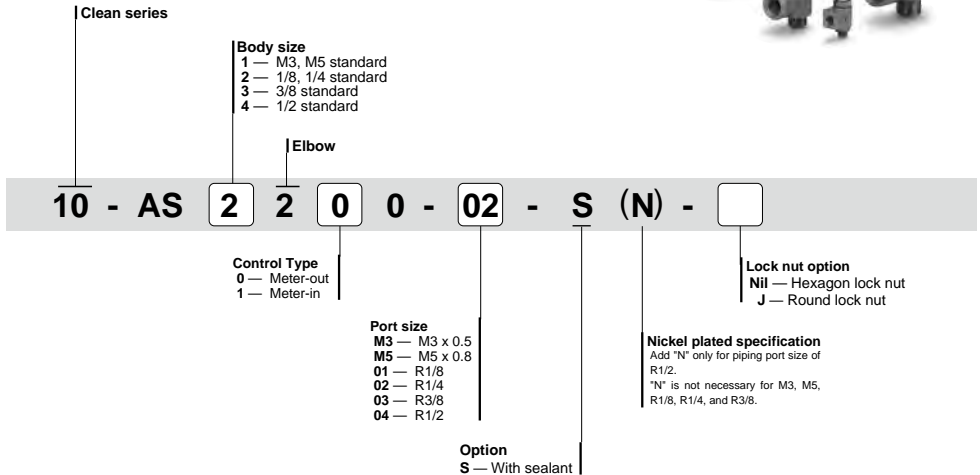

Specifications

Model	10-AS1200-M3	10-AS1200-M5	10-AS2200-01	10-AS2200-02	10-AS3200-03	10-AS4200-04	
Port size	M3 x 0.5	M5 x 0.8	R1/8, Rc1/8	R1/4, Rc1/4	R3/8, Rc3/8	R1/2, Rc1/2	
Proof pressure	1.05 MPa		1.5 MPa				
Max. operating pressure	0.7 MPa		1 MPa				
Min. operating pressure	0.1 MPa		0.1 MPa				
Ambient and fluid temperature	-5 to 60°C (No freezing)						
Option	Round lock nut		With sealant, round lock nut, nickel plated type				
Weight (g)	3	10	29	64	106	181	
Grease	Fluorine grease						
Cleanliness class (ISO class)	Class 3						
Controlled flow	Flow rate L/min (ANR)	20	105	230	460	920	1700
Free flow	Sonic conductance dm ³ /(s·bar)	0.06	0.32	0.7	1.4	2.8	5.2
Critical pressure ratio	Controlled flow	0.2	0.2	0.25	0.3	0.25	0.25
	Free flow	0.4	0.4	0.2	0.3	0.2	0.3

Note 1) Supply pressure: 0.5 MPa. Temperature: 20°C.

Note 2) A meter-in type is not available with AS1200-M3.

Note 3) Visual distinction between meter-out and meter-in types

The meter-out and meter-in types can be visually determined by the lock nut.

The hexagon lock nut on the meter-out type is zinc chromated, while the meter-in type is black zinc chromated.

The round lock nut on the meter-out type is electroless nickel plated, while the meter-in type is black zinc chromated.

Needle Valve / Flow Rate Characteristics

10-AS1200-M3

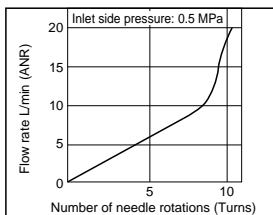

10-AS12□0-M5

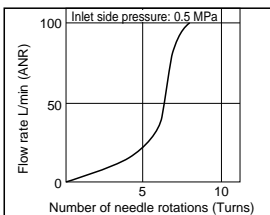

10-AS22□0-01

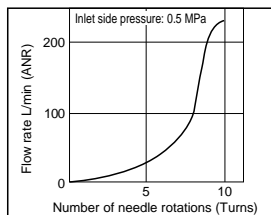

10-AS22□0-02

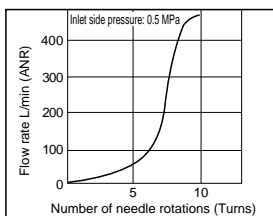

10-AS32□0

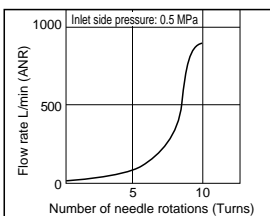

10-AS42□0

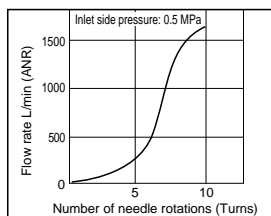

Dimensions

10-AS1200-M3
10-AS12□0-M5

10-AS22□0/32□0/42□0

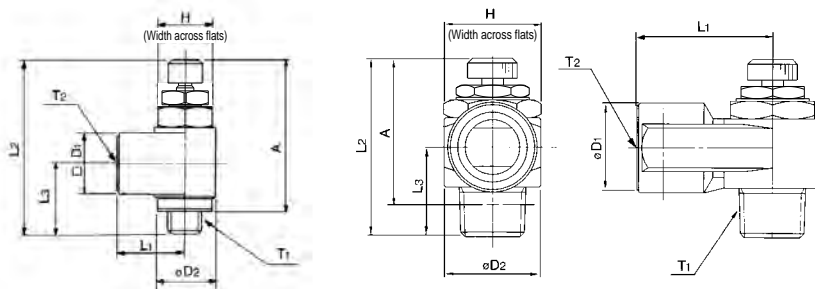

Dimensions

Model	T1	T2	H	L1	L2		L3	D1	D2	A	
					MAX.	MIN.				MAX.	MIN.
10-AS1200-M3	M3 x 0.5	M3 x 0.5	4.5	6.6	23.5	21.5	8	5	5	20.5	18.5
10-AS12□0-M5	M5 x 0.8	M5 x 0.8	8	10	28.3	25.5	10.3	9	9	25	22.2
10-AS22□0-01	R1/8	Rc1/8	12	18	36.4	31.4	14.1	14.3	14.6	32.4	27.4
10-AS22□0-02	R1/4	Rc1/4	17	27.2	40.8	35.8	18	18	19.5	34.8	29.8
10-AS32□0-03	R3/8	Rc3/8	19	30	46.9	41.9	20.8	22.5	24.3	40.6	35.6
10-AS42□0-04	R1/2	Rc1/2	24	38.5	55.6	50.6	26.7	27.5	28.5	47.4	42.4

Series 10-AS

Speed Controller/In-line Type
10-AS1000, 2000, 3000, 4000, 5000

RoHS

How to Order



Clean series

Body size

1	M3, M5 standard
2	1/8, 1/4 standard
3	3/8 standard
4	1/2 standard
5	1/2 standard

In-line type

10 - AS 1 000 - M5 -

Port size

Port size	Applicable series
M3	M3 x 0.5
M5	M5 x 0.8
01	Rc1/8
02	Rc1/4
03	Rc3/8
04	Rc1/2

Lock nut option

Nil	Hexagon lock nut
J	Round lock nut

Note) The round lock nut option is only for AS1000.

Model/Flow Rate and Sonic Conductance

Model	Port size	Free flow			Controlled flow			Weight (g)
		Flow rate L/min (ANR)	Sonic conductance dm ³ /(s·bar)	Critical pressure ratio	Flow rate L/min (ANR)	Sonic conductance dm ³ /(s·bar)	Critical pressure ratio	
10-AS1000-M3	M3 x 0.5	20	0.06	0.15	20	0.06	0.2	4.7
10-AS1000-M5	M5 x 0.8	90	0.25		80	0.22		33
10-AS2000-01	1/8	340	0.94		250	0.7		90
10-AS2000-02	1/4	340	0.94		250	0.7		115
10-AS3000-02	1/4	810	2.3	0.35	810	2.3	0.2	130
10-AS3000-03	3/8	810	2.3		810	2.3		124
10-AS4000-02	1/4	1,670	4.6		1,670	4.6		221
10-AS4000-03	3/8	1,670	4.6		1,670	4.6		214
10-AS4000-04	1/2	1,670	4.6		1,670	4.6		205
10-AS5000-02	1/4	2,840	7.9		2,840	7.9		242
10-AS5000-03	3/8	4,270	11.9	0.2	4,270	11.9	0.2	233
10-AS5000-04	1/2	4,270	11.9		4,270	11.9		224

Note) Supply pressure: 0.5 MPa, Temperature: 20°C.

Specifications

Proof pressure ^{Note)}	1.5 MPa (1.05 MPa)
Operating pressure range ^{Note)}	0.05 to 1.0 MPa (0.1 to 0.7 MPa)
Ambient and fluid temperature	-5 to 60°C (No freezing)
Grease	Fluorine grease
Cleanliness class (ISO class)	Class 3

Note) Descriptions in parentheses are for 10-AS1000.

Directional Control Valves

Air Cylinders

Rotary Actuators

Air Grippers

Air Preparation Equipment

Modular F. R.

Pressure Control Equipment

Fittings & Tubing

Flow Control Equipment

Pressure Switches/Pressure Sensors

Needle Valve / Flow Rate Characteristics

10-AS1000-M3

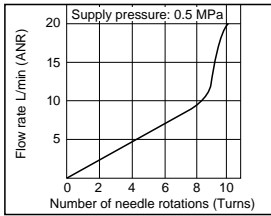

10-AS1000-M5

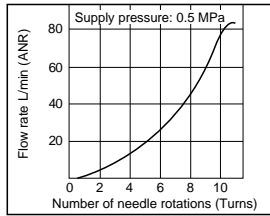

10-AS2000

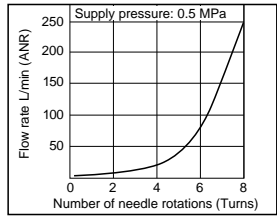

10-AS3000

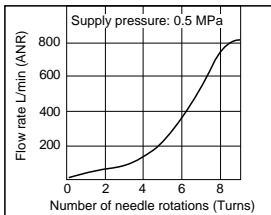

10-AS4000

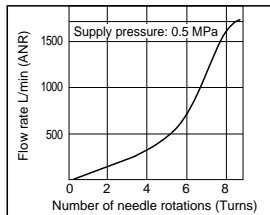

10-AS5000

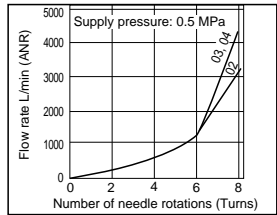

Dimensions

10-AS1000-M3

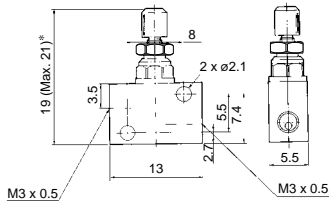

* Reference dimensions

10-AS1000-M5

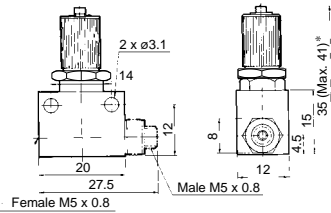

* Reference dimensions

10-AS2000/3000

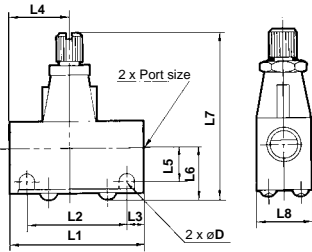

10-AS4000

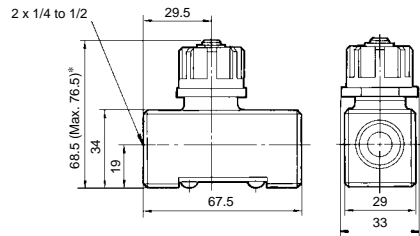

Dimensions

Model	Port size	L1	L2	L3	L4	L5	L6	L7 MAX. MIN.	L8	D	
10-AS2000-01	Rc1/8	40	30	5	17	10	15.5	54.5	50	16	4.5
10-AS2000-02	Rc1/4				23	11.5	17	56	51.5	20	
10-AS3000-02/03	Rc1/4, Rc3/8	56	45.5	5.25	25	13.2	20.6	68	61	26	5.5

10-AS5000

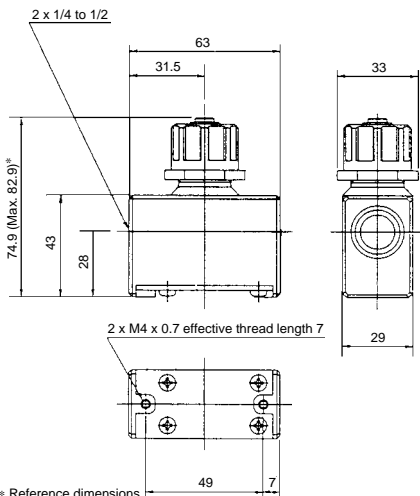

* Reference dimensions

* Reference dimensions

2 x M4 x 0.7
Effective thread length 6

Directional Control Valves

Air Cylinders

Rotary Actuators

Air Grippers

Air Preparation Equipment

Modular F. R.

Pressure Control Equipment

Fittings & Tubing

Flow Control Equipment

Pressure Switches/ Pressure Sensors

Series (21-)AS-FPQ/FPG

Clean Speed Controller with One-touch Fittings (Elbow type)

RoHS

How to Order

AS 2 2 1 1 F P G 01 06
21 - AS 2 2 1 1 F P Q 01 06

• Metal part material

Q	Brass (Electroless nickel plated)
G	Stainless steel (Stainless steel 304)

• Lock nut option

Nil	Hexagon lock nut
J	Round lock nut

• Body size

1	M5 standard
2	1/8, 1/4 standard
3	3/8 standard
4	1/2 standard

• Type

2	Elbow
---	-------

• Control type

0	Meter-out
1	Meter-in

• Applicable tubing O.D. (mm) ^(Note)
Metric size

04	ø4
06	ø6
08	ø8
10	ø10
12	ø12

(Note) Refer to the following Model list for selection of applicable tubing O.D.

• Connection port size

M5	M5 x 0.8
01	R1/8
02	R1/4
03	R3/8
04	R1/2

• Metal part material

Q	Brass (Electroless nickel plated)
---	-----------------------------------

Copper, fluorine and silicone-free + Low particle generation

AS-FPQ / Brass (Electroless nickel plated)
 Release button color: Light gray



With One-touch fittings

Clean specification

AS-FPG / Stainless steel (Stainless steel 304)
 Release button color: Light blue



Model

Elbow type	Connection port size	Applicable tubing O.D. (mm)				
		4	6	8	10	12
(21-) AS12□1FP□-M5	M5 x 0.8	●	●			
(21-) AS22□1FP□-01	R1/8	●	●	●		
(21-) AS22□1FP□-02	R1/4	●	●	●	●	
(21-) AS32□1FP□-03	R3/8		●	●	●	●
(21-) AS42□1FP□-04	R1/2				●	●

Specifications

Proof pressure (20°C)	1.5 MPa
Max. operating pressure (20°C)	1 MPa ^{Note 1)}
Min. operating pressure	0.1 MPa
Ambient and fluid temperature	-5 to 60°C (No freezing)
Grease	Fluorine grease 21-: Lithium soap based grease
Cleanliness class (ISO class)	Class 3

Note 1) The maximum operating pressure is the value at 20°C. Refer to operating pressure curve for values at other temperatures.

Flow Rate and Sonic Conduction

Model		(21-)AS12□1FP□-M5	(21-)AS22□1FP□-01		(21-)AS22□1FP□-02			(21-)AS32□1FP□-03			(21-)AS42□1FP□-04	
Tubing O.D.	Metric size	ø4	ø4	ø6	ø4	ø6	ø8	ø6	ø8	ø10	ø10	ø12
Controlled flow	Flow rate L/min (ANR)	100	180	230	260	390	460	660	790	920	1580	1710
	Sonic conduction $\frac{dm^3}{(s \cdot bar)}$	0.28	0.5	0.64	0.72	1.1	1.3	1.8	2.2	2.6	4.4	4.8
Critical pressure ratio	Controlled flow	0.2	0.25		0.3			0.25			0.25	
	Free flow	0.4	0.2		0.3			0.2			0.3	

Note) Flow rate values are measured at 0.5 MPa and 20°C.

Relationship Between Operating Temperature and Maximum Operating Pressure

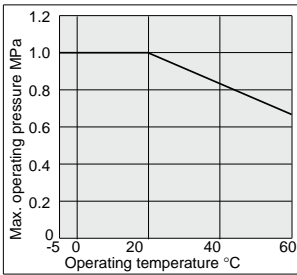

Recommended Applicable Tubing

Tubing material	Clean series polyurethane tubing: 10-series
Tubing O.D.	ø4, ø6, ø8, ø10, ø12

Polyurethane tubing: TU series, Nylon tubing: T series
Soft nylon tubing TS series can also be used. However, the degree of cleanliness will decline.

Needle Valve / Flow Rate Characteristics

(21-)AS12□1FP□-M5

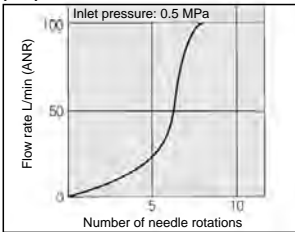

(21-)AS22□1FP□-01

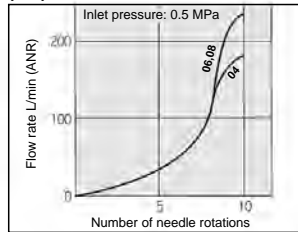

(21-)AS22□1FP□-02

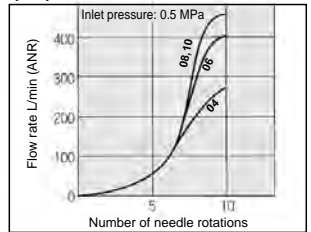

(21-)AS32□1FP□-03

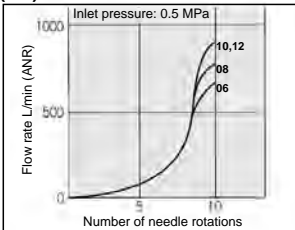

(21-)AS42□1FP□-04

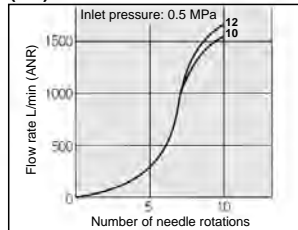

Directional Control Valves
 Air Cylinders
 Rotary Actuators
 Air Grippers
 Air Preparation Equipment
 Modular F. R.
 Pressure Control Equipment
 Fittings & Tubing
 Flow Control Equipment
 Pressure Switches/ Pressure Sensors

Dimensions

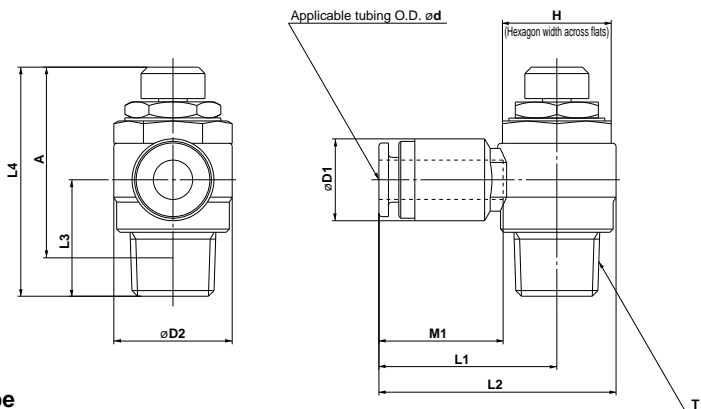

M5 type

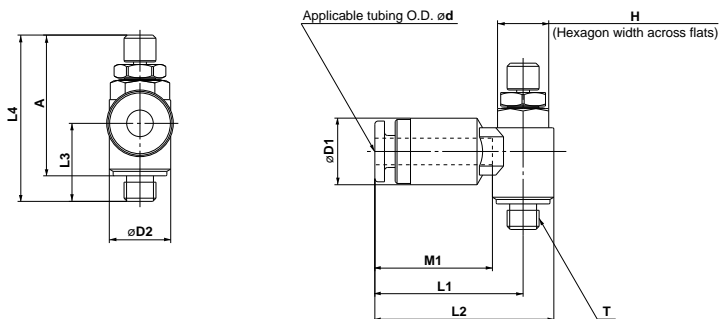

Model	Tubing O.D. d	T	H	D1	D2	L1	L2	L3	L4		A ^{Note 1)}		M1	Weight (g) ^{Note 2)}	
									MAX.	MIN.	MAX.	MIN.		* 1	* 2
(21-) AS12□1FP□-M5-04	4	M5 x 0.8	8	10.4	9.6	23.2	28	12.2	28.3	25.5	25	22.2	18.4	7	7
(21-) AS12□1FP□-M5-06	6			24.2		29	19.4						8	8	
(21-) AS22□1FP□-01-04	4	R1/8	12	10.4	14.2	25.3	32.4	14.3	36.4	31.4	32.4	27.4	18.4	17	17
(21-) AS22□1FP□-01-06	6			26.3		33.4	19.4						18	18	
(21-) AS22□1FP□-01-08	8			15.2		28.5	35.6						21.9	20	20
(21-) AS22□1FP□-02-04	4	R1/4	17	10.4	18.5	27.8	37	18.2	40.8	35.8	34.8	29.8	18.4	33	33
(21-) AS22□1FP□-02-06	6			30.4		39.6	19.4								
(21-) AS22□1FP□-02-08	8			34.6		44.4	21.9	35					35		
(21-) AS22□1FP□-02-10	10			38.3		47.5	23.8	38					38		
(21-) AS32□1FP□-03-06	6	R3/8	19	12.8	23	30.4	41.9	20.9	46.9	41.9	40.6	35.6	19.4	59	55
(21-) AS32□1FP□-03-08	8			32.9		44.4	21.9						61		
(21-) AS32□1FP□-03-10	10			34.6		46.1	23.8	63					59		
(21-) AS32□1FP□-03-12	12			35.8		47.3	25	65					61		
(21-) AS42□1FP□-04-10	10	R1/2	24	18.5	28.6	36.6	50.9	25.4	55.6	50.6	47.4	42.4	23.8	107	100
(21-) AS42□1FP□-04-12	12			38.2		52.5	25						109	102	

Note 1) Reference dimensions of threads after installation.

Note 2) * 1 is the weight of type (21-)AS□2□1FPQ (Brass + Electroless nickel plated). * 2 is the weight of type AS□2□1FPG (SUS304).

Series 10-AS-FM

Speed Controller for Low Speed Operation with One-touch Fittings (Elbow type/Universal type)



How to Order

10 - AS 2 2 1 1 FM - 01 - 06

Clean series

Body size

1	M5 standard
2	1/8, 1/4 standard

Type

2	Elbow
3	Universal

Control type

0	Meter-out
1	Meter-in

With One-touch fitting

For low speed operation

Lock nut option

Nil	Hexagon lock nut
J	Round lock nut

Option

Nil	None
S	With sealant

* Sealant is not available with the M5 type.

Applicable tubing O.D. (Note)

Metric size

23	ø3.2 *
04	ø4
06	ø6
08	ø8
10	ø10

Note) Refer to the following Model list for selection of applicable tubing O.D.
* ø1/8" tubing should be used.

Port size

M5	M5 x 0.8
01	R1/8
02	R1/4

Directional Control Valves

Air Cylinders

Rotary Actuators

Air Grippers

Air Preparation Equipment

Modular F. R.

Pressure Control Equipment

Fittings & Tubing

Flow Control Equipment

Pressure Switches/ Pressure Sensors

Model

Elbow type	Universal type	Port size	Applicable tubing O.D.				
			Metric size				
			3.2	4	6	8	10
10-AS12□1FM-M5	10-AS13□1FM-M5	M5 x 0.8	●	●	●		
10-AS22□1FM-01	10-AS23□1FM-01	R1/8	●	●	●	●	
10-AS22□1FM-02	10-AS23□1FM-02	R1/4		●	●	●	●

Specifications

Proof pressure	1.5 MPa
Max. operating pressure	1.0 MPa
Min. operating pressure	0.1 MPa
Ambient and fluid temperature	-5 to 60°C (No freezing)
Applicable tubing material	Polyurethane ^{Note 1)}
Option ^{Note 2)}	With sealant
Grease	Fluorine grease
Cleanliness class (ISO class)	Class 5

Note 1) The maximum operating pressure for polyurethane (at 20 °C) is 0.8 MPa.
(Refer to the **WEB catalog** for details.)

Note 2) Sealant is not available in case of types with M5 port.

* Brass parts are all electroless nickel plated.

* The knob of the M5 type and the lock nut of the meter-in type are black zinc chromated.

Flow Rate and Sonic Conductance

Model		10-AS12□1FM 10-AS13□1FM	10-AS22□1FM-□01 10-AS23□1FM-□01		10-AS22□1FM-□02 10-AS23□1FM-□02		
Tubing O.D.	Metric size	ø3.2, ø4, ø6	ø3.2, ø4	ø6, ø8	ø4	ø6	ø8, ø10
Controlled flow	Flow rate L/min (ANR)	7	12		38		
	Sonic conductance dm ³ /(s·bar)	0.02	0.04		0.12		
	Critical pressure ratio	0.2	0.25		0.3		
Free flow	Flow rate L/min (ANR)	100	180	230	260	390	460
	Sonic conductance dm ³ /(s·bar)	0.3	0.54	0.7	0.8	1.2	1.4
	Critical pressure ratio	0.4	0.2		0.3		

(Note) Supply pressure: 0.5 MPa, Temperature: 20°C.

Needle Valve / Flow Rate Characteristics

10-AS1201FM, AS1211FM
10-AS1301FM, AS1311FM

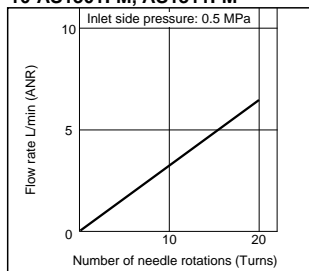

10-AS2201FM-01, AS2211FM-01
10-AS2301FM-01, AS2311FM-01

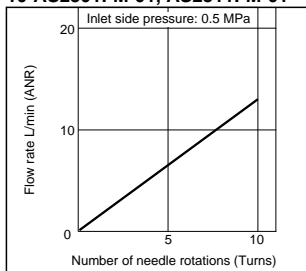

10-AS2201FM-02, AS2211FM-02
10-AS2301FM-02, AS2311FM-02

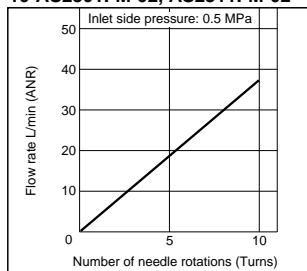

Dimensions / Elbow Type

M5 type

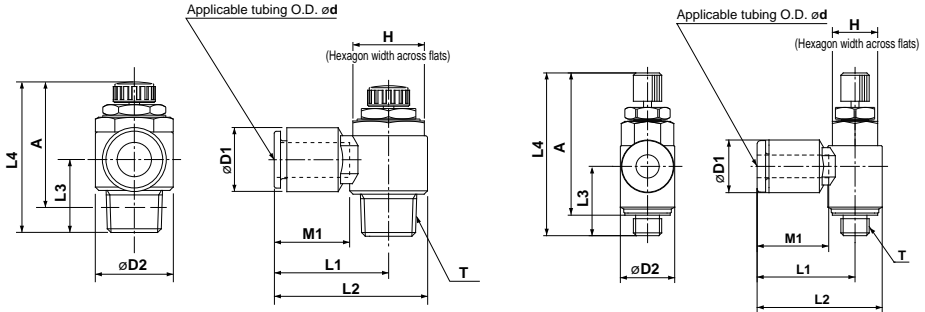

Model	d	T	H	D1	D2	L1	L2	L3	L4		A *		M1	Weight (g)					
									MAX.	MIN.	MAX.	MIN.							
10-AS12□1FM-M5-23	3.2	M5 x 0.8	8	8.4	9.6	17.3	22.1	12.3	33.8	28.8	30.1	25.1	12.7	7					
10-AS12□1FM-M5-04	4			9.3									11.6		13.5				
10-AS12□1FM-M5-06	6			11.6									18.1		22.9	11.7	13.5		
10-AS22□1FM-01-23	3.2	R1/8	12	9.3	14.2	20.4	27.5	14.3	36.1	31.1	32.1	27.1	12.7	17					
10-AS22□1FM-01-04	4			11.6									13.5						
10-AS22□1FM-01-06	6			15.2									18.5						
10-AS22□1FM-01-08	8			25.3									32.4						
10-AS22□1FM-02-04	4			10.4									18.5		20.0	40.4	35.4	34.4	29.4
10-AS22□1FM-02-06	6			12.8									25.2		34.4				
10-AS22□1FM-02-08	8	15.2	27.2	36.4															
10-AS22□1FM-02-10	10	18.5	35.3	44.5	20.0	18.5	34	21.0	36										

* Reference threaded dimensions after being screwed in.

- Directional Control Valves
- Air Cylinders
- Rotary Actuators
- Air Grippers
- Air Preparation Equipment
- Modular F. R.
- Pressure Control Equipment
- Fittings & Tubing
- Flow Control Equipment
- Pressure Switches/ Pressure Sensors

Dimensions / Universal Type

M5 type

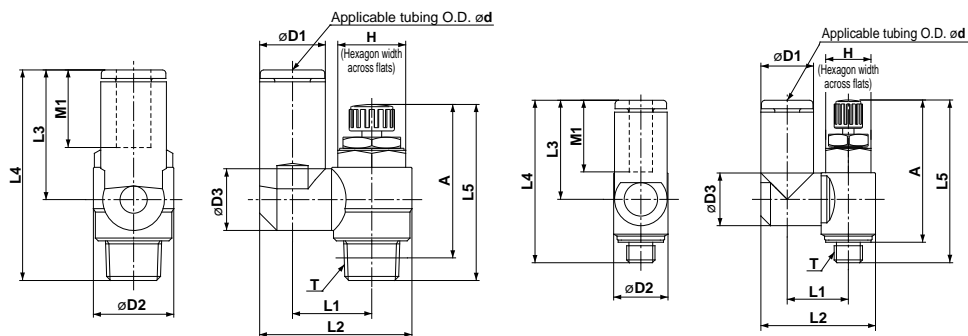

Model	d	T	H	D1	D2	D3	L1	L2	L3	L4	L5		A*		M1	Weight (g)	
											MAX.	MIN.	MAX.	MIN.			
10-AS13□1FM-M5-23	3.2	M5 x 0.8	8	8.4	9.6	9.3	10.8	19.8	17.5	28.7	33.8	28.8	30.1	25.1	12.7	8	
10-AS13□1FM-M5-04	4			9.3				20.3							13.5		
10-AS13□1FM-M5-06	6			11.6				21.4							20.6		
10-AS23□1FM-01-23	3.2	R1/8	12	8.4	14.2	10.9	14	24.4	22.9	37.2	36.1	31.1	32.1	27.1	12.7	17	
10-AS23□1FM-01-04	4			9.3				24.9							17.5		
10-AS23□1FM-01-06	6			11.6				26.9							22.9		
10-AS23□1FM-01-08	8	15.2	12.9	30.9	28.2	41.7	10.9	16.2	30.6	21.9	40.1	40.4	35.4	34.4	29.4	18.5	21
10-AS23□1FM-02-04	4	10.4	18.3	35.2	28.2	45.6										16	
10-AS23□1FM-02-06	6	12.8	18.4	34	25.2	42.6										17	
10-AS23□1FM-02-08	8	15.2	R1/4	17	18.5	12.9	18.3	35.2	28.2	45.6	40.4	35.4	34.4	29.4	18.5	36	
10-AS23□1FM-02-10	10	18.5													20.2		38.7

* Reference thread dimensions after being screwed in.

Series 10-AS-FM

Speed Controller for Low Speed Operation
with One-touch Fittings (In-line type)

How to Order

10 — **AS** **200** **1** **F** **M** — **06**

- Clean series**
- Body size**

100	M5 standard
200	1/8 standard
205	1/4 standard
- With One-touch fittings**
- For low speed control**
- Lock nut option**

Nil	Hexagon lock nut
J	Round lock nut
- Applicable tubing O.D. (Note)**
Metric size

23	ø3.2*
04	ø4
06	ø6
08	ø8

Note) Refer to the following Model list for selection of applicable tubing O.D.
* ø1/8 tubing should be used.



Model

Model	Applicable tubing O.D			
	Metric size			
	3.2	4	6	8
10-AS1001FM	●	●	●	
10-AS2001FM		●	●	
10-AS2051FM			●	●

Directional Control Valves

Air Cylinders

Rotary Actuators

Air Grippers

Air Preparation Equipment

Modular F. R.

Pressure Control Equipment

Fittings & Tubing

Flow Control Equipment

Pressure Switches/
Pressure Sensors

Specifications

Proof pressure	1.5 MPa
Max. operating pressure	1 MPa
Min. operating pressure	0.1 MPa
Ambient and fluid temperature	-5 to 60°C (No freezing)
Applicable tubing material	Polyurethane ^{Note 1)}
Grease	Fluorine grease
Cleanliness class (ISO class)	Class 5

Note 1) The maximum operating pressure for polyurethane (at 20 °C) is 0.8 MPa.

(Refer to the **WEB catalog** for details.)

- * Brass parts are all electroless nickel plated.
- * The knob of the M5 type is black zinc chromated.

Flow Rate and Sonic Conductance

Model		10-AS1001FM		10-AS2001FM		10-AS2051FM	
Tubing O.D.	Metric size	ø3.2, ø4, ø6		ø4	ø6	ø6	ø8
Controlled flow	Flow rate L/min (ANR)	7		12		38	
	Sonic conductance dm ³ /s-bar	0.02		0.04		0.12	
	Critical pressure ratio	0.2		0.2		0.2	
Free flow	Flow rate L/min (ANR)	100	130	230	290	460	460
	Sonic conductance dm ³ /s-bar	0.3	0.4	0.7	0.9	1.4	1.4
	Critical pressure ratio	0.25					

Note) Supply pressure: 0.5 MPa, Temperature: 20°C.

Needle Valve / Flow Rate Characteristics

10-AS1001FM

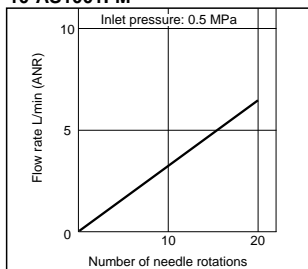

10-AS2001FM

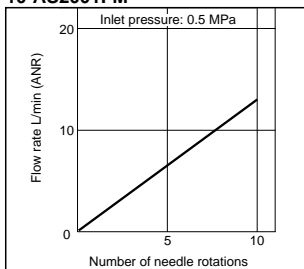

10-AS2051FM

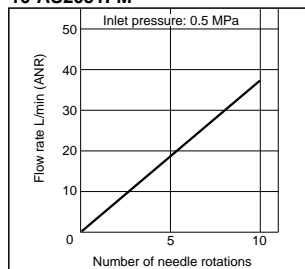

Dimensions

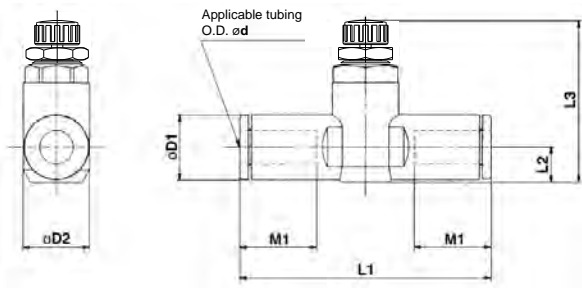

Model	d	D1	D2	L1	L2	L3		M1	Weight (g)
						MAX.	MIN.		
10-AS1001FM-23	3.2	8.4	10	38	4.5	27.7	24.9	12.7	6
10-AS1001FM-04	4	9.3		39.2	5.2	28.5	25.5		7
10-AS1001FM-06	6	11.6		40.7	6.2	29.8	26.6		13.5
10-AS2001FM-04	4	9.3	11.8	44.8	5.2	32.6	27.6	12.7	12
10-AS2001FM-06	6	11.6			6.3	33.7	28.7		
10-AS2051FM-06	6	12.8	14.8	53.2	6.7	35.2	30.2	17	26
10-AS2051FM-08	8	15.2		59.8	8.1	36.5	31.5		

- Directional Control Valves
- Air Cylinders
- Rotary Actuators
- Air Grippers
- Air Preparation Equipment
- Modular F. R.
- Pressure Control Equipment
- Fittings & Tubing
- Flow Control Equipment
- Pressure Switches/ Pressure Sensors

Series 10-ASD-FM

Dual Speed Controller for Low Speed Operation



How to Order

10 — ASD **3** **3** **0** **F** **M** — **01** **06** **S** —

- Clean series**
- Body size**

2	M5 standard
3	1/8 standard
4	1/4 standard
- Type**

3	Universal
---	-----------
- With One-touch fittings**
- For low speed control**
- Lock nut option**

Nil	Hexagon lock nut
J	Round lock nut
- With sealant**
 - * S is not necessary in case of M5 types, which are not provided with sealant.
- Applicable tubing O.D. (Note)**

Metric size

04	ø4
06	ø6
08	ø8
10	ø10

(Note) Refer to the following Model list for selection of applicable tubing O.D.
- Port size**

M5	M5 x 0.8
01	R1/8
02	R1/4



Model

Model	Applicable tubing			
	Metric size			
	4	6	8	10
10-ASD230FM-M5	●	●		
10-ASD330FM-01		●	●	
10-ASD430FM-02		●	●	●

Specifications

Proof pressure	1.5 MPa
Max. operating pressure	1 MPa
Min. operating pressure	0.1 MPa
Ambient and fluid temperature	-5 to 60°C (No freezing)
Applicable tubing material	Polyurethane ^(Note 1)
Grease	Fluorine grease
Cleanliness class (ISO class)	Class 5

Note 1) The maximum operating pressure for polyurethane (at 20 °C) is 0.8 MPa.
(Refer to the **WEB catalog** for details.)

* The knob of the M5 type and the lock nut of the meter-in type are black zinc chromated.

Flow Rate and Sonic Conductance

Model		10-ASD230FM	10-ASD330FM	10-ASD430FM
Tubing O.D.	Metric size	ø4, ø6	ø6, ø8	ø6, ø8, ø10
Controlled flow	Flow rate L/min (ANR)	7	12	38
	Sonic conductance dm ³ /(s·bar)	0.02	0.04	0.12
	Critical pressure ratio	0.25	0.2	0.2
Free flow	Flow rate L/min (ANR)	7	12	38
	Sonic conductance dm ³ /(s·bar)	0.02	0.04	0.12
	Critical pressure ratio	0.3	0.15	0.15

Note 1) Supply pressure: 0.5 MPa, Temperature: 20°C.

Needle Valve / Flow Rate Characteristics

10-ASD230FM

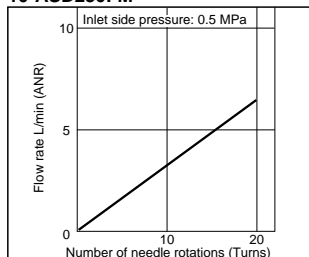

10-ASD330FM

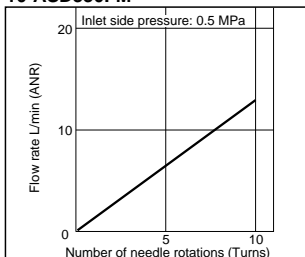

10-ASD430FM

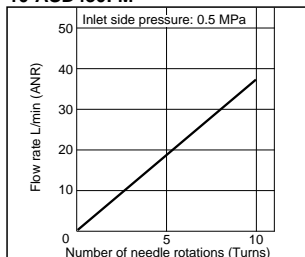

Directional Control Valves

Air Cylinders

Rotary Actuators

Air Grippers

Air Preparation Equipment

Modular F. R.

Pressure Control Equipment

Fittings & Tubing

Flow Control Equipment

Pressure Switches/ Pressure Sensors

Dimensions

10-ASD230FM

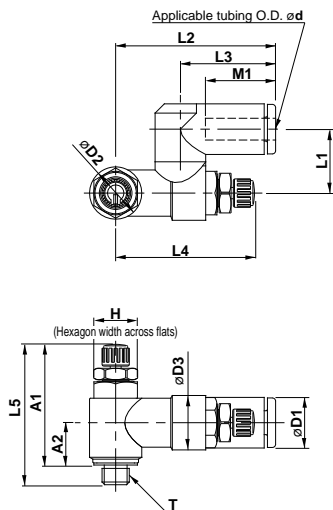

10-ASD330FM/430FM

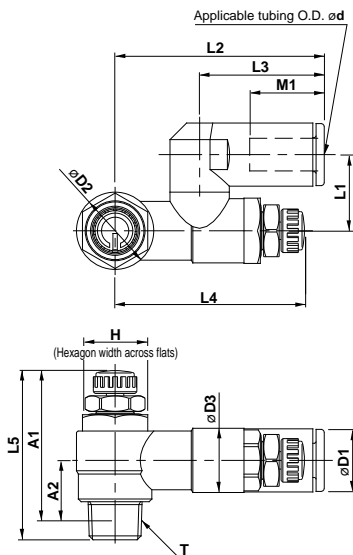

Model	d	T	H	D1	D2	D3	L1	L2	L3	L4		L5		A1 *		A2 *	M1	Weight (g)
										MAX.	MIN.	MAX.	MIN.	MAX.	MIN.			
10-ASD230FM-M5-04	4	M5 x 0.8	8	9.3	9.6	10	11.7	29.4	17.5	34.6	29.6	33.8	28.8	30.1	25.1	7.8	12.7	12
10-ASD230FM-M5-06	6			11.6				32.5	20.6									13
10-ASD330FM-01-06S	6			14				38.5	22.9									39.6
10-ASD330FM-01-08S	8	R1/8	12	15.2	14.2	11.8	15.8	44.8	28.2	38.9	33.9	36.1	31.1	32.1	27.1	10.6	18.5	31
10-ASD430FM-02-06S	6			12.8				43.5	25.2									53
10-ASD430FM-02-08S	8			15.2				46.5	28.2									55
10-ASD430FM-02-10S	10			18.5				49.3	31									58
				19.7				49.3	31									58

* Reference threaded dimensions after being screwed in.



Series ASD-FM Specific Product Precautions

Be sure to read this before handling. Refer to page 1382 for Safety Instructions and pages 1305 to 1308 for Flow Control Equipment Precautions.

Design / Selection

⚠ Caution

1. Single acting cylinder

When controlling a single acting cylinder, the cylinder's return speed will differ depending on the operating conditions. Operate after confirming the maximum return speeds shown in the table below.

Speed Controller	Cylinder	Solenoid valve	Tubing	Silencer	Max. return speed (mm/s)		
					10	20	30
ASD230FM	CJ2	SYJ500	TU0604 1 m	AN110-01	ø6		
					ø10		
					ø16		
ASD330FM	CM2	SYJ700	TU0604 1 m	AN110-01	ø20		
					ø25		
					ø32		

- <Operating conditions>
- Cylinder extension speed: 100 mm/s
 - Meter-out needle fully open

* Values are measured at 0.5 MPa and 20°C.

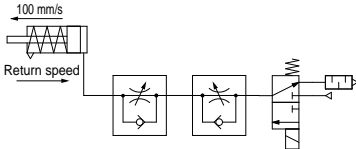

(Reference) Recommended circuit for high return speed

When low extension speed and high return speed are desired, the following circuit using 3-port is recommended.

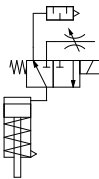

Note) Use the AS-FM series with -X214 for the throttle valve.

Directional Control Valves

Air Cylinders

Rotary Actuators

Air Grippers

Air Preparation Equipment

Modular F. R.

Pressure Control Equipment

Fittings & Tubing

Flow Control Equipment

Pressure Switches/
Pressure Sensors



Flow Control Equipment Precautions 1

Be sure to read this before handling.

Design / Selection

⚠ Warning

1. Check the specifications.

Products represented in this catalog are designed only for use in compressed air systems (including vacuum).

Do not operate at pressures or temperatures, etc., beyond the range of specifications, as this can cause damage or malfunction. (Refer to the specifications.)

Please contact SMC when using a fluid other than compressed air (including vacuum).

We do not guarantee against any damage if the product is used outside of the specification range.

2. Products mentioned in this catalog are not designed for the use as stop valve with zero air leakage.

A certain amount of leakage is allowed in the product's specifications. Tightening the needle to reduce leakage to zero may result in equipment damage.

3. Do not disassemble the product or make any modifications, including additional machining.

It may cause human injury and/or an accident.

4. The flow rate characteristics for each product are representative values.

The flow rate characteristics are characteristics of each individual product. Actual values may differ depending on the piping, circuitry, pressure conditions, etc. Also, there are variations in the zero needle rotations position of the flow rate characteristics, depending on product specifications.

5. Sonic conductance (C) and critical pressure ratio (b) values for products are representative values.

For controlled flow direction values the needle is fully open. For free flow direction values the needle is fully closed.

6. Check if that PTFE can be used in application.

PTFE powder (Polytetrafluoroethylene resin) is included in the seal material for piping taper thread of male thread type. Confirm that the use of it will not cause any adverse effect on the system. Please contact SMC if the Material Safety Data Sheet (MSDS) is required.

7. Speed controller is designed to control the speed of the actuator.

When it is used for adjusting the flow rate of the air blow, use a restrictor without check valve function (X214 or X21).

Mounting

⚠ Warning

1. Operation manual

Install the product and operate it only after reading the operation manual carefully and understanding its contents. Also, keep the manual where it can be referred to as necessary.

2. Ensure sufficient space for maintenance activities.

When installing the products, allow access for maintenance.

3. Tighten threads with the proper tightening torque.

When installing the products, follow the listed torque specifications.

1305

Mounting

⚠ Warning

4. Screw the R screw into the Rc thread and NPT screw into the NPT thread.

5. Confirm that the lock nut is tightened.

A loose lock nut may cause speed changes in the actuator.

6. Check the degree of rotation of the needle valve.

Products mentioned in this catalog are retainer type so that the needle is not removed completely. Over rotation will cause damage.

7. Do not use tools such as pliers to rotate the knob.

It can cause idle rotation of the knob or damage.

8. Verify the air flow direction.

Mounting backwards is dangerous, because the speed adjustment needle will not work and the actuator may lurch suddenly.

9. Adjust the needle by opening the needle slowly after having closed it completely.

Loose needle valves may cause unexpected sudden actuator extension. When a needle valve is turned clockwise, it is closed and cylinder speed decreases. When a needle valve is turned counterclockwise, it is open and cylinder speed increases.

10. Do not apply excessive force or shock to the body or fittings with an impact tool.

It can cause damage or air leakage.

11. Refer to the Fittings and Tubing Precautions (pages 1237 to 1240) for handling One-touch fittings.

12. Tubing O.D. $\varnothing 2$

Tubing other than that from SMC cannot be used, because it may result in inability to connect the tube, air leakage after connecting the tube or disconnection of the tube.

13. To install/remove the flow control equipment, use an appropriate wrench to tighten/loosen at the supplied nut are on body B, and as close to the thread as possible.

Do not apply torque at other points as the product may be damaged. Rotate body A manually for positioning after installation.

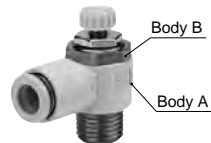

14. Do not use body A and universal type fittings for applications involving continuous rotation.

Body A and the fitting section may be damaged.



Flow Control Equipment Precautions 2

Be sure to read this before handling.

Mounting

⚠ Caution

1. Tightening the threaded portion of the connection thread M3, M5, 10-32 UNF

1) M3

First, tighten it by hand, then give it an additional 1/4 turn with a wrench. A reference value for the tightening torque is 0.4 to 0.5 N·m.

Note) AS12□1F-M3-02 should be given an approx. 1/6 turn after tightening by hand (reference value: 0.4 to 0.5 N·m).

2) M5 and 10-32UNF

First, tighten it by hand, then give it an additional 1/6 turn to 1/4 turn with a wrench. A reference value for the tightening torque is 1 to 1.5 N·m.

Note) Excessive tightening may damage the thread portion or deform the gasket and cause air leakage.

If the screw is too shallowly screwed in, it may come loose or air may leak.

2. Chamfered female thread size of the connection thread M3, M5, 10-32UNF

Confirming to ISO16030 (air pressure fluid dynamics – connection – boards and stud ends), the chamfered thread sizes shown below are recommended.

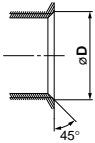

Female thread size	Chamfered port size øD (Recommended value)
M3	3.1 to 3.4
M5	5.1 to 5.4
10-32UNF	5.0 to 5.3

3. Proper tightening torque for a hexagon lock nut is shown in the table below. For standard installation, turn 15 to 30° using tool, after fastening by hand. Pay attention not to over torque the product. Check the dimensions for each product for the hexagonal width across flats.

Body size	Proper tightening torque (N·m)	Lock nut width across flats
M3	0.07	5 Note 1)
M5	0.3 Note 2)	7 Note 1)
1/8	1 Note 3)	10 Note 4)
1/4	1.2 Note 3)	12 Note 5)
3/8	2	14
1/2	6	17

Note 1) 4.5 for AS12□1F-M3-02, AS12□1F-M5-02 and AS1200-M3.

Note 2) 0.07 N·m for AS12□1F-M5-02, AS1□□1FM, AS12□□0M and ASD230-0M.

Note 3) 2 N·m for AS22□1FE-01 and AS22□1FE-02.

Note 4) 9 for AS2001F-□-3 and 12 for AS22□1FE-01.

Note 5) 14 for AS22□1FE-02.

UNI Thread Type Mounting

⚠ Caution

1. First, tighten the threaded portion by hand, then use a proper wrench, which could be suitable for the width across flats of the hexagon body, to tighten it further at a wrench tightening angle shown below. As a reference value for the tightening torque, refer to the table below.

Connection Female Thread: Rc, NPT, NPTF

Nominal size of UNI thread	Approx. wrench tightening angle after tightened by hand (deg)	Proper tightening torque (N·m)
1/8	30 to 60	3 to 5
1/4	30 to 60	8 to 12
3/8	15 to 45	14 to 16
1/2	15 to 30	20 to 22

Connection Female Thread: G

Nominal size of UNI thread	Approx. wrench tightening angle after tightened by hand (deg)	Proper tightening torque (N·m)
1/8	30 to 45	3 to 4
1/4	15 to 30	4 to 5
3/8	15 to 30	8 to 9
1/2	15 to 30	14 to 15

2. The gasket can be recycled up to 6 to 10 times. It can be replaced easily when it has sustained damage. A broken gasket can be removed by holding it and then turning it in the same direction as loosening the thread. If gasket is difficult to remove, cut it with nippers, etc. In such a case, use caution not to scratch the seat face because the seat face of 45° gasket of fitting is the sealing face.

3. Please consult with SMC if using for other fluids than air.

4. Other precautions on handling, etc. are the same as those for One-touch fittings.

Chamfered area for female thread (Recommended value)

By chamfering as shown in the following table, machining of threads is easier and effective for burr prevention.

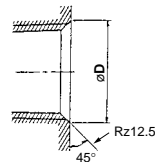

Nominal thread size	Chamfered port size øD (Recommended value)					
	G		Rc		NPT, NPTF	
	min	max	min	max	min	max
1/16	—	—	—	—	8.2	8.4
1/8	10.2	10.6	10.2	10.4	10.5	10.7
1/4	13.6	14.0	13.6	13.8	14.1	14.3
3/8	17.1	17.5	17.1	17.3	17.4	17.6
1/2	21.4	21.8	21.4	21.6	21.7	21.9



Flow Control Equipment Precautions 3

Be sure to read this before handling.

With Sealant Type

Piping

⚠ Caution

1. First, tighten the fitting by hand, then use a wrench appropriate for the hexagon flats of the body to tighten it a further two or three turns. As a reference value for the tightening torque, refer to the table below. Check the dimensions of each product for the hexagon width across flats.

Connection thread size (R, NPT)	[Reference value] Tightening torque (N·m)
1/8	3 to 5
1/4	8 to 12
3/8	15 to 20
1/2	20 to 25

2. If the fitting is tightened with excessive torque, a large amount of sealant will seep out. Remove the excess sealant.
3. Insufficient tightening may loosen the threads, or cause air leakage.
4. Reuse
 - 1) Normally, fittings with a sealant can be reused 2 to 3 times.
 - 2) To prevent air leakage through the sealant, remove any loose sealant stuck to the fitting by blowing air over the threaded portion.
 - 3) If the sealant no longer provides effective sealing, wrap sealing tape over the sealant before reusing. Do not use the sealant in any form other than a tape type.
5. Once the fitting has been tightened, backing it out to its original position often causes the sealant to become defective. Air leakage will occur.

Piping

⚠ Caution

1. Refer to the Fittings and Tubing Precautions (pages 1237 to 1240) for handling One-touch fittings.
2. Preparation before piping
Before piping is connected, it should be thoroughly blown out with air (flushing) or washed to remove chips, cutting oil and other debris from inside the pipe.
3. Winding of sealant tape
When screwing piping or fittings into ports, ensure that chips from the pipe threads or sealing material do not enter the piping. Also, if sealant tape is used, leave 1 thread ridge exposed at the end of the threads.

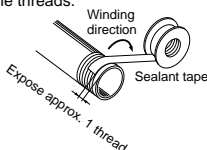

Air Supply

⚠ Warning

1. Type of fluids

Please consult with SMC when using the product in applications other than compressed air.

2. When there is a large amount of drainage.

Compressed air containing a large amount of drainage can cause malfunction of pneumatic equipment. An air dryer or water separator should be installed upstream from filters.

3. Drain flushing

If condensation in the drain bowl is not emptied on a regular basis, the bowl will overflow and allow the condensation to enter the compressed air lines. It causes malfunction of pneumatic equipment.

If the drain bowl is difficult to check and remove, installation of a drain bowl with an auto drain option is recommended.

For compressed air quality, refer to SMC Best Pneumatics catalog.

4. Use clean air.

Do not use compressed air that contains chemicals, synthetic oils including organic solvents, salt or corrosive gases, etc., as it can cause damage or malfunction.

⚠ Caution

1. Install an air filter.

Install an air filter upstream near the valve. Select an air filter with a filtration size of 5 µm or smaller.

2. Take measures to ensure air quality, such as by installing an aftercooler, air dryer, or water separator.

Compressed air that contains a large amount of drainage can cause malfunction of pneumatic equipment such as flow control equipment. Therefore, take appropriate measures to ensure air quality, such as by providing an aftercooler, air dryer, or water separator.

3. Ensure that the fluid and ambient temperature are within the specified range.

If the fluid temperature is 5°C or less, the moisture in the circuit could freeze, causing damage to the seals and leading to equipment malfunction. Therefore, take appropriate measures to prevent freezing.

For compressed air quality, refer to SMC Best Pneumatics catalog.



Flow Control Equipment Precautions 4

Be sure to read this before handling.

Operating Environment

⚠ Warning

1. Do not use in an atmosphere having corrosive gases, chemicals, sea water, water, water steam, or where there is direct contact with any of these.

Refer to each construction drawing on the flow control equipment material.

2. Do not expose the product to direct sunlight for an extended period of time.
3. Do not use in a place subject to heavy vibration and/or shock.
4. Do not mount the product in locations where it is exposed to radiant heat.
5. Using a flat blade screwdriver adjustable type tamper proof speed controller in locations where vibrations or impacts occur could lead to loosening of the needle. So please use a hexagon lock nut adjustable type speed controller.

For reference, SMC has conducted vibration tests in 25G for 200 operations, and we have confirmed no loosening of the needle.

Maintenance

⚠ Warning

1. Perform maintenance inspection according to the procedures indicated in the operation manual.

If handled improperly, malfunction and damage of machinery or equipment may occur.

2. Maintenance work

If handled improperly, compressed air can be dangerous. Assembly, handling, repair and element replacement of pneumatic systems should be performed by a knowledgeable and experienced person.

3. Drain flushing

Remove drainage from air filters regularly.

4. Removal of equipment, and supply/exhaust of compressed air

When components are removed, first confirm that measures are in place to prevent workpieces from dropping, run-away equipment, etc. Then, cut off the supply pressure and electric power, and exhaust all compressed air from the system using the residual pressure release function.

When machinery is restarted, proceed with caution after confirming that appropriate measures are in place to prevent cylinders from sudden movement.

Directional
Control Valves

Air Cylinders

Rotary Actuators

Air Grippers

Air Preparation
Equipment

Modular F. R.

Pressure Control
Equipment

Fittings & Tubing

Flow Control
Equipment

Pressure Switches/
Pressure Sensors

For Clean Room

Pressure Switches/Pressure Sensors

Contents	Series	Page
2-Color Display High Precision Digital Pressure Switch	10-ZSE30A(F)/ISE30A	P.1312
2-Color Display High Precision Digital Pressure Switch	10-ZSE40A(F)/ISE40A	P.1323
2-Color Display Digital Pressure Switch for General Fluids	10-ZSE80/ISE80	P.1340
Remote Type Pressure Sensor/For Compact Pneumatic Pressure	10-PSE530	P.1353
Remote Type Pressure Sensor/For Compact Pneumatic Pressure	10-PSE540	P.1355
Remote Type Pressure Sensor/For Low Differential Pressure	10-PSE550	P.1357
Remote Type Pressure Sensor/For General Fluids	10-PSE560	P.1359
Remote Type Multi-Channel Digital Pressure Sensor Controller	10-PSE200	P.1361
Remote Type 2-Color Display Digital Pressure Sensor Controller	10-PSE300	P.1366
Precautions		P.1374

Directional
Control Valves

Air Cylinders

Rotary Actuators

Air Grippers

Air Preparation
Equipment

Modular F. R.

Pressure Control
Equipment

Fittings & Tubing

Flow Control
Equipment

Pressure Switches/
Pressure Sensors

Series 10-ZSE30A(F)/10-ISE30A



How to Order

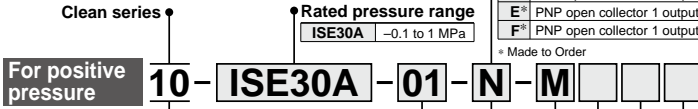

Output



N	NPN open collector 1 output
P	PNP open collector 1 output
A	NPN open collector 2 outputs
B	PNP open collector 2 outputs
C*	NPN open collector 1 output + Analog voltage output
D*	NPN open collector 1 output + Analog current output
E*	PNP open collector 1 output + Analog voltage output
F*	PNP open collector 1 output + Analog current output

* Made to Order

Rated pressure range

ISE30A	-0.1 to 1 MPa
ZSE30A	0 to -101 kPa
ZSE30AF	-100 to 100 kPa

Piping

01	R1/8 (M5 female thread)	
N01*	NPT1/8 (M5 female thread)	
C4H	One-touch fitting ø4 mm, ø5/32 inch	
C6H	One-touch fitting ø6 mm	
N7H	One-touch fitting ø1/4 inch	
C4L	One-touch fitting ø4 mm, ø5/32 inch	
C6L	One-touch fitting ø6 mm	
N7L	One-touch fitting ø1/4 inch	

* Made to Order

Display unit



Nil	With unit switching function (Note 1)
M	Fixed SI unit (Note 2)
P*	With unit switching function (Note 1) (Initial value psi)

* Made to Order

Note 1) Under the New Measurement Law, sales of switches with the unit switching function are not allowed for use in Japan.

Note 2) Fixed unit kPa, MPa

Option 1



Nil	Without lead wire	
L	Lead wire with connector (Lead wire length 2 m) (Note)	
G	Lead wire with connector (Lead wire length 2 m) (Note) With connector cover	

(Note) For output types N and P, the number of core of lead wires will be 3, and for other types, it will be 4.

Option 3

Symbol	Operating manual Booklet	Calibration certificate
Nil	<input type="radio"/>	<input type="radio"/>
Y	<input type="checkbox"/>	<input type="checkbox"/>
K	<input type="checkbox"/>	<input type="checkbox"/>
T	<input type="checkbox"/>	<input type="checkbox"/>

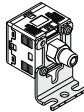
Option 2

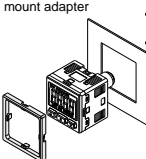
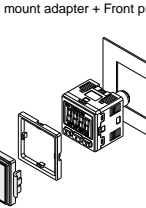
Nil	None
A1	Bracket A 
A2	Bracket B 
A3	Bracket C 
B	Panel mount adapter 
D	Panel mount adapter + Front protection cover 

⚠ Caution

This product is 10-ZSE30A(F)/ISE30A series blown with air and double packed in a Class M3.5 (ISO Class 5) clean room.

Directional Control Valves
 Air Cylinders
 Rotary Actuators
 Air Grippers
 Air Preparation Equipment
 Modular F.R.
 Pressure Control Equipment
 Fittings & Tubing
 Flow Control Equipment
 Pressure Switches/Pressure Sensors

2-Color Display High-Precision Digital Pressure Switch 10-ZSE30A(F)/10-ISE30A

Refer to the SMC website for Pressure Switches Precautions (M-E03-3) and Specific Product Precautions (Operation Manual).

Specifications

Model	10-ZSE30A (Vacuum pressure)	10-ZSE30AF (Compound pressure)	10-ISE30A (Positive pressure)
Rated pressure range	0.0 to -101.0 kPa	-100.0 to 100.0 kPa	-0.100 to 1.000 MPa
Display/Set pressure range	10.0 to -105.0 kPa	-105.0 to 105.0 kPa	-0.105 to 1.050 MPa
Withstand pressure	500 kPa	500 kPa	1.5 MPa
Display/Smallest settable increment	0.1 kPa	0.1 kPa	0.001 MPa
Applicable fluid	Air, Non-corrosive gas, Non-flammable gas		
Power supply voltage	12 to 24 VDC $\pm 10\%$, Ripple (p-p) 10% or less (with power supply polarity protection)		
Current consumption	40 mA or less		
Switch output	NPN or PNP open collector 1 output, NPN or PNP open collector 2 outputs (selectable)		
Maximum load current	80 mA		
Maximum applied voltage	28 V (at NPN output)		
Residual voltage	1 V or less (with load current of 80 mA)		
Response time	2.5 ms or less (with anti-chattering function: 20, 100, 500, 1000, 2000 ms)		
Short circuit protection	Yes		
Repeatability	$\pm 0.2\%$ F.S. ± 1 digit		
Hysteresis	Variable (0 or above) ^{Note 1)}		
Hysteresis	Window comparator mode		
Note 2)	Output voltage (Rated pressure range)	1 to 5V $\pm 2.5\%$ F.S.	0.6 to 5 V $\pm 2.5\%$ F.S.
Analog output	Voltage output	$\pm 1\%$ F.S.	
	Linearity	Approx. 1 k Ω	
	Output impedance	4 to 20 mA $\pm 2.5\%$ F.S.	
	Current output	2.4 to 20 mA $\pm 2.5\%$ F.S.	
Note 3)	Output current (Rated pressure range)	$\pm 1\%$ F.S.	
Linearity	Maximum load impedance: Power supply voltage 12 V: 300 Ω , Power supply voltage 24 V: 600 Ω Minimum load impedance: 50 Ω		
Load impedance			
Display	4-digit, 7-segment, 2-color LCD (Red/Green)		
Display accuracy	$\pm 2\%$ F.S. ± 1 digit (Ambient temperature of 25 $\pm 3^\circ\text{C}$)		
Indicator light	Lights up when switch output is turned ON. OUT1: Green, OUT2: Red		
Enclosure	IP40		
Environment	Operating temperature range Operating: 0 to 50°C, Stored: -10 to 60°C (No freezing or condensation)		
Operating humidity range	Operating/Stored: 35 to 85% RH (No condensation)		
Withstand voltage	1000 VAC for 1 minute between live parts and case		
Insulation resistance	50 M Ω or more between live parts and case (at 500 VDC Mega)		
Temperature characteristics	$\pm 2\%$ F.S. (Based on 25°C)		
Lead wire	Oilproof heavy-duty vinyl cable, 3 cores $\phi 3.5$, 2 m 4 cores Conductor area: 0.15 mm ² (AWG26), Insulator O.D.: 1.0 mm		
Standards	CE UL/CSA/E216656) RoHS		
Cleanliness class (ISO class)	Class 4		

Note 1) If applied pressure fluctuates near the set value, set the hysteresis above the fluctuation range to prevent chattering.

Note 2) When analog voltage output is selected, analog current output cannot be used together.

Note 3) When analog current output is selected, analog voltage output cannot be used together.

Piping Specifications

Model	01	N01	C4H	C6H	N7H	C4L	C6L	N7L
Port size	R1/8 M5 x 0.8	NPT1/8 M5 x 0.8	—	—	—	—	—	—
One-touch fitting, Straight type	—	—	$\phi 4$ mm $\phi 5/32$ inch	$\phi 6$ mm	$\phi 1/4$ inch	—	—	—
One-touch fitting, Elbow type	—	—	—	—	—	$\phi 4$ mm $\phi 5/32$ inch	$\phi 6$ mm	$\phi 1/4$ inch
Wetted parts material	Sensor pressure receiving area: Silicon Piping port: C3602 (electroless nickel plated) O-ring: HNBR		Sensor pressure receiving area: Silicon PBT, POM, Stainless steel 304, C3604 (electroless nickel plated) O-ring: HNBR					
Weight	Including lead wire with connector (3 cores, 2 m) 81 g	81 g	70 g	71 g	73 g	75 g	73 g	75 g
	Including lead wire with connector (4 cores, 2 m) 85 g	85 g	74 g	75 g	77 g	79 g	77 g	79 g
	Excluding lead wire with connector 43 g	43 g	32 g	33 g	35 g	37 g	35 g	37 g

Options/Part No.

When optional parts are required separately, use the following part numbers to place an order.

Part no.	Option	Note	Part no.	Option	Note
10-ZS-38-A1	Bracket A	Mounting screw (with 2 pcs. of M3 x 5L)	10-ZS-38-4G	Lead wire with connector (with connector cover)	4 cores, for 2 outputs, 2 m
10-ZS-38-A2	Bracket B	Mounting screw (with 2 pcs. of M3 x 5L)	10-ZS-38-5L	Lead wire with a connector for copying	3 cores, copy function, 1 m
10-ZS-38-A3	Bracket C	Mounting screw (with 2 pcs. of M3 x 5L)	10-ZS-38-U	Lead wire unit with a connector for copying	Copy function (up to 10 slaves)
10-ZS-27-C	Panel mount adapter	Mounting screw (with 2 pcs. of M3 x 8L)	10-ZS-38-C4H	One-touch fittings $\phi 4$ mm straight	O-ring, one-touch clip included
10-ZS-27-D	Panel mount adapter + Front protection cover	Mounting screw (with 2 pcs. of M3 x 8L)	10-ZS-38-C6H	One-touch fittings $\phi 6$ mm straight	O-ring, one-touch clip included
10-ZS-27-01	Front protection cover		10-ZS-38-N7H	One-touch fittings $\phi 1/4$ inch straight	O-ring, one-touch clip included
10-ZS-38-3L	Lead wire with connector	3 cores, for 1 output, 2 m	10-ZS-38-C4L	One-touch fittings $\phi 4$ mm elbow	O-ring, one-touch clip included
10-ZS-38-4L	Lead wire with connector	4 cores, for 2 outputs, 2 m	10-ZS-38-C6L	One-touch fittings $\phi 6$ mm elbow	O-ring, one-touch clip included
10-ZS-38-3G	Lead wire with connector (with connector cover)	3 cores, for 1 output, 2 m	10-ZS-38-N7L	One-touch fittings $\phi 1/4$ inch elbow	O-ring, one-touch clip included

Set Pressure Range and Rated Pressure Range

Set the pressure within the rated pressure range.

The set pressure range is the range of pressure that is possible in setting.

The rated pressure range is the range of pressure that satisfies the specifications (accuracy, linearity, etc.) on the switch.

Although it is possible to set a value outside the rated pressure range, the specifications will not be guaranteed even if the value stays within the set pressure range.

Switch		Pressure range				
		-100 kPa	0	100 kPa	500 kPa	1 MPa
For vacuum pressure	10-ZSE30A	-101 kPa	0			
		-105 kPa	10 kPa			
For compound pressure	10-ZSE30AF	-100 kPa	100 kPa			
		-105 kPa	105 kPa			
For positive pressure	10-ISE30A	-100 kPa				1 MPa
		-105 kPa (-0.105 MPa)				1.05 MPa

■ Rated pressure range of switch
 ■ Set pressure range of switch

Analog Output

Voltage output

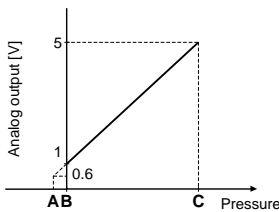

Current output

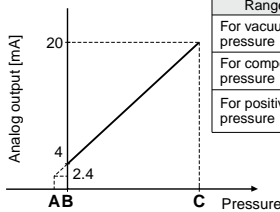

Range	Rated pressure range	A	B	C
For vacuum pressure	0.0 to -101.0 kPa	—	0	-101 kPa
For compound pressure	-100.0 to 100.0 kPa	—	-100 kPa	100 kPa
For positive pressure	-0.100 to 1.000 MPa	-0.1 MPa	0	1 MPa

Directional Control Valves
 Air Cylinders
 Rotary Actuators
 Air Grippers
 Air Preparation Equipment
 Modular F. R.
 Pressure Control Equipment
 Fittings & Tubing
 Flow Control Equipment
 Pressure Switches/ Pressure Sensors

Internal Circuits and Wiring Examples

-N NPN (1 output)

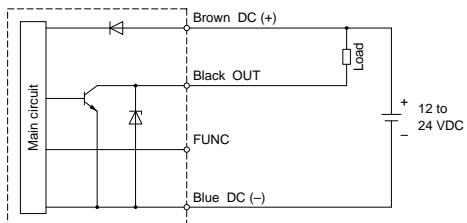

Max. 28 V, 80 mA
Residual voltage 1 V or less

-P PNP (1 output)

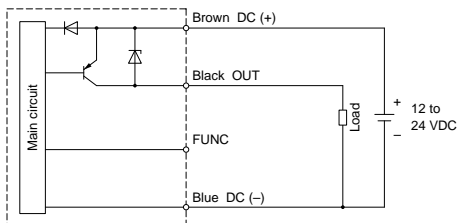

Max. 80 mA
Residual voltage 1 V or less

-A NPN (2 outputs)

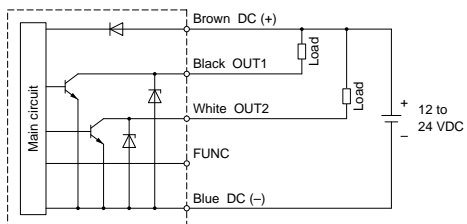

Max. 28 V, 80 mA
Residual voltage 1 V or less

-B PNP (2 outputs)

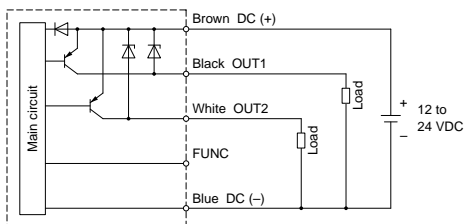

Max. 80 mA
Residual voltage 1 V or less

* The FUNC terminal is connected using a dedicated lead wire (10-ZS-38-5L or 10-ZS-38-U) when the copy function is used. (Refer to "Copy function" on page 1321.)

-C
NPN (1 output) + Analog voltage output

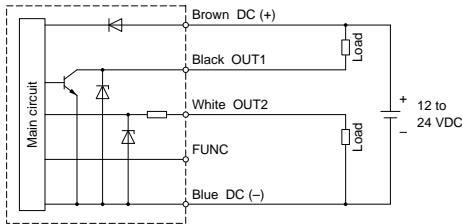

Max. 28 V, 80 mA
Residual voltage 1 V or less

Analog voltage output
Output impedance: Approx. 1 kΩ

-E
PNP (1 output) + Analog voltage output

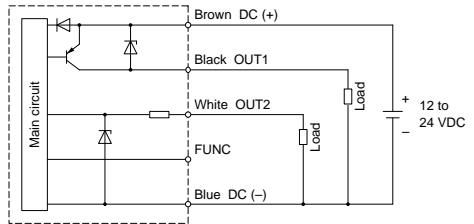

Max. 80 mA
Residual voltage 1 V or less

Analog voltage output
Output impedance: Approx. 1 kΩ

-D
NPN (1 output) + Analog current output

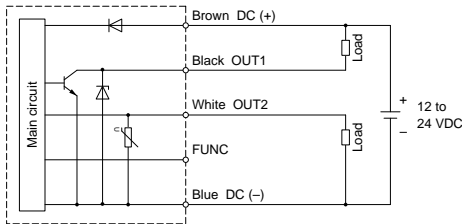

Max. 28 V, 80 mA
Residual voltage 1 V or less

Analog current output
Max. load impedance:
Power supply voltage 12 V: 300 Ω
Power supply voltage 24 V: 600 Ω
Min. load impedance: 50 Ω

-F
PNP (1 output) + Analog current output

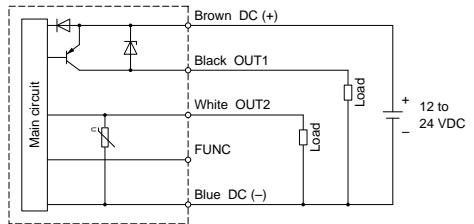

Max. 80 mA
Residual voltage 1 V or less

Analog current output
Max. load impedance:
Power supply voltage 12 V: 300 Ω
Power supply voltage 24 V: 600 Ω
Min. load impedance: 50 Ω

* The FUNC terminal is connected using a dedicated lead wire (10-ZS-38-5L or 10-ZS-38-U) when the copy function is used. (Refer to "Copy function" on page 1321.)

Directional Control Valves

Air Cylinders

Rotary Actuators

Air Grippers

Air Preparation Equipment

Modular F. R.

Pressure Control Equipment

Fittings & Tubing

Flow Control Equipment

Pressure Switches/ Pressure Sensors

Dimensions (For details about lead wires, refer to the product specifications.)



01 / N01

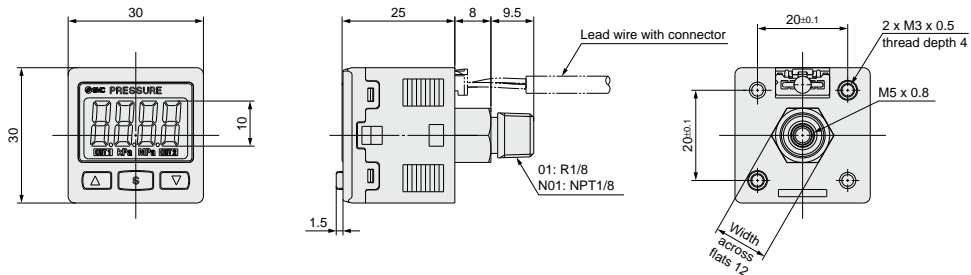

C4H

One-touch fitting $\varnothing 4$ mm
 $\varnothing 5/32$ inch straight

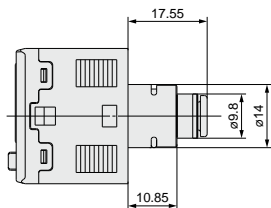

C6H

One-touch fitting $\varnothing 6$ mm
straight

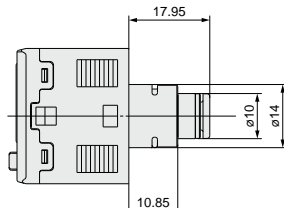

N7H

One-touch fitting $\varnothing 1/4$ inch
straight

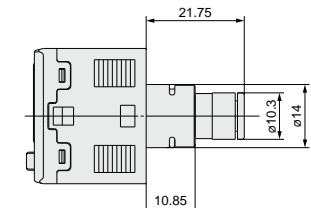

C4L

One-touch fitting $\varnothing 4$ mm
 $\varnothing 5/32$ inch elbow

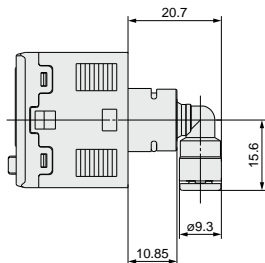

C6L

One-touch fitting $\varnothing 6$ mm
elbow

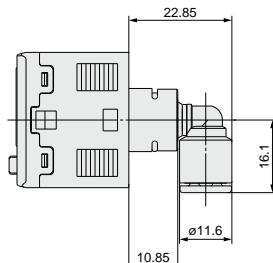

N7L

One-touch fitting $\varnothing 1/4$ inch
elbow

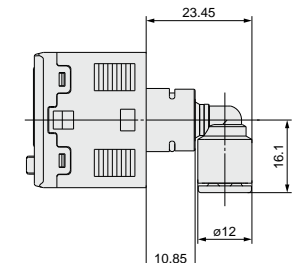

With bracket

10-ZSE30A(F)/10-ISE30A - □ - □ - □ - □ - □ - □

Option 2

A1

Bracket A
(Option unit part no.: 10-ZS-38-A1)

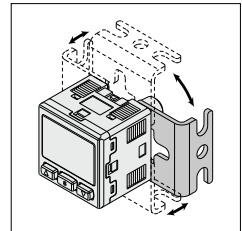
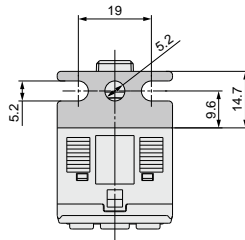
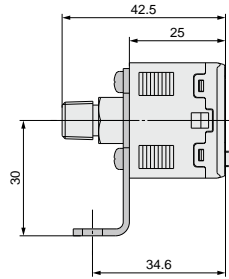
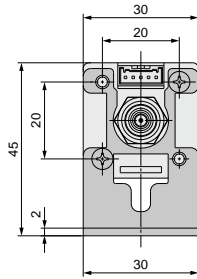

* Bracket configuration allows mounting in four orientations.

A2

Bracket B
(Option unit part no.: 10-ZS-38-A2)

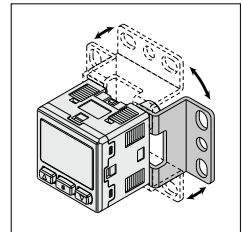
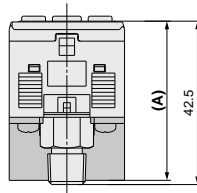

* Bracket configuration allows mounting in four orientations.

A3

Bracket C
(Option unit part no.: 10-ZS-38-A3)

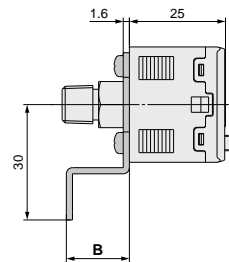
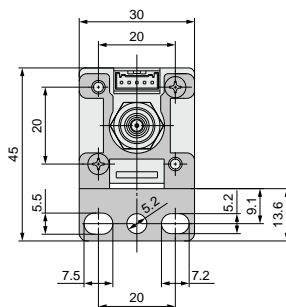

	A	B
Bracket B	41.4	16.4
Bracket C	53	28

Dimensions

Panel mount

10-ZSE30A(F)/10-ISE30A - □ - □ - □ - □ - □

Option 2

B

Panel mount adapter
(Option unit part no.:
10-ZS-27-C)

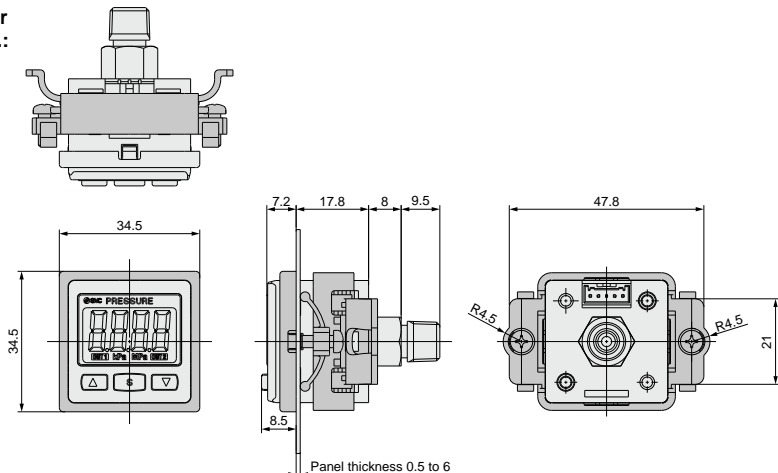

D

Panel mount adapter + Front protection cover
(Option unit part no.: 10-ZS-27-D)

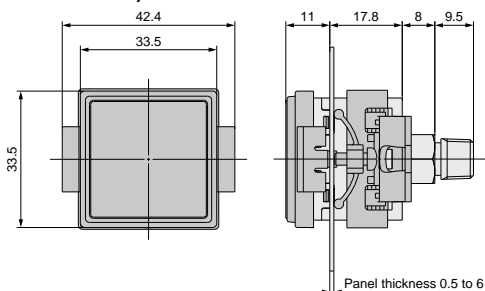

Lead wire with connector
(Option unit part no.: 10-ZS-38-3L)

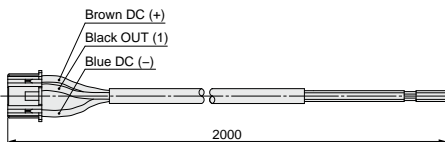

(Option unit part no.: 10-ZS-38-4L)

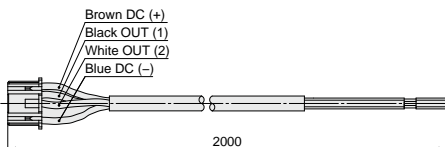

Panel-cut dimensions

1 pc. mounting

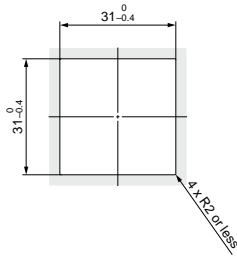

Multiple (2 pcs. or more) horizontal mounting

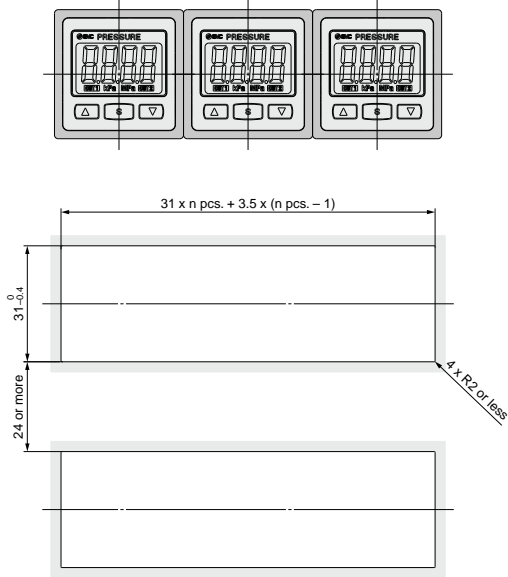

Multiple (2 pcs. or more) vertical mounting

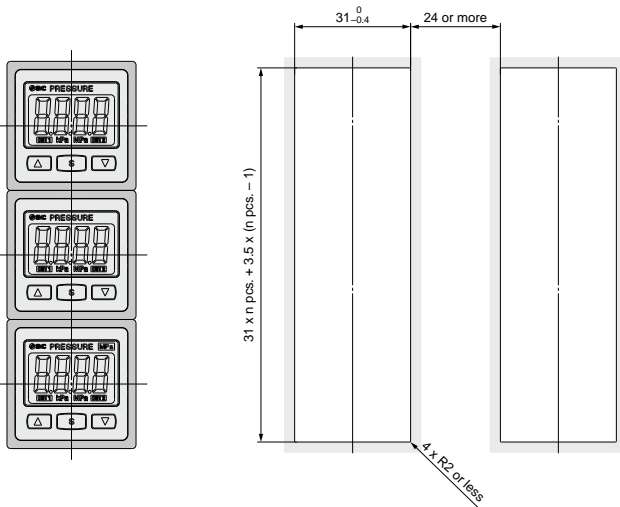

Directional Control Valves

Air Cylinders

Rotary Actuators

Air Grippers

Air Preparation Equipment

Modular F. R.

Pressure Control Equipment

Fittings & Tubing

Flow Control Equipment

Pressure Switches/ Pressure Sensors

Function Details

A Copy function (F97)

The settings of the master sensor can be copied to the slave sensors. It is to reduce the time taken for setting and prevent the input of wrong values.

Settings can be copied to up to 10 slave sensors at once.
(Max. transmission distance: 4 m)

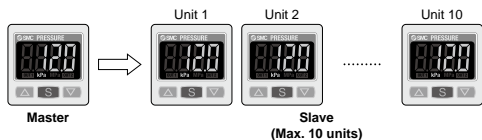

- 1) The sensors are connected by a dedicated lead wire (10-ZS-38-5L (for master and one slave) or 10-ZS-38-U (for master and up to 10 slaves)). Copying is performed through a dedicated communication line.
- 2) Make the slave sensor which needs to be the master into the master by button operation. (Initially all sensors are set as slaves.)
- 3) Press the **[S]** button on the master sensor to start copying.

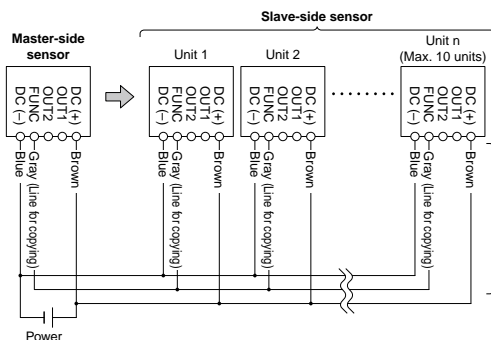

Wiring example when using 10-ZS-38-U

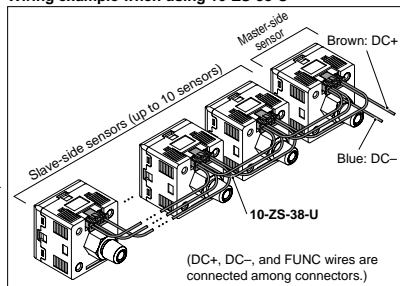

B Auto-preset function (F5)

Auto-preset function, when selected in the setting, calculates and stores the set-value from the measured pressure. The optimum set-value is determined automatically by repeating vacuum and break with the target workpiece several times.

Suction Verification

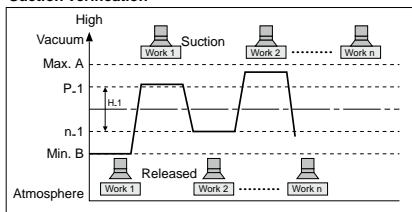

Formula for Obtaining the Set-Value

P ₁ or P ₂	H ₁ or H ₂
$P_1 (P_2) = A - (A-B)/4$	$H_1 (H_2) = (A-B)/2$
$n_1 (n_2) = B + (A-B)/4$	

C Precision indicator setting function (F6)

Fine adjustment of the indicated value of the pressure sensor can be made within the range of $\pm 5\%$ of the read value. The scattering of the indicated value can be eliminated.

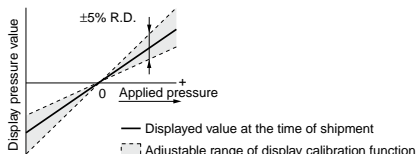

Note) When the precision indicator setting function is used, the set pressure value may change ± 1 digit.

D Peak and bottom display function

This function constantly detects and updates the maximum (minimum) value and allows to hold the maximum (minimum) pressure value.

When the **[Δ]** **[▽]** buttons are simultaneously pressed for 1 second or longer, while "holding", the held value will be reset.

E Key lock function

This function prevents incorrect operations such as accidentally changing the set-value.

F Zero-out function

This function clears and resets the zero value on the display of measured pressure.

For the pressure switch with analog output, the analog output shifts according to the indication. A displayed value can be adjusted within $\pm 7\%$ F.S. of the pressure when ex-factory. ($\pm 3.5\%$ F.S. for 10-ZSE30AF (compound pressure))

F in brackets stand for the function codes. Refer to the operating manual for how to operate and function codes in detail.

G Error indication function

Error name	Error code	Description	Solution
Overcurrent error	Er1	Load current of switch output (OUT1) exceeds 80 mA.	Shut off the power supply. After eliminating the output factor that caused the excess current, turn the power supply back on.
	Er2	Load current of switch output (OUT2) exceeds 80 mA.	
Residual pressure error	Er3	A pressure of $\pm 7\%$ F.S. of atmospheric pressure is applied in the zero-out function. ($\pm 3.5\%$ F.S. or more for 10-ZSE30AF (compound pressure)) The switch will automatically return to measuring mode in 1 second, however. Due to individual product differences, the setting range of the zero-out function varies within $\pm 1\%$ F.S.	Bring the pressure back to atmospheric pressure and try using the zero-out function.
Applied pressure error	HHH	Supply pressure exceeds the maximum set pressure.	Bring the pressure back to within the set pressure range.
	LLL	Supply pressure is below the minimum set pressure.	
System error	Er0	Internal data error	Shut off the power supply. Turn the power supply back on. If the switch will not recover to normal, consult SMC for investigation.
	Er4		
	Er6		
	Er7		
	Er8		
	Er9		

If the switch will not recover to normal even after all of the above-mentioned solutions have been applied, consult SMC for investigation.

H Anti-chattering function (F3)

A large bore cylinder or ejector consumes a large volume of air in operation and may experience a temporary drop in the supply pressure. This function prevents detection of such temporary drops in the supply pressure as an error.

Available response time settings
20 ms, 100 ms, 500 ms, 1000 ms, 2000 ms

Principle

This function averages pressure values measured during the response time set by the user and then compares the average pressure value with the pressure set point value to output the result on the switch.

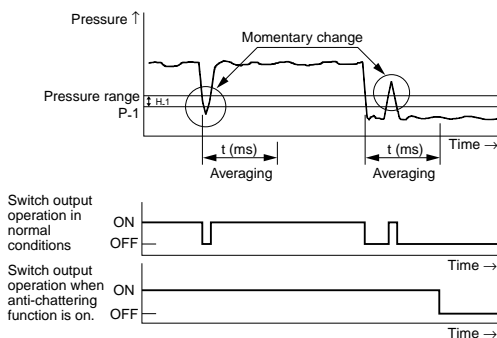

I Display unit switching function (F0)

Display units can be switched with this function.

Smallest settable increment	Display unit		PA	GF	bAr	PSI	inH	mmH
	kPa	MPa*	kgf/cm ²	bar	psi	inHg	mmHg	
10-ZSE30A (Vacuum pressure)	0.1	0.001	0.001	0.001	0.01	0.1	1	
10-ZSE30AF (Compound pressure)	0.1	0.001	0.001	0.001	0.01	0.1	1	
10-ISE30A (Positive pressure)	1	0.001	0.01	0.01	0.1			

* For the 10-ZSE30A (vacuum pressure) and 10-ZSE30AF (compound pressure), when the display unit is MPa, setting and display resolutions are changed.

J Power-saving mode (F7)

Power-saving mode can be selected.

It shifts to the power-saving mode without button operation for 30 seconds. It is set to the normal mode (Power-saving mode is OFF.) when ex-factory. (Decimal points and operation indicator light (only when the switch output is turned ON.) blink in the power-saving mode.)

K Secret code setting (F8)

It can be set whether code number input is required or not when key is locked. It is set to input no code number when ex-factory.

Series 10-ZSE40A(F)/10-ISE40A

How to Order

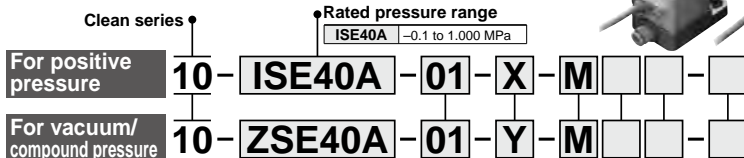
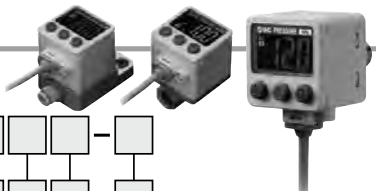

Rated pressure range

 ISE40A -0.1 to 1.000 MPa

Rated pressure range

 ZSE40A 0.0 to -101.3 kPa

 ZSE40AF -100.0 to 100 kPa

		Piping specifications	
01	R1/8 (With M5 female thread)		R1/8, NPT1/8
N01	NPT1/8 (With M5 female thread)		M5 x 0.8
W1	Rc1/8		Rc1/8, G1/8
WF1*	G1/8		Rc1/8, G1/8
M5*	M5 x 0.8 (Female thread)		M5 x 0.8
C4*	ø4 One-touch fitting		ø4, ø6 one-touch fitting
C6*	ø6 One-touch fitting		

* Made to Order

Combination of piping specifications with option 1 and part numbers of options

Description	Symbol	Part no.	Piping						
			01	N01	W1	WF1	M5	C4	C6
Bracket A	A	10-ZS-24-A	○	○	○	○	×	×	×
Bracket B	B	10-ZS-24-B	×	×	×	×	×	×	×
Bracket D	D	10-ZS-24-D	○	○	○	○	×	×	×
Panel mount adapter	E	10-ZS-35-C	○	×	×	×	×	○	○
		10-ZS-35-D	×	×	×	×	×	○	○
Panel mount adapter + Front protective cover	F	10-ZS-35-F	○	○	×	×	×	×	×
		10-ZS-35-G	×	×	○	○	○	○	○

Output specifications

R	NPN open collector 2 outputs + Analog voltage/Auto-shift switching
T	PNP open collector 2 outputs + Analog voltage/Auto-shift switching
S	NPN open collector 2 outputs + Analog current/Auto-shift switching
V	PNP open collector 2 outputs + Analog current/Auto-shift switching
X	NPN open collector 2 outputs + Copy function
Y	PNP open collector 2 outputs + Copy function

When optional parts are required separately, use the following part numbers to place an order.

Options/Part No.

Part no.	Option
10-ZS-24-A	Bracket A With 2 mounting screws each of M3 x 5L, M4 x 5L
10-ZS-24-B	Bracket B With 2 mounting screws M4 x 5L
10-ZS-24-D	Bracket D With 2 mounting screws each of M3 x 5L, M4 x 5L
10-ZS-35-C	Panel mount adapter (Piping: For 01/N01)
10-ZS-35-D	Panel mount adapter (Piping: For W1/WF1/M5/C4/C6)
10-ZS-35-F	Panel mount adapter + Front protective cover (Piping: For 01/N01)
10-ZS-35-G	Panel mount adapter + Front protective cover (Piping: For W1/WF1/M5/C4/C6)

Unit specifications

Nil	With unit switching function (Note 1)
M	Fixed SI unit (Note 2)
P	With unit switching function (Note 1) (Initial value psi)

Note 1) Under the New Measurement Law, sales of switches with the unit switching function are not allowed for use in Japan.

Note 2) Fixed unit:
For vacuum/compound pressure: kPa
For positive pressure: MPa

Option 2

 Symbol Calibration certificate

Nil	—
K	○

Symbol Specifications/Description

X501 Lead wire length 3 m

 Refer to page 1339 for details.

Option 1*

Nil	None
A	Bracket A
B	Bracket B
D	Bracket D
E	Panel mount adapter 01/N01
F	Panel mount adapter + Front protective cover 01/N01

* Some options are unavailable depending on the piping specifications. Refer to "Combination of piping specifications with option 1 and part numbers of options".

Caution

This product is 10-ZSE40A(F)/ISE40A series blown with air and double packed in a Class M3.5 (ISO Class 5) clean room.

Refer to the SMC website for Pressure Switches Precautions (M-E03-3) and Specific Product Precautions (Operation Manual).

Specifications

Model		10-ZSE40A (Vacuum pressure)	10-ZSE40AF (Compound pressure)	10-ISE40A (Positive pressure)	
Rated pressure range		0.0 to -101.3 kPa	-100.0 to 100.0 kPa	-0.100 to 1.000 MPa	
Display/Set pressure range		10.0 to -105.0 kPa	-105.0 to 105.0 kPa	-0.105 to 1.050 MPa	
Withstand pressure		500 kPa	500 kPa	1.5 MPa	
Display/Smallest settable increment		0.1 kPa	0.1 kPa	0.001 MPa	
Applicable fluid		Air, Non-corrosive gas, Non-flammable gas			
Power supply voltage		12 to 24 VDC ±10%, Ripple (p-p) 10% or less (with power supply polarity protection)			
Current consumption		45 mA or less			
Switch output		NPN or PNP open collector 2 outputs (Selectable)			
Maximum load current		80 mA			
Maximum applied voltage		28 V (at NPN output)			
Residual voltage		1 V or less			
Response time		2.5 ms (with anti-chattering function: 20, 100, 500, 1000, 2000 ms)			
Short circuit protection		Yes			
Repeat accuracy		±0.2% F.S. ±1 digit			
Hysteresis	Hysteresis mode	Variable (0 or above) ^{Note 1)}			
	Window comparator mode				
Analog output	^{Note 2)} Voltage output	Output voltage (Rated pressure range)	1 to 5 V ±2.5% F.S.	0.6 to 5 V ±2.5% F.S.	
		Linearity	±1% F.S. or less		
		Output impedance	Approx. 1 kΩ		
	^{Note 3)} Current output	Output current (Rated pressure range)	4 to 20 mA ±2.5% F.S.	2.4 to 20 mA ±2.5% F.S.	
		Linearity	±1% F.S. or less		
		Load impedance	Maximum load impedance: 300 Ω (Power supply voltage 12 V) 600 Ω (Power supply voltage 24 V) Minimum load impedance: 50 Ω		
Auto-shift input		Non-voltage input (Reed or Solid state), Low level: 0.4 V or less, 5 ms or longer input			
Display		3 1/2-digit, 7-segment, 2-color LCD (Red/Green)			
Display accuracy		±2% F.S. ±1 digit (Ambient temperature of 25 ±3°C)			
Indicator light		Lights up when output is turned ON. OUT1, OUT2: Orange			
Environment resistance	Enclosure	IP65			
	Operating temperature range	Operating: -5 to 50°C, Stored: -10 to 60°C (No freezing or condensation)			
	Operating humidity range	Operating/Stored: 35 to 85% RH (No condensation)			
	Withstand voltage	1000 VAC for 1 minute between live parts and case			
Insulation resistance		50 MΩ or more between live parts and case (at 500 VDC Mega)			
Temperature characteristics		±2% F.S. (Based on 25°C)			
Lead wire		Oilproof heavy-duty vinyl cable ø3.5, 2 m Conductor area: 0.15 mm ² (AWG26) Insulator O.D.: 0.95 mm			
Standards		CE UL/CSA (E216656) RoHS			
Cleanliness class (ISO class)		Class 4			

Note 1) If the applied voltage fluctuates around the set-value, the hysteresis must be set to a value more than the fluctuating width, otherwise chattering will occur.
 Note 2) When the analog voltage output is selected, the analog current output cannot be selected.
 Note 3) When the analog current output is selected, the analog voltage output cannot be selected.

Piping Specifications

Model		O1	N01	W1	WF1	M5	C4	C6
Port size		R1/8 (With M5 female thread)	NPT1/8 (With M5 female thread)	Rc1/8	G1/8	M5 x 0.8 female thread	ø4 One-touch fitting	ø6 One-touch fitting
Wetted parts material	Sensor pressure receiving area	Silicon						
	Piping port	C3602 (Electroless nickel plated) O-ring: HNBR		ZDC2 O-ring: HNBR		ZDC2, POM, Stainless steel 304, C3604 (Electroless nickel plated) O-ring: HNBR		
Weight		78 g	79 g	97 g	104 g	101 g		

Set Pressure Range and Rated Pressure Range

Set the pressure within the rated pressure range.

The set pressure range is the range of pressure that is possible in setting.

The rated pressure range is the range of pressure that satisfies the specifications (accuracy, linearity, etc.) on the switch.

Although it is possible to set a value outside the rated pressure range, the specifications will not be guaranteed even if the value stays within the set pressure range.

Switch	Pressure range				
	-100 kPa	0	100 kPa	500 kPa	1 MPa
For vacuum pressure 10-ZSE40A	-101.3 kPa	0			
	-105 kPa	10 kPa			
For compound pressure 10-ZSE40AF	-100 kPa	100 kPa			
	-105 kPa	105 kPa			
For positive pressure 10-ISE40A	-100 kPa				1 MPa
	-105 kPa (-0.105 MPa)				1.05 MPa

Rated pressure range of switch
 Set pressure range of switch

Analog Output

Voltage output

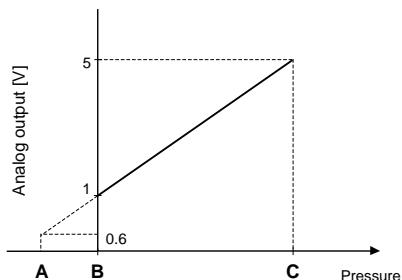

Current output

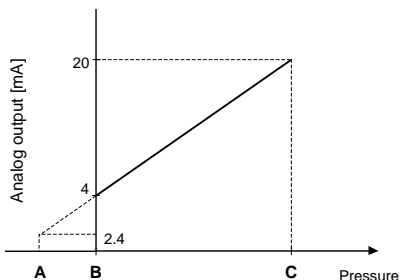

Range	Rated pressure range	A	B	C
For vacuum pressure	0.0 to -101.3 kPa	10.1 kPa	0	-101.3 kPa
For compound pressure	-100.0 to 100.0 kPa	—	-100.0 kPa	100.0 kPa
For positive pressure	-0.100 to 1.000 MPa	-0.100 MPa	0	1.000 MPa

Internal Circuit and Wiring Example

-R, -S

R: NPN (2 outputs) + Analog voltage output
S: NPN (2 outputs) + Analog current output

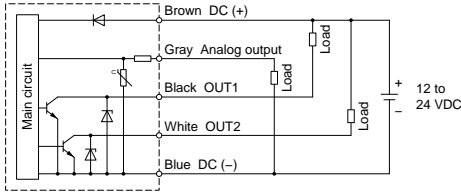

Max. 28 V, 80 mA
 Residual voltage 1 V or less

-R/-S

NPN (2 outputs) + Auto-shift input

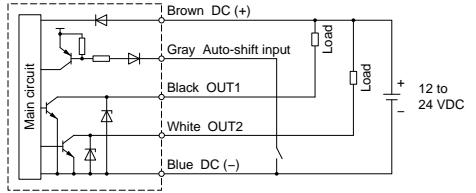

Max. 28 V, 80 mA
 Residual voltage 1 V or less

-T, -V

T: PNP (2 outputs) + Analog voltage output
V: PNP (2 outputs) + Analog current output

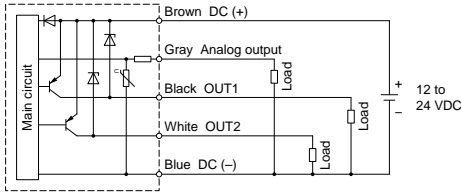

Max. 80 mA
 Residual voltage 1 V or less

-T/-V

PNP (2 outputs) + Auto-shift input

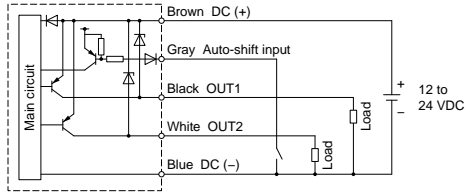

Max. 80 mA
 Residual voltage 1 V or less

-X

NPN (2 outputs) + Copy function

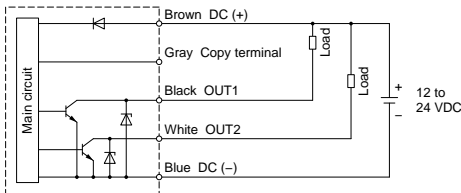

Max. 28 V, 80 mA
 Residual voltage 1 V or less

-Y

PNP (2 outputs) + Copy function

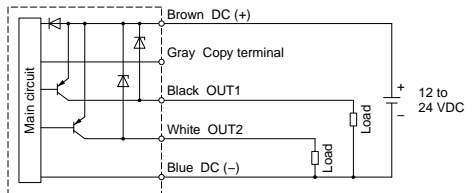

Max. 80 mA
 Residual voltage 1 V or less

Directional Control Valves
 Air Cylinders
 Rotary Actuators
 Air Grippers
 Air Preparation Equipment
 Modular F. R.
 Pressure Control Equipment
 Fittings & Tubing
 Flow Control Equipment
 Pressure Switches/ Pressure Sensors

2-Color Display High Precision Digital Pressure Switch 10-ZSE40A(F)/10-ISE40A

Dimensions (For details about lead wires, refer to the product specifications.)

10-ZSE40A(F)/10-ISE40A-01

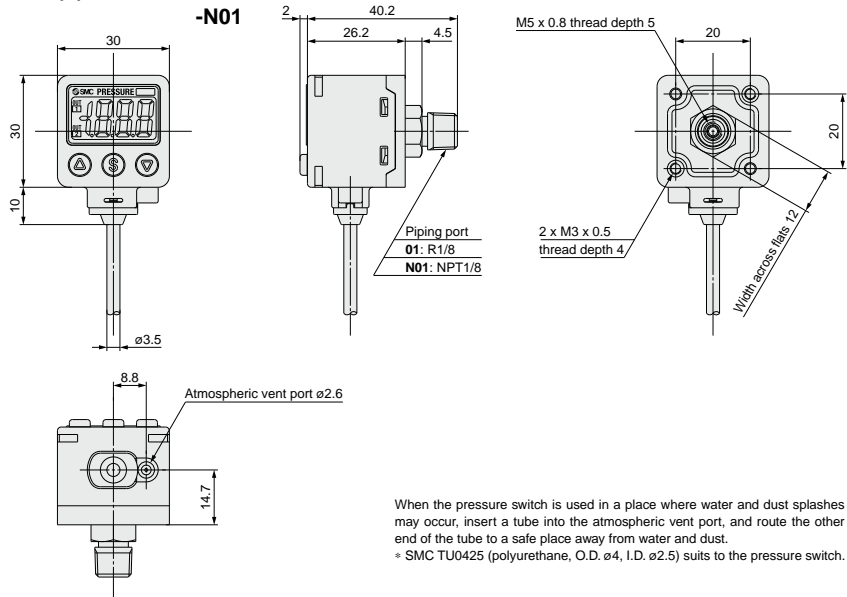

10-ZSE40A(F)/10-ISE40A-W1

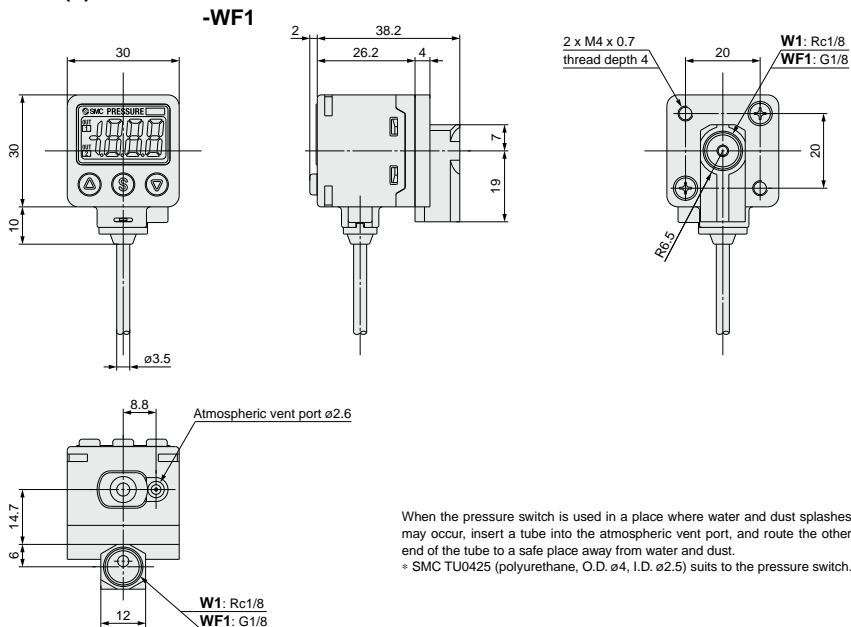

Dimensions (For details about lead wires, refer to the product specifications.)

10-ZSE40A(F)/10-ISE40A-C4

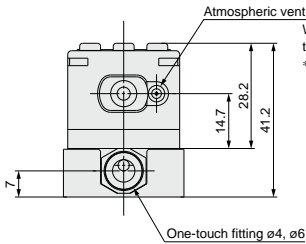
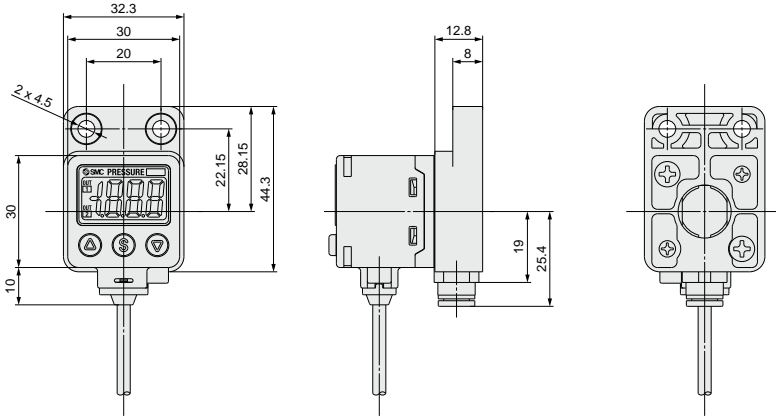

When the pressure switch is used in a place where water and dust splashes may occur, insert a tube into the atmospheric vent port, and route the other end of the tube to a safe place away from water and dust.
* SMC TU0425 (polyurethane, O.D. $\phi 4$, I.D. $\phi 2.5$) suits to the pressure switch.

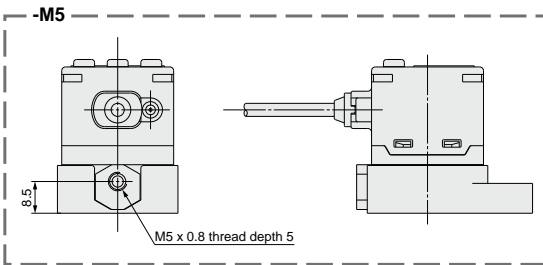

Directional Control Valves
Air Cylinders
Rotary Actuators
Air Grippers
Air Preparation Equipment
Modular F. R.
Pressure Control Equipment
Fittings & Tubing
Flow Control Equipment
Pressure Switches/ Pressure Sensors

Dimensions (For details about lead wires, refer to the product specifications.)

10-ZSE40A(F)/10-ISE40A-01-□-□A□
 -N01-□-□A□

With bracket

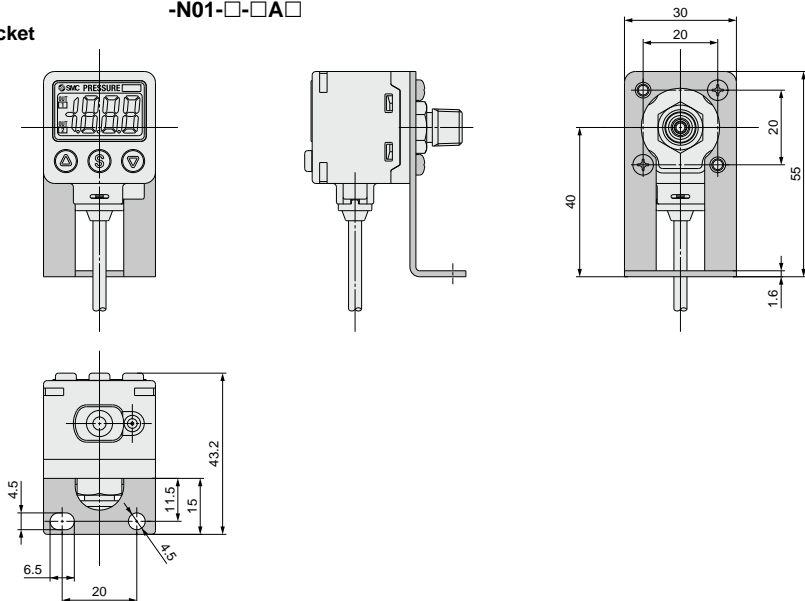

10-ZSE40A(F)/10-ISE40A-01-□-□D□
 -N01-□-□D□

With bracket

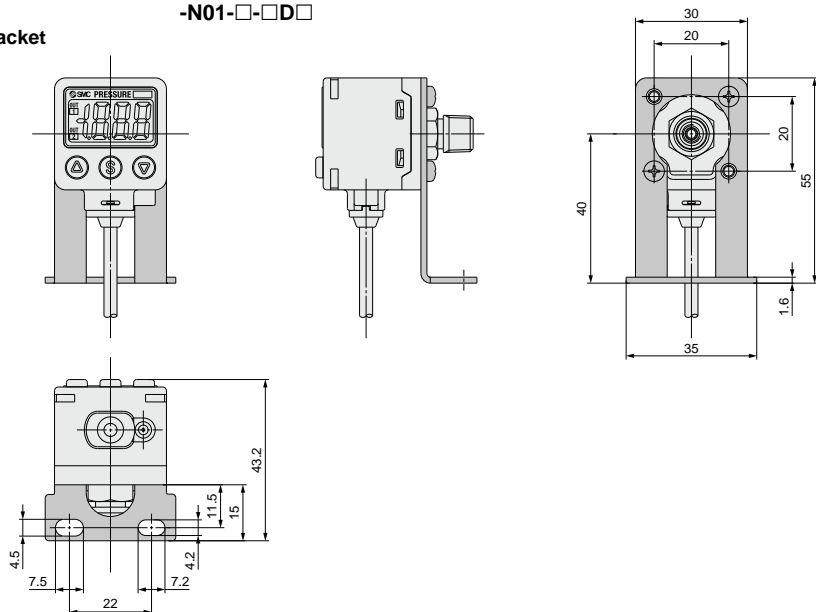

Dimensions (For details about lead wires, refer to the product specifications.)

10-ZSE40A(F)/10-ISE40A-W1-□-□A□
-WF1-□-□A□

With bracket

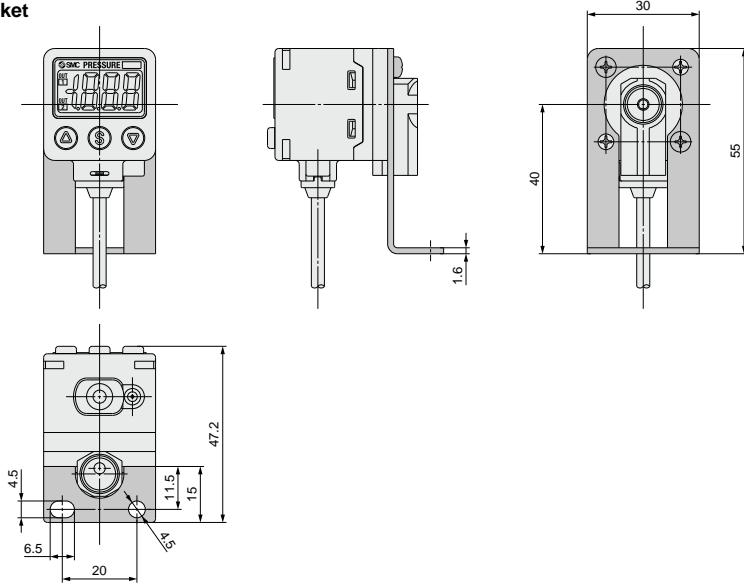

10-ZSE40A(F)/10-ISE40A-W1-□-□B□
-WF1-□-□B□

With bracket

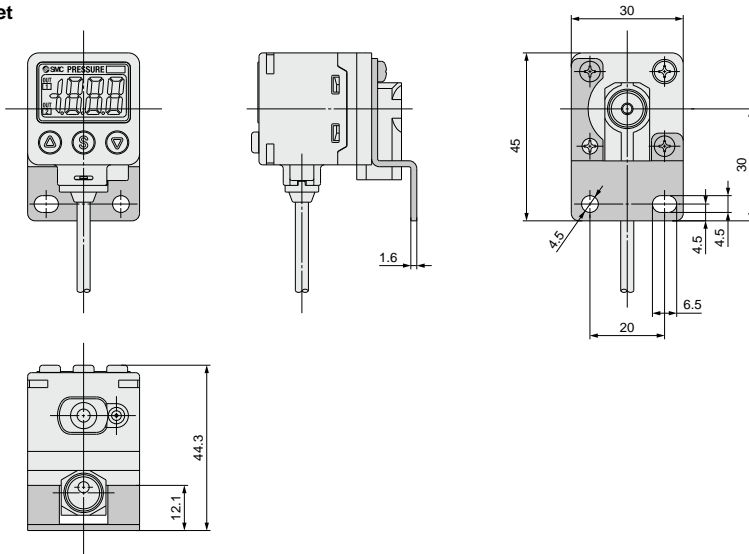

Directional Control Valves

Air Cylinders

Rotary Actuators

Air Grippers

Air Preparation Equipment

Modular F. R.

Pressure Control Equipment

Fittings & Tubing

Flow Control Equipment

Pressure Switches/ Pressure Sensors

2-Color Display High Precision Digital Pressure Switch 10-ZSE40A(F)/10-ISE40A

Dimensions (For details about lead wires, refer to the product specifications.)

10-ZSE40A(F)/10-ISE40A-W1-□-□D□
-WF1-□-□D□

With bracket

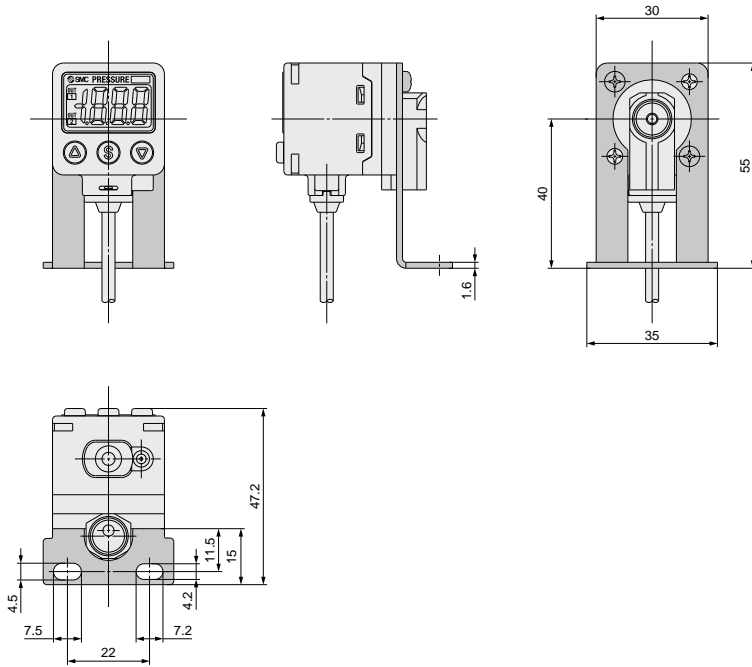

Dimensions (For details about lead wires, refer to the product specifications.)

10-ZSE40A(F)/10-ISE40A-01-□-□E□
 A-N01-□-□E□

Panel mounting

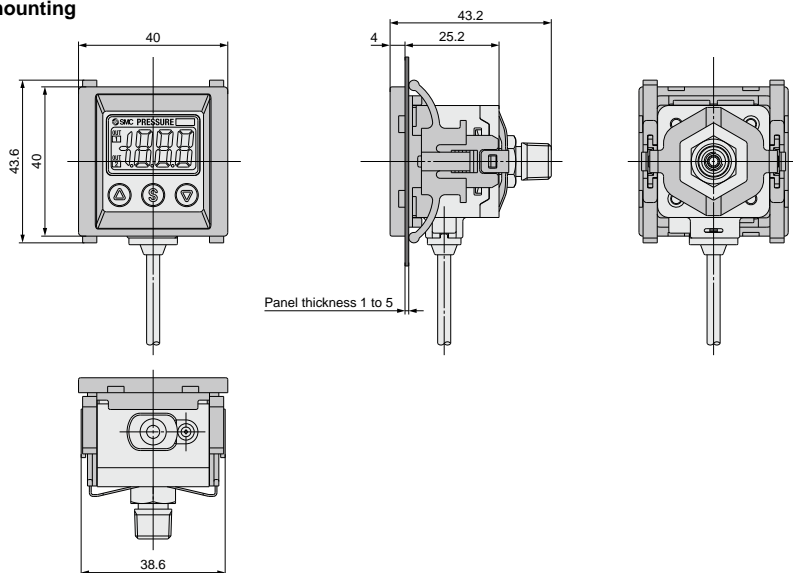

10-ZSE40A(F)/10-ISE40A-01-□-□F□
 -N01-□-□F□

Panel mounting + Front protective cover

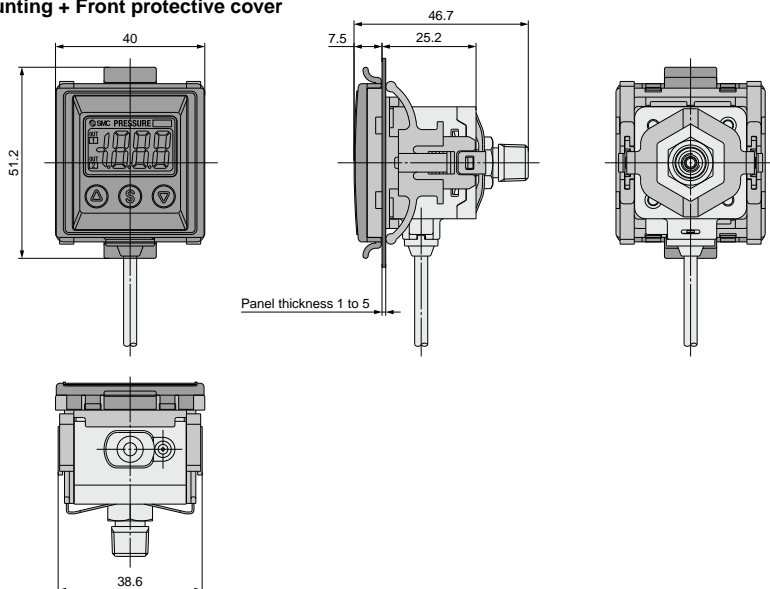

Directional
Control Valves

Air Cylinders

Rotary Actuators

Air Grippers

Air Preparation
Equipment

Modular F. R.

Pressure Control
Equipment

Fittings & Tubing

Flow Control
Equipment

Pressure Switches/
Pressure Sensors

Dimensions (For details about lead wires, refer to the product specifications.)

10-ZSE40A(F)/10-ISE40A-W1-□-□E□
-WF1-□-□E□

Panel mounting

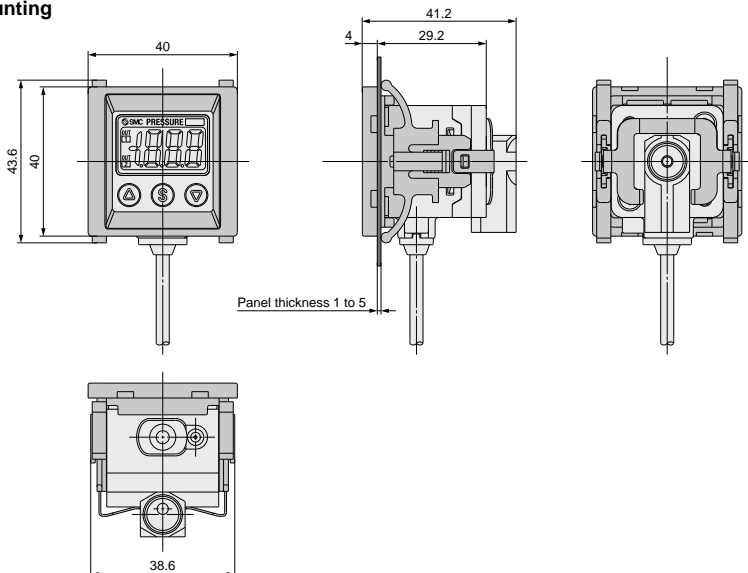

10-ZSE40A(F)/10-ISE40A-W1-□-□F□
-WF1-□-□F□

Panel mounting + Front protective cover

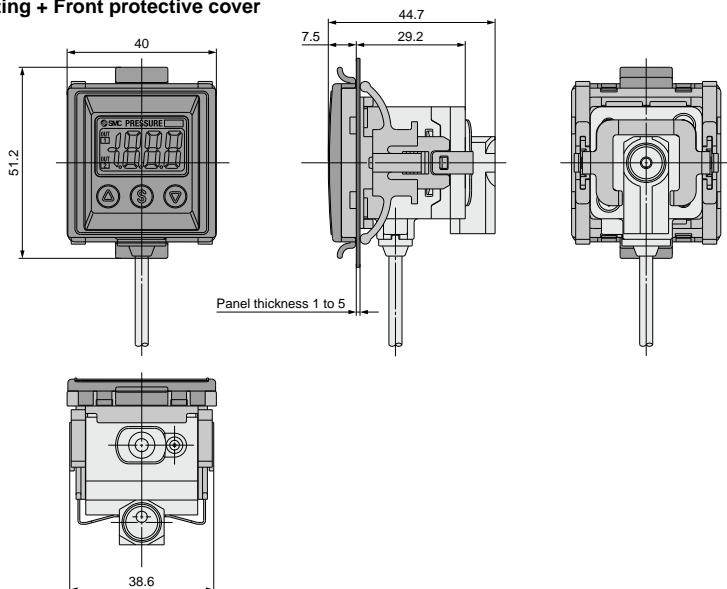

Dimensions (For details about lead wires, refer to the product specifications.)

10-ZSE40A(F)/10-ISE40A-C4-□E□
-C6-□E□

Panel mounting

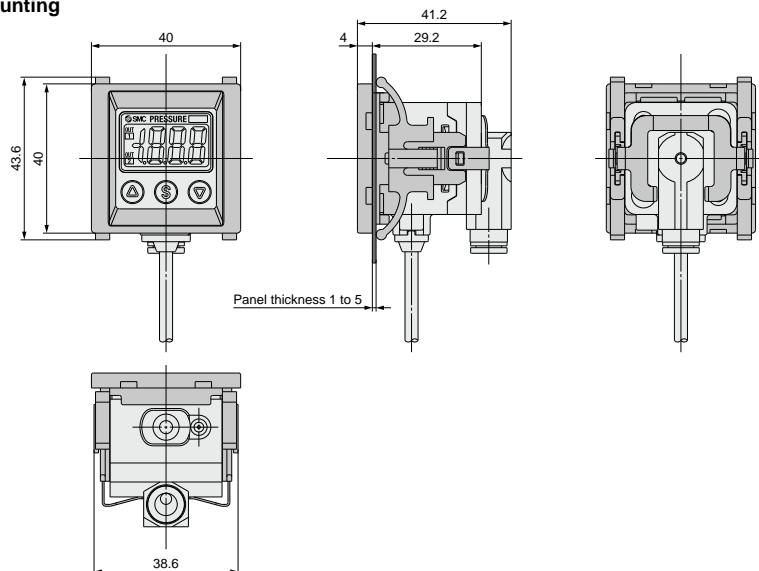

10-ZSE40A(F)/10-ISE40A-C4-□F□
-C6-□F□

Panel mounting + Front protective cover

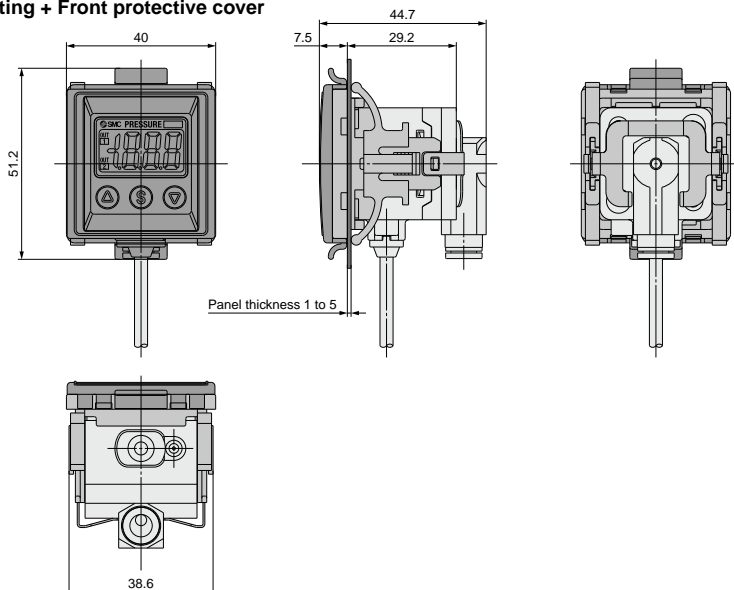

Directional Control Valves

Air Cylinders

Rotary Actuators

Air Grippers

Air Preparation Equipment

Modular F. R.

Pressure Control Equipment

Fittings & Tubing

Flow Control Equipment

Pressure Switches/ Pressure Sensors

Dimensions

Panel fitting dimensions

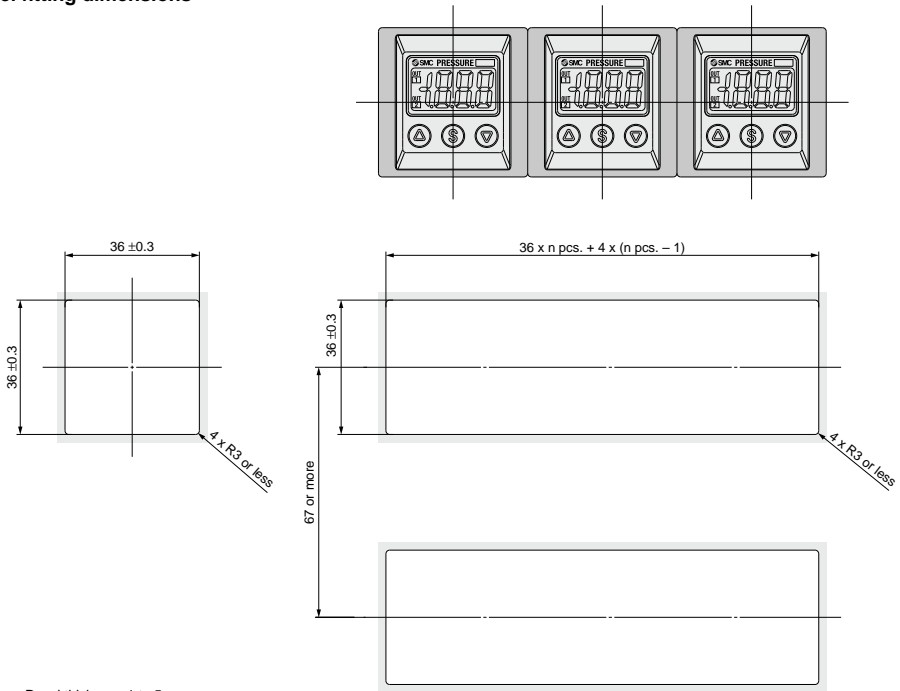

Note) This is the minimum value for the piping method O1 or N01.
Take the piping material and tubing into account for design. When the corner is to have radius, it must be R3 or less.

The F□ in () shows the function code number. Refer to the Operation Manual for the details of operation procedures and function codes.

Function Details

A Copy function (F97)

The settings of the master pressure switch can be copied to the slave pressure switches. This can reduce the labor for setting and prevent the entry of incorrect set-values.

The set-value can be copied to up to 10 switches simultaneously.
(Maximum communication distance 4 m)

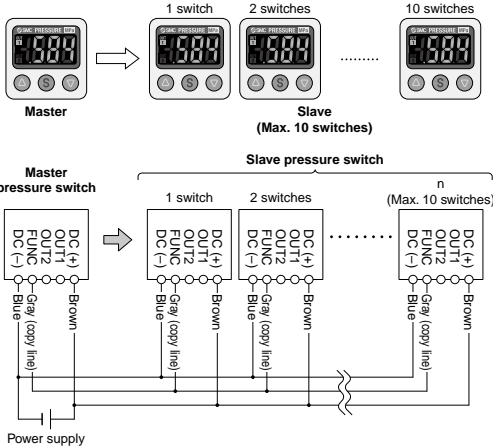

- 1) Wire as shown in the left figure.
- 2) Select the slave switch which is to be the master, and change it into a master using the buttons. (In the default setting, all switches are set as slaves.)
- 3) Press the button of the master switch to start copying.

B Auto-preset function (F4)

Auto-preset function, when selected in the initial setting, calculates and stores the set-value from the measured pressure. The optimum set-value is determined automatically by repeating vacuum and break with the target work piece several times.

Suction Verification

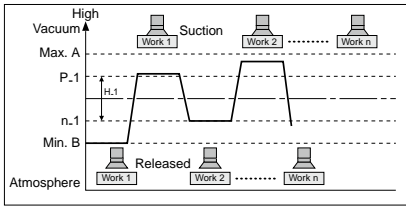

Formula for Obtaining the Set-Value

P ₋₁ or P ₋₂	H ₋₁ or H ₋₂
$P_{-1} (P_{-2}) = A - (A-B)/4$	$H_{-1} (H_{-2}) = (A-B)/2$
$n_{-1} (n_{-2}) = B + (A-B)/4$	

C Display calibration function (F6)

Fine adjustment of the indicated value of the pressure sensor can be made within the range of $\pm 5\%$ of the read value. (The scattering of the indicated value can be eliminated.)

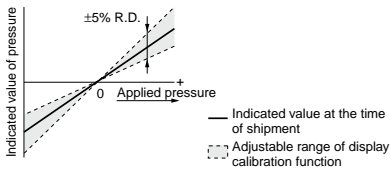

Note) When the display calibration function is used, the set pressure value may change ± 1 digit.

D Peak and bottom display function

This function constantly detects and updates the maximum (minimum) value and allows to hold the maximum (minimum) pressure value.

When the buttons are simultaneously pressed for 1 second or longer, while "holding", the hold value will be reset.

E Key lock function

This function prevents incorrect operations such as accidentally changing the set-value.

F Zero-clear function

This function clears and resets the zero value on the display of measured pressure.

For the pressure switch with analog output, the analog output shifts according to the indication. The indicated value can be adjusted within $\pm 7\%$ F.S. of the pressure when ex-factory. (ZSE40AF (for compound pressure) $\pm 3.5\%$ F.S.)

Function Details

G Error indication function

Error name	Error code	Description	Remedy
Overcurrent error	Er1	Load current of switch output (OUT1) exceeds 80 mA.	Turn the power off and remove the output factor for the overcurrent. Then, turn the power on.
	Er2	Load current of switch output (OUT2) exceeds 80 mA.	
Residual pressure error	Er3	During zero-clear operation, pressure over $\pm 7\%$ F.S. is applied. (10-ZSE40AF (compound) $\pm 3.5\%$ F.S.) After 1 second, the mode will reset to measurement mode. $\pm 1\%$ F.S. of the zero-clear range varies between individual products.	Perform zero-clear operation again after restoring the applied pressure to an atmospheric pressure condition.
Applied pressure error	HHH	Supply pressure exceeds the maximum set pressure.	Reset applied pressure to a level within the set pressure range.
	LLL	Supply pressure is below the minimum set pressure.	
Auto-shift error	or	The value measured at the time of auto-shift input is outside the set pressure range. * After displaying the error code for about 1 second, the switch returns to the measuring mode.	The controller does not respond to the auto-shift signal. Check the equipment and machinery for this point.
System error	Er0	Internal data error	Turn the power off and turn it on again. If the failure cannot be solved, ask SMC for repair.
	Er4		
	Er6		
	Er7		
	Er8		
	Er9		

If the above remedy cannot recover the operation, ask SMC for repair.

H Anti-chattering function (F3)

A large bore cylinder or ejector consumes a large volume of air in operation and may experience a temporary drop in the supply pressure. This function prevents detection of such temporary drops in the supply pressure as an error.

Available response time settings
20 ms, 100 ms, 500 ms, 1000 ms, 2000 ms

<Principle>

This function averages pressure values measured during the response time set by the user and then compares the average pressure value with the pressure set point value to output the result on the switch.

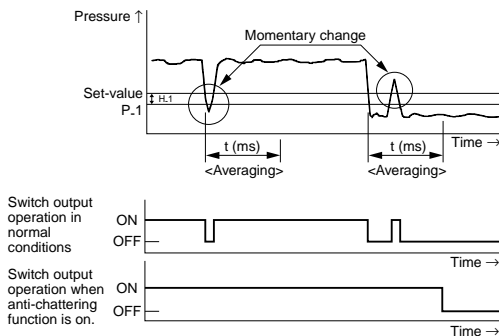

I Display unit switching function (F0)

Display units can be switched with this function.

Display unit	Display unit						
	Pa	MPa*	kgf/cm ²	bar	psi	inHg	mmHg
Smallest settable increment	kPa	MPa*	kgf/cm ²	bar	psi	inHg	mmHg
10-ZSE40A (vacuum pressure)	0.1	0.001	0.001	0.001	0.01	0.1	1
10-ZSE40AF (compound pressure)	0.1	0.001	0.001	0.001	0.02	0.1	1
10-ISE40A (positive pressure)	1	0.001	0.01	0.01	0.1		

* The 10-ZSE40A (vacuum pressure) and 10-ZSE40AF (compound pressure) will have different setting and display resolution when the unit is set to MPa.

The F□ in () shows the function code number. Refer to the Operation Manual for the details of operation procedures and function codes.

J Power-saving mode (F80)

Power-saving mode can be selected. It shifts to the power-saving mode without button operation for 30 seconds. It is set to the normal mode (Power-saving mode is OFF.) when ex-factory. (Decimal points and operation indicator light (only when the switch output is turned ON.) blink in the power-saving mode.)

K Secret code setting (F81)

It can be set whether secret code input is required or not when key is locked. It is set to input no secret code when ex-factory.

L Auto-shift function (F5)

When there are large fluctuations in the supply pressure, the switch may fail to operate correctly. The auto-shift function compensates such supply pressure fluctuations. It measures the pressure at the time of auto-shift signal input and uses it as the reference pressure to correct the set-value on the switch.

Set-value correction by auto-shift function

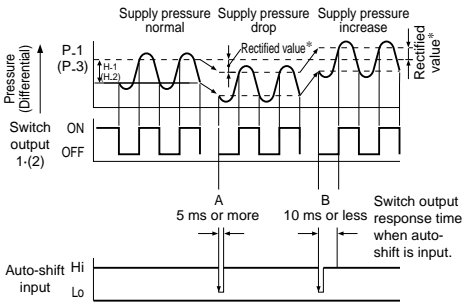

* Rectified value
When the auto-shift is selected, "000" will be displayed for about 1 second, and the pressure value at that point will be saved as a rectified value "□.5". Based on the saved rectified values, the set-value^{Note)} of "P_1", "H_1", "P_2", and "H_2" will likewise be rectified.

Note) When an output is reversed, "n_1", "H_1", "n_2", "H_2" will be rectified.

Possible Set Range for Auto-Shift Input

	Regulating pressure range	Possible set range
Compound pressure	-105.0 to 105.0 kPa	-210 to 210 kPa
Vacuum pressure	10.0 to -105.0 kPa	115.0 to -115.0 kPa
Positive pressure	-0.105 to 1.050 MPa	-1.155 to 1.155 MPa

Auto-shift zero

The basic function of auto-shift zero is the same as the function for auto-shift. Also, it corrects values on the display, based on a pressure value of "0", when the auto-shift is selected.

Directional Control Valves

Air Cylinders

Rotary Actuators

Air Grippers

Air Preparation Equipment

Modular F. R.

Pressure Control Equipment

Fittings & Tubing

Flow Control Equipment

Pressure Switches/ Pressure Sensors

Series 10-ZSE40A(F)/10-ISE40A Made to Order

Please contact SMC for detailed dimensions, specifications, and lead times.



Symbol

Lead wire length 3 m

-X501

It has a lead wire extended to 3 meters.

How to Order

* Refer to How to Order on page 1323 for standard specifications.

10-ZSE40A(F)/10-ISE40A - - - - X501

Piping specification*

Output specification*

Option*

Series 10-ZSE80/10-ISE80

How to Order



Clean series

For positive pressure
10-ISE80-02-□-N-M-□-□-□

For vacuum/compound pressure
10-ZSE80-02-□-N-M-□-□-□

Rated pressure range

80	-0.1 to 1 MPa
80H	-0.1 to 2 MPa

Rated pressure range

80	0 to -101 kPa
80F	-100 to 100 kPa

Piping

02	R1/4 (M5 female thread)
N02	NPT1/4 (M5 female thread)
F02*	G1/4 (M5 female thread)
C01	Rc1/8
A2	URJ1/4
B2	TSJ1/4

* Piping direction "L" (bottom ported) is not available.

Piping direction

Nil

L*

* Piping specification "F2" (G 1/4) is not available.

Input/Output

N	NPN open collector 1 output
P	PNP open collector 1 output
A	NPN open collector 2 outputs
B	PNP open collector 2 outputs
R	NPN open collector 2 outputs + Analog voltage output/Auto-shift switching
T	PNP open collector 2 outputs + Analog voltage output/Auto-shift switching
S	NPN open collector 2 outputs + Analog current output/Auto-shift switching
V	PNP open collector 2 outputs + Analog current output/Auto-shift switching

Made to Order
Refer to Table 1 below.

Option 1

Nil	With unit switching function <small>Note 1</small>
M	Fixed SI unit <small>Note 2</small>
P	Initial value psi

Option 2

Nil	None
A	With bracket
B	With bracket <small>Note 1</small>
C	Panel mount
D	Panel mount + Front protection cover

Option 3

Symbol	Operating manual	Calibration certificate
Nil	● (Booklet)	—
Y	—	—
K	● (Booklet)	●
T	—	●

Note 1 Under the New Measurement Law, sales of switches with the unit switching function are not allowed for use in Japan.
Note 2 Fixed unit 10-ISE80H: MPa, kPa
Others : MPa, kPa

Note All texts in both English and Japanese

Table 1 Made to Order

Symbol	Specifications
-X501	Lead wire length 3 m

Note Refer to page 1351 for detail.

Option

Option	Piping direction	Part no.
Bracket	Rear ported	10-ZS-24-A
	Rear ported	10-ZS-24-D
	Bottom ported	10-ZS-35-A
Panel mount	Rear ported	10-ZS-35-C
	Bottom ported	10-ZS-35-B
	Rear ported	10-ZS-35-F
Panel mount + Front protection cover	Rear ported	10-ZS-35-E
	Bottom ported	10-ZS-35-F

Caution

This product is the 10-ZSE80/SE80 series blown with air and double packed in a Class M3.5 (ISO Class 5) clean room.

Directional Control Valves

Air Cylinders

Rotary Actuators

Air Grippers

Air Preparation Equipment

Modular F. R.

Pressure Control Equipment

Fittings & Tubing

Flow Control Equipment

Pressure Switches/Pressure Sensors

2-Color Display Digital Pressure Switch For General Fluids **10-ZSE80/10-ISE80**

Refer to the SMC website for Pressure Switches Precautions (M-E03-3) and Specific Product Precautions (Operation Manual).

Specifications

Model	10-ZSE80 (Vacuum pressure)	10-ZSE80F (Compound pressure)	10-ISE80 (Positive pressure)	10-ISE80H (Positive pressure)	
Rated pressure range	0.0 to -101.0 kPa	-100.0 to 100.0 kPa	-0.100 to 1.000 MPa	-0.100 to 2.00 MPa	
Display/Set pressure range	10.0 to -111.1 kPa	-110.0 to 110.0 kPa	-0.105 to 1.100 MPa	-0.105 to 2.20 MPa	
Withstand pressure	500 kPa		2 MPa	4 MPa	
Wetted parts material	Pressure sensor: Stainless steel 630, Fitting: Stainless steel 304				
Display/Smallest settable increment	0.1 kPa	0.1 kPa	0.001 MPa	0.001 MPa (to 1.999) 0.01 MPa (2.00 to)	
Applicable fluid	Fluids do not corrode stainless steel 630 and 304				
Power supply voltage	12 to 24 VDC ±10%, Ripple (p-p) 10% or less (with power supply polarity protection)				
Current consumption	45 mA or less				
Switch output	NPN 1 output, NPN 2 outputs, PNP 1 output, PNP 2 outputs				
	Maximum load current	80 mA			
	Maximum load voltage	28 V (at NPN output)			
	Residual voltage	1 V or less (with load current of 80 mA)			
	Response time	2.5 ms (with anti-chattering function: 20, 100, 500, 1000, 2000 ms)			
	Short circuit protection	Yes			
Repeatability	±0.2% F.S. ±1 digit				
Hysteresis	Hysteresis mode	Variable (0 or above)			
	Window comparator mode				
Analog output	Voltage output	Output voltage (Rated pressure range)	1 to 5 V ±2.5% F.S.	0.6 to 5 V ±2.5% F.S.	0.8 to 5 V ±2.5% F.S.
		Linearity	±1% F.S. or less		
		Output impedance	Approx. 1 kΩ		
	Current output	Output current (Rated pressure range)	4 to 20 mA ±2.5% F.S.	2.4 to 20 mA ±2.5% F.S.	3.2 to 20 mA ±2.5% F.S.
		Linearity	±1% F.S. or less		
	Load impedance	Maximum load impedance: 300 Ω (Power supply voltage 12 V) 600 Ω (Power supply voltage 24 V) Minimum load impedance: 50 Ω			
Auto-shift input	Non-voltage input (Reed or Solid state), Low level: 0.4 V or less, 5 ms or longer input				
Display	3 1/2-digit, 7-segment, 2-color LCD (Red/Green)				
Display accuracy	±2% F.S. ±1 digit (Ambient temperature of 25 ±3°C)				
Indicator light	Lights up when output is turned ON. OUT1, OUT2: Orange				
Environment resistance	Enclosure	IP65			
	Operating temperature range	Operating: 0 to 50°C, Stored: -10 to 60°C (No freezing or condensation)			
	Operating humidity range	Operating/Stored: 35 to 85% RH (No condensation)			
	Withstand voltage	250 VAC for 1 minute between live parts and case			
	Insulation resistance	2 MΩ or more between live parts and case (at 50 VDC Mega)			
Temperature characteristics	±3% F.S. (Based on 25°C, within operating temperature range)				
Lead wire	Oilproof heavy-duty vinyl cable, 3 cores (N.P) 4 cores (A.B) 5 cores (R.T.S.V)		ø3.5, 2 m Conductor area: 0.15 mm ² (AWG26) Insulator O.D.: 0.95 mm		
Standards	CE UL/CSA (E216656) RoHS				
Cleanliness class (ISO class)	Class 4				

Piping Specifications

Model	02	N02	F02	C01	A2	B2
Port size	R1/4	NPT1/4	G1/4	Rc1/8	UR,J1/4	TSJ1/4
Weight (Bottom ported)	117 g	118 g	—	114 g	120 g	111 g
Weight (Rear ported)	89 g	90 g	86 g	86 g	92 g	83 g
Leakage	1 x 10 ⁻⁶ Pa·m ³ /s			1 x 10 ⁻¹⁰ Pa·m ³ /s		

Set Pressure Range and Rated Pressure Range

Set the pressure within the rated pressure range.

The set pressure range is the range of pressure that is possible in setting.

The rated pressure range is the range of pressure that satisfies the specifications (accuracy, linearity, etc.) on the switch.

Although it is possible to set a value outside the rated pressure range, the specifications will not be guaranteed even if the value stays within the set pressure range.

Switch		Pressure range				
		-100 kPa	0	100 kPa	1 MPa	2 MPa
For vacuum pressure	10-ZSE80	-101 kPa	0	10 kPa		
		-111 kPa				
For compound pressure	10-ZSE80F	-100 kPa		100 kPa		
		-110 kPa		110 kPa		
For positive pressure	10-ISE80	-0.1 MPa			1 MPa	
		-0.105 MPa			1.1 MPa	
	10-ISE80H	-0.1 MPa				2 MPa
		-0.105 MPa				2.2 MPa

Rated pressure range of switch
 Set pressure range of switch

Analog Output

Voltage output

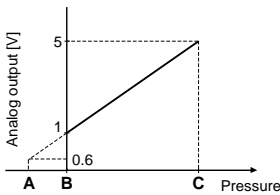

Current output

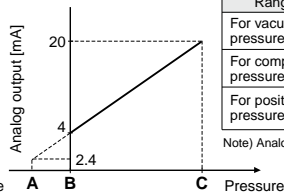

Range	Rated pressure range	A	B	C
For vacuum pressure	0.0 to -101.0 kPa	10.1 kPa	0	-101.0 kPa
For compound pressure	-100.0 to 100.0 kPa	—	-100.0 kPa	100.0 kPa
For positive pressure	-0.100 to 1.000 MPa	-0.100 MPa	0	1.000 MPa
	-0.100 to 2.00 MPa	-0.100 MPa ^{Note)}	0	2.00 MPa

Note) Analog output is 0.8 [V] or 3.2 [mA] at the pressure A.

Internal Circuit and Wiring Example

-N
NPN (1 outputs)

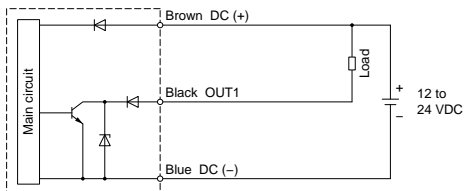

Max. 28 V, 80 mA
Residual voltage 1 V or less

-P
PNP (1 outputs)

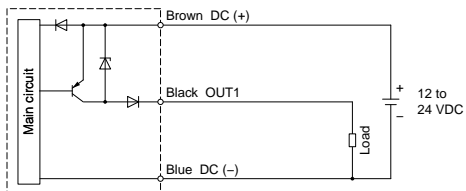

Max. 80 mA
Residual voltage 1 V or less

-A
NPN (2 outputs)

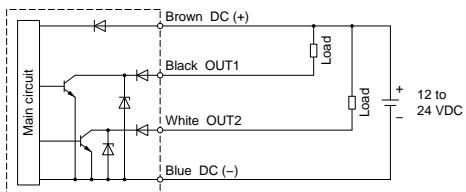

Max. 28 V, 80 mA
Residual voltage 1 V or less

-B
PNP (2 outputs)

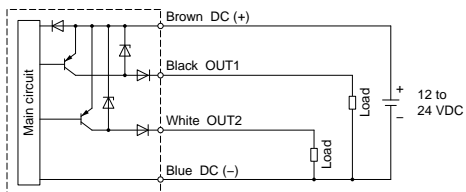

Max. 80 mA
Residual voltage 1 V or less

-R, -S
R: NPN (2 outputs) + Analog voltage output
S: NPN (2 outputs) + Analog current output

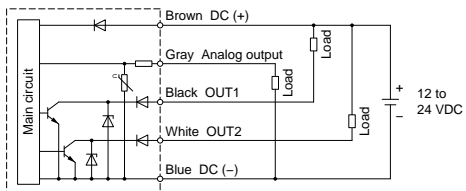

Max. 28 V, 80 mA
Residual voltage 1 V or less

-R/-S
NPN (2 outputs) + Auto-shift input

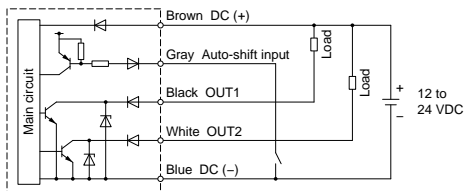

Max. 28 V, 80 mA
Residual voltage 1 V or less

-T, -V
T: PNP (2 outputs) + Analog voltage output
V: PNP (2 outputs) + Analog current output

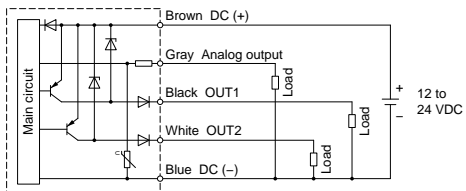

Max. 80 mA
Residual voltage 1 V or less

-T/-V
PNP (2 outputs) + Auto-shift input

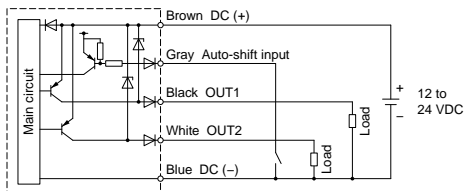

Max. 80 mA
Residual voltage 1 V or less

2-Color Display Digital Pressure Switch For General Fluids **10-ZSE80/10-ISE80**

Dimensions (For details about lead wires, refer to the product specifications.)

10-ZSE80/10-ISE80-02

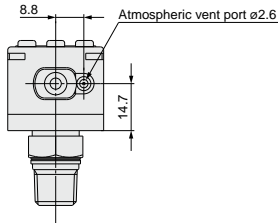
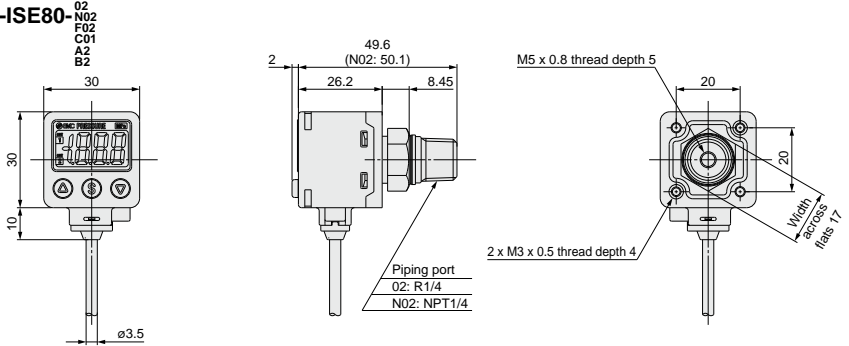

When the pressure switch is used in a place where water and dust splashes may occur, insert a tube into the atmospheric vent port, and route the other end of the tube to a safe place away from water and dust.
 * SMC TU0425 (polyurethane, O.D. ϕ 4, I.D. ϕ 2.5) suits to the pressure switch.

Note) If it is predicted that the pressure, such as the water hammer or surge pressure fluctuates rapidly, refer to the Handling Precautions stated in the Operation Manual at SMC website (<http://www.smworld.com>).

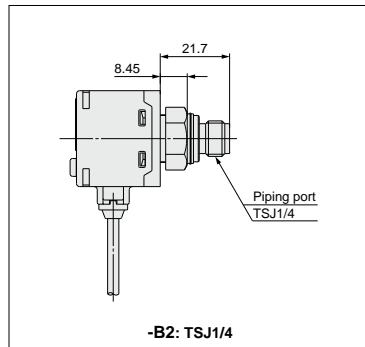
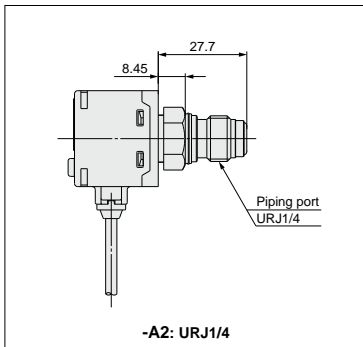
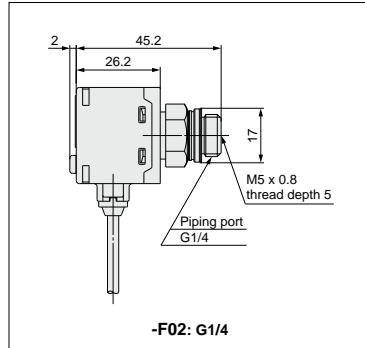
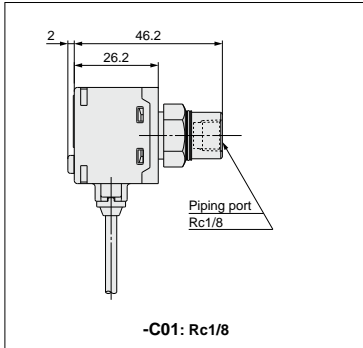

- Directional Control Valves
- Air Cylinders
- Rotary Actuators
- Air Grippers
- Air Preparation Equipment
- Modular F. R.
- Pressure Control Equipment
- Fittings & Tubing
- Flow Control Equipment
- Pressure Switches/ Pressure Sensors

Dimensions (For details about lead wires, refer to the product specifications.)

10-ZSE80/10-ISE80 ^{02L}
^{N02L}
^{C01L}
^{A2L}
^{B2L}

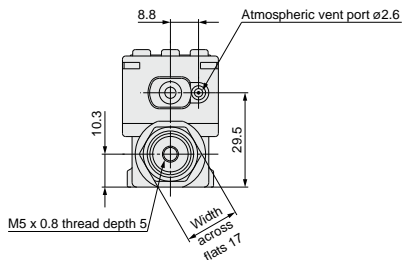
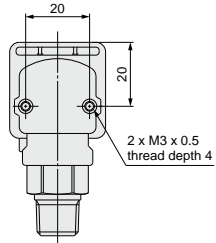
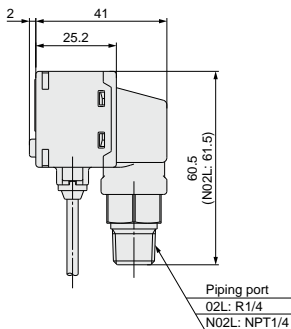
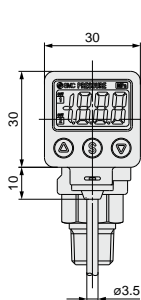

When the pressure switch is used in a place where water and dust splashes may occur, insert a tube into the atmospheric vent port, and route the other end of the tube to a safe place away from water and dust.
 * SMC TU0425 (polyurethane, O.D. ϕ 4, I.D. ϕ 2.5) suits to the pressure switch.

Note) If it is predicted that the pressure, such as the water hammer or surge pressure fluctuates rapidly, refer to the Handling Precautions stated in the Operation Manual at SMC website (<http://www.smcworld.com>).

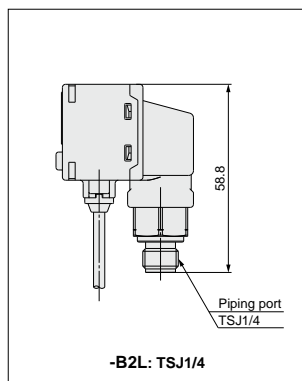
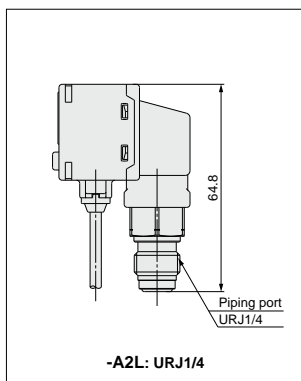
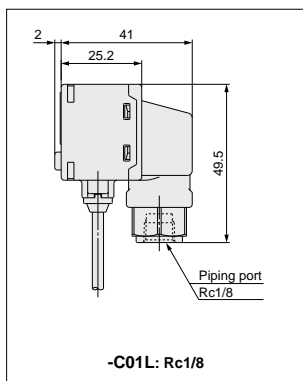

Dimensions (For details about lead wires, refer to the product specifications.)

With bracket (Rear ported)

- 10-ZS-24-A

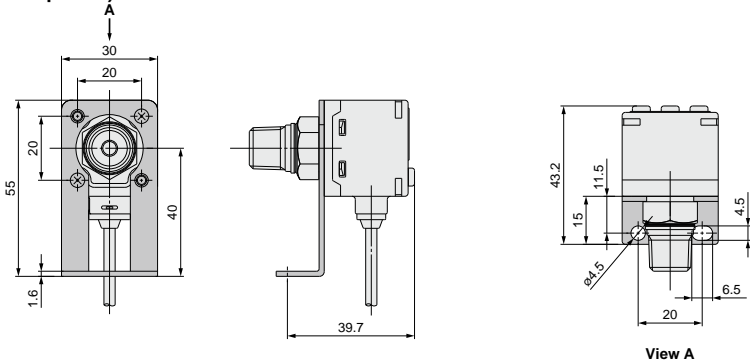

With bracket (Rear ported)

- 10-ZS-24-D

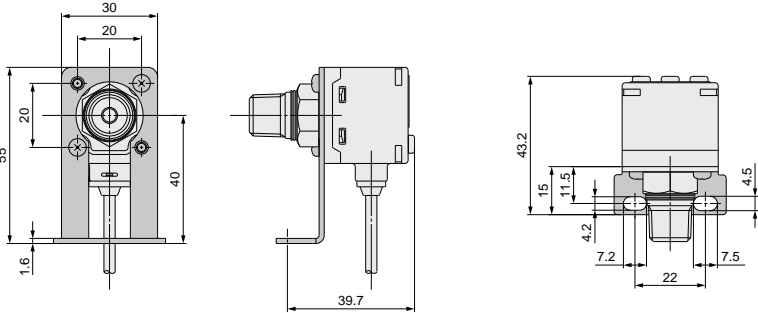

With bracket (Bottom ported)

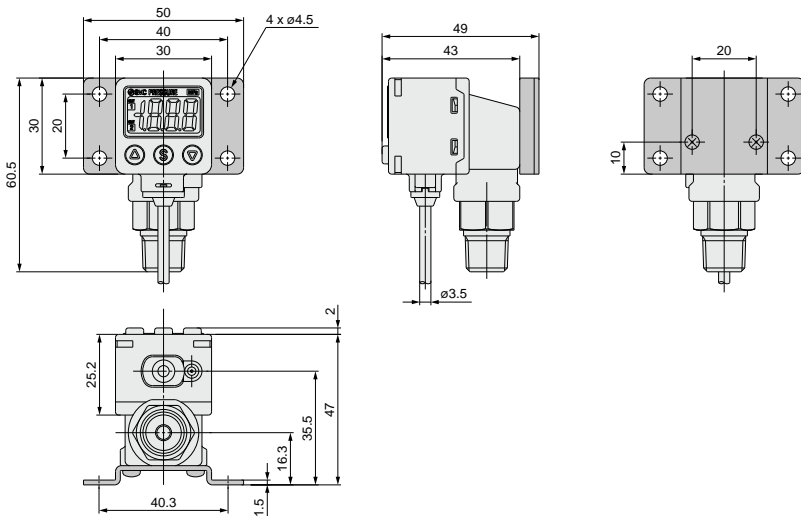

Directional Control Valves

Air Cylinders

Rotary Actuators

Air Grippers

Air Preparation Equipment

Modular F. R.

Pressure Control Equipment

Fittings & Tubing

Flow Control Equipment

Pressure Switches/ Pressure Sensors

Dimensions (For details about lead wires, refer to the product specifications.)

Panel mount (Rear ported)

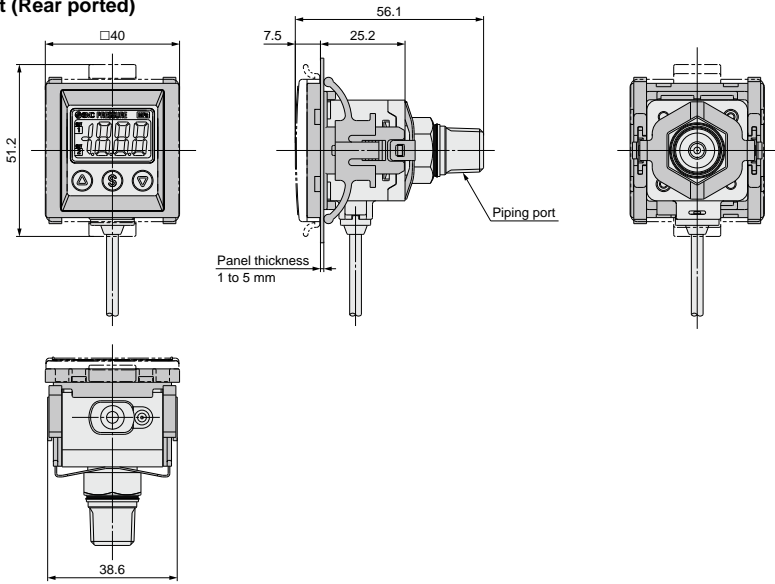

Panel-cut dimensions

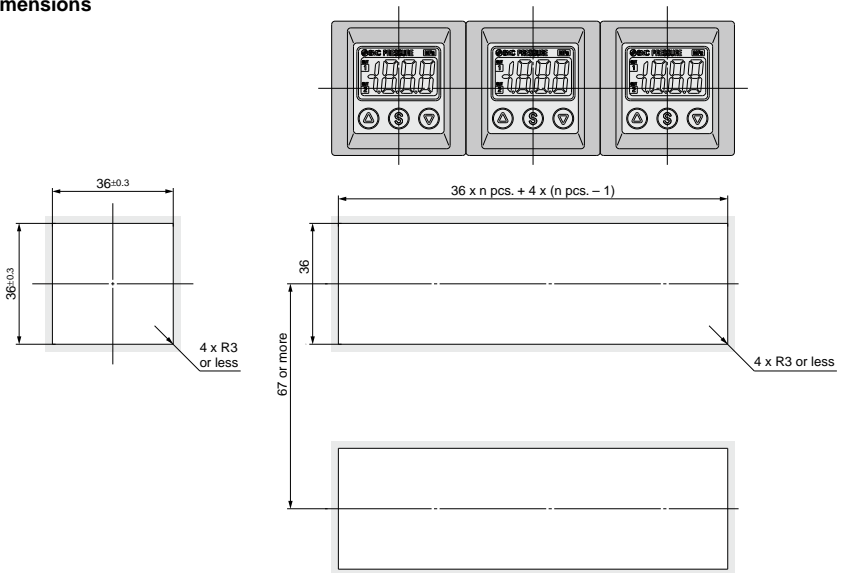

Dimensions (For details about lead wires, refer to the product specifications.)

Panel mount (Bottom ported)

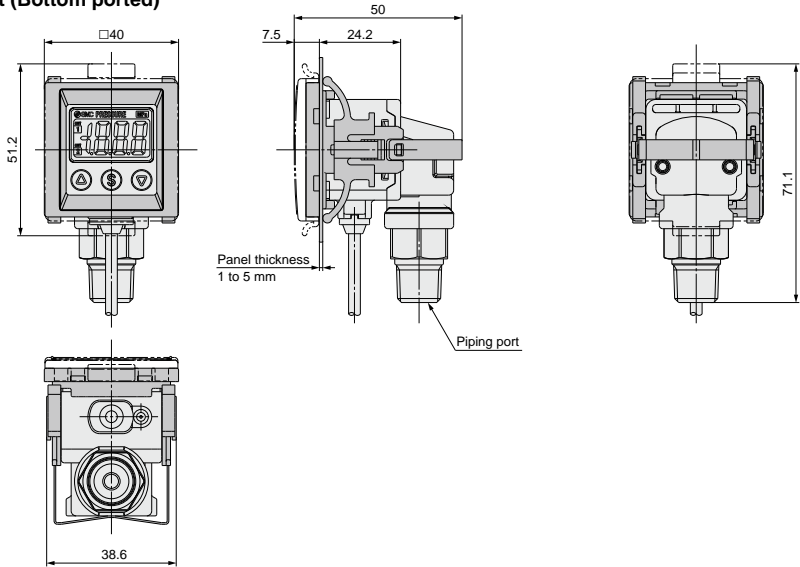

Panel-cut dimensions

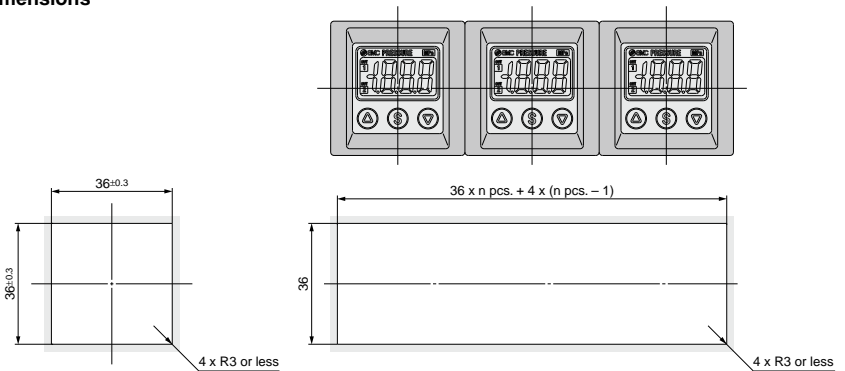

- Directional Control Valves
- Air Cylinders
- Rotary Actuators
- Air Grippers
- Air Preparation Equipment
- Modular F. R.
- Pressure Control Equipment
- Fittings & Tubing
- Flow Control Equipment
- Pressure Switches/ Pressure Sensors

□ in brackets stand for the function codes. Refer to the operating manual for how to operate and function codes in detail.

Function Details

A Auto-shift function (F4)

When there are large fluctuations in the supply pressure, the switch may fail to operate correctly. The auto-shift function compensates such supply pressure fluctuations. It measures the pressure at the time of auto-shift signal input and uses it as the reference pressure to correct the set-value on the switch.

Set-value correction by auto-shift function

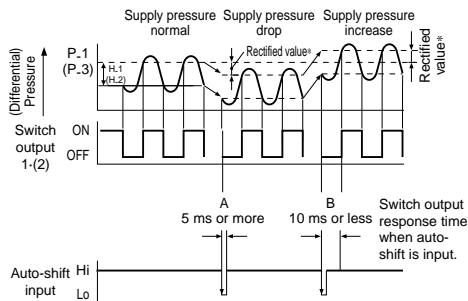

* Rectified value

When the auto-shift is selected, "ooo" will be displayed for approximately 1 second, and the pressure value at that point will be saved as a rectified value "C_5". Based on the saved rectified values, the set-value^(Note) of "P_1", "H_1", "P_2", and "H_2" will likewise be rectified.

Note) When an output is reversed, "n_1", "H_1", "n_2", "H_2" will be rectified.

Possible Set Range for Auto-Shift Input

	Regulating pressure range	Possible set range
Compound pressure	-110.0 to 110.0 kPa	-220 to 220 kPa
Vacuum pressure	10.0 to -111.0 kPa	121.0 to -121.0 kPa
Positive pressure	-0.105 to 1.100 MPa	-1.205 to 1.205 MPa
	-0.105 to 2.20 MPa	-2.31 to 2.31 MPa

Auto-shift zero

The basic function of auto-shift zero is the same as the function for auto-shift. Also, it corrects values on the display, based on a pressure value of 0, when the auto-shift is selected.

B Auto-preset function (F8)

Auto-preset function, when selected in the initial setting, calculates and stores the set-value from the measured pressure. The optimum set-value is determined automatically by repeating vacuum and break with the target workpiece several times.

Suction Verification

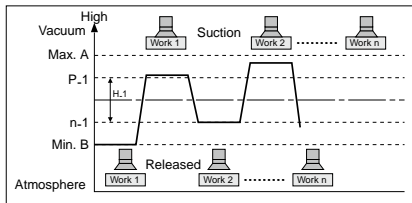

Formula for Obtaining the Set-Value

P_1 or P_2	H_1 or H_2
$P_1 (P_2) = A - (A-B)/4$	$H_1 (H_2) = (A-B)/2$
$n_1 (n_2) = B + (A-B)/4$	

C Precision indicator setting function (F7)

Fine adjustment of the indicated value can be made within the range of $\pm 5\%$ of the read value. The scattering of the indicated value can be eliminated.

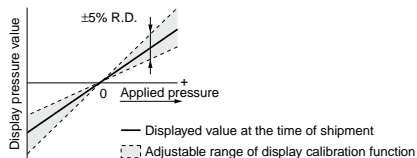

Note) When the precision indicator setting function is used, the set pressure value may change ± 1 digit.

D Peak and bottom display function

This function constantly detects and updates the maximum (minimum) value and allows to hold the maximum (minimum) pressure value.

When the \odot \ominus buttons are simultaneously pressed for 1 second or longer, while "holding", the hold value will be reset.

E Key lock function

This function prevents incorrect operations such as accidentally changing the set-value.

F Zero-out function

This function clears and resets the zero value on the display of measured pressure.

For the pressure switch with analog output, the analog output shifts according to the indication. A displayed value can be adjusted within $\pm 10\%$ F.S. of the pressure when ex-factory.

Function Details

G Error indication function

Error name	Error code	Description
Overcurrent error	Er 1	Load current of switch output (OUT1) exceeds 80 mA.
	Er 2	Load current of switch output (OUT2) exceeds 80 mA.
Residual pressure error	Er 3	It is still applied with pressure that is $\pm 10\%$ over the atmospheric pressure and the upper limit of the rated pressure range when it is cleared to zero. * After displaying the error code for 1 second, the switch automatically returns to the measuring mode. Due to individual product differences, the setting range varies ± 1 digits.
Applied pressure error	HHH	Supply pressure exceeds the maximum set pressure.
	LLL	Supply pressure is below the minimum set pressure.
Auto-shift error	or	The value measured at the time of auto-shift input is outside the set pressure range. * After displaying the error code for one second, the switch returns to the measuring mode.
System error	Er 0	Internal data error
	Er 4	Internal data error
	Er 7	Internal data error

H Anti-chattering function (F3)

A large bore cylinder or ejector consumes a large volume of air in operation and may experience a temporary drop in the supply pressure. This function prevents detection of such temporary drops in the supply pressure as an error.

Available response time settings
20 ms, 100 ms, 500 ms, 1000 ms, 2000 ms

<Principle>

This function averages pressure values measured during the response time set by the user and then compares the average pressure value with the pressure set point value to output the result on the switch.

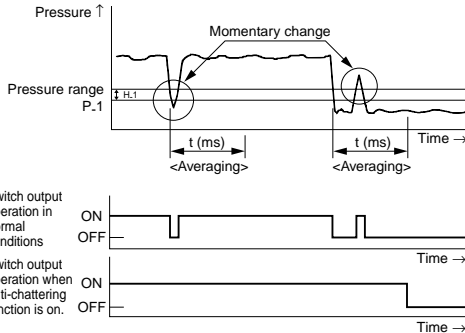

I Display unit switching function (F0)

Display units can be switched with this function.

Pressure range	For compound pressure	For vacuum pressure	For positive pressure	
Applicable pressure sensor	10-ZSE80F	10-ZSE80	10-ISE80	10-ISE80H*
Set pressure range	-110 to 110 kPa	10 to -111 kPa	-0.1 to 1.1 MPa	-0.1 to 2.2 MPa
Pa	kPa	0.1	0.1	1
	MPa	0.001	0.001	0.001
Gf	kgf/cm ²	0.001	0.001	0.01
bBr	bar	0.001	0.001	0.01
PS	psi	0.02	0.02	0.1
inH	inHg	0.1	0.1	—
mmH	mmHg	1	1	—

* 10-ISE80H: Does not indicate the last digit when the pressure is 2.000 MPa or higher.

J Power-saving mode (F9)



The numerical value disappears and the decimal points blink.

Power-saving mode can be selected.

It shifts to the power-saving mode without button operation for 30 seconds. It is set to the normal mode (Power-saving mode is OFF) when ex-factory. (Decimal points and operation indicator light (only when the switch output is turned ON.) blink in the power-saving mode.)

K Secret code setting (F10)



Input an arbitrary three-digit value.

* The set-value can be confirmed when the key is locked.

It can be set whether code number input is required or not when key is locked. It is set to input no code number when ex-factory.

Series 10-ZSE80/10-ISE80

Made to Order

Please contact SMC for detailed dimensions, specifications, and lead times.



Symbol

Lead wire length 3 m

-X501

It has a lead wire extended to 3 meters.

How to Order

* Refer to How to Order on page 1340 for standard specifications.

10-ZSE80(F)/10-ISE80(H) - □ - □ - □ - X501

Piping*

Output*

Option*

Pressure Switches/
Pressure Sensors

Flow Control
Equipment

Fittings & Tubing

Pressure Control
Equipment

Modular F. R.

Air Preparation
Equipment

Air Grippers

Rotary Actuators

Air Cylinders

Directional
Control Valves

Series 10-PSE530

Remote Type Pressure Sensor/For Compact Pneumatic Pressure

How to Order

RoHS

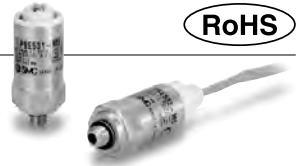

Clean series
10-PSE530 **0** **M5**

Pressure sensing range

0	High pressure [0 to 1 MPa]
1	Vacuum [0 to -101 kPa]
2	Low pressure [0 to 101 kPa]
3	Compound pressure [-101 to 101 kPa]

Port size

M5	M5 x 0.8
R06	ø6 reducer
R07	1/4-inch reducer

Option

Nil	Without cable
L	Sensor cable (3 m)
	Connector for pressure sensor controller connection (1 pc.) + Cable for sensor (3 m)
C2L	

Note) At the factory, the connector is not connected to the cable, but packed together with it for shipment.

Option

When only optional parts are required, order using the part numbers listed below.

Description	Part no.	Note
Connector	10-ZS-28-C	1 pc. per set
Sensor cable	10-ZS-26-F	Cable length: 3 m
Connector for pressure sensor controller connection + Sensor cable	10-ZS-26-J	The connector is not connected to the cable at the time of shipment.

Specifications

Refer to the SMC website for Pressure Switches Precautions (M-E03-3) and Specific Product Precautions (Operation Manual).

Model	10-PSE530 (Positive pressure)	10-PSE531 (Vacuum)	10-PSE532 (Low pressure)	10-PSE533 (Compound pressure)
Rated pressure range	0 to 1 MPa	0 to -101 kPa	0 to 101 kPa	-101 to 101 kPa
Extension analog output range	-0.1 to 0 MPa	10.1 to 0 kPa	-10.1 to 0 kPa	—
Proof pressure	1.5 MPa	500 kPa		
Applicable fluid	Air/Non-corrosive gas/Non-flammable gas			
Power supply voltage	12 to 24 VDC ±10%, Ripple (p-p) 10% or less (with power supply polarity protection)			
Current consumption	15 mA or less (with no load)			
Output specification	Analog output 1 to 5 V (with rated pressure range), 0.6 to 1 V (with extension analog output range), Output impedance: Approx. 1 kΩ			
Accuracy (Ambient temperature at 25°C)	±2% F.S. (with rated pressure range), ±5% F.S. (with extension analog output range)			
Linearity	±1% F.S.			
Repeatability	±1% F.S.			
Power supply voltage effect	±1% F.S. based on the analog output at 18 V ranging from 12 to 24 VDC			
Environment	Enclosure	IP40		
	Temperature range	Operating: 0 to 50°C; Stored: -10 to 70°C (No freezing or condensation)		
	Withstand voltage	1000 VAC (in 50/60 Hz) for 1 minute between terminals and housing		
	Insulation resistance	5 MΩ or more (500 VDC measured via megohmmeter) between terminals and housing		
Temperature characteristics	±2% F.S. (25°C reference)			
Sensor cable/Option	Halogen-free heavy-duty cable, 3 cores, ø2.7, 3 m, Conductor area: 0.15 mm ² , Insulator O.D.: 0.8 mm			
Standards	CE, RoHS			
Cleanliness class (ISO class)	Class 4			

Piping Specifications

Model	M5	R06	R07
Port size	M5 x 0.8 male	ø6 reducer type	1/4-inch reducer type
Wetted parts material	Pressure sensor: Silicon, O-ring: FKM		
	Body: Stainless steel 304	Body: PBT	
Weight	With sensor cable (3 m)	41 g	38 g
	Without sensor cable	7 g	3.8 g

⚠ Caution

This product is blown with air and double packed in a Class M3.5 (ISO Class 5) clean room.

Internal Circuit

10-PSE53□

Voltage output type
1 to 5 V
Output impedance
Approx. 1 kΩ

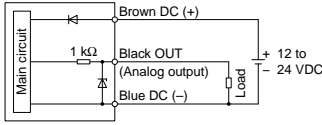

Analog Output

1 to 5 VDC

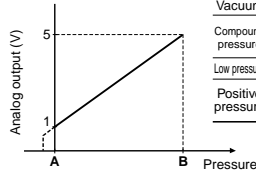

Range	Rated pressure range	A	B
Vacuum	0 to -101 kPa	0	-101 kPa
Compound pressure	-101 kPa to 101 kPa	-101 kPa	101 kPa
Low pressure	0 to 101 kPa	0	101 kPa
Positive pressure	0 to 1 MPa	0	1 MPa
	0 to 500 kPa	0	500 kPa

Dimensions

10-PSE53□-M5

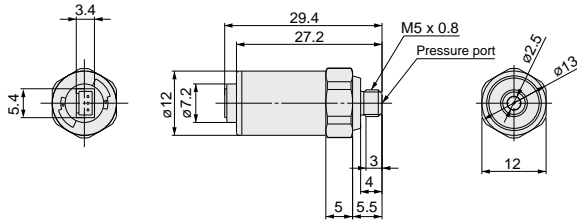

**10-PSE53□-R06
R07**

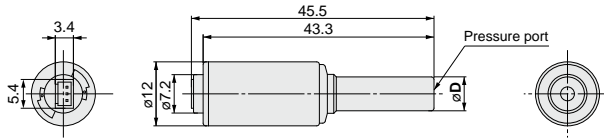

Model	Applicable fitting size (D)
10-PSE53□-R06	6
10-PSE53□-R07	1/4"

With sensor cable

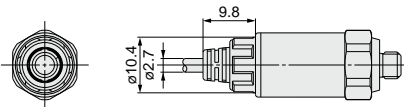

Directional Control Valves

Air Cylinders

Rotary Actuators

Air Grippers

Air Preparation Equipment

Modular F. R.

Pressure Control Equipment

Fittings & Tubing

Flow Control Equipment

Pressure Switches/ Pressure Sensors

Series 10-PSE540

Remote Type Pressure Sensor/For Compact Pneumatic Pressure

How to Order

Pressure sensing range		Accuracy	
0	Positive pressure [0 to 1 MPa]	Nil	±2% F.S.
1	Vacuum [0 to -101 kPa]	A	±1% F.S.
3	Compound pressure [-100 to 100 kPa]		



10 — PSE54 1 [] M3 []

Clean series

Option (connector)

Nil	C2
Without connector	Connector for pressure sensor controller 1 pc.

Note) At the factory, the connector is not connected to the cable, but packed together with it for shipment.

Port size

M3	M3 x 0.5		IM5	M5 female thread, through type	
M5	M5 x 0.8		IM5H	M5 female thread, through type (with mounting hole)	
01	R 1/8 (with M5 female thread)				
N01	NPT 1/8 (with M5 female thread)				
R04	ø4 reducer				
R06	ø6 reducer				

Option/Part No.

Description	Part no.	Note
Connector for pressure sensor controller	10-ZS-28-C	1 pc.

Specifications

Refer to the SMC website for Pressure Switches Precautions (M-E03-3) and Specific Product Precautions (Operation Manual).

Model	10-PSE540	10-PSE541	10-PSE543
Rated pressure range	0 to 1 MPa	0 to -101 kPa	-100 to 100 kPa
Extension analog output range	-0.1 to 0 MPa	10.1 to 0 kPa	—
Proof pressure	1.5 MPa	500 kPa	
Applicable fluid	Air/Non-corrosive gas/Non-flammable gas		
Power supply voltage	12 to 24 VDC±10%, Ripple (p-p) 10% or less (with power supply polarity protection)		
Current consumption	15 mA or less		
Output specification	Analog output 1 to 5 V (with rated pressure range), 0.6 to 1 V (with extension analog output range), Output impedance: Approx. 1 kΩ		
Accuracy (Ambient temperature at 25°C)	10-PSE54□: ±2% F.S. (with rated pressure range), ±5% F.S. (with extension analog output range) 10-PSE54□A: 1% F.S. (with rated pressure range), ±3% F.S. (with extension analog output range)		
Linearity	±0.7% F.S. or less		±0.4% F.S.
Repeatability		±0.2% F.S.	
Power supply voltage effect		±0.8% F.S.	
Environment	Enclosure	IP40	
	Operating temperature range	Operating: 0 to 50°C, Stored: -20 to 70°C (No freezing or condensation)	
	Operating humidity range	Operating/Stored: 35 to 85% RH (No condensation)	
	Withstand voltage	1000 VAC (in 50/60 Hz) for 1 minute between terminals and housing	
Insulation resistance	50 MΩ or more (500 VDC measured via megohmmeter) between terminals and housing		
Temperature characteristics	±2% F.S. (Based on 25°C)		
Sensor cable	Oilproof heavy-duty vinyl cable (ellipse), 3 cores, 2.7 x 3.2, 3 m, Conductor area: 0.15 mm ² , Insulator O.D.: 0.9 mm		
Standards	CE, UL/CSA (E216656), RoHS		
Cleanliness class (ISO class)	Class 4		

Piping Specifications

Model	M3	M5	1	N01	R04	R06	IM5	IM5H
Port size	M3 x 0.5	M5 x 0.8	R 1/8	NPT 1/8	ø4	ø6	M5 female thread, through type	M5 female thread, through type with mounting hole
Material	Resin case: PBT Fitting: Stainless steel 303		Resin case: PBT Fitting: C3604BD		PBT		Resin case: PBT Fitting: A6063S-T5	
	Pressure sensing section: Silicon, O-ring: FKM							
Sensor cable	3-wire oval cable (0.15 mm ²)							
Weight	With sensor cable	42.4 g	42.7 g	49.3 g	41.4 g	41.6 g	43.3 g	44.1 g
	Without sensor cable	2.9 g	3.2 g	9.8 g	1.9 g	2.1 g	3.8 g	4.6 g

Caution

This product is blown with air and double packed in a Class M3.5 (ISO Class 5) clean room.

Internal Circuit

10-PSE54□
 Voltage output type
 1 to 5 V
 Output impedance
 Approx.1 kΩ

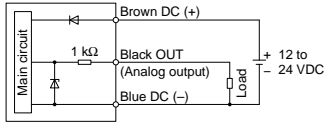

Analog Output

1 to 5 VDC

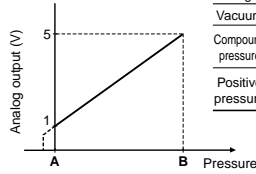

Range	Rated pressure range	A	B
Vacuum	0 to -101 kPa	0	-101 kPa
Compound pressure	-100 kPa to 100 kPa	-100 kPa	100 kPa
Positive pressure	0 to 1 MPa	0	1 MPa

Dimensions

10-PSE54□-M3
M5



10-PSE54□-R04
R06

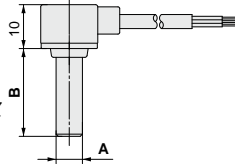
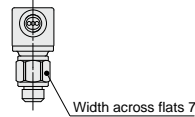
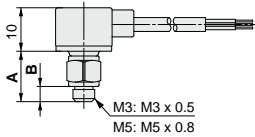

	10-PSE54□-M3	10-PSE54□-M5
A	10.8	11.5
B	3	3.5

	10-PSE54□-R04	10-PSE54□-R06
A	∅4	∅6
B	18	20

Common dimensions

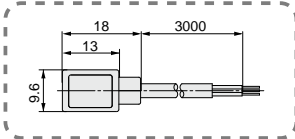

10-PSE54□-IM5

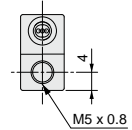
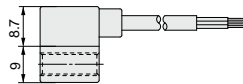

10-PSE54□-01
N01



10-PSE54□-IM5H

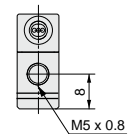
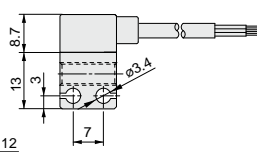
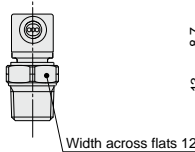
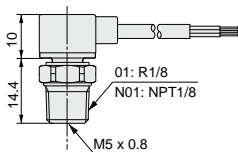

Directional Control Valves
 Air Cylinders
 Rotary Actuators
 Air Grippers
 Air Preparation Equipment
 Modular F. R.
 Pressure Control Equipment
 Fittings & Tubing
 Flow Control Equipment
 Pressure Switches/ Pressure Sensors

Series 10-PSE550

Remote Type Pressure Sensor/For Low Differential Pressure

How to Order



10-PSE550

• Clean series

Output specifications

NII	1 to 5 V voltage output type
28	4 to 20 mA current output type

Option 1 (Bracket)

NII	Without bracket
A	Bracket

(Note) Brackets are packed together without being assembled.

Option 2 (Connector)

NII	Without connector
C2	Connector for PSE300, pressure sensor monitor: 1 pc.

Note 1) The current output type cannot be connected to series PSE300.
Note 2) Connector is packed together without being connected to the cable.

Options/Part No.

Description	Part no.	Note
Bracket	10-ZS-30-A	With M3 x 5L (2 pcs.)
Connector for PSE300 pressure sensor monitor	10-ZS-28-C	1 pc.

Specifications

Refer to the SMC website for Pressure Switches Precautions (M-E03-3) and Specific Product Precautions (Operation Manual).

Model	10-PSE550	10-PSE550-28
Rated differential pressure range	0 to 2 kPa	
Operating pressure range	-50 to 50 kPa (Note)	
Extension analog output range	-0.2 to 0 kPa	—
Proof pressure	65 kPa	
Applicable fluid	Air/Non-corrosive gas/Non-flammable gas	
Power supply voltage	12 to 24 VDC±10%, Ripple (p-p) 10% or less (with power supply polarity protection)	
Current consumption	15 mA or less	—
Output specification	Analog output: 1 to 5 VDC (within rated differential pressure range) 0.6 to 1 VDC (with extension analog output range) Output impedance: Approx. 1 kΩ	Analog output: 4 to 20 mA DC (within rated differential pressure range) Allowable load impedance: 500 Ω or less (at 24 VDC) 100 Ω or less (at 12 VDC)
Accuracy (Operating temperature at 25°C)	±1% F.S. (with rated pressure range), ±3% F.S. (with extension analog output range)	
Linearity	±0.5% F.S.	
Repeatability	±0.3% F.S.	
Indicator light	Orange light is turned on. (When energized)	
Environment	Enclosure	IP40
	Operating temperature range	Operating: 0 to 50°C, Stored: -20 to 70°C (No freezing or condensation)
	Operating humidity range	Operating/Stored: 35 to 85% RH (No condensation)
	Withstand voltage	1000 VAC (in 50/60 Hz) for 1 minute between terminals and housing
Insulation resistance	50 MΩ or more (500 VDC measured via megohmmeter) between terminals and housing	
Temperature characteristics	±3% F.S. (25°C reference)	
Port size	ø4.8 (ø4.4 in the end) resin piping (Applicable to I.D. ø4 air tubing)	
Wetted parts material	Resin pipe: Nylon, Piston area of sensor: Silicon	
Sensor cable	Oilproof heavy-duty vinyl cable (ellipse), 3 cores, 2.7 x 3.2, 3 m Conductor area: 0.15 mm ² , Insulator O.D.: 0.9 mm	Oilproof heavy-duty vinyl cable (ellipse), 2 cores, 2.7 x 3.2, 3 m Conductor area: 0.15 mm ² , Insulator O.D.: 0.9 mm
Weight	With sensor cable	75 g
	Without sensor cable	35 g
Standards	CE, UL/CSA (E216656), RoHS	
Cleanliness class (ISO class)	Class 4	

(Note) The differential pressure of 0 to 2 kPa can be detected within the range of -50 to 50 kPa.

Caution

This product is blown with air and double packed in a Class M3.5 (ISO Class 5) clean room.

Internal Circuit

10-PSE550

Voltage output type
1 to 5 V
Output impedance
Approx.1 kΩ

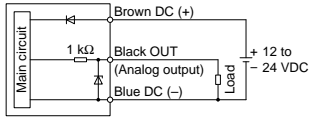

10-PSE550-28

Current output type
4 to 20 mA
Allowable load impedance
500 Ω or less (at 24 VDC)
100 Ω or less (at 12 VDC)

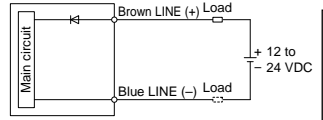

* Install the load either on the LINE (+) or LINE (-) side.

Analog Output

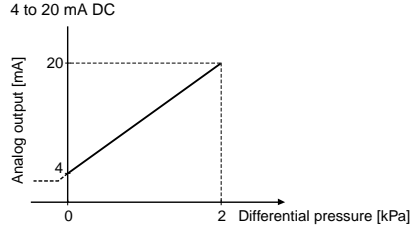
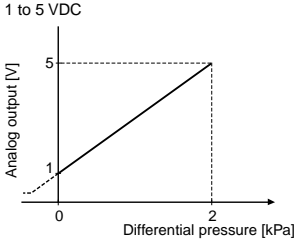

Dimensions

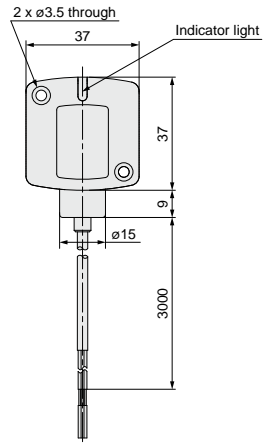
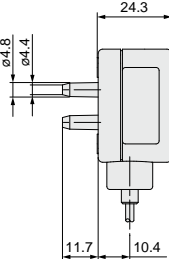
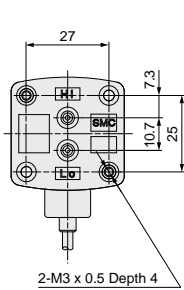

With bracket

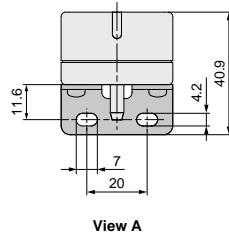
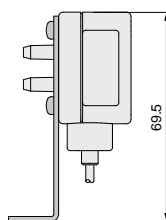
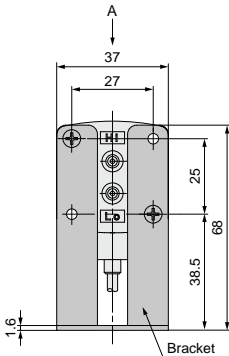

Directional Control Valves
 Air Cylinders
 Rotary Actuators
 Air Grippers
 Air Preparation Equipment
 Modular F. R.
 Pressure Control Equipment
 Fittings & Tubing
 Flow Control Equipment
 Pressure Switches/ Pressure Sensors

Series 10-PSE560

Remote Type Pressure Sensor/For General Fluids

How to Order

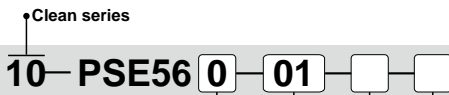

Sensor range

0	For positive pressure (0 to 1 MPa)
1	For vacuum pressure (0 to -101 kPa)
3	For compound pressure (-100 to 100 kPa)
4	For positive pressure (0 to 500 kPa)

Port size

01	R1/8 (with M5 female thread)
02	R1/4 (with M5 female thread)
C01	Rc1/8
N01	NPT1/8 (with M5 female thread)
N02	NPT1/4 (with M5 female thread)
A2	URJ1/4
B2	TSJ1/4

Option (Connector)

Nil	C2
Without connector	Connector for pressure sensor monitor 1 pc.

Note 1) Current output type cannot be connected to PSE20□ and PSE30□.

Note 2) At the factory, the connector is not connected to the cable, but packed together with it for shipment.

Output specifications

Nil	1 to 5 V voltage output type
28	4 to 20 mA current output type

Option/Part No.

Description	Part no.	Note
Connector for pressure sensor monitor	10-ZS-28-C	1 pc.

Specifications

Refer to the SMC website for Pressure Switches Precautions (M-E03-3) and Specific Product Precautions (Operation Manual).

Model	10-PSE560 (Positive pressure)	10-PSE561 (Vacuum)	10-PSE563 (Compound pressure)	10-PSE564 (Positive pressure)
Rated pressure range	0 to 1 MPa	0 to -101 kPa	-100 to 100 kPa	0 to 500 kPa
Extension analog output range	-0.1 to 0 MPa	10.1 to 0 kPa	—	-50 to 0 kPa
Proof pressure	1.5 MPa	500 kPa	500 kPa	750 kPa

Model	10-PSE56□-□	10-PSE56□-□-28
Applicable fluid	Liquid or gas that will not corrode stainless steel 316L	
Power supply voltage	12 to 24 VDC ±10%, Ripple (p-p) 10% or less (with power supply polarity protection)	
Current consumption	10 mA or less	
Output specifications	Analog output: 1 to 5 V (within rated differential pressure range) 0.6 to 1 V (with extension analog output range) Output impedance: Approx. 1 kΩ	Analog output: 4 to 20 mA DC (within rated differential pressure range) Allowable load impedance: 500 Ω or less (at 24 VDC) 100 Ω or less (at 12 VDC)
Accuracy (Ambient temperature at 25°C)	±1% F.S. (with rated pressure range), ±3% F.S. (with extension analog output range)	
Linearity	±0.5% F.S.	
Repeatability	±0.2% F.S.	
Power supply voltage effect	±0.3% F.S.	
Environment	IP65	
Operating temperature range	Operating: -10 to 60°C, Stored: -20 to 70°C (No freezing or condensation)	
Operating humidity range	Operating/Stored: 35 to 85% RH (No condensation)	
Withstand voltage	250 VAC for 1 minute between terminals and housing	
Insulation resistance	50 MΩ or more (50 VDC measured via megohmmeter) between terminals and housing	
Temperature characteristics	±2% F.S. (0 to 50°C: Based on 25°C), ±3% F.S. (-10 to 60°C: Based on 25°C)	
Sensor cable	10-PSE56□-□: Oilproof heavy-duty vinyl cable with air tubing, 3 cores, ø5.1, 3 m, Conductor area: 0.2 mm ² , Insulator O.D.: 1.12 mm 10-PSE56□-□-28: Oilproof heavy-duty vinyl cable with air tubing, 2 cores, ø5.1, 3 m, Conductor area: 0.2 mm ² , Insulator O.D.: 1.12 mm	
Standards	CE, UL/CSA (E216656), RoHS	
Cleanliness class (ISO class)	Class 4	

Piping Specifications

Model	01	02	N01	N02	C01	A2	B2
Port size	R1/8 M5 x 0.8	R1/4 M5 x 0.8	NPT1/8 M5 x 0.8	NPT1/4 M5 x 0.8	Rc1/8	URJ1/4	TSJ1/4
Material	Case: C3604 + Nickel-plated, Piping port and pressure sensor: stainless steel SUS 316L						
Weight	193 g	200 g	194 g	201 g	187 g	203 g	193 g
	101 g	108 g	102 g	109 g	95 g	111 g	101 g

Caution This product is blown with air and double packed in a Class M3.5 (ISO Class 5) clean room.

Internal Circuit

10-PSE56□-□
Voltage output type
1 to 5 V
Output impedance
Approx.1 kΩ

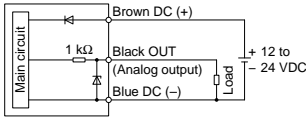

10-PSE56□-□-28
Current output type
4 to 20 mA
Allowable load impedance
500 Ω or less (at 24 VDC)
100 Ω or less (at 12 VDC)

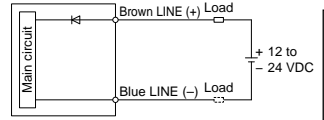

* Install the load either on the LINE (+) or LINE (-) side.

Analog Output

1 to 5 VDC

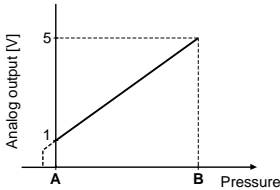

4 to 20 mA DC

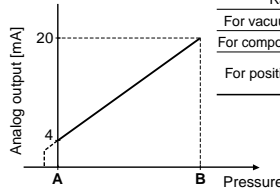

Range	Rated pressure range	A	B
For vacuum pressure	0 to -101 kPa	0	-101 kPa
For compound pressure	-100 kPa to 100 kPa	-100 kPa	100 kPa
For positive pressure	0 to 1 MPa	0	1 MPa
	0 to 500 kPa	0	500 kPa

Dimensions

10-PSE56□-01 / 10-PSE56□-N01
02 / N02

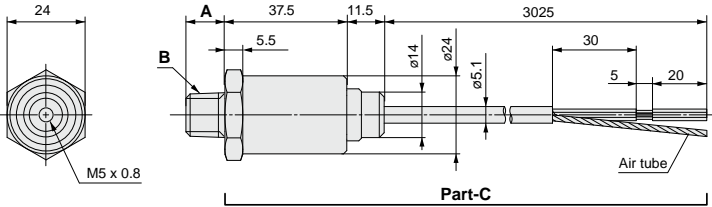

* Dimensions and size of part C are all common.

10-PSE56□-C01

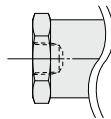
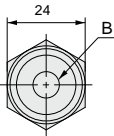

10-PSE56□-A2

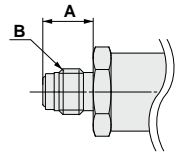
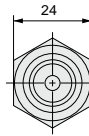

10-PSE56□-B2

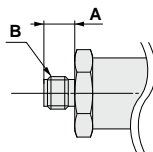
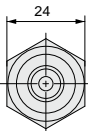

Part no.	A	B
10-PSE56□-01	8.2	R1/8
10-PSE56□-02	12	R1/4
10-PSE56□-N01	9.2	NPT1/8
10-PSE56□-N02	12.2	NPT1/4
10-PSE56□-C01	—	Rc1/8
10-PSE56□-A2	15.5	URJ1/4
10-PSE56□-B2	9.5	TSJ1/4

Series 10-PSE200

Remote Type
Multi-Channel Digital Pressure Sensor Controller

How to Order



Clean series

10-PSE200 M

Input/Output specifications

0	NPN 5 outputs + Auto shift input
1	PNP 5 outputs + Auto shift input

Unit specifications

Nil	With unit switching function <small>Note 1)</small>
M	Fixed SI unit <small>Note 2)</small>

Note 1) Under the New Measurement Law, sales of switches with the unit switching function are not allowed for use in Japan.

Note 2) Fixed unit:
For vacuum/low pressure /compound pressure: kPa
For positive pressure: MPa

Option 2

Nil	Without connector
4C	Sensor connectors (4 pcs.)

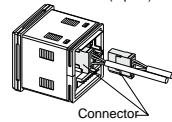

Option 1

Nil	Without panel mount/protective cover
A	Panel mount adapter Waterproof seal (Accessory) Panel mount adapter Panel Mounting screws (M3 x 8L) (Accessory)
B	Front protective cover + Panel mount adapter Front protective cover Waterproof seal (Accessory) Panel mount adapter Panel Mounting screws (M3 x 8L) (Accessory)

Accessory: Power supply/Output connection cable (2m)
Attached to the controller.

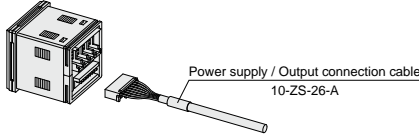

Option

When only optional parts are required, order with the part numbers listed below.

Description	Part no.	Note
Panel mount adapter	10-ZS-26-B	With waterproof seal and mounting screw
Front protective cover + Panel mount adapter	10-ZS-26-C	With waterproof seal and mounting screw

48 conversion adapter
This adapter is used to mount PSE200 on the panel fitting of PSE100.

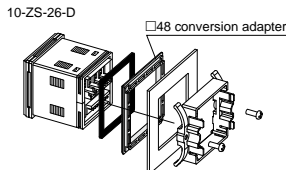

Order panel mount adapter separately.

Sensor connector	10-ZS-28-C (1 pc. per set)
------------------	----------------------------

Refer to the SMC website for Pressure Switches Precautions (M-E03-3) and Specific Product Precautions (Operation Manual).

Specifications

Model		10-PSE200	10-PSE201
Power supply voltage		12 to 24 VDC, Ripple (p-p) 10% or less (with power supply polarity protection)	
Current consumption		55 mA or less (Current consumption for sensor is not included.)	
Power supply voltage for sensor		[Power supply voltage] -1.5 V	
Power supply current for sensor <small>Note 1)</small>		40 mA maximum (100 mA maximum for the total power supply current when 4 sensors are input)	
Sensor input		1 to 5 VDC (Input impedance: Approx. 800 kΩ)	
Number of inputs	Input protection	4 inputs	
		With excess voltage protection (up to 26.4 V)	
Switch output	Maximum load current	NPN open collector: 5 outputs (Sensor input CH: 2 outputs, CH2 to 4: 1 output)	PNP open collector: 5 outputs (CH: 2 outputs, CH2 to 4: 1 output)
	Maximum applied voltage	30 V	—
	Residual voltage	80 mA	
	Response time	1 V or less (with load current of 80 mA)	
	Short-circuit protection	5 ms or less (With anti-chattering function, Response time selection: 20 ms, 160 ms, 640 ms)	
Repeatability	With short-circuit protection		
Hysteresis	Hysteresis mode	±0.1% F.S. ±1 digit or less	
	Window comparator mode	Adjustable (can be set from 0)	
Display	Fixed (3 digits)		
Display accuracy (at operating temperature 25°C)	For measured value display: 4-digit, 7-segment indicator, Display color: Orange (Sampling interval: 4 times/1s) For channel display: 1-digit, 7-segment indicator, Display color: Red		
Indicator light	±0.5% F.S. ±1 digit or less		
Auto shift input	Red (Lights up when output is ON.)		
Auto identification function	Non-voltage input (reed or solid state), Input 10 ms or more, Independently controllable auto shift function ON/OFF		
Environment resistance	Enclosure	With auto identification function <small>Note 2)</small>	
	Ambient temperature range	Front face: IP65 (with panel mount), Other: IP40 <small>Note 3)</small>	
	Ambient humidity range	Operating: 0 to 50°C, Stored: -10 to 60°C (with no condensation or freezing)	
Temperature characteristics	Operating/Stored: 35 to 85% RH (with no condensation)		
Connection	±0.5% F.S. or less (based on 25°C)		
Material	Power supply/Output connection: 8 P connector, Sensor connection: e-con		
Weight	Case: PBT; Display: Transparent nylon; Back rubber cover: CR		
Power supply/Output connection cable	Approx. 60 g (Power supply/Output connection cable not included)		
Standards	Oilproof heavy-duty vinyl cable, 8 cores, ø4.8, 2 m, Conductor area: 0.15 mm ² , Insulator O.D.: 0.9 mm		
Cleanliness class (ISO class)	CE, RoHS		
	Class 3		

Note 1) If the Vcc and 0 V side of the sensor input connector are short circuited, the inside of the monitor is damaged.

Note 2) Auto identification function comes with "Series PSE53□" pressure sensor only. Other SMC series (PSE540, PSE560) are not equipped with this function.

Note 3) IP40 when using the □48 conversion adapter.

Applicable Pressure Sensor

Applicable sensor				Rated pressure range				Setting/Display resolution
10-PSE53□	10-PSE54□	10-PSE55□	10-PSE56□	-100 kPa	0	100 kPa	1 MPa	
PSE531	PSE541	—	PSE561	-101 kPa		0		0.1 kPa
PSE533	PSE543	—	PSE563	-101 kPa			101 kPa	0.1 kPa
PSE530	PSE540	—	PSE560		0		1 MPa	0.001 MPa
PSE532		—			0		101 kPa	0.1 kPa

⚠ Caution

This product is blown with air and double packed in a Class M3.5 (ISO Class 5) clean room.

Internal Circuit

10-PSE200-(M) □

• NPN open collector 5 outputs + Auto shift 1 input specification

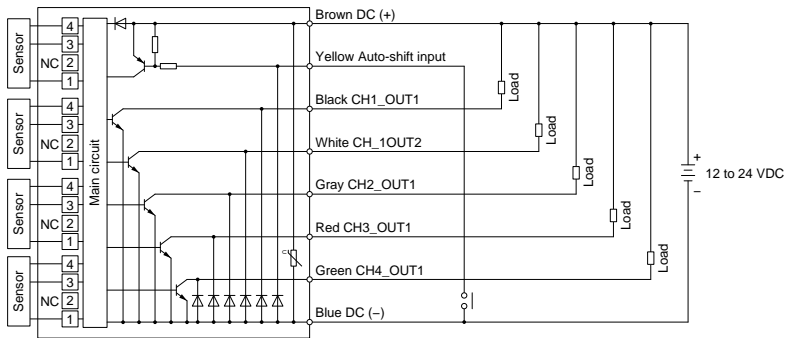

10-PSE201-(M) □

• PNP open collector 5 outputs + Auto shift 1 input specification

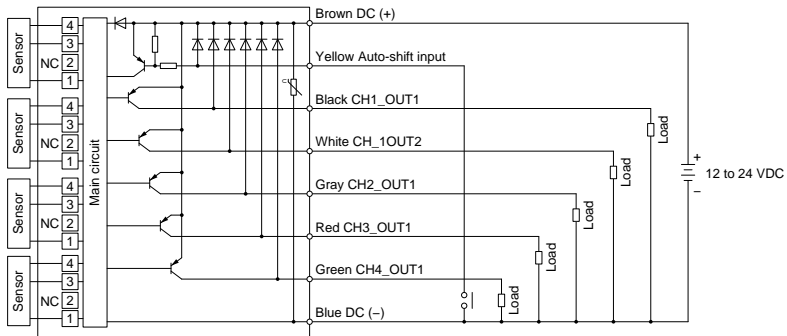

Dimensions

10-PSE200/201

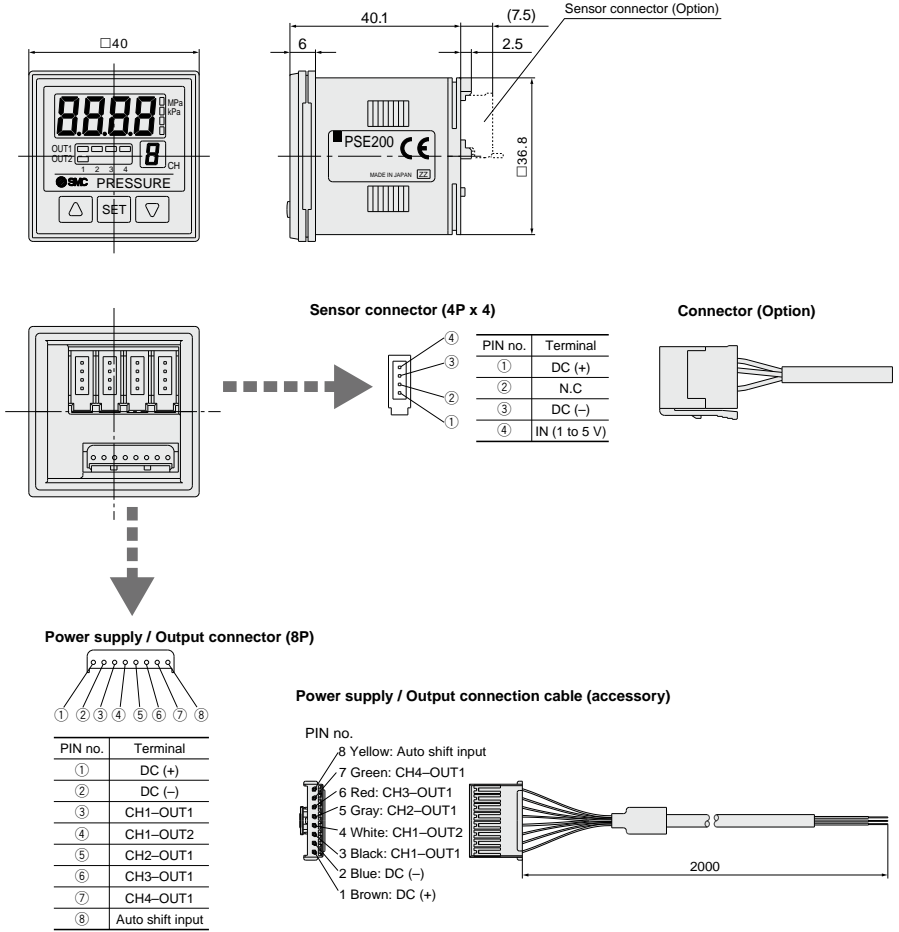

Directional Control Valves
Air Cylinders
Rotary Actuators
Air Grippers
Air Preparation Equipment
Modular F. R.
Pressure Control Equipment
Fittings & Tubing
Flow Control Equipment
Pressure Switches/ Pressure Sensors

Dimensions

Front protective cover + Panel mount

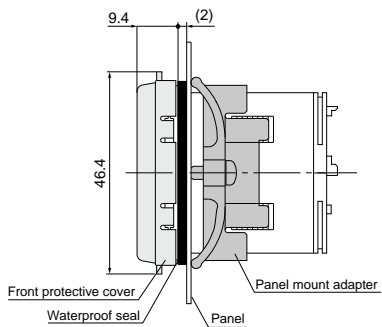
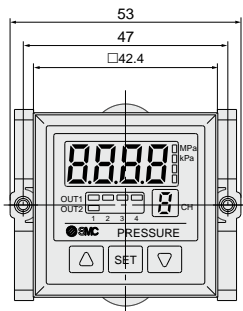

□48 conversion adapter + panel mount

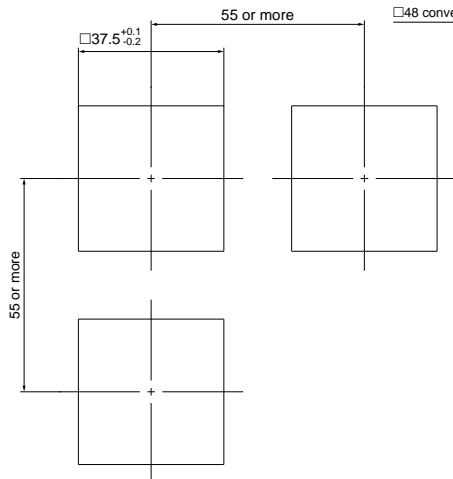
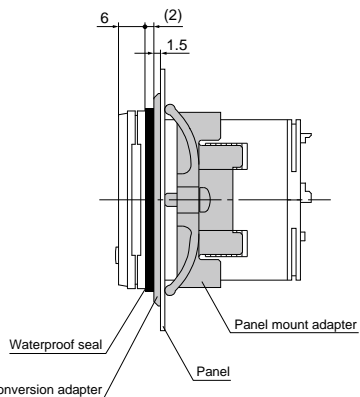
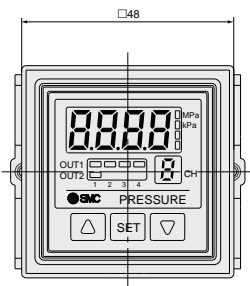

Panel fitting dimension

Applicable panel thickness: 0.5 to 8 mm

Series 10-PSE300

Remote Type
2-Color Display Digital Pressure Sensor Controller



How to Order



Input/Output specifications

0	NPN2 output + 1 to 5 V output
1	NPN2 output + 4 to 20 mA output
2	NPN2 output + Auto shift input
3	PNP2 output + 1 to 5 V output
4	PNP2 output + 4 to 20 mA output
5	PNP2 output + Auto shift input

Unit specifications

Nil	With unit switching function ^{Note 1)}
M	Fixed SI unit ^{Note 2)}

Note 1) Under the New Measurement Law, sales of switches with the unit switching function are not allowed for use in Japan.

Note 2) Fixed unit

For vacuum/low pressure/low differential pressure/compound pressure: kPa
For positive pressure: MPa (for 1 MPa)
kPa (for 500 kPa)

10 — PSE30 0 — M — — —

Clean series

Option 1

Option 3

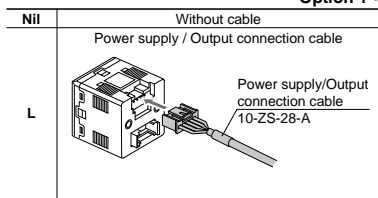

Note) At the factory, the cable is packed together without being connected.

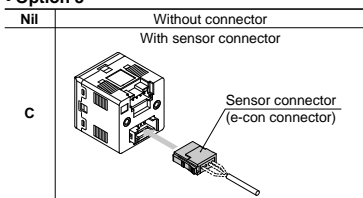

Note) At the factory, the connector is packed together without being connected.

Option 2

Nil None
Bracket

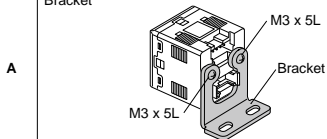

Panel mount adapter

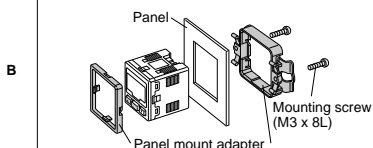

Panel mount adapter + Front protective cover

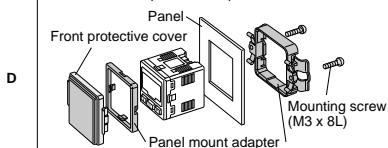

Note) These options are unassembled in the factory, but are included with the shipment.

Options/Part No.

Description	Part no.	Note
Power supply / Output connection cable (2 m)	10-ZS-28-A	
Bracket	10-ZS-28-B	With M3 x 5L (2 pcs.)
Sensor connector	10-ZS-28-C	1 pc.
Panel mount adapter	10-ZS-27-C	With M3 x 8L (2 pcs.)
Panel mount adapter + Front protective cover	10-ZS-27-D	With M3 x 8L (2 pcs.)

Directional Control Valves

Air Cylinders

Rotary Actuators

Air Grippers

Air Preparation Equipment

Modular F. R.

Pressure Control Equipment

Fittings & Tubing

Flow Control Equipment

Pressure Switches/ Pressure Sensors

Remote Type 2-Color Display Digital Pressure Sensor Controller 10-PSE300

Refer to the SMC website for Pressure Switches Precautions (M-E03-3) and Specific Product Precautions (Operation Manual).

Specifications

Model		10-PSE300□					
Set (differential) pressure range		-101 to 101 kPa	10 to -101 kPa	-10 to 100 kPa	-0.1 to 1 MPa	-50 to 500 kPa	-0.2 to 2 kPa
Pressure range ^{Note 1)}	For compound pressure	For vacuum pressure	For low pressure	For positive pressure		For low differential pressure	
Rated (differential) pressure range		-100 to 100 kPa	0 to -101 kPa	0 to 100k Pa	0 to 1 MPa	0 to 500 kPa	0 to 2k Pa
Power supply voltage	12 to 24 VDC, Ripple (p-p) 10% or less (with power supply polarity protection)						
Current consumption	50 mA or less (Current consumption for sensor is not included.)						
Sensor input	Number of inputs	1 input					
	Input protection	With excess voltage protection (up to 26.4 V)					
Hysteresis	Hysteresis mode: Variable, Window comparator mode: Variable						
	NPN or PNP open collector output: 2 outputs						
Switch output	Maximum load current	80 mA					
	Maximum load voltage	30 VDC (at NPN output)					
	Residual voltage	1 V or less (with load current of 80 mA)					
	Output protection	With short-circuit protection					
Response time	1 ms or less						
	Anti-chattering function	Response time selections with anti-chattering function: 20 ms, 160 ms, 640 ms, 1280 ms					
Repeatability	±0.1% F.S. or less						
Analog output	Voltage output ^{Note 2)}	Output voltage: 1 to 5 V (within rated (differential) pressure range), 0.6 to 1 V (within extension analog output range); Output impedance: Approx. 1 kΩ Linearity: ±0.2% F.S. or less (not including sensor accuracy); Response time: 150 ms or less					
	Accuracy (to display value) (25°C)	±0.6% F.S. or less					
	Current output ^{Note 2)}	Output current: 4 to 20 mA (within rated (differential) pressure range), 2.4 to 4 mA (within extension analog output range) Maximum load impedance: 300 Ω (12 VDC), 600 Ω (24 VDC), Minimum load impedance: 50 Ω Linearity: ±0.2% F.S. or less (not including sensor accuracy); Response time: 150 ms or less					
	Accuracy (to display value) (25°C)	±1.0% F.S. or less					
Display accuracy (ambient temperature 25°C)	±0.5% F.S.	±0.5% F.S. ±1 digit or less					±2.0% F.S. or less
Display	3+1/2 digit, 7 segment indicator, 2 color display (red/green), Sampling cycle: 5 times/sec						
Indicator light	OUT1: Lights up when ON (green), OUT2: Lights up when ON (red)						
Auto shift input ^{Note 2)}	No-voltage input (reed or solid state), Low level input: 5 ms or more, Low level: 0.4V or less						
Environment resistance	Enclosure	IP40					
	Operating temperature range	Operating: 0 to 50°C; Stored: -10 to 60°C (with no freezing or condensation)					
	Operating humidity range	Operating and stored: 35 to 85% RH (with no condensation)					
	Withstand voltage	1000 VAC for 1 min. between live parts and case					
	Insulation resistance	50 MΩ or more (measured by 500 VDC mega meter) between live parts and case					
Temperature characteristics	±0.5% F.S. or less (based on 25°C)						
Connection	Power supply/Output connection: 5P connector, Sensor connection: 4P connector						
Material	Front case: PBT; Rear case: PBT						
Weight	With power supply and output connection cable	85 g					
	Without power supply and output connection cable	30 g					
Power supply/Output connection cable	Oilproof heavy-duty vinyl cable, 5 cores, ø4.1, 2 m, Conductor area: 0.2 mm ² Insulator O.D.: 1.12 mm						
Standards	CE, UL/CSA (E216656), RoHS						
Cleanliness class (ISO class)	Class 3						

Note 1) Pressure range can be selected during initial setting.

Note 2) Auto shift function can not be selected when analog output option is selected.

Also, analog output option can not be selected when auto shift function is selected.

Note 3) The following units can be selected with unit conversion function:

For vacuum/compound pressure: kPa-kgf/cm²-bar-psi-mmHg-inHg

For positive/low pressure: MPa-kPa-kgf/cm²-bar-psi

For low differential pressure: kPa-mmH₂O

⚠ Caution

This product is blown with air and double packed in a Class M3.5 (ISO Class 5) clean room.

Analog Output

1 to 5 V DC

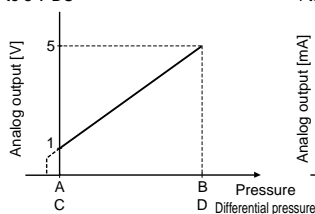

4 to 20 mA DC

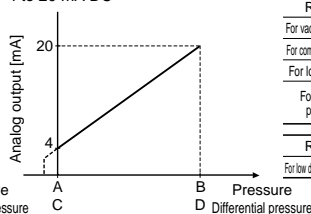

Range	Rated pressure range	A	B
For vacuum pressure	0 to -101 kPa	0	-101 kPa
For compound pressure	-100 kPa to 100 kPa	-100 kPa	100 kPa
For low pressure	0 to 100 kPa	0	100 kPa
	0 to 1 MPa	0	1 MPa
For positive pressure	0 to 500 kPa	0	500 kPa
	0 to 2 kPa	0	2 kPa

Internal Circuit

10-PSE300

NPN open collector output: 2 outputs,
 Maximum 30 V, 80 mA, Residual voltage: 1 V or less
 Analog output: 1 to 5 V
 Output impedance: Approx. 1 k Ω

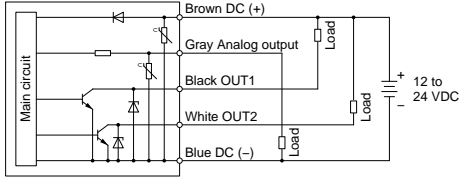

10-PSE300

PNP open collector output: 2 outputs,
 Maximum 80 mA, Residual voltage: 1 V or less
 Analog output: 1 to 5 V
 Output impedance: Approx. 1 k Ω

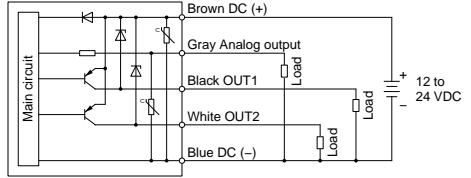

10-PSE301

NPN open collector output: 2 outputs,
 Maximum 30 V, 80 mA, Residual voltage: 1 V or less
 Analog output: 4 to 20 mA
 Maximum load impedance: 300 Ω (12 VDC) 600 Ω (24 VDC)
 Minimum load impedance: 50 Ω

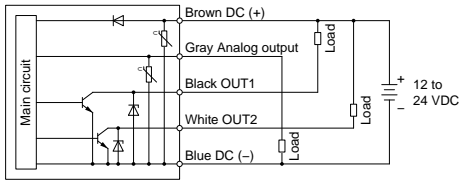

10-PSE304

PNP open collector output: 2 outputs,
 Maximum 80 mA, Residual voltage: 1 V or less
 Analog output: 4 to 20 mA
 Maximum load impedance: 300 Ω (12 VDC) 600 Ω (24 VDC)
 Minimum load impedance: 50 Ω

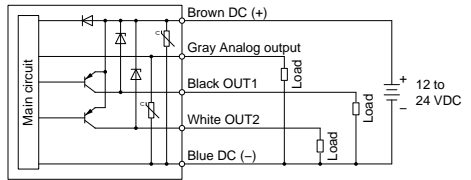

10-PSE302

NPN open collector output with auto shift input: 2 outputs,
 Maximum 30 V, 80 mA, Residual voltage: 1 V or less

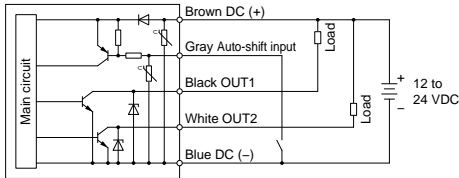

10-PSE305

PNP open collector output with auto shift input: 2 outputs,
 Maximum 80 mA, Residual voltage: 1 V or less

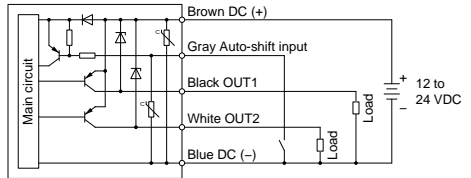

Directional Control Valves
 Air Cylinders
 Rotary Actuators
 Air Grippers
 Air Preparation Equipment
 Modular F. R.
 Pressure Control Equipment
 Fittings & Tubing
 Flow Control Equipment
 Pressure Switches/ Pressure Sensors

Dimensions

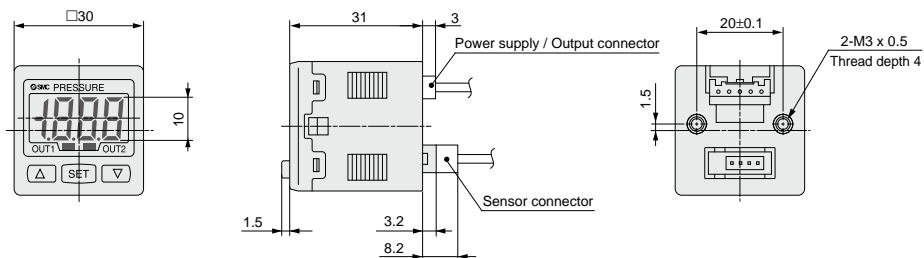

Power supply / Output connection cable (10-ZS-28-A)

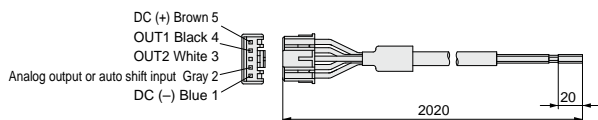

Sensor connector

PIN no.	Terminal
1	DC (+)
2	N.C.
3	DC (-)
4	IN (1 to 5V)

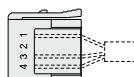

With bracket

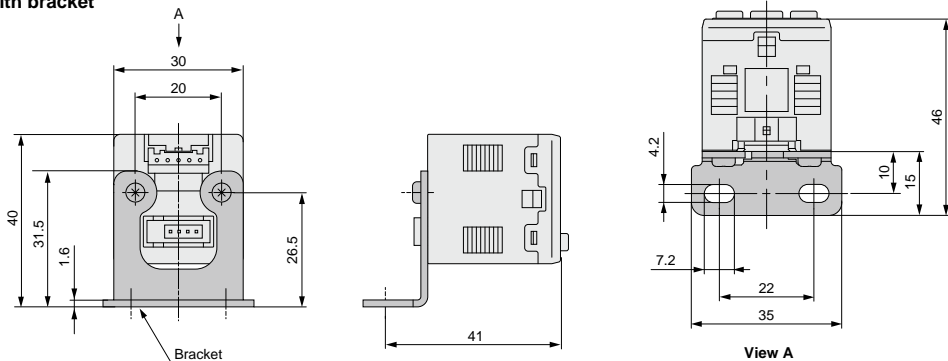

With panel mount adapter

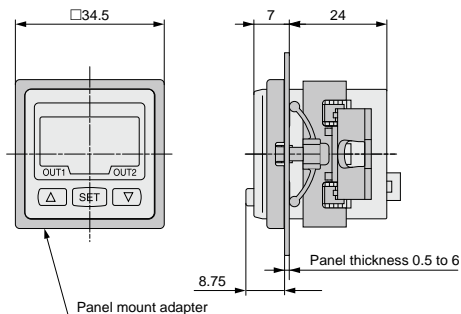

With panel mount adapter + Front protective cover

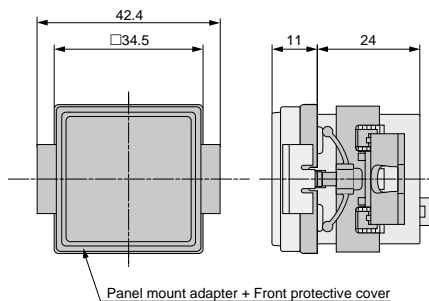

Dimensions

Panel fitting dimensions

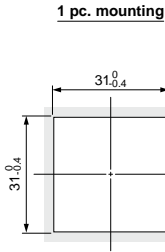

Stacking mount of multiple units (n pcs.) (horizontal)

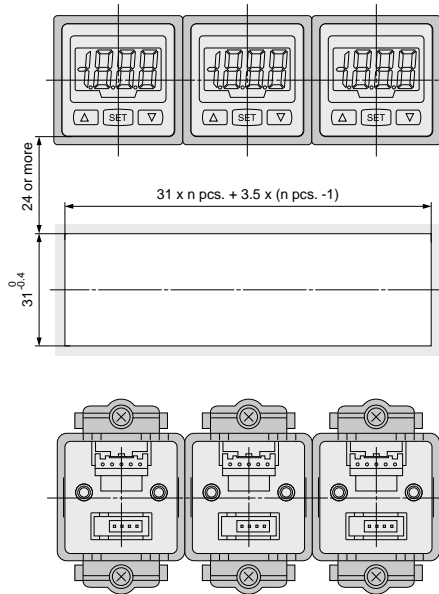

Stacking mounting of multiple units (n pcs.) (vertical)

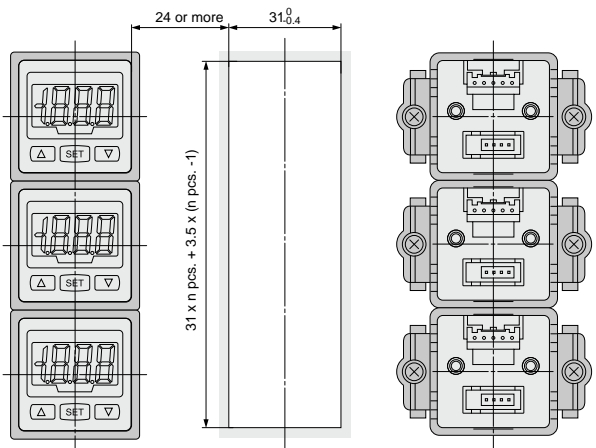

Directional Control Valves

Air Cylinders

Rotary Actuators

Air Grippers

Air Preparation Equipment

Modular F. R.

Pressure Control Equipment

Fittings & Tubing

Flow Control Equipment

Pressure Switches/
Pressure Sensors

Functions

A Auto shift function

When there are large fluctuations in the supply pressure, the switch may fail to operate correctly. The auto shift function rectifies such supply pressure fluctuations. It measures the differential pressure at the time of auto shift signal input and uses it as the reference (differential) pressure to correct the set value on the switch.

Set value correction by auto shift function

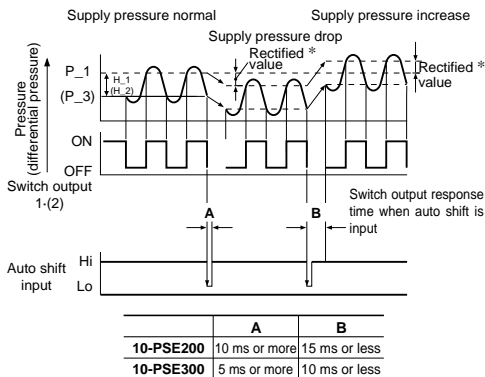

* Rectified value

When the auto shift is input, "ooo" will be displayed for approx. 1 second, and the pressure value at that point will be saved as a rectified value "C_5"(CH1 for 10-PSE200 and 10-PSE300) or "C_3"(CH2 to CH4 for 10-PSE200). Based on the saved rectified values, the set value Note) "P_1" to "P_4" (10-PSE200) or "P_1", "H_1", "P_3", and "H_2" (10-PSE300) will be rectified.

Note) Upon reverse output, "n_1" to "n_4" (10-PSE200) or "n_1", "H_1", "n_3", and "H_2" (10-PSE300) are rectified.

Possible set range for auto shift input

10-PSE200	Set (differential) pressure range	Possible set range
Compound pressure	-101.0 to 101.0 kPa	-101.0 to 101.0 kPa
Vacuum pressure	10.0 to -101.0 kPa	-101.0 to 101.0 kPa
Low pressure	-10.0 to 101.0 kPa	-100.0 to 101.0 kPa
Positive pressure	-0.1 to 1.000 MPa	-1.000 to 1.000 MPa
Low differential pressure	-	-

10-PSE300	Set (differential) pressure range	Possible set range
Compound pressure	-101.0 to 101.0 kPa	-101.0 to 101.0 kPa
Vacuum pressure	10.0 to -101.0 kPa	-101.0 to 101.0 kPa
Low pressure	-10 to 100.0 kPa	-100.0 to 100.0 kPa
Positive pressure	-0.1 to 1.000 MPa	-1.000 to 1.000 MPa
	-50 to 500 kPa	-500 to 500 kPa
Low differential pressure	-0.2 to 2.00 kPa	-2.00 to 2.00 kPa

Auto shift zero (10-PSE300 only)

Basic function of auto shift zero is the same as the auto shift function. The only difference is that assuming the pressure value when an auto shift is input to be "0", display value is also rectified.

B Auto preset function

When auto preset function is selected in the initial setting, it calculates and stores the set value from the measured (differential) pressure.

The optimum set value is determined automatically by repeating vacuum and release with the target workpiece several times.

Absorption verification

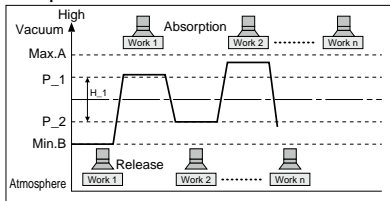

Formula for calculating the set value

	P_1 or P_3	P_2(H_1) or P_4(H_2)
10-PSE200		P_2(P_4) = B + (A-B)/4
10-PSE300	P_1(P_3) = A - (A-B)/4	H_1(H_2) = (A-B)/2

C Display calibration function

This function eliminates slight differences in the output values and allows uniformity in the numbers displayed. Displayed values of the pressure sensors can be adjusted to within ±5%.

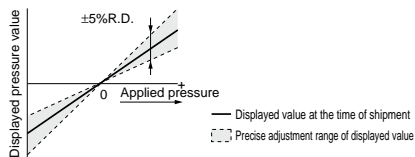

Note) When the precision indicator setting function is used, the set (differential) pressure value may change ±1 digit.

D Peak/Bottom hold display function

This function constantly detects and updates the maximum and minimum values and allows to hold the display value.

Series 10-PSE300 allows the hold value to be reset by pressing ↑ and ↓ at the same time for one second or more while holding the display value.

E Key lock function

This function prevents incorrect operations such as accidentally changing the set value.

F Reset function

This function clears and resets the zero value on the display of measured (differential) pressure.

It is possible to rectify within ±7% F.S. from the factory-set value.

Functions

G Error indication function

Error name	Error indication function 10-PSE200	10-PSE300	Description
Overcurrent error	Er 1	Er 1	Current exceeding 80 mA is applied to switch output (OUT1).
	Er 2	Er 2	Current exceeding 80 mA is applied to switch output OUT2.
Residual pressure error	Er 3	Er 3	Pressure exceeding $\pm 7\%$ F.S. is applied during the zero reset operation. * After displaying the error code for 3 seconds, the switch automatically returns to the measuring mode. Due to individual product differences, the setting range varies ± 4 digits.
Applied pressure error	---	HHH	Supply pressure exceeds the maximum set (differential) pressure or upper limit of the display pressure.
	---	LLL	A sensor may not be unconnected or miswired. Or, supply pressure is below the minimum set (differential) pressure or lower limit of the display pressure.
Auto shift error	/	or	The value measured at the time of auto shift input is outside the set (differential) pressure range. * After displaying the error code for approx. 1 second, the switch returns to the measuring mode.
System error	Er 5	Er 4	Displayed when internal data error has occurred.
	Er 6	Er 6	Displayed when internal data error has occurred.
	Er 7	Er 7	Displayed when internal data error has occurred.
	Er 8	Er 8	Displayed when internal data error has occurred.

H Copy function (10-PSE200 only)

Information that can be copied includes the following: (1)Pressure set values (2)Range settings (3)Display units (4)Output modes (5)Response times.

- When CH1 is copied to CH2, CH3, and CH4, information of OUT1 in CH1 will be copied.
- When CH2, CH3, or CH4 is copied to CH1, information of OUT1 in CH2, CH3, or CH4 will be copied only to OUT1 in CH1.

Note 1) When the copy function is used, the regulating pressure value of the copied channel may change ± 1 digit.

I Auto identification function (10-PSE200 only)

This function automatically identifies the pressure range of the pressure sensor that is connected to the multi-channel pressure sensor monitor, thus eliminating the need of having to reset the range again after replacing the sensor.

This function will be activated either when "Aon" is set in the auto identification mode or when the power is turned back on in that condition. However, this function only works in conjunction with specific pressure sensors (SMC: Series PSE53□).

When other pressure sensors are used, this function will not work. When using other types of pressure sensors, first set the auto identification mode to "AoF" and then proceed to the range setting. Turning the power back on while in the "Aon" setting can cause a malfunction.

J Anti-chattering function

Devices such as large bore cylinders and high-flow vacuum ejectors consume a large volume of air when they operate, and this may cause a momentary drop in the supply pressure. This function prevents such momentary drops from being detected as abnormal pressures by changing the response time setting.

	Possible response time settings
10-PSE200	20 ms, 160 ms, 640 ms
10-PSE300	20 ms, 160 ms, 640 ms, 1280 ms

<Principle>

The pressure values measured within the response time that are selected by the user are averaged. By comparing this average pressure value with the set pressure value, switch output (ON/OFF) is determined.

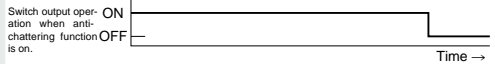
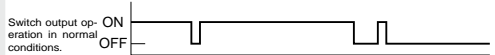
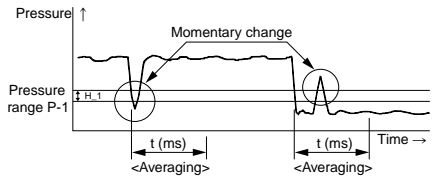

K Channel selection function (10-PSE200 only)

This function displays the measured pressure of any channel.

L Channel scan function (10-PSE200 only)

This function displays measured pressure for each channel in order at approx. 2-second intervals.

Directional Control Valves

Air Cylinders

Rotary Actuators

Air Grippers

Air Preparation Equipment

Modular F. R.

Pressure Control Equipment

Fittings & Tubing

Flow Control Equipment

Pressure Switches/Pressure Sensors

Functions

M Display unit switching function

Display units can be switched with this function.

Units that can be set vary depending on the range of the pressure sensors connected to the controller.

10-PSE200

Pressure range	For compound pressure	For vacuum pressure	For low pressure	For positive pressure	
Applicable pressure sensor	10-PSE533	10-PSE531		10-PSE530	
	10-PSE543	10-PSE541	10-PSE532	10-PSE540	
	10-PSE563	10-PSE561		10-PSE560	
Set (differential) pressure range	-101 to 101 kPa	10 to -101 kPa	-10 to 100 kPa	-0.1 to 1 MPa	
$\overline{P}R$	kPa	0.1	0.1	0.1	—
	MPa	—	—	—	0.001
$\overline{G}F$	kgf/cm ²	0.001	0.001	0.001	0.01
$\overline{b}Rr$	bar	0.001	0.001	0.001	0.01
$\overline{P}S$	psi	0.02	0.01	0.01	0.1
$\overline{in}H$	inHg	0.1	0.1	—	—
$\overline{mm}H$	mmHg	1	1	—	—

10-PSE300

Pressure range	For compound pressure	For vacuum pressure	For low pressure	For positive pressure		For low differential pressure	
Applicable pressure sensor	10-PSE533	10-PSE531		10-PSE530			
	10-PSE543	10-PSE541	10-PSE532	10-PSE540	10-PSE564	10-PSE550	
	10-PSE563	10-PSE561		10-PSE560			
Set (differential) pressure range	-101 to 101 kPa	10 to -101 kPa	-10 to 100 kPa	-0.1 to 1 MPa	-50 to 500 kPa	-0.2 to 2.00 kPa	
$\overline{P}R$	kPa	0.2	0.1	0.1	—	1	0.01
	MPa	—	—	—	0.001	—	—
$\overline{G}F$	kgf/cm ²	0.002	0.001	0.001	0.01	0.01	—
$\overline{b}Rr$	bar	0.002	0.001	0.001	0.01	0.01	—
$\overline{P}S$	psi	0.05	0.02	0.02	0.2	0.1	—
$\overline{in}H$	inHg	0.1	0.1	—	—	—	—
$\overline{mm}H$	mmHg	2	1	—	—	—	1 mmH ₂ O



Pressure Switches/Flow Switches Precautions 1

Be sure to read this before handling.

⚠ Warning

1. Check the product specifications before use.

If the product is used outside of the specifications, it may cause malfunction, failure or damage to the product, leading to an electric shock, explosion or fire.

2. Do not modify the product.

Do not disassemble, modify (including changing the printed circuit board) or repair the product. An injury or failure can result.

3. The product should be mounted correctly.

If the product is not mounted correctly, malfunction, failure or damage may occur.

For the handling of fittings (including One-touch fittings), refer to the Precautions for Fittings and Tubing.
Refer to the operation manual for the products in item 3 below.

- Use the appropriate tool.
- Tighten with the required torque.
- If the mounting direction is specified, mount the product in accordance with the direction.

4. Perform regular maintenance and confirm normal operation.

If maintenance is not performed, malfunction or failure may occur.
Turn off the power supply and stop the fluid supply before performing maintenance.

Otherwise, it may cause an injury.
After maintenance is complete, perform appropriate functional inspections and leak tests.
Safety cannot be assured in the case of unexpected malfunction.

Cut off the power supply and stop supplying fluid if the equipment does not function properly or there is leakage of fluid.

5. Do not apply vibration, impact or loads.

If vibration, impact or loads are applied, malfunction, failure or damage may occur.
In particular, never mount a product in a location that will be used as a foothold.

6. Do not expose the product to direct sunlight.

If the product is exposed to direct sunlight, malfunction, failure or damage may occur.
If the product is exposed to direct sunlight, provide a suitable protective cover.

7. Do not use the product in an environment where the product may be corroded.

If the product is used in a corrosive environment, malfunction, failure or damage may occur.
Check the product materials before use.

8. Do not use products other than ATEX compliant products in an environment where the product is exposed to explosive or flammable gas or dust.

ATEX (explosion proof) compliant products should be used in an environment which is correspondent to ATEX compliance.
If products other than ATEX compliant products are used in an explosive or flammable environment, an explosion or fire may occur.

9. Ensure that the product is used within the enclosure specifications.

If the product is used outside of the specifications, malfunction or failure may occur.

Use the product in accordance with the protection level with reference to IEC60529.

10. Use the product within the operating temperature, humidity and fluid temperature.

Do not use the product outside of these specifications.
Even when the product is used within the specifications, do not use in a location where there are rapid temperature changes, or in a location where there are heating/cooling cycles, or in a location where there is freezing or condensation.
It may result in malfunction or failure.

If the product is to be used in under low temperature, protection against freezing is necessary.

11. Do not use fluids other than applicable fluids.

If fluids other than applicable fluids are used, malfunction, failure or breakage may occur.

12. Do not use for flammable or poisonous fluids.

If flammable or poisonous fluids are used, an explosion or fire may occur.

13. Do not let foreign matter or condensate get inside the piping of the product.

If foreign matter or condensate enters the product, malfunction, failure or damage may occur.
Mount an appropriate filter on the fluid inlet side (IN side).

14. Use the product within the specified operating pressure range.

If the product is used outside of the rated pressure range, malfunction may occur.

15. Do not apply pressure which exceeds the proof pressure.

If pressure exceeding the proof pressure is applied, malfunction, failure or damage may occur.

16. Ensure that the product is used within the power supply specifications.

If the product is used outside of the specifications, malfunction or failure may occur, leading to an electric shock or fire.

17. Ensure that the FG terminal is connected to ground when using a commercially available switch-mode power supply.

When a switch-mode power supply is connected to the product, switching noise will be superimposed and the product specification can no longer be met.

This can be prevented by inserting a noise filter, such as a line noise filter and ferrite core, between the switch-mode power supply and the product, or by using a series power supply instead of a switch-mode power supply.

18. Do not use a load exceeding the maximum load voltage or current.

If the product is used outside of the specifications, it may cause malfunction or damage, leading to a reduction in the life of the product.

19. Wire the product correctly.

Incorrect wiring could cause malfunction or failure, leading to an electric shock or fire.

Directional
Control Valves

Air Cylinders

Rotary Actuators

Air Grippers

Air Preparation
Equipment

Modular F. R.

Pressure Control
Equipment

Fittings & Tubing

Flow Control
Equipment

Pressure Switches/
Pressure Sensors



Pressure Switches/Flow Switches Precautions 2

Be sure to read this before handling.

Warning

20. Avoid repeatedly bending, stretching or applying load to the cable.

Applying repeated bending, tensile stress or load to the cable can damage the wire.

The recommended bend radius of the cable is 6 times the outside diameter of the sheath, or 33 times the outside diameter of the insulation material, whichever is larger.

21. Do not perform wiring while the power is ON.

Touching the terminal or connector while the power is ON may cause an electric shock.

Performing wiring while the power is ON may result in malfunction or failure.

22. Use appropriate countermeasures against surge when using a load which generates a surge voltage.

If surge voltages are repeatedly applied, this may cause malfunction or failure.

23. Do not use in an area where surges are generated.

If the product is used in an environment where surges are generated (solenoid lifter, high frequency induction furnace, motor, etc.), malfunction or failure may occur.

Take appropriate measures before using the product.

24. Route the wires of the product separately from power or high voltage cables.

If the wires of the product are routed with power or high voltage cables, malfunction or failure may occur due to noise.

25. Confirm proper insulation of the wiring.

If there is insulation failure (short circuits, faulty ground connection, improper insulation between terminals, etc.), malfunction or failure may occur.

26. Do not use the product in a place where static electricity is a problem.

It may result in system failure or malfunction.

Caution

1. Slight scratches or dirt on the display or the product body will not cause a problem. Please continue to use the product.

2. Ensure sufficient space for installation and maintenance.

3. Install the product while taking into consideration the internal voltage drop. (Electrical type only)

Verify the equation below is satisfied after checking the operating voltage of the load.

Power supply voltage - Product internal voltage drop > Minimum operating voltage

Even though the product operates normally, if the operating voltage is not satisfied, the load may not operate.

4. Pay attention to the write limit of the input data. (Electrical type only)

The input data (the set value, etc.) is written into memory, so if the power supply is cut, the data will not be lost. However, there is a limit to the number of write operations.

Refer to the operation manual for the write limit.

5. Do not use solvents such as benzene, thinner etc. to clean the product.

They could damage the surface of the body and erase the markings on the body.

Use a soft cloth to remove stains. For heavy stains, use a cloth lightly dampened with diluted neutral detergent, then wipe up any residue with a dry cloth.

Pressure Switches/
Pressure Sensors

Flow Control
Equipment

Fittings & Tubing

Pressure Control
Equipment

Modular F. R.

Air Preparation
Equipment

Air Grippers

Rotary Actuators

Air Cylinders

Directional
Control Valves

For details about the clean wet series, refer to the **WEB catalog** or Best Pneumatics No. 7.

Fluoropolymer Products (Clean Wet Series)

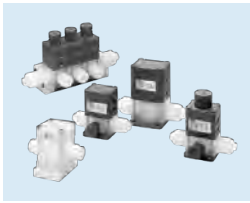

Air Operated Chemical Liquid Valve/Integrated Fitting Type **LVC**

- Body material: New PFA
- Same configuration N.C./N.O./Double acting
- Able to handle fluid temperatures up to 100°C
- Manifold type No.: LLC2, LLC3, LLC4, LLC5

Series	Type	Actuation	Applicable tubing O.D.		Orifice diameter (mm ϕ)
			Metric size	Inch size	
LVC	Integrated fitting	N.C./N.O./Double acting	3 to 25	1/8 to 1	4 to 22

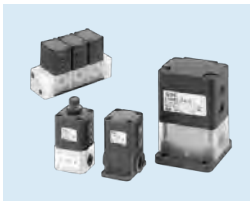

Air Operated Chemical Liquid Valve/Threaded Type **LVA**

- Body material: New PFA/Stainless steel/PPS
- Diaphragm material: PTFE, EPR, NBR available.
- Manifold type No.: LLA2, LLA3, LLA4, LLA5

Series	Type	Actuation	Port size	Orifice diameter (mm ϕ)
LVA	Threaded type	N.C./N.O./Double acting	1/8 to 1	2 to 22

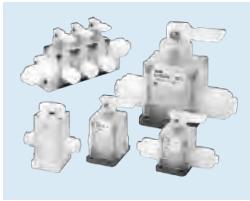

Manually Operated Chemical Liquid Valve (Integrated Fitting/Threaded Type) **LVH**

- Body material: New PFA/Stainless steel/PPS
- Compatible with locking and non-locking types
- Manifold type No.: LLH2, LLH3, LLH4

Series	Type	Actuation	Port size (Applicable tubing O.D.)		Orifice diameter (mm ϕ)
			Metric size	Inch size	
LVH	Manual type (Integrated fitting/Threaded type)	N.C.	1/8 to 1/2	1/4 to 1/2	4 to 12

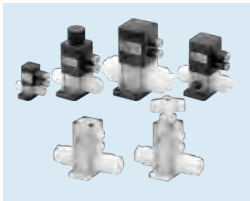

Air Operated Chemical Liquid Valve/Compact Type **LVD**

- Compact and space-saving lineup. Up to 29% reduction in dimensions on piping side.
- Body material: New PFA
- Diaphragm material: PTFE
- Actuator material: PPS

Series	Type	Actuation	Applicable tubing O.D. ^(Note)		Orifice diameter (mm ϕ)
			Metric size	Inch size	
			LVD	Integrated fitting	
LVD	Tube extension	6 to 19	1/4 to 3/4	4 to 16	

(Note) Tubing O.D. for tube extension type.



Chemical Liquid Valve/Non-Metallic Exterior **LVQ**

- No screws, all-in-one integrated design. Non-metallic structure. No metal screws used to fasten the actuator portion and body portion.
- Body material: New PFA
- Diaphragm material: PTFE
- Actuator material: PVDF

Series	Type	Actuation	Applicable tubing O.D.		Orifice diameter (mm ϕ)
			Metric size	Inch size	
			LVQ	Integrated fitting	
LVQ	Space-saving type	Fitting size: 2 to 6	Fitting size: 2 to 6		
LVQ	Tube extension	6 to 25 ^(Note)	1/4 to 1 ^(Note)		

(Note) Tubing size

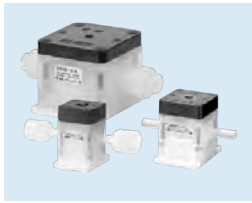

Clean Regulator/Fluoro-resin Type **SRF**

- Wetted part materials Body: New PFA, Diaphragm: PTFE
- Recommended maximum flow rate: 20 L/min (SRF50) (Inlet pressure: 0.3 MPa, Fluid: Water)

Series	Model	Applicable tubing O.D.		Set pressure (MPa)
		Metric size	Inch size	
SRF	Integrated fitting	ø4 to ø19	ø1/8 to ø3/4	0.02 to 0.4
	With nut	Fitting size: 2 to 6	Fitting size: 2 to 6	
	Tube extension	—	Tubing O.D. ø1/4 to ø3/4	



Fluoropolymer Fittings Hyper Fittings/Insert Bushing Type **LQ1**

- Material: New PFA
- 4-layer seal construction
- Reducer allows tube size to be changed with no change in the body required.

Series	Maximum operating pressure	Operating temperature (°C)
LQ1	1.0 MPa	0 to 200

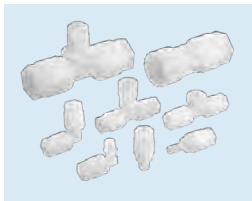

Fluoropolymer Fittings Hyper Fittings/Flare Type **LQ3**

- Material: New PFA
- 3-layer seal construction
- Easy installation

Series	Maximum operating pressure	Operating temperature (°C)
LQ3	1.0 MPa	Nut material PVDF: 0 to 150 Nut material PFA: 0 to 200

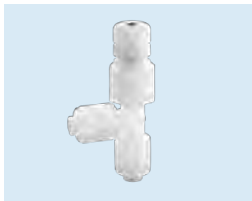

Fluoropolymer Needle Valve **LVN**

- Material: New PFA
- Fitting integrated, all-in-one structure. Hyper fitting/LQ2 series used.
- 3-layer seal construction

Series	Applicable tubing O.D.		Flow adjustment range (L/min)	Orifice diameter (mm ø)
	Metric size	Inch size		
LVN	4 to 12	1/8" to 1/2"	0 to 12	4.4 to 10



Fluoropolymer Bore Through Connector **LQHB**

- Freely choose tube positioning. As the tube runs through the fitting itself, the fitting can be set at any location.
- Can be used in pressure feed of chemical liquids, etc., in the production process of semiconductors.
- Applicable to chemical liquids such as acid, alkali and deionized water.
- Material: New PFA (Body, nut), PTFE (Collet)

Series	Applicable tubing O.D.		Operating temperature (°C)
	Metric size	Inch size	
LQHB	ø3 to ø25	ø1/8" to ø1"	0 to 200

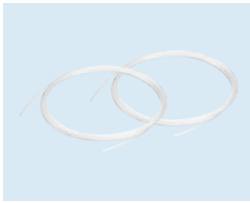

Fluoropolymer Tubing *TL/TIL*

- Material: Super PFA
- Maximum operating temperature: 260°C (Can vary according to operating conditions.)

Series	Tubing O.D.		Color
	Metric size	Inch size	
TL/TIL	4, 6, 8, 10, 12, 19	1/8", 3/16", 1/4", 3/8" 1/2", 3/4", 1", 1 1/2"*	Translucent

* Made to Order

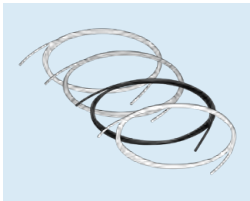

Fluoropolymer Tubing (PFA) *TLM/TILM*

- Maximum operating temperature: 260°C (Can vary according to operating conditions.)
- Complies with Food Sanitation Law.
- Complies with FDA (Food and Drug Administration) §177-1550 dissolution test.

Series	Tubing O.D.		Color
	Metric size	Inch size	
TLM/TILM	ø2, ø3, ø4, ø6 ø8, ø10, ø12, ø16 ø19, ø25	ø1/8", ø3/16", ø1/4" ø3/8", ø1/2", ø3/4", ø1" ø1 1/4"	Translucent, Black, Red, Blue



Soft Fluoropolymer Tubing *TD/TID*

- Maximum operating pressure 1.6 MPa or less (at 20°C)*
- Complies with Food Sanitation Law.
- Complies with FDA (Food and Drug Administration) §177-1550 dissolution test.
- Maximum operating temperature: 260°C (Can vary according to operating conditions.)

* Varies according to size.

Series	Tubing O.D.		Color
	Metric size	Inch size	
TD/TID	ø4, ø6, ø8, ø10, ø12	ø1/8", ø3/16", ø1/4" ø3/8", ø1/2"	Translucent



FEP Tubing (Fluoropolymer) *TH/TH*

- Maximum operating pressure 2.3 MPa or less (at 20°C)*
- Complies with Food Sanitation Law.
- Complies with FDA (Food and Drug Administration) §177-1550 dissolution test.
- Maximum operating temperature: 200°C (Can vary according to operating conditions.)

* Varies according to size.

Series	Tubing O.D.		Color
	Metric size	Inch size	
TH/TH	ø4, ø6, ø8, ø10, ø12	ø1/8", ø3/16", ø1/4" ø3/8", ø1/2", ø3/4"	Translucent, Black, Red, Blue



Process Pump/Double Acting Pump **PAP**

Series	Action	Discharge rate (L/min)	Wetted part material
PAP3310	Automatically operated type	1 to 13	New PFA (Fluororesin)
PAP3313	Air operated type	0.1 to 9	



Process Pump/Single Acting Pump **PB**

Series	Action	Discharge rate (mL/min)	Wetted part material
PB1313A	Air operated type	8 to 1000	New PFA (Fluororesin)



Non-Metallic Pump/Double Acting Pump **PAF**

Series	Action	Discharge rate (L/min)	Wetted part material
PAF3410	Automatically operated type	1 to 20	New PFA (Fluororesin)
PAF3413	Air operated type	1 to 15	
PAF3410-X68*	Automatically operated type	1 to 20	
PAF5410	Automatically operated type	5 to 45	
PAF5413	Air operated type	5 to 38	

* Tightening bolt, Air switching valve: Stainless steel

Use the PAF series standard products when a metal-free pump is necessary for hydrofluoric acid, etc.



Digital Flow Switch for Deionized Water and Chemical Liquids **PF2D**

- Body sensor: New PFA, Tube: Super PFA
- Low-particle generation, excellent flow-through characteristics

Series	Rated flow range (L/min)
PF2D	0.4 to 4
	1.8 to 20
	4.0 to 40

Electric Actuators (Clean Room Specification)

ISO Class 4* (ISO14644-1)

- Built-in vacuum piping
- Mount the main body without removing the external cover etc.
- Body-integrated linear guide specification

* Changes depending on the suction flow rate.

For details, refer to the **WEB catalog** or the Electric Actuators catalog (CAT.E102).

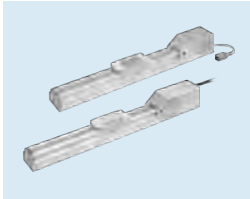

Electric Actuator/Slider Type Ball Screw Drive **11-LEFS**

Specification	Series	Stroke (mm)	Work load (kg) Horizontal	Speed (mm/s)	Screw lead (mm)
Step motor (Servo/24 VDC)	11-LEFS16	50 to 500	Max. 14	Max. 500	5, 10
Step motor (Servo/24 VDC)	11-LEFS25	50 to 600	Max. 25	Max. 500	6, 12
Step motor (Servo/24 VDC)	11-LEFS32	50 to 800	Max. 45	Max. 500	8, 16
Step motor (Servo/24 VDC)	11-LEFS40	150 to 1000	Max. 55	Max. 500	10, 20
Servo motor (24 VDC)	11-LEFS16A	50 to 500	Max. 10	Max. 500	5, 10
Servo motor (24 VDC)	11-LEFS25A	50 to 600	Max. 18	Max. 500	6, 12
AC servo motor (100/200/400 W)	11-LEFS25S	50 to 600	Max. 20	Max. 900	6, 12
AC servo motor (100/200/400 W)	11-LEFS32S	50 to 800	Max. 45	Max. 1000	8, 16
AC servo motor (100/200/400 W)	11-LEFS40S	150 to 1000	Max. 60	Max. 1000	10, 20

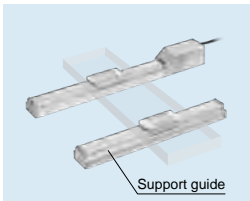

Electric Actuator/Series LEF Support Guide **11-LEFG**

Actuation type	Model	Stroke (mm)
Ball screw drive/S	11-LEFG16-S	50 to 500
Ball screw drive/S	11-LEFG25-S	50 to 600
Ball screw drive/S	11-LEFG32-S	50 to 800
Ball screw drive/S	11-LEFG40-S	150 to 1000

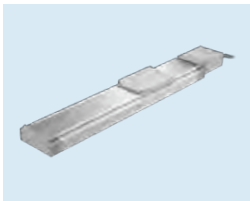



Electric Actuator/High Rigidity Slider Type Ball Screw Drive **11-LEJS**

Specification	Series	Stroke (mm)	Work load (kg) Horizontal	Speed (mm/s)	Screw lead (mm)
AC servo motor	11-LEJS40	200 to 1200	Max. 55	Max. 1200	8, 16
AC servo motor	11-LEJS63	300 to 1500	Max. 85	Max. 1200	10, 20

Safety Instructions

These safety instructions are intended to prevent hazardous situations and/or equipment damage. These instructions indicate the level of potential hazard with the labels of “**Caution**,” “**Warning**” or “**Danger**.” They are all important notes for safety and must be followed in addition to International Standards (ISO/IEC)*1), and other safety regulations.

 **Caution:** Caution indicates a hazard with a low level of risk which, if not avoided, could result in minor or moderate injury.

 **Warning:** Warning indicates a hazard with a medium level of risk which, if not avoided, could result in death or serious injury.

 **Danger :** Danger indicates a hazard with a high level of risk which, if not avoided, will result in death or serious injury.

*1) ISO 4414: Pneumatic fluid power – General rules relating to systems.
ISO 4413: Hydraulic fluid power – General rules relating to systems.
IEC 60204-1: Safety of machinery – Electrical equipment of machines.
(Part 1: General requirements)
ISO 10218-1: Manipulating industrial robots – Safety.
etc.

Warning

1. The compatibility of the product is the responsibility of the person who designs the equipment or decides its specifications.

Since the product specified here is used under various operating conditions, its compatibility with specific equipment must be decided by the person who designs the equipment or decides its specifications based on necessary analysis and test results. The expected performance and safety assurance of the equipment will be the responsibility of the person who has determined its compatibility with the product. This person should also continuously review all specifications of the product referring to its latest catalog information, with a view to giving due consideration to any possibility of equipment failure when configuring the equipment.

2. Only personnel with appropriate training should operate machinery and equipment.

The product specified here may become unsafe if handled incorrectly. The assembly, operation and maintenance of machines or equipment including our products must be performed by an operator who is appropriately trained and experienced.

3. Do not service or attempt to remove product and machinery/equipment until safety is confirmed.

1. The inspection and maintenance of machinery/equipment should only be performed after measures to prevent falling or runaway of the driven objects have been confirmed.
2. When the product is to be removed, confirm that the safety measures as mentioned above are implemented and the power from any appropriate source is cut, and read and understand the specific product precautions of all relevant products carefully.
3. Before machinery/equipment is restarted, take measures to prevent unexpected operation and malfunction.

4. Contact SMC beforehand and take special consideration of safety measures if the product is to be used in any of the following conditions.

1. Conditions and environments outside of the given specifications, or use outdoors or in a place exposed to direct sunlight.
2. Installation on equipment in conjunction with atomic energy, railways, air navigation, space, shipping, vehicles, military, medical treatment, combustion and recreation, or equipment in contact with food and beverages, emergency stop circuits, clutch and brake circuits in press applications, safety equipment or other applications unsuitable for the standard specifications described in the product catalog.
3. An application which could have negative effects on people, property, or animals requiring special safety analysis.
4. Use in an interlock circuit, which requires the provision of double interlock for possible failure by using a mechanical protective function, and periodical checks to confirm proper operation.

Caution

1. The product is provided for use in manufacturing industries.

The product herein described is basically provided for peaceful use in manufacturing industries.

If considering using the product in other industries, consult SMC beforehand and exchange specifications or a contract if necessary.
If anything is unclear, contact your nearest sales branch.

Limited warranty and Disclaimer/ Compliance Requirements

The product used is subject to the following “Limited warranty and Disclaimer” and “Compliance Requirements”.

Read and accept them before using the product.

Limited warranty and Disclaimer

1. The warranty period of the product is 1 year in service or 1.5 years after the product is delivered, whichever is first.^(*)
Also, the product may have specified durability, running distance or replacement parts. Please consult your nearest sales branch.
2. For any failure or damage reported within the warranty period which is clearly our responsibility, a replacement product or necessary parts will be provided.
This limited warranty applies only to our product independently, and not to any other damage incurred due to the failure of the product.
3. Prior to using SMC products, please read and understand the warranty terms and disclaimers noted in the specified catalog for the particular products.

^(*)2) Vacuum pads are excluded from this 1 year warranty.

A vacuum pad is a consumable part, so it is warranted for a year after it is delivered.
Also, even within the warranty period, the wear of a product due to the use of the vacuum pad or failure due to the deterioration of rubber material are not covered by the limited warranty.

Compliance Requirements

1. The use of SMC products with production equipment for the manufacture of weapons of mass destruction (WMD) or any other weapon is strictly prohibited.
2. The exports of SMC products or technology from one country to another are governed by the relevant security laws and regulations of the countries involved in the transaction. Prior to the shipment of a SMC product to another country, assure that all local rules governing that export are known and followed.

Caution

SMC products are not intended for use as instruments for legal metrology.

Measurement instruments that SMC manufactures or sells have not been qualified by type approval tests relevant to the metrology (measurement) laws of each country. Therefore, SMC products cannot be used for business or certification ordained by the metrology (measurement) laws of each country.

Safety Instructions

Be sure to read the “Handling Precautions for SMC Products” (M-E03-3) and “Operation Manual” before use.



Clean Series Precautions 1

Be sure to read this before handling products.
Refer to the main text for detailed precautions for every series.

Air Supply

⚠ Caution

System Configuration

Refer to the "Air Preparation System" below for the quality of compressed air before configuring the system.

Main line

Sub-line

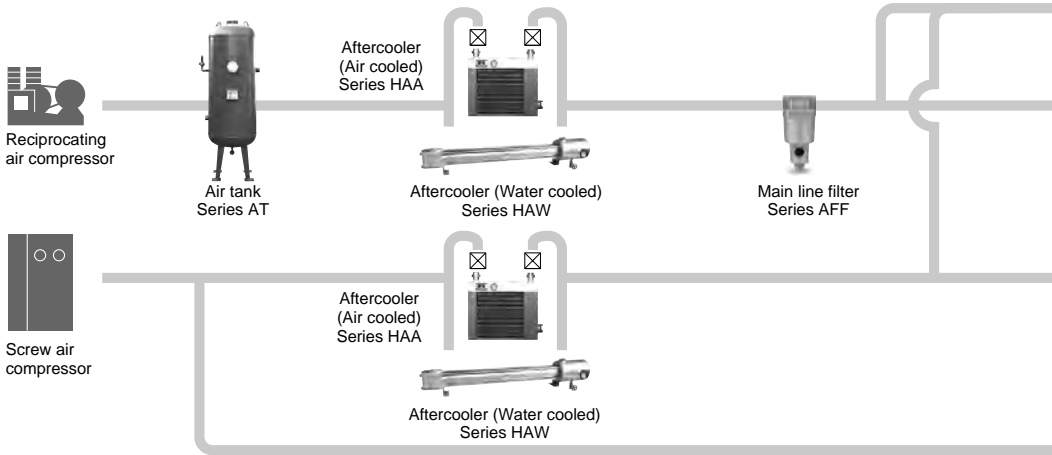

Piping

1. Provide an inclination of 1 cm per meter in the direction of the air flow to the main piping.
2. If there is a line branching from the main piping, provide an outlet of compressed air on top using a tee so that drainage accumulated in the piping will not flow out.
3. Provide a drainage mechanism at every recessed point or dead end to prevent drain accumulation.
4. For future piping extensions, plug the end of the piping with a tee.
5. Before piping
Before piping, the piping should be thoroughly flushed out with air or washed to remove chips, cutting oil and other debris from inside the pipe.
6. Winding of sealant tape
When screwing piping or fittings into ports, ensure that chips from the pipe threads or sealing material do not get inside the valve. Also, when sealant tape is used, leave approx. 1 thread ridge exposed at the end of the threads.

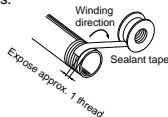

7. After piping
After piping, the piping should be thoroughly flushed out with air, and dust generated when piping should be removed.

8. If air with a low dew point (-40°C or less) is required, do not use nylon tubes or resin fittings (except for fluorine resin) for the outlet side of the membrane air dryer or heatless air dryer. Nylon tubing could be affected by the ambient air and thus may not be able to achieve the prescribed low dew point at the end of the tube. Therefore, for low dew point air, use stainless steel or fluorine tubes and fittings.

Maintenance

1. If the heatless air dryer Series ID is left unused for a long period, the absorbent may become moist. Prior to use, close the valve on the outlet side of the dryer for regeneration and drying.

Design

Employ a safe design, so that the following unexpected conditions will not occur.

⚠ Warning

1. Provide a design that prevents high-temperature compressed air from flowing into the outlet side of the cooling equipment.
If the flow of the coolant water in a water-cooled aftercooler is stopped or if the fan motor of an air cooled aftercooler is stopped, the high-temperature compressed air will flow to the outlet side of the cooling equipment, causing the equipment on the outlet side (such as the AFF, AM, AD, or IDF series) to be damaged or to malfunction.

Air Supply

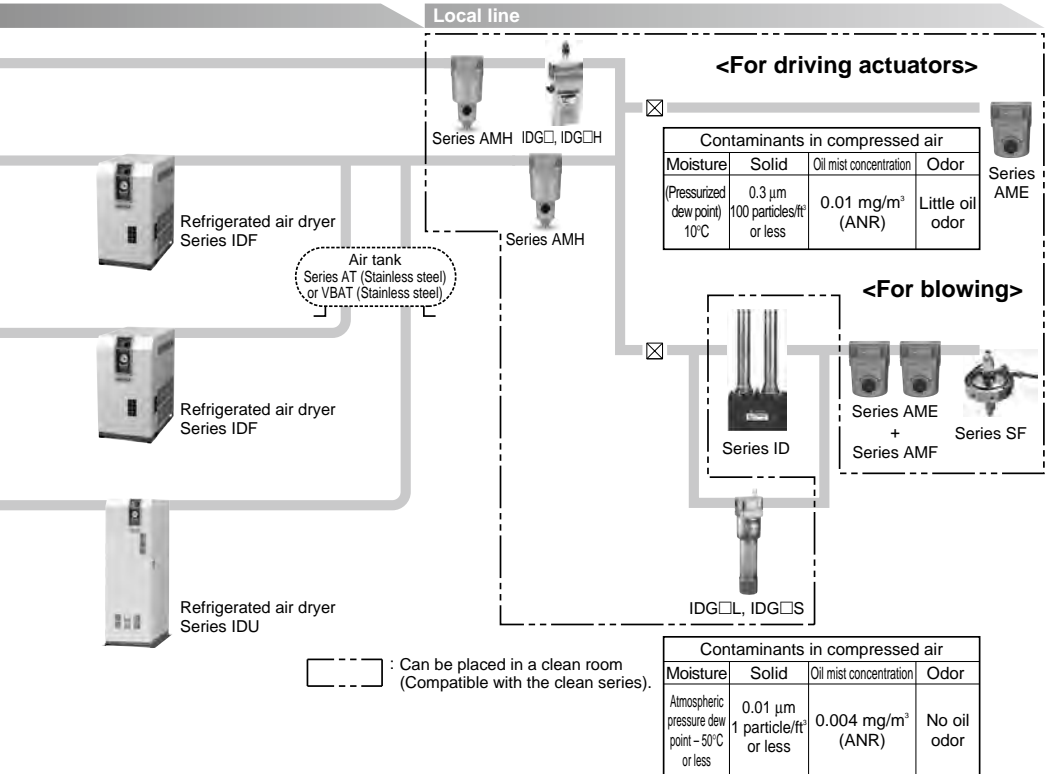

2. Provide a design in which interruptions in the supply of compressed air are taken into consideration.

There are cases in which compressed air cannot flow due to freezing of the refrigerated air dryer or a malfunction (heatless dryer) in the switching valve.

⚠ Caution

3. Design a layout in which the leakage of the coolant water and the dripping of condensation are taken into consideration.

A water-cooled aftercooler that uses coolant water could lead to water leakage due to freezing. Depending on the operating conditions, the refrigerated air dryer and its downstream pipes could create water droplets due to condensation formed by supercooling.

4. Provide a design that prevents back pressure and backflow.

The generation of back pressure and backflow could lead to equipment damage.

Take appropriate safety measures, including the proper installation methods.

5. When super dry air is used as the fluid, equipment reliability (service life) may be adversely affected due to deteriorating lubrication properties inside the equipment.

Please consult SMC in such cases.

6. Blowing system

Even a small amount of dust can be a problem for blowing systems.

Install Clean Gas Filter or Clean Air Filter Series SF to the end of the blowing line.



Clean Series Precautions 2

Be sure to read this before handling products.
Refer to the main text for detailed precautions for every series.

Piping: Inside of Clean Room

⚠ Caution

1. Do not make the piping for the air cylinder relief port and regulator breathing tube common with solenoid valve exhaust piping.
This can cause malfunctions in the air cylinder or regulator pressure change.
Do not apply pressure to the air cylinder relief port.
2. Arrange the piping so that the exhaust air of the solenoid valves is exhausted outside of the clean room.
3. Air filter drain piping
Exhaust drainage outside the clean room through piping from the drain guide of the air filter.
4. Arrange the membrane dryer air purge piping using standard size tubing so that air is exhausted outside the clean room.
5. Take precautions so that the threaded portion of the piping connection or the tubing connection will not be loosened.
Take sufficient precautions against piping shaking along with vibration of the equipment.
6. Use polyurethane tubing containing no plasticizer.
7. In case of the One-touch fitting 10-KQ (that includes built-in One-touch fitting solenoid valve manifolds, and speed controllers with One-touch fittings), changes in internal pressure may cause the collet chuck to slide very slightly. This may result in particle generation, so please avoid using this item in ISO Class 3 or ISO Class 4 areas.
However, there is no need for similar caution in the case of insert fittings (KF), miniature fittings (M/MS), clean One-touch fittings (KP/KPQ/KPG), or speed controllers with clean One-touch fittings (AS-FPQ/FPG).

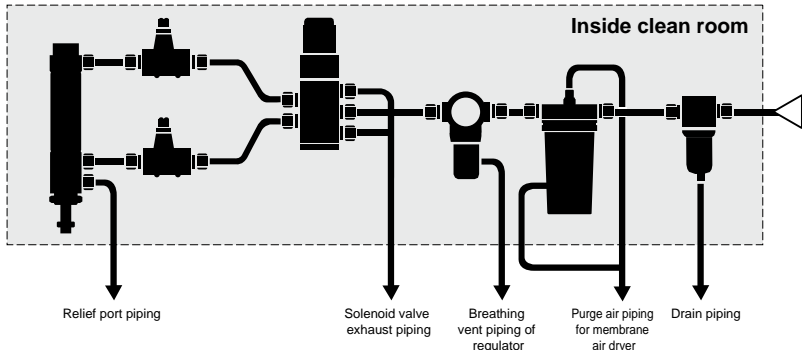

Handling

⚠ Caution

1. The inner bag of a double-packed clean series package should be opened in a clean room or clean environment.
2. When standard pneumatic equipment is brought into a clean room, spray high-purity air onto it and remove dust thoroughly by wiping the external surfaces of the cylinder tube, solenoid valves and air line equipment with alcohol.
3. To replace parts or disassemble the product in a clean room, first exhaust the compressed air inside the piping to the outside of the clean room before the work.
4. Do not use rotation type mounting brackets such as clevises, trunnions, etc. They will generate a considerable amount of particulate matter due to the sliding friction between the metal parts.

Lubrication for Actuators

⚠ Warning

Be sure to wash your hands after handling fluororesin grease.
The grease itself is not hazardous but it can produce a hazardous gas at temperatures exceeding 260°C.



Clean Series Precautions 3

Be sure to read this before handling products.
Refer to the main text for detailed precautions for every series.

Lubrication for Actuators

⚠ Caution

- Do not use any greases but those specified by SMC.
Use of greases not specified will cause malfunctions or particle generation.
- Do not lubricate the products since they are of a non-lubricant type.
As the clean series actuators are lubricated at the factory with fluororesin grease, the product specifications may not be satisfied if turbine oil or other such lubricants are applied.

Piston Speed

⚠ Caution

The air cylinder speed upper limit that retains the particle generation grade is 400 mm/s. When the maximum operating speed for the standard type is 400 mm/s or slower, operate the series within the operating speed range.

Suction Flow Rate of Vacuum Suction Types

⚠ Caution

For vacuum suction types (11-/13-/22-Series), perform vacuum suction at the vacuum port to retain the particle generation grade.

The optimum suction flow rate varies depending on the series and size. Refer to "Suction flow rate of vacuum suction type (Reference values)" for each series. (The vacuum pressure will be approximately -27 kPa at around 1 m from the vacuum suction port.) Please consult SMC for further details.

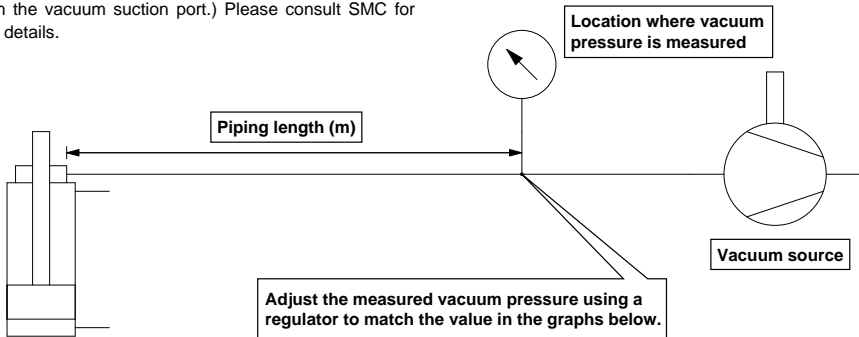

* The symbol for the cylinder is an SMC original symbol.

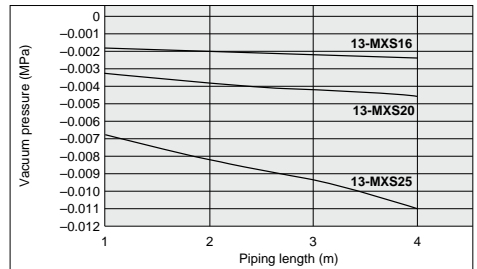
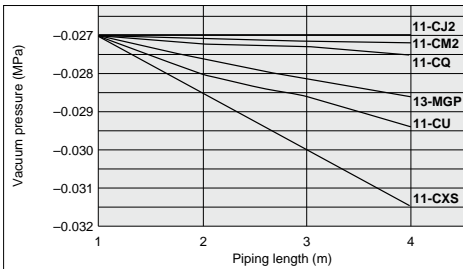

Alphabetical Index

Product Series Index

A

¹⁰⁻ ₂₁₋ AF	Air Filter	P.1069
¹⁰⁻ ₂₁₋ AFD	Micro Mist Separator	P.1073
10-AFF	Main Line Filter	P.959
10-AFF-CA□	Bowl Assembly	P.1002
¹⁰⁻ ₂₁₋ AFM	Mist Separator	P.1071
10-AM	Mist Separator	P.966
10-AM□-CA□	Bowl Assembly	P.1002
10-AMD	Micro Mist Separator	P.973
10-AME	Super Mist Separator	P.987
10-AMF	Odor Removal Filter	P.994
10-AMH	Micro Mist Separator with Pre-filter	P.980
AMP	Exhaust Cleaner for Clean Room	P.1055
¹⁰⁻ ₂₁₋ AR	Regulator	P.1075
¹⁰⁻ ₂₁₋ AR□K	Regulator with Backflow Function	P.1075
¹⁰⁻ ₂₁₋ ARP20 to ¹⁰⁻ ₂₁₋ ARP40	Direct Operated Precision Regulator/Modular Type (Special applications)	P.1093
¹⁰⁻ ₂₁₋ ARP20K to ¹⁰⁻ ₂₁₋ ARP40K	Direct Operated Precision Regulator with Backflow Function/Modular Type (Special applications)	P.1093
10-AS	Speed Controller with One-touch Fitting: In-line Type	P.1257
10-AS	Speed Controller: Cylinder Direct Mount Type/Metal Elbow Type	P.1286
10-AS	Speed Controller: In-line Type	P.1288
10-ASD	Dual Speed Controller with One-touch Fitting	P.1261
10-ASD-FG	Stainless Steel Dual Speed Controller with One-touch Fittings	P.1282
10-ASD-FM	Dual Speed Controller for Low Speed Operation	P.1301
10-AS-F	Push-lock Type Speed Controller with One-touch Fitting: Elbow Type/Universal Type	P.1243
10-AS-F	Speed Controller with One-touch Fitting: Elbow Type/Universal Type	P.1253
10-AS-FG	Push-lock Type Speed Controller with One-touch Fitting: Stainless Steel Type (Elbow/Universal)	P.1265
10-AS-FG	Stainless Steel Speed Controller with One-touch Fittings (In-line Type)	P.1279
10-AS-FG	Stainless Steel Speed Controller with One-touch Fittings (Elbow/Universal Type)	P.1275
10-AS-FM	Speed Controller for Low Speed Operation with One-touch Fittings: Elbow Type/Universal Type	P.1294
10-AS-FM	Speed Controller for Low Speed Operation with One-touch Fittings: In-line Type	P.1298
(21-)AS-FPQ/FPG	Clean Speed Controller with One-touch Fittings: Elbow Type	P.1291
10-AS-FS	Push-lock Type Speed Controller with Indicator: Elbow Type	P.1249
10-AS-FSG	Push-lock Type Speed Controller with Indicator: Stainless Steel Type (Elbow)	P.1271
¹⁰⁻ ₂₁₋ AW	Filter Regulator	P.1079
¹⁰⁻ ₂₁₋ AW□K	Filter Regulator with Backflow Function	P.1079
¹⁰⁻ ₂₁₋ AWD	Micro Mist Separator Regulator	P.1083
¹⁰⁻ ₂₁₋ AWM	Mist Separator Regulator	P.1083

C

^{10-/11-} _{21-/22-} CA2	Air Cylinder	P.736
^{10-/11-} _{21-/22-} CBM2	Cylinder with End Lock	P.716

10-11-21-22- CDU	Free Mount Cylinder	P.746
10-11-21-22- CG1-Z	Air Cylinder: Double Acting, Single Rod	P.722
10-11- CG1R-Z	Direct Mount Cylinder	P.733
10-11- CG1W-Z	Double Rod Cylinder	P.729
10-11-21-22- CJ2	Air Cylinder	P.686
10-11-21-22- CJ2-Z	Air Cylinder	P.685
10-11-21-22- CJ2RA-Z	Direct Mount Cylinder	P.698
10-11-21-22- CJ2W-Z	Double Rod Cylinder	P.695
10-11-21-22- CM2-Z	Air Cylinder	P.700
10-11-21-22- CM2R-Z	Direct Mount Cylinder	P.713
10-11-21-22- CM2W-Z	Double Rod Cylinder	P.709
10-11- CM2X-Z	Low Speed Cylinder: Double Acting, Single Rod	P.868
10-21-11-22- CQ2	Compact Cylinder	P.758
10-11- CQ2X	Low Speed Cylinder	P.872
10-21-11-22- CQS	Compact Cylinder/Compact Type	P.749
10-11- CQSX	Low Speed Cylinder	P.870
11-CRA1-Z	Rack & Pinion Type Rotary Actuator	P.905
10-21- CRB1	Vane Type Rotary Actuator	P.893
10-11- CUJ	Mini Free Mount Cylinder	P.740
10-11-11-12-21-22- CXS	Dual Rod Cylinder	P.852
11-12-21-22- CXSJ	Dual Rod Cylinder/Compact Type	P.848
12-CY3B	Magnetically Coupled Rodless Cylinder	P.767
12-CY3R	Magnetically Coupled Rodless Cylinder (Direct Mount Type)	P.769
CYP	Clean Rodless Cylinder	P.773

I

10-IDG	Membrane Air Dryer/Single Unit Type	P.950
10-IDG□A	Membrane Air Dryer/Single Unit Type	P.949
10-IR1000	Precision Regulator	P.1101
10-IR2000	Precision Regulator	P.1101
10-IR3000	Precision Regulator	P.1101
10-IRV10	Vacuum Regulator	P.1106
10-IRV20	Vacuum Regulator	P.1106
10-ISE30A	2-Color Display High Precision Digital Pressure Switch	P.1312
10-ISE40A	2-Color Display High Precision Digital Pressure Switch	P.1323
10-ISE80	2-Color Display Digital Pressure Switch for General Fluids	P.1340

K

10-KDM	Rectangular Multi-connector	P.1202
10-KF	Insert Fittings	P.1190
10-KG	Stainless One-touch Fittings	P.1206

Alphabetical Index

Product Series Index

KP	Clean One-touch Fittings for Blowing	P.1221
KPQ/KPG	Clean One-touch Fittings for Driving Air Piping	P.1225
10-KQ2	Metric Size One-touch Fittings/Applicable Tubing: Metric Size, Connection Thread: M, R, Rc	P.1124
10-KQ2	Inch Size One-touch Fittings/Applicable Tubing: Inch Size, Connection Thread: UNF, NPT	P.1154
10-KQ2	Inch Size One-touch Fittings/Applicable Tubing: Inch Size, Connection Thread: M, R, Rc	P.1176
10-KQ2	Metric Size Uni One-touch Fittings/Applicable Tubing: Metric Size, Connection Thread: Rc, G, NPT, NPTF	P.1181
10-KQ2	Inch Size Uni One-touch Fittings/Applicable Tubing: Inch Size, Connection Thread: Rc, G, NPT, NPTF	P.1186

L

LLB	Clean Air Module	P.1039
------------	------------------	---------------

M

10-M	Miniature Fittings	P.1196
10-MGF	Guide Table	P.844
12-¹³MGPL-Z	Compact Guide Cylinder	P.839
11-²²MHL2	Parallel Type Wide Opening Air Gripper	P.927
11-²²MHR2	2 Finger Rotary Actuated Air Gripper	P.932
11-²²MHR3	3 Finger Rotary Actuated Air Gripper	P.938
11-²²MHZ2	Air Gripper	P.923
10-MS	Stainless Miniature Fittings	P.1217
11-²²MSQ	Rack & Pinion Type Rotary Table	P.909
11-MXJ	Air Slide Table	P.825
11-²²MXP	Air Slide Table	P.831
11-²²MXPJ6	Air Slide Table	P.831
13-²²MXQ	Air Slide Table	P.799
13-²²MXS	Air Slide Table	P.778

P

10-PSE200	Remote Type Multi-Channel Digital Pressure Sensor Controller	P.1361
10-PSE300	Remote Type 2-Color Display Digital Pressure Sensor Controller	P.1366
10-PSE530	Remote Type Pressure Sensor/For Compact Pneumatic Pressure	P.1353
10-PSE540	Remote Type Pressure Sensor/For Compact Pneumatic Pressure	P.1355
10-PSE550	Remote Type Pressure Sensor/For Low Differential Pressure	P.1357
10-PSE560	Remote Type Pressure Sensor/For General Fluids	P.1359

R

12-REA	Sine Rodless Cylinder	P.861
10-¹¹REC	Sine Cylinder	P.864

S

10-S070	Compact Direct Operated 3 Port Solenoid Valve	P.658
10-S0700	5 Port Solenoid Valve	P.417
10-S0700	Slim Compact Plug-in Manifold Bar Base: S Kit (Serial Transmission) EX510 Gateway-type Serial Transmission System	P.425
10-S0700	Slim Compact Plug-in Manifold Bar Base: F Kit (D-sub Connector)	P.429
10-S0700	Slim Compact Plug-in Manifold Bar Base: P Kit (Flat Ribbon Cable)	P.433
10-S0700	Slim Compact Plug-in Manifold Bar Base: J Kit (PC Wiring System Compatible Flat Ribbon Cable)	P.437
10-S0700	Plug-in Manifold Stacking Base: S Kit (Serial Transmission) EX500 Gateway-type Serial Transmission System	P.447
10-S0700	Plug-in Manifold Stacking Base: S Kit (Serial Transmission) EX250 Integrated-type (For Input/Output) Serial Transmission System	P.449
10-S0700	Plug-in Manifold Stacking Base: S Kit (Serial Transmission) EX600 Integrated-type (For Input/Output) Serial Transmission System (Fieldbus System)	P.451
10-S0700	Plug-in Manifold Stacking Base: F Kit (D-sub Connector)	P.457
10-S0700	Plug-in Manifold Stacking Base: P Kit (Flat Ribbon Cable)	P.461
10-S0700	Plug-in Manifold Stacking Base: J Kit (PC Wiring System Compatible Flat Ribbon Cable)	P.465
10-S0700	Plug-in Manifold Stacking Base: T Kit (Terminal Block Box)	P.469
10-S0700	Plug-in Manifold Stacking Base: L Kit (Lead Wire)	P.473
10-S0700	Plug-in Manifold Stacking Base: M Kit (Circular Connector)	P.477
10-S0700	Plug Lead Manifold Bar Base: C Kit (Connector)	P.491
10-S0700	Plug Lead Manifold Bar Base: S Kit (Serial Transmission) EX510 Gateway-type Serial Transmission System	P.495
10-S0700	5 Port Solenoid Valve: Base Mounted/Plug Lead, Single Unit	P.499
SFA100	Clean Gas Filter: Cartridge Type/Disc Type	P.1011
SFA200	Clean Gas Filter: Cartridge Type/Disc Type	P.1011
SFA300	Clean Gas Filter: Cartridge Type/Disc Type	P.1011
SFB100	Clean Gas Filter: Cartridge Type/Straight Type	P.1014
SFB200	Clean Gas Strainer: Cartridge Type/Straight Type	P.1015
SFB300	Clean Gas Filter: Disposable Type/Straight Type	P.1018
SFC100	Clean Gas Filter: Disposable Type/Multiple Disc Type	P.1021
SFD	Clean Air Filter	P.1031
SFE	Exhaust Cleaner for Clean Room	P.1060
10-SQ1000	5 Port Solenoid Valve: Plug-in Unit	P.578
10-SQ2000	5 Port Solenoid Valve: Plug-in Unit	P.587
SRH	Clean Regulator	P.1114
SRP	Precision Clean Regulator	P.1118
10-SV	EX500 Decentralized Serial Wiring	P.183
10-SV	EX250 Serial Wiring with Input/Output Unit	P.193
10-SV	EX600 Integrated-type (For Input/Output) Serial Transmission System	P.199
10-SV	EX120 Dedicated Output Serial Wiring	P.209
10-SV	EX260 Integrated-type (For Output) Serial Transmission System	P.219
10-SV	EX126 Dedicated Output Serial Wiring	P.225
10-SV	Circular Connector	P.231
10-SV	D-sub Connector	P.241
10-SV	Flat Ribbon Cable Connector	P.251
10-SV1000	5 Port Solenoid Valve	P.179

Alphabetical Index

Product Series Index

10-SV1000	Single Unit/Sub-plate Type [IP67 Compliant]	P.265
10-SV2000	5 Port Solenoid Valve	P.179
10-SV2000	Single Unit/Sub-plate Type [IP67 Compliant]	P.265
10-SV3000	5 Port Solenoid Valve	P.179
10-SV3000	Single Unit/Sub-plate Type [IP67 Compliant]	P.265
10-SV4000	5 Port Solenoid Valve	P.179
10-SV4000	Single Unit/Sub-plate Type [IP67 Compliant]	P.265
10-SY100	Rubber Seal 3 Port/Direct Operated	P.648
10-SY300	3 Port Valve Mixed Mounting Type on 5 Port Valve Manifold	P.162
10-SY500	3 Port Valve Mixed Mounting Type on 5 Port Valve Manifold	P.162
10-SY3000	5 Port Solenoid Valve	P.38
10-SY3000	5 Port Solenoid Valve: Body Ported/Single Unit	P.43
10-SY3000	5 Port Solenoid Valve: Base Mounted/Single Unit	P.58
10-SY3000	5 Port Solenoid Valve: Body Ported Manifold, Bar Stock Type/Individual Wiring (Type 20)	P.73
10-SY3000	5 Port Solenoid Valve: Body Ported Manifold, Bar Stock Type/Flat Ribbon Cable (Type 20P)	P.83
10-SY3000	EX510 Gateway-type Serial Transmission System: Body Ported Manifold/Integrated Base (Type 20SA)	P.92
10-SY3000	5 Port Solenoid Valve: Body Ported Manifold, Cassette Type (Type 60)	P.104
10-SY3000	5 Port Solenoid Valve: Base Mounted Manifold, Bar Stock Type/Individual Wiring (Type 41/42)	P.118
10-SY3000	5 Port Solenoid Valve: Base Mounted Manifold, Bar Stock Type/Flat Ribbon Cable (Type 41P/42P)	P.134
10-SY3000	5 Port Solenoid Valve: Base Mounted Manifold, Stacking Type/DIN Rail Mounted/Individual Wiring (Type 45)	P.150
10-SY3000	5 Port Solenoid Valve: Base Mounted Manifold, Stacking Type/DIN Rail Mounted/Connector Box (Type 45-A, NA)	P.157
10-SY5000	5 Port Solenoid Valve	P.38
10-SY5000	5 Port Solenoid Valve: Body Ported/Single Unit	P.43
10-SY5000	5 Port Solenoid Valve: Base Mounted/Single Unit	P.58
10-SY5000	5 Port Solenoid Valve: Body Ported Manifold, Bar Stock Type/Individual Wiring (Type 20)	P.73
10-SY5000	5 Port Solenoid Valve: Body Ported Manifold, Bar Stock Type/Flat Ribbon Cable (Type 20P)	P.83
10-SY5000	EX510 Gateway-type Serial Transmission System: Body Ported Manifold/Integrated Base (Type 20SA)	P.92
10-SY5000	5 Port Solenoid Valve: Body Ported Manifold, Cassette Type (Type 60)	P.104
10-SY5000	5 Port Solenoid Valve: Base Mounted Manifold, Bar Stock Type/Individual Wiring (Type 41/42)	P.118
10-SY5000	5 Port Solenoid Valve: Base Mounted Manifold, Bar Stock Type/Flat Ribbon Cable (Type 41P/42P)	P.134
10-SY5000	5 Port Solenoid Valve: Base Mounted Manifold, Stacking Type/DIN Rail Mounted/Individual Wiring (Type 45)	P.150
10-SY5000	5 Port Solenoid Valve: Base Mounted Manifold, Stacking Type/DIN Rail Mounted/Connector Box (Type 45-A, NA)	P.157
10-SY7000	5 Port Solenoid Valve	P.38
10-SY7000	5 Port Solenoid Valve: Body Ported/Single Unit	P.43
10-SY7000	5 Port Solenoid Valve: Base Mounted/Single Unit	P.58
10-SY7000	5 Port Solenoid Valve: Body Ported Manifold, Bar Stock Type/Individual Wiring (Type 20)	P.73
10-SY7000	5 Port Solenoid Valve: Body Ported Manifold, Bar Stock Type/Flat Ribbon Cable (Type 20P)	P.83
10-SY7000	EX510 Gateway-type Serial Transmission System: Body Ported Manifold/Integrated Base (Type 20SA)	P.92
10-SY7000	5 Port Solenoid Valve: Body Ported Manifold, Cassette Type (Type 60)	P.104
10-SY7000	5 Port Solenoid Valve: Base Mounted Manifold, Bar Stock Type/Individual Wiring (Type 41/42)	P.118
10-SY7000	5 Port Solenoid Valve: Base Mounted Manifold, Bar Stock Type/Flat Ribbon Cable (Type 41P/42P)	P.134
10-SY9000	5 Port Solenoid Valve	P.38
10-SY9000	5 Port Solenoid Valve: Body Ported/Single Unit	P.43

10-SY9000	5 Port Solenoid Valve: Base Mounted/Single Unit	P.58
10-SY9000	5 Port Solenoid Valve: Body Ported Manifold, Stacking Type/Individual Wiring (Type 23)	P.79
10-SY9000	5 Port Solenoid Valve: Body Ported Manifold, Stacking Type/Flat Ribbon Cable (Type 23P)	P.89
10-SY9000	EX510 Gateway-type Serial Transmission System: Body Ported Manifold/Stacking Type (Type 23SA)	P.97
10-SY9000	5 Port Solenoid Valve: Base Mounted Manifold, Stacking Type/Individual Wiring (Type 43)	P.128
10-SY9000	5 Port Solenoid Valve: Base Mounted Manifold, Stacking Type/Flat Ribbon Cable (Type 43P)	P.142
10-SYJ300	Rubber Seal 3 Port Solenoid Valve	P.602
10-SYJ300	Rubber Seal 3 Port Pilot Solenoid Valve	P.604
10-SYJ3000	Rubber Seal 4/5 Port Solenoid Valve	P.279
10-SYJ3000	Rubber Seal 4/5 Port Solenoid Valve	P.283
10-SYJ3000	EX510 Gateway-type Serial Transmission System: Body Ported Manifold	P.297
10-SYJ3000	EX510 Gateway-type Serial Transmission System: Base Mounted Manifold	P.298
10-SYJ500	Rubber Seal 3 Port Solenoid Valve	P.602
10-SYJ500	Rubber Seal 3 Port Pilot Solenoid Valve	P.615
10-SYJ5000	Rubber Seal 4/5 Port Solenoid Valve	P.279
10-SYJ5000	Rubber Seal 5 Port Solenoid Valve	P.311
10-SYJ5000	EX510 Gateway-type Serial Transmission System: Body Ported Manifold	P.325
10-SYJ5000	EX510 Gateway-type Serial Transmission System: Base Mounted Manifold	P.326
10-SYJ700	Rubber Seal 3 Port Solenoid Valve	P.602
10-SYJ700	Rubber Seal 3 Port Pilot Solenoid Valve	P.627
10-SYJ7000	Rubber Seal 4/5 Port Solenoid Valve	P.279
10-SYJ7000	Rubber Seal 5 Port Solenoid Valve	P.342
10-SYJ7000	EX510 Gateway-type Serial Transmission System: Body Ported Manifold	P.355
10-SYJ7000	EX510 Gateway-type Serial Transmission System: Base Mounted Manifold	P.356
10-SZ3000	5 Port Solenoid Valve	P.377
10-SZ3000	5 Port Solenoid Valve: Plug-in Type	P.378
10-SZ3000	5 Port Solenoid Valve: Non Plug-in Type	P.393
10-SZ3000	EX140 Integrated-type (For Output) Serial Transmission System (Type 60S□)	P.399
10-SZ3000	EX510 Gateway-type Serial Transmission System: Plug-in Type, Cassette Type Manifold (Type 60S6B)	P.403
10-SZ3000	PC Wiring System: Plug-in Type (Type 60GD)	P.407

T

10-TCU	Polyurethane Coil Tubing	P.1233
10-TFU	Polyurethane Flat Tubing	P.1234
TPH	Clean Tubing: Polyolefin Tubing	P.1235
TPS	Clean Tubing: Soft Polyolefin Tubing	P.1236
10-TU	Polyurethane Tubing	P.1232

V

10-21-VQ1000	5 Port Solenoid Valve	P.514
10-21-VQ1000	Base Mounted Plug-in Unit	P.515

Alphabetical Index

Product Series Index

10-21-VQ1000	F Kit (D-sub Connector)	P.523
10-21-VQ1000	P Kit (Flat Ribbon Cable)	P.527
10-21-VQ1000	J Kit (Flat Ribbon Cable)	P.531
10-21-VQ1000	G Kit (Flat Ribbon Cable with Terminal Block)	P.535
10-21-VQ1000	T Kit (Terminal Block Box)	P.539
10-21-VQ1000	L Kit (Lead Wire)	P.543
10-21-VQ1000	S Kit (Serial Transmission) Base Mounted Plug-in Manifold: For EX510 Gateway-type Serial Transmission System	P.547
10-21-VQ1000	S Kit (Serial Transmission): For EX120/123/124 Integrated-type (Output) Serial Transmission System	P.551
10-21-VQ2000	5 Port Solenoid Valve	P.514
10-21-VQ2000	Base Mounted Plug-in Unit	P.517
10-21-VQ2000	Sub-plate Single Unit	P.560
10-21-VQ2000	F Kit (D-sub Connector)	P.523
10-21-VQ2000	P Kit (Flat Ribbon Cable)	P.527
10-21-VQ2000	J Kit (Flat Ribbon Cable)	P.531
10-21-VQ2000	G Kit (Flat Ribbon Cable with Terminal Block)	P.535
10-21-VQ2000	T Kit (Terminal Block Box)	P.539
10-21-VQ2000	L Kit (Lead Wire)	P.543
10-21-VQ2000	S Kit (Serial Transmission) Base Mounted Plug-in Manifold: For EX510 Gateway-type Serial Transmission System	P.547
10-21-VQ2000	S Kit (Serial Transmission): For EX120/123/124 Integrated-type (Output) Serial Transmission System	P.551
10-21-VQ2000	S Kit (Serial Transmission): For EX240 Integrated-type (I/O) Serial Transmission System	P.555
10-21-VQ2000	M Kit (Circular Connector)	P.557
10-VQD1000	4 Port Direct Operated Poppet Solenoid Valve	P.597

Z

10-ZSE30A(F)	2-Color Display High Precision Digital Pressure Switch	P.1312
10-ZSE40A(F)	2-Color Display High Precision Digital Pressure Switch	P.1323
10-ZSE80	2-Color Display Digital Pressure Switch for General Fluids	P.1340

Revision history

2nd Edition

- **Series Added**
 - **Actuator**
Series 10-CBM2, 10-REC, 10-CXSL, 10-MGPL, 10-MGF, 12-CY1B, 12-CY1R, 12-REA, 11-MSQ, 11-MHR2/3, 11-MHL2
 - **Directional Control Valve**
Series 10-SYJ, 10-SY100, 10-VQ100, 10-VQD1000
 - **Air Line Equipment**
Series 10-AFM, 10-AFD, 10-ARP, 10-AWM, 10-AWD
 - **Air Purification Equipment**
Series 10-AMD, 10-IDG
 - **Pressure Switch**
Series 10-PSE, 10-ZSE/ISE
 - **Clean Regulator**
Series SR
 - **Clean Gas Filter**
Series SF
- **Addition of Safety Instructions**
- **Series Removed**
 - **Directional Control Valve**
Series 10-VZ

AY

3rd Edition

- **Series Added**
 - **Actuator**
Series 10-CUJ, 10-CXSJ, 11-MXP, 11-MXPJ6, 13-MXQ, 13-MXS, CYP, 10-CQSX, 10-CQ2X, 10-CM2X, 11-MHZ2
 - **Directional Control Valve**
Series 10-SZ3000, 10-SQ1000/2000
 - **Air Line Equipment**
<Speed controller>
Series AS-FPG/FPQ, 10-AS/FG(Universal/In-line type), 10-ASD, 10-AS/FM, 10-ASD/FM
<Regulator>
Series 10-IR1000/2000/3000
<Fittings & Tubing>
Series KP-KPQ/KPG, TPH, TPS
 - **Air Purification Equipment**
Series AMP220/320/420
 - **Pressure Switch**
Series 10-ZSE40/ISE40
 - **Clean Regulator**
Series SRH3000/4000, SRP1000
- **Series Removed**
 - **Pressure Switch**
Series 10-ZSE4E/ISE4E
 - **Clean Regulator**
Series SRE1000/3000/4000

EZ

CAT. E02-23 A

- **Addition of Series for Copper, Fluorine, and Silicone Free + Low Particle Generation (Series 21-/22-)**
 - **Actuator**
Change of auto switch D-F9 type → D-M9 type
Addition of ø80 and ø100 of series CG1
Addition of series CA2
Addition of ø80 and ø100 of series CQ2
Addition of series 10- of series CXS
Change of series CY1B/CY1R ø15/20/25/32/40 → CY3B/CY3R ø15/20/25/32/40
Addition of ø50 and ø63 of series CQ2X
Addition of size 1, 2, 3 and 7 of series MSQ
Addition of size 40 of series MHL2
Change of dimensions of series MXS

- **Directional Control Valve**
Addition of series SV1000/2000/3000/4000
Addition of series V100
Replacement of series new SY3000/5000/7000/9000
Replacement of series new SYJ3000/5000/7000
Replacement of series new SYJ300/500/700
- **Flow Control Equipment**
Addition of inline type with One-touch fittings
Addition of inline type for low speed operation
- **Filter/Pressure Control Equipment**
Replacement of series new AF/AR/AW/AWM/AWD
- **Air Preparation Equipment**
Addition of series AFF
Addition of series AMH
Addition of series IDG1 to 5 and 20 to 100
Addition of series IDG3H to 100H
Addition of series IDG30L to 100L
Addition of series IDG60S to 100S
- **Pressure Switch**
Addition of series ZSE/ISE30 and 50
Change of series PSE510 → PSE530/540/550/560
Change of series PSE100 → PSE200/300

MT

CAT. E02-23 B

- Cleanliness Class Notation: Changed to ISO Classes
- **Series Added**
 - Series 10-S0700, 10-S070
 - Series 11-MXJ
Addition of ø6, ø10, ø50 and ø63 of series 12-CY3B/12-CY3R
Series SFD, LLB, SFE
Series 10-AS-F (Push-lock),
10-AS-FS (With indicator), 10-AS-FG (Push-lock),
10-AS-FSG (With indicator), 10-AS (In-line)
- **Change to Remodeled Products**
 - Series 10-VQ1000/2000, 10-SQ1000/2000
Series 10-CJ2-Z, 10-CM2-Z, 10-CG1-Z, 10-CQ2-Z,
10-CM2X-Z, 10-MGPL-Z
Series 11-CRA1-Z
Series 10-IDG□A, 10-AFF, 10-AM, 10-AMD, 10-AMH,
10-AME, 10-AMF
Series 10-IRV10/20
Series 10-KQ2
Series 10-ZSE30A(F)/ISE30A, 10-ZSE40A(F)/ISE40A,
10-ZSE80(F)/ISE80(H)

UR

Pneumatic Clean Series



SMC Corporation

Akihabara UDX 15F,
4-14-1, Sotokanda, Chiyoda-ku, Tokyo 101-0021, JAPAN
<http://www.smcworld.com>

Specifications are subject to change without prior notice and any obligation on the part of the manufacturer.

© 2016 SMC Corporation All Rights Reserved

D-G 1st printing MT printing UR 12000DN Printed in Japan.