

Series SYJ300 Manifold Specifications

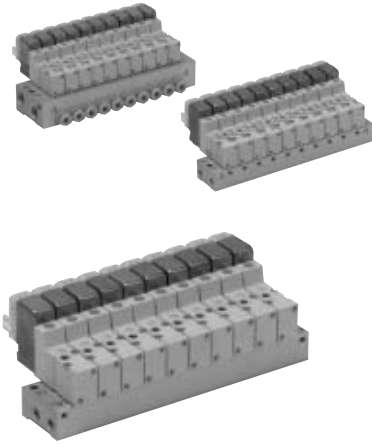

Manifold Specifications

Model	For internal pilot	Type 20	Type 41, S41	Type 42, S42
	For external pilot	Type 20R	—	Type 42R, S42R
Manifold type	Single base/B mount			
P (SUP), R (EXH)	Common SUP/Common EXH			
Valve stations	2 to 20 stations			
A port Porting specifications	Location	Valve	Base	
	Direction	Top	Side	
Port size	P, R port	$\frac{M5 \times 0.8}{1/8}$	M5 x 0.8	1/8
		A port	M3 x 0.5	M5 x 0.8 C4 (One-touch fitting $\phi 4$)
	X port ^{Note)}	M5 x 0.8	—	M5 x 0.8

Note) Only for external pilot

Flow Characteristics

Manifold			Port size		Flow characteristics						Effective area (mm ²)
					1 → 2 (P → A)			2 → 3 (A → R)			
					C [dm ³ /(s bar)]	b	Cv	C [dm ³ /(s bar)]	b	Cv	
Body ported for internal pilot	Type SS3YJ3-20	SYJ3□2	M5 x 0.8	M3 x 0.5	—	—	—	—	—	—	0.9
	Type SS3YJ3-41 S41	SYJ3□4	M5 x 0.8	M3 x 0.5	—	—	—	—	—	—	1.5
Base mounted for internal pilot	Type SS3YJ3-42-M5	SYJ3□4	1/8	M5 x 0.8	0.31	0.17	0.075	0.32	0.11	0.072	—
	Type SS3YJ3-42-C4			C4	0.33	0.36	0.086	0.33	0.2	0.082	—
	Type SS3YJ3-S42-M5	SYJ3□4	1/8	M5 x 0.8	0.32	0.3	0.079	0.33	0.35	0.086	—
	Type SS3YJ3-S42-C4			C4	0.35	0.17	0.082	0.35	0.26	0.086	—
Body ported for external pilot	Type SS3YJ3-20R	SYJ3□2R	1/8	M3 x 0.5	—	—	—	—	—	—	0.9
Base mounted for external pilot	Type SS3YJ3-42R-M5	SYJ3□4R	1/8	M5 x 0.8	0.31	0.17	0.075	0.32	0.11	0.072	—
	Type SS3YJ3-42R-C4			C4	0.33	0.36	0.086	0.33	0.20	0.082	—
	Type SS3YJ3-S42R-M5	SYJ3□4R	1/8	M5 x 0.8	0.32	0.30	0.079	0.33	0.35	0.086	—
	Type SS3YJ3-S42R-C4			C4	0.35	0.17	0.082	0.35	0.26	0.086	—

Note) Value at manifold base mounted, 2 position single acting

How to Order Manifold (Example)

Instruct by specifying the valves and blanking plate assembly to be mounted on the manifold along with the manifold base model no.

Example:

- SS3YJ3-20-03.....1 set (Manifold base)
- SS3YJ3-42R-03-C41 set (Manifold base)
- * SYJ312-5LZ-M3.....2 sets (Valve)
- * SYJ314R-5G.....2 sets (Valve)
- * SYJ300-10-1A.....1 set (Blanking plate assembly)
- * SYJ300-10-2A.....1 set (Blanking plate assembly)

↳ The asterisk denotes the symbol for assembly. Prefix it to the part nos. of the solenoid valve, etc.

3 Port Pilot Operated Solenoid Valve Rubber Seal Series SYJ300

Combinations of Solenoid Valve, Manifold Gasket and Manifold Base

**Body ported
(Type SYJ3□2(R))**

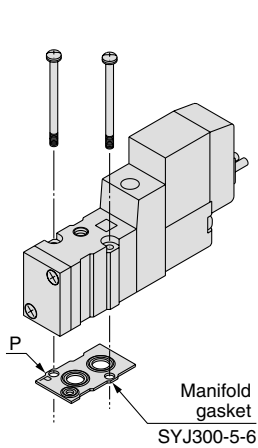

Applicable base
SS3YJ3-20 | Manifold
SS3YJ3-20R | base

**Base mounted
(Type SYJ3□4(R))**

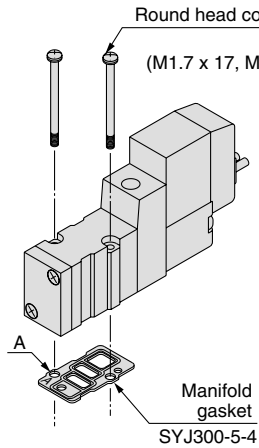

Applicable base
Sub-plate
SS3YJ3-41
SS3YJ3-S41
SS3YJ3-42
SS3YJ3-S42
SS3YJ3-42R
SS3YJ3-S42R } Manifold
base

Blanking Plate Assembly

Part no.: SYJ300-10-1A

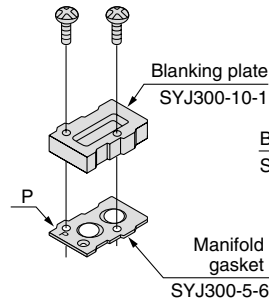

Applicable base
SS3YJ3-20 | Manifold
SS3YJ3-20R | base

Part no.: SYJ300-10-2A

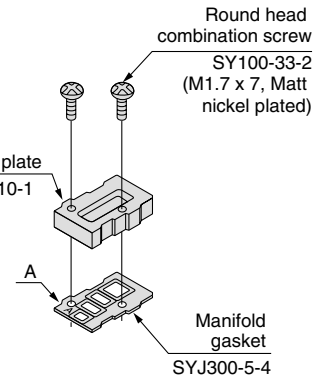

Applicable base
Sub-plate
SS3YJ3-41
SS3YJ3-S41
SS3YJ3-42
SS3YJ3-S42
SS3YJ3-42R
SS3YJ3-S42R } Manifold
base

⚠ Caution

Mounting Screw Tightening Torques

M1.7: 0.12 N·m

Use caution to the assembly orientation for solenoid valves, gasket, and optional parts.

V100

SY

SYJ

VK

VZ

VT

VP

VG

VP

S070

VQ

VKF

VQZ

VZ

VS

VFN

Series SYJ300

Manifold for Internal Pilot Type

Type 20

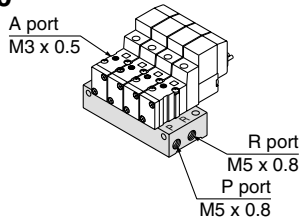

How to Order

SS3YJ3-20-05-□

Stations	
02	2 stations
:	:
20	20 stations

Bracket	
Nil	Without bracket
F	With bracket

Applicable solenoid valve
 SYJ312-□□□□-M3
 SYJ312M-□□□□-M3
 SYJ322-□□□□-M3
 SYJ322M-□□□□-M3

Applicable blanking plate assembly
 SYJ300-10-1A

Note) For more than 10 stations, supply air to both sides of P port and exhaust air from both sides of R port.

Type 41

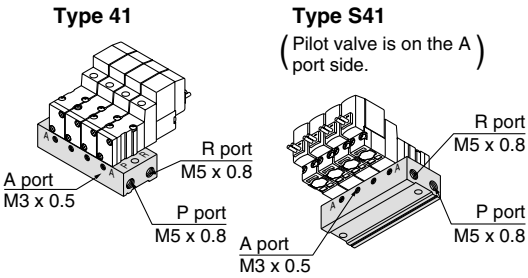

How to Order

SS3YJ3-□41-05-M3

Valve mounting direction	
Nil	Pilot valve is opposite the A port side.
S	Pilot valve is on the A port side.

Stations	
02	2 stations
:	:
20	20 stations

Applicable solenoid valve
 SYJ314-□□□□
 SYJ314M-□□□□
 SYJ324-□□□□
 SYJ324M-□□□□

Applicable blanking plate assembly
 SYJ300-10-2A

Note) For more than 10 stations, supply air to both sides of P port and exhaust air from both sides of R port.

Type 42

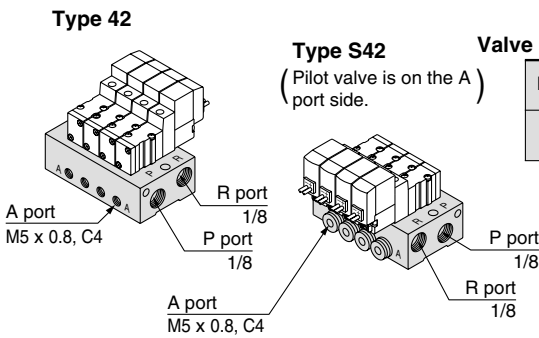

How to Order

SS3YJ3-□42-05-M5-□

Valve mounting direction	
Nil	Pilot valve is opposite the A port side.
S	Pilot valve is on the A port side.

Stations	
02	2 stations
:	:
20	20 stations

A port size	
M5	M5 x 0.8
C4	ø4 One-touch fitting
N3	ø5/32" One-touch fitting

Applicable solenoid valve
 SYJ314-□□□□
 SYJ314M-□□□□
 SYJ324-□□□□
 SYJ324M-□□□□

Applicable blanking plate assembly
 SYJ300-10-2A

P, R port thread type	
Nil	Rc
F	G
N	NPT
T	NPTF

Note) For more than 8 stations, supply/exhaust air to/from both sides of P port and R port.

Manifold for External Pilot Type

Pilot valve pressure is supplied separately from the main valve pressure through the use of a separate supply port. It can be used in the vacuum (up to -100 kPa) or low pressure line with 0.15 MPa or less.

Type 20R

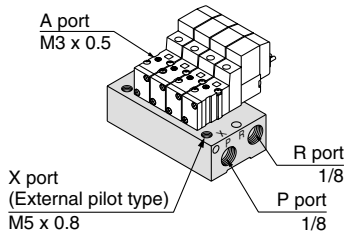

How to Order

SS3YJ3-20R-05-□

Stations	
02	2 stations
:	:
20	20 stations

P, R port thread type	
Nil	Rc
00F	G
00N	NPT
00T	NPTF

Applicable solenoid valve
 SYJ312R-□□□□
 SYJ322R-□□□□

Applicable blanking plate assembly
 SYJ300-10-1A

Note) For more than 10 stations, supply/exhaust air to/from both sides of P port and R port.

Type 42R

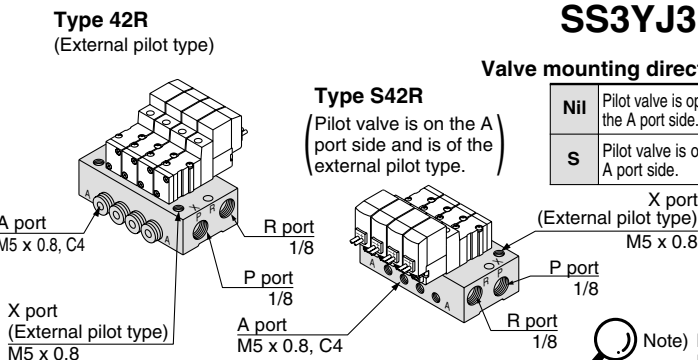

How to Order

SS3YJ3-□42R-05-M5-□

Valve mounting direction	
Nil	Pilot valve is opposite the A port side.
S	Pilot valve is on the A port side.

Stations	
02	2 stations
:	:
20	20 stations

A port size	
M5	M5 x 0.8
C4	ø4 One-touch fitting
N3	ø5/32" One-touch fitting

Applicable solenoid valve
 SYJ314R-□□□□
 SYJ324R-□□□□

Applicable blanking plate assembly
 SYJ300-10-2A

P, R port thread type	
Nil	Rc
F	G
N	NPT
T	NPTF

Note) For more than 8 stations, supply/exhaust air to/from both sides of P port and R port.

Series SYJ300

Type 20R Manifold: Top Ported (External Pilot Type)/SS3YJ3-20R- **Stations -00** □

* [] for AC

Grommet (G)

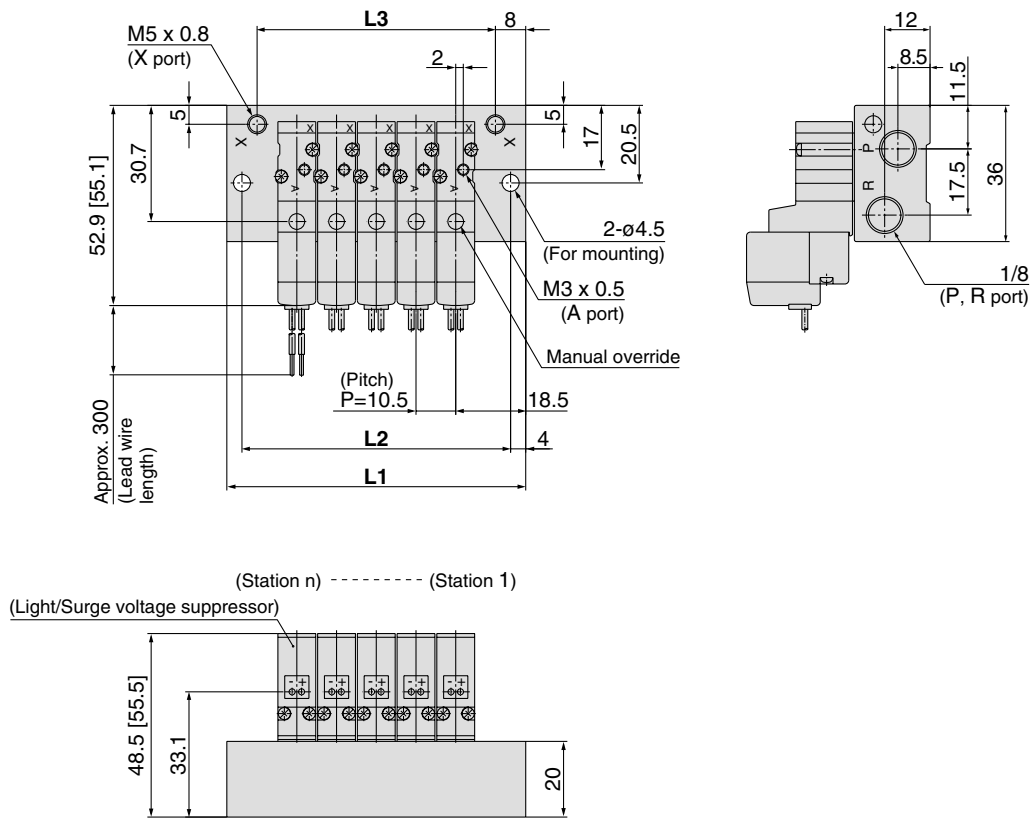

L plug connector (L)

M plug connector (M)

M8 connector (WO)

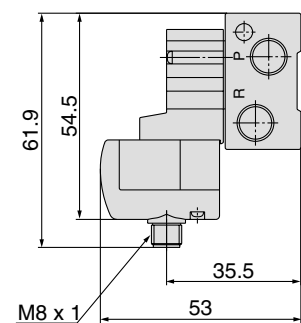
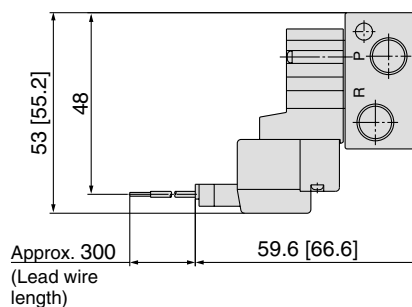
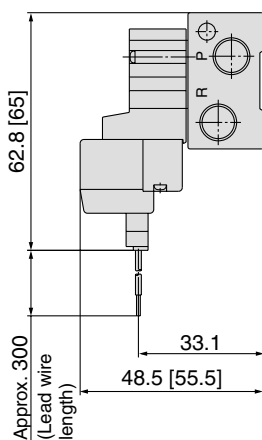

* Refer to page 4-4-61 for dimensions with connector cable.

Station n	Station 2	3	4	5	6	7	8	9	10	11	12	13	14	15	16	17	18	19	Station 20
L1	47.5	58	68.5	79	89.5	100	110.5	121	131.5	142	152.5	163	173.5	184	194.5	205	215.5	226	236.5
L2	39.5	50	60.5	71	81.5	92	102.5	113	123.5	134	144.5	155	165.5	176	186.5	197	207.5	218	228.5
L3	31.5	42	52.5	63	73.5	84	94.5	105	115.5	126	136.5	147	157.5	168	178.5	189	199.5	210	220.5

3 Port Pilot Operated Solenoid Valve Rubber Seal Series SYJ300

Type 42R Manifold: Side Ported (External Pilot Type)/SS3YJ3-42R- Stations -M5, C4 N3] for AC

Grommet (G)
For M5

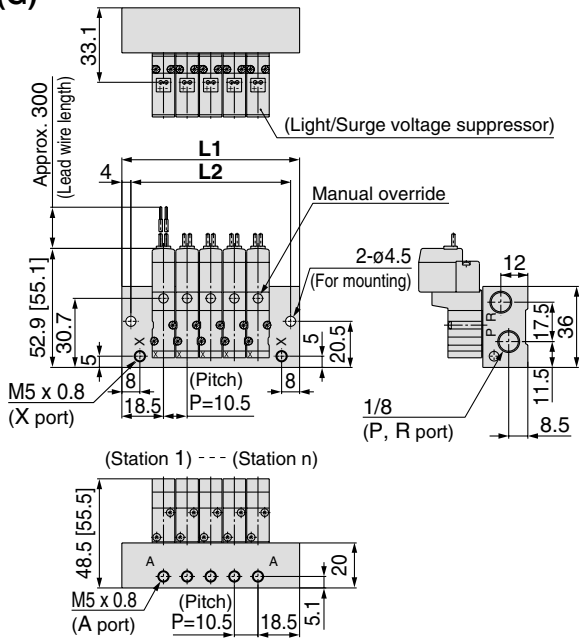

For C4 N3 (Built-in One-touch fitting)

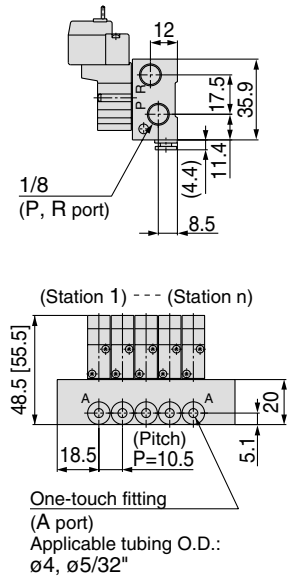

L plug connector (L)

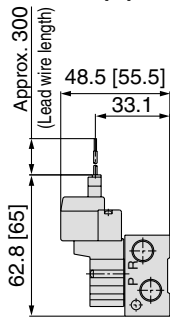

M plug connector (M)

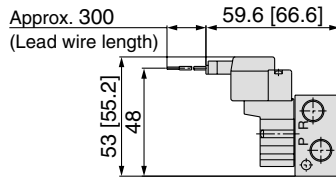

M8 connector (WO)

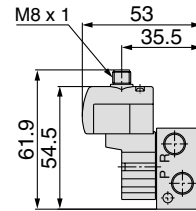

* Refer to page 4-4-61 for dimensions with connector cable.

Type S42R Manifold: Side Ported (Pilot valve is on the A port side)/SS3YJ3-S42R- Stations -M5, C4 N3]

Grommet (G)
For M5

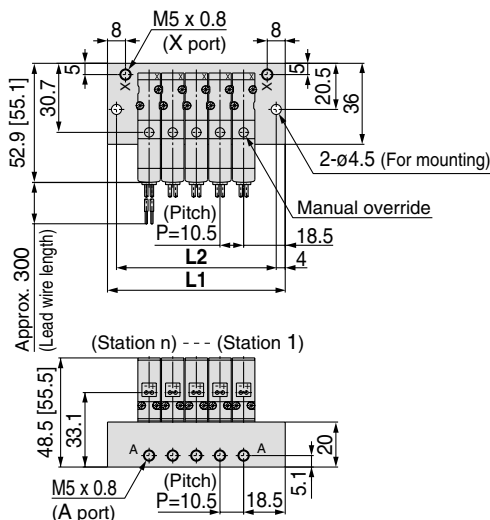

For C4 N3 (Built-in One-touch fitting)

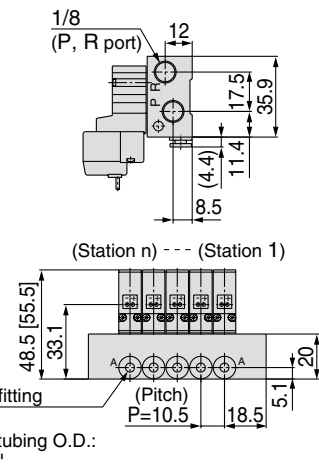

Station n	Station 2	3	4	5	6	7	8	9	10	11	12	13	14	15	16	17	18	19	Station 20
L1	47.5	58	68.5	79	89.5	100	110.5	121	131.5	142	152.5	163	173.5	184	194.5	205	215.5	226	236.5
L2	39.5	50	60.5	71	81.5	92	102.5	113	123.5	134	144.5	155	165.5	176	186.5	197	207.5	218	228.5

V100

SY

SYJ

VK

VZ

VT

VP

VG

VP

S070

VQ

VKF

VQZ

VZ

VS

VFN

Series SYJ500 Manifold Specifications

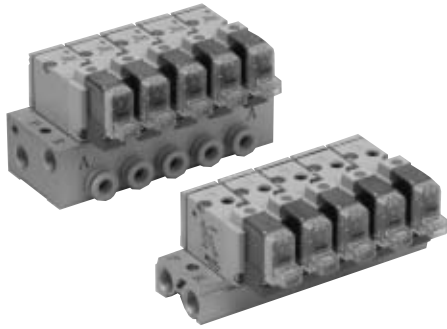

Manifold Specifications

Model	For internal pilot	Type 20	Type 40	Type 41
	For external pilot	Type 21R	Type 40R	Type 41R
Manifold type	Single base/B mount			
P (SUP), R (EXH)	Common SUP, common EXH			
Valve stations	2 to 20 stations			
A port Porting specifications	Location	Valve	Base	
	Direction	Top	Bottom	Side
Port size	P, R port	1/8	1/8	1/8
	A port	M5 x 0.8	M5 x 0.8 1/8	M5 x 0.8, 1/8, C4 (One-touch fitting for ø4), C6 (One-touch fitting for ø6)
	X port ^{Note)}	M5 x 0.8	M5 x 0.8	M5 x 0.8

Note) Only for external pilot

Flow Characteristics

Manifold			Port size		Flow characteristics					
					1 → 2 (P → A)			2 → 3 (A → R)		
1(P), 3(R) port	2(A) port		C [dm ³ /(s·bar)]	b	Cv	C [dm ³ /(s·bar)]	b	Cv		
Body ported for internal pilot	Type SS3YJ5-20	SYJ5□2	1/8	M5 x 0.8	0.47	0.43	0.13	0.74	0.32	0.19
Base mounted for internal pilot	Type SS3YJ5-40-M5	SYJ5□4	1/8	M5 x 0.8	0.71	0.52	0.21	0.81	0.28	0.20
	Type SS3YJ5-40-01		1/8	1/8	0.98	0.36	0.25	0.92	0.24	0.22
	Type SS3YJ5-41-M5		1/8	M5 x 0.8	0.71	0.49	0.20	0.80	0.23	0.19
	Type SS3YJ5-41-01		1/8	1/8	1.0	0.37	0.26	0.96	0.25	0.24
	Type SS3YJ5-41-C4		1/8	C4	0.68	0.35	0.17	1.0	0.25	0.24
	Type SS3YJ5-41-C6		1/8	C6	1.0	0.27	0.25	1.0	0.30	0.26
Body ported for external pilot	Type SS3YJ5-21R	SYJ5□2R	1/8	M5 x 0.8	0.47	0.43	0.13	0.74	0.32	0.19
Base mounted for external pilot	Type SS3YJ5-40R-M5	SYJ5□4R	1/8	M5 x 0.8	0.71	0.52	0.21	0.81	0.28	0.20
	Type SS3YJ5-40R-01		1/8	1/8	0.98	0.36	0.25	0.92	0.24	0.22
	Type SS3YJ5-41R-M5		1/8	M5 x 0.8	0.71	0.49	0.20	0.80	0.23	0.19
	Type SS3YJ5-41R-01		1/8	1/8	1.0	0.37	0.26	0.96	0.25	0.24
	Type SS3YJ5-41R-C4		1/8	C4	0.68	0.35	0.17	1.0	0.25	0.24
	Type SS3YJ5-41R-C6		1/8	C6	1.0	0.27	0.25	1.0	0.30	0.26

Note) Value at manifold base mounted, 2 position single operating

How to Order Manifold (Example)

Instruct by specifying the valves and blanking plate assembly to be mounted on the manifold along with the manifold base model no.

Example:

- SS3YJ5-20-03 1 set (Manifold base)
- SS3YJ5-41R-03-C6 1 set (Manifold base)
- *SYJ512-5LZ-M5 2 sets (Valve)
- *SYJ514R-5G 2 sets (Valve)
- *SYJ500-10-1A 1 set (Blanking plate assembly)
- *SYJ500-10-3A 1 set (Blanking plate assembly)

↳ The asterisk denotes the symbol for assembly. Prefix it to the part nos. of the solenoid valve, etc.

3 Port Pilot Operated Solenoid Valve Rubber Seal Series SYJ500

Combinations of Solenoid Valve, Manifold Gasket and Manifold Base

Body ported (Type SYJ5□2(R))

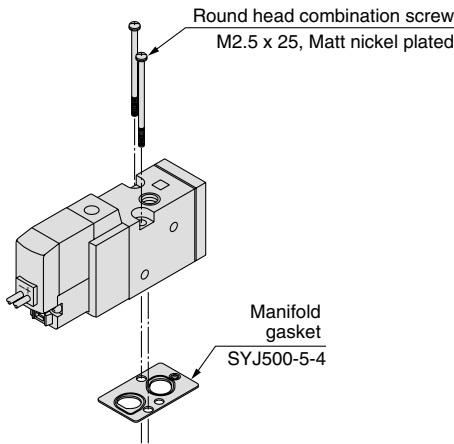

Applicable base
SS3YJ5-21R } Manifold base
SS3YJ5-20 }
Manifold base

Base mounted (Type SYJ5□4(R))

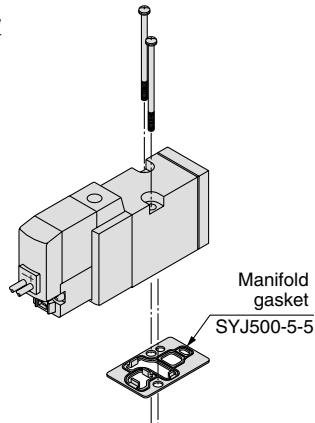

Applicable base
Sub-plate
SS3YJ5-40 } Manifold base
SS3YJ5-41 }
SS3YJ5-40R }
SS3YJ5-41R }

Blanking Plate Assembly

Part no.: SYJ500-10-3A

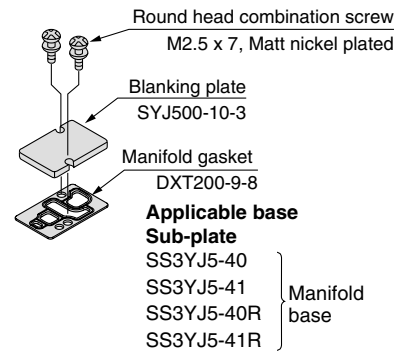

Part no.: SYJ500-10-1A

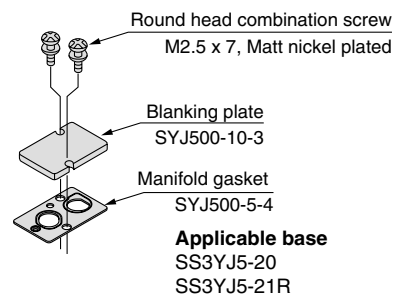

Caution

Mounting screw tightening torques

M2.5: 0.45 N·m

Use caution to the assembly orientation for solenoid valves (blanking plate) and manifold gasket.

V100

SY

SYJ

VK

VZ

VT

VP

VG

VP

S070

VQ

VKF

VQZ

VZ

VS

VFN

Series SYJ500

Manifold for Internal Pilot Type

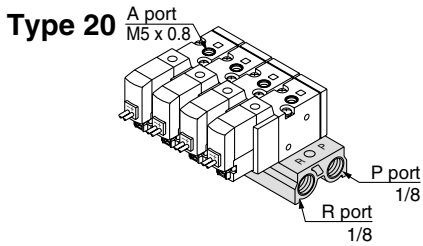

How to Order

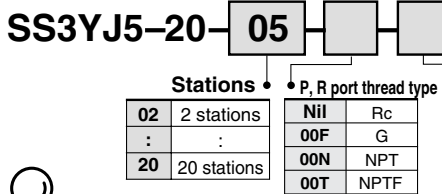

Applicable solenoid valve
 SYJ512-□□□□-M5
 SYJ512M-□□□□-M5
 SYJ522-□□□□-M5
 SYJ522M-□□□□-M5

Applicable blanking plate assembly
 SYJ500-10-1A



Note) For more than 6 stations, supply air to both sides of P port and exhaust air from both sides of R port.

Type 40

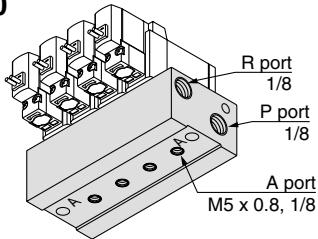

How to Order

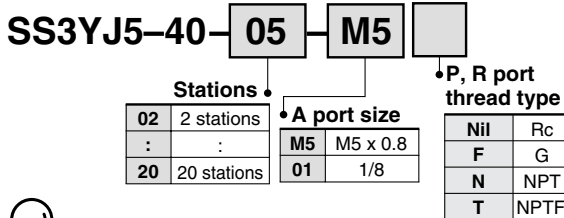

Applicable solenoid valve
 SYJ514-□□□□
 SYJ514M-□□□□
 SYJ524-□□□□
 SYJ524M-□□□□

Applicable blanking plate assembly
 SYJ500-10-3A



Note) For more than 9 stations, supply air to both sides of P port and exhaust air from both sides of R port.

Type 41

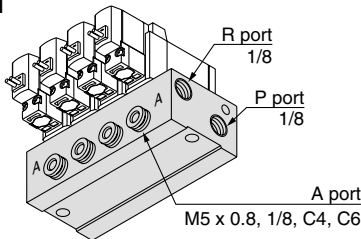

How to Order

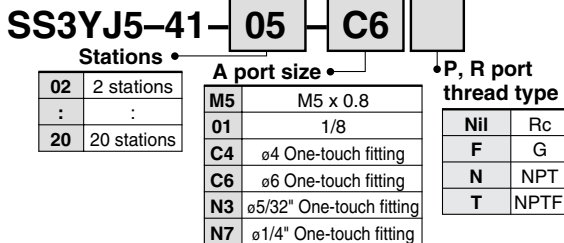

Applicable solenoid valve
 SYJ514-□□□□
 SYJ514M-□□□□
 SYJ524-□□□□
 SYJ524M-□□□□

Applicable blanking plate assembly
 SYJ500-10-3A



Note) For more than 9 stations, supply air to both sides of P port and exhaust air from both sides of R port.

Manifold for External Pilot Type

Pilot valve pressure is supplied separately from the main valve pressure through the use of a separate supply port. It can be used in the vacuum (up to -100 kPa) or low pressure line with 0.15 MPa or less.

Type 21R

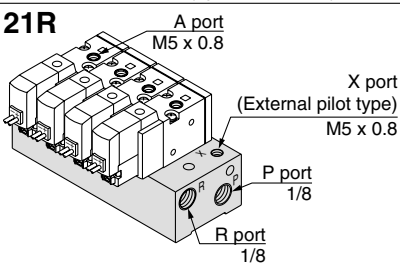

How to Order

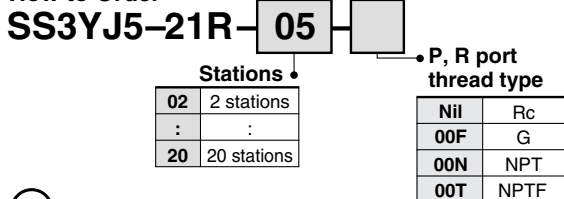

Applicable solenoid valve
 SYJ512R-□□□□-M5
 SYJ522R-□□□□-M5

Applicable blanking plate assembly
 SYJ500-10-1A



Note) For more than 9 stations, supply/exhaust air to/from both sides of P and R port

Type 40R

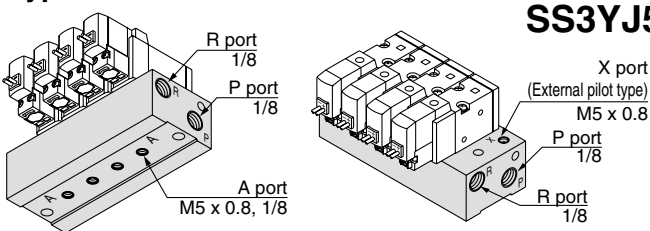

How to Order

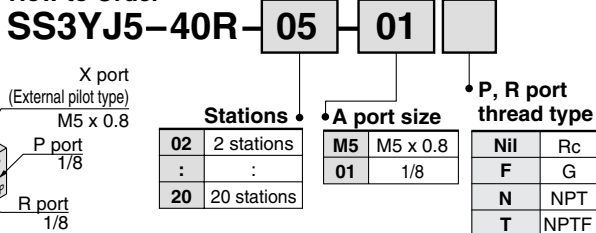

Applicable solenoid valve
 SYJ514R-□□□□
 SYJ524R-□□□□

Applicable blanking plate assembly
 SYJ500-10-3A



Note) For more than 9 stations, supply/exhaust air to/from both sides of P and R port

Type 41R

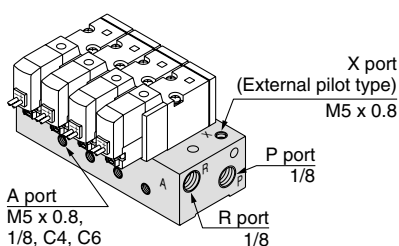

How to Order

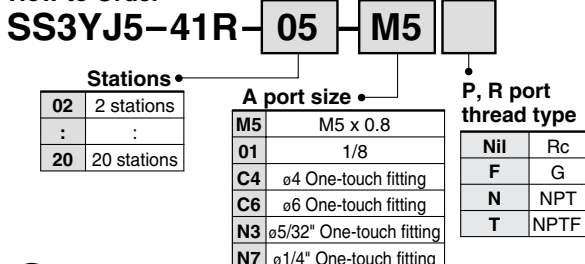

Applicable solenoid valve
 SYJ514R-□□□□
 SYJ524R-□□□□

Applicable blanking plate assembly
 SYJ500-10-3A



Note) For more than 9 stations, supply/exhaust air to/from both sides of P and R port

3 Port Pilot Operated Solenoid Valve Rubber Seal Series SYJ500

Type 21R Manifold: Top Ported (External Pilot Type)/SS3YJ5-21R-Stations-00□

* [] for AC

Grommet (G)

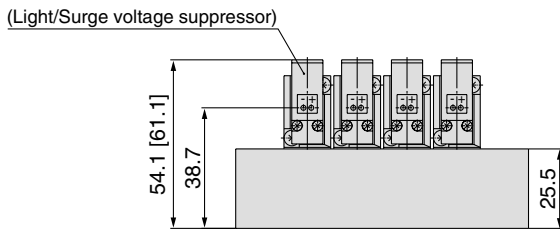
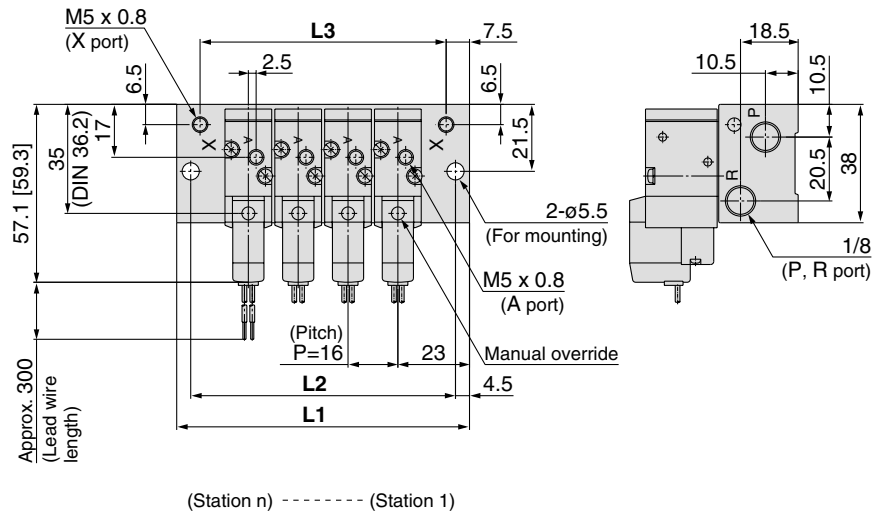

L plug connector (L)

M plug connector (M)

DIN terminal (D)

M8 connector (WO)

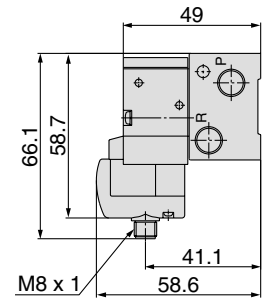
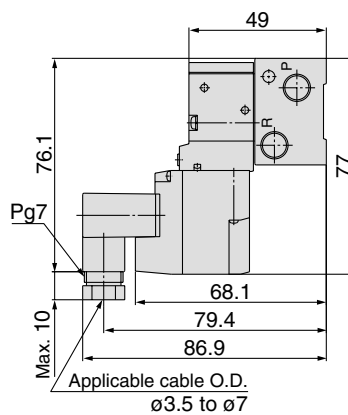
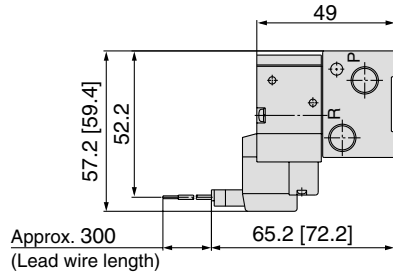
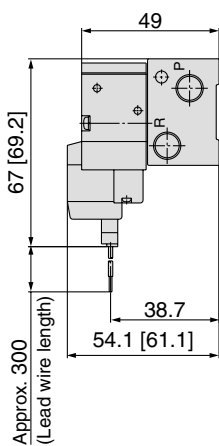

* Refer to page 4-4-61 for dimensions with connector cable.

Station n	Station 2	3	4	5	6	7	8	9	10	11	12	13	14	15	16	17	18	19	Station 20
L1	62	78	94	110	126	142	158	174	190	206	222	238	254	270	286	302	318	334	350
L2	53	69	85	101	117	133	149	165	181	197	213	229	245	261	277	293	309	325	341
L3	47	63	79	95	111	127	143	159	175	191	207	223	239	255	271	287	303	319	335

- V100
- SY
- SYJ**
- VK
- VZ
- VT
- VP
- VG
- VP
- S070
- VQ
- VKF
- VQZ
- VZ
- VS
- VFN

Series SYJ500

Type 40R Manifold: Bottom Ported (External Pilot Type)/SS3YJ5-40R-**Stations**-M5, 01□

* [] for AC

Grommet (G)

For 1/8

For M5

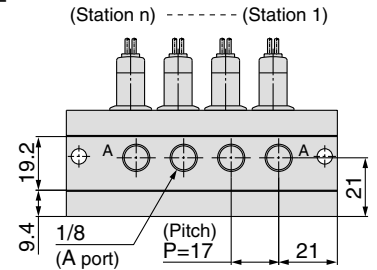
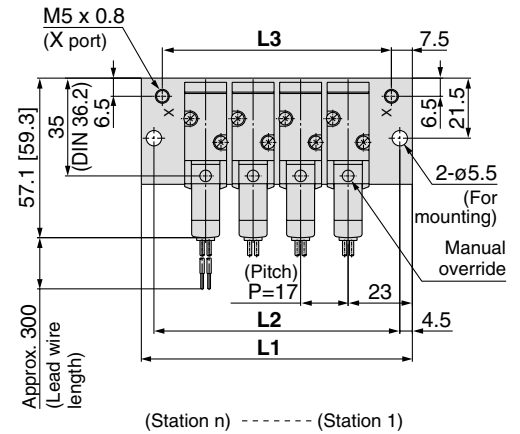
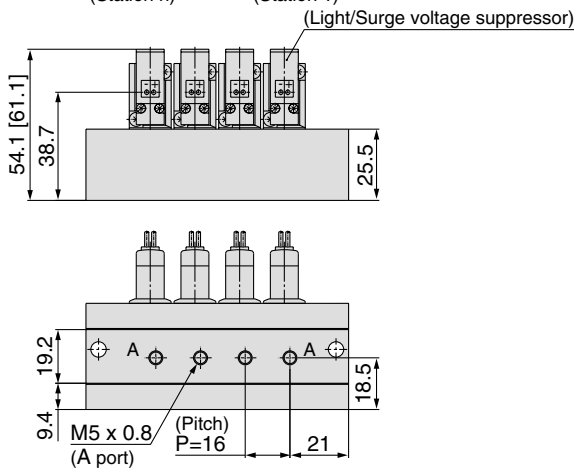
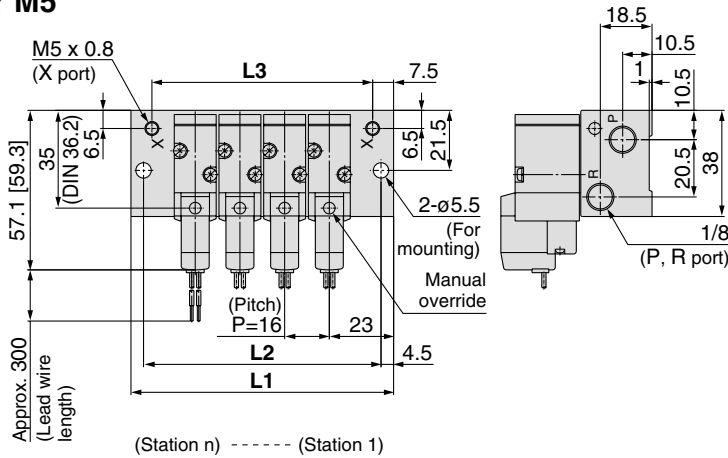

L plug connector (L)

M plug connector (M)

DIN terminal (D)

M8 connector (WO)

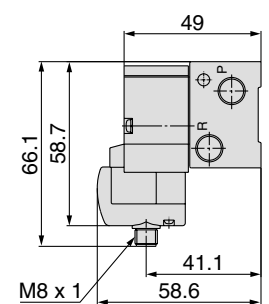
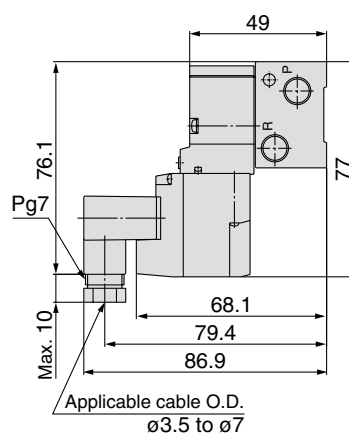
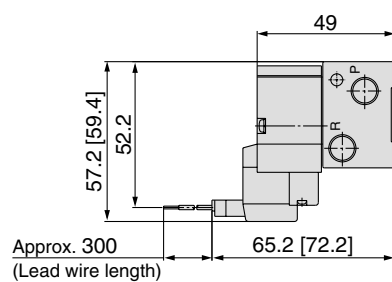
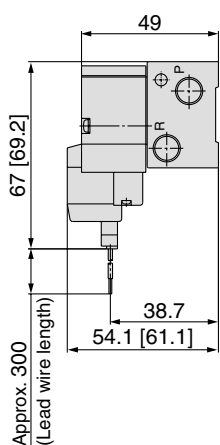

* Refer to page 4-4-61 for dimensions with connector cable.

Port size	Station n	Station 2	3	4	5	6	7	8	9	10	11	12	13	14	15	16	17	18	19	Station 20
M5	L1	62	78	94	110	126	142	158	174	190	206	222	238	254	270	286	302	318	334	350
	L2	53	69	85	101	117	133	149	165	181	197	213	229	245	261	277	293	309	325	341
	L3	47	63	79	95	111	127	143	159	175	191	207	223	239	255	271	287	303	319	335
1/8	L1	63	80	97	114	131	148	165	182	199	216	233	250	267	284	301	318	335	352	369
	L2	54	71	88	105	122	139	156	173	190	207	224	241	258	275	292	309	326	343	360
	L3	48	65	82	99	116	133	150	167	184	201	218	235	252	269	286	303	320	337	354

3 Port Pilot Operated Solenoid Valve Rubber Seal Series SYJ500

Type 41R Manifold: Side Ported (External Pilot Type)/SS3YJ5-41R- Stations C4, N3 C6, N7

* [] for AC

Grommet (G)

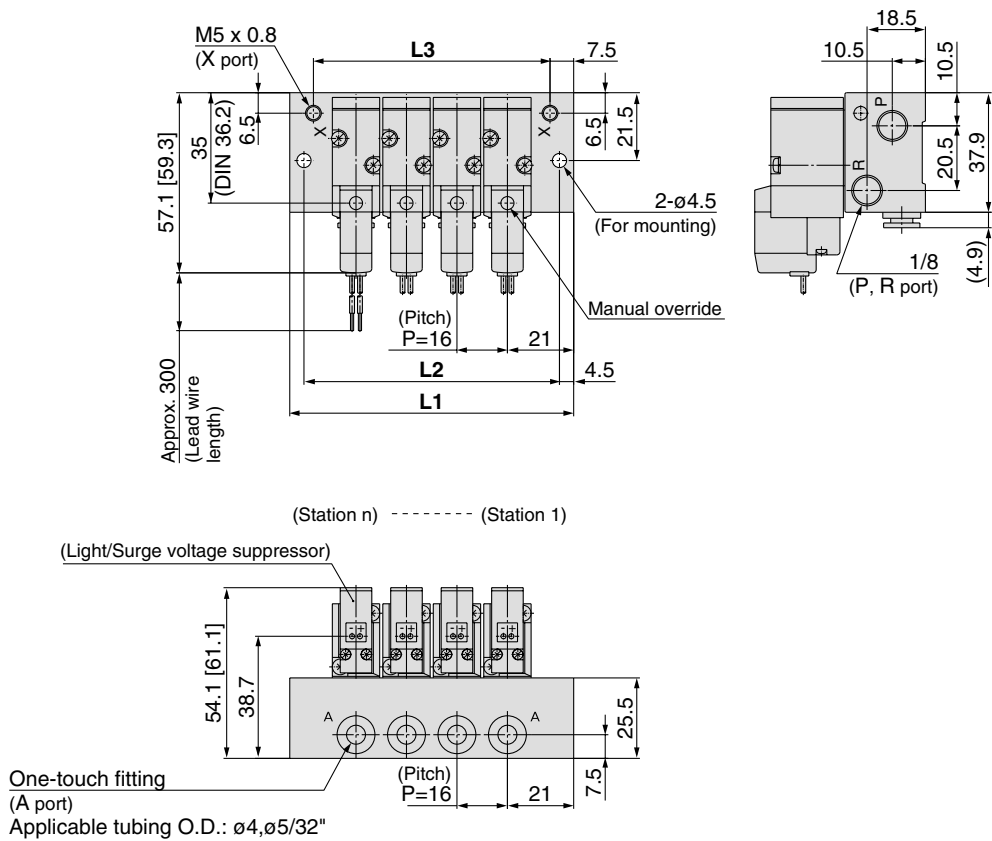

L plug connector (L)

M plug connector (M)

DIN terminal (D)

M8 connector (WO)

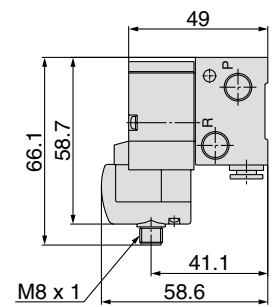
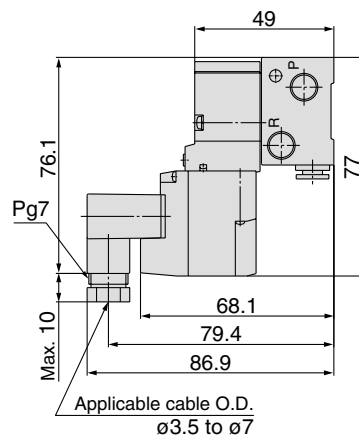
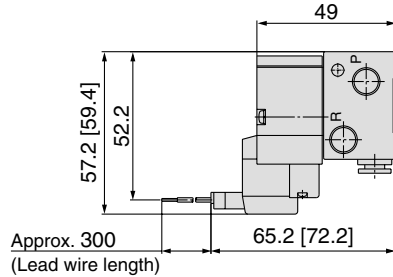
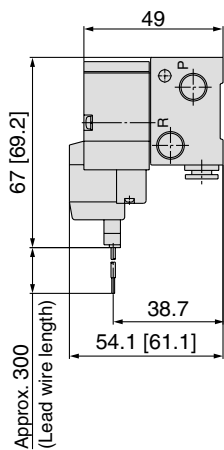

* Refer to page 4-4-61 for dimensions with connector cable.

Port size	Station n	Station 2	3	4	5	6	7	8	9	10	11	12	13	14	15	16	17	18	19	Station 20
One-touch fitting	L1	58	74	90	106	122	138	154	170	186	202	218	234	250	266	282	298	314	330	346
	L2	49	65	81	97	113	129	145	161	177	193	209	225	241	257	273	289	305	321	337
	L3	43	59	75	91	107	123	139	155	171	187	203	219	235	251	267	283	299	315	331

- V100
- SY
- SYJ**
- VK
- VZ
- VT
- VP
- VG
- VP
- S070
- VQ
- VKF
- VQZ
- VZ
- VS
- VFN

Series SYJ500

Type 41R Manifold: Side Ported (External Pilot Type)/SS3YJ5-41R- Stations -M5, 01□



For M5

For 1/8

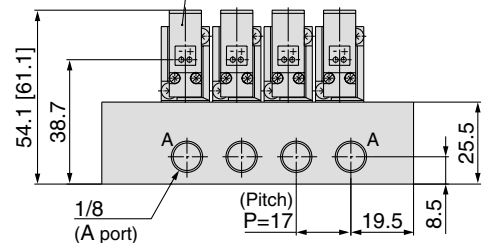
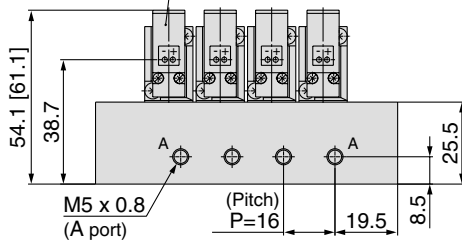
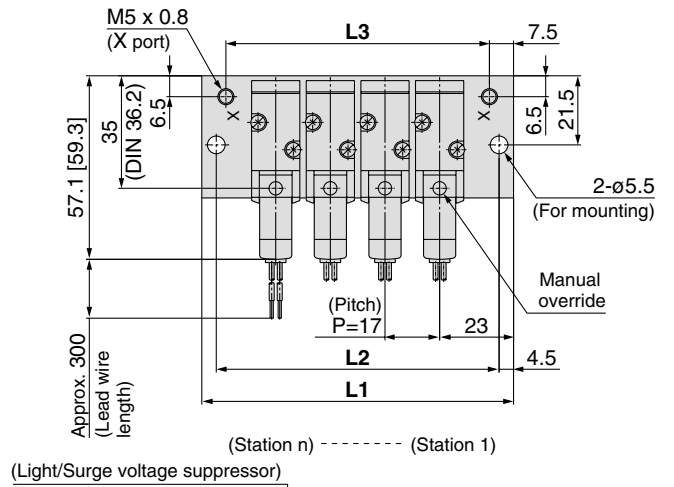
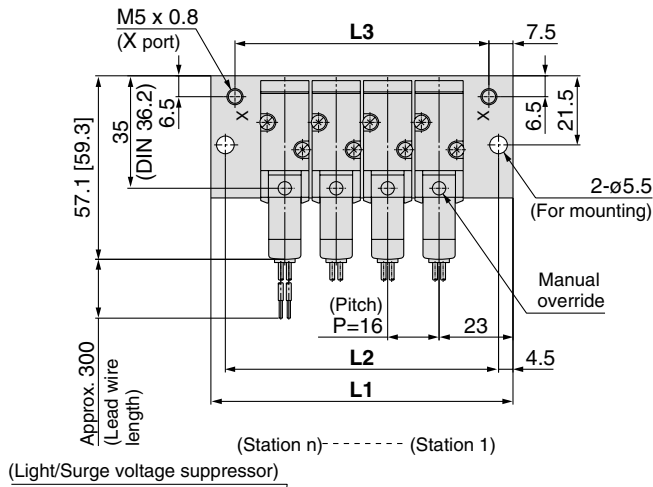

Port size	Station n	Station 2	3	4	5	6	7	8	9	10	11	12	13	14	15	16	17	18	19	Station 20
M5	L1	62	78	94	110	126	142	158	174	190	206	222	238	254	270	286	302	318	334	350
	L2	53	69	85	101	117	133	149	165	181	197	213	229	245	261	277	293	309	325	341
	L3	47	63	79	95	111	127	143	159	175	191	207	223	239	255	271	287	303	319	335
1/8	L1	63	80	97	114	131	148	165	182	199	216	233	250	267	284	301	318	335	352	369
	L2	54	71	88	105	122	139	156	173	190	207	224	241	258	275	292	309	326	343	360
	L3	48	65	82	99	116	133	150	167	184	201	218	235	252	269	286	303	320	337	354

Series SYJ700 Manifold Specifications

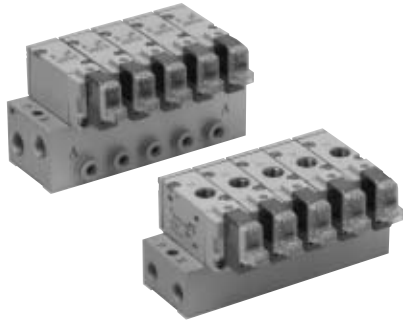

Manifold Specifications

Model	For internal pilot	Type 20	Type 21	Type 40	Type 41	Type 42
	For external pilot	—	Type 21R	—	Type 41R	Type 42R
Manifold type		Single base/B mount				
P (SUP), R (EXH)		Common SUP, common EXH				
Valve stations		2 to 20 stations				
A port Porting specifications	Location	Valve	Valve	Base	Base	Base
	Direction	Top	Top	Bottom	Bottom	Side
Port size	P, R port	1/8	1/4	1/8	1/4	1/4
	A port	1/8	1/8	1/8	1/8	1/8 C6 (ø6 one-touch fitting) C8 (ø8 one-touch fitting)
	X port ^{Note)}	—	M3 x 0.8	—	M5 x 0.8	M5 x 0.8

Note) Only for external pilot

Flow Characteristics

Manifold			Port size		Flow characteristics					
					1 → 2 (P → A)			2 → 3 (A → R)		
			1(P), 3(R) port	2(A) port	C [dm ³ /(s·bar)]	b	Cv	C [dm ³ /(s·bar)]	b	Cv
Body ported for internal pilot	Type SS3YJ7-20	SYJ7□2	1/8	1/8	2.2	0.34	0.55	2.3	0.27	0.59
	Type SS3YJ7-21		1/4	1/8	2.2	0.39	0.59	2.4	0.32	0.62
Base mounted for internal pilot	Type SS3YJ7-40	SYJ7□4	1/8	1/8	2.1	0.35	0.59	2.3	0.27	0.54
	Type SS3YJ7-41		1/4	1/8	2.2	0.35	0.59	2.4	0.36	0.66
	Type SS3YJ7-42-01		1/4	1/8	2.0	0.27	0.47	2.2	0.32	0.56
	Type SS3YJ7-42-C6		1/4	C6	1.6	0.32	0.39	2.2	0.27	0.54
	Type SS3YJ7-42-C8		1/4	C8	2.1	0.24	0.51	2.3	0.31	0.59
Body ported for external pilot	Type SS3YJ7-21R	SYJ7□2R	1/4	1/8	2.2	0.34	0.55	2.4	0.32	0.62
Base mounted for external pilot	Type SS3YJ7-41R	SYJ7□4R	1/4	1/8	2.2	0.35	0.59	2.4	0.36	0.66
	Type SS3YJ7-42R-01		1/4	1/8	2.0	0.27	0.47	2.2	0.32	0.56
	Type SS3YJ7-42R-C6		1/4	C6	1.6	0.32	0.39	2.2	0.27	0.54
	Type SS3YJ7-42R-C8		1/4	C8	2.1	0.24	0.51	2.3	0.31	0.59

Note) Value at manifold base mounted, 2 position single operating

How to Order Manifold (Example)

Instruct by specifying the valves and blanking plate assembly to be mounted on the manifold along with the manifold base model no.

Example:

- SS3YJ7-20-031 set (Manifold base)
- SS3YJ7-42R-03-011 set (Manifold base)
- * SYJ712-5LZ-012 sets (Valve)
- * SYJ714R-5G2 sets (Valve)
- * SYJ700-10-1A1 set (Blanking plate assembly)
- * SYJ700-10-2A1 set (Blanking plate assembly)

↳ The asterisk denotes the symbol for assembly. Prefix it to the part nos. of the solenoid valve, etc.

3 Port Pilot Operated Solenoid Valve Rubber Seal Series SYJ700

Combinations of Solenoid Valve, Manifold Gasket and Manifold Base

Body ported (Type SYJ7□2)

Base mounted (Type SYJ7□4)

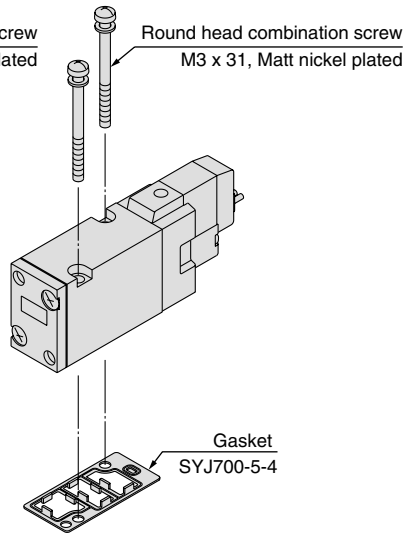
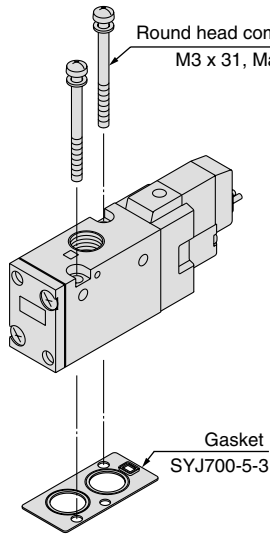

Applicable base
SS3YJ7-20
SS3YJ7-21
SS3YJ7-21R } Manifold base

Applicable base
Sub-plate
SS3YJ7-40
SS3YJ7-41
SS3YJ7-42
SS3YJ7-41R
SS3YJ7-42R } Manifold base

Blanking Plate Assembly

Part no.: SYJ700-10-2A

(In common for body ported type and base mounted type)

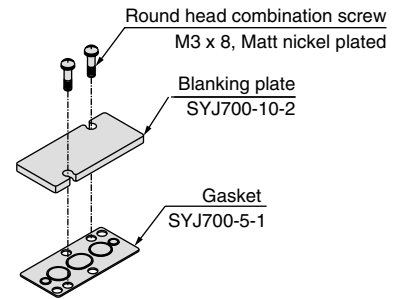

V100

SY

SYJ

VK

VZ

VT

VP

VG

VP

S070

VQ

VKF

VQZ

VZ

VS

VFN

⚠ Caution

Mounting screw tightening torques

M3: 0.8 N·m

Use caution to the assembly orientation for solenoid valves, gasket, and optional parts.

Series SYJ700

Manifold for Internal Pilot Type

Type 20/Type 21

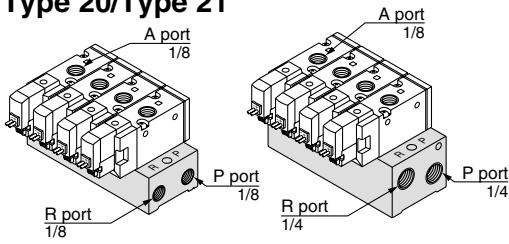

How to Order

SS3YJ7-20-05-□

Manifold type	
20	Type 20
21	Type 21

Stations	
02	2 stations
:	:
20	20 stations

P, R port thread type	
Nil	Rc
00F	G
00N	NPT
00T	NPTF

Applicable solenoid valve
 SYJ712-□□□□-01
 SYJ712M-□□□□-01
 SYJ722-□□□□-01
 SYJ722M-□□□□-01

Applicable blanking plate assembly
 SYJ700-10-2A

Note) If there are more than 6 stations for type 20, or more than 9 stations for 21 type, supply air to both sides of P port and exhaust air from both sides of R port.

Type 40/Type 41

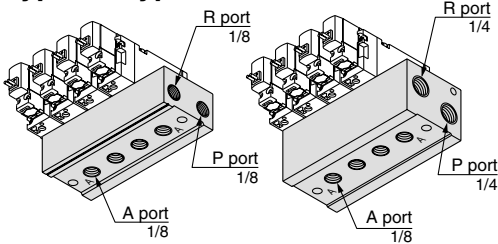

How to Order

SS3YJ7-40-05-01-□

Manifold type	
40	Type 40
41	Type 41

Stations	
02	2 stations
:	:
20	20 stations

A port size	
01	1/8

P, R port thread type	
Nil	Rc
F	G
N	NPT
T	NPTF

Applicable solenoid valve
 SYJ714-□□□□
 SYJ714M-□□□□
 SYJ724-□□□□
 SYJ724M-□□□□

Applicable blanking plate assembly
 SYJ700-10-2A

Note) If there are more than 6 stations for type 40, or more than 9 stations for 41 type, supply air to both sides of P port and exhaust air from both sides of R port.

Type 42

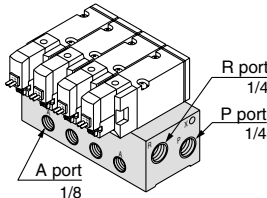

How to Order

SS3YJ7-42-05-C6-□

Stations	
02	2 stations
:	:
20	20 stations

A port size	
01	1/8
C6	ø6 One-touch fitting
C8	ø8 One-touch fitting
N7	ø1/4" One-touch fitting
N9	ø5/16" One-touch fitting

P, R port thread type	
Nil	Rc
F	G
N	NPT
T	NPTF

Applicable solenoid valve
 SYJ714-□□□□
 SYJ714M-□□□□
 SYJ724-□□□□
 SYJ724M-□□□□

Applicable blanking plate assembly
 SYJ700-10-2A

Note) For more than 9 stations, supply air to both sides of P port and exhaust air from both sides of R port.

Manifold for External Pilot Type

Pilot valve pressure is supplied separately from the main valve pressure through the use of a separate supply port. It can be used in the vacuum (up to -100 kPa) or low pressure line with 0.15 MPa or less.

Type 21R

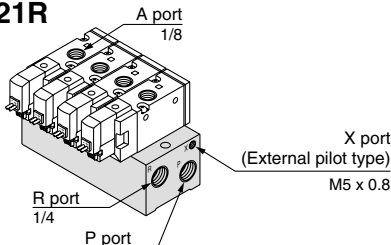

How to Order

SS3YJ7-21R-05-□

Stations	
02	2 stations
:	:
20	20 stations

P, R port thread type	
Nil	Rc
00F	G
00N	NPT
00T	NPTF

Applicable solenoid valve
 SYJ712R-□□□□-01
 SYJ722R-□□□□-01

Applicable blanking plate assembly
 SYJ700-10-2A

Note) For more than 9 stations, supply/exhaust air to/from both sides of P and R port.

Type 41R

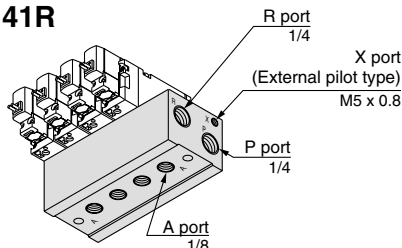

How to Order

SS3YJ7-41R-05-01-□

Stations	
02	2 stations
:	:
20	20 stations

A port size	
01	1/8

P, R port thread type	
Nil	Rc
F	G
N	NPT
T	NPTF

Applicable solenoid valve
 SYJ714R-□□□□
 SYJ724R-□□□□

Applicable blanking plate assembly
 SYJ700-10-2A

Note) For more than 9 stations, supply/exhaust air to/from both sides of P and R port.

Type 42R

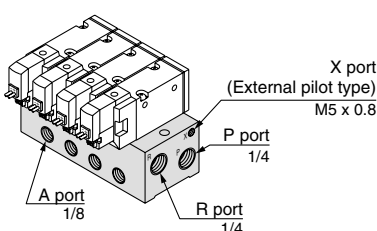

How to Order

SS3YJ7-42R-05-01-□

Stations	
02	2 stations
:	:
20	20 stations

A port size	
01	1/8
C6	ø6 One-touch fitting
C8	ø8 One-touch fitting
N7	ø1/4" One-touch fitting
N9	ø5/16" One-touch fitting

P, R port thread type	
Nil	Rc
F	G
N	NPT
T	NPTF

Applicable solenoid valve
 SYJ714R-□□□□
 SYJ724R-□□□□

Applicable blanking plate assembly
 SYJ700-10-2A

Note) For more than 9 stations, supply/exhaust air to/from both sides of P and R port.

Series SYJ700

Type 21R Manifold: Top Ported (External Pilot Type)/SS3YJ7-21R- Stations (-00□)



Grommet (G)

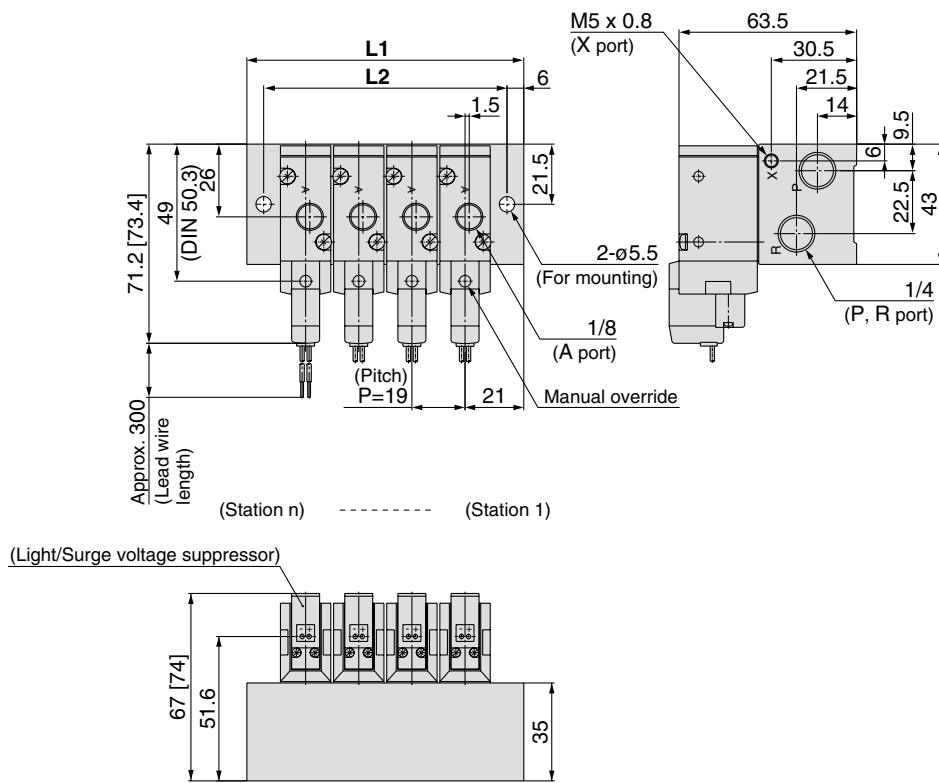

L plug connector (L)

M plug connector (M)

DIN terminal (D)

M8 connector (WO)

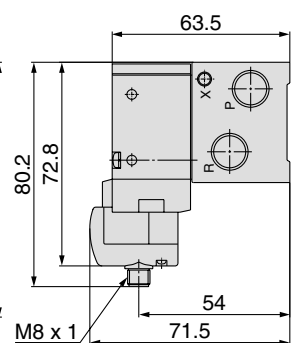
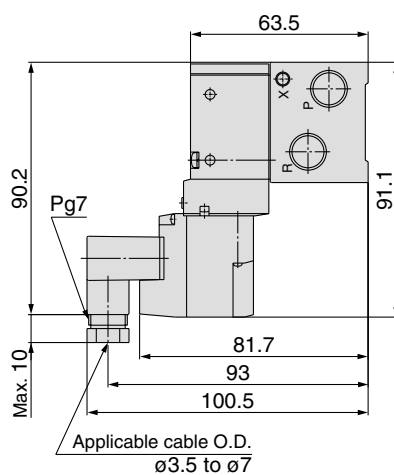
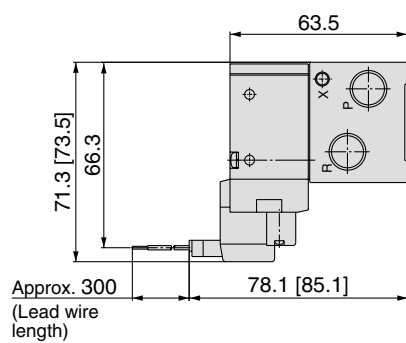
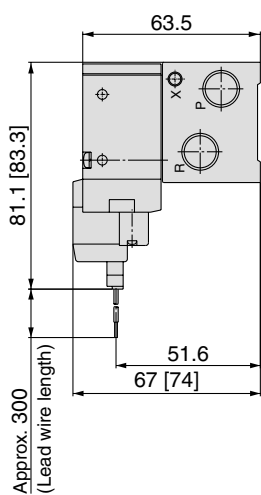

* Refer to page 4-4-61 for dimensions with connector cable.

Station n	Station 2	3	4	5	6	7	8	9	10	11	12	13	14	15	16	17	18	19	Station 20
L1	61	80	99	118	137	156	175	194	213	232	251	270	289	308	327	346	365	384	403
L2	49	68	87	106	125	144	163	182	201	220	239	258	277	296	315	334	353	372	391

3 Port Pilot Operated Solenoid Valve Rubber Seal Series SYJ700

Type 42R Manifold: Side Ported/SS3YJ7-42R- **Stations** -01, C6, N7, C8, N9

* [] for AC

Grommet (G)

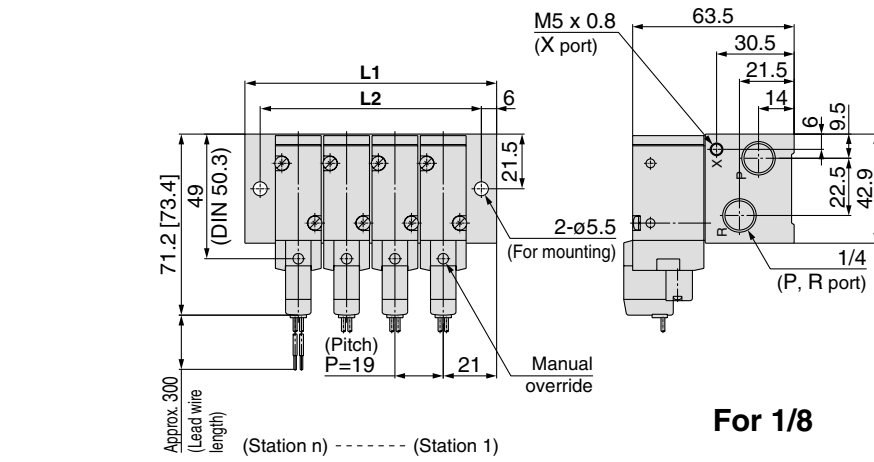

For 1/8

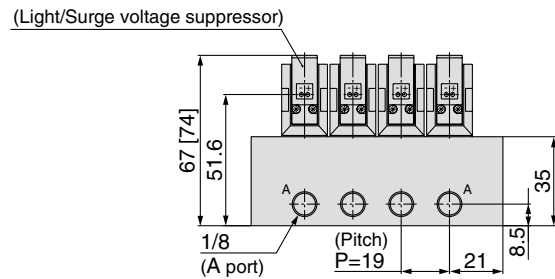
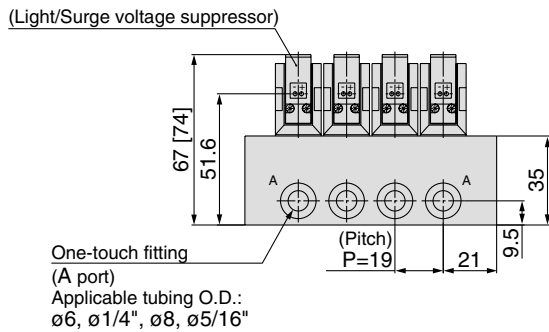

L plug connector (L)

M plug connector (M)

DIN terminal (D)

M8 connector (WO)

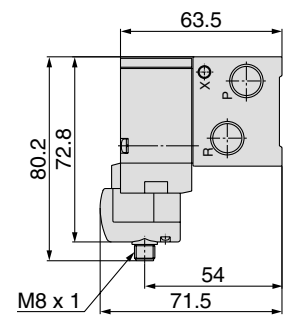
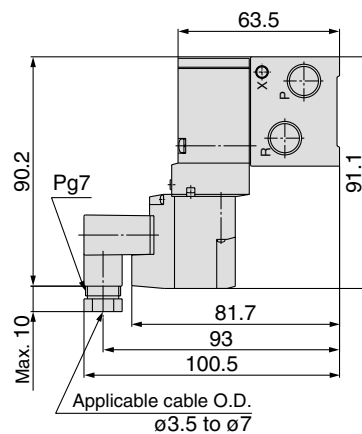
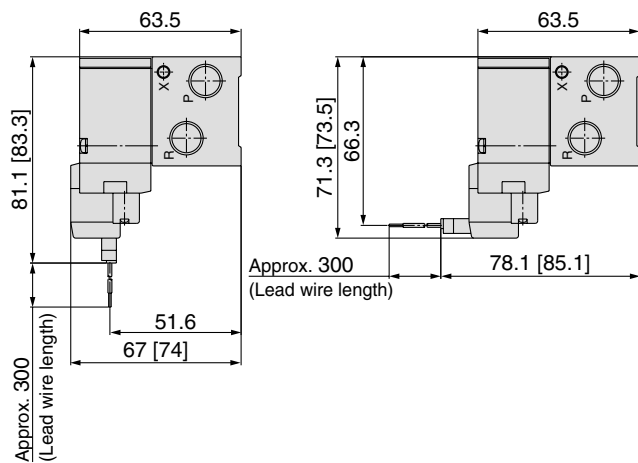

* Refer to page 4-4-61 for dimensions with connector cable.

Station n	Station 2	3	4	5	6	7	8	9	10	11	12	13	14	15	16	17	18	19	Station 20
L1	61	80	99	118	137	156	175	194	213	232	251	270	289	308	327	346	365	384	403
L2	49	68	87	106	125	144	163	182	201	220	239	258	277	296	315	334	353	372	391

- V100
- SY
- SYJ**
- VK
- VZ
- VT
- VP
- VG
- VP
- S070
- VQ
- VKF
- VQZ
- VZ
- VS
- VFN

Series SYJ700

Type 41R Manifold: Bottom Ported (External Pilot Type)/SS3YJ7-41R- Stations -01□



Grommet (G)

(Light/Surge voltage suppressor)

