

## VQZ200/300 / How to Order Valve



Made to Order

(For details, refer to page 19 and 34.)

VQZ **2** **1** **5** - **5** **M** **1** - -

Series

2	VQZ200 body width 15 mm
3	VQZ300 body width 18 mm

Type of actuation

1	N.C. (A)	Metal seal
	2 3 1 (R) (P)	
2	N.O. (A)	Metal seal
	2 3 1 (R) (P)	
3	N.C. (A)	Rubber seal
	2 3 1 (R) (P)	
4	N.O. (A)	Rubber seal
	2 3 1 (R) (P)	

Body type

5	Body mounted
---	--------------

Function

Symbol	Specifications	DC (0.35 W)	AC (Note 3)
Nil	Standard	○	○
B Note 1)	High speed response type	(0.9 W) ○	—
K Note 1)	High pressure type (Metal seal type only)	(0.9 W) ○	—
R Note 1, 2)	External pilot type	○	○
BR Note 1, 2)	High speed response/External pilot type	(0.9 W) ○	—
KR Note 1, 2)	High pressure/External pilot type (Metal seal type only)	(0.9 W) ○	—

Note 1) Option  
 Note 2) For details on external pilot type, refer to page 32.  
 Note 3) For AC specification power consumption, refer to page 19.

**Caution**

Use standard (DC) specification for continuous duty.

IP65 compliant

Nil	—
W Note)	Compliant

Note) VQZ200/300 DIN terminal rubber seal only (except external pilot). For details on IP65 enclosure, refer to page 32.

CE compliant

Nil	—
Q	CE marked

Note) AC-type models that are CE compliant have DIN terminals only.

Port size [2(A) port]

Symbol	Port size	VQZ200	VQZ300
Nil	Without sub-plate	○	○
01	Rc 1/8	○	—
02	Rc 1/4	○	○
03	Rc 3/8	—	○

Note) For optional thread type, refer to page 32.

Manual override

Nil: Non-locking push type (Tool required)  
 B: Locking type (Tool required)

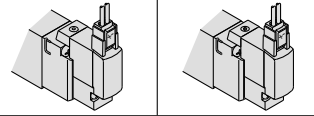

Electrical entry

G: Grommet (DC specification)	L: L-type plug connector with lead wire	LO: L-type plug connector without connector	M: M-type plug connector with lead wire	MO: M-type plug connector without connector
	With light/surge voltage suppressor	With light/surge voltage suppressor	With light/surge voltage suppressor	With light/surge voltage suppressor
Y: DIN terminal	YO: DIN terminal without connector	YZ: DIN terminal	YOS: DIN terminal without connector (DC specification)	YS: DIN terminal (DC specification)
	With light/surge voltage suppressor	With light/surge voltage suppressor	With surge voltage suppressor	With surge voltage suppressor

Note 1) Standard lead wire length: 300 mm  
 Note 2) For AC voltage valves there is no "S" option. It is already built-in to the rectifier circuit.

Coil voltage

1	100 VAC (50/60 Hz)
2	200 VAC (50/60 Hz)
3	110 VAC [115 VAC] (50/60 Hz)
4	220 VAC [230 VAC] (50/60 Hz)
5	24 VDC
6	12 VDC

Note) For sub-plate part no., refer to page 33.

# Series VQZ100/200/300



## Specifications

Valve construction	Metal seal	Rubber seal	VQZ100 (Poppet seal)
Fluid	Air, Inert gas		
Max. operating pressure (MPa)	0.7 (High pressure type: 1.0)	0.7	0.7 (High pressure type: 1.0)
Min. operating pressure (MPa)	0.1	0.15	0.15
Ambient and fluid temperature (°C)	-10 to 50 (No freezing)		
Max. operating frequency (Hz)	20	5	20
Pilot exhaust method	Individual exhaust		Common exhaust
Lubrication	Not required		
Manual override	Push type, Locking type (Tool required)		
Mounting orientation	Free		
Impact/Vibration resistance (m/s <sup>2</sup> ) <sup>Note 1)</sup>	150/30		
Enclosure	Dustproof (DIN terminal: IP65 <sup>Note 2)</sup> )		



\* Based on IEC60529

Note 1) Impact resistance: No malfunction occurred when it is tested with a drop tester in the axial direction and at the right angles to the main valve and armature in both energized and de-energized states every once for each condition. (Value in the initial state)

Vibration resistance: No malfunction occurred in one sweep test between 45 and 2000 Hz. Test was performed to axis and right angle directions of the main valve and armature when pilot signal is ON and OFF. (Value in the initial state)

Note 2) When IP65 compliant DIN terminals are selected: VQZ<sub>3</sub>□5□-□Y□□W1-□-□

## Solenoid Specifications

## Options

High speed response type
High pressure type (Metal seal type only)
External pilot type*

\* For details on external pilot type, refer to page 32.



**Made to Order**  
(For details, refer to page 34.)

Symbol	Description
X30	Pilot valve common exhaust
X90	Main valve fluoro-rubber
X113	All fluoro-rubber

Electrical entry	Grommet (G)		M-type plug connector (M)	
	L-type plug connector (L)		DIN terminal (Y)	
		G, L, M		Y
Coil rated voltage (V)	DC	24, 12		
	AC 50/60 Hz	100, 110, 200, 220*		
Allowable voltage fluctuation		±10% of rated voltage*		
Power consumption (W)	DC	Standard	0.35 [(With light: 0.4 (DIN terminal with light: 0.45))]	
		High speed response, high pressure	0.9 [(With light: 0.95 (DIN terminal with light: 1.0))]	
Apparent power (VA)	AC	100 V	0.78 (With light: 0.81)	0.78 (With light: 0.87)
		110 V [115 V]	0.86 (With light: 0.89) [0.94 (With light: 0.97)]	0.86 (With light: 0.87) [0.94 (With light: 1.07)]
		200 V	1.18 (With light: 1.22)	1.15 (With light: 1.30)
		220 V [230 V]	1.30 (With light: 1.34) [1.42 (With light: 1.46)]	1.27 (With light: 1.46) [1.39 (With light: 1.60)]
Surge voltage suppressor		Varistor		
Indicator light		LED (Neon light when AC with DIN terminal)		



\* In common between 110 VAC and 115 VAC, and between 220 VAC and 230 VAC.

\* For 115 VAC and 230 VAC, the allowable voltage is -15% to +5% of rated voltage.

## Flow Characteristics

Series	Valve construction	Model	Flow characteristics						Response time (ms) <sup>Note 1)</sup>				Weight (g) <sup>Note 2)</sup>	
			1→2 (P→A)			2→3 (A→R)			Standard: 0.35 W	High speed response: 0.9 W	High pressure: 0.9 W	AC		
			C [dm <sup>3</sup> /(s·bar)]	b	Cv	C [dm <sup>3</sup> /(s·bar)]	b	Cv						
VQZ100	N.C. valve	Poppet	VQZ115	0.87	0.46	0.23	1.0	0.35	0.25	10 or less	—	13 or less	22 or less	24
VQZ200	N.C. valve	Metal seal	VQZ215	1.7	0.17	0.38	2.0	0.20	0.45	22 or less	14 or less	18 or less	34 or less	52
		Rubber seal	VQZ235	2.3	0.46	0.65	3.0	0.40	0.80	22 or less	15 or less	—	36 or less	
	N.O. valve	Metal seal	VQZ225	1.7	0.18	0.38	1.8	0.21	0.39	22 or less	14 or less	18 or less	34 or less	
		Rubber seal	VQZ245	2.5	0.43	0.67	3.0	0.30	0.74	22 or less	15 or less	—	36 or less	
VQZ300	N.C. valve	Metal seal	VQZ315	3.0	0.21	0.70	3.2	0.27	0.80	22 or less	17 or less	22 or less	34 or less	78
		Rubber seal	VQZ335	4.5	0.42	1.3	4.1	0.36	1.0	33 or less	25 or less	—	57 or less	
	N.O. valve	Metal seal	VQZ325	2.9	0.21	0.72	2.9	0.16	0.69	22 or less	17 or less	22 or less	34 or less	
		Rubber seal	VQZ345	4.4	0.45	1.2	4.5	0.38	1.2	33 or less	25 or less	—	57 or less	



Note 1) Based on JIS B 8375-1981 (Supply pressure: 0.5 MPa; with light/surge voltage suppressor: clean air)  
Response time values will change depending on pressure and air quality.

Note 2) Weight without sub-plate.

## Dimensions: VQZ200

### Single Unit

Grommet (G): VQZ2□5□-□G□1-<sup>01</sup>/<sub>02</sub>

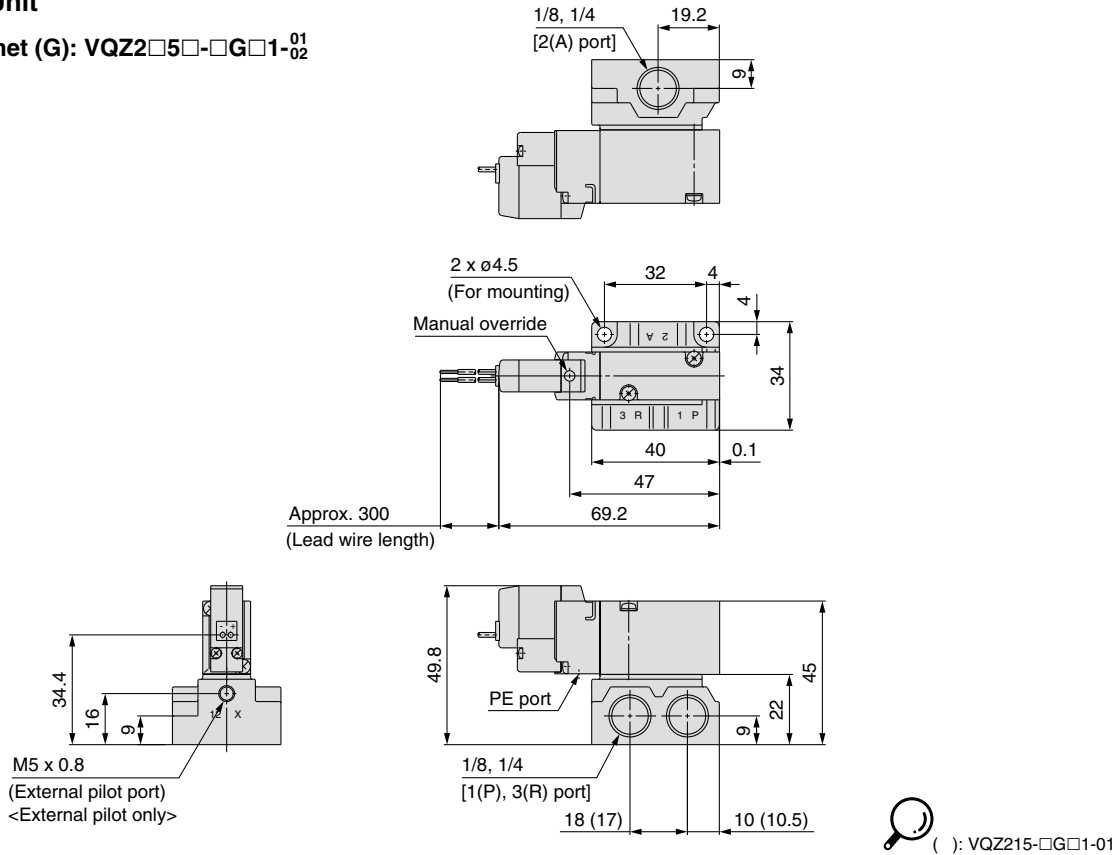

L-type plug connector (L): VQZ2□5□-□L□1-<sup>01</sup>/<sub>02</sub>

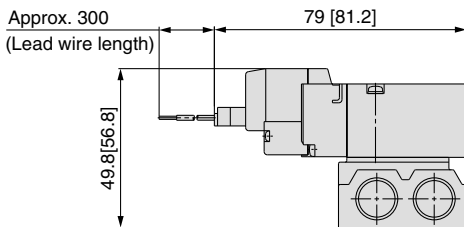

Unless otherwise indicated, dimensions are the same as Grommet (G).  
[ ]: AC

DIN terminal (Y): VQZ2□5□-□Y□1-<sup>01</sup>/<sub>02</sub>

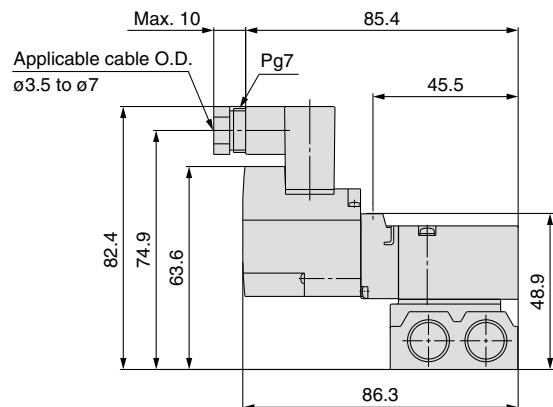

Unless otherwise indicated, dimensions are the same as Grommet (G).  
[ ]: AC

M-type plug connector (M): VQZ2□5□-□M□1-<sup>01</sup>/<sub>02</sub>

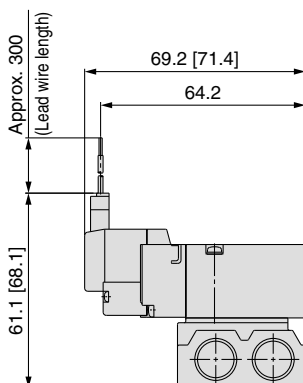

Unless otherwise indicated, dimensions are the same as Grommet (G).  
[ ]: AC

# Series VQZ100/200/300

## Dimensions: VQZ300

### Single Unit

Grommet (G): VQZ3□5□-□G□1-0<sup>2</sup>/<sub>3</sub>

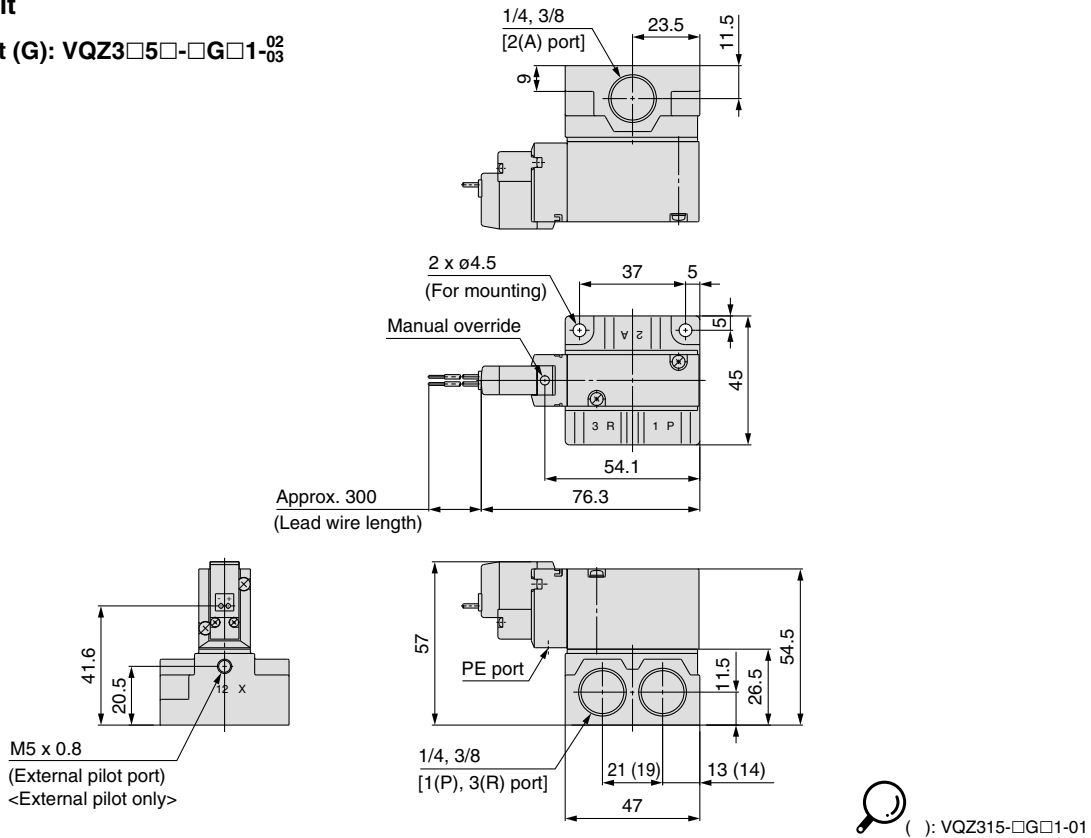

L-type plug connector (L): VQZ3□5□-□L□1-0<sup>2</sup>/<sub>3</sub>

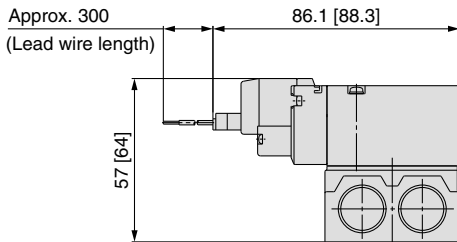

Unless otherwise indicated, dimensions are the same as Grommet (G).  
[ ] : AC

DIN terminal (Y): VQZ3□5□-□Y□□1-0<sup>2</sup>/<sub>3</sub>

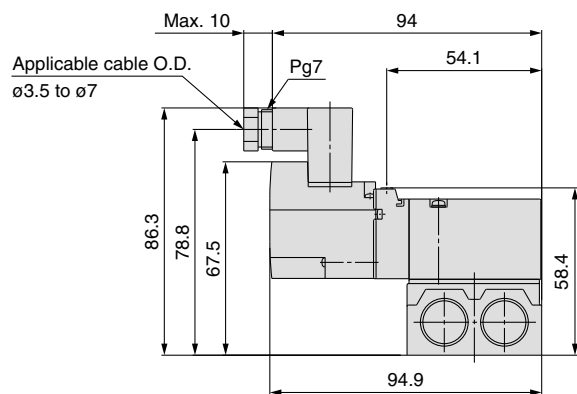

M-type plug connector (M): VQZ3□5□-□M□1-0<sup>2</sup>/<sub>3</sub>

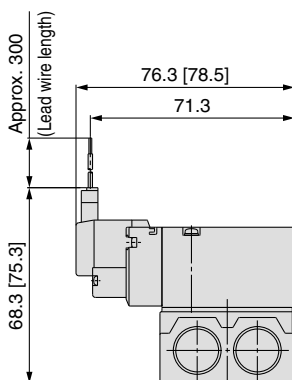

Unless otherwise indicated, dimensions are the same as Grommet (G).  
[ ] : AC

Unless otherwise indicated, dimensions are the same as Grommet (G).

## VQZ200/300 / How to Order Manifold



Made to Order  
(For details, refer to page 34.)

**VV3QZ** **2** **5** - **08** **C6** **C** - **□** - **□**

**Series**

2	VQZ200
3	VQZ300

**Manifold type**

5	Base mounted
---	--------------

**Stations**

02	2 stations
⋮	⋮
20	20 stations

**Port size [2(A) port]**

Symbol	Port size	VQZ200	VQZ300
C4	ø4 one-touch fitting	○	—
C6	ø6 one-touch fitting	○	○
C8	ø8 one-touch fitting	○	○
C10	ø10 one-touch fitting	—	○
01	Rc 1/8	○	—
02	Rc 1/4	—	○
CM <sup>Note 1)</sup>	Mixed port sizes	○	○

**CE compliant**

Nil	—
Q	CE marked

**Option**

Nil	None
D	DIN rail mounting (With standard DIN rail length)
D0 <sup>Note)</sup>	DIN rail mounting (Without DIN rail)
R	External pilot type

**Kit type**

C	Connector
---	-----------

**Note 1)** Specify port mixture/with port plug by means of the manifold specification sheet. Port mixture and port plug are available only for one-touch fitting type.  
**Note 2)** For inch size one-touch fittings, refer to page 32.

## VQZ200/300 / How to Order Valve

**VQZ** **2** **1** **5** **□** - **5** **M** **□** **□** **1** - **□**

**Series**

2	VQZ200 body width 15 mm
3	VQZ300 body width 18 mm

**Type of actuation**

1	N.C. Metal seal
2	N.O. Metal seal
3	N.C. Rubber seal
4	N.O. Rubber seal

**Body type**

5	Base mouned
---	-------------

**Function**

Symbol	Specifications	DC	AC
Nil	Standard	(0.35 W) ○ <sup>Note 3)</sup>	○
B <sup>Note 1)</sup>	High speed response type	(0.9 W) ○	—
K <sup>Note 1)</sup>	High pressure type (Metal seal type only)	(0.9 W) ○	—
R <sup>Note 1, 2)</sup>	External pilot type	○	○
BR <sup>Note 1, 2)</sup>	High speed response/External pilot type	(0.9 W) ○	—
KR <sup>Note 1, 2)</sup>	High pressure/External pilot type (Metal seal type only)	(0.9 W) ○	—

**CE compliant**

Nil	—
Q	CE marked

**IP65 compliant**

Nil	—
W <sup>Note)</sup>	Compliant

**Manual override**

Nil	Non-locking push type (Tool required)
B	Locking type (Tool required)

**Electrical entry**

Symbol	Electrical entry	Light/surge voltage suppressor
G	Grommet (DC specification)	None
L	L-type plug connector with lead wire	Yes
LO	L-type plug connector without connector	
M	M-type plug connector with lead wire	
MO	M-type plug connector without connector	None
Y	DIN terminal	
YO	DIN terminal without connector	
YZ	DIN terminal	Yes
YS <sup>Note 2)</sup>	DIN terminal (DC specification)	Yes
YOS <sup>Note 2)</sup>	DIN terminal without connector (DC specification)	(Without light)

**Coil voltage**

1	100 VAC (50/60 Hz)
2	200 VAC (50/60 Hz)
3	110 VAC [115 VAC] (50/60 Hz)
4	220 VAC [230 VAC] (50/60 Hz)
5	24 VDC
6	12 VDC

**Note 1)** Option  
**Note 2)** For details on external pilot type, refer to page 32.  
**Note 3)** For AC specification power consumption, refer to page 19.



**Caution**  
Use standard (DC) specification for continuous duty.

## Manifold Specifications

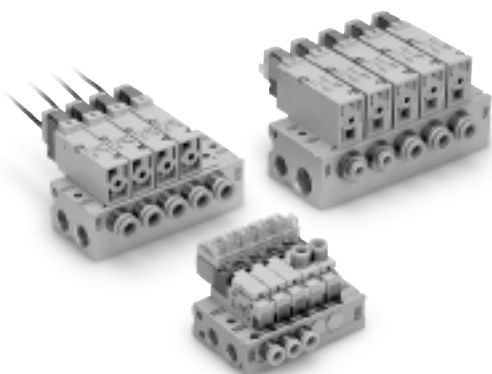

Series	Base model	Piping specifications			Applicable solenoid valve	Applicable stations	Manifold base weight (g) <sup>(Note)</sup>
		Piping direction	Port size				
			1(P), 3(R)	2(A)			
VQZ100	VV3QZ15-□□□	Side/Top	Rc 1/8	C3 (for ø3.2) C4 (for ø4) C6 (for ø6) M5 (M5 thread)	VQZ115	2 to 20 stations	2 stations: 83 Addition per station: 19
VQZ200	VV3QZ25-□□□	Side	Rc 1/4	C4 (for ø4) C6 (for ø6) C8 (for ø8) Rc 1/8	VQZ2□5	2 to 20 stations	2 stations: 126 Addition per station: 38
VQZ300	VV3QZ35-□□□	Side	1(P) port Rc 3/8 3(R) port Rc 1/4	C6 (for ø6) C8 (for ø8) C10 (for ø10) Rc 1/4	VQZ3□5	2 to 20 stations	2 stations: 209 Addition per station: 60

 Note) Weight for threaded connection.

## How to Order Manifold Assembly (Example)

**VV3QZ25-05C6C** .... 1 set (C kit 5-station manifold base part no.)

- \* **VVQZ200-10A-5** ... 1 set (Blanking plate assembly part no.)
- \* **VQZ215-5L1** ..... 4 sets (N.C. type part no.)

→ The asterisk denotes the symbol for assembly. Prefix it to the part nos. of the solenoid valve, etc.

→ Enter in order starting from the first station on the D side.

Add the valve and option part number under the manifold base part number.  
When entry of part numbers becomes complicated, indicate by the manifold specification sheet.

# Series VQZ100/200/300

## Dimensions: VQZ200

VV3QZ25- Stations Port size C

### Grommet (G)

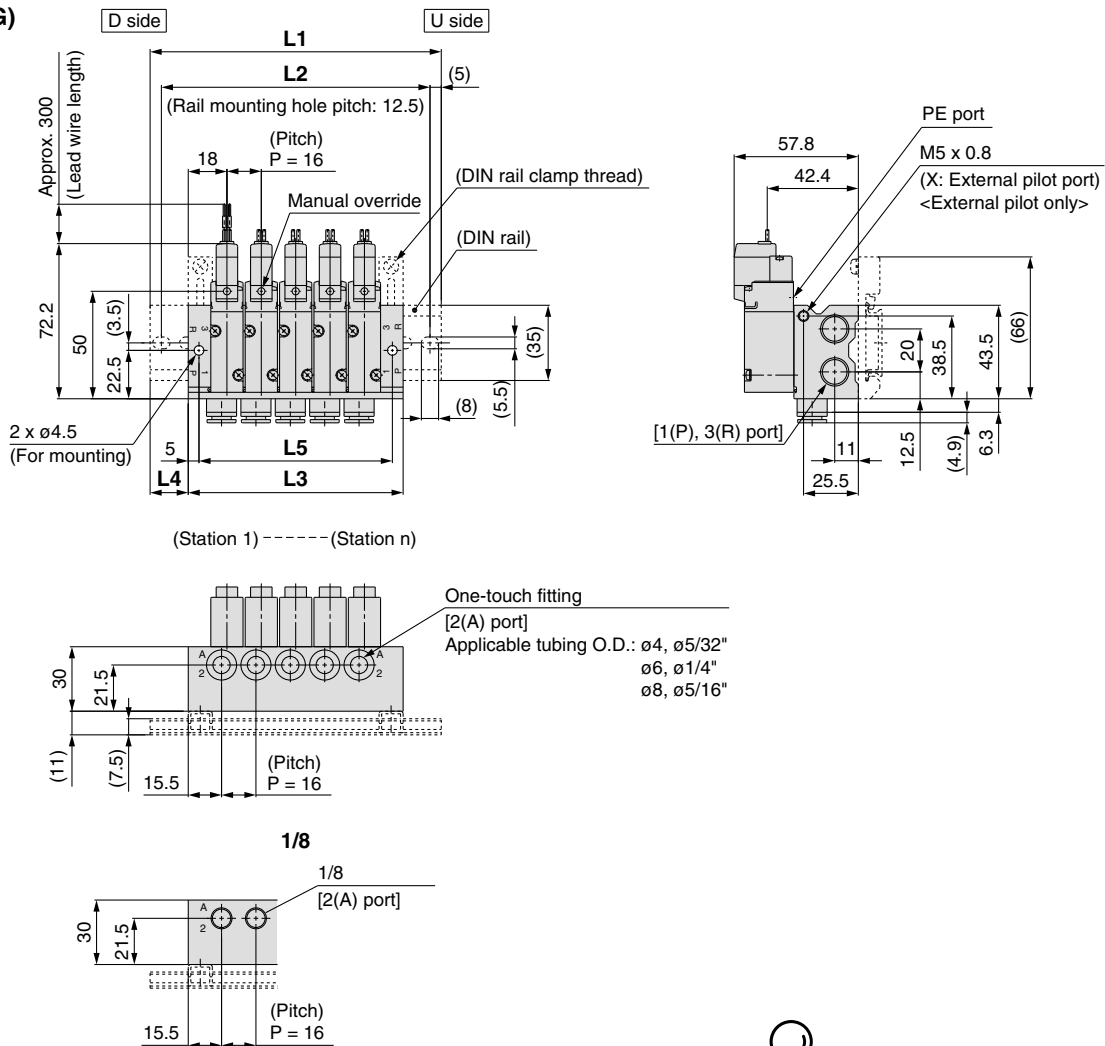

The dashed lines indicate the DIN rail mounting [-D].

### L-type plug connector (L)

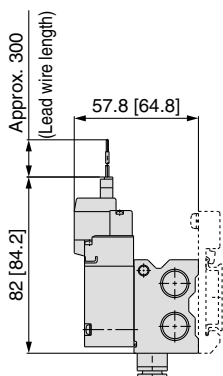

Unless otherwise indicated, dimensions are the same as Grommet (G).  
[ ]: AC

### M-type plug connector (M)

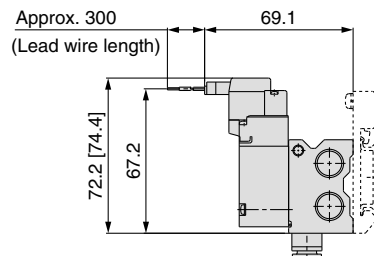

Unless otherwise indicated, dimensions are the same as Grommet (G).  
[ ]: AC

### DIN terminal (Y)

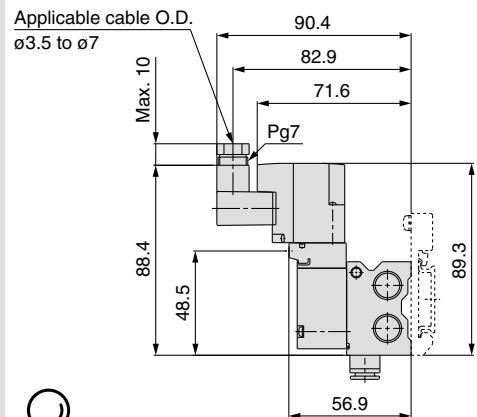

Unless otherwise indicated, dimensions are the same as Grommet (G).

### Dimensions

Formula: L5 = 16n + 10 L3 = 16n + 20 n: Stations (Max. 20 stations)

L \ n	2	3	4	5	6	7	8	9	10	11	12	13	14	15	16	17	18	19	20
<b>L1</b>	85.5	98	123	135.5	148	173	185.5	198	210.5	235.5	248	260.5	285.5	298	310.5	323	348	360.5	373
<b>L2</b>	75	87.5	112.5	125	137.5	162.5	175	187.5	200	225	237.5	250	275	287.5	300	312.5	337.5	350	362.5
<b>L3</b>	52	68	84	100	116	132	148	164	180	196	212	228	244	260	276	292	308	324	340
<b>L4</b>	17	15	19.5	18	16	20.5	19	17	15.5	20	18	16.5	21	19	17.5	15.5	20	18.5	16.5
<b>L5</b>	42	58	74	90	106	122	138	154	170	186	202	218	234	250	266	282	298	314	330

## Dimensions: VQZ300

VV3QZ35- Stations Port size C

### Grommet (G)

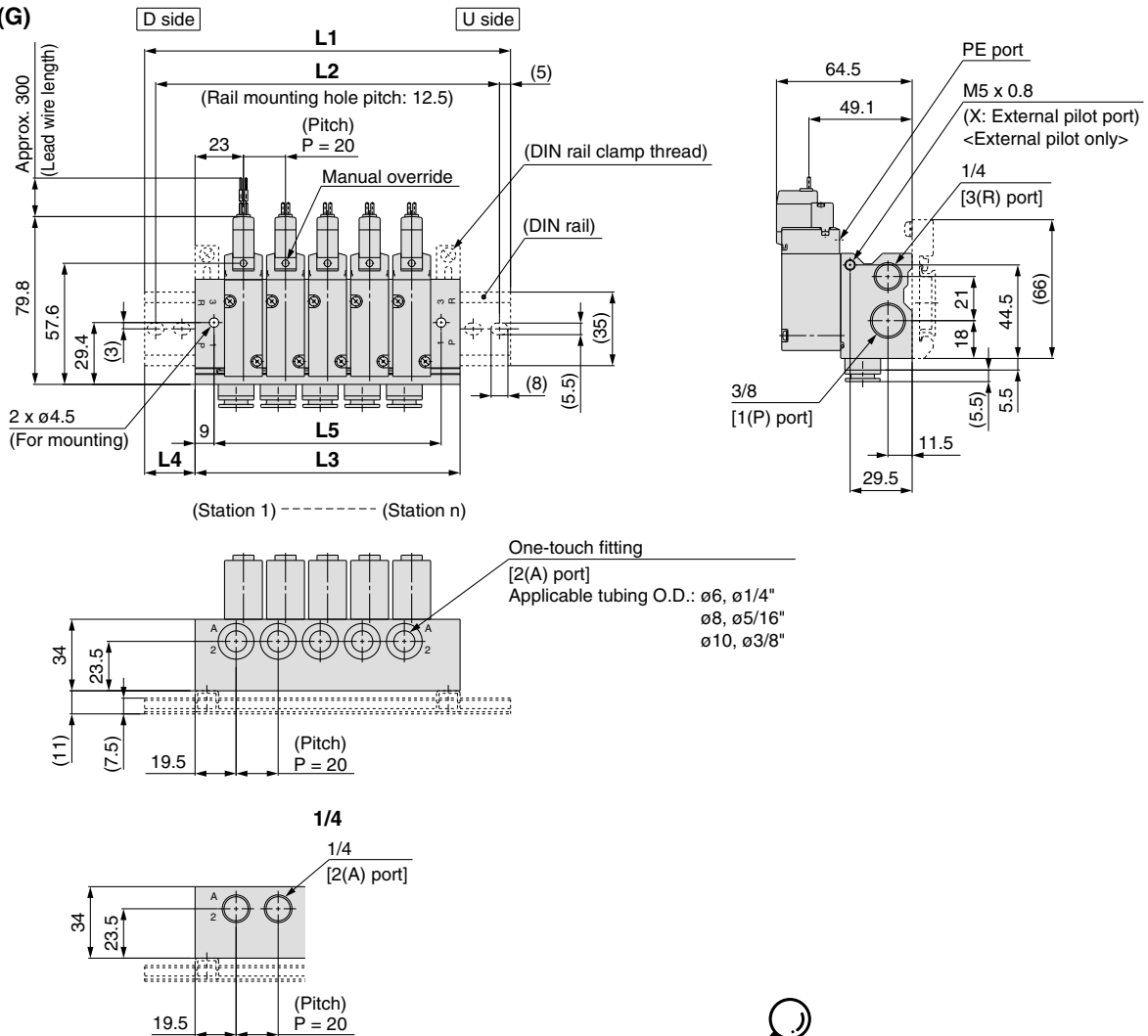

The dashed lines indicate the DIN rail mounting [-D].

### L-type plug connector (L)

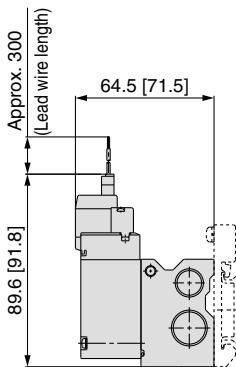

Unless otherwise indicated, dimensions are the same as Grommet (G).  
[ ]: AC

### M-type plug connector (M)

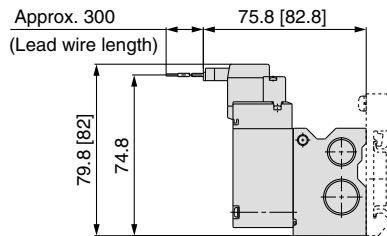

Unless otherwise indicated, dimensions are the same as Grommet (G).  
[ ]: AC

### DIN terminal (Y)

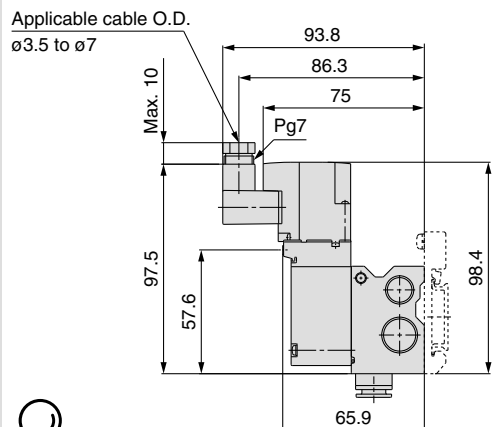

Unless otherwise indicated, dimensions are the same as Grommet (G).

### Dimensions

Formula: L5 = 20n + 8 L3 = 20n + 26 n: Stations (Max. 20 stations)

L \ n	2	3	4	5	6	7	8	9	10	11	12	13	14	15	16	17	18	19	20
L1	98	123	148	160.5	185.5	198	223	248	260.5	285.5	298	323	348	360.5	385.5	398	423	448	460.5
L2	87.5	112.5	137.5	150	175	187.5	212.5	237.5	250	275	287.5	312.5	337.5	350	375	387.5	412.5	437.5	450
L3	66	86	106	126	146	166	186	206	226	246	266	286	306	326	346	366	386	406	426
L4	16	18.5	21	17.5	20	16	18.5	21	17.5	20	16	18.5	21	17.5	20	16	18.5	21	17.5
L5	48	68	88	108	128	148	168	188	208	228	248	268	288	308	328	348	368	388	408



# Series VQZ100/200/300

## Manifold Options

### Blanking plate assembly

VVQZ100-10A-5 (for VQZ100)

VVQZ200-10A-5 (for VQZ200)

VVQZ300-10A-5 (for VQZ300)

It is used by attaching on the manifold block for being prepared for removing a valve for maintenance reasons or planning to mount a spare valve, etc.

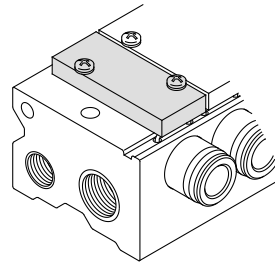

### Blanking plug

KQ2P-23

KQ2P-04

KQ2P-06

KQ2P-08

KQ2P-10

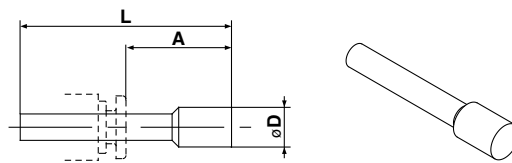

#### Dimensions

Applicable fitting size ød	Model	A	L	D
3.2	<b>KQ2P-23</b>	16	31.5	3.2
4	<b>KQ2P-04</b>	16	32	6
6	<b>KQ2P-06</b>	18	35	8
8	<b>KQ2P-08</b>	20.5	39	10
10	<b>KQ2P-10</b>	22	43	12

### DIN rail

AXT100-DR-□

\* As for □, enter the number from the DIN rail dimensions table.  
For L dimension, refer to the dimensions of each kit.

Each manifold can be mounted on a DIN rail.  
Insert "D" at the end of the manifold part number.  
The DIN rail is approximately 30 mm longer than the length of manifold.

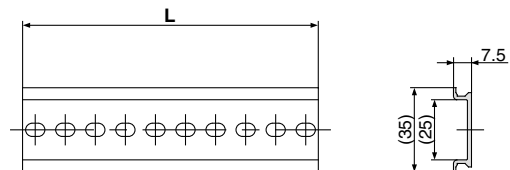

#### L Dimension

$$L = 12.5n + 10.5$$

No.	1	2	3	4	5	6	7	8	9	10	11	12	13	14	15	16	17	18	19	20
L dimension	23	35.5	48	60.5	73	85.5	98	110.5	123	135.5	148	160.5	173	185.5	198	210.5	223	235.5	248	260.5

  

No.	21	22	23	24	25	26	27	28	29	30	31	32	33	34	35	36	37	38	39	40
L dimension	273	285.5	298	310.5	323	335.5	348	360.5	373	385.5	398	410.5	423	435.5	448	460.5	473	485.5	498	510.5

### Silencer

(for manifold EXH port)

Silencer is installed in the manifold EXH port.

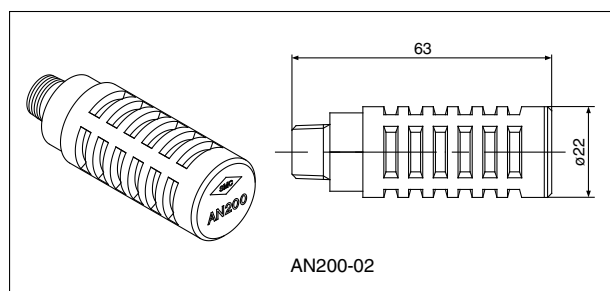
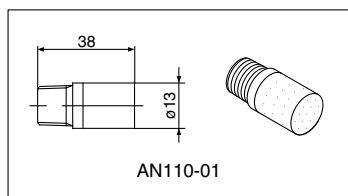

#### Dimensions

Model	Silencer part no.
<b>VQZ100</b>	AN110-01
<b>VQZ200</b>	AN200-02
<b>VQZ300</b>	AN200-02

### Port plug

VVQZ100-CP (for VQZ100)

This is used when changing piping location. (Side or Top)

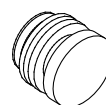

# Series VQZ Base Mounted

## Options

### External Pilot Specification

The external pilot specification is used when the operating pressure is below the minimum operating pressure 0.1 to 0.15 MPa or when valve is used for a vacuum application. Order a valve by adding the external pilot specification [R] to the part number.

#### Valve Part No.



• Entry is the same as standard products.

#### Manifold Part No.



• Entry is the same as standard products.

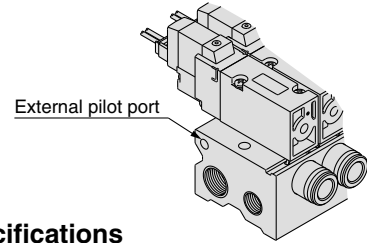

### Pressure Specifications

Series		VQZ100 <sup>Note 2)</sup>	VQZ200/300
External pilot pressure range <sup>Note 1)</sup>	Metal seal	—	0.1 to 0.7 MPa
	Rubber seal (VQZ100: poppet)	0.2 to 0.7 MPa	0.15 to 0.7 MPa
Operating pressure range <sup>Note 1)</sup>		-100 kPa to 0.7 MPa	

Note 1) In case of the high pressure type, upper limit of max. operating pressure and external pilot pressure range is 1 MPa.

Note 2) When using the VQZ100 series for a vacuum application, vacuum air through its 1(P) port. When supplying vacuum-release air, supply it through its 3(R) port. But do not supply vacuum-release air exceeding 50% for the external pilot pressure.

### Inch Size One-touch Fittings and Optional Threads

Inch size one-touch fittings and NPT, NPTF and G thread are available.

#### Manifold Part No.

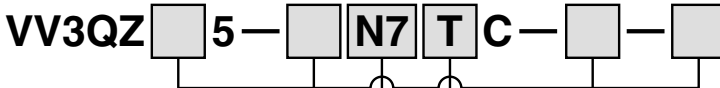

• Entry is the same as standard products.

• Cylinder port

• Thread type (Cylinder port and 1(P), 3(R) ports)

Symbol	N1	N3	N7	N9	N11	NM <sup>Note 1)</sup>	M5	O1	O2
Applicable tubing O.D.	ø1/8"	ø5/32"	ø1/4"	ø5/16"	ø3/8"	Mixed	M5 thread	1/8 thread	1/4 thread
Cylinder port	VQZ100	●	●	●	—	●	●	—	—
	VQZ200	—	●	●	●	●	—	●	—
	VQZ300	—	—	●	●	●	—	—	●

Nil	Rc
N	NPT
T	NPTF
F	G

Note 1) Except VQZ100, mixing one-touch fittings and thread types is impossible.  
Note 2) Metric size one-touch fittings (C□) are also available.

### Optional Threads Other than Rc

Rc specifications are standard for all ports, however, NPT, NPTF and G are available for overseas markets. Add the appropriate symbol following the port size in the standard part number.

#### Valve Part No.

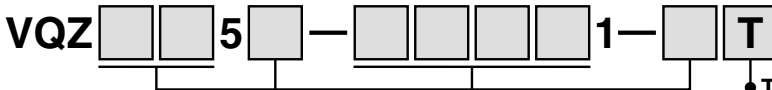

• Entry is the same as standard products.

• Thread type (Cylinder port and 1(P), 3(R) ports of sub-plate)

Nil	Rc
N	NPT
T	NPTF
F	G

### IP65 Enclosure (Based on IEC529)

DIN terminal is available with IP65 enclosure.

#### Valve Part No.

(Applicable to the VQZ200/300 rubber seal with the exception of the external pilot type)

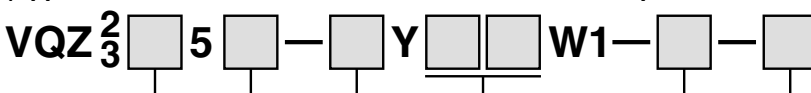

• Entry is the same as standard products.

Note) The pilot exhaust IP65 valves is common with main valve exhaust. (The standard valve has an individual exhaust for the pilot valve.)

# Replacement Parts

## One-touch Fitting Assembly (for Cylinder port)

Fitting size	C3	C4	C6	C8	C10	M5 (VQZ100 only)
<b>VQZ100</b>	VVQ1000-50A-C3	VVQ1000-50A-C4	VVQ1000-50A-C6	—	—	VVQ1000-50A-M5
<b>VQZ200</b>	—	VVQ1000-51A-C4	VVQ1000-51A-C6	VVQ1000-51A-C8	—	—
<b>VQZ300</b>	—	—	VVQ2000-51A-C6	VVQ2000-51A-C8	VVQ2000-51A-C10	—

Note) Purchasing order is available in units of 10 pieces.

### <Plug connector assembly>

DC: SY100-30-4A-

100 VAC: SY100-30-1A-

200 VAC: SY100-30-2A-

Other AC voltages: SY100-30-3A-

Without lead wire: SY100-30-A  
(with connector and 2 sockets only)

#### Lead wire length

Lead wire length	Symbol
300 mm	Nil
600 mm	6
1000 mm	10
1500 mm	15
2000 mm	20
2500 mm	25
3000 mm	30
5000 mm	50

### How to Order

Include the connector assembly part number together with the part number for the plug connector's solenoid valve without connector.

Example) In case of 2000 mm of lead wire

DC	AC
VQZ115-5LO1-M5	VQZ115-1LO1-M5
SY100-30-4A-20	SY100-30-1A-20

### <Gasket and screw assembly>

Model	Part no.
<b>VQZ100</b>	VQZ100-GS-5
<b>VQZ200</b>	VQZ200-GS-5
<b>VQZ300</b>	VQZ300-GS-5

Note) Above part number consists of 10 units. Each unit has one gasket and two screws. Purchasing order is available in units of 10 pieces.

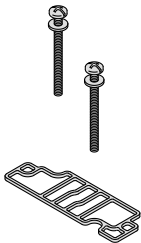

### <Sub-plate>

Model	Sub-plate part no.
<b>VQZ100</b>	VQZ100-S-01(R) (R) (-Q) (Note)
<b>VQZ200</b>	VQZ200-S-01 (01) (02) (-Q)
<b>VQZ300</b>	VQZ300-S-02 (02) (03) (-Q)

\* Thread type  
Note) R indicates external pilot type. Except VQZ100, external pilot type and internal pilot type are common.

### <Pilot valve assembly>

V111 □ □ — 5 G □ □

Symbol	Specifications	DC	AC
Nil	Standard	(0.35 W) ○	○
B (Note)	High speed response type (Applicable to VQZ200/300)	(0.9 W) ○	—
K (Note)	High pressure type (Applicable to Metal seal type, Poppet seal type)	(0.9 W) ○	—

Note) Option

#### Manual override

Nil	None (Applicable to VQZ200/300)
M	Yes (Applicable to VQZ100)

#### Manual override (Applicable to the VQZ100)

Nil	Non-locking push type
B	Locking slotted type

#### Coil voltage

1	100 VAC (50/60 Hz)
2	200 VAC (50/60 Hz)
3	110 VAC (50/60 Hz)
4	220 VAC (50/60 Hz)
5	24 VDC
6	12 VDC

#### Electrical entry

Symbol	Electrical entry	Light/surge voltage suppressor
DC	AC	
G	—	Grommet (DC specification)
LU	LZ	L-type plug connector with lead wire
LOU	LOZ	L-type plug connector without connector
MU	MZ	M-type plug connector with lead wire
MOU	MOZ	M-type plug connector without connector

Note) The electrical entry (L, M) for the VQZ100 pilot valve is different from that of the main valve model number.

Valve model	Pilot valve model
VQZ115□-□L□1	V111□M-□M□
VQZ115□-□M□1	V111□M-□L□

### <DIN terminal type (Applicable to the VQZ200/300)>

V115 □ □ — 5 Y — X110

Symbol	Specifications	DC	AC
Nil	Standard	(0.35 W) ○	○
B (Note)	High speed response type	(0.9 W) ○	—
K (Note)	High pressure type (Metal seal type only)	(0.9 W) ○	—

Note) Option

#### Coil voltage

1	100 VAC (50/60 Hz)
2	200 VAC (50/60 Hz)
3	110 VAC (50/60 Hz)
4	220 VAC (50/60 Hz)
5	24 VDC
6	12 VDC

#### Electrical entry

Symbol	Electrical entry	Light/surge voltage suppressor
Y	DIN terminal	None
YO	DIN terminal without connector	
YZ	DIN terminal with light/surge voltage suppressor	Yes
YS (Note)	DIN terminal with surge voltage suppressor (DC specification)	Yes (Without light)
YOS (Note)	DIN terminal with surge voltage suppressor, without connector (DC specification)	

Note) For AC voltage valves there is no "S" option. It is already built-in to the rectifier circuit.

### Caution

When replacing only the pilot valve assembly, use caution because it is not possible to convert to a V115 (DIN terminal) from a V111 (Grommet, L-type, M-type), or vice versa.





Series VQZ

# Safety Instructions

These safety instructions are intended to prevent a hazardous situation and/or equipment damage. These instructions indicate the level of potential hazard by labels of "Caution", "Warning" or "Danger". To ensure safety, be sure to observe ISO 4414 <sup>Note 1)</sup>, JIS B 8370 <sup>Note 2)</sup> and other safety practices.

## ■ Explanation of the Labels

Labels	Explanation of the labels
 <b>Danger</b>	In extreme conditions, there is a possible result of serious injury or loss of life.
 <b>Warning</b>	Operator error could result in serious injury or loss of life.
 <b>Caution</b>	Operator error could result in injury <sup>Note 3)</sup> or equipment damage. <sup>Note 4)</sup>

Note 1) ISO 4414: Pneumatic fluid power – General rules relating to systems

Note 2) JIS B 8370: General Rules for Pneumatic Equipment

Note 3) Injury indicates light wounds, burns and electrical shocks that do not require hospitalization or hospital visits for long-term medical treatment.

Note 4) Equipment damage refers to extensive damage to the equipment and surrounding devices.

## ■ Selection/Handling/Applications

### 1. The compatibility of the pneumatic equipment is the responsibility of the person who designs the pneumatic system or decides its specifications.

Since the products specified here are used in various operating conditions, their compatibility for the specific pneumatic system must be based on specifications or post analysis and/or tests to meet the specific requirements. The expected performance and safety assurance are the responsibility of the person who has determined the compatibility of the system. This person should continuously review the suitability of all items specified, referring to the latest catalog information with a view to giving due consideration to any possibility of equipment failure when configuring a system.

### 2. Only trained personnel should operate pneumatically operated machinery and equipment.

Compressed air can be dangerous if handled incorrectly. Assembly, handling or repair of the systems using pneumatic equipment should be performed by trained and experienced operators. (Understanding JIS B 8370 General Rules for Pneumatic Equipment, and other safety rules are included.)

### 3. Do not service machinery/equipment or attempt to remove components until safety is confirmed.

1. Inspection and maintenance of machinery/equipment should only be performed once measures to prevent falling or runaway of the driven objects have been confirmed.
2. When equipment is removed, confirm the safety process as mentioned above. Turn off the supply pressure for this equipment and exhaust all residual compressed air in the system, and release all the energy (liquid pressure, spring, condenser, gravity).
3. Before machinery/equipment is restarted, take measures to prevent quick extension of a cylinder piston rod, etc.

### 4. If the equipment will be used in the following conditions or environment, please contact SMC first and be sure to take all necessary safety precautions.

1. Conditions and environments beyond the given specifications, or if product is used outdoors.
2. Installation on equipment in conjunction with atomic energy, railway, air navigation, vehicles, medical equipment, food and beverages, recreation equipment, emergency stop circuits, clutch and brake circuits in press applications, or safety equipment.
3. An application which has the possibility of having negative effects on people, property, requiring special safety analysis.
4. If the products are used in an interlock circuit, prepare a double interlock style circuit with a mechanical protection function for the prevention of a breakdown. And, examine the devices periodically if they function normally or not.

## ■ Exemption from Liability

1. SMC, its officers and employees shall be exempted from liability for any loss or damage arising out of earthquakes or fire, action by a third person, accidents, customer error with or without intention, product misuse, and any other damages caused by abnormal operating conditions.

2. SMC, its officers and employees shall be exempted from liability for any direct or indirect loss or damage, including consequential loss or damage, loss of profits, or loss of chance, claims, demands, proceedings, costs, expenses, awards, judgments and any other liability whatsoever including legal costs and expenses, which may be suffered or incurred, whether in tort (including negligence), contract, breach of statutory duty, equity or otherwise.

3. SMC is exempted from liability for any damages caused by operations not contained in the catalogs and/or instruction manuals, and operations outside of the specification range.

4. SMC is exempted from liability for any loss or damage whatsoever caused by malfunctions of its products when combined with other devices or software.



# Series VQZ Specific Product Precautions 1

Be sure to read this before handling.

For Safety Instructions and 3 Port Solenoid Valve Precautions, refer to "Precautions for Handling Pneumatic Devices" (M-03-E3A).

## Manual Override

### ⚠ Caution

Without an electric signal for the solenoid valve the manual override is used for switching the main valve. Push type is standard. Locking type (Tool required) is available as an option.

#### 1. VQZ100

##### Push type

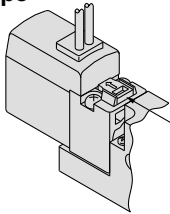

Press in the direction of the arrow.

##### Locking type (Tool required)

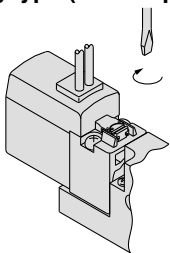

Turn 90° in the direction of arrow.

#### 2. VQZ200/300

##### Push type (Tool required)

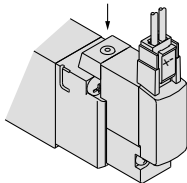

Push down on the manual override button with a small screwdriver until it stops. Release the screwdriver and the manual override will return.

##### Locking type (Tool required)

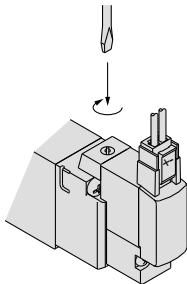

Push down completely on the manual override button with a small screwdriver. While down, turn clockwise 90° to lock it. Turn it counterclockwise to release it.

##### Locked position

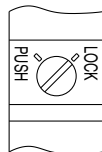

### Precautions

When operating with a screwdriver, turn it gently using a watchmaker's screwdriver. (Torque: less than 0.1 N·m)  
Press and rotate to lock the manual operation of VQZ200/300. If rotate without pressing, manual breakage and air leakage could be occurred.

## How to Use L/M-Type Plug Connector

### ⚠ Caution

#### 1. Attaching and detaching connectors

To attach a connector, hold the lever and connector unit between your fingers and insert straight onto the pins of the solenoid valve and remove the pawl from the groove by pushing the lever downward with your thumb, and pull the connector straight out.

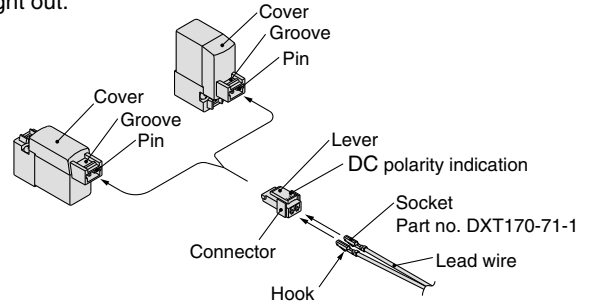

## Light/Surge Voltage Suppressor

### ⚠ Caution

#### 1. L/M-type plug connector

<DC>

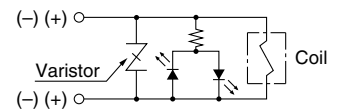

<AC>

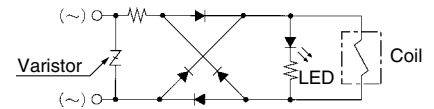

#### 2. DIN terminal

<DC>

##### With surge voltage suppressor (YS, YOS)

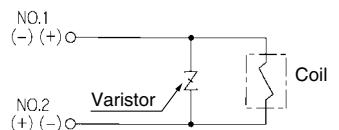

##### Light/surge voltage suppressor (YZ)

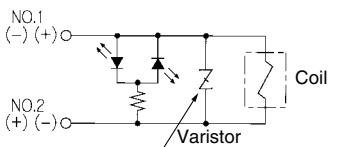

<AC>

##### With light (YZ)

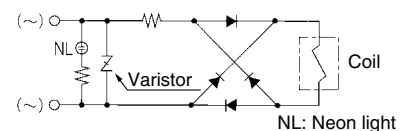

NL: Neon light

Note) Surge voltage suppressor of varistor has residual voltage corresponding to the protective element and rated voltage; therefore, protect the controller side from the surge.



# Series VQZ

## Specific Product Precautions 2

Be sure to read this before handling.

For Safety Instructions and 3 Port Solenoid Valve Precautions, refer to “Precautions for Handling Pneumatic Devices” (M-03-E3A).

### Light/Surge Voltage Suppressor

#### ⚠ Caution

##### 1. Surge voltage countermeasures

When shutting off the DC power supply using an emergency circuit breaker, the valve may operate incorrectly due to surge voltage generated by other electric parts (e.g., the solenoid). To ensure that surge does not affect the valve, take anti-surge measures (diode for surge protection, etc.) or use a valve with diode to prevent reverse current. (Contact SMC for model numbers.)

Circuit example

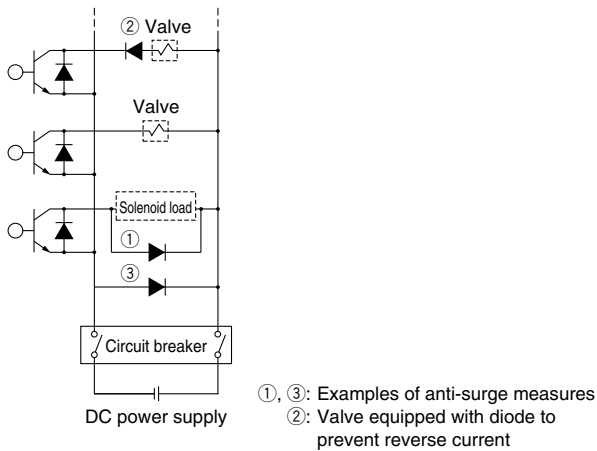

### Lead Wire Connection

#### ⚠ Caution

##### 1. Crimping of lead wires and sockets

Not necessary if ordering the lead wire pre-connected model. Strip 3.2 to 3.7 mm at the end of the lead wires, insert the ends of the core wires evenly into the sockets, and then crimp with a crimping tool. When this is done, take care that the coverings of the lead wires do not enter the core wire crimping area.

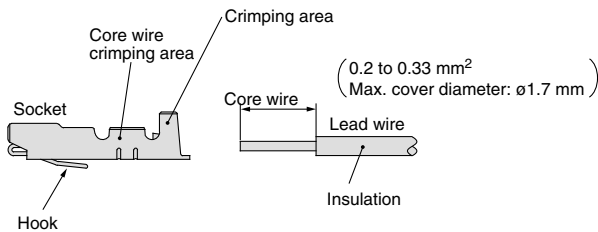

Crimping tool part no. DXT170-75-1

### Lead Wire Connection

#### ⚠ Caution

##### 2. Attaching and detaching sockets with lead wires

###### Attaching

Insert the sockets into the square holes of the connector (⊕, ⊖ indication), and continue to push the sockets all the way in until they lock by hooking into the seats in the connector. (When they are pushed in, their hooks open and they are locked automatically.) Then, confirm that they are locked by pulling lightly on the lead wires.

###### Detaching

To detach a socket from a connector, pull out the lead wire while pressing the socket's hook with a stick having a thin tip (approx. 1 mm). If the socket will be used again, first spread the hook outward.

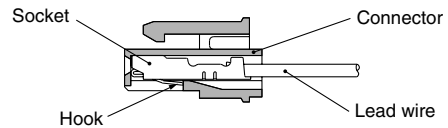

### Pilot Valve Replacement

#### ⚠ Caution

##### 1. When replacing a conventional type valve with a new type for maintenance or other reasons, a “conversion connector assembly” is necessary to convert the connector from 3 terminals to 2 terminals and must be ordered separately. (When ordering, refer to the below part nos.)

For pilot valves, there is no compatibility between the conventional type and new type. When replacing a pilot valve, be sure to confirm whether it is the new type or the conventional type.

###### [Conventional]

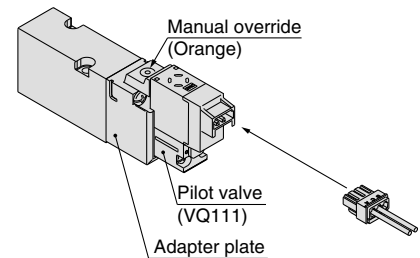

###### [New]

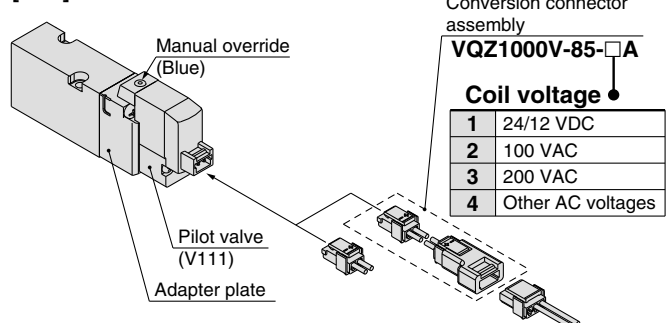



# Series VQZ

## Specific Product Precautions 3

Be sure to read this before handling.

For Safety Instructions and 3 Port Solenoid Valve Precautions, refer to “Precautions for Handling Pneumatic Devices” (M-03-E3A).

### How to Use DIN Terminal

#### 1. EN-175301-803C (Former DIN 43650C)

The DIN terminal type with an IP65 enclosure is protected against dust and water, however, it must not be used in water.

#### 2. Connection

- Loosen the holding screw and pull the connector out of the solenoid valve terminal block.
- After removing the holding screw, insert a flat head screwdriver, etc. into the notch on the bottom of the terminal block and pry it open, separating the terminal block and the housing.
- Loosen the terminal screws (slotted screws) on the terminal block, insert the cores of the lead wires into the terminals according to the connection method, and fasten them securely with the terminal screws.
- Secure the cord by fastening the ground nut.

#### 3. Changing the entry direction

After separating the terminal block and housing, the cord entry can be changed by attaching the housing in the desired direction (4 directions at 90° intervals).

\* When equipped with a light, be careful not to damage the light with the cord's lead wires.

#### 4. Precautions

Plug in and pull out the connector vertically without tilting to one side.

#### 5. Compatible cable

Cable O.D.:  $\varnothing 3.5$  to  $\varnothing 7$

(Reference) 0.5 mm<sup>2</sup>, 2-core or 3-core, equivalent to JIS C 3306

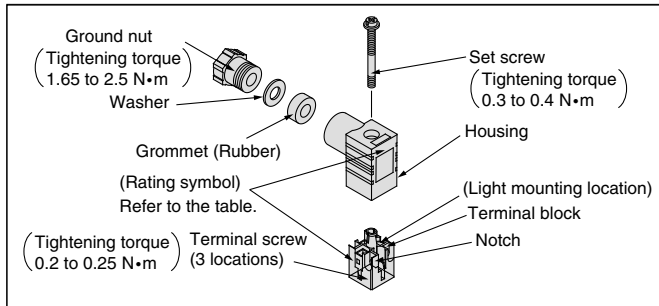

### DIN Connector Part No.

#### Without light

Rated voltage	Voltage symbol	Part no.
All voltages	None	SY100-82-1

#### With light

Rated voltage	Voltage symbol	Part no.
24 VDC	24 V	SY100-82-3-05
12 VDC	12 V	SY100-82-3-06
100 VAC	100 V	SY100-82-2-01
200 VAC	200 V	SY100-82-2-02
110 VAC (115 VAC)	110 V	SY100-82-2-03
220 VAC (230 VAC)	220 V	SY100-82-2-04

#### Circuit diagram with light

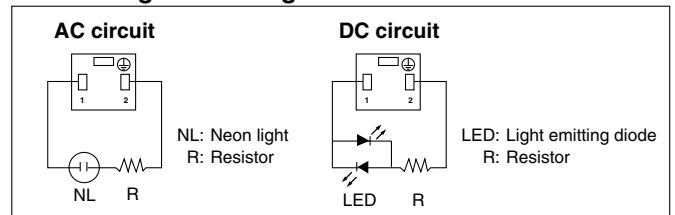

### Fitting and Silencer Part No. for P, R Ports When Using Valve as an Individual Unit

#### Part no. for one-touch fitting for 1(P) port and silencer/one-touch fitting for 3(R) port

Series	(1) One-touch fitting for 1(P) port	(2) For 3(R) port	
		Silencer	One-touch fitting
VQZ100	KQ2H06-M5	AN120-M5	KJS04-M5
VQZ200	KQ2S06-01S	INA-25-46	IN-457-32 (for $\varnothing 6$ )
VQZ300	KQ2H08-02S	AN101-01	KQ2H06-01S

The diameter of the above fitting and silencer is the maximum diameter to in the EXH port.

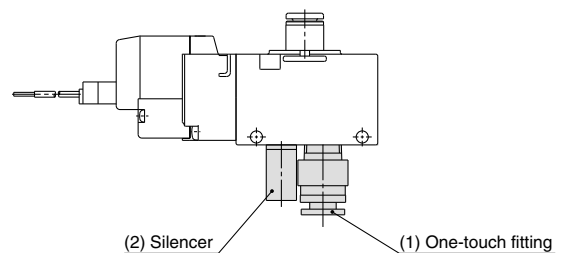



# Series VQZ

## Specific Product Precautions 4

Be sure to read this before handling.

For Safety Instructions and 3 Port Solenoid Valve Precautions, refer to “Precautions for Handling Pneumatic Devices” (M-03-E3A).

### One-touch Fittings Replacement

#### ⚠ Caution

The built-in fittings on the manifold can be changed easily. Simply remove the corresponding valve and take out the fitting clip underneath.

Take out the clip with a screwdriver, etc., then replace the fittings. About mounting the fittings, after inserting the fitting until it stops, then put the clip into the prescribed position.

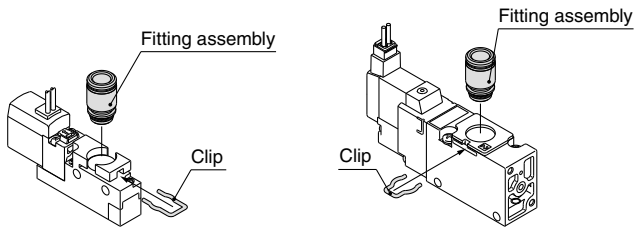

VQZ200: Horizontally clipped to the valve body  
VQZ100/300: Vertically clipped to the valve body

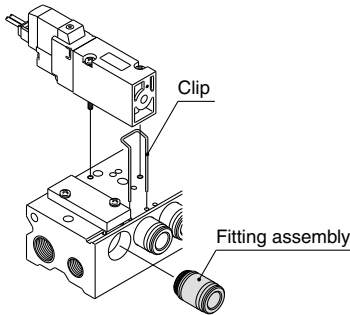

#### Precautions

When pulling the fitting assembly away from the valve base, remove the clip, then connect a tube or plug (KQ2P-□□) with the one-touch fitting and pull it out holding the tube or plug. Do not hold the release bushing to avoid damage.

### DIN Rail Removal/Mounting

#### ⚠ Caution

##### 1. Removing

- 1) Loosen the clamp screw on the (a) side of both ends of the manifold.
- 2) Lift the (a) side of the manifold off the DIN rail and slide it in the direction of the (b) side.

##### 2. Mounting

- 1) Catch the hook of the DIN rail bracket on the (b) side on the DIN rail.
- 2) Push side (a) onto the DIN rail and tighten the clamp screw. The proper tightening torque for screws is 0.3 to 0.4 N·m.

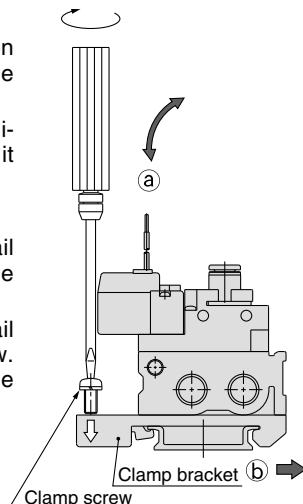

### Valve Mounting

#### ⚠ Caution

1. After confirming the gasket is correctly placed under the valve, securely tighten the bolts with the proper torque shown in the table below.

Model	Proper tightening torque
VQZ100	0.13 to 0.19 N·m
VQZ200	0.25 to 0.35 N·m
VQZ300	0.5 to 0.7 N·m

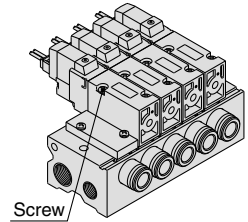

### VQZ100 Piping Direction Replacement

#### ⚠ Caution

##### 1. How to replace the port direction

Fitting and port plug are modules. After removing the clip with a flat head screwdriver, take out the fitting and port plug. The piping direction (side or top) can be altered by exchanging the fitting and port plug. During exchange, insert the fitting and the port plug until they contact the wall, then, insert the clip to specified position.

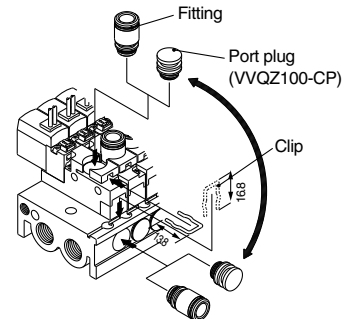

#### Precautions

The clip length for the valve and the base are different. Fitting may detach if the incorrect clip is used.

##### 2. Valve piped on top can be operated independently by using PR plate.

(Refer to the below part numbers when placing an order.)

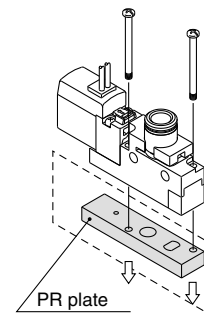

VQZ100-12A (Standard)  
VQZ100-12B (External pilot type)  
\* 2 set screws are included.





#### Record of changes

<b>B edition</b>	* Page 3, 19	Correction of Solenoid Specifications and Flow Characteristics	
	* Page 4, 20	Correction of Construction	
	* Page 5 to 7, Page 11 to 13, Page 21 to 23, Page 27 to 30	Correction of Dimensions	
	* Page 34	Addition of Made to Order	LX

 **Safety Instructions** Be sure to read "Precautions for Handling Pneumatic Devices" (M-03-E3A) before using.

## SMC Corporation

Akihabara UDX 15F,  
4-14-1, Sotokanda, Chiyoda-ku, Tokyo 101-0021, JAPAN  
Phone: 03-5207-8249 Fax: 03-5298-5362  
URL <http://www.smcworld.com>  
© 2007 SMC Corporation All Rights Reserved

Specifications are subject to change without prior notice and any obligation on the part of the manufacturer.

D-DN

1st printing KY printing LX 13500DN Printed in Japan.

This catalog is printed on recycled paper with concern for the global environment.