

VQZ200/300 / How to Order Valve



Made to Order

(For details, refer to page 3 and 34.)

VQZ **2** **1** **2** **5** **M** **1** - **C6** - -

Series

2	VQZ200 body width 15 mm
3	VQZ300 body width 18 mm

Type of actuation

1	N.C.	(A) 2 3 1 (R) (P)	Metal seal
	N.O.	(A) 2 3 1 (R) (P)	
3	N.C.	(A) 2 3 1 (R) (P)	Rubber seal
	N.O.	(A) 2 3 1 (R) (P)	

Body type

2	Body ported
---	-------------

Function

Symbol	Specifications	DC (0.35 W)	AC (Note 3)
Nil	Standard	○	○
B Note 1)	High speed response type	○	—
K Note 1)	High pressure type (Metal seal type only)	○	—
R Note 1, 2)	External pilot type	○	○
BR Note 1, 2)	High speed response/External pilot type	○	—
KR Note 1, 2)	High pressure/External pilot type (Metal seal type only)	○	—



Note 1) Option

Note 2) For details on external pilot type, refer to page 15.

Note 3) For AC specification power consumption, refer to page 3.

Caution

Use standard (DC) specification for continuous duty.

Coil voltage

1	100 VAC (50/60 Hz)
2	200 VAC (50/60 Hz)
3	110 VAC [115 VAC] (50/60 Hz)
4	220 VAC [230 VAC] (50/60 Hz)
5	24 VDC
6	12 VDC

Note) For applicable one-touch fitting and silencer models for this valve series, refer to back page 4.

IP65 compliant

Nil	—
W Note)	Compliant

Note) VQZ200/300 DIN terminal rubber seal only (except external pilot). For details on IP65 enclosure, refer to page 15.

CE compliant

Nil	—
Q	CE marked

Note) AC-type models that are CE compliant have DIN terminals only.

Option

Nil: None
F: With bracket

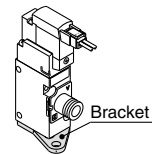

Port size [2(A) port]

Symbol	Port size	VQZ200	VQZ300
C4	ø4 one-touch fitting	○	—
C6	ø6 one-touch fitting	○	○
C8	ø8 one-touch fitting	—	○
C10	ø10 one-touch fitting	—	○
M5	M5 thread	○	—
02	Rc 1/4	—	○

Note) For inch size one-touch fittings and option thread type, refer to page 15.

Manual override

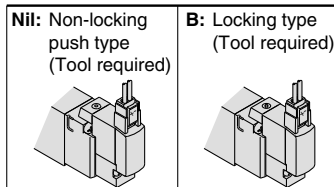

Electrical entry

G: Grommet (DC specification)	L: L-type plug connector with lead wire	LO: L-type plug connector without connector	M: M-type plug connector with lead wire	MO: M-type plug connector without connector
	With light/surge voltage suppressor 	With light/surge voltage suppressor 	With light/surge voltage suppressor 	With light/surge voltage suppressor
Y: DIN terminal 	YO: DIN terminal without connector 	YZ: DIN terminal 	YOS: DIN terminal without connector (DC specification) 	YS: DIN terminal (DC specification)
		With light/surge voltage suppressor 	With surge voltage suppressor 	With surge voltage suppressor



Note 1) Standard lead wire length: 300 mm

Note 2) For AC voltage valves there is no "S" option. It is already built-in to the rectifier circuit.

Series VQZ100/200/300

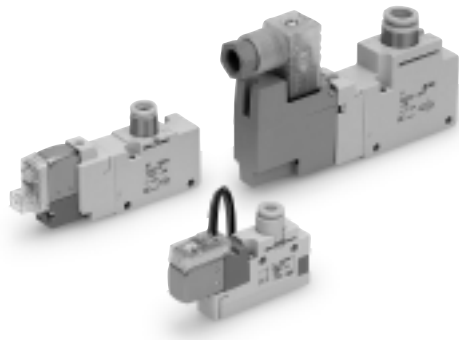

Specifications

Valve construction	Metal seal	Rubber seal	VQZ100 (Poppet seal)
Fluid	Air, Inert gas		
Max. operating pressure (MPa)	0.7 (High pressure type: 1.0)	0.7	0.7 (High pressure type: 1.0)
Min. operating pressure (MPa)	0.1	0.15	0.15
Ambient and fluid temperature (°C)	-10 to 50 (No freezing)		
Max. operating frequency (Hz)	20	5	20
Pilot exhaust method	Individual exhaust		Common exhaust
Lubrication	Not required		
Manual override	Push type, Locking type (Tool required)		
Mounting orientation	Free		
Impact/Vibration resistance (m/s ²) ^{Note 1)}	150/30		
Enclosure	Dustproof (DIN terminal: IP65 ^{Note 2)})		



* Based on IEC60529

Note 1) Impact resistance: No malfunction occurred when it is tested with a drop tester in the axial direction and at the right angles to the main valve and armature in both energized and de-energized states every once for each condition. (Value in the initial state)

Vibration resistance: No malfunction occurred in one sweep test between 45 and 2000 Hz. Test was performed to axis and right angle directions of the main valve and armature when pilot signal is ON and OFF. (Value in the initial state)

Note 2) When IP65 compliant DIN terminals are selected: VQZ₃□2□-□Y□□W1-□□

Options

High speed response type
High pressure type (Metal seal type only)
External pilot type*

* For details on external pilot type, refer to page 15.



Made to Order
(For details, refer to page 34.)

Symbol	Description
X30	Pilot valve common exhaust
X90	Main valve fluoro-rubber
X113	All fluoro-rubber

Solenoid Specifications

Electrical entry		Grommet (G)		M-type plug connector (M)	
		L-type plug connector (L)		DIN terminal (Y)	
		G, L, M		Y	
Coil rated voltage (V)	DC	24, 12			
	AC 50/60 Hz	100, 110, 200, 220*			
Allowable voltage fluctuation		±10% of rated voltage*			
Power consumption (W)	DC	Standard	0.35 [(With light: 0.4 (DIN terminal with light: 0.45)]		
		High speed response, high pressure	0.9 [(With light: 0.95 (DIN terminal with light: 1.0)]		
Apparent power (VA)*	AC	100 V	0.78 (With light: 0.81)	0.78 (With light: 0.87)	
		110 V [115 V]	0.86 (With light: 0.89) [0.94 (With light: 0.97)]	0.86 (With light: 0.87) [0.94 (With light: 1.07)]	
		200 V	1.18 (With light: 1.22)	1.15 (With light: 1.30)	
		220 V [230 V]	1.30 (With light: 1.34) [1.42 (With light: 1.46)]	1.27 (With light: 1.46) [1.39 (With light: 1.60)]	
Surge voltage suppressor		Varistor			
Indicator light		LED (Neon light when AC with DIN terminal)			



* In common between 110 VAC and 115 VAC, and between 220 VAC and 230 VAC.

* For 115 VAC and 230 VAC, the allowable voltage is -15% to +5% of rated voltage.

Flow Characteristics

Series	Valve construction	Model		Flow characteristics						Response time (ms) ^{Note 1)}				Weight (g) ^{Note 2)}
				1→2 (P→A)			2→3 (A→R)			Standard: 0.35 W	High speed response: 0.9 W	High pressure: 0.9 W	AC	
				C [dm ³ /(s·bar)]	b	Cv	C [dm ³ /(s·bar)]	b	Cv					
VQZ100	N.C. valve	Poppet	VQZ115	0.59	0.44	0.17	0.56	0.30	0.14	10 or less	—	13 or less	22 or less	24
VQZ200	N.C. valve	Metal seal	VQZ212	1.2	0.21	0.30	1.3	0.24	0.33	22 or less	14 or less	18 or less	34 or less	57
		Rubber seal	VQZ232	1.6	0.33	0.39	1.7	0.37	0.45	22 or less	15 or less	—	36 or less	
	N.O. valve	Metal seal	VQZ222	1.2	0.25	0.31	1.3	0.20	0.31	22 or less	14 or less	18 or less	34 or less	
		Rubber seal	VQZ242	1.6	0.36	0.40	1.7	0.36	0.45	22 or less	15 or less	—	36 or less	
VQZ300	N.C. valve	Metal seal	VQZ312	2.7	0.18	0.62	2.4	0.28	0.56	22 or less	17 or less	22 or less	34 or less	93
		Rubber seal	VQZ332	3.5	0.34	0.87	3.0	0.33	0.72	33 or less	25 or less	—	57 or less	
	N.O. valve	Metal seal	VQZ322	2.6	0.21	0.59	2.2	0.16	0.49	22 or less	17 or less	22 or less	34 or less	
		Rubber seal	VQZ342	3.5	0.38	0.88	2.9	0.27	0.69	33 or less	25 or less	—	57 or less	



Note 1) Based on JIS B 8375-1981 (Supply pressure: 0.5 MPa; with light/surge voltage suppressor: clean air)

Response time values will change depending on pressure and air quality.

Note 2) Weight for threaded connection

Construction

VQZ100 Poppet type

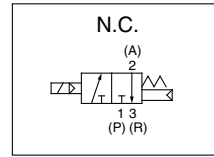
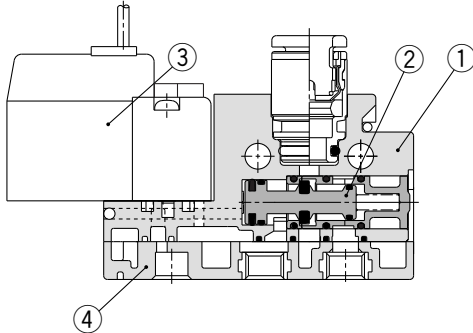

Component Parts

No.	Description	Material	Note
1	Body	Resin	
2	Spool valve	Aluminum/HNBR	
3	Pilot valve assembly	—	
4	P, R port	Resin/Aluminum	VQZ100-12A (Standard) VQZ100-12B (External pilot type)

VQZ200/300 Metal seal type

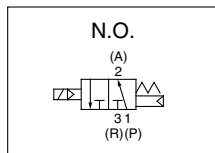
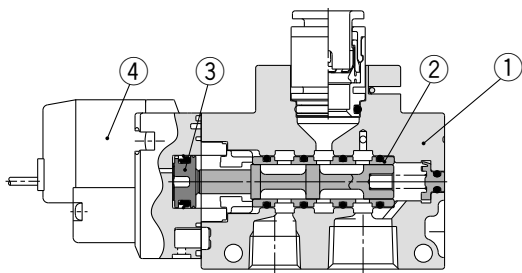
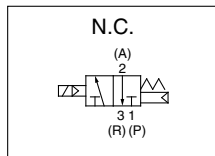
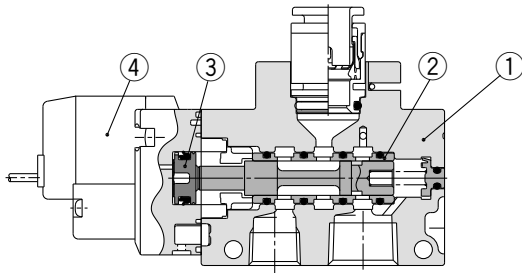

Rubber seal type

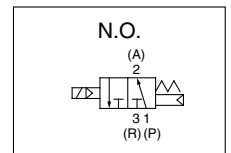
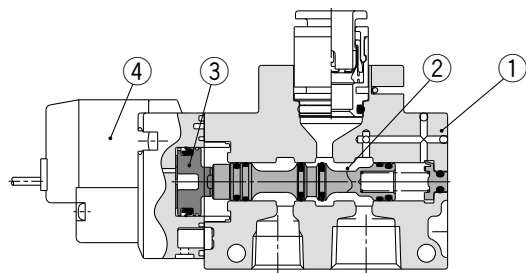
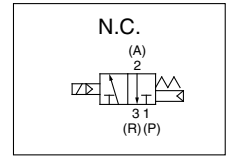
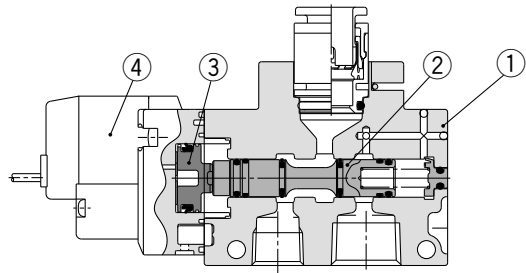

Component Parts

No.	Description	Material	Note
1	Body	Aluminum die-casted	
2	Spool, Sleeve	Stainless steel	Metal seal
	Spool valve	Aluminum/HNBR	Rubber seal
3	Piston	Resin	
4	Pilot valve assembly	—	

Note) For "How to Order Pilot Valve Assembly", refer to page 16.

Dimensions: VQZ200

Single Unit

Grommet (G): VQZ2□2□-□G□1-C4, C6

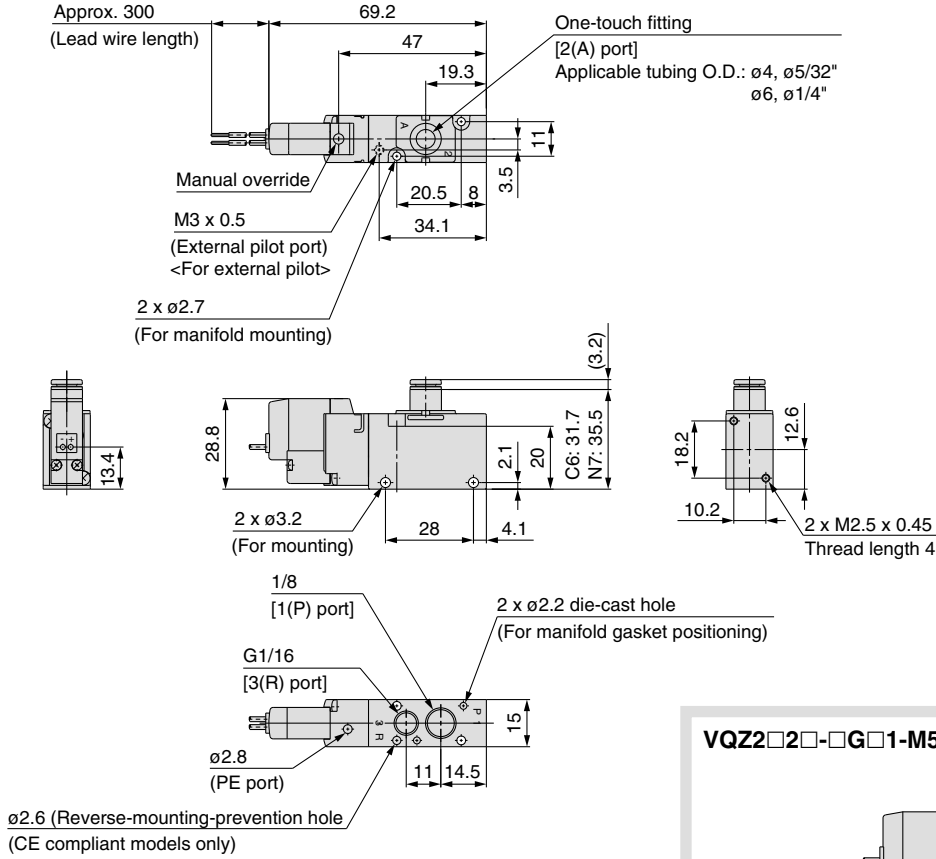

Note) For one-touch fittings for P/R port and silencer part no., refer to back page 4.

VQZ2□2□-□G□1-M5

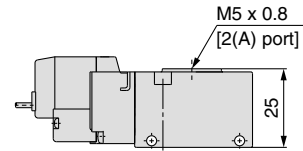

L-type plug connector (L): VQZ2□2□-□L□1-C4, C6

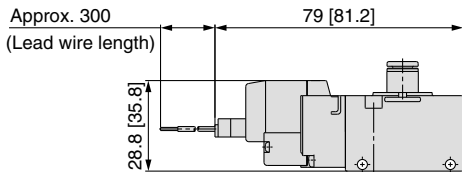

Unless otherwise indicated, dimensions are the same as Grommet (G).
[]: AC

M-type plug connector (M): VQZ2□2□-□M□1-C4, C6

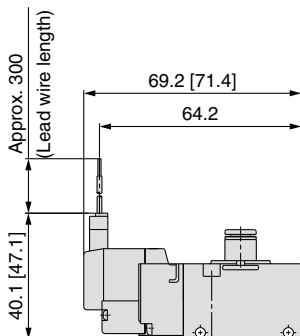

Unless otherwise indicated, dimensions are the same as Grommet (G).
[]: AC

DIN terminal (Y): VQZ2□2□-□Y□1-C4, C6

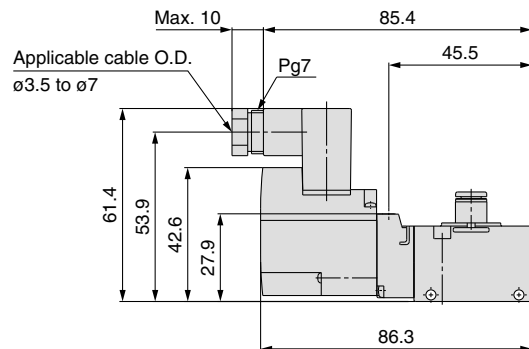

Unless otherwise indicated, dimensions are the same as Grommet (G).

Series VQZ100/200/300

Dimensions: VQZ300

Single Unit

Grommet (G): VQZ3□2□-□G□1-C6, C8, C10

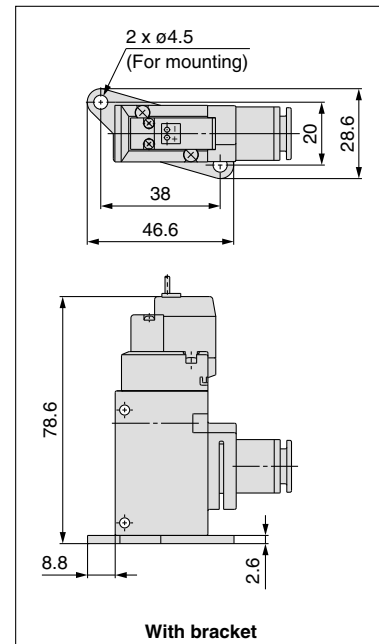
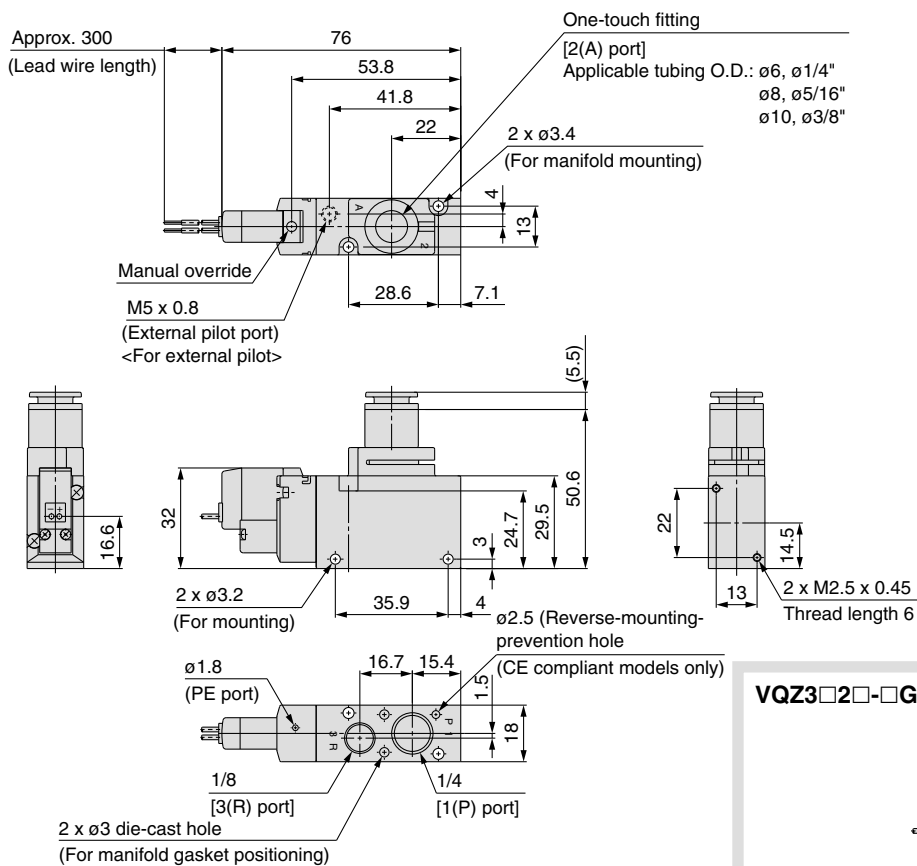

Note) For bracket assembly part no., refer to page 16.

VQZ3□2□-□G□1-02

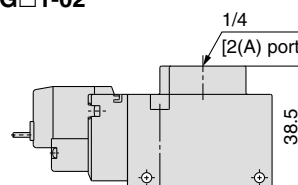

L-type plug connector (L): VQZ3□2□-□L□1-C6, C8, C10

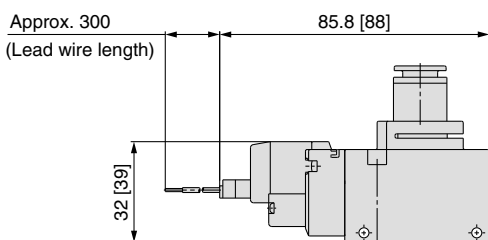

Unless otherwise indicated, dimensions are the same as Grommet (G).
[] : AC

M-type plug connector (M): VQZ3□2□-□M□1-C6, C8, C10

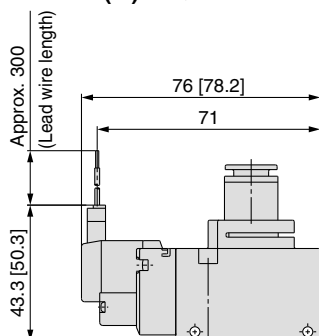

Unless otherwise indicated, dimensions are the same as Grommet (G).
[] : AC

DIN terminal (Y): VQZ3□2□-□Y□□1-C6, C8, C10

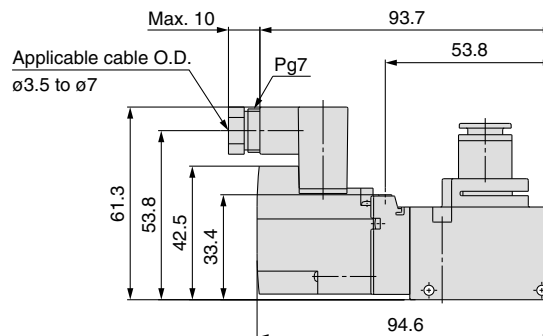

Unless otherwise indicated, dimensions are the same as Grommet (G).

Series VQZ100/200/300

VQZ200/300 / How to Order Manifold



Made to Order
(For details, refer to page 34.)

VV3QZ **2** **2** - **08** **C** - **□** - **□**

Series

2	VQZ200
3	VQZ300

Manifold type

2	Body ported
---	-------------

Stations

02	2 stations
⋮	⋮
20	20 stations

Kit type

C	Connector
---	-----------

CE compliant

Nil	—
Q	CE marked

Option

Nil	None
D	DIN rail mounting (With standard DIN rail length)
D0 ^{Note)}	DIN rail mounting (Without DIN rail)

Note) Order DIN rail separately.
For DIN rail part no., refer to page 14.

Note) For 1(P), 3(R) of optional thread type, refer to page 15.

VQZ200/300 / How to Order Valve

VQZ **2** **1** **2** **□** - **5** **M** **□** **□** **1** - **□** - **□**

Series

2	VQZ200 body width 15 mm
3	VQZ300 body width 18 mm

Type of actuation

1	N.C. Metal seal
2	N.O. Metal seal
3	N.C. Rubber seal
4	N.O. Rubber seal

Body type

2	Body ported
---	-------------

Function

Symbol	Specifications	DC	AC
Nil	Standard	(0.35 W) ○	Note 3) ○
B ^{Note 1)}	High speed response type	(0.9 W) ○	—
K ^{Note 1)}	High pressure type (Metal seal type only)	(0.9 W) ○	—
R ^{Note 1, 2)}	External pilot type	○	○
BR ^{Note 1, 2)}	High speed response/External pilot type	(0.9 W) ○	—
KR ^{Note 1, 2)}	High pressure/External pilot type (Metal seal type only)	(0.9 W) ○	—



Note 1) Option
Note 2) For details on external pilot type, refer to page 15.
Note 3) For AC specification power consumption, refer to page 3.

Caution

Use standard (DC) specification for continuous duty.

Coil voltage

1	100 VAC (50/60 Hz)
2	200 VAC (50/60 Hz)
3	110 VAC [115 VAC] (50/60 Hz)
4	220 VAC [230 VAC] (50/60 Hz)
5	24 VDC
6	12 VDC

IP65 compliant

Nil	—
W ^{Note)}	Compliant

Note) VQZ200/300 DIN terminal rubber seal only (except external pilot).
For details on IP65 enclosure, refer to page 15.

CE compliant

Nil	—
Q	CE marked

Note) AC-type models that are CE compliant have DIN terminals only.

Port size [2(A) port]

Symbol	Port size	VQZ200	VQZ300
C4	ø4 one-touch fitting	○	—
C6	ø6 one-touch fitting	○	○
C8	ø8 one-touch fitting	—	○
C10	ø10 one-touch fitting	—	○
M5	M5 thread	○	—
02	Rc 1/4	—	○

Note) For inch size one-touch fittings and optional thread type, refer to page 15.

Manual override

Nil	Non-locking push type (Tool required)
B	Locking type (Tool required)

Electrical entry

Symbol	Electrical entry	Light/surge voltage suppressor
G	Grommet (DC specification)	None
L	L-type plug connector with lead wire	Yes
LO	L-type plug connector without connector	
M	M-type plug connector with lead wire	
MO	M-type plug connector without connector	
Y	DIN terminal	None
YO	DIN terminal without connector	
YZ	DIN terminal	Yes
YS ^{Note 2)}	DIN terminal (DC specification)	Yes
YOS ^{Note 2)}	DIN terminal without connector (DC specification)	(Without light)



Note 1) Standard lead wire length: 300 mm
Note 2) For AC voltage valves there is no "S" option. It is already built-in to the rectifier circuit.

Dimensions: VQZ200

VV3QZ22- Stations C

Grommet (G)

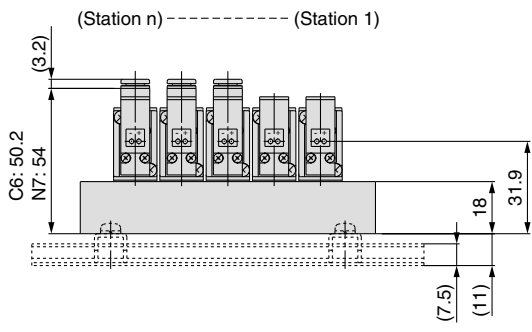
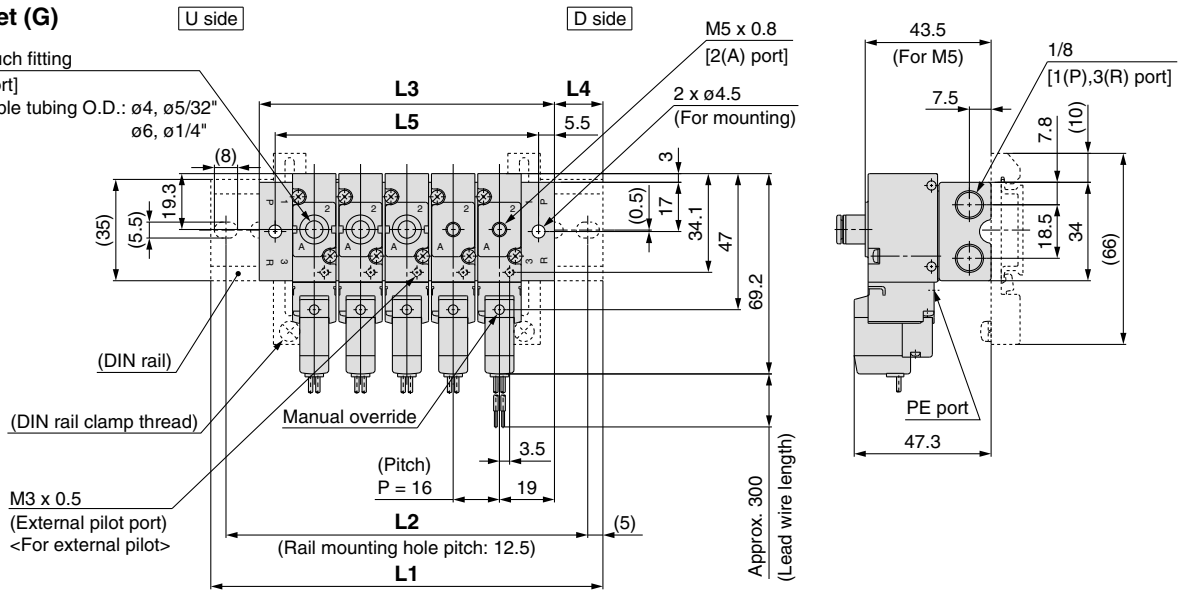

The dashed lines indicate the DIN rail mounting [-D].

L-type plug connector (L)

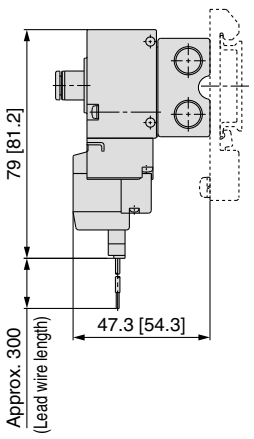

Unless otherwise indicated, dimensions are the same as Grommet (G).
[]: AC

M-type plug connector (M)

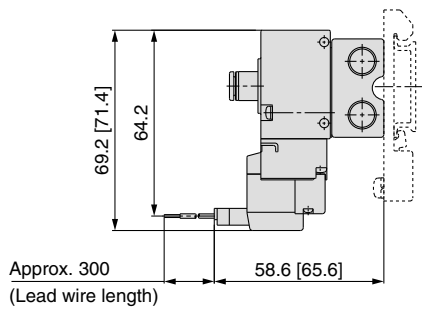

Unless otherwise indicated, dimensions are the same as Grommet (G).
[]: AC

DIN terminal (Y)

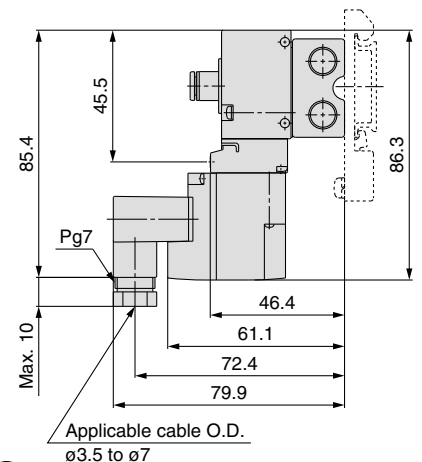

Unless otherwise indicated, dimensions are the same as Grommet (G).

Dimensions

Formula: $L5 = 16n + 11$ $L3 = 16n + 22$ n: Stations (Max. 20 stations)

L \ n	2	3	4	5	6	7	8	9	10	11	12	13	14	15	16	17	18	19	20
L1	85.5	110.5	123	135.5	148	173	185.5	198	223	235.5	248	260.5	285.5	298	310.5	335.5	348	360.5	373
L2	75	100	112.5	125	137.5	162.5	175	187.5	212.5	225	237.5	250	275	287.5	300	325	337.5	350	362.5
L3	54	70	86	102	118	134	150	166	182	198	214	230	246	262	278	294	310	326	342
L4	16	20.5	18.5	17	15	19.5	18	16	20.5	19	17	15.5	20	18	16.5	21	19	17.5	15.5
L5	43	59	75	91	107	123	139	155	171	187	203	219	235	251	267	283	299	315	331

Series VQZ100/200/300

Dimensions: VQZ300

VV3QZ32- Stations C

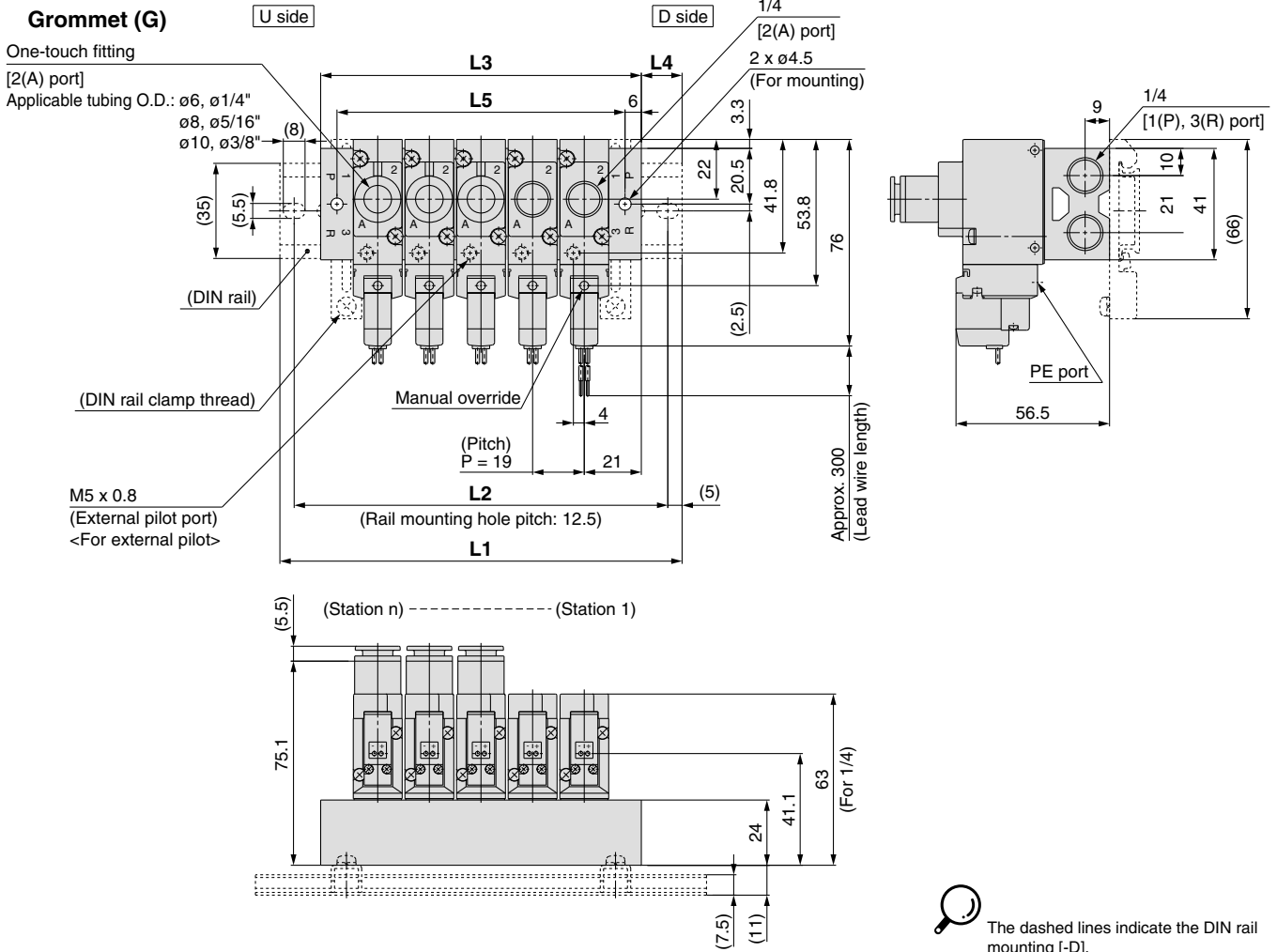

The dashed lines indicate the DIN rail mounting [-D].

L-type plug connector (L)

85.8 [88]
 56.5 [63.5]
 Approx. 300 (Lead wire length)

Unless otherwise indicated, dimensions are the same as Grommet (G).
 [] : AC

M-type plug connector (M)

76 [78.2]
 71
 67.8 [74.8]
 Approx. 300 (Lead wire length)

Unless otherwise indicated, dimensions are the same as Grommet (G).
 [] : AC

DIN terminal (Y)

93.7
 53.8
 94.6
 57.9
 67
 78.3
 85.8
 Max. 10
 Pg7
 Applicable cable O.D.
 $\phi 0.35$ to $\phi 0.7$

Unless otherwise indicated, dimensions are the same as Grommet (G).

Dimensions

Formula: $L5 = 19n + 11$ $L3 = 19n + 23$ n: Stations (Max. 20 stations)

L \ n	2	3	4	5	6	7	8	9	10	11	12	13	14	15	16	17	18	19	20
L1	98	110.5	135.5	148	173	198	210.5	235.5	248	273	285.5	310.5	323	348	360.5	385.5	398	423	435.5
L2	87.5	100	125	137.5	162.5	187.5	200	225	237.5	262.5	275	300	312.5	337.5	350	375	387.5	412.5	425
L3	61	80	99	118	137	156	175	194	213	232	251	270	289	308	327	346	365	384	403
L4	18.5	15.5	18.5	15	18	21	18	21	17.5	20.5	17.5	20.5	17	20	17	20	16.5	19.5	16.5
L5	49	68	87	106	125	144	163	182	201	220	239	258	277	296	315	334	353	372	391

Series VQZ Body Ported

Options

External Pilot Specification

The external pilot specification is used when the operating pressure is below the minimum operating pressure 0.1 to 0.15 MPa or when valve is used for a vacuum application. Order a valve by adding the external pilot specification [R] to the part number.

Valve Part No.



• Entry is the same as standard products.

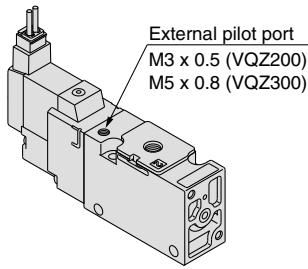

Pressure Specifications

Series		VQZ100 ^{Note 2)}	VQZ200/300
External pilot pressure range	Metal seal	—	0.1 to 0.7 MPa
	Rubber seal (VQZ100: poppet)	0.2 to 0.7 MPa	0.15 to 0.7 MPa
Operating pressure range ^{Note 1)}		-100 kPa to 0.7 MPa	

• Note 1) In case of the high pressure type, upper limit of max. operating pressure and external pilot pressure range is 1 MPa.
 • Note 2) Pump down from 1(P) port when VQZ100 series vacuum type is specified. Apply pressure from 3(R) port to relieve vacuum pressure. Set the release pressure at 50% of external pilot pressure or less.

Inch Size One-touch Fittings and Optional Threads

Inch size one-touch fittings and NPT, NPTF and G thread are available.

Valve Part No.

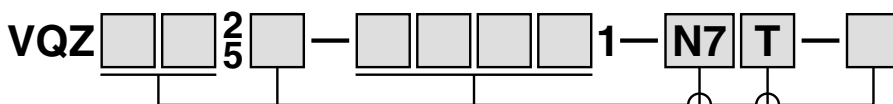

• Entry is the same as standard products.

		Cylinder port						
Symbol		N1	N3	N7	N9	N11	M5	O2
Applicable tubing O.D. (Inch)		ø1/8"	ø5/32"	ø1/4"	ø5/16"	ø3/8"	M5 thread	1/4 thread
2(A) port	VQZ100	●	●	●	—	—	●	—
	VQZ200	—	●	●	—	—	●	—
	VQZ300	—	—	●	●	●	—	●

• Thread type (Cylinder port and 1(P), 3(R) ports)

Nil	Rc
N	NPT
T	NPTF
F	G

• Note 1) 3(R) port of the VQZ200 is only G1/16.
 • Note 2) Except VQZ100

• Note) Metric size one-touch fittings (□) are also available.

Manifold Part No.

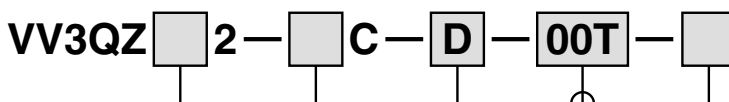

• Entry is the same as standard products.

• Thread type (1(P), 3(R) ports)

Nil	Rc
00N	NPT
00T	NPTF
00F	G

IP65 Enclosure (Based on IEC529)

DIN terminal is available with IP65 enclosure.

Valve Part No.

(Applicable to the VQZ200/300 rubber seal with the exception of the external pilot type)

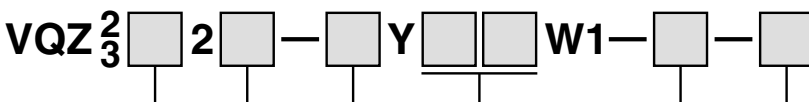

• Entry is the same as standard products.

• Note) The pilot exhaust IP65 valves is common with main valve exhaust. (The standard valve has an individual exhaust for the pilot valve.)

Replacement Parts

One-touch Fitting Assembly (for Cylinder port)

Fitting size	C3	C4	C6	C8	C10	M5 (VQZ100 only)
VQZ100/200	VVQ1000-50A-C3	VVQ1000-50A-C4	VVQ1000-50A-C6	—	—	VVQ1000-50A-M5
VQZ300	—	—	VVQ1000-51A-C6	VVQ1000-51A-C8	VVQ1000-51A-C10	—

Note) Purchasing order is available in units of 10 pieces.

<Plug connector assembly>

DC: SY100-30-4A-

100 VAC: SY100-30-1A-

200 VAC: SY100-30-2A-

Other AC voltages: SY100-30-3A-

Without lead wire: SY100-30-A
(with connector and 2 sockets only)

Lead wire length

Symbol	Length
Nil	300 mm
6	600 mm
10	1000 mm
15	1500 mm
20	2000 mm
25	2500 mm
30	3000 mm
50	5000 mm

How to Order

Include the connector assembly part number together with the part number for the plug connector's solenoid valve without connector.

Example) In case of 2000 mm of lead wire

DC VQZ115-5LO1-M5-PR SY100-30-4A-20
AC VQZ115-1LO1-M5-PR SY100-30-1A-20

<Gasket and screw assembly>

Model	Part no.
VQZ100	VQZ100-GS-2
VQZ200	VQZ200-GS-2
VQZ300	VQZ300-GS-2

Note) Above part number consists of 10 units. Each unit has one gasket and two screws. Purchasing order is available in units of 10 pieces.

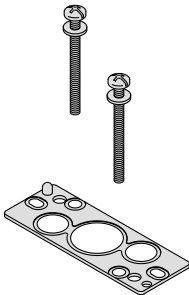

<Pilot valve assembly>

V111 — 5 G

Symbol	Specifications	DC	AC
Nil	Standard	(0.35 W) ○	○
B <small>Note)</small>	High speed response type (Applicable to VQZ200/300)	(0.9 W) ○	—
K <small>Note)</small>	High pressure type (Applicable to Metal seal type, Poppet seal type)	(0.9 W) ○	—

Note) Option

Manual override

Nil	None (Applicable to VQZ200/300)
M	Yes (Applicable to VQZ100)

Manual override (Applicable to the VQZ100)

Nil	Non-locking push type
B	Locking slotted type

Coil voltage

1	100 VAC (50/60 Hz)
2	200 VAC (50/60 Hz)
3	110 VAC (50/60 Hz)
4	220 VAC (50/60 Hz)
5	24 VDC
6	12 VDC

Electrical entry

Symbol	DC	AC	Electrical entry	Light/surge voltage suppressor
G	—	—	Grommet (DC specification)	None
LU LZ	—	—	L-type plug connector with lead wire	Yes
LOU LOZ	—	—	L-type plug connector without connector	
MU MZ	—	—	M-type plug connector with lead wire	
MOU MOZ	—	—	M-type plug connector without connector	

Note) VQZ pilot valve electrical entry (L, M) is the opposite of the how to order of valve body.

Valve model	Pilot valve model
VQZ115□-□L□1	V111□M-□M□
VQZ115□-□M□1	V111□M-□L□

<Bracket assembly>

Model	Part no.	Tightening torque (N·m) <small>Note)</small>
VQZ100	VQZ100-FB	0.45 to 0.55
VQZ200	VQZ200-FB	0.25 to 0.35
VQZ300	VQZ300-FB	0.25 to 0.35

Note) Tightening torque when mounting a bracket on the valve.

<DIN terminal type (Applicable to the VQZ200/300)>

V115 — 5 Y — X110

Symbol	Specifications	DC	AC
Nil	Standard	(0.35 W) ○	○
B <small>Note)</small>	High speed response type	(0.9 W) ○	—
K <small>Note)</small>	High pressure type (Metal seal type only)	(0.9 W) ○	—

Note) Option

Coil voltage

1	100 VAC (50/60 Hz)
2	200 VAC (50/60 Hz)
3	110 VAC (50/60 Hz)
4	220 VAC (50/60 Hz)
5	24 VDC
6	12 VDC

Electrical entry

Symbol	Electrical entry	Light/surge voltage suppressor
Y	DIN terminal	None
YO	DIN terminal without connector	
YZ	DIN terminal with light/surge voltage suppressor	Yes
YS <small>Note)</small>	DIN terminal with surge voltage suppressor (DC specification)	Yes (Without light)
YOS <small>Note)</small>	DIN terminal with surge voltage suppressor, without connector (DC specification)	

Note) For AC voltage valves there is no "S" option. It is already built-in to the rectifier circuit.

Caution

When replacing only the pilot valve assembly, use caution because it is not possible to convert to a V115 (DIN terminal) from a V111 (Grommet, L-type, M-type), or vice versa.