

### How to Order Valves

**VQ 2 1 4 0 Y 5 L C6**

**Series**  
2 VQ2000

**Type of actuation**

1 2 position single  
2 2 position double (latching)

**Coil voltage**

1	100 VAC (50/60 Hz)
2 Note)	200 VAC (50/60 Hz)
3	110 VAC (50/60 Hz)
4 Note)	220 VAC (50/60 Hz)
5	24 VDC
6	12 VDC

Note) The C kits is applicable to 200/220 VAC.

**Function**

Symbol	Specifications	DC	AC
Nil	Standard type	(1.0 W) ○	○ (1)
H (2)	High pressure type	(1.5 W) ○	—
Y (2)	Low wattage type	(0.5 W) ○	—

Note 1) For power consumption of AC type, refer to page 2-4-36.  
Note 2) Except double (latching).

**Electrical entry**

Symbol	Specifications
G:	Grommet C kit single only. (Except AC)
L:	L plug connector With lead wire
LO:	L plug connector Without connector
M:	M plug connector With lead wire
MO:	M plug connector Without connector

Note) LO and MO valves are used for F, P, T, and S kits. The plug connector and lead wire are attached to the manifold.

**Seal**

0	Metal seal
1	Rubber seal

**Cylinder port**

Symbol	Port size
C4	With One-touch fitting for ø4
C6	With One-touch fitting for ø6
C8	With One-touch fitting for ø8

Note) For inch-size One-touch fittings, refer to "Option" on page 2-4-69.

**Manual override**

Nil: Non-locking push type (Tool required)	B: Locking type (Tool required)	C: Locking type (Manual)
--	---------------------------------	--------------------------

Note) A manual override for pilot valve is provided to the standard model for double type.

Manual override body side  
Pilot valve Manual override

Note 1) For negative common specifications, refer to "Option" on page 2-4-69.  
Note 2) Connector assembly will be required when the F, P, T, S kits add a valve. For part nos., refer to "Option" on page 2-4-69.

VQC

SQ

VQ0

VQ4

VQ5

VQZ

VQD

### Manifold Option

P. 2-4-59

**Blanking plate assembly VVQ2000-10A-4**

**Name plate [-N4] VVQ2000-N4-Station (1 to Max. stations)**

**Silencer (For EXH port) AN200-KM8**

**Blanking plug KQ2P-06**

**Individual SUP spacer VVQ2000-P-4-C8**

**DIN rail mounting bracket VVQ2000-57A-4**

**Block valve VQ2 1/4 1 - □ - □ - □ - PR**

**Blocking indication label**

**Individual EXH spacer VVQ2000-R-4-C8**

**Built-in silencer, direct exhaust [-S]**

**Port plug VVQ1000-58A**

**Double check block VVQ2000-FPG-□□**

**How to Order Manifold Assembly**

**Example**

Single solenoid (24 VDC)  
VQ2140-5LO-C8 (4 sets)

Double solenoid (24 VDC)  
VQ2240-5LOB-C8 (4 sets)

D-sub connector cable  
AXT100 -DS25-030

F kit (D-sub connector)

Manifold base (8 stations)  
VV5Q24-08FU2-D

Individual EXH spacer port size C8: One-touch fitting for ø8

VV5Q24-08FU2-D ... 1 set (F kit 8 station manifold base no.)  
\*VQ2140-5LO-C6 ... 4 sets (Single solenoid part no.)  
\*VQ2240-5LOB-C6 ... 4 sets (Double solenoid part no.)

The asterisk denotes the symbol for assembly. Prefix it to the part nos. of the solenoid valve, etc.

Please indicate manifold base type, corresponding valve, and option parts. When entry of part numbers becomes complicated, indicate on the manifold specification sheet.

For replacement parts, refer to page 2-4-109.

# Series VQ0000/1000/2000

## Body Ported

# Plug Lead Unit: Flip Type

### Model

Series	Number of solenoids	Model		Flow characteristics						Response time <sup>(2)</sup> (ms)			Weight (g)		
				1 → 4/2 (P → A/B)			4/2 → 5/3 (A/B → R1/R2)			Standard: 1 W H: 1.5 W	Low wattage: 0.5 W	AC			
				C [dm <sup>3</sup> /(s·bar)]	b	Cv	C [dm <sup>3</sup> /(s·bar)]	b	Cv						
VQ0000	2 position	Single	Metal seal	VQ0140	0.43	0.20	0.10	0.50	0.19	0.12	12 or less	15 or less	29 or less	57	
			Rubber seal	VQ0141	0.49	0.34	0.13	0.59	0.19	0.14	15 or less	20 or less	34 or less		
		Double (Latching)	Metal seal	VQ0240	0.43	0.20	0.10	0.50	0.19	0.12	12 or less	15 or less	29 or less		
			Rubber seal	VQ0241	0.49	0.34	0.13	0.59	0.19	0.14	15 or less	20 or less	34 or less		
	3 position	Closed center	Metal seal	VQ0340	0.34	0.12	0.08	0.36	0.38	0.10	20 or less	26 or less	40 or less	105	
			Rubber seal	VQ0341	0.37	0.25	0.09	0.42	0.45	0.12	25 or less	33 or less	47 or less		
Exhaust center	Metal seal	VQ0440	0.36	0.21	0.09	0.48	0.18	0.12	20 or less	26 or less	40 or less				
	Rubber seal	VQ0441	0.37	0.31	0.11	0.59	0.24	0.14	25 or less	33 or less	47 or less				
VQ1000	2 position	Single	Metal seal	VQ1140	0.77	0.14	0.18	0.84	0.14	0.19	12 or less	15 or less	29 or less		57
			Rubber seal	VQ1141	0.91	0.19	0.21	1.0	0.21	0.25	15 or less	20 or less	34 or less		
		Double (Latching)	Metal seal	VQ1240	0.77	0.14	0.18	0.84	0.14	0.19	12 or less	15 or less	29 or less		
			Rubber seal	VQ1241	0.91	0.19	0.21	1.0	0.21	0.25	15 or less	20 or less	34 or less		
	3 position	Closed center	Metal seal	VQ1340	0.67	0.13	0.16	0.73	0.13	0.17	20 or less	26 or less	40 or less	72	
			Rubber seal	VQ1341	0.78	0.22	0.18	0.84	0.21	0.20	25 or less	33 or less	47 or less		
Exhaust center	Metal seal	VQ1440	0.74	0.14	0.17	0.84	0.16	0.20	20 or less	26 or less	40 or less				
	Rubber seal	VQ1441	0.78	0.28	0.19	1.0	0.21	0.24	25 or less	33 or less	47 or less				
Pressure center	Metal seal	VQ1540	0.74	0.14	0.17	0.82	0.18	0.20	20 or less	26 or less	40 or less				
	Rubber seal	VQ1541	0.80	0.28	0.19	0.84	0.21	0.22	25 or less	33 or less	47 or less				
VQ2000	2 position	Single	Metal seal	VQ2140	2.0	0.13	0.43	2.3	0.15	0.58	22 or less	29 or less	49 or less	103	
			Rubber seal	VQ2141	2.3	0.21	0.54	2.7	0.25	0.62	24 or less	31 or less	51 or less		
		Double (Latching)	Metal seal	VQ2240	2.0	0.13	0.43	2.3	0.15	0.58	22 or less	29 or less	49 or less		
			Rubber seal	VQ2241	2.3	0.21	0.54	2.7	0.25	0.62	24 or less	31 or less	51 or less		

Note 1) Cylinder port size C4: (VQ0000), C6: (VQ1000), C8: (VQ2000)

Note 2) As per JIS B 8375-1981 (Supply pressure: 0.5 MPa; with indicator light/surge voltage suppressor; clean air) Subject to the pressure and air quality.

### JIS Symbol

2 position single

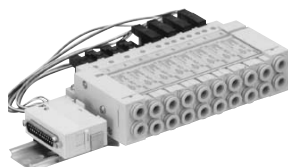
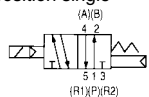

2 position double (Latching)

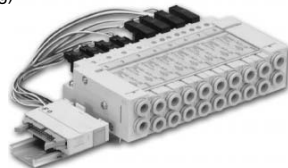
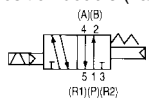

Metal seal

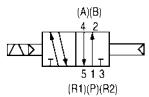

Rubber seal

3 position closed center

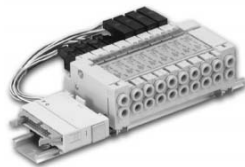
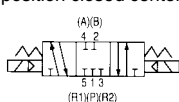

3 position exhaust center

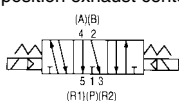

3 position pressure center

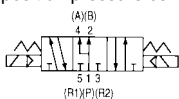

### Standard Specifications

Valve specifications	Valve construction	Metal seal	Rubber seal	
	Fluid	Air/Inert gas		Air/Inert gas
Maximum operating pressure	0.7 MPa (High pressure type: 0.8 MPa) <sup>(3)</sup>			
Min. operating pressure	Single	0.1 MPa	0.15 MPa	
	Double (Latching)	0.1 MPa	0.15 MPa	
	3 position	0.15 MPa	0.2 MPa	
Ambient and fluid temperature	-10 to 50°C <sup>(1)</sup>			
Lubrication	Not required			
Manual override	Push type/Locking type (Tool required, Manual type) Option			
Impact resistance/Vibration resistance <sup>(2)</sup>	150/30 m/s <sup>2</sup>			
Enclosure	Dust-protected			
Solenoid	Coil rated voltage	12, 24 VDC, 100, 110, 200, 220 VAC (50/60 Hz)		
	Allowable voltage fluctuation	±10% of rated voltage		
	Coil insulation type	Class B or equivalent		
	Power consumption (Current)	24 VDC	1 W DC (42 mA), 1.5 W DC (63 mA) <sup>(3)</sup> , 0.5 W DC (21 mA) <sup>(4)</sup>	
		12 VDC	1 W DC (83 mA), 1.5 W DC (125 mA) <sup>(3)</sup> , 0.5 W DC (42 mA) <sup>(4)</sup>	
		100 VAC	Inrush 0.5 VA (5 mA), Holding 0.5 VA (5 mA)	
		110 VAC	Inrush 0.55 VA (5 mA), Holding 0.55 VA (5 mA)	
200 VAC		Inrush 1.0 VA (5 mA), Holding 1.0 VA (5 mA)		
220 VAC	Inrush 1.1 VA (5 mA), Holding 1.1 VA (5 mA)			

Note 1) Use dry air to prevent condensation when operating at low temperatures.

Note 2) Impact resistance: No malfunction occurred when it is tested with a drop tester in the axial direction and at the right angles to the main valve and armature in both energized and de-energized states every once for each condition. (Values at the initial period)

Vibration resistance: No malfunction occurred in a one-sweep test between 45 and 2000 Hz. Test was performed at both energized and de-energized states in the axial direction and at the right angles to the main valve and armature. (Values at the initial period)

Note 3) Values in the case of high pressure type (1.5 W) specifications.

Note 4) Values in the case of low wattage type (0.5 W) specifications.

## ⚠ Precautions

Be sure to read before handling. For Safety Instructions and Solenoid Valve Precautions, refer to page 2-9-2.

### Light/Surge Voltage Suppressor

#### ⚠ Caution

The lighting positions are concentrated on one side for both single solenoid and double (latching) type. In the double (latching) type, A side and B side energization are indicated by two colors which match the colors of the manual overrides.

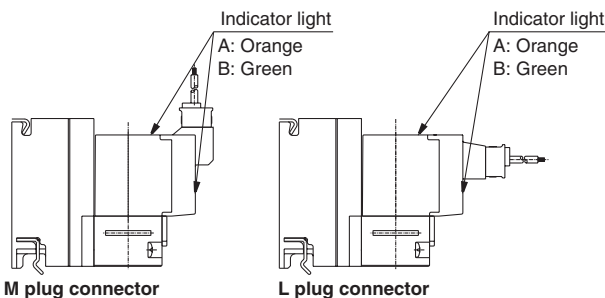
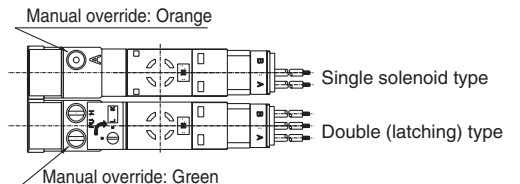

#### DC circuit diagram

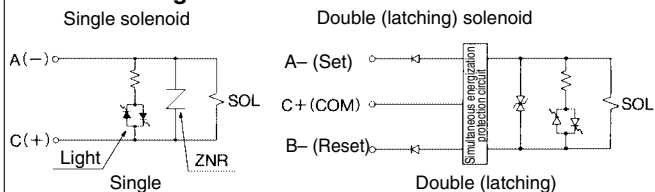

Note 1) • A-side energization: A light (orange) illuminates. Note 3) In the case of double  
• B-side energization: B light (green) illuminates. (latching), the electromagnetic  
• Equipped with a wiring error prevention (stop valve channel is, A-(set):  
diode) mechanism and a surge absorption (ZNR/surge absorption diode) mechanism. P → A, B → R,  
B-(reset):  
P → B, A → R.

Note 2) Applicable to negative COM specification models.

### Double (Latching solenoid) Type

#### ⚠ Caution

Different from the conventional double solenoid, the double type uses a latching (self-holding system) solenoid. Although the appearance is the same as the single solenoid, it is constructed so that the movable iron core in the solenoid is held in the ON position on A and B sides by instantaneous energization (20 ms or more). The usage and function is the same as the double solenoid.

#### <Special Cautions for Latching Solenoid>

1. Select the circuit in which ON and OFF signals are not energized simultaneously.
2. 20 ms energization time is necessary for self-holding.
3. Avoid using the latching solenoid valves in environments where impact or collisions with the valve might occur. Also, do not use in places where strong magnetic fields are present.
4. Even though the armature in the solenoid of this valve is held on to B side, ON position (Reset), verify either A side, ON position or B side, ON position by energizing prior to use.
5. After manual operation, the main valve will return to its original position. Manual override on the pilot valve side can retain its switching position after manipulation.
6. Please contact SMC for long-term energization applications.
7. If the metal seal type goes down below the minimum operating pressure of supply air (0.1 MPa or less), the main valve will get back the home position. (B side ON position) Therefore, in the event of shutting the supply air or applying the air with being A side ON position remained, cylinder may be pulsated. In the event of manipulating the supply air, the valve's switching position has to be set in the home position side (B side ON position side).

### How to Mount/Remove Solenoid Valve

#### ⚠ Caution

##### <Procedure>

##### How to Remove

1. Loosen tie-rod bolt B. (Two to four turns)
2. After fully loosening the tie-rod bolt, take off bolt A upward as shown above.
3. Slide the valves aside to make a 1 mm clearance between the valve to be taken off and the others. As shown above, remove the whole valve while holding up the (a) side. (Avoid rough handling of the connector.)

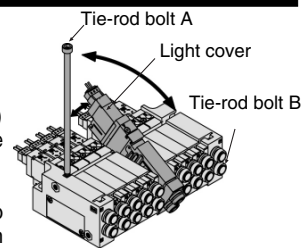

##### Mounting

Reverse the sequence of steps above to remount.

Tighten the tie-rod bolts with the tightening torque at the right table while using caution not to tighten the only one side unevenly.

Note) Be careful not to push on the light cover while mounting/removing the valve.

#### Torque Applied to Tie-rod Bolt

Model	Torque
VQ0000	0.5 to 0.7 N·m
VQ1000	1.0 to 1.4 N·m
VQ2000	1.0 to 1.4 N·m

### Double (Latching solenoid) Type

#### ⚠ Warning

Without an electric signal for the solenoid valve the manual override is used for switching the main valve.

##### ■ Push type (Tool required)

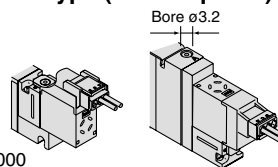

Push down on the manual override button with a small screwdriver until it stops. Release the screwdriver and the manual override will return.

##### ■ Locking slotted type

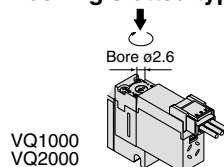

If the manual override is turned by 180° clockwise and the ► mark is adjusted to 1, then pushed in the direction of an arrow (↓), it will be locked in the ON state. If the manual override is turned by 180° counterclockwise and ► mark is adjusted to 0, locking will be released and the manual override will return.

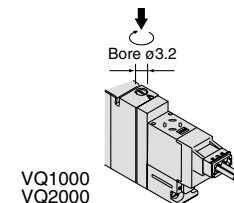

Push down completely on the manual override button with a small screwdriver. While down, turn clockwise 90° to lock it. Turn it counterclockwise to release it.

##### ■ Locking lever type (Option)

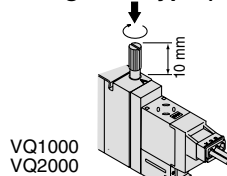

Push down completely on the manual override button with a small screwdriver. While down, turn clockwise 90° to lock it. Turn it counterclockwise to release it.

##### ■ Manual override for double (latching) type

In the case of a double (latching) type, a manual override is provided not only on the body side but to the pilot as a standard. (VQ0000: Pilot valve only). After manual operation, the main valve of the manual on the body side returns to the position before the manual operation, however, the pilot valve manual override maintains the change-over position.

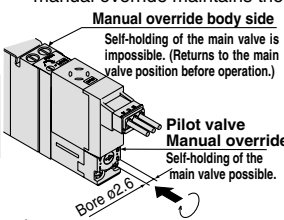

• If the manual override is turned by 180° clockwise and the ► mark is adjusted to A, then pushed in the direction of an arrow (◀), it will be back to the reset condition. (passage P → A)

• If the manual override is turned by 180° counterclockwise and the ► mark is adjusted to B, then pushed in the direction of an arrow (▶), it will be back to the reset condition. (passage P → B) (It is in the reset state at the time of shipment.)

#### ⚠ Caution

Do not apply excessive torque when turning the locking type manual override. (0.1 N·m or less)

# Plug Lead Unit: Flip Type Series VQ0000/1000/2000

## Replacement of Cylinder Port Fittings

### ⚠ Caution

The cylinder port fittings are a cassette for easy replacement. (Except VQ1000)

The fittings are blocked by a clip inserted from the top of the valve. Remove the clip with a screwdriver to remove fittings. For replacement, insert the fitting assembly until it strikes against the inside wall and then re-insert the clip to the specified position.

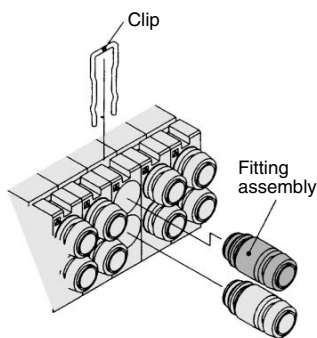

Applicable tubing O.D	Fitting assembly part no.	
	VQ1000	VQ2000
Applicable tubing ø3.2	VVQ1000-50A-C3	—
Applicable tubing ø4	VVQ1000-50A-C4	VVQ1000-51A-C4
Applicable tubing ø6	VVQ1000-50A-C6	VVQ1000-51A-C6
Applicable tubing ø8	—	VVQ1000-51A-C8

Purchasing order is available in units of 10 pieces.

### Caution

1. Protect O-rings from scratches and dust to prevent air leakage.
2. The tightening torque for inserting fittings to the M5 thread assembly should be 0.8 to 1.4 N·m

## Mounting/Removing from the DIN Rail

### ⚠ Caution

<Procedure>

#### How to Remove

1. Loosen the clamp screw on side (a) of the end plate on both sides.
2. Lift side (a) of the manifold base and slide the end plate in the direction of (2) shown in the figure to remove.

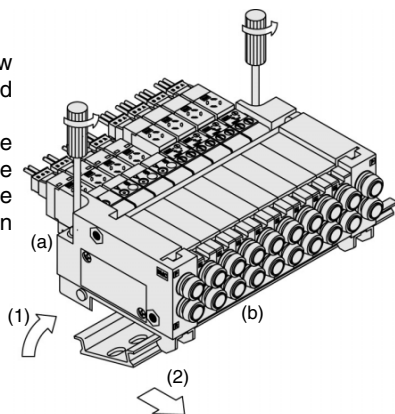

#### Mounting

1. Hook side (b) of the manifold base on the DIN rail.
2. Press down side (a) and mount the end plate on the DIN rail. Tighten the clamp screw on side (a) of the end plate. The proper tightening torque for screws is 0.4 to 0.6 N·m.

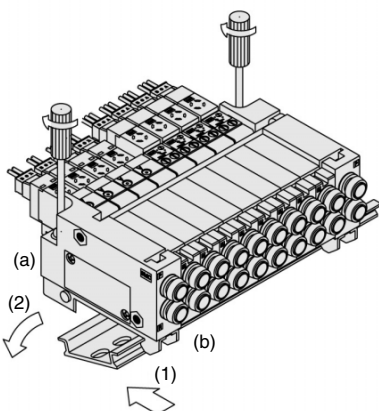

## How to Calculate the Flow Rate

For obtaining the flow rate, refer to pages 2-1-8 to 2-1-11.

## Built-in Silencer Replacement Element

### ⚠ Caution

A silencer element is incorporated in the end plate on both sides of the manifold base. A dirty and choked element may reduce cylinder speed or cause malfunction. Clean or replace the dirty element.

#### Element Part No.

Type	Element part no.		
	VQ0000	VQ1000	VQ2000
Built-in silencer, direct exhaust (-S)	VVQ0000-82A-4	VVQ1000-82A-4	VVQ2000-82A-4

\* The minimum order quantity is 10 pcs.

Remove the cover from the side of the end plate and remove the old element with a screwdriver, etc.

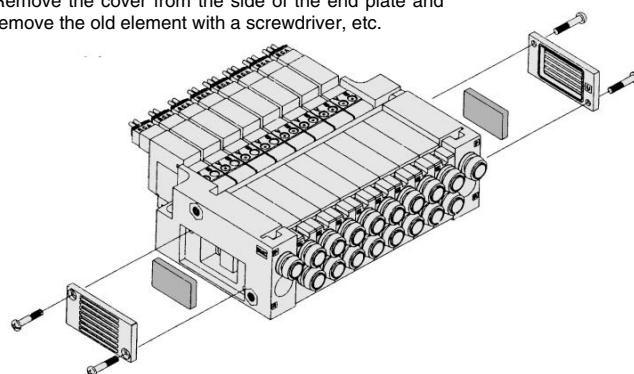

## How to Use Plug Connector

### ⚠ Caution

#### Attaching and detaching connectors

To attach a connector, hold the lever and connector unit between your fingers and insert straight onto the pins of the solenoid valve so that the lever's pawl is pushed into the groove and locks.

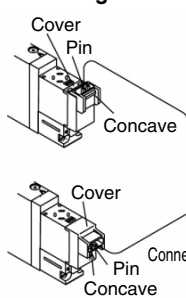

DC indicator Socket Part no. DXT170-71-1  
Lead wire 0.2 to 0.33 mm<sup>2</sup>  
(Max. cover diameter ø1.7 mm)

To detach a connector, remove the pawl from the groove by pushing the lever downward with your thumb, and pull the connector straight out.

#### Crimping the lead wire and socket

Peel 3.2 to 3.7 mm of the tip of lead wire, enter the core wires and press contact it by a press tool. Be careful so that the cover of lead wire does not enter into the core contacting part.

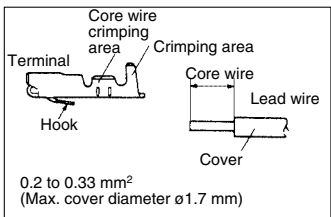

#### Attaching and detaching lead wires with sockets

##### Attaching

Insert a socket in the square hole (Indicated as +, -) of connector, push in the lead wire and lock by hanging the hook of socket to the seat of connector. (Pushing-in can open the hook and lock it automatically.) Then confirm the lock by lightly pulling on the lead wire.

##### Detaching

To detach a socket from a connector, pull out the lead wire while pressing the socket's hook with a stick having a thin tip (approx. 1 mm). If the socket will be used again, first spread the hook outward.

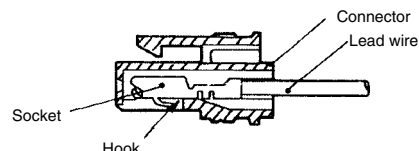

### Special Wiring Specifications

In the internal wiring of F kit, P kit, T kit and S kit, double wiring (connected to SOL. A and SOL. B) is adopted for each station regardless of the valve and option types.

Mixed single and double wiring is available as an option.

#### 1. How to order valves

Indicate an option symbol, -K, for the manifold no. and be sure to specify the mounting position and number of stations of the single and double wiring by means of the manifold specification sheet.

Example)

**VV5Q14-09FS0-D K S**



Others, option symbols: to be indicated alphabetically.

#### 2. Wiring specifications

Connector terminal numbers are connected from solenoid station 1 on the A side in the order indicated by the arrows without skipping any terminal numbers.

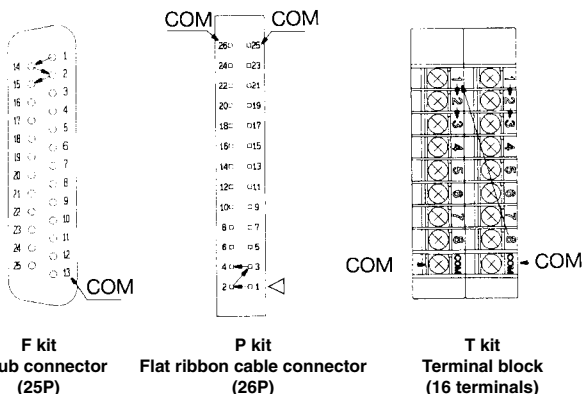

#### 3. Max. number of stations

The maximum number of stations depends upon the number of solenoids. Assuming one for a single and two for a double, determine the number of stations so that the total number is not more than the maximum number given in the following table.

kit	F kit (D-sub connector)		P kit (Flat ribbon cable connector)				T kit (Terminal block)		S kit (Serial)
Type	F □ 25P	F □ A 15P	P □ 26P	P □ C 20P	P □ B 16P	P □ A 10P	T1	T2	S □
Max. points	Note) 16	14	Note) 16	Note) 16	14	8	8	16	16

Note) Due to the limitation of internal wiring.

### Negative Common Specifications

Specify the valve model no. as shown below for negative COM specification. The standard manifold no. can be used. Please contact SMC for negative COM S kit.

#### How to order negative COM valves

**VQ1140 N-5LO-C6**

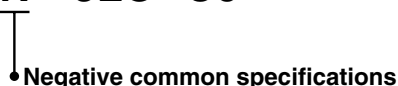

### Inch-size One-touch Fittings

Refer to following model no. for inch-size One-touch fittings.

#### How to order manifold

**VV5Q14-08FS0-DN-00T**

P, R port size

VQ0000	ø1/4"
VQ1000	ø1/4"
VQ2000	ø5/16"

#### How to order valves

**VQ1140-5M-N7**

Cylinder port

Symbol	N1	N3	N7	N9
Applicable tubing O.D. (Inch)	ø1/8"	ø5/32"	ø1/4"	ø5/16"
A, B port	VQ0000	○	○	—
	VQ1000	—	○	○
	VQ2000	—	○	○

### Plug Connector Assembly Model

Connector assembly will be required when the F, P, T, S kits add a valve.

Specify the type of valve and connector assembly.

#### Connector Assembly Part No.

Specifications		Part no.
Single (2-wire)	Positive common	AXT661-14A-F
	Negative common	AXT661-14AN-F
Double (latching) (3-wire)	Positive common	AXT661-13A-F
	Negative common	AXT661-13AN-F

Note) Lead wire length: 300 mm

Note) The parts numbers above are applicable to VQ0000/1000 (2 to 16 stations) and VQ2000 (2 to 10 stations). VQ2000 (11 to 16 stations) uses AXT661-13A(N)-F425.

VQC

SQ

VQ0

VQ4

VQ5

VQZ

VQD

**Construction: VQ0000, 1000, 2000/Plug Lead Unit, Flip Type**

**Metal seal**  
**VQ0000**

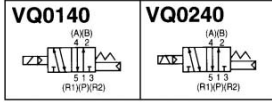
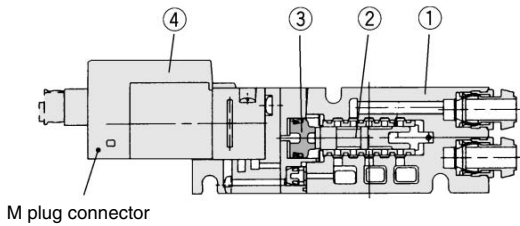

**Rubber seal**  
**VQ0000**

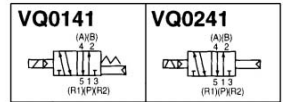
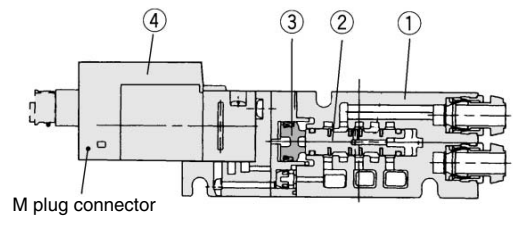

**VQ1000**  
**Single/Double (Latching)**

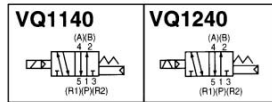
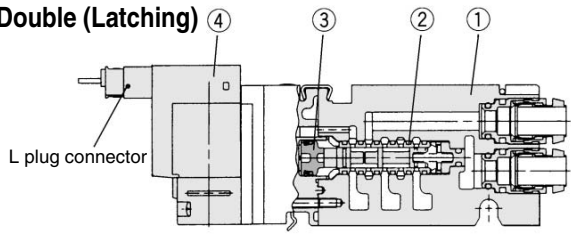

**VQ1000**  
**Single/Double (Latching)**

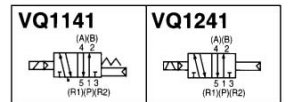
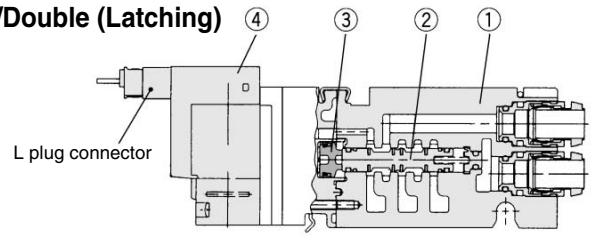

**3 position**

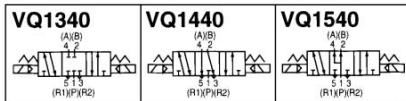
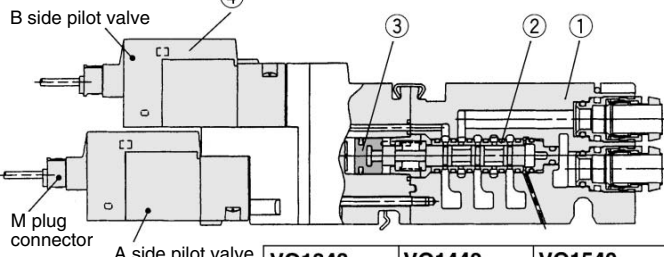

**3 position**

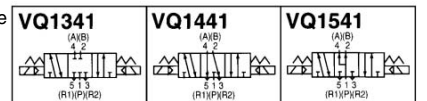
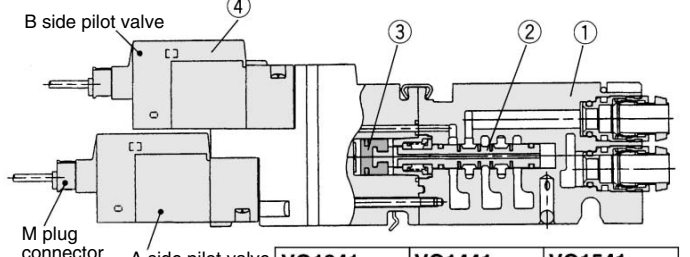

**VQ2000**

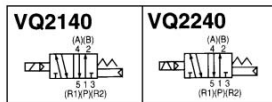
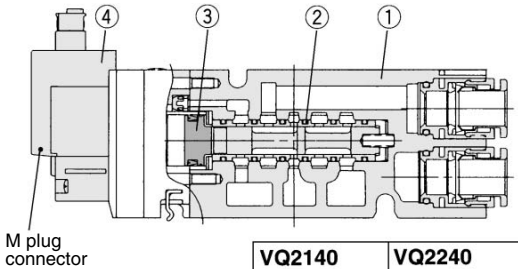

**VQ2000**

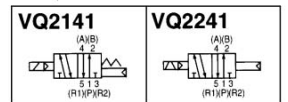
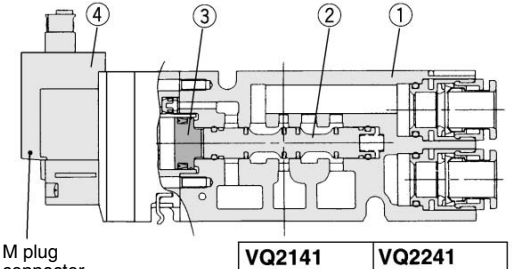

**Component Parts**

No.	Description	Material	Note
①	Body	Aluminum die-casted	
②	Spool/Sleeve	Stainless steel	
③	Piston	Resin	

**④ Pilot valve assembly**

Single 3 position (VQ1000)	VQ111 <small>Note</small> (H) L Nil (VQ0000) (Y) M -2 (VQ1000) (G) 3 (VQ2000) Voltage 1 to 6 <small>0: VQ0000</small> <small>1: VQ1000, VQ2000</small>	
Double (Latching)	VQ110L <small>Note</small> L Nil (VQ0000) M -2 (VQ1000) 3 (VQ2000) Voltage 1 to 6	
3 position (VQ1000)	VQ111 <small>Note</small> (H) L Nil (VQ0000) (Y) M -2 (VQ1000) (G) Nil (B side (Top side)) Voltage 1 to 6	The direction of the L and M connectors of a pilot valve is opposite to that of the single and double type.

Note 1) (H): 1.5 W, (Y): 0.5 W, G type: DC only

**Component Parts**

No.	Description	Material	Note
①	Body	Aluminum die-casted	
②	Spool valve	Aluminum/HNBR	
③	Piston	Resin	

**④ Pilot valve assembly**

Single 3 position (VQ1000)	VQ111 <small>Note</small> (H) L Nil (VQ0000) (Y) M -2 (VQ1000) (G) 3 (VQ2000) Voltage 1 to 6 <small>0: VQ0000</small> <small>1: VQ1000, VQ2000</small>	
Double (Latching)	VQ110L <small>Note</small> L Nil (VQ0000) M -2 (VQ1000) 3 (VQ2000) Voltage 1 to 6	
3 position (VQ1000)	VQ111 <small>Note</small> (H) L Nil (VQ0000) (Y) M -2 (VQ1000) (G) Nil (B side (Top side)) Voltage 1 to 6	The direction of the L and M connectors of a pilot valve is opposite to that of the single and double type.

Note 1) (H): 1.5 W, (Y): 0.5 W, G type: DC only