



Operation Manual

3 Port Direct Operated Solenoid Valve

PRODUCT NAME

VT307 Series

MODEL/ Series

SMC Corporation

Contents

Safety Instructions	2,3
Precautions on Design / Selection	4,5
Mounting	5
Piping	5
Wiring	5
Lubrication	5
Air Supply	6
Operating Environment	6
Maintenance	6
Specific Product Precautions	7,8
Troubleshooting	9
Remedy	10



Safety Instructions

These safety instructions are intended to prevent hazardous situations and/or equipment damage. These instructions indicate the level of potential hazard with the labels of “Caution,” “Warning” or “Danger.” They are all important notes for safety and must be followed in addition to International Standards (ISO/IEC)*1), and other safety regulations.

*1) ISO 4414: Pneumatic fluid power -- General rules relating to systems
ISO 4413: Hydraulic fluid power -- General rules relating to systems
IEC 60204-1: Safety of machinery -- Electrical equipment of machines (Part 1: General requirements)
ISO 10218-1992: Manipulating industrial robots -Safety.
etc.



Caution

Caution indicates a hazard with a low level of risk which, if not avoided, could result in minor or moderate injury.



Warning

Warning indicates a hazard with a medium level of risk which, if not avoided, could result in death or serious injury.



Danger

Danger indicates a hazard with a high level of risk which, if not avoided, will result in death or serious injury.

Warning

1. The compatibility of the product is the responsibility of the person who designs the equipment or decides its specifications.

Since the product specified here is used under various operating conditions, its compatibility with specific equipment must be decided by the person who designs the equipment or decides its specifications based on necessary analysis and test results.

The expected performance and safety assurance of the equipment will be the responsibility of the person who has determined its compatibility with the product.

This person should also continuously review all specifications of the product referring to its latest catalog information, with a view to giving due consideration to any possibility of equipment failure when configuring the equipment.

2. Only personnel with appropriate training should operate machinery and equipment.

The product specified here may become unsafe if handled incorrectly.

The assembly, operation and maintenance of machines or equipment including our products must be performed by an operator who is appropriately trained and experienced.

3. Do not service or attempt to remove product and machinery/equipment until safety is confirmed.

1. The inspection and maintenance of machinery/equipment should only be performed after measures to prevent falling or runaway of the driven objects have been confirmed.

2. When the product is to be removed, confirm that the safety measures as mentioned above are implemented and the power from any appropriate source is cut, and read and understand the specific product precautions of all relevant products carefully.

3. Before machinery/equipment is restarted, take measures to prevent unexpected operation and malfunction.

4. Contact SMC beforehand and take special consideration of safety measures if the product is to be used in any of the following conditions.

1. Conditions and environments outside of the given specifications, or use outdoors or in a place exposed to direct sunlight.

2. Installation on equipment in conjunction with atomic energy, railways, air navigation, space, shipping, vehicles, military, medical treatment, combustion and recreation, or equipment in contact with food and beverages, emergency stop circuits, clutch and brake circuits in press applications, safety equipment or other applications unsuitable for the standard specifications described in the product catalog.

3. An application which could have negative effects on people, property, or animals requiring special safety analysis.

4. Use in an interlock circuit, which requires the provision of double interlock for possible failure by using a mechanical protective function, and periodical checks to confirm proper operation.



Safety Instructions

Caution

1. The product is provided for use in manufacturing industries.

The product herein described is basically provided for peaceful use in manufacturing industries. If considering using the product in other industries, consult SMC beforehand and exchange specifications or a contract if necessary.
If anything is unclear, contact your nearest sales branch.

Limited warranty and Disclaimer/Compliance Requirements

The product used is subject to the following “Limited warranty and Disclaimer” and “Compliance Requirements”.

Read and accept them before using the product.

Limited warranty and Disclaimer

1. The warranty period of the product is 1 year in service or 1.5 years after the product is delivered.*2)

Also, the product may have specified durability, running distance or replacement parts. Please consult your nearest sales branch.

2. For any failure or damage reported within the warranty period which is clearly our responsibility, a replacement product or necessary parts will be provided.

This limited warranty applies only to our product independently, and not to any other damage incurred due to the failure of the product.

3. Prior to using SMC products, please read and understand the warranty terms and disclaimers noted in the specified catalog for the particular products.

***2) Vacuum pads are excluded from this 1 year warranty.**

A vacuum pad is a consumable part, so it is warranted for a year after it is delivered. Also, even within the warranty period, the wear of a product due to the use of the vacuum pad or failure due to the deterioration of rubber material are not covered by the limited warranty.

Compliance Requirements

1. The use of SMC products with production equipment for the manufacture of weapons of mass destruction (WMD) or any other weapon is strictly prohibited.

2. The exports of SMC products or technology from one country to another are governed by the relevant security laws and regulation of the countries involved in the transaction. Prior to the shipment of a SMC product to another country, assure that all local rules governing that export are known and followed.



Precautions for 3 Port Solenoid Valve ①

Be sure to read before handling.

Design / Selection

Warning

1. Confirm the specifications.

Products represented in this manual are designed only for use in compressed air systems (including vacuum).

Do not operate at pressures or temperatures, etc., beyond the range of specifications, as this can cause damage or malfunction. (Refer to the specifications.)

Please contact SMC when using a fluid other than compressed air (including vacuum).

We do not guarantee against any damage if the product is used outside of the specification range.

2. Actuator drive

When an actuator, such as a cylinder, is to be driven using a valve, take appropriate measures (cover installation or approach prohibition) to prevent potential danger caused by actuator operation.

3. Effect of back pressure when using a manifold

Use caution when valves are used on a manifold, because an actuator may malfunction due to back-pressure.

For single acting cylinder, take appropriate measures to prevent malfunction by using it with an individual exhaust manifold.

4. Holding pressure (including vacuum)

Since the valves are subject to air leakage, they cannot be used for applications such as holding pressure (including vacuum) in a pressure vessel.

5. Not suitable for use as an emergency shutoff valve, etc.

The valves listed in this manual are not designed for safety applications such as an emergency shutoff valve. If the valves are used for the mentioned applications, additional safety measures should be adopted.

6. Release of residual pressure

For maintenance purposes install a system for releasing residual pressure.

7. Operation in a vacuum condition

When a valve is used for switching a vacuum, take measures to install a suction filter or similar to prevent external dust or other foreign matter from entering inside the valve. In addition, at the time of vacuum adsorption, be sure to vacuum at all times. Failure to do so may result in foreign matter sticking to the adsorption pad, or air leakage causing the workpiece to drop.

8. Regarding a vacuum switch valve and a vacuum release valve

If a non-vacuum valve is installed in the middle of piping system having a vacuum, the vacuum condition will not be maintained. Use a valve designed for use under vacuum condition.

9. Ventilation

Provide ventilation when using a valve in a confined area, such as in a closed control panel. For example, install a ventilation opening, etc. in order to prevent pressure from increasing inside of the confined area.

10. Extended periods of continuous energization

If a valve will be continuously energized for an extended period of time, the temperature of the valve will increase due to the heat generated by the coil. This will likely adversely affect the performance of the solenoid valve and any nearby peripheral equipment. Therefore, when it is continuously energized or the energized period per day is longer than the de-energized period use low power consumption specification, or continuous energization type..

Also, please contact SMC because depending on the application, there may be additional valves not mentioned above that may be used (especially in DC specification).

In addition, it is possible to shorten the energized time by making a valve with an N.O. (normally open) specification.

If valves are mounted on a control panel, please take measures to release heat so that the temperature would fall within the temperature specified for the valve.

Please note in particular that the temperature rise will be large if three or more adjoining valves are continuously energised on a manifold at the same time for an extended period of time.

11. Do not disassemble the product or make any modifications, including additional machining.

It may cause human injury and/or an accident.

Caution

1. Leakage voltage

Take note that the leakage voltage will increase when a resistor is used in parallel with switching element or a C-R circuit (surge voltage suppressor) is used for protecting a switching device because of the passing leakage voltage through the C-R circuit.

The suppressor residual leakage voltage should be as follows.

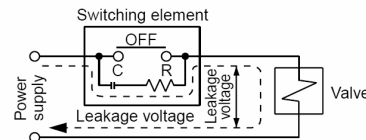

DC coil 3% or less of rated voltage

AC coil 15% or less of rated voltage

2. Solenoid valve drive for AC with solid state output (SSR, TRIAC output, etc.)

1) Current leakage

When using a snubber circuit (C-R element) for surge protection of the output, a very small amount of electrical current will continue to flow even during the OFF state. This results in the valve not returning. In the a situation where the tolerance is exceeded, as in the above case, take measures to install a bleeder resistor.

2) Minimum allowable load amount (Min. load current)

When the consumption current of a valve is less than the output's minimum allowable load volume or the margin is small, the output may not switch normally. Please contact SMC.

3. Surge voltage suppressor

If a surge protection circuit contains nonstandard diodes, such as Zener diodes or varistor, a residual voltage that is in proportion to the protective circuit and the rated voltage will remain. Therefore, take into consideration the surge voltage protection of the controller. In the case of diodes, the residual voltage is approximately 1 V.



VT307 Series

Precautions for 3 Port Solenoid Valve ②

Be sure to read before handling.

Design / Selection

⚠ Caution

4. Operation in a low temperature condition

It is possible to operate a valve in extreme temperature, as low as -10°C. Take appropriate measures to avoid freezing of drainage, moisture etc. in low temperature.

5. Mounting orientation

Mounting orientation is free.

Mounting

⚠ Warning

1. Operation manual

Install the products and operate them only after reading the operation manual carefully and understanding its contents. Also, keep the manual where it can be referred to as necessary.

2. Ensure sufficient space for maintenance activities.

When installing the products, allow access for maintenance.

3. Tighten threads with the proper tightening torque.

When installing the products, follow the listed torque specifications.

4. If air leakage increases or equipment does not operate properly, stop operation.

Check mounting conditions when air and power supplies are connected. Initial function and leakage tests should be performed after installation.

5. Painting and coating

Warnings or specifications printed or affixed to the product should not be erased, removed or covered up.

Please consult with SMC before applying paint to resinous parts, as this may have an adverse effect due to the solvent in the paint.

Piping

⚠ Caution

1. Preparation before piping

Before piping is connected, it should be thoroughly blown out with air (flushing) or washed to remove chips, cutting oil and other debris from inside the pipe.

2. Wrapping of pipe tape

When screwing piping or fittings into ports, ensure that chips from the pipe threads or sealing material do not enter the piping. Also, if pipe tape is used, leave 1 thread ridges exposed at the end of the threads.

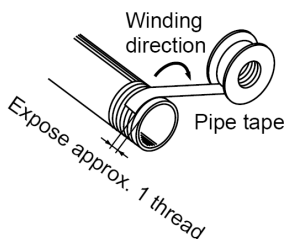

3. Connection of fittings

When screwing fittings into valves, tighten as follows.

Tightening Torque for Piping

Connection thread	Proper tightening torque (N·m)
Rc 1/8	7~9
Rc 1/4	12~14

4. Piping to products

When piping to a product, refer to the instruction manual to avoid mistakes regarding the supply port, etc.

Wiring

⚠ Caution

1. Preparation before piping

When connecting power to a solenoid valve with a DC specification and equipped with a light or surge voltage suppressor, check for polarity.

If a mistake is made regarding the polarity, Valve is not operated.

2. Applied voltage

When electric power is connected to a solenoid valve, be careful to apply the proper voltage. Improper voltage may cause malfunction or coil damage.

3. Check the connections.

Check if the connections are correct after completing all wiring.

Lubrication

⚠ Warning

Lubrication

- 1) The valve has been lubricated for life by the factory and does not require any further.
- 2) If a lubricant is used in the system, use class 1 turbine oil (no additive), ISO VG32.

Once a lubricant is used in the system, lubrication must be continued because the original lubricant applied during manufacturing will be washed away.

If turbine oil is used, refer to the Material Safety Data Sheet (MSDS) of the oil.



Precautions for 3 Port Solenoid Valve ③

Be sure to read before handling.

Air Supply

Warning

1. Type of fluids

Please consult with SMC when using the product in applications other than compressed air.

2. When there is a large amount of drainage.

Compressed air containing a large amount of drainage can cause malfunction of pneumatic equipment. An air dryer or water separator should be installed upstream from filters.

3. Drain flushing

If condensation in the drain bowl is not emptied on a regular basis, the bowl will overflow and allow the condensation to enter the compressed air lines. It causes malfunction of pneumatic equipment.

If the drain bowl is difficult to check and remove, installation of a drain bowl with an auto drain option is recommended.

For compressed air quality, refer to SMC's Best Pneumatics catalog.

4. Use clean air.

Do not use compressed air that contains chemicals, synthetic oils including organic solvents, salt or corrosive gases, etc., as it can cause damage or malfunction.

Caution

1. When extremely dry air is used as the fluid, degradation of the lubrication properties in side the equipment may occur, resulting in reduced reliability (or reduced service life) of the equipment. Please consult with SMC.

2. Install an air filter.

Install an air filter upstream near the valve. Select an air filter with a filtration size of 5 μm or smaller.

3. Take measures to ensure air quality, such as by installing an aftercooler, air dryer, or water separator.

Compressed air that contains a large amount of drainage can cause malfunction of pneumatic equipment such as valves. Therefore, take appropriate measures to ensure air quality, such as by providing an aftercooler, air dryer, or water separator.

4. If excessive carbon powder is seen, install a mist separator on the upstream side of the valve.

If excessive carbon dust is generated by the compressor, it may adhere to the inside of a valve and cause it to malfunction.

For compressed air quality, refer to SMC's Best Pneumatics catalog.

Operating Environment

Warning

1. Do not use in an atmosphere having corrosive gases, chemicals, sea water, water, water steam, or where there is direct contact with any of these .
2. Do not use in an environment where flammable gas or explosive gas exists. Usage may cause a fire or explosion. The products do not have an explosion proof construction.

3. Do not use in a place subject to heavy vibration and/or shock.
4. The valve should not be exposed to prolonged sunlight. Use a protective cover.
5. Remove any sources of excessive heat.
6. If it is used in an environment where there is possible contact with a waterdrop, oil, weld spatter, etc., exercise preventive measures.
7. When the solenoid valve is mounted in a control panel or its energized for a long time, make sure ambient temperatures is within the specification of the valve.

Maintenance

Warning

1. Perform maintenance inspection according to the procedures indicated in the operation manual.

If handled improperly, malfunction and damage of machinery or equipment may occur.

2. Removal of equipment, and supply/exhaust of compressed air

When components are removed, first confirm that measures are in place to prevent workpieces from dropping, run-away equipment, etc. Then, cut off the supply pressure and electric power, and exhaust all compressed air from the system using the residual pressure release function.

When the equipment is operated after remounting or replacement, first confirm that measures are in place to prevent lurching of actuators, etc. Then, confirm that the equipment is operating normally.

3. Low frequency operation

Valves should be operated at least once every 30 days to prevent malfunction. (Use caution regarding the air supply.)

4. Manual override operation

When the manual override is operated, connected equipment will be actuated.

Operate after safety is confirmed.

Caution

1. Drain flushing

Remove drainage from the air filters regularly.

2. Lubrication

In the case of rubber seals, once lubrication has been started, it must be continued.

Use class 1 turbine oil (with no additive), ISO VG32 because if other lubricant oil is used, it may cause malfunction.



VT307 Series

Specific Product Precautions ①

Be sure to read before handling.

How to Use DIN Terminal

1. Disassembly

- 1) After loosening the thread (1), then if the housing (2) is pulled in the direction of the thread, the connector will be removed from the body equipment (solenoid, etc.).
- 2) Pull the screw (1) out of the housing (2).
- 3) On the bottom part of the terminal block (3), there's a cut-off part (9). If a small flat head screwdriver is inserted between the opening in the bottom, terminal block (3) will be removed from the housing (2). (Refer to "Figure 1".)
- 4) Remove the cable gland (4) and plain washer (5) and rubber seal (6).

2. Wiring

- 1) Passing through the cable (7), cable gland (4), plain washer (5), rubber seal (6) in this order, and then insert into the housing (2).
- 2) From the terminal block (3), loosen the screw (11), then pass the lead wire (10) through, then again tighten the screw (11).

Note 1) Tighten within the tightening torque of 0.5 N·m±15%.

Note 2) Cable (7) external; $\phi 6$ to $\phi 8$ mm

Note 3) Crimped terminal like round-shape or Y shape cannot be used.

3. Assembly

- 1) Passing cable gland (4), washer (5), rubber seal (6), housing (2) in this order through cable (7) and connect to terminal block (3) to the housing (2).
(Push it down until you hear the click sound.)
- 2) Putting rubber seal (6), plain washer (5), in this order into the cable introducing slit on the housing (2), then further tighten the cable gland (4) securely.
- 3) Insert the gasket (8) between the bottom part of terminal block (3) and a plug attached to equipment, and then screw (1) in from the top of the housing (2) to tighten it.

Note 1) Tighten within the tightening torque of 0.5 N·m±15%.

Note 2) Connector orientation can be changed by 180 degrees depending on how to assemble the housing (2) and the terminal block (3).

Connector for DIN Terminal

Description	Part no.
DIN connector	B1B09-2A

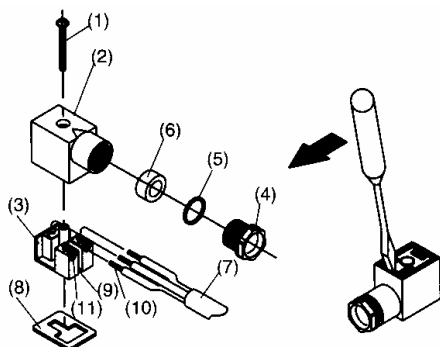

Light/Surge Voltage Suppressor

⚠ Caution

AC, 100VDC or more

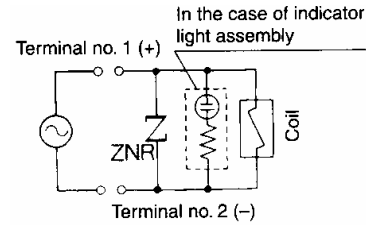

48 VDC or less

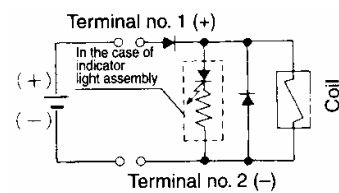

Electrical Connection

⚠ Caution

Din terminal and terminal (with light/surge voltage suppressor) are connected inside as in the figure below. Connect to the corresponding power supply.

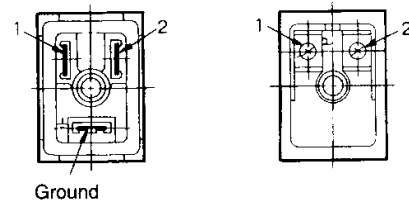

Terminal no.	1	2
DIN terminal	+	-
Terminal	+	-

• Applicable cable O.D.

Type T: $\phi 4.5$ to $\phi 7$ mm

Type E: $\phi 2.3$ to $\phi 2.8$ mm

Type D: $\phi 6$ to $\phi 8$ mm

• Applicable crimp terminal

Type E/T: 1.25-3, 1.25-3S

1.25Y-3N, 1.25Y-3S

(Round or "Y" shaped crimped terminals can be not used for type "D".)

Lead Wire Color

Voltage	Color
100 VAC	Blue
200 VAC	Red
DC	Red (+), Black (-)
Other	Gray



Specific Product Precautions ②

Be sure to read before handling.

Continuous On Time

⚠ Caution

On the standard and low power consumption types, when the valve is to be continuously energized, ensure that it is operated for no more than 1,400 hours (equivalent to approx. 2 months) in a year. Provide at least one operation every 30 days.

In applications where the operating time exceeds 1,400 hours, select the long-time energizing type which has specifically been designed for long time operation. It should be noted, however, that even with this type, the operation must be switched over at least once a month. Consult us for use with special application such as emergency circuit breaker.

Vacuum Specifications

⚠ Caution

For vacuum specifications, use Model VT307V. In applications where the valve is used in a dusty place, install a filter between the vacuum cup, where used on the R port, and the valve. It should be noted that this valve is not for vacuum retention.

Manifold

⚠ Caution

1. Each valve is fixed to the manifold base with two M4 mounting screws. Tighten the screws evenly when re-mounting.
2. For mounting, tighten M4 or equivalent screws evenly into the mounting holes of the manifold base.
Tightening torque of the mounting screw(M4): 1.4N·m

⚠ Warning

1. Use caution when valves are used on a manifold, because an actuator may malfunction due to back-pressure.
Take appropriate measures to prevent malfunction by using it with an individual exhaust manifold.
2. When mounting a valve on the manifold base, N.C. and N.O. can be reversed by a function plate orientation. Also, since cylinder also acts reversely, confirm if the function plate is correctly mounted or not.

N.C. specifications N.O. specifications

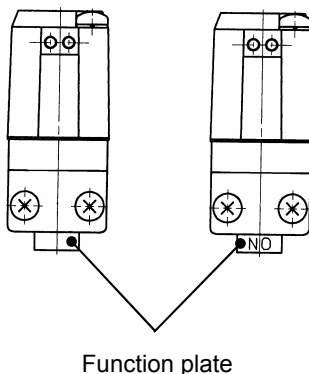

Changing from N.C. to N.O

⚠ Caution

This product is delivered as N.C. valve. If N.O. valve is needed, remove mounting screws of the required valve and turn over the function plate. (Make sure that there are gaskets on both sides of the plate.) Then, tighten the mounting screws to fix the valve to the manifold base.

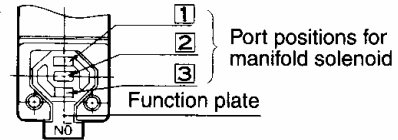

Figure: For N.C.

Specifications	Function plate
N.C.	No mark
N.O.	NO

Port Direction

⚠ Caution

For the common exhaust type, pressurization or evacuation of the R port can cause a malfunction.

TROUBLESHOOTING

Should any trouble be found during operation, trace the source of the trouble in the following order and take corrective action.

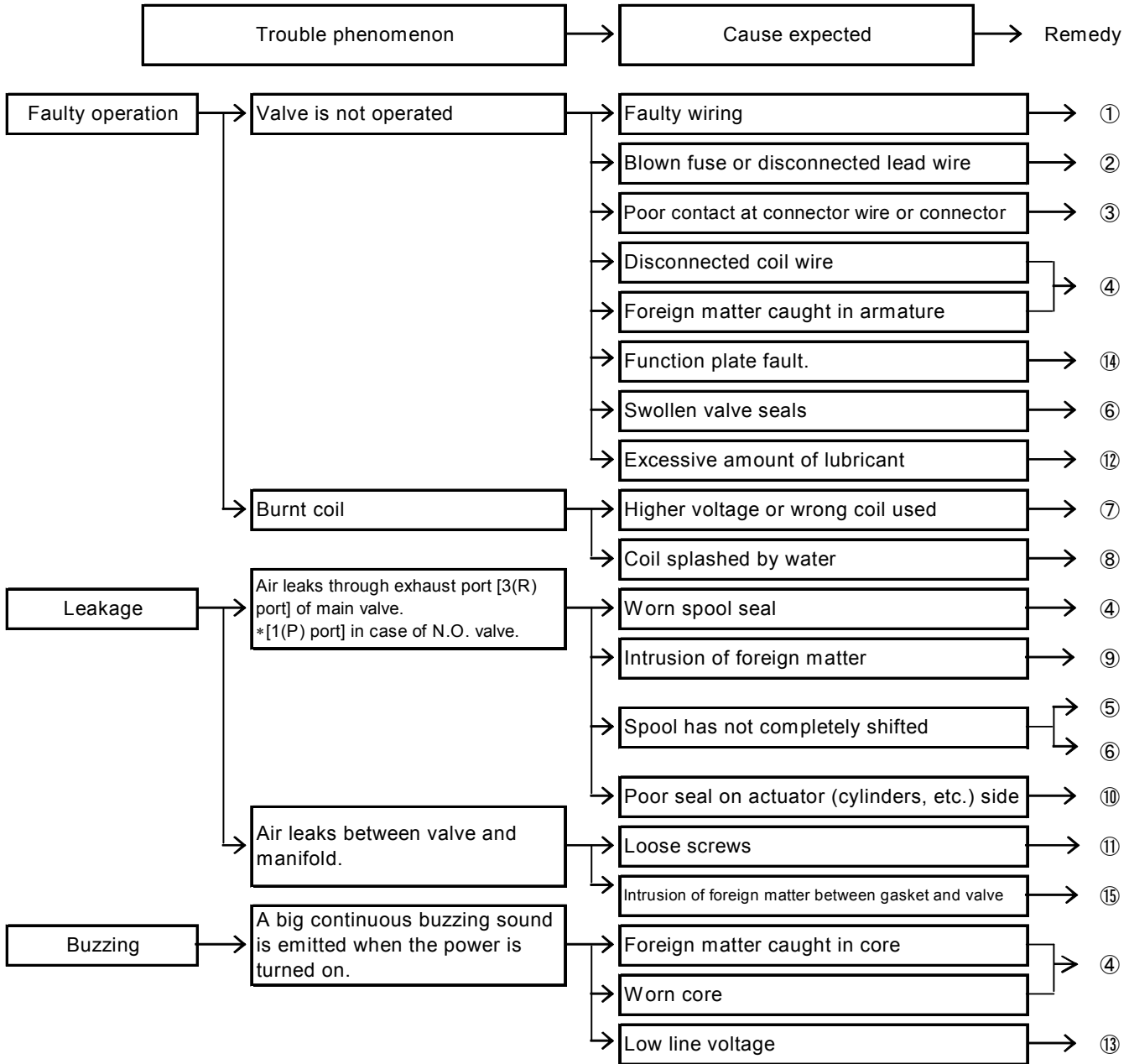

Remedy

No.	Remedy
①	Re-wire correctly.
②	Replace part.
③	Replace part or re-wire positively.
④	Replace valve.
⑤	Regulate pressure so that pilot pressure will fall within operating pressure range during operation.
⑥	·If wrong oil is used, completely air blow to remove oil, and replace valve. After valve is replaced, use turbine oil class 1 (ISO VG32).
	·When a large quantity of drain is given and cannot carry out drain omission surely, install either an auto-drain or a dryer. The valve should be replaced.
⑦	Check voltage. Replace valve.
⑧	Protect the valve so that water does not splash the coil.
⑨	In case of intrusion of foreign matter, to remove foreign matter by air blow of piping and then replace valve.
⑩	Repair or replace actuators.
⑪	After stopping air and re-tighten the bolts.
⑫	Reduce the amount of lubricant to the degree that no oil splashes out of the air exhaust port [3(R) port]. * [1(P) port] in case of N.O. valve.
⑬	Regulate voltage, so that the voltage at the time of the operation becomes specifications range.
⑭	Match the function plate correctly.
⑮	Remove the foreign matter.

If no improvement is achieved in spite of the above countermeasure, inside of the valve may have some abnormality. In this case, stop using the valve immediately.

If any of followings are carried out, inside of the valve may have some failure. In this case, stop using the valve immediately.

1. Voltage out of rated voltage has been used.
2. Oil other than the specified one has been lubricated.
3. Lubrication has been stopped intermediately, or lubrication was suspended temporary.
4. Water splashed directly.
5. Strong impact was given.
6. Alien substance such as drain and particle got into. Drain or garbage invaded a valve.
7. Prohibited way of using the valve which is written at "Precautions" section in this operation manual was carried out excluding above-mentioned.

In addition, in the case of trouble, please send it back to the supplier for repair or replacement.

Record of changes	
<input type="checkbox"/> A	Renewal My
<input type="checkbox"/> B	All revisions oU
<input type="checkbox"/> C	Safety Instructions Po

1st printing: 1986.4

SMC Corporation

4-14-1, Sotokanda, Chiyoda-ku, Tokyo 101-0021 JAPAN
Tel: + 81 3 5207 8249 Fax: +81 3 5298 5362
URL <http://www.smcworld.com>

Note: Specifications are subject to change without prior notice and any obligation on the part of the manufacturer.
© 2008 SMC Corporation All Rights Reserved



VT307**-OMH0001-C