

Series VZ300

Manifold Specifications

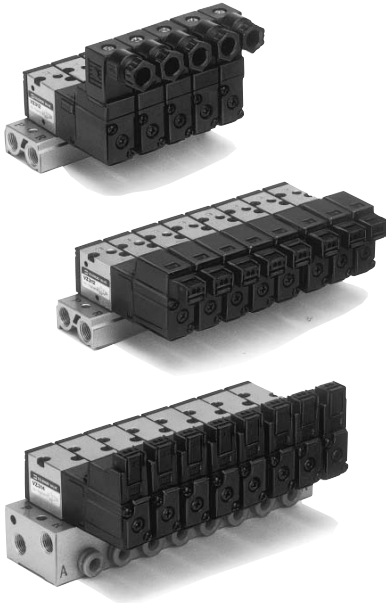

Manifold Specifications

Model	For internal pilot	20-□1	40-□2	40-□1
	For external pilot	21R-□1	40R-□2	40R-□1
Manifold type	Single base/B mount			
P(SUP)/R(EXH)	Common SUP/Common EXH			
Valve stations	2 to 20 stations			
A port porting specifications	Location	Valve		
	Direction	Top	Bottom	Side
Port size	1(P), 3(R) port	Rc 1/8	Rc 1/8	Rc 1/8
	2(A) port	M5 x 0.8	M5 x 0.8 1/8	M5 x 0.8, Rc 1/8, C4 (One-touch fitting for ø4), C6 (One-touch fitting for ø6)
	X port ^{Note)}	M5 x 0.8	M5 x 0.8	M5 x 0.8

Note) Only for external pilot

Flow Characteristics

Manifold			Port size		Flow characteristics					
					1 → 2 (P → A)			2 → 3 (A → R)		
			1(P), 3(R) port	2(A) port	C [dm ³ /(s·bar)]	b	Cv	C [dm ³ /(s·bar)]	b	Cv
Body ported For internal pilot	VV3Z3-20-□1	VZ3□2	1/8	M5 x 0.8	0.47	0.43	0.13	0.74	0.32	0.19
			1/8	M5 x 0.8	0.71	0.52	0.21	0.81	0.28	0.20
Base mounted For internal pilot	VV3Z3-40-□2	VZ3□4	1/8	M5 x 0.8	0.98	0.36	0.25	0.92	0.24	0.22
			1/8	M5 x 0.8	0.71	0.49	0.2	0.80	0.23	0.19
	1/8		1/8	1.00	0.37	0.26	0.96	0.25	0.24	
	1/8		C4	0.68	0.35	0.17	1.00	0.25	0.24	
	1/8		C6	1.00	0.27	0.25	1.00	0.30	0.26	
	1/8		C6	1.00	0.27	0.25	1.00	0.30	0.26	
Body ported For external pilot	VV3Z3-21R-□1	VZ3□2R	1/8	M5 x 0.8	0.47	0.43	0.13	0.74	0.32	0.19
			1/8	M5 x 0.8	0.71	0.52	0.21	0.81	0.28	0.20
Base mounted For external pilot	VV3Z3-40R-□2	VZ3□4R	1/8	M5 x 0.8	0.98	0.36	0.25	0.92	0.24	0.22
			1/8	M5 x 0.8	0.71	0.49	0.2	0.80	0.23	0.19
	1/8		1/8	1.00	0.37	0.26	0.96	0.25	0.24	
	1/8		C4	0.68	0.35	0.17	1.00	0.25	0.24	
	1/8		C6	1.00	0.27	0.25	1.00	0.30	0.26	
	1/8		C6	1.00	0.27	0.25	1.00	0.30	0.26	

How to Order Manifold

Instruct by specifying the valves and blanking plate assembly to be mounted on the manifold along with the manifold base model no.

(Example)

VV3Z3-20-031.....1 pc. (Manifold base)

VV3Z3-40R-031-C6.....1 pc. (Manifold base)

*VZ312-5LZ-M5...2 pcs. (Valve)

*VZ314R-5G.....2 pcs. (Valve)

*DXT200-8-6A.....1 pc. (Blanking plate assembly)

*DXT200-8-3A.....1 pc. (Blanking plate assembly)

↳ The asterisk denotes the symbol for assembly. Prefix it to the part nos. of the solenoid valve, etc.

3 Port Solenoid Valve Rubber Seal, Body Ported/Base Mounted **Series VZ300**

Option

Combinations of Solenoid Valve, Manifold Gasket and Manifold

Body ported (VZ3□2)

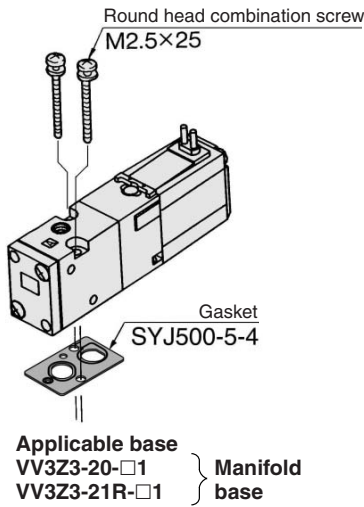

Base mounted (VZ3□4)

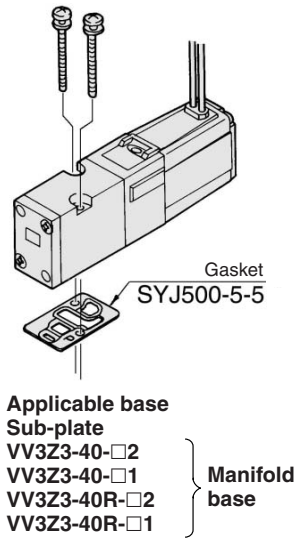

Blanking Plate Assembly

Part no.: DXT-200-8-3A

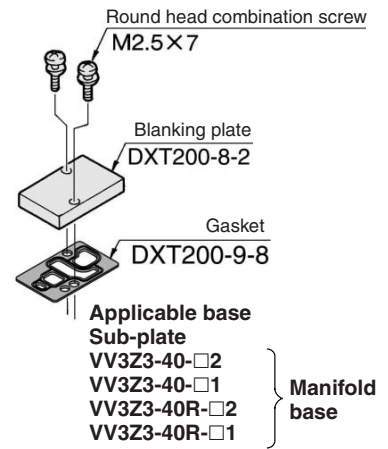

Part no.: DXT200-8-6A

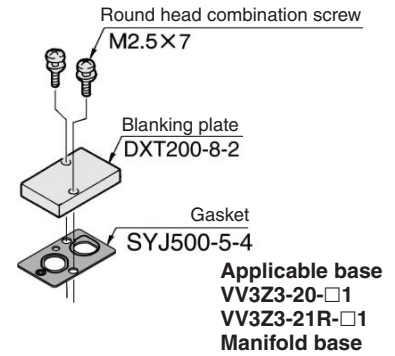

⚠ Caution

Mounting Screw Tightening Torques

M2.5: 0.45 N·m

⚠ Warning

When mounting a solenoid valve on the manifold base or sub-plate, etc., the mounting direction is determined. If mounted in the wrong direction, the equipment to be wired might result in malfunction. Refer to dimensions of this catalog and use caution to the mounting direction.

V100

SY

SYJ

VK

VZ

VT

VP

VG

VP

S070

VQ

VKF

VQZ

VZ

VS

VFN

Series VZ300

Manifold for Internal Pilot

20-□1

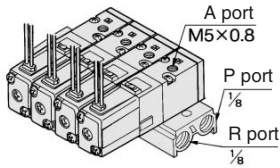

How to Order

VV3Z3-20-05 1 □ □

Stations	
02	2 stations
⋮	⋮
20	20 stations

P/R port Thread type	
Nil	Rc
00F	G
00N	NPT
00T	NPTF

Option	
F	Foot bracket

* Bracket is not mounted.

Applicable solenoid valve
 VZ312-□□□□-M5
 VZ312M-□□□□-M5
 VZ322-□□□□-M5
 VZ322M-□□□□-M5
Applicable blanking plate assembly
 DXT200-8-6A



Note) For more than 6 stations, supply air to both sides of P port and exhaust air from both sides of R port.

40-□2

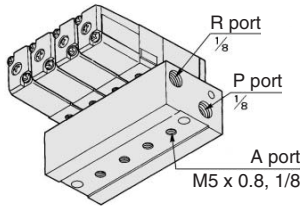

How to Order

VV3Z3-40-05 2-M5 □ □

Stations	
02	2 stations
⋮	⋮
20	20 stations

A port side	
M5	M5 x 0.8
01	1/8

P/R port Thread type	
Nil	Rc
F	G
N	NPT
Z	NPTF

Applicable solenoid valve
 VZ314-□□□□
 VZ314M-□□□□
 VZ324-□□□□
 VZ324M-□□□□
Applicable blanking plate assembly
 DXT200-8-3A



Note) For more than 9 stations, supply air to both sides of P port and exhaust air from both sides of R port.

40-□1

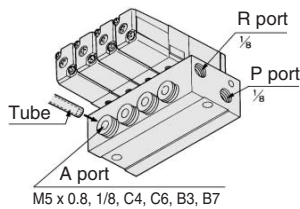

How to Order

VV3Z3-40-05 1-C6 □ □

Stations	
02	2 stations
⋮	⋮
20	20 stations

A port side	
M5	M5 x 0.8
01	1/8
C4	One-touch fitting for ø4
C6	One-touch fitting for ø6
B3	One-touch fitting for ø5/32"
B7	One-touch fitting for ø1/4

P/R port Thread type	
Nil	Rc
F	G
N	NPT
T	NPTF

Applicable solenoid valve
 VZ314-□□□□
 VZ314M-□□□□
 VZ324-□□□□
 VZ324M-□□□□
Applicable blanking plate assembly
 DXT200-8-3A



Note) For more than 9 stations, supply air to both sides of P port and exhaust air from both sides of R port.

Manifold for External Pilot

Pilot valve pressure is supplied separately from the main valve pressure through the use of a separate supply port. It can be used in the vacuum (up to -100 kPa) or low pressure line with 0.15 MPa or less.

21R-□1

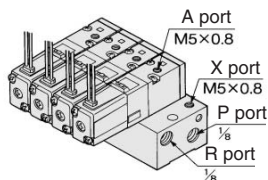

How to Order

VV3Z3-21R-05 1 □ □

Stations	
02	2 stations
⋮	⋮
20	20 stations

P/R port Thread type	
Nil	Rc
00F	G
00N	NPT
00T	NPTF

Applicable solenoid valve
 VZ312R-□□□□-M5
 VZ322R-□□□□-M5
Applicable blanking plate assembly
 DXT200-8-6A



Note) For more than 9 stations, supply air to both sides of P port and exhaust air from both sides of R port.

40R-□2

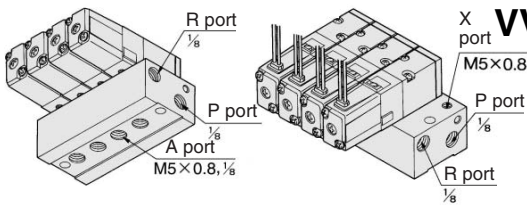

How to Order

VV3Z3-40R-05 2-01 □ □

Stations	
02	2 stations
⋮	⋮
20	20 stations

A port side	
M5	M5 x 0.8
01	1/8

P/R port Thread type	
Nil	Rc
F	G
N	NPT
T	NPTF

Applicable solenoid valve
 VZ314R-□□□□
 VZ324R-□□□□
Applicable blanking plate assembly
 DXT200-8-3A



Note) For more than 9 stations, supply air to both sides of P port and exhaust air from both sides of R port.

40R-□1

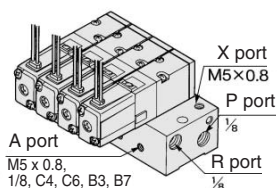

How to Order

VV3Z3-40R-05 1-M5 □ □

Stations	
02	2 stations
⋮	⋮
20	20 stations

A port side	
M5	M5 x 0.8
01	1/8
C4	One-touch fitting for ø4
C6	One-touch fitting for ø6
B3	One-touch fitting for ø5/32"
B7	One-touch fitting for ø1/4

P/R port Thread type	
Nil	Rc
F	G
N	NPT
T	NPTF

Applicable solenoid valve
 VZ314R-□□□□
 VZ324R-□□□□
Applicable blanking plate assembly
 DXT200-8-3A



Note) For more than 9 stations, supply air to both sides of P port and exhaust air from both sides of R port.

3 Port Solenoid Valve Rubber Seal, Body Ported/Base Mounted **Series VZ300**

**For Internal Pilot
Type 20 Manifold: Top Ported**

**VV3Z3-20- Stations 1(-F)
Grommet (G), (H)**

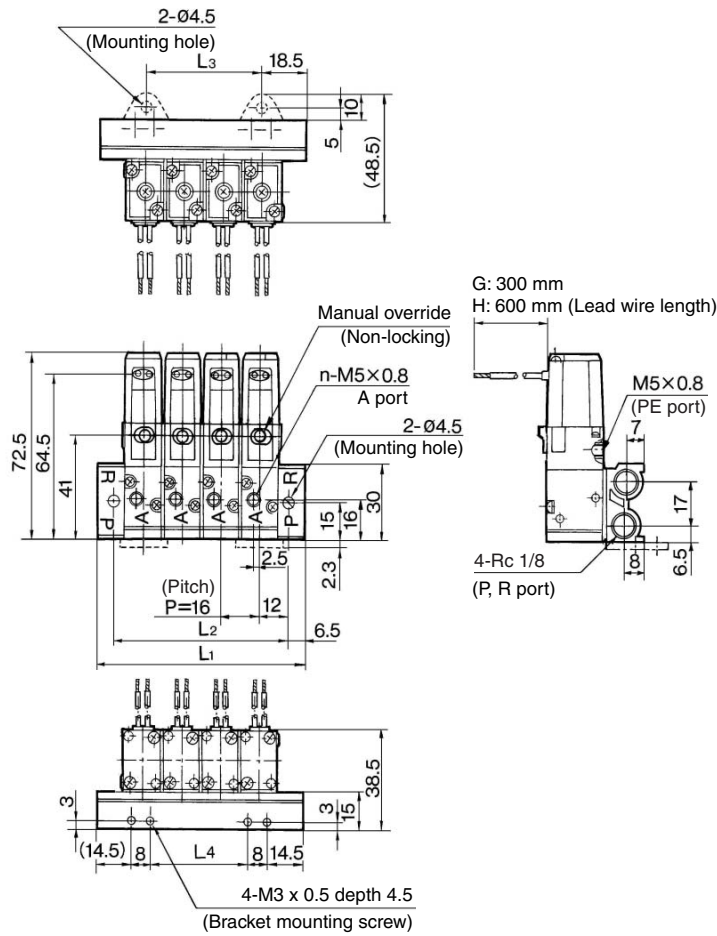

- V100
- SY
- SYJ
- VK
- VZ**
- VT
- VP
- VG
- VP
- S070
- VQ
- VKF
- VQZ
- VZ
- VS
- VFN

Stations n	2	3	4	5	6	7	8	9	10	11	12	13	14	15	16	17	18	19	20
L1	53	69	85	101	117	133	149	165	181	197	213	229	245	261	277	293	309	325	341
L2	40	56	72	88	104	120	136	152	168	184	200	216	232	248	264	280	296	312	328
L3	16	32	48	64	80	96	112	128	144	160	176	192	208	224	240	256	272	288	304
L4	8	24	40	56	72	88	104	120	136	152	168	184	200	216	232	248	264	280	296

L plug connector (L)

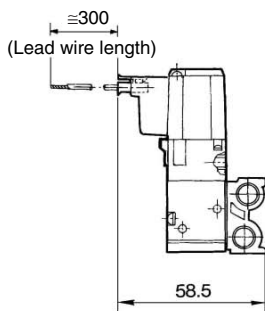

M plug connector (M)

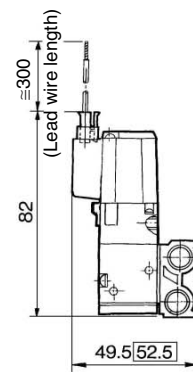

DIN terminal (D)

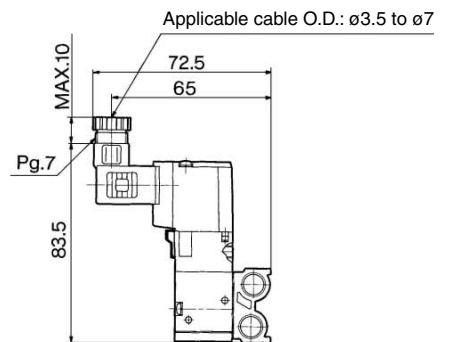

□: With light/surge voltage suppressor

Series VZ300

Type 40 Manifold: Bottom Ported

VVZ3-40- Stations 2-M5/01
Grommet (G), (H)

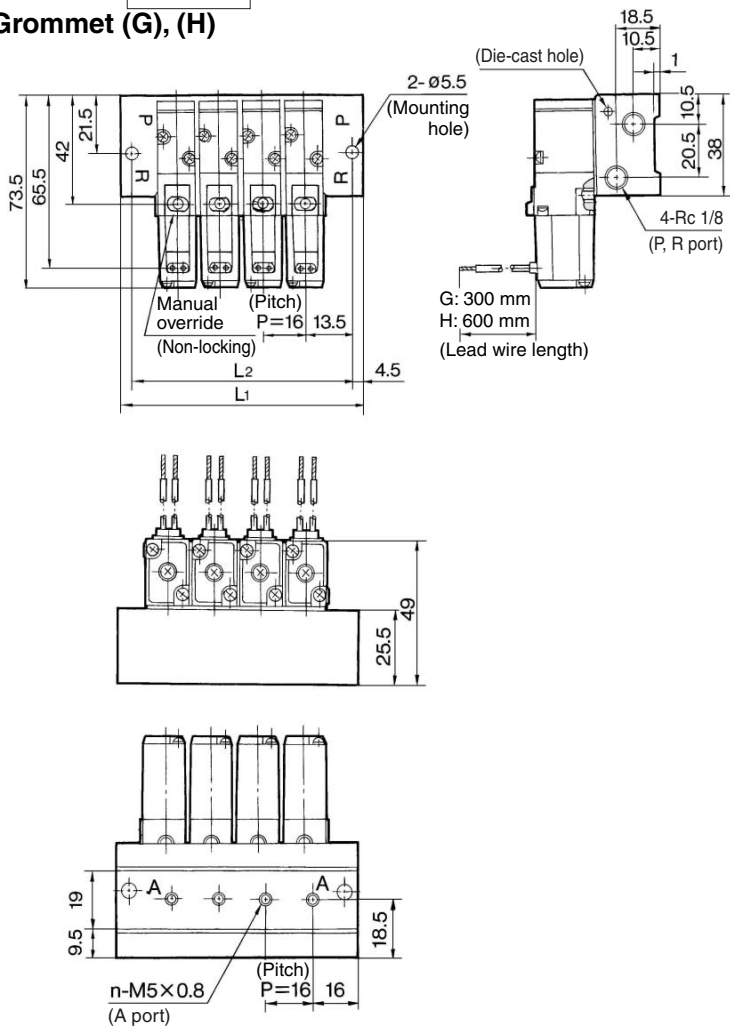

Rc 1/8

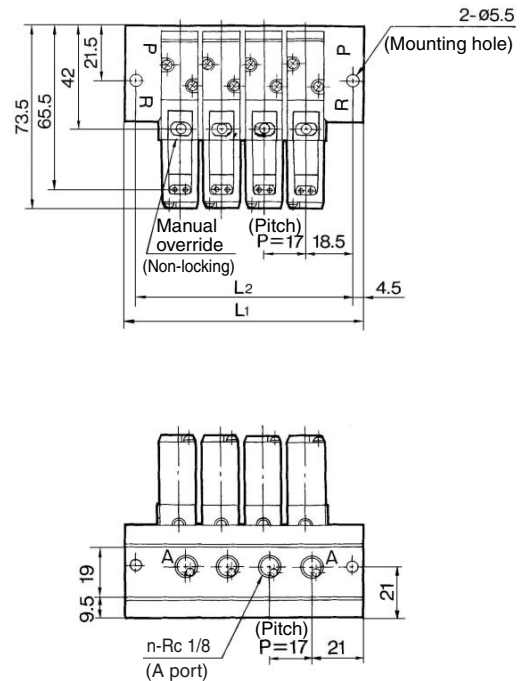

Port size	Stations n	2	3	4	5	6	7	8	9	10	11	12	13	14	15	16	17	18	19	20
M5	L1	52	68	84	100	116	132	148	164	180	196	212	228	244	260	276	292	308	324	340
	L2	43	59	75	91	107	123	139	155	171	187	203	219	235	251	267	283	299	315	331
Rc 1/8	L1	63	80	97	114	131	148	165	182	199	216	233	250	267	284	301	318	335	352	369
	L2	54	71	88	105	122	139	156	173	190	207	224	241	258	275	292	309	326	343	360

L plug connector (L)

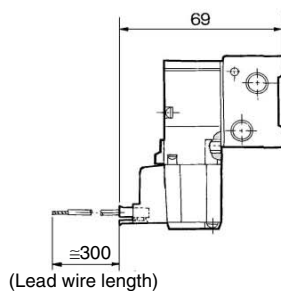

M plug connector (M)

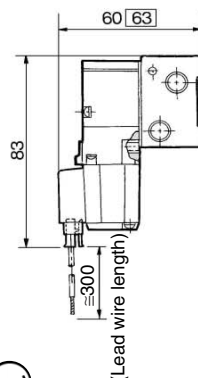

DIN terminal (D)

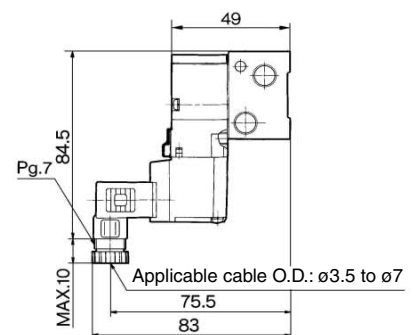

□: With light/surge voltage suppressor

3 Port Solenoid Valve Rubber Seal, Body Ported/Base Mounted **Series VZ300**

**For Internal Pilot
Type 40 Manifold: Side Ported**

**VV3Z3-40- Stations 1-M5/01
Grommet (G), (H)**

Rc 1/8

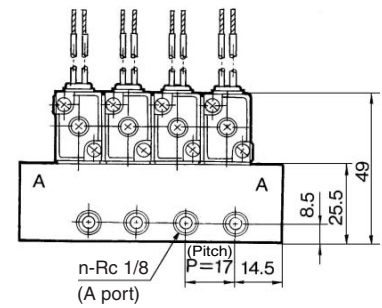
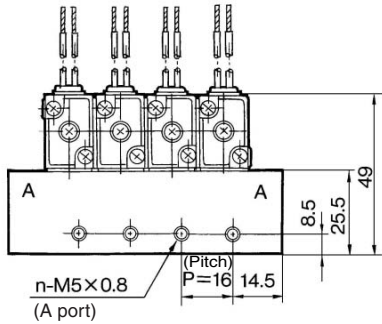
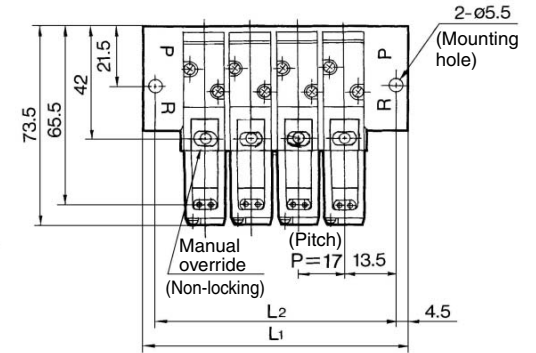
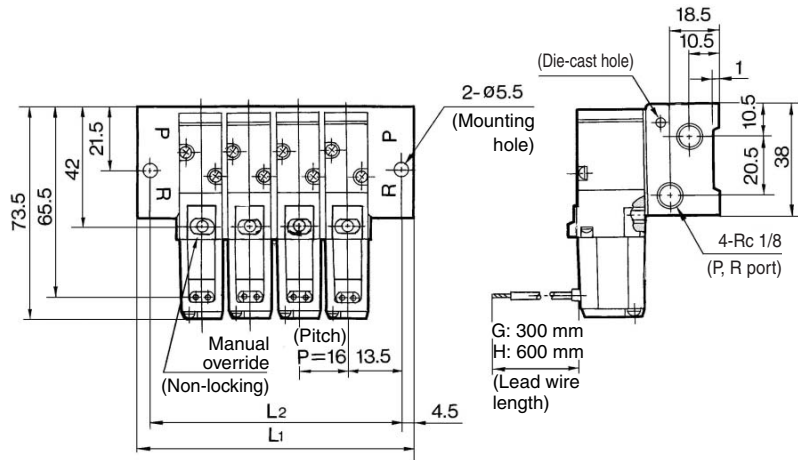

Port size	Stations n	2	3	4	5	6	7	8	9	10	11	12	13	14	15	16	17	18	19	20
M5	L1	52	68	84	100	116	132	148	164	180	196	212	228	244	260	276	292	308	324	340
	L2	43	59	75	91	107	123	139	155	171	187	203	219	235	251	267	283	299	315	331
Rc 1/8	L1	53	70	87	104	121	138	155	172	189	206	223	240	257	274	291	308	325	342	359
	L2	44	61	78	95	112	129	146	163	180	197	214	231	248	265	282	299	316	333	350

L plug connector (L)

M plug connector (M)

DIN terminal (D)

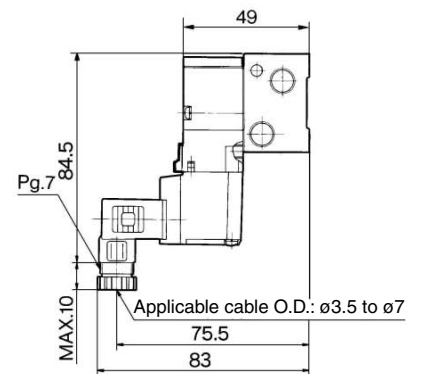
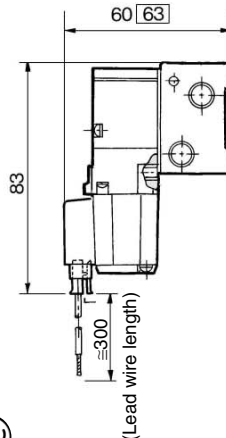
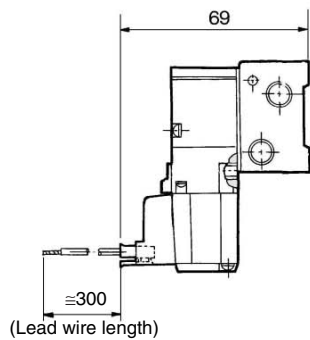

□: With light/surge voltage suppressor

- V100
- SY
- SYJ
- VK
- VZ**
- VT
- VP
- VG
- VP
- S070
- VQ
- VKF
- VQZ
- VZ
- VS
- VFN

Series VZ300

For Internal Pilot
Type 40 Manifold: Side Ported

VV3Z3-40- Stations 1-C4/C6
Grommet (G), (H)

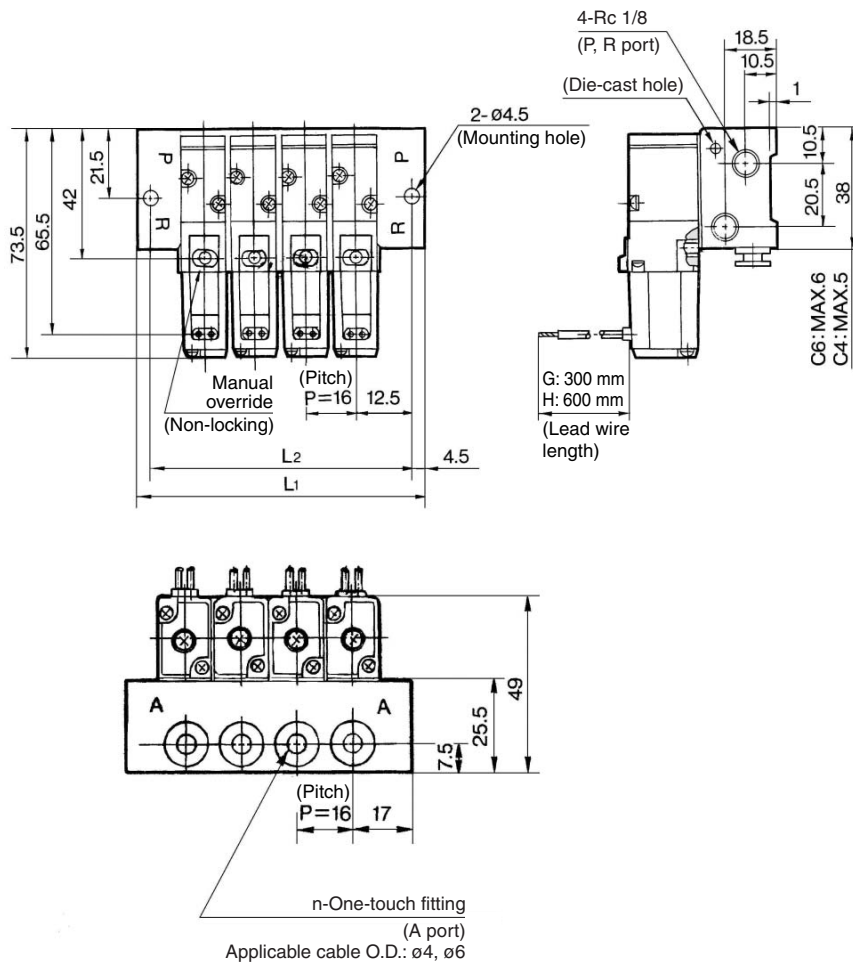

Stations n	2	3	4	5	6	7	8	9	10	11	12	13	14	15	16	17	18	19	20
L1	50	66	82	98	114	130	146	162	178	194	210	226	242	258	274	290	306	322	338
L2	41	57	73	89	105	121	137	153	169	185	201	217	233	249	265	281	297	313	329

L plug connector (L)

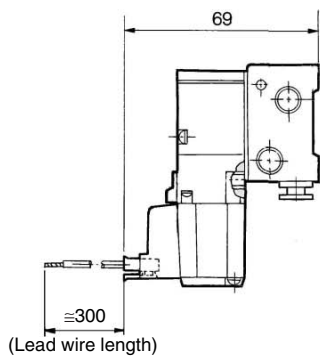

M plug connector (M)

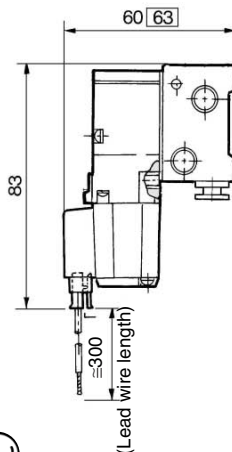

DIN terminal (D)

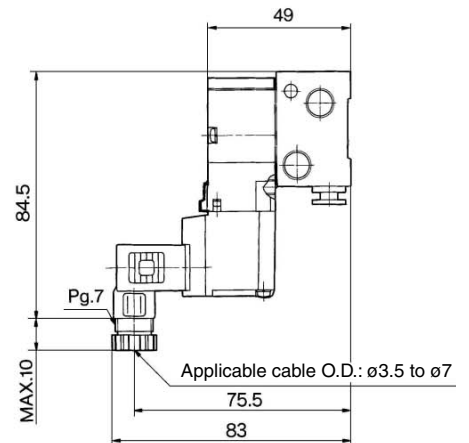

□: With light/surge voltage suppressor