

Series VFS1000 Manifold Specifications Single Base Type

Compact and lightweight

Compact due to manifolding on a single base for mounting in small spaces.

Keeps environmental air clean from pilot exhaust

Use of the VV5FS1-30 manifold can exhaust intensively the pilot exhaust gas to the base side, and can prevent environmental aggravation due to noise and oil mist.

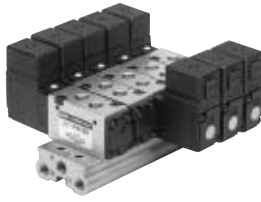

VV5FS1-20



VV5FS1-30

Part no. for mounting bolt and gasket
BG-VFS1030

Specifications

Manifold base type	Bar manifold, Body ported
Stations	Max. 15 stations

Port Specifications



Symbol	Passage		Porting specifications: Rc (Connecting port size)		
			Base	Valve	Base
	1(P)	5(R1), 3(R2)	1(P)	4(A), 2(B)	5(R1), 3(R2)
1	Common	Common	Side/Rc 1/8	Top/Rc 1/8	Side/Rc 1/8

Option

Blanking plate	VVFS1000-10A-1	With gasket, screw
----------------	----------------	--------------------

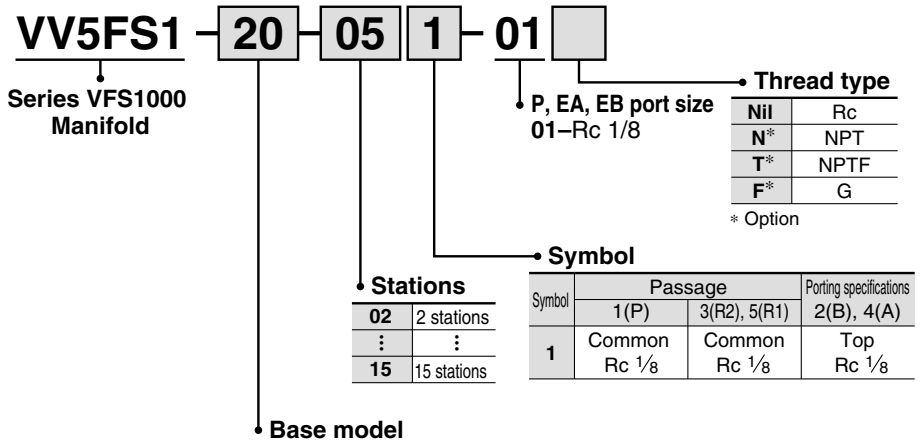
How to Order Manifold Base



Model	Pilot exhaust	Applicable valve model
20	Pilot individual EXH 	VFS1□20-□□-01
30	Pilot common EXH 	VFS1□30-□□-01 *VFS1□20-□□-01 mountable

How to Order Manifold Assembly

Instruct by specifying the valves and blanking plate to be mounted on the manifold along with the manifold base model no.

<Example>

(Manifold base)	VV5FS1-20-061-01	1
(2 position single)	VFS1120-1D-01	3
(2 position double)	VFS1220-1D-01	2
(Blanking plate)	VVFS1000-10A-1	1

5 Port Pilot Operated Solenoid Valve Metal Seal, Body Ported Series VFS1000

Type 20 Manifold Pilot individual exhaust: VV5FS1-20-Station 1-01

Grommet: G

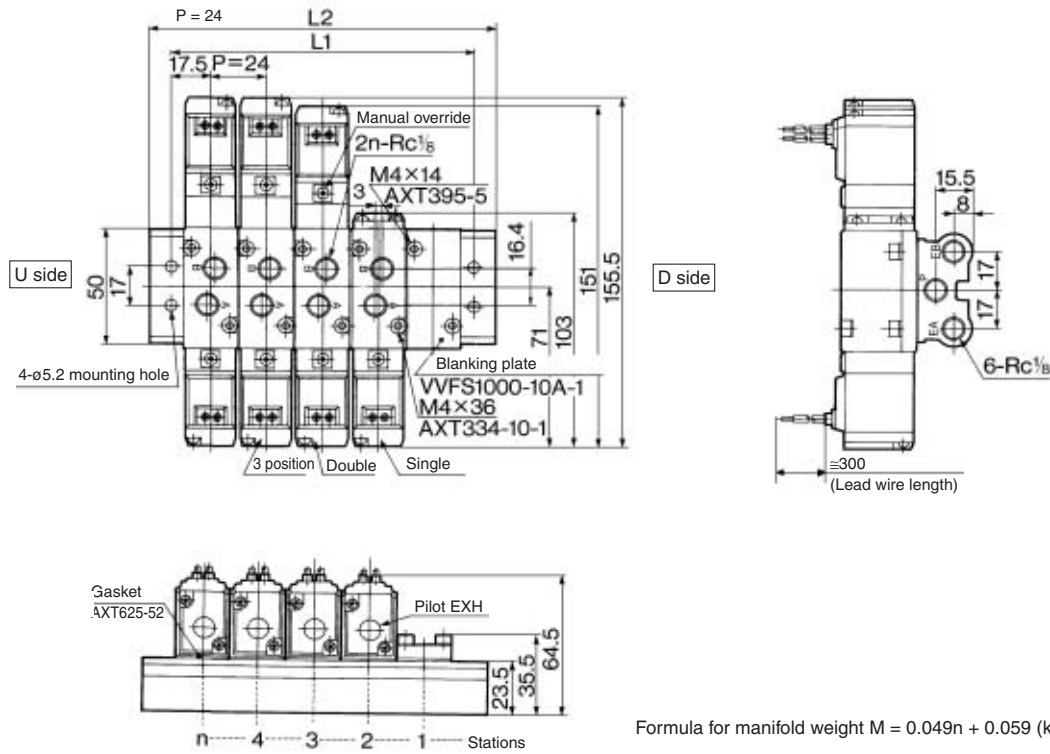

- VK
- VZ
- VF
- VFR
- VP4
- VZS
- VFS**
- VS4
- VQ7
- EVS
- VFN

Grommet terminal: E/EZ

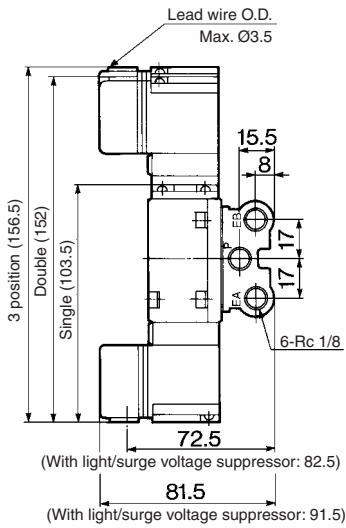

Conduit terminal: T/TZ

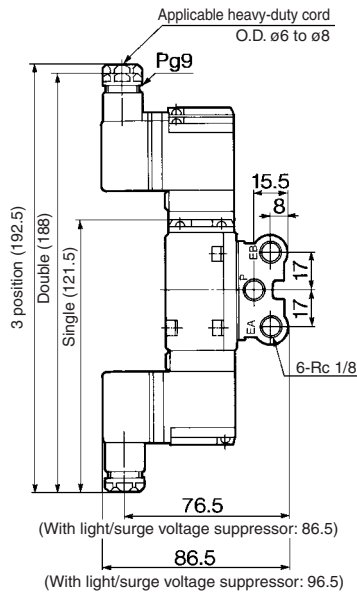

DIN terminal: D/DZ/Y/YZ

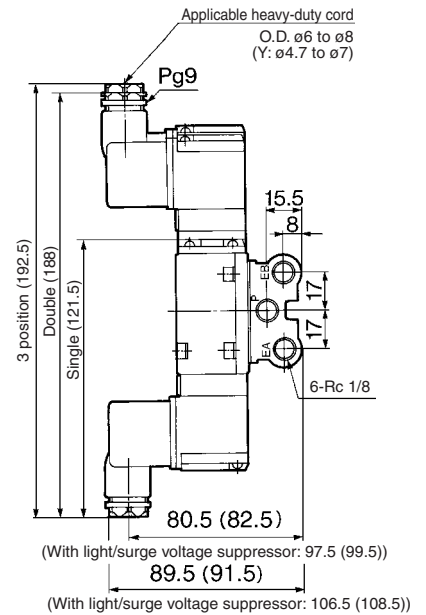

(): Y, YZ

n: Station

Symbol	Stations	2	3	4	5	6	7	8	9	10	Formula
L1		59	83	107	131	155	179	203	227	251	$L1 = 24 \times n + 11$
L2		77	101	125	149	173	197	221	245	269	$L2 = 24 \times n + 29$

Series VFS1000

Type 30 Manifold Pilot common exhaust: VV5FS1-30-Station 1-01

Grommet: G

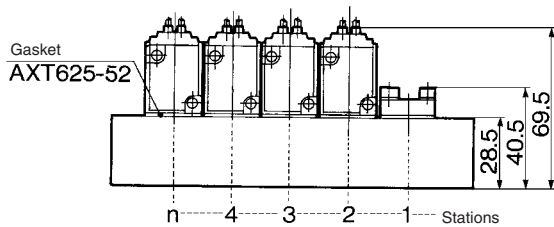
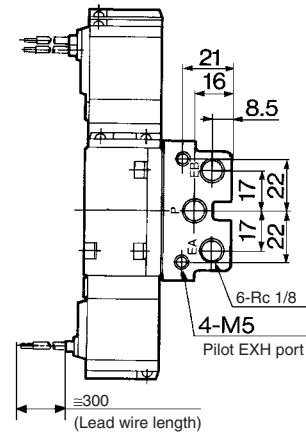
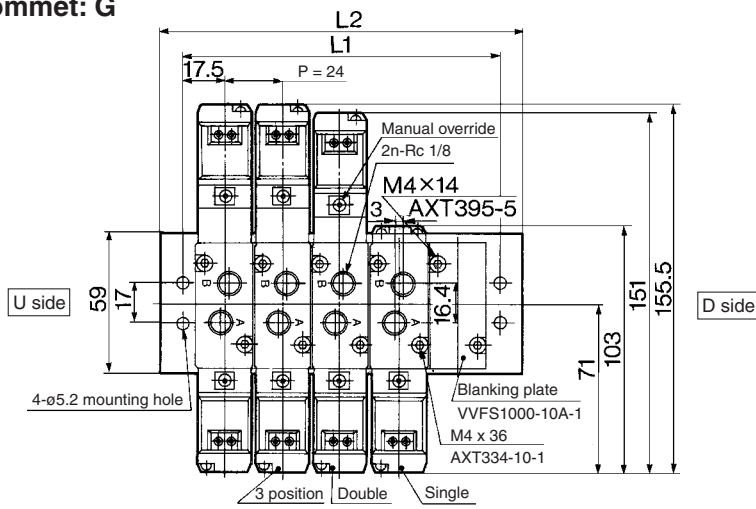

Formula for manifold weight $M = 0.079n + 0.093$ (kg) n: Station

Grommet terminal: E/EZ

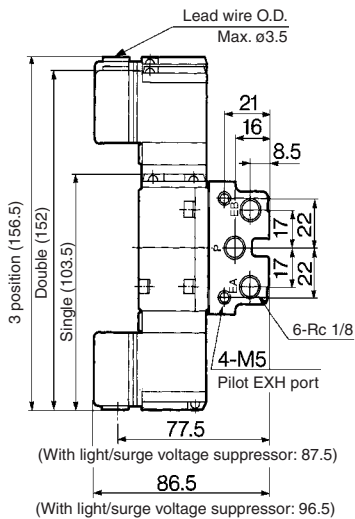

Conduit terminal: T/TZ

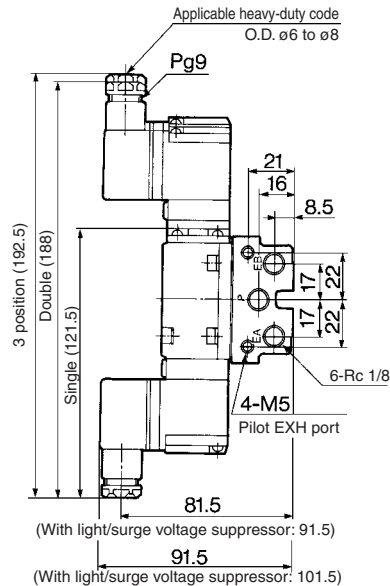

DIN terminal: D/DZ/Y/YZ

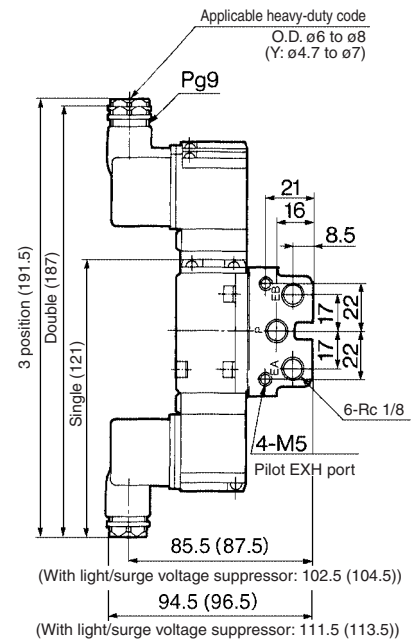

(): Y, YZ
n: Station

Symbol	Stations	2	3	4	5	6	7	8	9	10	Formula
L1		59	83	107	131	155	179	203	227	251	$L1 = 24 \times n + 11$
L2		77	101	125	149	173	197	221	245	269	$L2 = 24 \times n + 29$