

Series VK3000 Manifold Specifications

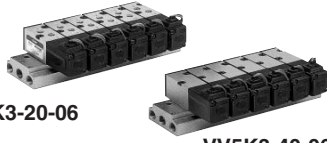

VV5K3-20-06

VV5K3-40-06-M5

Specifications

Valve stations		1 to 20
Piping method	Common SUP, Common EXH	Body ported, Base mounted
	Common SUP, Individual EXH	Body ported

Common SUP/Common EXH

Type 20: Body ported (A, B port top ported)

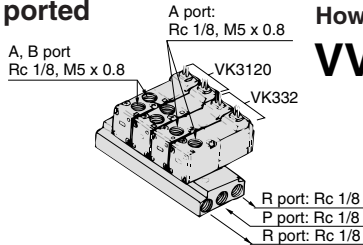

How to Order

VV5K3-20-05

Valve stations	
01	1 station
⋮	⋮
20	20 stations

Thread type

Nil	Rc
00F	G
00N	NPT
00T	NPTF

Applicable solenoid valve
VK3120□-□□□-M5
VK3120□-□□□-01
VK332□-□□□-M5
VK332□-□□□-01

Applicable blanking
plate assembly
VK3000-7-1A

Type 40: Base mounted (A, B port bottom ported)

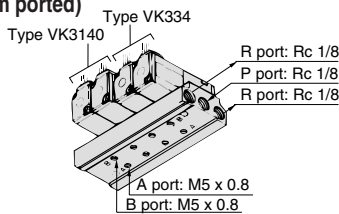

How to Order

VV5K3-40-05-M5

Valve stations	
01	1 station
⋮	⋮
20	20 stations

Thread type

Nil	Rc
F	G
N	NPT
T	NPTF

Applicable solenoid valve
VK3140□-□□□
VK334□-□□□

Applicable blanking
plate assembly
VK3000-7-1A

Type 41: Base mounted (A, B port side ported)

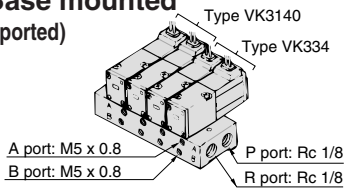

How to Order

VV5K3-41-05-M5

Solenoid direction

Nil	Solenoid on same side of A and B port
S	Solenoid on same side of A and B port

Valve stations

01	1 station
⋮	⋮
20	20 stations

Port size

M5	M5 x 0.8
C4	ø4 cassette

Thread type

Nil	Rc
F	G
N	NPT
T	NPTF

Applicable solenoid valve
VK3140□-□□□
VK334□-□□□

Applicable blanking
plate assembly
VK3000-7-1A

Type S41

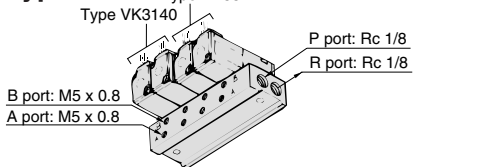

Type 42: Base mounted (A, B port side ported)

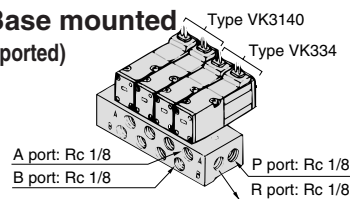

How to Order

VV5K3-42-05-01

Solenoid direction

Nil	Solenoid on same side of A and B port
S	Solenoid on same side of A and B port

Valve stations

01	1 station
⋮	⋮
20	20 stations

Port size

01	Rc 1/8
C6	ø6 cassette

Thread type

Nil	Rc
F	G
N	NPT
T	NPTF

Applicable solenoid valve
VK3140□-□□□
VK334□-□□□

Applicable blanking
plate assembly
VK3000-7-1A

Type S42

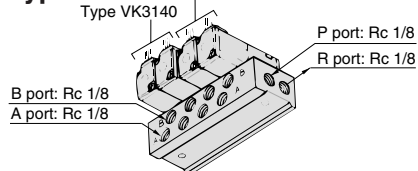

Common SUP/Individual EXH

Type 21: Body ported (A, B port top ported)

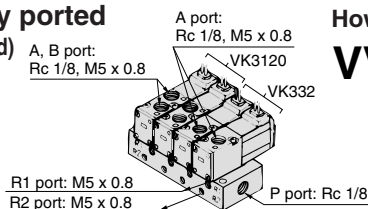

How to Order

VV5K3-21-05

Valve stations	
01	1 station
⋮	⋮
20	20 stations

Thread type

Nil	Rc
F	G
N	NPT
T	NPTF

Applicable solenoid valve
VK3120□-□□□-M5
VK3120□-□□□-01
VK332□-□□□-M5
VK332□-□□□-01

Applicable blanking
plate assembly
VK3000-7-1A

Series VK3000

Combinations of Solenoid Valve, Manifold Gasket and Manifold Base

5 port body ported: VK3120

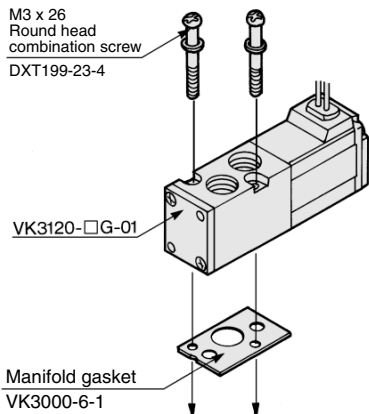

Applicable base
Type VV5K3-20 } Manifold base
Type VV5K3-21 }

5 port base mounted: VK3140

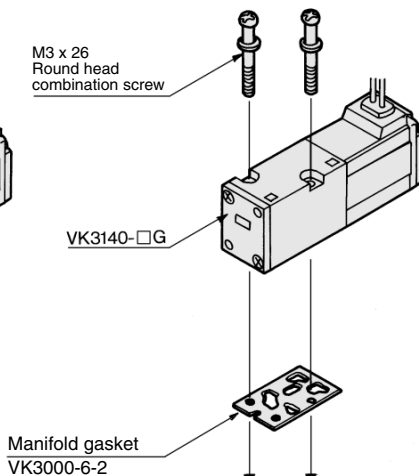

Applicable base
VK3000-9-1 Sub-plate } Manifold base
Type VV5K3-40 }
Type VV5K3-(S)41 }
Type VV5K3-(S)42 }

	Body ported	Base mounted
Manifold gasket	VK3000-6-1A	VK3000-6-2A
Screw assembly		

Caution Mounting Screw Tightening Torques
M3: 0.6 N·m

Combination of Blanking Plate Assembly and Manifold Base

Blanking plate assembly: VK3000-7-1A

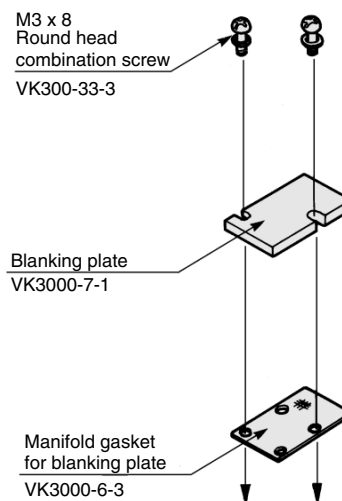

Applicable base: In common for all types of VV5K3 models

Caution Mounting Screw Tightening Torques
M3: 0.6 N·m

Note) Mounting direction is not flexible. Make sure to mount them in the right direction.

Mixed Mounting of VK300 and Manifold Base of Series VK3000

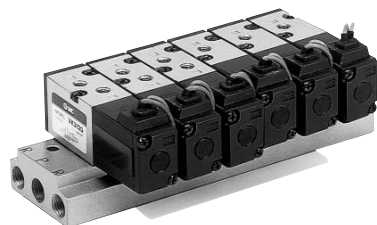

1. In the case of VV5K3-20/40

When installing the 3 port valve on the manifold base, plug the "R" port at the corresponding mark side with the rubber plug (VK3000-8-1) as shown in the figures on the right.

2. Other manifold

3 port valve except VV5K3-20 and 40 types can be mounted without any work.

Note 1) Remove the plug if changing the 3 port valve to a 5 port valve.

Note 2) In case a 3 port valve VK300 is mounted on the manifold base for a 5 port valve VK3000, switching type is normally closed (N.C.). If requiring a normally open type (N.O.), plug the "A" port on the 5 port valve.

Note 3) "A" port of a 3 port valve for base mounted type becomes "A" port of a 5 port valve. Plug that "A" port to avoid mistaking "B" port for the "A" port.

Type VV5K3-20

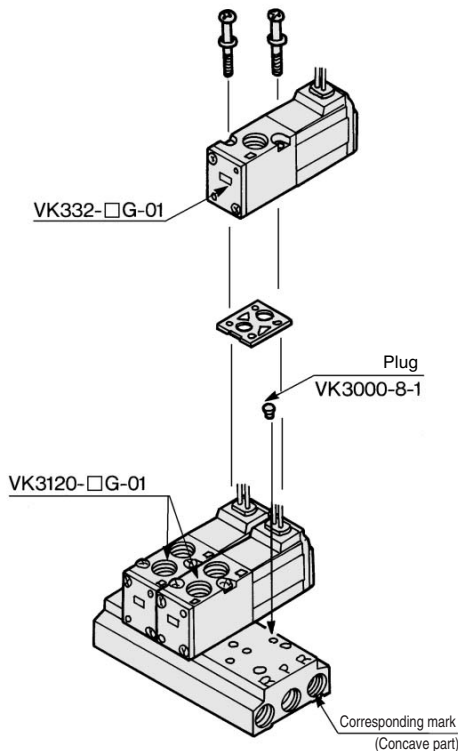

Type VV5K3-40

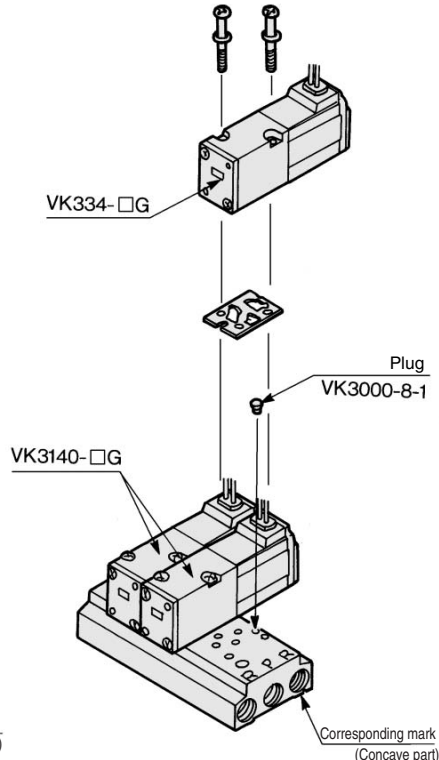

Caution Mounting Screw Tightening Torques
M3: 0.6 N·m

Series VK3000

Dimensions: Base Mounted

Grommet: VK3140-□G-01

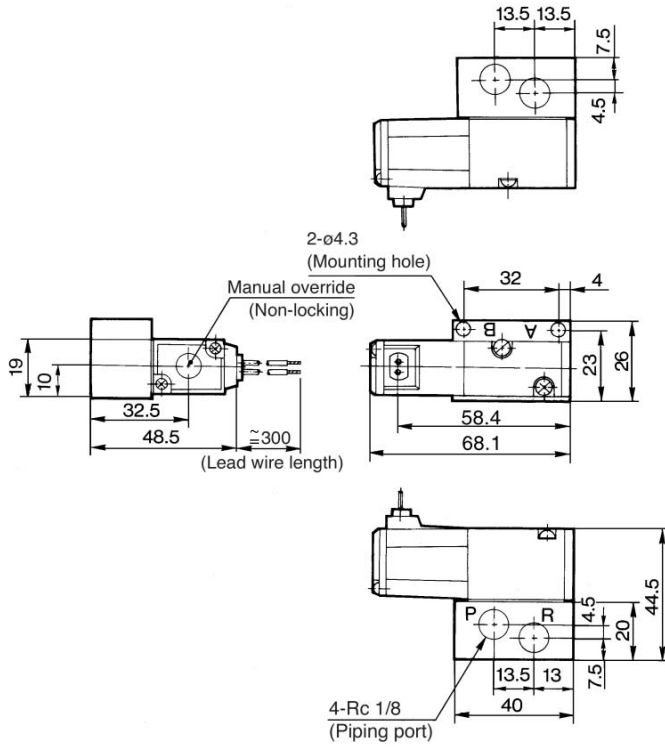

DIN terminal: VK3140-□D-01

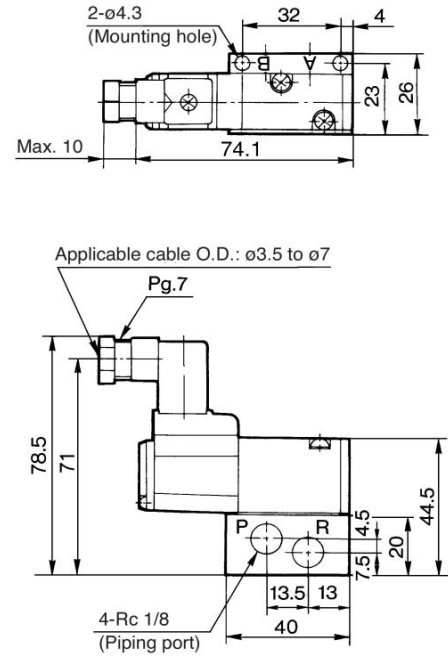

Refer to grommet type for other dimensions.

Series VK3000

Type 40 Manifold Base mounted (Bottom ported)

VV5K3-40-Station-M5

Grommet: G

DIN terminal: D

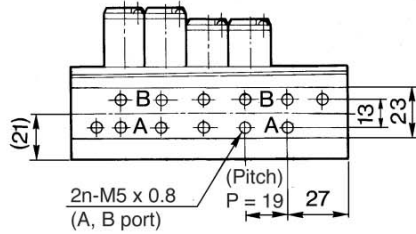
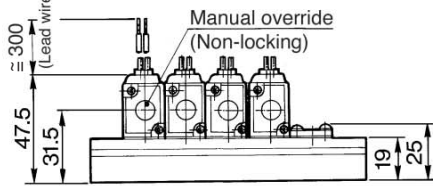
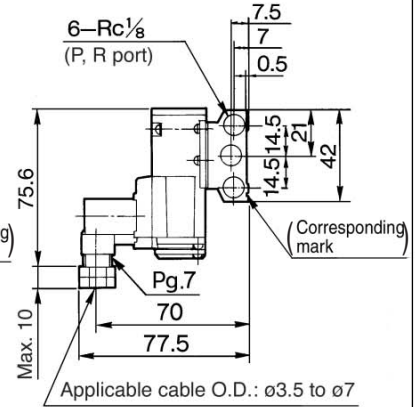
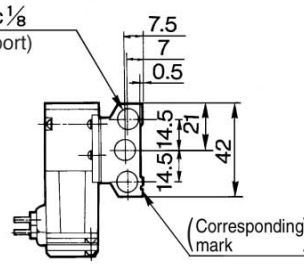
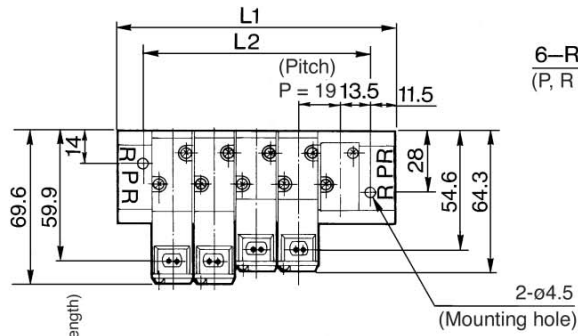

L Dimension

n: Stations

L \ n	1	2	3	4	5	6	7	8	9	10	11	12	13	14	15	16	17	18	19	20
L ₁	50	69	88	107	126	145	164	183	202	221	240	259	278	297	316	335	354	373	392	411
L ₂	27	46	65	84	103	122	141	160	179	198	217	236	255	274	293	312	331	350	369	388

5 Port Direct Operated Poppet Solenoid Valve Rubber Seal Series **VK3000**

Type 41 Manifold Base mounted (Side ported)

VV5K3-41-Station-M5

Grommet: G

DIN terminal: D

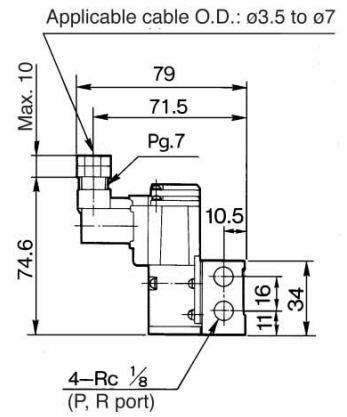
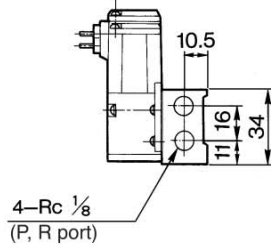
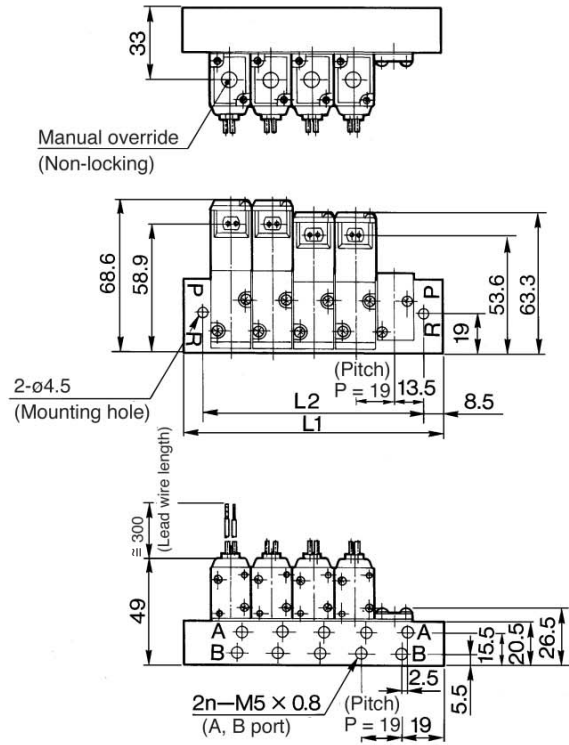

Built-in One-touch fitting: VV5K3-41-Station-C4

Solenoid is at the same side as A port: VV5K3-S41-Station-□

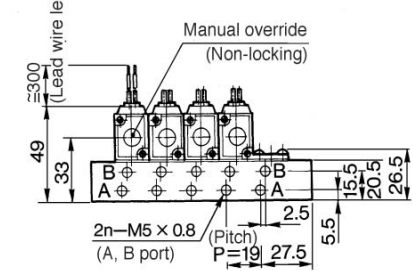
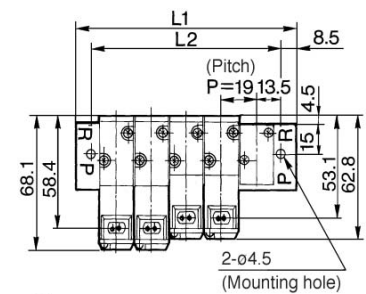
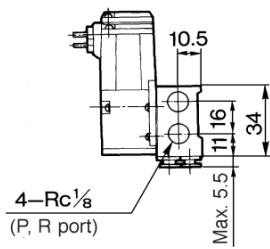
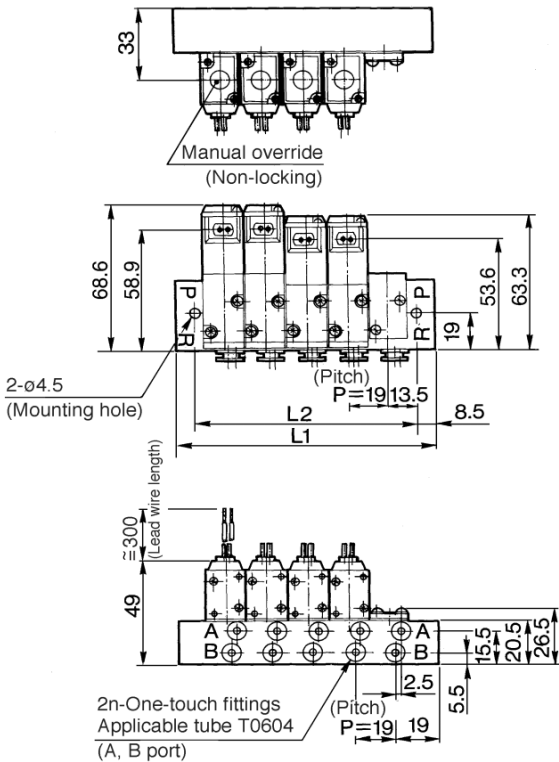

Refer to the above drawing for DIN terminal dimensions.

Refer to the above drawing for other dimensions.

L	n	1	2	3	4	5	6	7	8	9	10	11	12	13	14	15	16	17	18	19	20
L_1		44	63	82	101	120	139	158	177	196	215	234	253	272	291	310	329	348	367	386	405
L_2		27	46	65	84	103	122	141	160	179	198	217	236	255	274	293	312	331	350	369	388

- VK**
- VZ
- VF
- VFR
- VP4
- VZS
- VFS
- VS4
- VQ7
- EVS
- VFN

Series VK3000

Type 42 Manifold Base mounted (Side ported)

VV5K3-42-Station-01

Grommet: G

DIN terminal: D

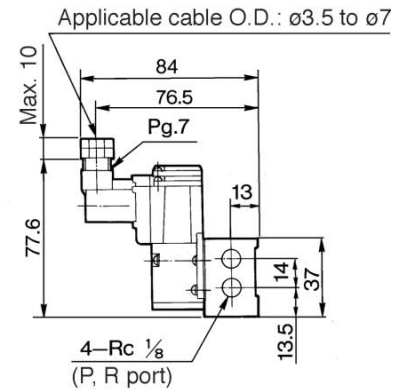
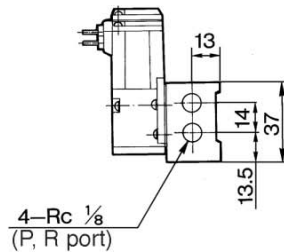
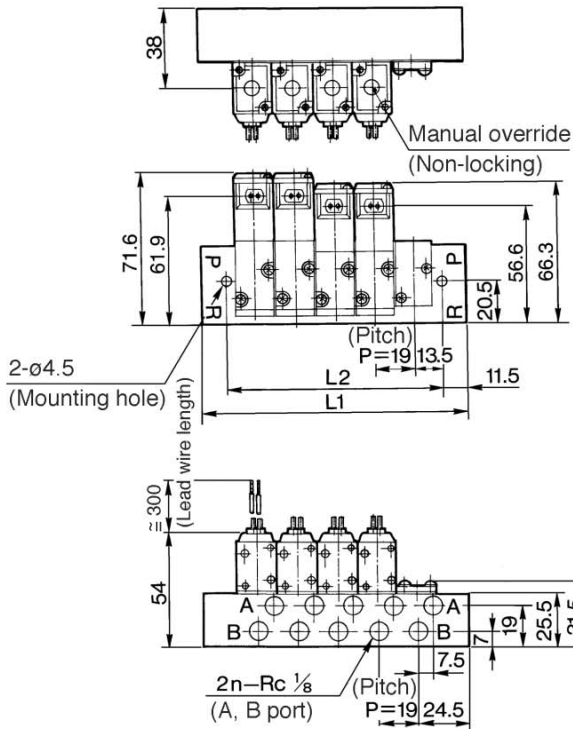

Built-in One-touch fitting: VV5K3-42-Station-C6

Solenoid is at the same side as A port: VV5K3-S42-Station-□

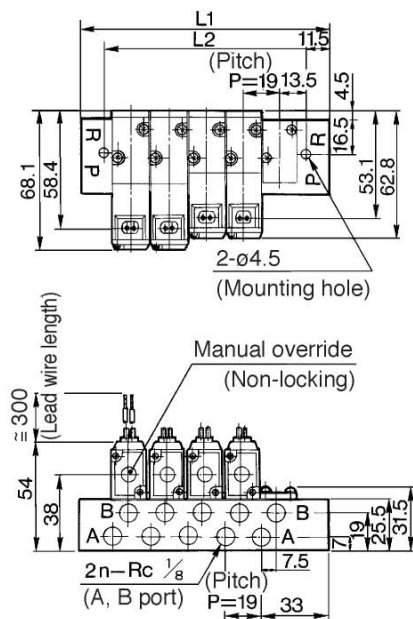
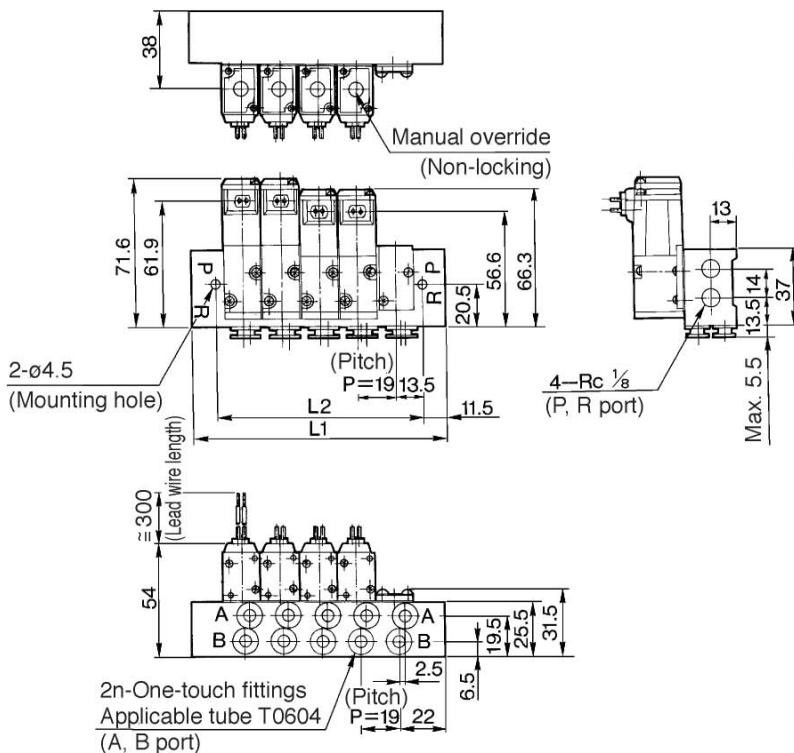

Refer to the above drawing for DIN terminal dimensions.



Refer to the above drawing for other dimensions.

L	n	1	2	3	4	5	6	7	8	9	10	11	12	13	14	15	16	17	18	19	20
L ₁		50	69	88	107	126	145	164	183	202	221	240	259	278	297	316	335	354	373	392	411
L ₂		27	46	65	84	103	122	141	160	179	198	217	236	255	274	293	312	331	350	369	388