

# Series VQ0000

## Base Mounted

### Plug Lead Unit

### How to Order Manifold

**VV5Q 05 - 08 C4 F U1 - D**

Series/Manifold  
05 VQ0000

Kit type

Option

#### Stations

01	1 station
⋮	⋮

The number of max. stations differs from kit to kit. (Refer to the table below.)

Symbol	Port size
C3	With One-touch fitting for ø3.2
C4	With One-touch fitting for ø4
M5	M5 thread
CM	With mixed size/with port plug <sup>Note)</sup>

- Note 1) Specify "Mixed size/with port plug" on the manifold specification sheet.
- Note 2) For inch-size One-touch fittings, refer to "Option" on page 2-4-216.
- Note 3) M5 fittings for M5 thread are attached without being incorporated.

Symbol	Option
Nil	None
D	DIN rail mounting style <sup>(2)</sup>
K	Special wiring specifications (Not double wiring) <sup>(3)</sup>
N	With name plate
S	Built-in silencer, direct exhaust

- Note 1) When two or more symbols are specified, indicate them alphabetically. Example) -DNS
- Note 2) F, P, S, and T kits for VQ0000 are all equipped with a DIN rail, so include suffix "-D."
- Note 3) Specify the wiring specifications on the manifold specification sheet. (Except C kit)

Simple specials are available with SMC Simple Specials System. For details about applicable models, please contact SMC.

#### Kit/Electrical entry: Cable length

**F** kit  
(D-sub connector)

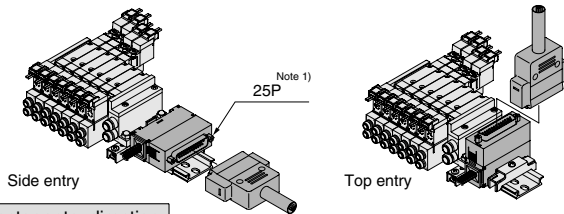

Connector entry direction		Kit		Cable length	Max. stations <sup>(2)</sup>
Top entry	Side entry	U	S		
F	F	U0	S0	Without cable	Max. 16 stations
		U1	S1	With cable (1.5 m)	
		U2	S2	With cable (3 m)	
		U3	S3	With cable (5 m)	

P. 2-4-188

**P** kit  
(Flat ribbon cable connector)

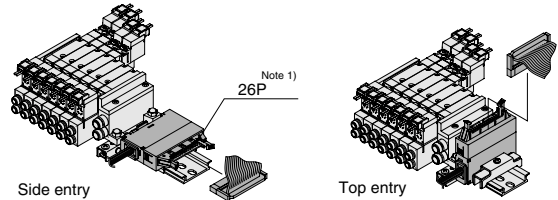

Connector entry direction		Kit		Cable length	Max. stations <sup>(2)</sup>
Top entry	Side entry	U	S		
P	P	U0	S0	Without cable	Max. 16 stations
		U1	S1	With cable (1.5 m)	
		U2	S2	With cable (3 m)	
		U3	S3	With cable (5 m)	

P. 2-4-192

**T** kit  
(Terminal block)

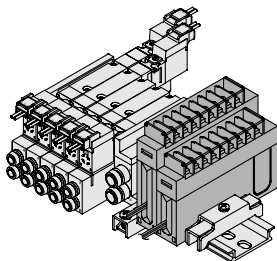

Kit	Number of terminals:	Applicable stations
1	8, 1 row	1 to 8 stations
2	16, 2 rows	5 to 16 stations

P. 2-4-196

**C** kit  
(Connector)

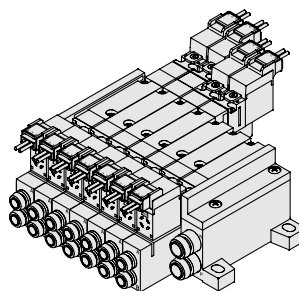

C	Connector kit	Max. 16 stations
---	---------------	------------------

P. 2-4-200

**S** kit  
(Serial transmission unit)

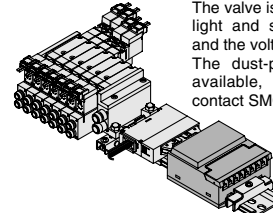

The valve is equipped with an indicator light and surge voltage suppressor, and the voltage is 24 VDC. The dust-protected type SI unit is available, too. For details, please contact SMC.

Kit	Option	Max. stations <sup>(2)</sup>
0	Without SI unit	Max. 16 stations
A	With general type SI unit (Series EX300)	
B	Mitsubishi Electric Corp.: MELSECNET/mini-S3 Data Link System	
C	OMRON Corp.: SYSBUS Wire System	
D	SHARP Corp.: Satellite I/O Link System	
F1	NKE Corp.: Uni-wire System (16 output points)	
H	NKE Corp.: Uni-wire H System	

P. 2-4-204

Note 1) Besides the above, F and P kits with different number of pins are available. Refer to page 2-4-215 for details.

Note 2) For details, refer to page 2-4-216.

Note 3) Please consult with SMC for the following serial transmission kits: Matsushita Electric Works, Ltd.; Rockwell Automation, Inc.; SUNX Corporation; Fuji Electric Co., Ltd.; OMRON Corporation.

### How to Order Valves

**VQ 0 1 5 0 Y 5 LO**

**Series**  
**0** VQ0000

**Type of actuation**

**1** 2 position single (A/B) (R1/P1/R2)

**2** 2 position double (A/B) (R1/P1/R2)

**3** 3 position closed center (A/B) (R1/P1/R2)

**4** 3 position exhaust center (A/B) (R1/P1/R2)

**Manual override**  
**Nil:** Non-locking push type (Tool required)  
**B:** Locking type (Tool required)

**Electrical entry**

**G:** Grommet (C Kit only) (Except AC)  
**L:** L plug connector With lead wire With light/surge voltage suppressor  
**LO:** L plug connector Without connector With light/surge voltage suppressor

**M:** M plug connector With lead wire With light/surge voltage suppressor  
**MO:** M plug connector Without connector With light/surge voltage suppressor

**Body type**  
**5** VQ0000

**Seal**  
**0** Metal seal  
**1** Rubber seal

**Function**

Symbol	Specifications	DC	AC
Nil	Standard type	(1.0 W) ○	Note) ○
H	High pressure type	(1.5 W) ○	—
Y	Low wattage type	(0.5 W) ○	—

**Coil voltage**

<b>1</b>	100 VAC (50/60 Hz)
<b>2</b>	200 VAC (50/60 Hz)
<b>3</b>	110 VAC (50/60 Hz)
<b>4</b>	220 VAC (50/60 Hz)
<b>5</b>	24 VDC
<b>6</b>	12 VDC

Note 1) LO or MO type valve is used for F, P, T, and S kits. The plug connector and lead wire are attached to the manifold.  
 Note 2) In cases of L and M type the connector direction is based on the pilot valve.

### How to Order Valve Manifold Assembly

**Example**

Closed center (24 VDC)  
 VQ0350-5MO

Double solenoid (24 VDC)  
 VQ0250-5MO

Single solenoid (24 VDC)  
 VQ0150-5MO

Stations: 1, 2, 3, 4, 5, 6, 7

3 m

**VVQ05-07C4FS2-D...1** set (F kit 7 station manifold base no.)  
 \* **VQ0150-5MO...3** sets (Single solenoid part no.)  
 \* **VQ0250-5MO...2** sets (Double solenoid part no.)  
 \* **VQ0350-5MO...2** sets (3 position solenoid part no.)

The asterisk denotes the symbol for assembly. Prefix it to the part nos. of the solenoid valve, etc.

Specify the part numbers for valves and options together beneath the manifold base part number. Besides, when the arrangement will be complicated, specify them by means of the manifold specification sheet.

VQC

SQ

VQ0

VQ4

VQ5

VQZ

VQD

Note 1) For negative common specifications, refer to "Option" on page 2-4-216.  
 Note 2) F, P, T and S kits requires connector assembly when increasing valve stations. Refer to "Option" on page 2-4-216 for parts nos.

Note) For power consumption of AC type, refer to page 2-4-186.

Note) The C kits are applicable to 200/220 VAC. Please contact SMC for other kits.

### Manifold Option

P. 2-4-208

**Blanking plate assembly**  
 VVQ0000-10A-5

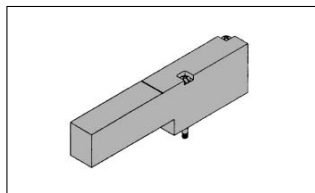

**Name plate [-N\*]**  
 VVQ0000-N5-Station (1 to Max. stations)

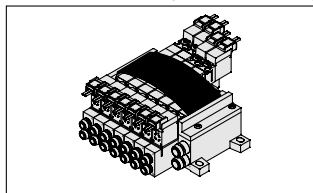

**DIN rail mounting bracket [-D]**  
 VVQ0000-57A-5

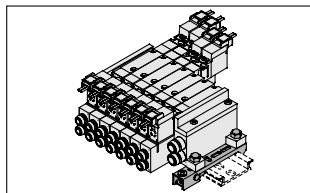

**Silencer**  
 AN103-X233

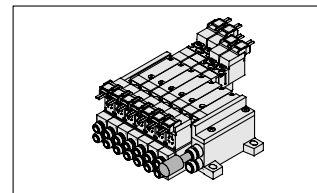

**SUP/EXH block plate**  
 VVQ0000-16A-5-<sup>R</sup><sub>PR</sub>

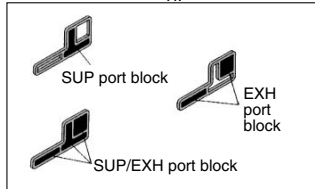

**Double check block**  
 VQ1000-FPG-□□

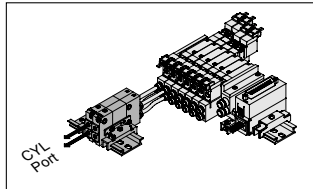

**Built-in silencer, direct exhaust [-S]**

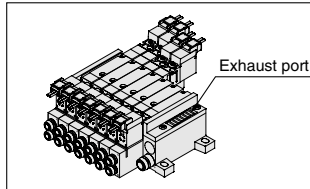

**Blanking plug**  
 KQ2P-<sup>R</sup><sub>BEACH</sub>

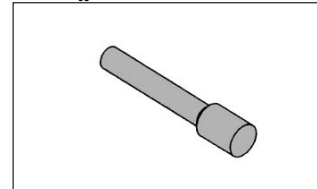

- For cylinder port fittings part no., refer to page 2-4-213.
- For replacement parts, refer to page 2-4-231.

**Individual SUP spacer**  
 VVQ0000-P-5-C4

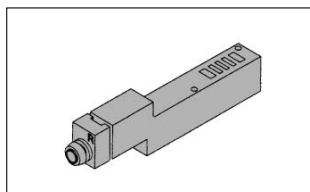

**Individual EXH spacer**  
 VVQ0000-R-5-C4

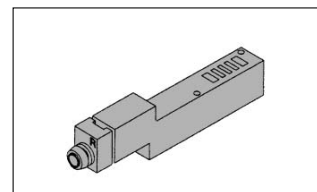

# Plug Lead Unit Series VQ0000/1000

## Manifold Specifications

Series	Base model	Type of connection	Porting specifications		Applicable stations <sup>(2)</sup>	Applicable solenoid valve	5 station weight (g)	
			Port location	Port size <sup>(1)</sup>				
				1(P), 3(R)	4(A), 2(B)			
VQ0000	VV5Q05-□□□	<ul style="list-style-type: none"> <li>■ F kit—D-sub connector</li> <li>■ P kit—Flat ribbon cable connector</li> <li>■ T kit—Terminal block</li> <li>■ C kit—Individual connector</li> <li>■ S kit—Serial transmission</li> </ul>	Side	C6 (ø6) Option (Built-in silencer, direct exhaust)	C3 (ø3.2) C4 (ø4) M5 (M5 thread)	1 to 16 stations	VQ0□50 VQ0□51	330 (Single) 400 (Double, 3 position)
VQ1000	VV5Q12-□□□	<ul style="list-style-type: none"> <li>■ F kit—D-sub connector</li> <li>■ P kit—Flat ribbon cable connector</li> <li>■ T kit—Terminal block</li> <li>■ C kit—Individual connector</li> <li>■ S kit—Serial transmission</li> </ul>	Side	C8 (ø8) Option (Built-in silencer, direct exhaust)	C3 (ø3.2) C4 (ø4)C6 (ø6) M5 (M5 thread)	1 to 16 stations	VQ1□10 VQ1□11	818 (Single) 885 (Double, 3 position)



Note 1) Inch-size One-touch fittings are also available. For details, refer to page 2-4-216.

Note 2) For details, refer to page 2-4-216.

VQC

SQ

VQ0

VQ4

VQ5

VQZ

VQD

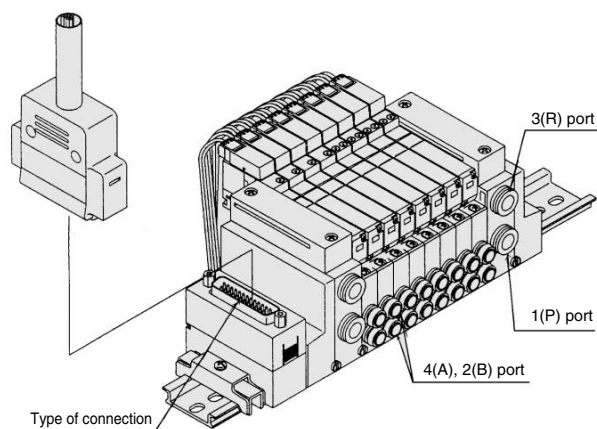
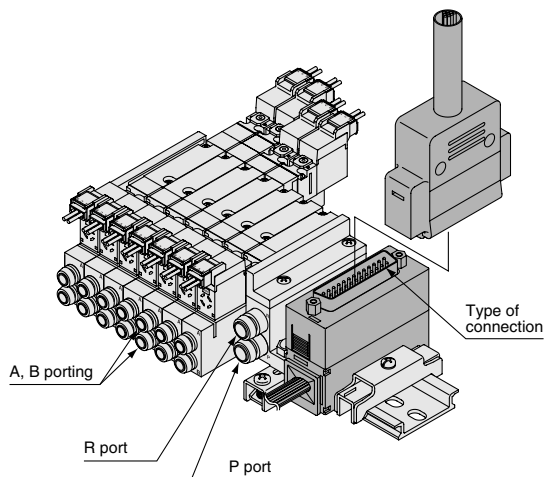

VV5Q12

# P VQ0000/1000 Kit (Flat ribbon cable connector)

- MIL flat ribbon cable connector reduces installation labor savings for electrical connection.
- Using the connector for flat ribbon cable (26P), (10P, 16P, 20P as an option) conforming to MIL standard permits the use of connectors put on the market and gives a wide interchangeability.  
Top or side receptacle position can be selected in accordance with the available mounting space.
- Maximum stations are 16.

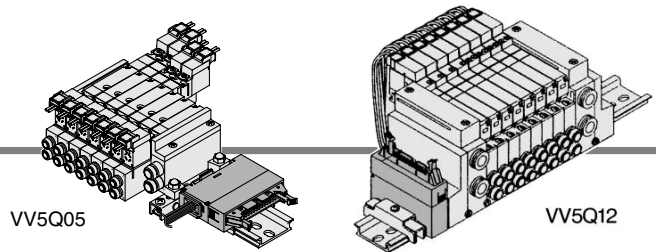

## Manifold Specifications

Series	Port location	Porting specifications		Applicable stations
		1(P), 3(R)	4(A), 2(B)	
VQ0000	Side	C6	C3, C4, M5	Max.16 stations
VQ1000	Side	C8	C3, C4, C6, M5	Max.16 stations

## Flat Ribbon Cable (26 pins)

**AXT100-FC26-<sup>1</sup>/<sub>3</sub>**  
 ( Flat ribbon cable connector assembly can be ordered individually or included in a specific manifold model no. Refer to "How to Order Manifold". )

**Flat Ribbon Cable Connector Assembly (Option)**

Cable length (L)	Assembly part no.	Note
1.5 m	AXT100-FC26-1	Cable 26 cores x 28AWG
3 m	AXT100-FC26-2	
5 m	AXT100-FC26-3	

\* For other commercial connectors, use a 26 pins type with strain relief conforming to MIL-C-83503.

**Connector manufacturers' example**

- Hirose Electric Co., Ltd.
- Sumitomo 3M Limited
- Fujitsu Limited
- Japan Aviation Electronics Industry, Ltd.
- J.S.T. Mfg. Co., Ltd.
- Oki Electric Cable Co., Ltd.

Note) Types with 10, 16, or 20 pin are also available. Refer to page 2-4-215 for details.

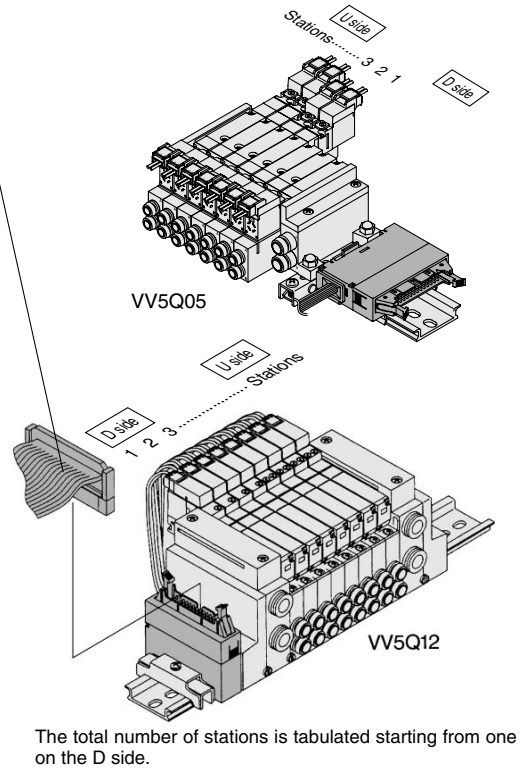

## How to Order Manifold

**VV5Q 12-08 C6 P U 1-D**

**Series/Manifold**

05	VQ0000	Plug lead unit
12	VQ1000	

**Stations**

01	1 station
⋮	⋮
16	16 stations <sup>Note)</sup>

**Connector entry direction**

U	Top (Vertical)
S	Side (Horizontal)

**Cable (Length)**

0	Without cable
1	With cable (1.5 m)
2	With cable (3 m)
3	With cable (5 m)

**Cylinder port**

Symbol	Port size	VQ0000	VQ1000
C3	With One-touch fitting for ø3.2	●	●
C4	With One-touch fitting for ø4	●	●
C6	With One-touch fitting for ø6	●	●
M5	M5 thread	●	●
CM	With mixed size/with port plug	●	●

**Option**

Symbol	Option	VQ0000	VQ1000
B	With back pressure check valve	●	● <sup>(2)</sup>
D	DIN rail mounting style	●	● <sup>(3)</sup>
K	Special wiring specification (Not double wiring)	●	● <sup>(4)</sup>
N	With name plate	●	●
S	Built-in silencer (Direct exhaust)	●	●

Note) As an option, the maximum number of stations can be increased by special wiring specifications. For details, refer to page 2-4-216.

Note 1) Specify "Mixed size/with port plug" on the manifold specification sheet.  
 Note 2) For inch-size One-touch fittings, refer to "Option" on page 2-4-216.

Note 1) When two or more symbols are specified, indicate them alphabetically. Example) -BNS  
 Note 2) Models with a suffix "B" have the back pressure check valve at all manifold stations. If not all stations need this check valve, specify the stations where check valves are installed by using the manifold specification sheet.  
 Note 3) P kit of VQ0000 and all of VQ1000 are equipped with a DIN rail, so indicate suffix "D".  
 Note 4) Specify the wiring specifications on the manifold specification sheet.



VQC

SQ

VQ0

VQ4

VQ5

VQZ

VQD

● Electrical wiring specifications

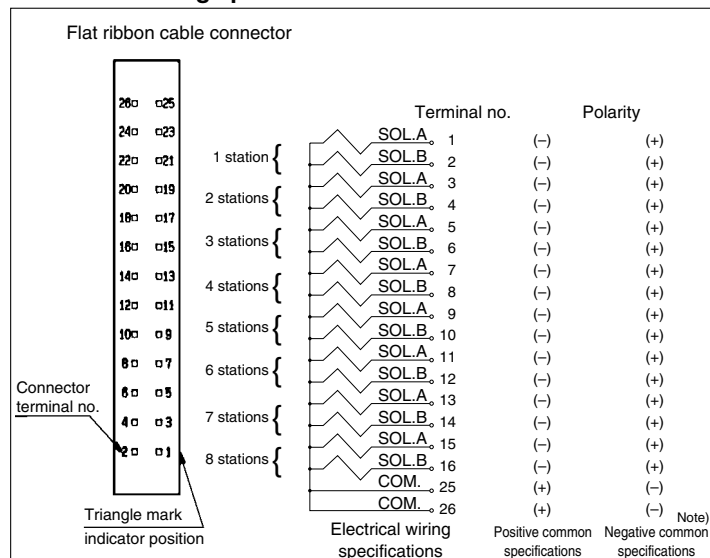

As the standard electrical wiring specifications, double wiring (connected to SOL. A and SOL. B) is adopted for the internal wiring of each station for 8 stations or less, regardless of valve and option types.

Mixed single and double wiring is available as an option.

For details, refer to page 2-4-216.

Note) When using the negative commons specifications, use valves for negative common. (Refer to page 2-4-216.)

How to Order Valves

**VQ 1 1 1 0 Y 5 LO**

**Series**

0	VQ0000
1	VQ1000

**Type of actuation**

1	2 position single
2	2 position double
3	3 position closed center
4	3 position exhaust center
5	3 position pressure center (VQ1000 only)

**Body type**

5	VQ0000	Plug lead unit
1	VQ1000	Plug lead unit

**Manual override**

Nil	Non-locking push type (Tool required)
B	Locking type (Tool required)
C	Locking type (Manual) <sup>Note)</sup>

Note) VQ1000 only.

**Electrical entry**

	VQ0000	VQ1000
LO	L plug connector without connector	●
MO	M plug terminal without connector	●

Note) Plug connector and lead wire are attached to the manifold.

**Coil voltage**

	VQ0000	VQ1000
1	100 VAC (50/60 Hz)	●
3	110 VAC (50/60 Hz)	●
5	24 VDC	●
6	12 VDC	●

**Function**

Symbol	Specifications	DC	AC
Nil	Standard type	(1.0 W) ○	Note) ○
H	High pressure type	(1.5 W) ○	—
Y	Low wattage type	(0.5 W) ○	—

Note) For power consumption of AC type, refer to page 2-4-186.

**Seal**

0	Metal seal
1	Rubber seal

Note 1) For negative common specifications, refer to Note 2)  
Note 2) Connector assembly will be required when the P kits add a valve. For part nos., refer to "Option" on page 2-4-126.

How to Order Manifold Assembly

Specify the part numbers for valves and options together beneath the manifold base part number.

<Example>

Flat ribbon cable kit with 3 m cable

VV5Q12-08C6PU1-D ...1 set—Manifold base no.  
\*VQ1110-5LO .....4 sets—Valve part no. (Stations 1 to 4)  
\*VQ1210-5LO .....3 sets—Valve part no. (Stations 5 to 8)

Prefix the asterisk to the part nos. of the solenoid valve, etc. Write sequentially from the 1st station on the D side. When part nos. written collectively are complicated, specify by using the manifold specification sheet.

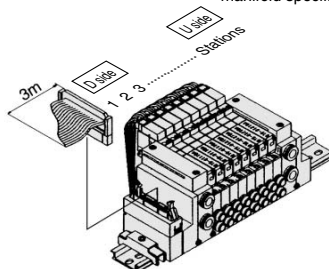

# P VQ0000/1000 Kit (Flat ribbon cable connector)

## VQ0000

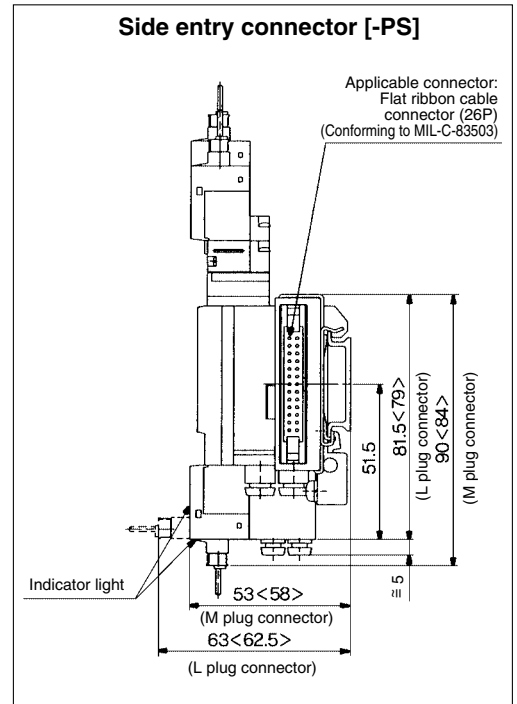
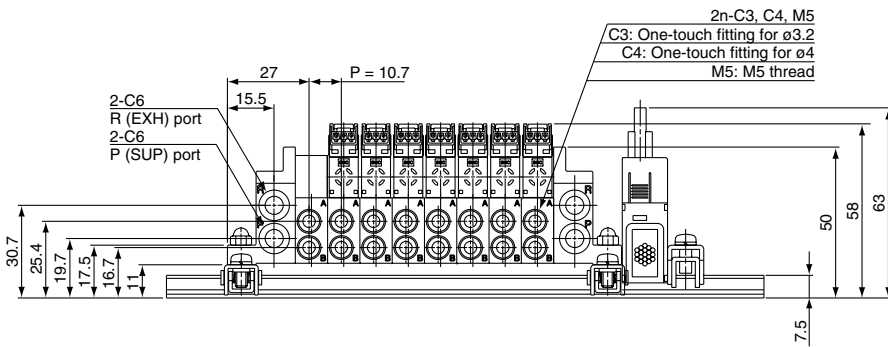
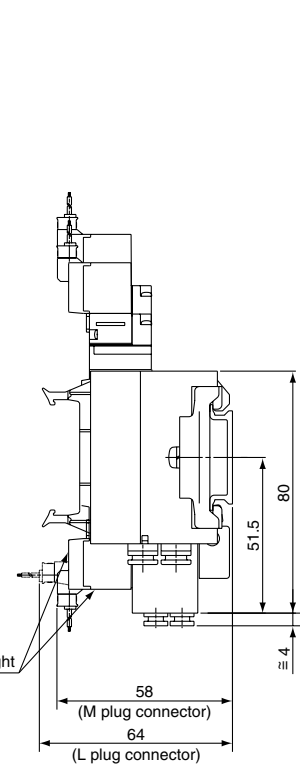
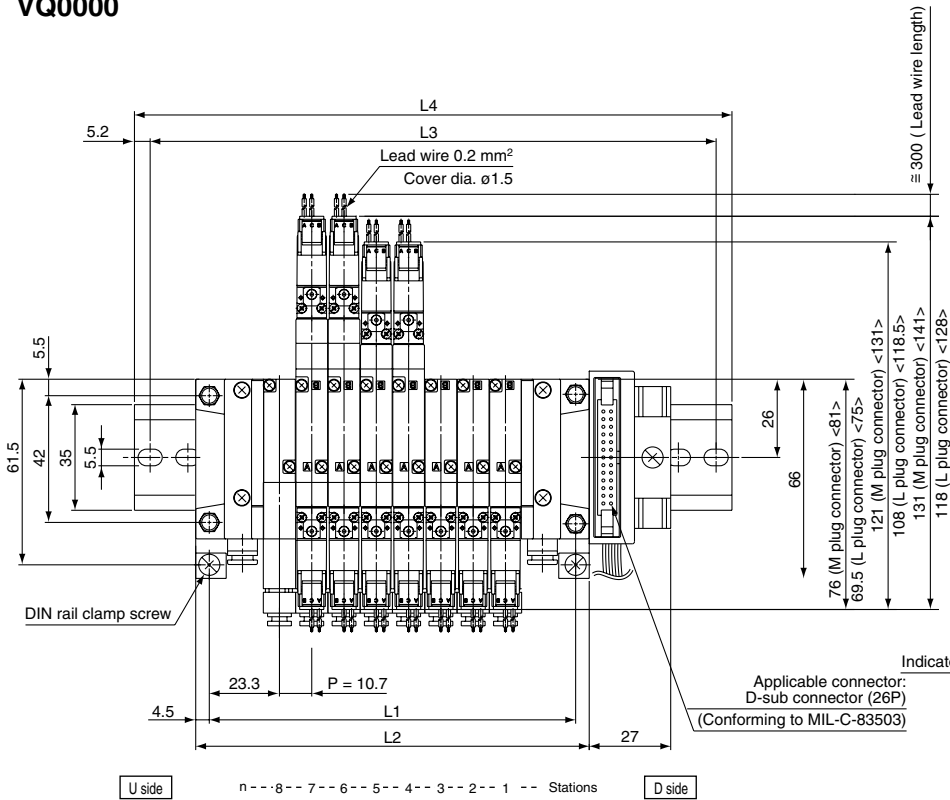

< >: AC

### Dimensions: Top Entry Connector [-PU]

L	n	1	2	3	4	5	6	7	8	9	10	11	12	13	14	15	16
L1		46.7	57.4	68.1	78.8	89.5	100.2	110.9	121.6	132.3	143	153.7	164.4	175.1	185.8	196.5	207.2
L2		55.7	66.4	77.1	87.8	98.5	109.2	119.9	130.6	141.3	152	162.7	173.4	184.1	194.8	205.5	216.2
L3		112.5	125	125	137.5	150	162.5	175	187.5	200	200	212.5	225	237.5	250	262.5	275
L4		123	135.5	135.5	148	160.5	173	185.5	198	210.5	210.5	223	235.5	248	260.5	273	285.5

### Dimensions: Side Entry Connector [-PS]

L	n	1	2	3	4	5	6	7	8	9	10	11	12	13	14	15	16
L3		137.5	150	150	162.5	175	187.5	200	212.5	225	225	237.5	250	262.5	275	287.5	300
L4		148	160.5	160.5	173	185.5	198	210.5	223	235.5	235.5	248	260.5	273	285.5	298	310.5

Formula L1 = 10.7n + 36, L2 = 10.7n + 45  
n: Station (Maximum 16 stations)

# Series VQ0000

## Manifold Option Parts for VQ0000

### Blanking plate assembly VVQ0000-10A-5

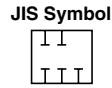

It is used by attaching on the manifold block for being prepared for removing a valve for maintenance reasons or planning to mount a spare valve, etc.

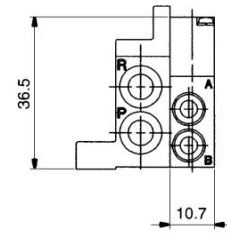
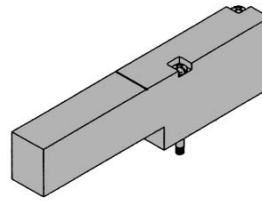

### Individual SUP spacer VVQ0000-P-5-C4

When the same manifold is to be used for different pressures, this spacer is mounted under the valve to equip each valve with an individual supply port.

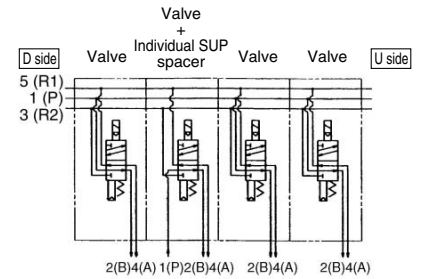
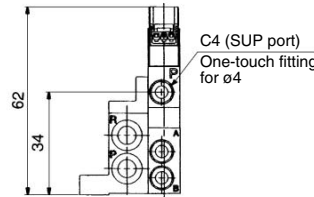
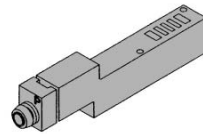

### Individual EXH spacer VVQ0000-R-5-C4

When a valve exhaust affects other stations due to the circuit configuration, this spacer is mounted under the valve to equip each valve with an individual valve exhaust.

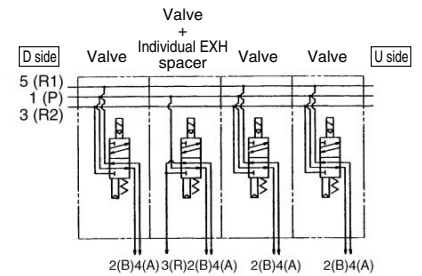
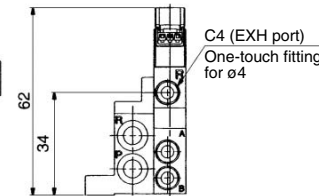
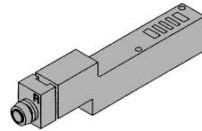

### SUP/EXH block plate VVQ0000-16A-5

P (SUP)  
R (EXH)  
PR (SUP/EXH)

#### 1(P) (For SUP)

When different pressures, high and low, are supplied to one manifold, block a plate is inserted between the stations under different pressures.

#### 3(R) (For EXH)

When a valve exhaust affects other stations due to the circuit configuration, this plate is used between the stations where exhaust should be separated.

#### 1(P), 3(R) (For SUP/EXH)

When blocking SUP and EXH simultaneously, SUP/EXH block plate (PR) is used.

\* Specify the number of stations on the manifold specification sheet.

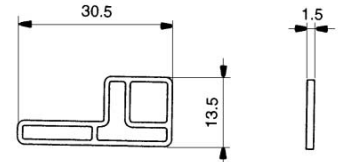
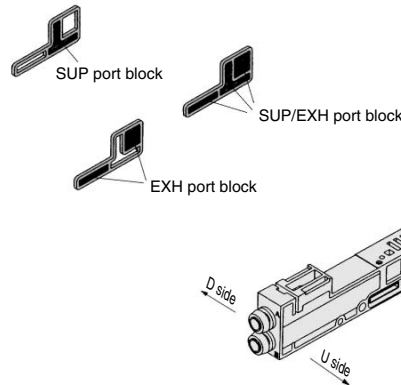

### <Blocking indication label>

When blocking the SUP, EXH passage with a SUP, EXH block plate, indication label for confirmation of the blocking position from outside is attached. (One label for each)

\* When ordering a block plate incorporated with the manifold no., a block indication label is attached to the manifold.

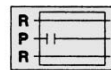

SUP passage blocked  
(VVQ0000-16A-5-P)

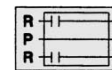

EXH passage blocked  
(VVQ0000-16A-5-R)

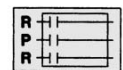

SUP/EXH passage blocked  
(VVQ0000-16A-5-PR)

### Name plate [-N\*]

#### VVQ0000-N5-Station (1 to Max. stations)

It is a transparent resin plate for placing a label that indicates solenoid valve function, etc. Insert it into the groove on the side of the end plate and bend it as shown in the figure.

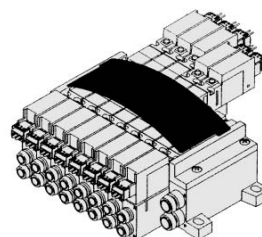

\* When ordering assemblies incorporated with a manifold, add suffix "N" to the manifold no.

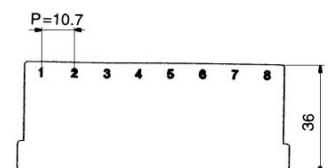

**Blanking plug (For One-touch fittings)**

**KQ2P-<sup>23</sup><sub>04</sub><sub>06</sub>**

It is inserted into an unused cylinder port and SUP/EXH ports.

Purchasing order is available in units of 10 pieces.

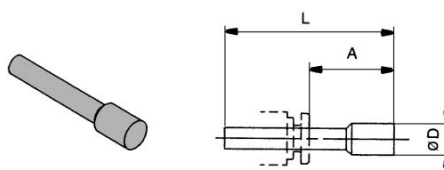

**Dimensions**

Applicable fitting size $\phi$ d	Model	A	L	D
3.2	KQ2P-23	16	31.5	3.2
4	KQP-04	16	32	6
6	KQP-06	18	35	8

**DIN rail mounting bracket [-D]**

**VVQ0000-57A-5 (VQ0000)**

It is used for mounting a VV5Q05 type manifold on a DIN rail. The DIN rail mounting bracket is fixed to the manifold end plate. (The specification is the same as that for the option "-D".)

1 set of DIN rail mounting bracket is used for 1 set of manifold (2 DIN rail mounting brackets).

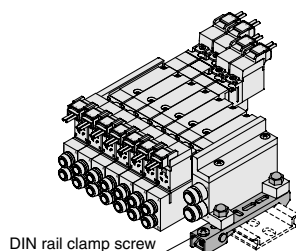

DIN rail clamp screw

\* When ordering assemblies incorporated with a manifold, add suffix "-D" to the manifold no.

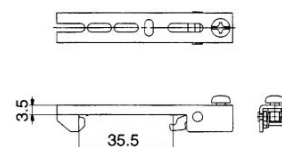

**Built-in silencer, Direct exhaust [-S]**

This is an exhaust port on the manifold end plate. The built-in silencer exhibits an excellent noise suppression effect. (Silencing effect: 20 dB)



Note) A large quantity of drainage generated in the air source results in exhaust of air together with drainage.

- For maintenance, refer to page 2-4-214.

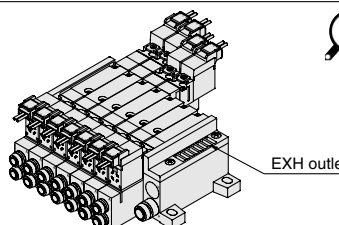

EXH outlet



\* When ordering assemblies incorporated with a manifold, add suffix "-S" to the manifold no.

**Silencer (For EXH port)**

This is inserted into the centralized type EXH port (One-touch fitting).

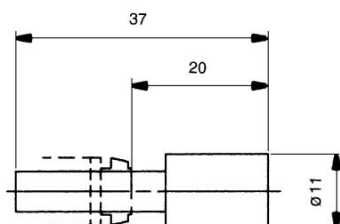

**Dimensions**

Series	Applicable fitting size $\phi$ d	Model	A	L	D	Effective area (mm <sup>2</sup> )	Noise reduction (dB)
VQ0000	6	AN103-X233	20	37	11	7	25

VQC

SQ

VQ0

VQ4

VQ5

VQZ

VQD



## ⚠ Precautions 1

Be sure to read before handling. For Safety Instructions and Solenoid Valve Precautions, refer to page 2-9-2.

### Light/Surge Voltage Suppressor

#### ⚠ Caution

In the case of VQ1000, the standard model is equipped with an indicator light and surge voltage suppressor. The lighting positions are concentrated on one side for both single solenoid type and double solenoid type.

For the double solenoid type, A side and B side energization are indicated by two colors which match the colors of the manual overrides.

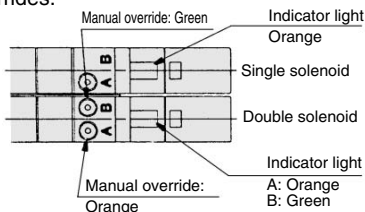

\* In the case of VQ0000, solenoid and manual override on both sides.

#### DC circuit diagram VQ0000

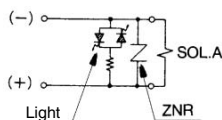

\* In the case of VQ0000, solenoid and manual override on both sides.

Note) A side energization:  
A light (orange) illuminates.  
With wrong wiring preventing ability (stop diode)  
B side energization:  
B light (green) illuminates.  
Equipped with a surge absorption (surge absorption diode) mechanism.

#### VQ1000 (DC)/Single solenoid

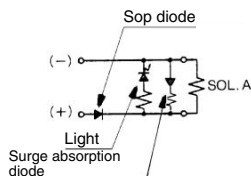

#### VQ1000/Double solenoid

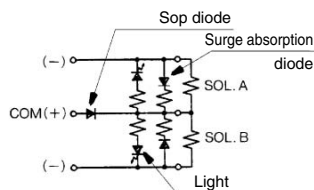

### Manual Override

#### ⚠ Warning

Without an electric signal for the solenoid valve the manual override is used for switching the main valve.

Push type is standard. (Tool required)

Option: Locking type (Tool required/Manual)

##### ■ Push type (Tool required)

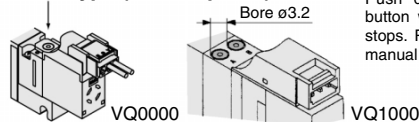

Push down on the manual override button with a small screwdriver until it stops. Release the screwdriver and the manual override will return.

##### ■ Locking type (Tool required) <Option>

If the manual override is turned by 180° clockwise and the ► mark is adjusted to 1, it will be locked in the ON state.  
If the manual override is turned by 180° counterclockwise and the ► mark is adjusted to 0, locking will be released and the manual override will return.

Push down completely on the manual override button with a small screwdriver. While down, turn clockwise 90° to lock it. Turn it counterclockwise to release it.

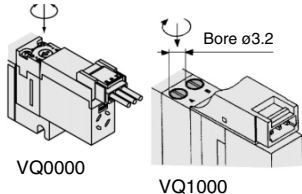

##### ■ Locking type (Manual) <Option>

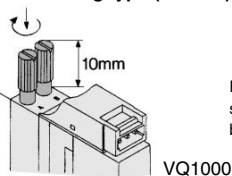

Push down on the manual override button with a small screwdriver or with your fingers until it stops. Turn clockwise by 90° to lock it. Turn it counterclockwise to release it.

#### ⚠ Caution

Do not apply excessive torque when turning the locking type manual override. (0.1 N·m or less)

### How to Mount/Remove Solenoid Valve

#### ⚠ Caution

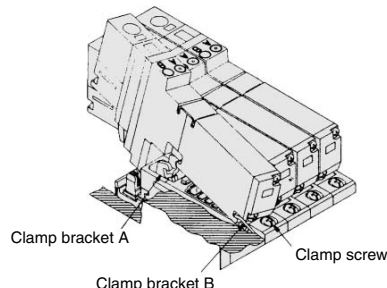

##### How to Remove

1. Loosen the clamp screw until it turns freely. (The screw is captive.)
2. Lift the coil side of the valve body while pressing down slightly on the screw head and remove it from the clamp bracket B. When the screw head cannot be pressed easily, gently press the area near the manual override of the valve.

##### How to Remove

1. Press down on the clamp screw. → Clamp bracket A opens. Diagonally insert the hook on the valve end plate side into clamp B.
2. Press the valve body downward. (When the screw is released, it will be locked by clamp bracket A.)
3. Tighten the clamp screw. (Proper tightening torque: 0.25 to 0.35 N·m)

##### Mounting

1. Dust on the sealing surface of the gasket or solenoid valve can cause air leakage.
2. In the case of VQ0000, valve mounting screw clamping torque is 0.18 to 0.25 N·m.

### Replacement of Cylinder Port Fittings

#### ⚠ Caution

The cylinder port fittings are a cassette for easy replacement. The fittings are blocked by a clip inserted from the top of manifold. Remove the clip with a screwdriver to remove fittings. For replacement, insert the fitting assembly until it strikes against the inside wall and then re-insert the clip to specified position.

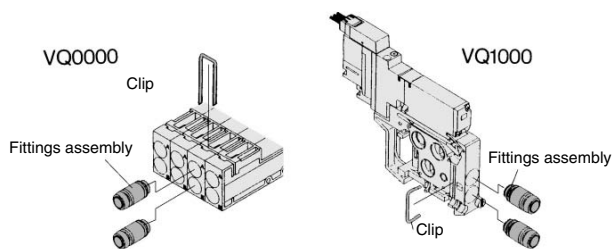

Take off the valve and remove the clip.

Remove the clip after taking off the manifold.

Applicable tubing O.D.	Fitting assembly part no.	
	VQ0000	VQ1000
Applicable tubing ø3.2	VVQ1000-51A-C3	VVQ1000-50A-C3
Applicable tubing ø4	VVQ1000-51A-C4	VVQ1000-50A-C4
Applicable tubing ø6	—	VVQ1000-50A-C6
M5	—	VVQ1000-50A-M5

\* Refer to "Option" on pages 2-4-208 to 2-4-211 for other types of fittings.

#### ⚠ Caution

1. Use caution that O-rings must be free from scratches and dust. Otherwise, air leakage may result.
2. After screwing in the fittings, mount the M5 fitting assembly on the manifold base. (Tightening torque 0.8 to 1.2 N·m)
3. Purchasing order is available in units of 10 pieces.

VQC

SQ

VQ0

VQ4

VQ5

VQZ

VQD

## ⚠ Precautions 2

Be sure to read before handling. For Safety Instructions and Solenoid Valve Precautions, refer to page 2-9-2.

### How to Use Plug Connector

#### ⚠ Caution

##### Attaching and detaching connectors

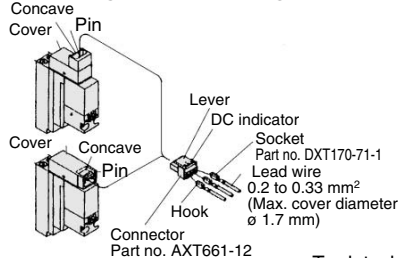

To attach a connector, hold the lever and connector unit between your fingers and insert straight onto the pins of the solenoid valve so that the lever's pawl is pushed into the groove and locks.

To detach a connector, remove the pawl from the groove by pushing the lever downward with your thumb, and pull the connector straight out.

##### Crimping the lead wire and socket

Peel 3.2 to 3.7 mm of the tip of lead wire, neatly into a socket and press contact it by a press tool. Be careful so that the cover of lead wire does not enter into the core press contacting part.

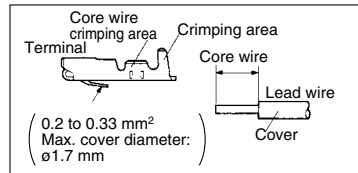

##### Attaching and detaching lead wires with sockets

**Attaching**  
Insert a socket in the square hole (Indicated as ⊕, ⊖) of connector, push in the lead wire and lock by hanging the hook of socket to the seat of connector. (Pushing-in can open the hook and lock it automatically.) Then confirm the lock by lightly pulling on the lead wire.

##### Detaching

For pulling-out the socket from the connector, pull out the lead wire while pushing the hook of the socket with a fine point (ca. 1 mm) tool. If the socket is to be re-used, spread the hook to the outside.

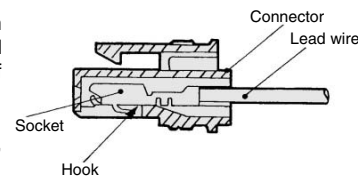

### Mounting/Removing from the DIN Rail (VQ1000)

#### ⚠ Caution

##### Removing

- Loosen the clamp screw on side (a) of the end plate on both sides.
- Lift side (a) of the manifold base and slide the end plate in the direction of (2) shown in the figure to remove.

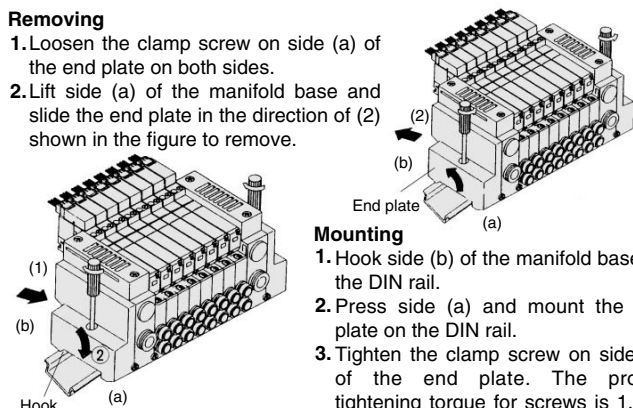

##### Mounting

- Hook side (b) of the manifold base on the DIN rail.
- Press side (a) and mount the end plate on the DIN rail.
- Tighten the clamp screw on side (a) of the end plate. The proper tightening torque for screws is 1.2 to 1.6 N·m.

### Enclosure IP65

#### ⚠ Caution

Wires, cables, connectors, etc. used for models conforming to IP65 should also have enclosures equivalent to or of stricter than IP65.

### How to Calculate the Flow Rate

#### ⚠ Caution

For obtaining the flow rate, refer to pages 2-1-8 to 2-1-11.

### Built-in Silencer Replacement

#### ⚠ Caution

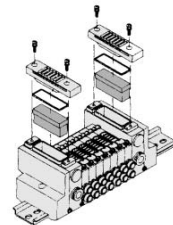

A silencer element is incorporated in the end plate on both sides of the manifold base. A dirty and choked element may reduce cylinder speed and cause malfunction. Clean or replace the dirty element.

Remove the cover from the top of the end plate and remove the old element with a screwdriver, etc.

#### Element part no.

Type	Element part no.	
	VQ0000	VQ1000
Built-in silencer, direct exhaust (-S)	VVQ0000-82A-1	VVQ1000-82A-1

\* The minimum order quantity is 10 pcs.

### Manifold Base Station Increasing Procedure (VQ1000)

#### ⚠ Caution

- Loosen the clamp screw on the top surface of the end plate on one side.
- Turn the manual override between the manifold blocks with a regular screwdriver, etc. in a counterclockwise direction.
- Slide the manifold base to the side where the screw is loosened. Make a clearance of 15 mm or more.
- Mount the station increasing manifold block assembly and solenoid valve on the DIN rail. Install it to the DIN rail by applying the hook on the (b) side of the manifold block and pushing down the (a) side.

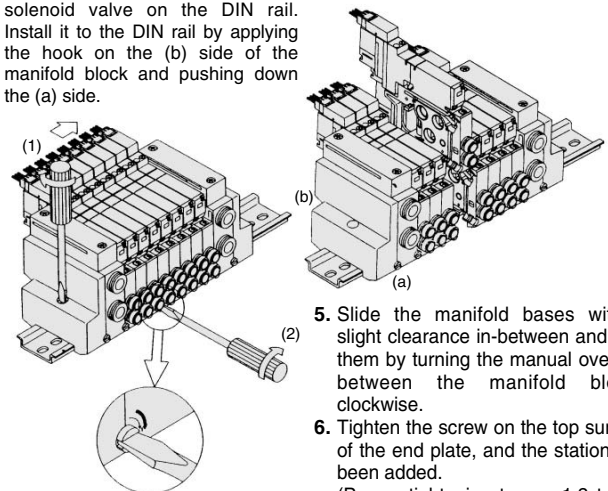
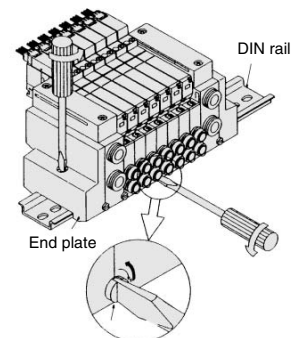

- Slide the manifold bases with a slight clearance in-between and lock them by turning the manual override between the manifold blocks clockwise.
- Tighten the screw on the top surface of the end plate, and the station has been added. (Proper tightening torque 1.2 to 1.6 N·m)

### Manifold Block Assembly

VQ1000	Port size
VVQ1000-1A-2-C3	With One-touch fitting for ø3.2
VVQ1000-1A-2-C4	With One-touch fitting for ø4
VVQ1000-1A-2-C6	With One-touch fitting for ø6
VVQ1000-1A-2-M5	M5 thread

Option

Different Number of Connector Pins

F and P kits with the following number of pins are available besides the standard number (F = 25; P = 26). Select the desired number of pins and cable length from the cable assembly list. Place an order for the cable assembly separately.

**F** kit (D-sub connector) 15 pins

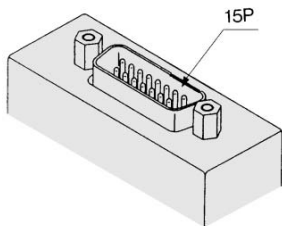

How to order manifold

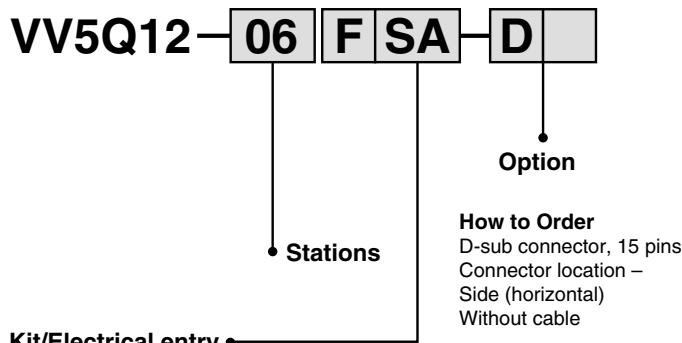

Kit/Electrical entry

Pins	Location	Top entry		Side entry	
15P (Max. 7 stations)		Kit F	UA	Kit F	SA

Wiring Specifications

\* In the same way as the 25-pin models (standard), terminal no. 1 for is SOL.A at the 1st station, terminal no. 9 for SOL.B at the 1st station, and terminal no. 8 for COM.

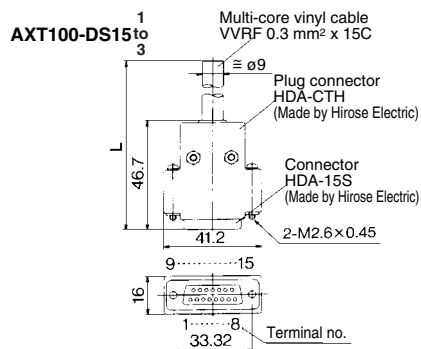

Wire Color by Terminal No. of D-sub Connector Cable Assembly

Terminal no.	Lead wire color	Dot marking
1	Black	None
2	Brown	None
3	Red	None
4	Orange	None
5	Yellow	None
6	Pink	None
7	Blue	None
8	Purple	White
9	Gray	Black
10	White	Black
11	White	Red
12	Yellow	Red
13	Orange	Red
14	Yellow	Black
15	Pink	Black

D-sub Connector Cable Assembly

Cable length (L)	Pins	15P
1.5 m		AXT100-DS15-1
3 m		AXT100-DS15-2
5 m		AXT100-DS15-3

\* For other commercial connectors, use a type conforming to MIL-C-24308.

**P** kit (Flat ribbon cable connector) 10 pins, 16 pins, 20 pins

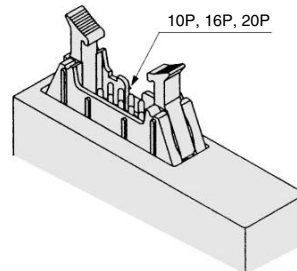

How to order manifold

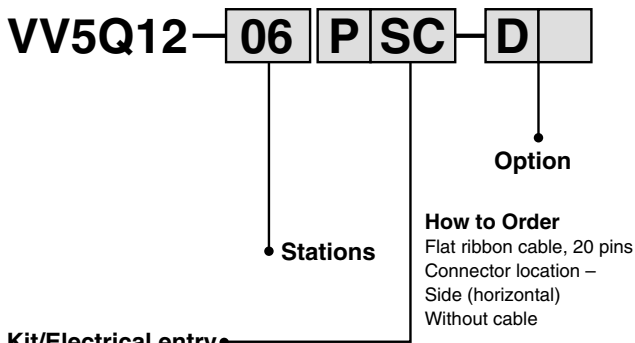

Kit/Electrical entry

Pins	Location	Top entry		Side entry	
10P (Max. 4 stations)		Kit P	UA	Kit P	SA
16P (Max. 7 stations)			UB		SB
20P (Max. 9 stations)			UC		SC

Wiring Specifications

\* In the same way as the 26-pin models (standard), terminal no. 1 is SOL.A at the 1st station, terminal no. 2 for SOL.B at the 1st station, and two pins from the max.

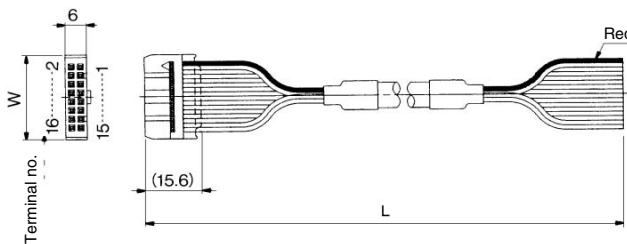

Flat Ribbon Cable Assembly

Cable length (L)	Pins	10P	16P	20P
1.5 m		AXT100-FC10-1	AXT100-FC16-1	AXT100-FC20-1
3 m		AXT100-FC10-2	AXT100-FC16-2	AXT100-FC20-2
5 m		AXT100-FC10-3	AXT100-FC16-3	AXT100-FC20-3
Connector width (W)		17.2	24.8	30

\* For other commercial connectors, use a type with strain relief conforming to MIL-C-83503.

VQC

SQ

VQ0

VQ4

VQ5

VQZ

VQD

# Series VQ0000/1000

## Option

### Special Wiring Specifications

In the internal wiring of F kit, P kit, T kit and S kit, double wiring (connected to SOL. A and SOL. B) is adopted for each station regardless of the valve and option types. Mixed single and double wiring is available as an option.

#### 1. How to Order

Indicate an option symbol "-K", for the manifold no. and be sure to specify the mounting position and number of stations of the single and double wiring by means of the manifold specification sheet.

**Example) VV5Q05-08C4FU1-D K S**

Others, option symbols: to be indicated alphabetically.

#### 2. Wiring specifications

With the A side solenoid of the 1st station as no. 1 (meaning, to be connected to no. 1 terminal), without making any terminals vacant.

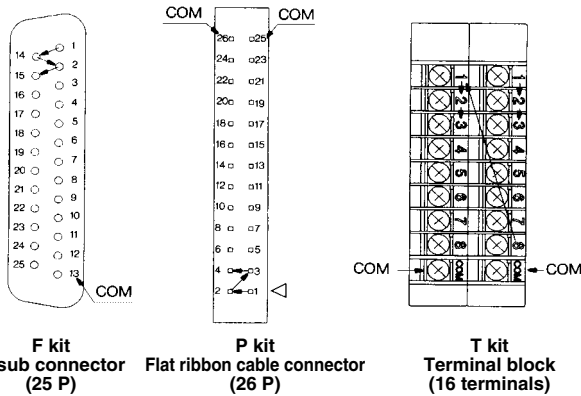

#### 3. Max. number of stations

The maximum number of stations depends upon the number of solenoids. Assuming one for a single and two for a double, determine the number of stations so that the total number is not more than the max. number given in the following table.

Kit	F kit (D-sub connector)		P kit (Flat ribbon cable connector)			T kit (Terminal block)		S kit (Serial transmission)	
	F <sub>S</sub> <sup>U</sup> 25P	F <sub>S</sub> <sup>U</sup> A 15P	P <sub>S</sub> <sup>U</sup> 26P	P <sub>S</sub> <sup>U</sup> C 20P	P <sub>S</sub> <sup>U</sup> B 16P	P <sub>S</sub> <sup>U</sup> A 10P	T1		T2
Type									S□
Max. points	16 <sup>Note)</sup>	14	16 <sup>Note)</sup>	16 <sup>Note)</sup>	14	8	8	16	16

Note) Due to the limitation of internal wiring.

### Negative Common Specifications [Series VQ1□10]

The following valve part numbers are for negative COM specifications. Manifold model no. is the same as the standard products.

#### How to order negative COM valves

**VQ1110 N - 5M**

• Negative common specifications

\* Series VQ0□50 has no polarity, so the negative common is applicable to standard models.

### Inch-size One-touch Fittings

Valve with inch-size One-touch fittings is shown below.

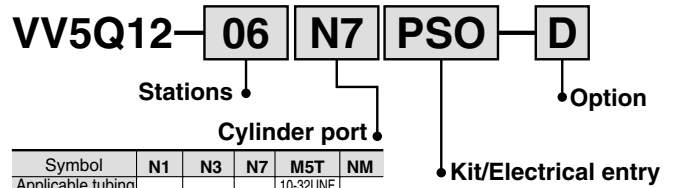

Symbol	N1	N3	N7	M5T	NM
Applicable tubing O.D. (Inch)	ø1/8"	ø5/32"	ø1/4"	10-32UNF (M5 thread)	Mixed
A, B port	○	○	—	○	○
	○	○	○	○	○

1(P), 3(R) port size  
 VQ0000 .....ø1/4"  
 VQ1000 .....ø5/16"

Note) When inch size fittings are selected for a cylinder port, use inch size fittings for both P and R port, too.

### Plug Connector Assembly Model

Connector assembly will be required when the F, P, S kits add a valve. Specify the style of valve and connector assembly.

#### Connector Assembly Part No.

Specifications		Part no.
Single VQ0000 (2-wire)	Positive common	AXT661-14A-F
	Negative common	AXT661-14AN-F
Double (latching) (3-wire)	Positive common	AXT661-13A-F
	Negative common	AXT661-13AN-F

Note) Lead wire length: 300 mm

The part numbers above are applicable to 2 to 10 stations. 11 to 16 stations: "AXT661-13A(N)-F-425".



## DIN Rail Mounting

Each manifold can be mounted on a DIN rail. Order it by indicating a DIN rail mounting option symbol, "-D". In this case, a DIN rail which is approx. 30 mm longer than the manifold with the specified number of stations is attached. Other than this, it is applicable for the following cases.

● **When DIN rail is unnecessary (C kit VQ0000 only)**

Indicate the option symbol, -DO, for the manifold no.

Example)

**VV5Q05-08C4C-DOS**

Others, option symbols:  
to be indicated alphabetically.

● **When using DIN rail longer than the manifold with specified number of stations (VQ0000/VQ1000)**

Clearly indicate the necessary number of stations next to the option symbol. "D" for the manifold no.

Example)

**VV5Q05-08C4FU1-D09S**

DIN rail for 9 stations  
Others, option symbols:  
to be indicated alphabetically.

● **When changing the manifold style into a DIN rail mounting style (VQ0000 only)**

Order brackets for mounting a DIN rail. (Refer to "Option" on page 2-4-209.)

No. VVQ0000-57A-5 2 pcs. per one set.

● **When ordering DIN rail only (VQ0000 only)**

DIN rail no.: AXT100-DR-□

As for □, specify the number from the DIN rail table.  
For L dimension, refer to the dimensions of each kit.

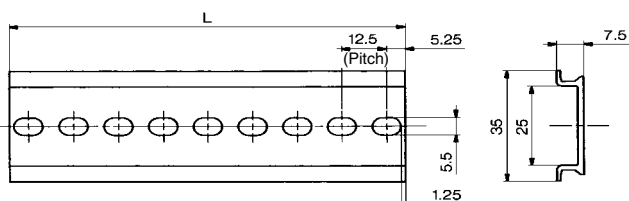

### L Dimension

$$L = 12.5 \times n + 10.5$$

No.	1	2	3	4	5	6	7	8	9	10
L dimension	23	35.5	48	60.5	73	85.5	98	110.5	123	135.5
No.	11	12	13	14	15	16	17	18	19	20
L dimension	148	160.5	173	185.5	198	210.5	223	235.5	248	260.5
No.	21	22	23	24	25	26	27	28	29	30
L dimension	273	285.5	298	310.5	323	335.5	348	360.5	373	385.5
No.	31	32	33	34	35	36	37	38	39	40
L dimension	398	410.5	423	435.5	448	460.5	473	485.5	498	510.5

VQC

SQ

VQ0

VQ4

VQ5

VQZ

VQD



# Series VQ

## Exploded View: VQ0000/Plug Lead Unit

(F, P, C, S kit)

\* For how to increase the stations, refer to the instruction manual.

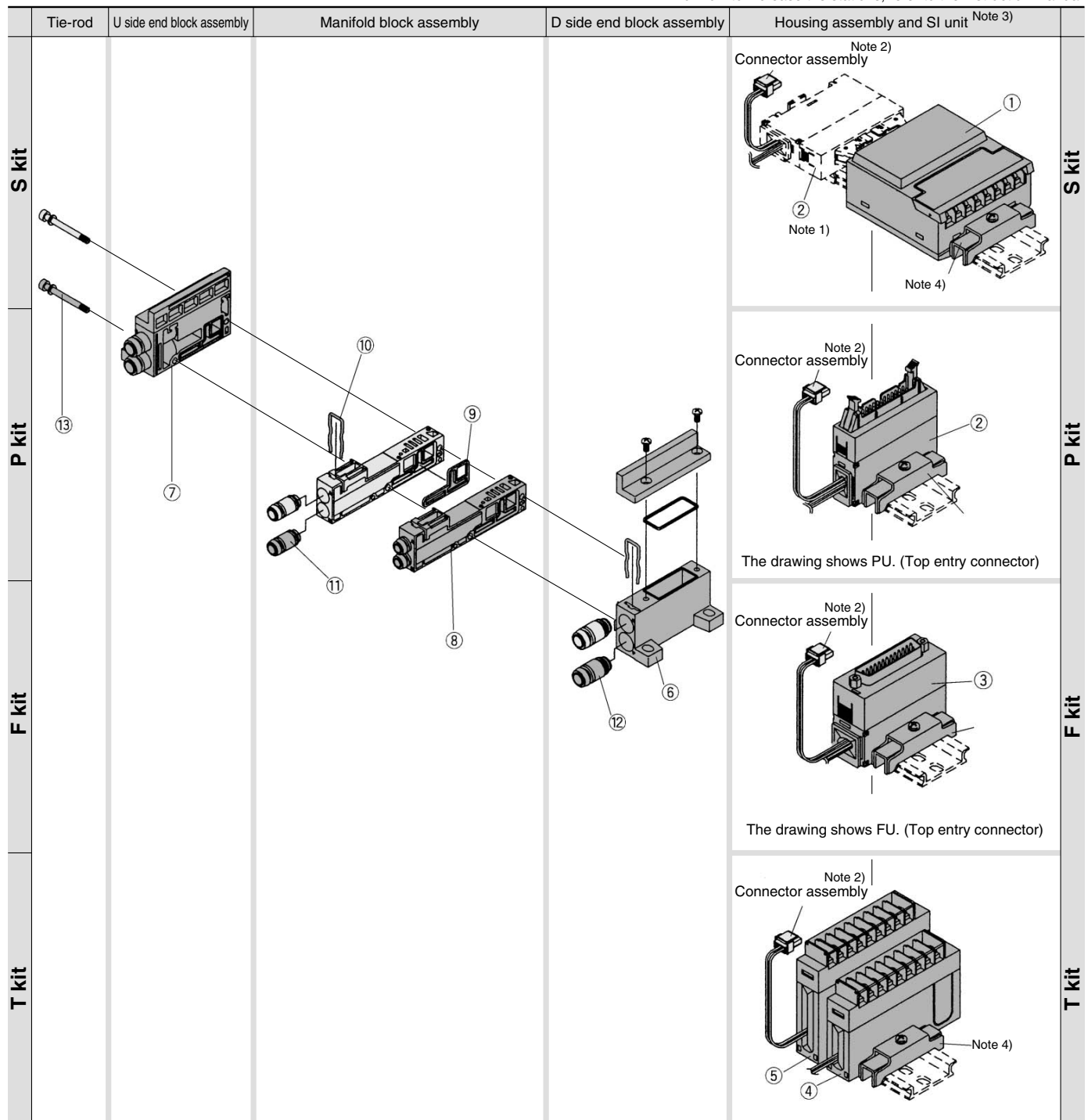

Note 1) S kit is composed of a flat ribbon cable housing assembly (AXT100-2-PS20) of ① SI unit and ② P kit (20 pins).

Note 2) Since no connector assembly is included, order it separately. (Refer to page 2-4-216.)

Note 3) A housing assembly is not used for a C kit.

Note 4) A DIN rail clamping bracket is attached to each.



## <Housing Assembly and SI Unit>

### Housing assembly and SI unit no.

No.	Manifold	Part no.	Description
①	(SA kit)	EX330-S001	General type SI unit (Series EX300)
	(SB kit)	EX130-SMB1	SI unit for MELSECNET/MINI-S3 Data Link System (Mitsubishi Electric Corp.)
	(SC kit)	EX130-STA1	SI unit for SYSBUS Wire System (OMRON Corporation)
	(SD kit)	EX130-SSH1	SI unit for Satellite I/O Link System (SHARP Corporation)
	(SF1 kit)	EX130-SUW1	16 point Uni-wire System (NKE Corporation)
	(SH kit)	EX130-SUH1	SI unit for 16 point Uni-wire H System (NKE Corporation)
②	P <sub>S</sub> <sup>U</sup> kit	AXT100-2-P <sub>S</sub> <sup>U</sup> □ <sup>(2)</sup>	Flat ribbon cable housing assembly l = Number of pins: 26, 20, 16, 10
③	F <sub>S</sub> <sup>U</sup> kit	AXT100-2-F <sub>S</sub> <sup>U</sup> □ <sup>(2)</sup>	D-sub connector housing assembly l = Number of pins: 25, 15
④	T kit	AXT100-2-TB1 <sup>(4)</sup>	Terminal block assembly (8 terminals)
⑤	T kit	AXT100-2-TB2 <sup>(4)</sup>	Terminal block assembly (8 terminals)

① Note 1) S kit is composed of a flat ribbon cable housing assembly (AXT100-2-PS20) of ① SI unit and ② P kit (20 pins). Place an order for AXT100-2-PS20 separately.

Note 2) Top/vertical entry connector for FU and PU while side (horizontal) entry connector for FS and PS.

③ Note 3) Since no connector assembly is included, order it separately. (Refer to page 2-4-216.)

Note 4) In the case of standard specifications and double wiring, ④ is for 1 to ⑤ stations and t is for 5 to 8 stations.

VQC

SQ

VQ0

VQ4

VQ5

VQZ

VQD

## <D Side End Plate Assembly>

### ⑥ D side end plate assembly no.

VVQ0000-3A-5-□

Option

Nil	Common exhaust type
S	Built-in silencer, direct exhaust

⑫ Note) The ⑫'s fitting assembly is included.

## <U Side End Plate Assembly>

### ⑦ U side end plate assembly no.

VVQ0000-2A-5-□

Option

Nil	Common exhaust type
S	Built-in silencer, direct exhaust

## <Manifold Block Assembly>

### ⑧ manifold block assembly no.

VVQ0000-1A-5-□

Port size

C3	With One-touch fitting for ø3.2
C4	With One-touch fitting for ø4
M5	M5 thread

## <Replacement Parts for Manifold Block>

### Replaceable Parts

No.	Part no.	Description	Material	Number
⑨	VVQ0000-80A-5-2	Seal	HNBR	12
⑩	VVQ0000-80A-5-4	Clip	HNBR	12

⑩ Note) A set of parts containing 12 pcs. each is enclosed.

## <Fitting Assembly>

### ⑪ Fittings assembly part no. (For cylinder port)

VVQ0000-50A-□

Port size

Note) Purchasing order is available in units of 10 pieces.

C3	With One-touch fitting for ø3.2
C4	With One-touch fitting for ø4

### ⑫ Fitting assembly part no. (For P, R port)

VVQ1000-50A-C6

Applicable tubing ø6

Note) Purchasing order is available in units of 10 pieces.

## <Tie-rod Bolt>

### ⑬ Tie-rod bolt

VVQ0000-103A-5-□

Stations

1	For 1 station
2	For 2 station
⋮	⋮
16	For 16 station

Note) 2 bolts per one set.