

Series VQ1000

Base Mounted

Plug Lead Unit

How to Order Manifold

VV5Q 12 - 08 C6 F U1 - D

Series/Manifold

12	VQ1000
----	--------

Stations

01	1 station
⋮	⋮

The number of max. stations differs from kit to kit. (Refer to the table below.)

Note 1) Specify "Mixed size/with port plug" in the manifold specification sheet.

Note 2) For One-touch fittings in inch sizes, refer to "Option" on page 2-4-216.

Note 3) M5 fittings for M5 thread are attached without being incorporated.

Cylinder port

Symbol	Port size
C3	With One-touch fitting for ø3.2
C4	With One-touch fitting for ø4
C6	With One-touch fitting for ø6
M5	M5 thread
CM	With mixed size/with port plug
L3	With elbow One-touch fitting ø3.2 for top piping
L4	With elbow One-touch fitting ø4 for top piping
L6	With elbow One-touch fitting ø6 for top piping
L5	Elbow M5 thread for top piping
B3	With elbow One-touch fitting ø3.2 for bottom piping
B4	With elbow One-touch fitting ø4 for bottom piping
B6	With elbow One-touch fitting ø6 for bottom piping
B5	Elbow M5 thread for bottom piping
LM	Mixed size for elbow piping

Kit type

Option

Symbol	Option
Nil	None
B	With back pressure check valve
D	DIN rail mounting style ⁽³⁾
K	Special wiring specifications (Not double wiring) ⁽⁴⁾
N	With name plate
S	Built-in silencer, direct exhaust

Note 1) When two or more symbols are specified, indicate them alphabetically. Example) -BNS

Note 2) Models with a suffix "-B" have check valves for prevention of back pressure at all manifold stations. If not all stations need this check valve, specify the stations where check valves are installed by using manifold specification sheet.

Note 3) Manifold is a DIN rail mounting style, and so suffix -D should be indicated.

Note 4) Specify the wiring specifications in the manifold specification sheet. (Except C kit)

Kit/Electrical entry/Cable length

F kit (D-sub connector)

Side entry Note 2) 25P Top entry

Connector entry direction			
Top entry	Side entry		
U0	S0	Without cable	Max. 16 stations ⁽²⁾
U1	S1	With cable (1.5 m)	
U2	S2	With cable (3 m)	
U3	S3	With cable (5 m)	

P. 2-4-188

P kit (Flat ribbon cable connector)

Side entry Note 2) 26P Top entry

Connector entry direction			
Top entry	Side entry		
U0	S0	Without cable	Max. 16 stations ⁽²⁾
U1	S1	With cable (1.5 m)	
U2	S2	With cable (3 m)	
U3	S3	With cable (5 m)	

P. 2-4-192

T kit (Terminal block)

P. 2-4-196

kit	1	Number of terminals: 8, 1 row	Applicable stations 1 to 8 stations
T	2	Number of terminals: 16, 2 rows	Applicable stations ⁽²⁾ 5 to 16 stations

C kit (Connector)

P. 2-4-200

C	Connector kit	Max. 16 stations
---	---------------	------------------

S kit (Serial transmission unit)

The valve is equipped with an indicator light and surge voltage suppressor, and the voltage is 24 VDC. The dust-protected type SI unit is available, too. For details, please contact SMC.

P. 2-4-204

		Without SI unit	
A		With general type SI unit (Series EX300)	
B		Mitsubishi Electric Corp.: MELSECNET/MINI-S3 Data Link System	
C		OMRON Corp.: SYSBUS Wire System	
D		SHARP Corp.: Satellite I/O Link System	
E		Matsushita Electric Works: MEWNET-F System	
F1		NKE Corp.: Uni-wire System (16 output points)	Max. 16 stations
F2		NKE Corp.: Uni-wire H System	
G		Rockwell Automation: Allen Bradley Remote I/O (RIO) System	
H		NKE Corp.: Uni-wire H System	
J1		SUNX Corp.: S-LINK System (16 output points)	Max. 8 stations
J2		SUNX Corp.: S-LINK System (8 output points)	
K		Fuji Electric Co.: T-LINK Mini System	Max. 16 stations
Q		DeviceNet, CompoBus/D (OMRON Corp.)	
R1		OMRON Corp.: CompoBus/S System (16 output points)	Max. 8 stations
R2		OMRON Corp.: CompoBus/S System (8 output points)	
V		Mitsubishi Electric Corp.: CC-LINK System	Max. 16 stations

Note 1) Besides the above, F and P kits with different number of pins are available. Refer to page 2-4-215 for details.

Note 2) For details, refer to page 2-4-216.

Simple specials are available with SMC Simple Specials System. For details about applicable models, please contact SMC.

How to Order Valves

VQ 1 1 1 0 Y 5 LO 

Series
0 VQ0000

Type of actuation

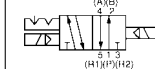
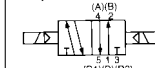
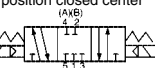
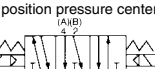
1	2 position single 
2	Metal 2 position double 
	Rubber 2 position double 
3	3 position closed center 
4	3 position pressure center 

Body type
1 VQ1000

Seal

0	Metal seal
1	Rubber seal

Manual override

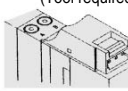
Nil: Non-locking push type (Tool required)

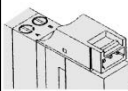
B: Locking type (Tool required)

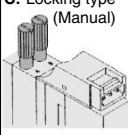
C: Locking type (Manual)

Electrical entry

L: L plug connector With lead wire

LO: L plug connector Without connector

With light/surge voltage suppressor

Function

Symbol	Specifications	DC
Nil	Standard type	(1.0 W) ○
H	High pressure type	(1.5 W) ○
Y	Low wattage type	(0.5 W) ○

Coil voltage

5	24 VDC
6	12 VDC

Note) LO type valve is used for F, P, T, and S kits. The plug connector and lead wire are attached to the manifold.

How to Order Valve Manifold Assembly

Example

Single solenoid (24 VDC)
VQ1110-5LO

Double solenoid (24 VDC)
VQ1210-5LO

3m

D-sub connector cable
VVZS3000-21A-2

F kit (D-sub connector)

Manifold base (9 stations)
VV5Q12-08C6FU2-D

Cylinder ports
C6: With One-touch fitting for ø6

Stations

1 2 3

D-sub connector

VQC
SQ
VQ0
VQ4
VQ5
VQZ
VQD

VV5Q12-08C6FU2-D ... 1 set (F kit 8 station manifold base no.)
 *VQ1110-5LO ... 4 sets (Single solenoid part no.)
 *VQ1210-5LO ... 4 sets (Double solenoid part no.)

The asterisk denotes the symbol for assembly. Prefix it to the part nos. of the solenoid valve, etc.

Specify the part numbers for valves and options together beneath the manifold base part number. Besides, when the arrangement will be complicated, specify them by means of the manifold specification sheet.

Manifold Option

P. 2-4-208

Blanking plate assembly
VVQ1000-10A-1

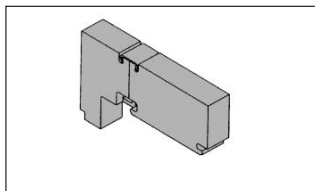

SUP/EXH block plate
VVQ1000-16A-2

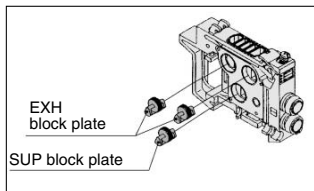

Double check block
VVQ1000-FPG-□□

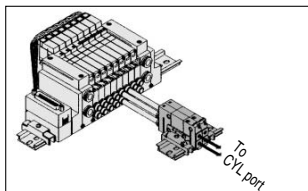

2 stations matching fitting assembly
VVQ1000-52A-C8

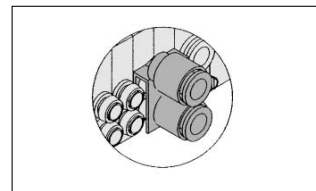

Individual SUP spacer
VVQ1000-P-1-C6

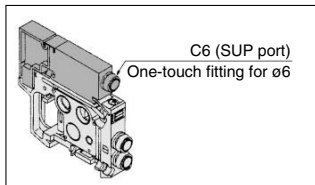

Back pressure check valve assembly [-B]
VVQ1000-18A

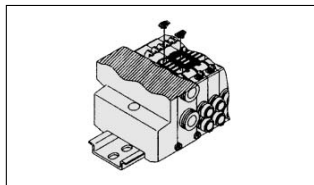

Elbow fitting assembly
VVQ1000-F-L

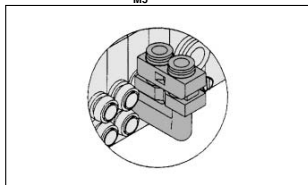

Silencer
AN200-KM8

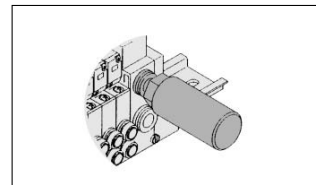

Individual EXH spacer
VVQ1000-R-1-C6

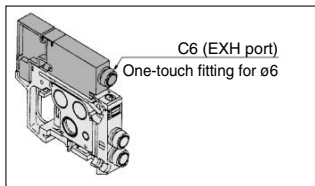

Name plate [-N*]
VVQ1000-N2-Station (1 to Max. stations)

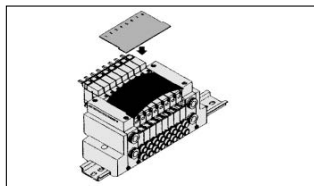

Built-in silencer, direct exhaust [-S]

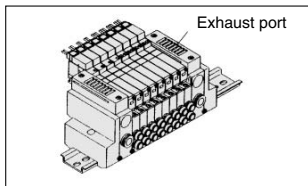

Port plug
VVQ0000-58A

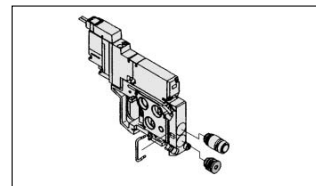

For cylinder port fittings part no., refer to page 2-4-213.
 For replacement parts, refer to page 2-4-231.

Blanking plug
KQ2P-
23
04
06
08

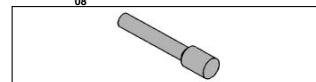

Plug Lead Unit Series VQ0000/1000

Manifold Specifications

Series	Base model	Type of connection	Porting specifications		Applicable stations ⁽²⁾	Applicable solenoid valve	5 station weight (g)	
			Port location	Port size ⁽¹⁾				
				1(P), 3(R)	4(A), 2(B)			
VQ0000	VV5Q05-□□□	<ul style="list-style-type: none"> ■ F kit—D-sub connector ■ P kit—Flat ribbon cable connector ■ T kit—Terminal block ■ C kit—Individual connector ■ S kit—Serial transmission 	Side	C6 (ø6) Option (Built-in silencer, direct exhaust)	C3 (ø3.2) C4 (ø4) M5 (M5 thread)	1 to 16 stations	VQ0□50 VQ0□51	330 (Single) 400 (Double, 3 position)
VQ1000	VV5Q12-□□□	<ul style="list-style-type: none"> ■ F kit—D-sub connector ■ P kit—Flat ribbon cable connector ■ T kit—Terminal block ■ C kit—Individual connector ■ S kit—Serial transmission 	Side	C8 (ø8) Option (Built-in silencer, direct exhaust)	C3 (ø3.2) C4 (ø4)C6 (ø6) M5 (M5 thread)	1 to 16 stations	VQ1□10 VQ1□11	818 (Single) 885 (Double, 3 position)



Note 1) Inch-size One-touch fittings are also available. For details, refer to page 2-4-216.

Note 2) For details, refer to page 2-4-216.

VQC

SQ

VQ0

VQ4

VQ5

VQZ

VQD

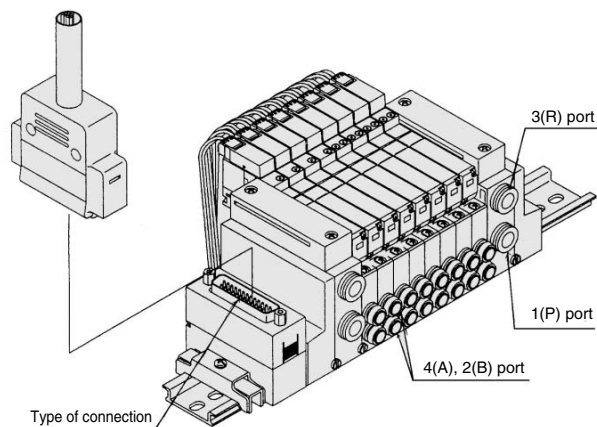
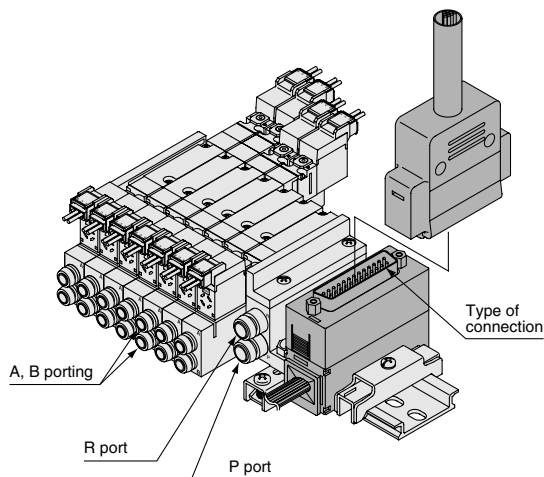

VV5Q12

T VQ0000/1000 Kit (Terminal block)

- It is a standard terminal block type.
- Two quantities of terminals can be selected in accordance with the number of stations. (8 terminals/16 terminals)
- Maximum stations are 8. (16 stations as an option)

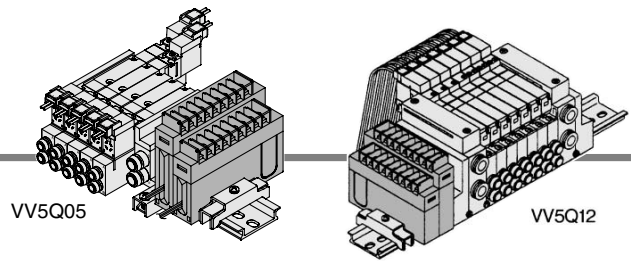

Manifold Specifications

Series	Porting specifications		Applicable stations
	Port location	Port size	
VQ0000	Side	1(P), 3(R), 4(A), 2(B)	Max.16 stations
VQ1000	Side	C6, C3, C4, C6, M5	Max.16 stations

Electrical wiring specifications

Terminal no.

Terminal no.

1 station { SOL.A₁ (-)
SOL.B₂ (-)
SOL.A₃ (-)
SOL.B₄ (-)
SOL.A₅ (-)
SOL.B₆ (-)
SOL.A₇ (-)
SOL.B₈ (-)
COM₉ COM (+)

2 stations { SOL.A₁ (-)
SOL.B₂ (-)
SOL.A₃ (-)
SOL.B₄ (-)
SOL.A₅ (-)
SOL.B₆ (-)
SOL.A₇ (-)
SOL.B₈ (-)
COM₉ COM (+)

3 stations { SOL.A₁ (-)
SOL.B₂ (-)
SOL.A₃ (-)
SOL.B₄ (-)
SOL.A₅ (-)
SOL.B₆ (-)
SOL.A₇ (-)
SOL.B₈ (-)
COM₉ COM (+)

4 stations { SOL.A₁ (-)
SOL.B₂ (-)
SOL.A₃ (-)
SOL.B₄ (-)
SOL.A₅ (-)
SOL.B₆ (-)
SOL.A₇ (-)
SOL.B₈ (-)
COM₉ COM (+)

5 stations { SOL.A₁ (-)
SOL.B₂ (-)
SOL.A₃ (-)
SOL.B₄ (-)
SOL.A₅ (-)
SOL.B₆ (-)
SOL.A₇ (-)
SOL.B₈ (-)
COM₉ COM (+)

6 stations { SOL.A₁ (-)
SOL.B₂ (-)
SOL.A₃ (-)
SOL.B₄ (-)
SOL.A₅ (-)
SOL.B₆ (-)
SOL.A₇ (-)
SOL.B₈ (-)
COM₉ COM (+)

7 stations { SOL.A₁ (-)
SOL.B₂ (-)
SOL.A₃ (-)
SOL.B₄ (-)
SOL.A₅ (-)
SOL.B₆ (-)
SOL.A₇ (-)
SOL.B₈ (-)
COM₉ COM (+)

8 stations { SOL.A₁ (-)
SOL.B₂ (-)
SOL.A₃ (-)
SOL.B₄ (-)
SOL.A₅ (-)
SOL.B₆ (-)
SOL.A₇ (-)
SOL.B₈ (-)
COM₉ COM (+)

In the case of double wiring (standard spec.)
T1 (Terminal block of 1 row): 1-4 stations
T2 (Terminal block of 2 rows): 5-8 stations
T1 and T2 can be optionally chosen by adopting the combinations of single and double wiring (option spec.) etc.

The quantity of terminal blocks used depends on the number of manifold stations

Manifold	Terminal blocks
1 to 4 stations	1 row
5 to 8 stations	2 rows

Note) Wiring other than those above is possible. For details, refer to page 2-4-216.

Double wiring (connected to SOL. A and SOL. B) is adopted for the internal wiring of each station, regardless of valve and option types. Mixed single and double wiring is available as an option. For details, refer to page 2-4-216.

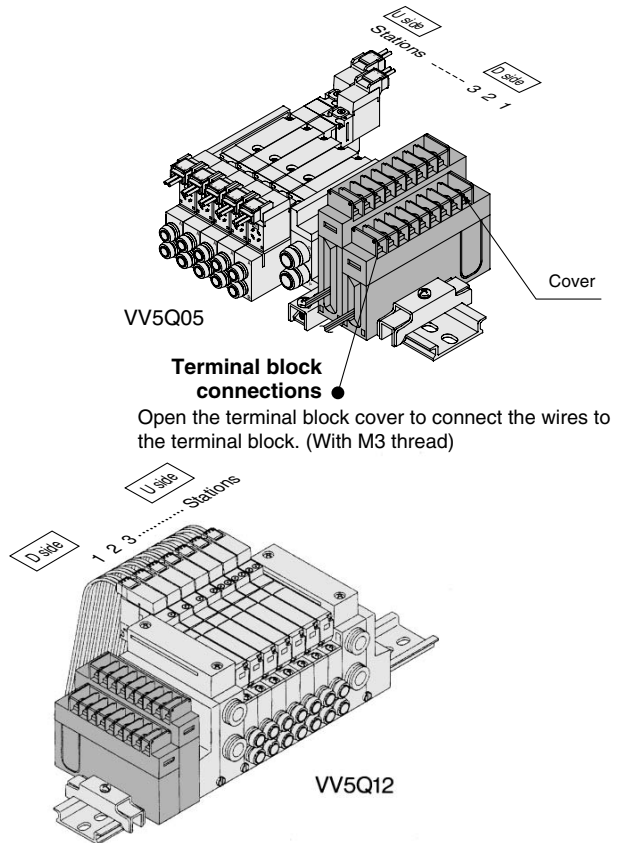

How to Order Manifold

VV5Q 12 08 C6 T 2 D

Series/Manifold

05	VQ0000	Plug lead unit
12	VQ1000	Plug lead unit

Stations

01	1 station
⋮	⋮
16	16 stations ^{Note)}

Note) Refer to page 2-4-216 for details.

Cylinder ports

Symbol	Port size
C3	With One-touch fitting for ø3.2
C4	With One-touch fitting for ø4
C6	With One-touch fitting for ø6
M5	M5 thread
CM	With mixed size/with port plug ^{Note)}

Note 1) Specify "Mixed size/with port plug" on the manifold specification sheet.
Note 2) For inch-size One-touch fittings, refer to "Option" on page 2-4-216.

Number of terminals

1	8 terminals in 1 row	1 to 4 stations (Double wiring), 8 stations (Single wiring)
2	16 terminals in 2 rows	5 to 8 stations (Double wiring), 16 stations (Single wiring)

Note) The number of terminal blocks can be chosen regardless of station qty. Suffix the option symbol, "K" when the wiring specifications are special.

Option

Symbol	Option	VQ0000	VQ1000
B	With back pressure check valve		● ⁽²⁾
D	DIN rail mounting style	●	● ⁽³⁾
K	Special wiring specifications (Not double wiring)	●	● ⁽⁴⁾
N	With name plate	●	●
S	Built-in silencer, direct exhaust	●	●

Note 1) When two or more symbols are specified, indicate them alphabetically.
Example) -BNS

Note 2) Models with a suffix "-B" have the back pressure check valve at all manifold stations. If not all stations need this check valve, specify the stations where check valves are installed by using the manifold specification sheet.

Note 3) T kit of VQ0000 and all of VQ1000 are equipped with a DIN rail, so indicate suffix "-D".

Note 4) Specify the wiring specifications on the manifold specification sheet.

VQC

SQ

VQ0

VQ4

VQ5

VQZ

VQD

How to Order Valves

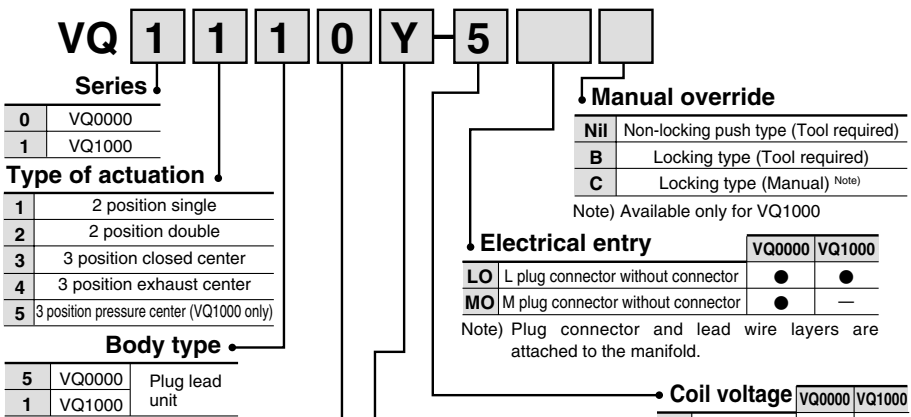

Series

0	VQ0000
1	VQ1000

Type of actuation

1	2 position single
2	2 position double
3	3 position closed center
4	3 position exhaust center
5	3 position pressure center (VQ1000 only)

Body type

5	VQ0000	Plug lead unit
1	VQ1000	

Seal

0	Metal seal
1	Rubber seal

Manual override

Nil	Non-locking push type (Tool required)
B	Locking type (Tool required)
C	Locking type (Manual) ^{Note)}

Note) Available only for VQ1000

Electrical entry

	VQ0000	VQ1000
LO	L plug connector without connector	● ●
MO	M plug connector without connector	● —

Note) Plug connector and lead wire layers are attached to the manifold.

Coil voltage

	VQ0000	VQ1000
1	100 VAC (50/60 Hz)	● —
3	110 VAC (50/60 Hz)	● —
5	24 VDC	● ●
6	12 VDC	● ●

Function

Symbol	Specifications	DC	AC
Nil	Standard type	(1.0 W) ○	^{Note)} ○
H	High pressure type	(1.5 W) ○	—
Y	Low wattage type	(0.5 W) ○	—

Note) For power consumption of AC type, refer to page 2-4-186.

How to Order Manifold Assembly

Specify the part numbers for valves and options together beneath the manifold base part number.

<Example>
 Flat ribbon cable kit with 3 m cable
 VV5Q12-07C6T2-D ... 1 set—Manifold base no.
 *VQ1110-5LO 4 sets—Valve part no. (Stations 1 to 4)
 *VQ1210-5LO 3 sets—Valve part no. (Stations 5 to 8)

Prefix the asterisk to the part nos. of the solenoid valve, etc.
 Write sequentially from the 1st station on the D side. When part nos. written collectively are complicated, specify by using the manifold specification sheet.

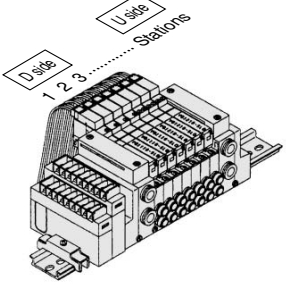

Note 1) For negative common specifications, refer to "Option" on page 2-4-216.
 Note 2) Connector assembly will be required when the T kits add a valve.
 For part nos., refer to "Option" on page 2-4-216.

VQ1000

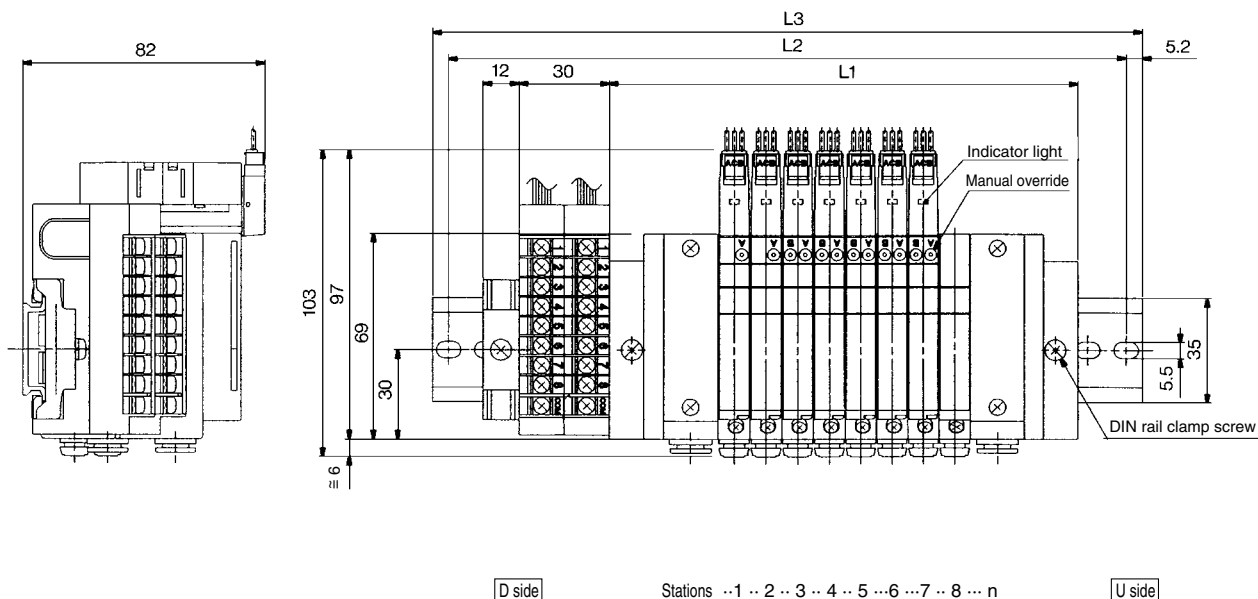

- VQC
- SQ
- VQ0**
- VQ4
- VQ5
- VQZ
- VQD

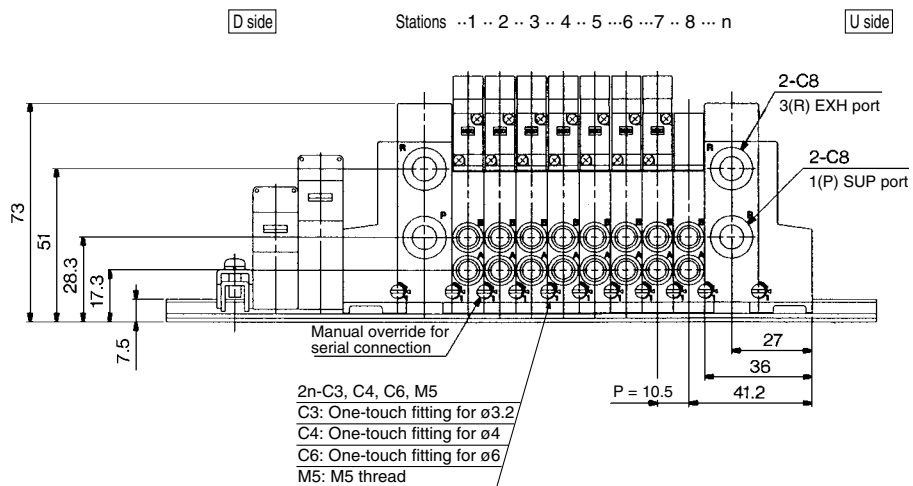

This drawing shows the case of VV5Q12-□□T2-D□.

Dimensions

Formula L1 = 10.5n + 72 n: Station (Maximum 16 stations)

L	n	1	2	3	4	5	6	7	8	9	10	11	12	13	14	15	16
L1		82.5	93	103.5	114	124.5	135	145.5	156	166.5	177	187.5	198	208.5	219	229.5	240
L2		150	162.5	175	187.5	187.5	200	212.5	225	237.5	250	250	262.5	275	287.5	300	312.5
L3		160.5	173	185.5	198	198	210.5	223	235.5	248	260.5	260.5	273	285.5	298	310.5	323

Series VQ1000

Manifold Option Parts for VQ1000

Blanking plate assembly VVQ1000-10A-1

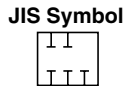

It is used by attaching on the manifold block for being prepared for removing a valve for maintenance reasons or planning to mount a spare valve, etc.

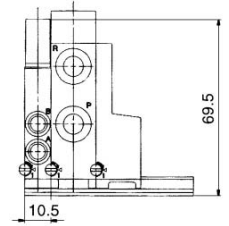
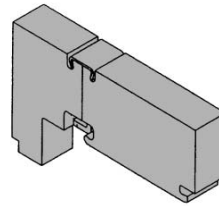

Individual SUP spacer VVQ1000-P-2-C6

When the same manifold is to be used for different pressures, individual SUP spacers are used as SUP ports for different pressures. (One station space is occupied.)

Block both sides of the station, for which the supply pressure from the individual SUP spacer is used, with SUP block plates. (Refer to the application ex.)

* Specify the spacer mounting position and SUP block plate position on the manifold specification sheet. The block plates are used in two places for one set. (Two SUP block plates for blocking SUP station are attached to the individual SUP spacer.)

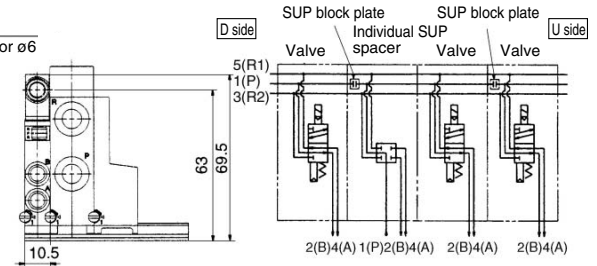
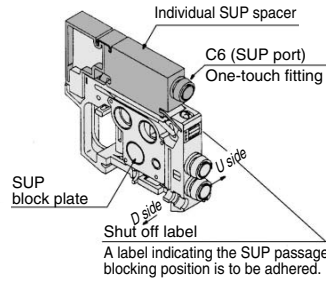

Individual EXH spacer VVQ1000-R-2-C6

When valve exhaust affects other stations due to the circuit configuration, this spacer is used for individual valve exhaust. (One station space is occupied.)

Block both sides of the individual valve EXH station. (See example.)

* Specify the mounting position, as well as EXH block base or EXH block plate position on the manifold specification sheet. The block plates are used in two places for one set.

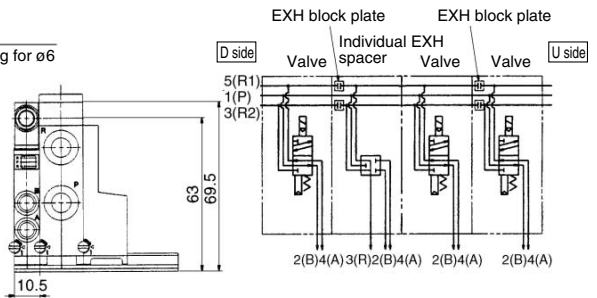
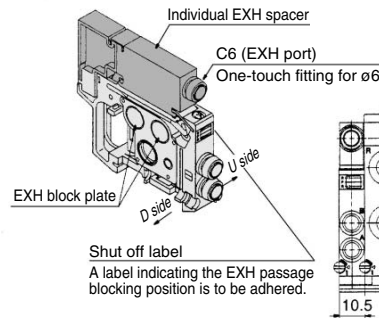

SUP/EXH block plate VVQ1000-16A-2

When different pressures, high and low, are supplied to one manifold, a SUP block plate is inserted between the stations under different pressures.

When a valve exhaust affects other stations due to the circuit configuration, this plate is also used between the stations where exhaust should be separated. It is also used for individual exhaust by combining an EXH block plate with an individual EXH spacer.

(2 EXH plates are necessary for 1 station.)

Note) The SUP/EXH block plate is common.

* Specify the number of stations on the manifold specification sheet.

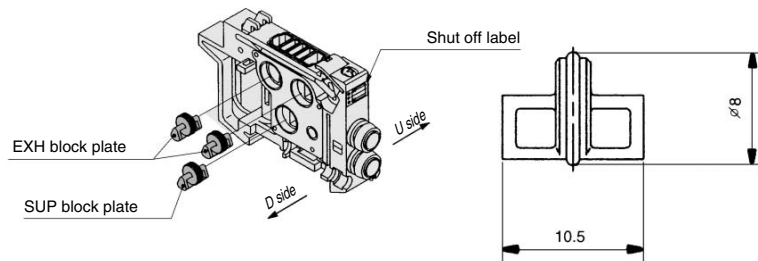

<Blocking indication label>

When using block plates for SUP/EXH passage, the indication label for confirmation of the blocking position from outside is attached. (One label for each)

* When ordering a block plate incorporated with the manifold no., a block indication label is attached to the manifold.

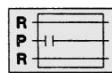

SUP passage blocked

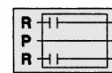

EXH passage blocked

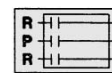

SUP/EXH passage blocked

Back pressure check valve assembly [-B] VVQ1000-18A

It prevents cylinder malfunction caused by other valve exhaust. Insert it into R (EXH) port on the manifold side of a valve which is affected. It is effective when a single acting cylinder is used or an exhaust center type solenoid valve is used.

Note) When a check valve for back pressure prevention is desired to be installed only in certain manifold stations, write clearly the part no. and specify the station numbers by using the manifold specification sheet.

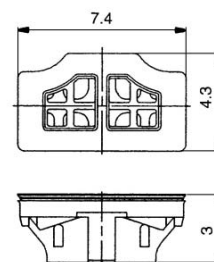
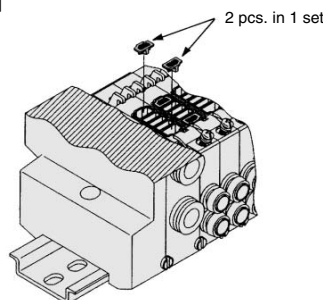

* When ordering assemblies incorporated with a manifold, add suffix "-B" to the manifold no.

<Precautions>

1. Back pressure check valve assembly is assembled with a check valve structure. However, as slight air leakage is allowed for the back pressure, take note the exhaust air will not be throttled at the exhaust port.
2. When a back pressure check valve is mounted, the effective orifice of the valve will decrease by about 20%.

Name plate [-N*]

VVQ1000-N2-Station (1 to Max. stations)

It is a transparent resin plate for placing a label that indicates solenoid valve function, etc. Insert it into the groove on the side of the end plate and bend it as shown in the figure.

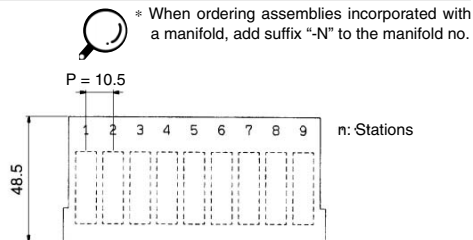
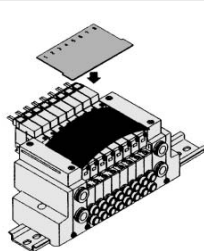

* When ordering assemblies incorporated with a manifold, add suffix "-N" to the manifold no.

Blanking plug (For One-touch fittings)

KQ2P-²³_{06 04 08}

It is inserted into an unused cylinder port and SUP/EXH ports. Purchasing order is available in units of 10 pieces.

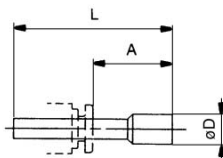
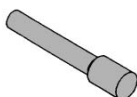

Dimensions

Applicable fitting size øD	Model	A	L	D
3.2	KQ2P-23	16	31.5	3.2
4	KQP-04	16	32	6
6	KQP-06	18	35	8
8	KQP-08	20.5	39	10

VQC

SQ

VQ0

VQ4

VQ5

VQZ

VQD

Port plug VVQ0000-58A

The plug is used to block the cylinder port when using a 4 port valve as a 3 port valve.

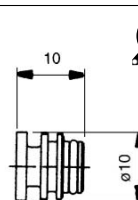
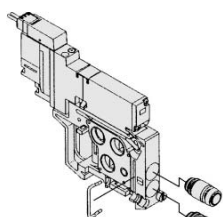

* When ordering a plug incorporated with a manifold, indicate "CM" for the port size in the manifold no., as well as, the mounting position and number of stations and cylinder port mounting positions, A and B, by means of the manifold specification sheet.

* Lightly screw an M3 screw in the port plug hole and pull it for removal.

Elbow fittings assembly

VVQ1000-F-L^{CC3}_{CC4 MS}

It is used for piping that extends upward or downward from the manifold.

When not mounting it to all manifold stations, clearly write the elbow type fitting assembly no. and specify the station's qty and position by manifold specifications.

* When mounting elbow fittings assembly on the edge of manifold station and a silencer on EXH port, select a silencer, AN203-KM8.

Silencer (AN200-KM8) is interfered with fittings.

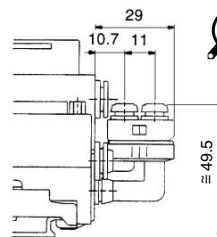
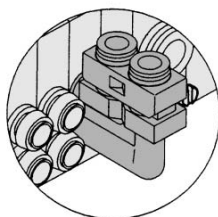

* When ordering assemblies incorporated with a manifold, indicate "L□" or "B□" for the manifold port size.

Built-in silencer, Direct exhaust [-S]

This is an exhaust port on the manifold end plate.

The built-in silencer exhibits an excellent noise suppression effect. (Silencing effect: 30 dB)

(Note) A large quantity of drainage generated in the air source results in exhaust of air together with drainage.



• For maintenance, refer to page 2-4-214.

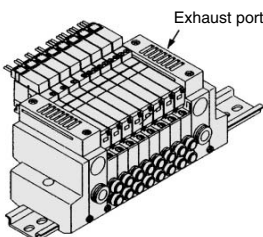

* When ordering assemblies incorporated with a manifold, add suffix "-S" to the manifold no.

2 stations matching fitting assembly

VVQ1000-52A-C8

For driving a cylinder with a large bore, valves for two stations are operated to double the flow rate. This assembly for the cylinder port is used in that case. The assembly is equipped with One-touch fittings for a ø8 bore.

* The bore for the manifold no. is "CM".

Clearly indicate the 2 station matching fitting assembly no., and specify the number of stations and positions on the manifold specification sheet.

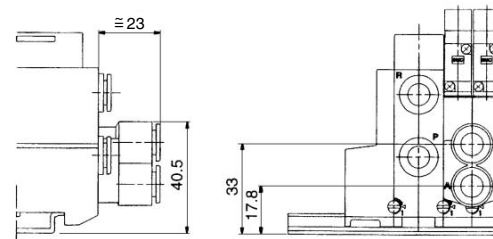
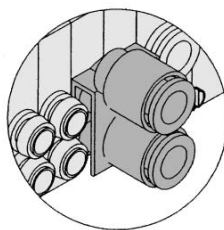

Silencer (For EXH port)

This is inserted into the centralized type EXH port (One-touch fitting).

* When mounting elbow fittings assembly (VVQ1000-F-L□) on the edge of manifold station, select a silencer, AN203-KM8.

Silencer (AN200-KM8) is interfered with fittings.

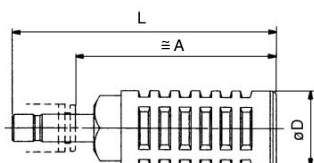

Dimensions

Series	Applicable fitting size øD	Model	A	L	D	Effective area (mm ²)	Noise reduction (dB)
VQ1000	8	AN200-KM8	59	78	22	20	30
		AN203-KM8	32	51	16	14	25*

Manifold Option Parts for VQ0000/VQ1000

Double check block (Separated type)

VQ1000-FPG-□□

It is used on the outlet side piping to keep the cylinder in the intermediate position for a long time. Combining the double check block with a built-in pilot type double check valve and a 3 position exhaust center solenoid valve will enable the cylinder to stop in the middle or maintain its position for a long time.

The combination with a 2 position single/double solenoid valve will permit this block to be used for preventing the dropping at the cylinder stroke end when the SUP residual pressure is released.

Specifications

Max. operating pressure	0.8 MPa
Min. operating pressure	0.15 MPa
Ambient and fluid temperature	-5 to 50°C
Flow characteristics: C	0.60 dm ³ /(s·bar)
Max. operating frequency	180 CPM

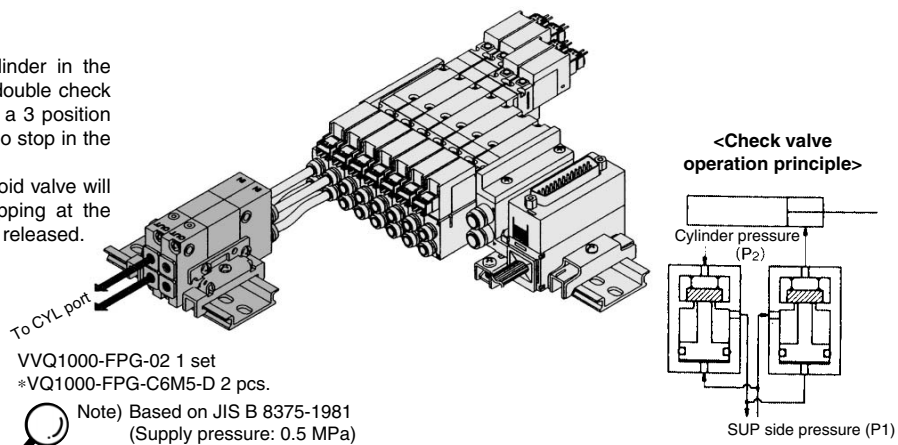

Dimensions

Single unit

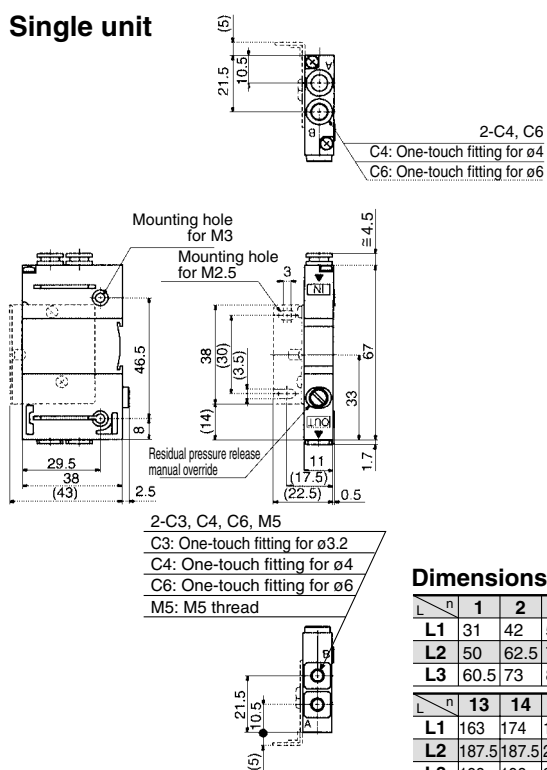

Manifold

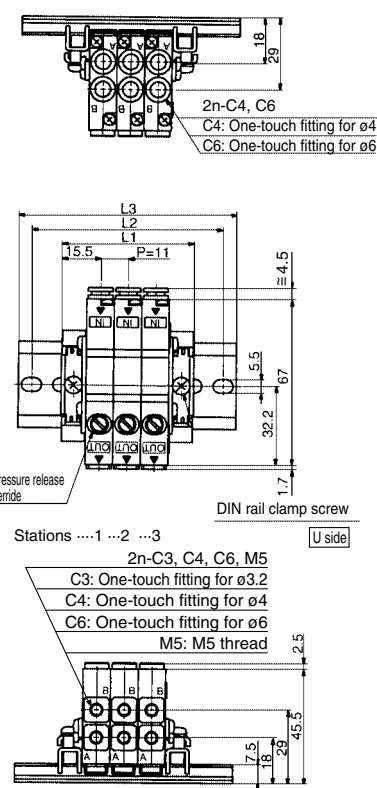

How to Order

Double check block

VQ1000-FPG-□□-□□-□

IN side port size

C4	One-touch fitting for ø4
C6	One-touch fitting for ø6

OUT side port size

M5	M5 thread
C3	One-touch fitting for ø3.2
C4	One-touch fitting for ø4
C6	One-touch fitting for ø6

Option

Nil	None
F	With bracket
D	DIN rail mounting style (For manifold)
N	Name plate

Note) When two or more symbols are specified, indicate them alphabetically.
Example) -DN

Manifold

VVQ1000-FPG-06

Stations

01	1 station
⋮	⋮
16	16 stations

<Example>

VVQ1000-FPG-06 ... 6 types of manifold
*VQ1000-FPG-C4M5-D, 3 sets } Doublecheck block
*VQ1000-FPG-C6M5-D, 3 sets }

Bracket Assembly

Part no.	Tightening torque
VQ1000-FPG-FB	0.22 to 0.25 N·m

Caution

- Air leakage from the pipe between the valve and cylinder or from the fittings will prevent the cylinder from stopping for a long time. Check the leakage using neutral household detergent, such as dish washing soap. Also check the cylinder's tube gasket, piston packing and rod packing for air leakage.
- Since One-touch fittings allow slight air leakage, screw piping (with M5 thread) is recommended when stopping the cylinder in the middle for a long time.
- Combining double check block with 3 position closed center or pressure center solenoid valve will not work.
- M5 fitting assembly is attached, not incorporated into the double check block. After screwing in the M5 fittings, mount the assembly on the double check block. (Tightening torque: 0.8 to 1.2 N·m)
- If the exhaust of the double check block is throttled too much, the cylinder may not operate properly and may not stop intermediately.
- Set the cylinder load so that the cylinder pressure will be within two times that of the supply pressure.

⚠ Precautions 1

Be sure to read before handling. For Safety Instructions and Solenoid Valve Precautions, refer to page 2-9-2.

Light/Surge Voltage Suppressor

⚠ Caution

In the case of VQ1000, the standard model is equipped with an indicator light and surge voltage suppressor. The lighting positions are concentrated on one side for both single solenoid type and double solenoid type.

For the double solenoid type, A side and B side energization are indicated by two colors which match the colors of the manual overrides.

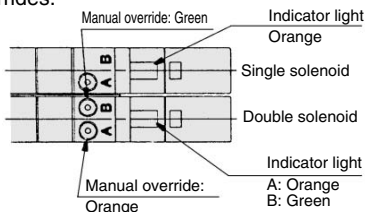

* In the case of VQ0000, solenoid and manual override on both sides.

DC circuit diagram VQ0000

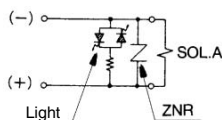

* In the case of VQ0000, solenoid and manual override on both sides.

Note) A side energization:
A light (orange) illuminates.
With wrong wiring preventing ability (stop diode)
B side energization:
B light (green) illuminates.
Equipped with a surge absorption (surge absorption diode) mechanism.

VQ1000 (DC)/Single solenoid

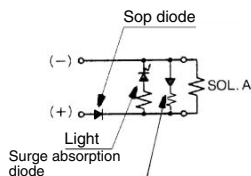

VQ1000/Double solenoid

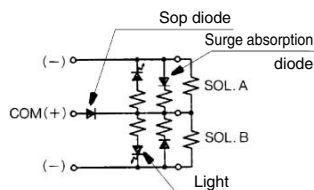

Manual Override

⚠ Warning

Without an electric signal for the solenoid valve the manual override is used for switching the main valve.

Push type is standard. (Tool required)

Option: Locking type (Tool required/Manual)

■ Push type (Tool required)

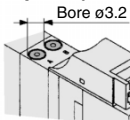
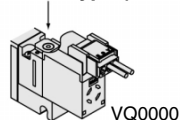

Push down on the manual override button with a small screwdriver until it stops. Release the screwdriver and the manual override will return.

■ Locking type (Tool required) <Option>

If the manual override is turned by 180° clockwise and the ► mark is adjusted to 1, it will be locked in the ON state.

If the manual override is turned by 180° counterclockwise and the ► mark is adjusted to 0, locking will be released and the manual override will return.

Push down completely on the manual override button with a small screwdriver. While down, turn clockwise 90° to lock it. Turn it counterclockwise to release it.

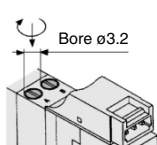
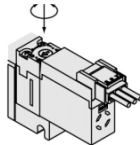

■ Locking type (Manual) <Option>

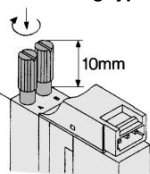

VQ1000

Push down on the manual override button with a small screwdriver or with your fingers until it stops. Turn clockwise by 90° to lock it. Turn it counterclockwise to release it.

⚠ Caution

Do not apply excessive torque when turning the locking type manual override. (0.1 N·m or less)

How to Mount/Remove Solenoid Valve

⚠ Caution

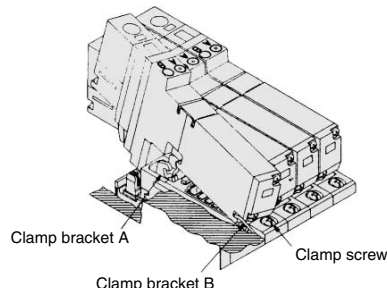

How to Remove

1. Loosen the clamp screw until it turns freely. (The screw is captive.)
2. Lift the coil side of the valve body while pressing down slightly on the screw head and remove it from the clamp bracket B. When the screw head cannot be pressed easily, gently press the area near the manual override of the valve.

How to Remove

1. Press down on the clamp screw. → Clamp bracket A opens. Diagonally insert the hook on the valve end plate side into clamp B.
2. Press the valve body downward. (When the screw is released, it will be locked by clamp bracket A.)
3. Tighten the clamp screw. (Proper tightening torque: 0.25 to 0.35 N·m)

Mounting

1. Dust on the sealing surface of the gasket or solenoid valve can cause air leakage.
2. In the case of VQ0000, valve mounting screw clamping torque is 0.18 to 0.25 N·m.

Replacement of Cylinder Port Fittings

⚠ Caution

The cylinder port fittings are a cassette for easy replacement. The fittings are blocked by a clip inserted from the top of manifold.

Remove the clip with a screwdriver to remove fittings. For replacement, insert the fitting assembly until it strikes against the inside wall and then re-insert the clip to specified position.

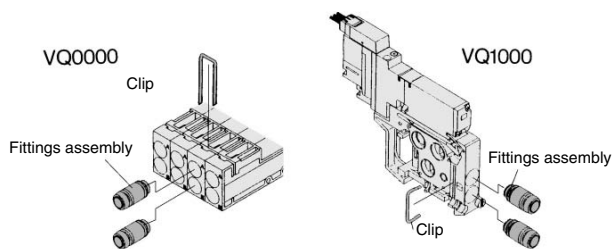

Take off the valve and remove the clip.

Remove the clip after taking off the manifold.

Applicable tubing O.D.	Fitting assembly part no.	
	VQ0000	VQ1000
Applicable tubing ø3.2	VVQ1000-51A-C3	VVQ1000-50A-C3
Applicable tubing ø4	VVQ1000-51A-C4	VVQ1000-50A-C4
Applicable tubing ø6	—	VVQ1000-50A-C6
M5	—	VVQ1000-50A-M5

* Refer to "Option" on pages 2-4-208 to 2-4-211 for other types of fittings.

⚠ Caution

1. Use caution that O-rings must be free from scratches and dust. Otherwise, air leakage may result.
2. After screwing in the fittings, mount the M5 fitting assembly on the manifold base. (Tightening torque 0.8 to 1.2 N·m)
3. Purchasing order is available in units of 10 pieces.

VQC

SQ

VQ0

VQ4

VQ5

VQZ

VQD

⚠ Precautions 2

Be sure to read before handling. For Safety Instructions and Solenoid Valve Precautions, refer to page 2-9-2.

How to Use Plug Connector

⚠ Caution

Attaching and detaching connectors

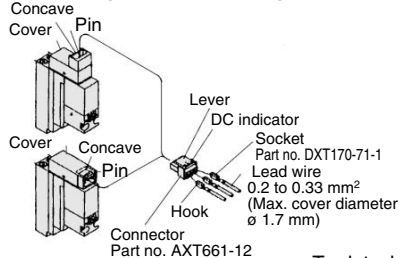

To attach a connector, hold the lever and connector unit between your fingers and insert straight onto the pins of the solenoid valve so that the lever's pawl is pushed into the groove and locks.

To detach a connector, remove the pawl from the groove by pushing the lever downward with your thumb, and pull the connector straight out.

Crimping the lead wire and socket

Peel 3.2 to 3.7 mm of the tip of lead wire, neatly into a socket and press contact it by a press tool. Be careful so that the cover of lead wire does not enter into the core press contacting part.

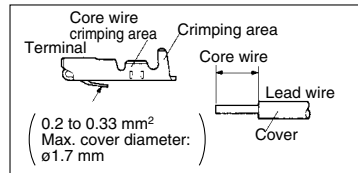

Attaching and detaching lead wires with sockets

Attaching

Insert a socket in the square hole (Indicated as ⊕, ⊖) of connector, push in the lead wire and lock by hanging the hook of socket to the seat of connector. (Pushing-in can open the hook and lock it automatically.) Then confirm the lock by lightly pulling on the lead wire.

Detaching

For pulling-out the socket from the connector, pull out the lead wire while pushing the hook of the socket with a fine point (ca. 1 mm) tool. If the socket is to be re-used, spread the hook to the outside.

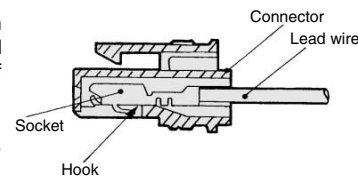

Mounting/Removing from the DIN Rail (VQ1000)

⚠ Caution

Removing

- Loosen the clamp screw on side (a) of the end plate on both sides.
- Lift side (a) of the manifold base and slide the end plate in the direction of (2) shown in the figure to remove.

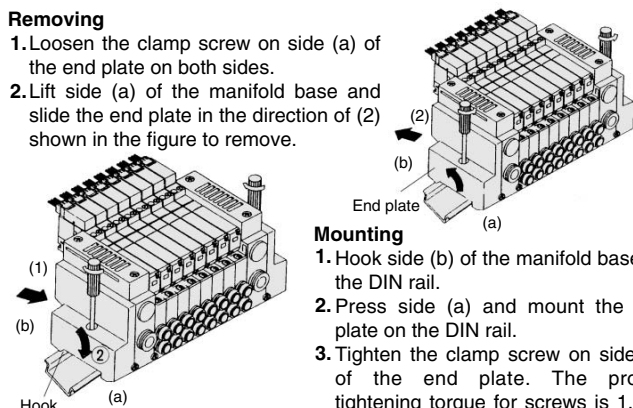

Mounting

- Hook side (b) of the manifold base on the DIN rail.
- Press side (a) and mount the end plate on the DIN rail.
- Tighten the clamp screw on side (a) of the end plate. The proper tightening torque for screws is 1.2 to 1.6 N·m.

Enclosure IP65

⚠ Caution

Wires, cables, connectors, etc. used for models conforming to IP65 should also have enclosures equivalent to or of stricter than IP65.

How to Calculate the Flow Rate

⚠ Caution

For obtaining the flow rate, refer to pages 2-1-8 to 2-1-11.

Built-in Silencer Replacement

⚠ Caution

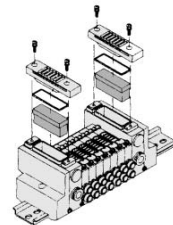

A silencer element is incorporated in the end plate on both sides of the manifold base. A dirty and choked element may reduce cylinder speed and cause malfunction. Clean or replace the dirty element.

Remove the cover from the top of the end plate and remove the old element with a screwdriver, etc.

Element part no.

Type	Element part no.	
	VQ0000	VQ1000
Built-in silencer, direct exhaust (-S)	VVQ0000-82A-1	VVQ1000-82A-1

* The minimum order quantity is 10 pcs.

Manifold Base Station Increasing Procedure (VQ1000)

⚠ Caution

- Loosen the clamp screw on the top surface of the end plate on one side.
- Turn the manual override between the manifold blocks with a regular screwdriver, etc. in a counterclockwise direction.
- Slide the manifold base to the side where the screw is loosened. Make a clearance of 15 mm or more.
- Mount the station increasing manifold block assembly and solenoid valve on the DIN rail. Install it to the DIN rail by applying the hook on the (b) side of the manifold block and pushing down the (a) side.

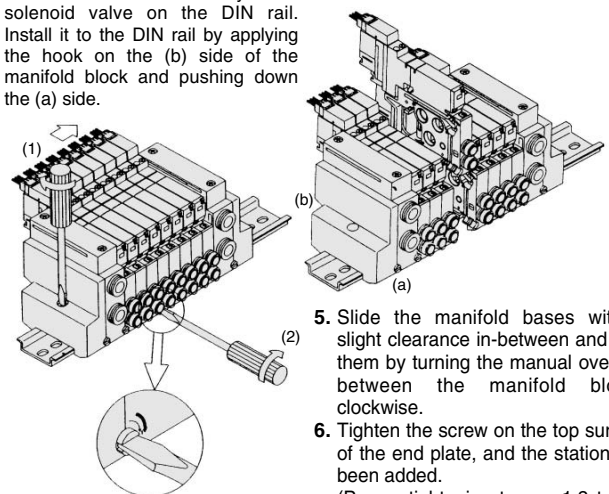
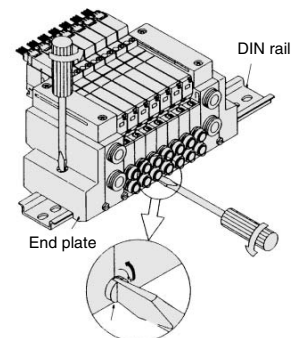

- Slide the manifold bases with a slight clearance in-between and lock them by turning the manual override between the manifold blocks clockwise.
- Tighten the screw on the top surface of the end plate, and the station has been added. (Proper tightening torque 1.2 to 1.6 N·m)

Manifold Block Assembly

VQ1000	Port size
VVQ1000-1A-2-C3	With One-touch fitting for ø3.2
VVQ1000-1A-2-C4	With One-touch fitting for ø4
VVQ1000-1A-2-C6	With One-touch fitting for ø6
VVQ1000-1A-2-M5	M5 thread

Series VQ0000/1000

Option

Special Wiring Specifications

In the internal wiring of F kit, P kit, T kit and S kit, double wiring (connected to SOL. A and SOL. B) is adopted for each station regardless of the valve and option types. Mixed single and double wiring is available as an option.

1. How to Order

Indicate an option symbol "-K", for the manifold no. and be sure to specify the mounting position and number of stations of the single and double wiring by means of the manifold specification sheet.

Example) VV5Q05-08C4FU1-D K S

Others, option symbols: to be indicated alphabetically.

2. Wiring specifications

With the A side solenoid of the 1st station as no. 1 (meaning, to be connected to no. 1 terminal), without making any terminals vacant.

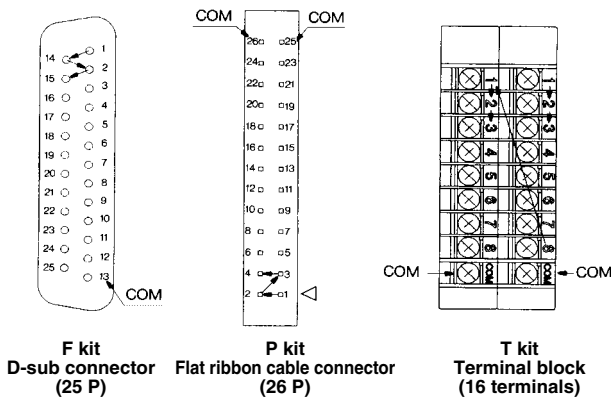

3. Max. number of stations

The maximum number of stations depends upon the number of solenoids. Assuming one for a single and two for a double, determine the number of stations so that the total number is not more than the max. number given in the following table.

Kit	F kit (D-sub connector)		P kit (Flat ribbon cable connector)			T kit (Terminal block)		S kit (Serial transmission)	
	F _S ^U 25P	F _S ^U 15P	P _S ^U 26P	P _S ^U 20P	P _S ^U 16P	P _S ^U 10P	T1		T2
Type									S□
Max. points	16 ^{Note)}	14	16 ^{Note)}	16 ^{Note)}	14	8	8	16	16

Note) Due to the limitation of internal wiring.

Negative Common Specifications [Series VQ1□10]

The following valve part numbers are for negative COM specifications. Manifold model no. is the same as the standard products.

How to order negative COM valves

VQ1110 N - 5M

• Negative common specifications

* Series VQ0□50 has no polarity, so the negative common is applicable to standard models.

Inch-size One-touch Fittings

Valve with inch-size One-touch fittings is shown below.

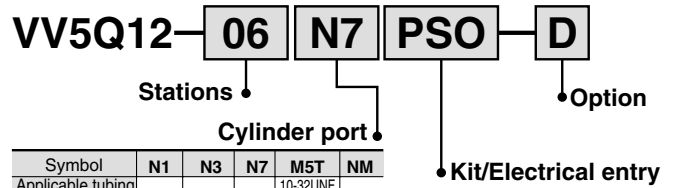

Symbol	N1	N3	N7	M5T	NM
Applicable tubing O.D. (Inch)	ø1/8"	ø5/32"	ø1/4"	10-32UNF (M5 thread)	Mixed
A, B port	○	○	—	○	○
	○	○	○	○	○

1(P), 3(R) port size
 VQ0000ø1/4"
 VQ1000ø5/16"

Note) When inch size fittings are selected for a cylinder port, use inch size fittings for both P and R port, too.

Plug Connector Assembly Model

Connector assembly will be required when the F, P, S kits add a valve. Specify the style of valve and connector assembly.

Connector Assembly Part No.

Specifications		Part no.
Single VQ0000 (2-wire)	Positive common	AXT661-14A-F
	Negative common	AXT661-14AN-F
Double (latching) (3-wire)	Positive common	AXT661-13A-F
	Negative common	AXT661-13AN-F

Note) Lead wire length: 300 mm

The part numbers above are applicable to 2 to 10 stations. 11 to 16 stations: "AXT661-13A(N)-F-425".

DIN Rail Mounting

Each manifold can be mounted on a DIN rail. Order it by indicating a DIN rail mounting option symbol, “-D”. In this case, a DIN rail which is approx. 30 mm longer than the manifold with the specified number of stations is attached. Other than this, it is applicable for the following cases.

● **When DIN rail is unnecessary (C kit VQ0000 only)**

Indicate the option symbol, -DO, for the manifold no.

Example)

VV5Q05-08C4C-DOS

Others, option symbols:
to be indicated alphabetically.

● **When using DIN rail longer than the manifold with specified number of stations (VQ0000/VQ1000)**

Clearly indicate the necessary number of stations next to the option symbol. “D” for the manifold no.

Example)

VV5Q05-08C4FU1-D09S

DIN rail for 9 stations
Others, option symbols:
to be indicated alphabetically.

● **When changing the manifold style into a DIN rail mounting style (VQ0000 only)**

Order brackets for mounting a DIN rail. (Refer to “Option” on page 2-4-209.)

No. VVQ0000-57A-5 2 pcs. per one set.

● **When ordering DIN rail only (VQ0000 only)**

DIN rail no.: AXT100-DR-□

As for □, specify the number from the DIN rail table.
For L dimension, refer to the dimensions of each kit.

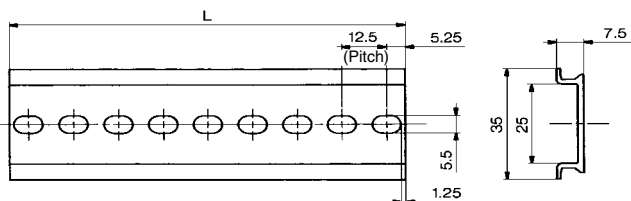

L Dimension

$L = 12.5 \times n + 10.5$

No.	1	2	3	4	5	6	7	8	9	10
L dimension	23	35.5	48	60.5	73	85.5	98	110.5	123	135.5
No.	11	12	13	14	15	16	17	18	19	20
L dimension	148	160.5	173	185.5	198	210.5	223	235.5	248	260.5
No.	21	22	23	24	25	26	27	28	29	30
L dimension	273	285.5	298	310.5	323	335.5	348	360.5	373	385.5
No.	31	32	33	34	35	36	37	38	39	40
L dimension	398	410.5	423	435.5	448	460.5	473	485.5	498	510.5

VQC

SQ

VQ0

VQ4

VQ5

VQZ

VQD

Series VQ

Exploded View: VQ1000/Plug Lead Unit

(F, P, T, S kit)

* For how to increase the stations, refer to the instruction manual.

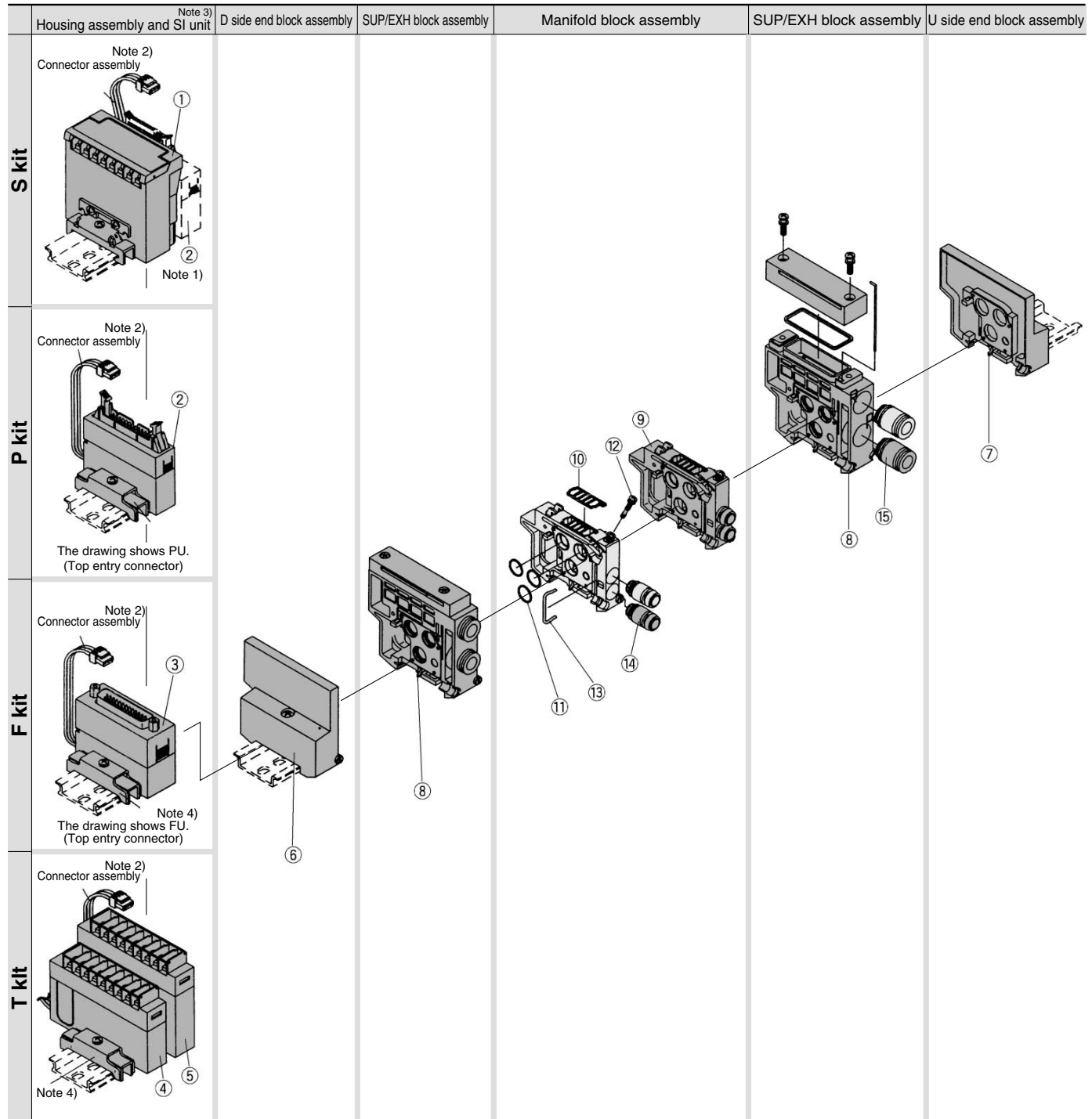

Note 1) S kit is composed of a flat ribbon cable housing assembly (AXT100-2-PU20) of ① SI unit and ② P kit (20 pins).

Note 2) Since no connector assembly is included, order it separately. (Refer to page 2-4-216.)

Note 3) A housing assembly is not used for a C kit.

Note 4) A DIN rail clamping bracket is attached to each.



<Housing Assembly and SI Unit>

Housing assembly and SI unit no.

No.	Manifold	Part no.	Description
	(SA kit)	EX321-S001(-XP) ⁽⁵⁾	General type SI unit (Series EX300)
	(SB kit)	EX121-SMB1(-XP) ⁽⁵⁾	SI unit for MELSECNET/MINI-S3 Data Link System (Mitsubishi Electric Corporation)
	(SC kit)	EX121-STA1(-XP) ⁽⁵⁾	SI unit for SYSBUS Wire System (OMRON Corporation)
	(SD kit)	EX121-SSH1(-XP) ⁽⁵⁾	SI unit for Satellite I/O Link System (SHARP Corporation)
	(SE kit)	EX121-SPA1	SI unit for MEWNET-F System (Matsushita Electric Works, Ltd.)
	(SF1kit)	EX121-SUW1(-XP) ⁽⁵⁾	SI unit for 16 point Uni-wire System (NKE Corporation)
	(SG kit)	EX121-SAB1(-XP) ⁽⁵⁾	SI unit for Allen Bradley Remote I/O (RIO) System (Rockwell Automation, Inc.)
①	(SH kit)	EX120-SUH1(-XP) ⁽⁵⁾	SI unit for 16 point Uni-wire H System (NKE Corporation)
	(SJ1 kit)	EX121-SSL1(-XP) ⁽⁵⁾	16 point S-LINK System (SUNX Corporation)
	(SJ2 kit)	EX121-SSL2(-XP) ⁽⁵⁾	8 point S-LINK System (SUNX Corporation)
	(SK kit)	EX121-SFU1(-XP) ⁽⁵⁾	T-LINK Mini System (Fuji Electric Co., Ltd.)
	(SQ kit)	EX121-SDN1	DeviceNet, CompoBus/D (OMRON Corporation)
	(SR1 kit)	EX121-SCS1(-XP) ⁽⁵⁾	OMRON Corporation: CompoBus/S System (16 output points)
	(SR2 kit)	EX121-SCS2(-XP) ⁽⁵⁾	OMRON Corporation: CompoBus/S System (8 output points)
	(SV kit)	EX120-SMJ1(-XP) ⁽⁵⁾	Mitsubishi Electric Corporation: CC-LINK System
②	P $\frac{U}{S}$ kit	AXT100-2-P $\frac{U}{S}$ □ ⁽²⁾	Flat ribbon cable housing assembly □ = Number of pins: 26, 20, 16, 10
③	F $\frac{U}{S}$ kit	AXT100-2-F $\frac{U}{S}$ □ ⁽²⁾	D-sub connector housing assembly □ = Number of pins: 25, 15
④	T kit	AXT100-2-TB1 ⁽⁴⁾	Terminal block assembly (8 terminals)
⑤	T kit	AXT100-2-TB2 ⁽⁴⁾	Terminal block assembly (8 terminals)

Note 1) A S kit is composed of a flat ribbon cable housing assembly (AXT100-2-PS20) of ① SI unit and ② P kit (20 pins).
Place an order for AXT100-2-PU20 separately.

Note 2) Top/vertical entry connector for FU and PU while side (horizontal) entry connector for FS and PS.

Note 3) Since no connector assembly is included, order it separately. (Refer to page 2-4-216.)

Note 4) In the case of standard specifications and double wiring, ④ is for 1 to 4 stations and ⑤ is for 5 to 8 stations.

Note 5) Suffix "-XP" for dust-protected type SI unit.

<D Side End Plate Assembly>

⑥ D side end plate assembly no.

VVQ1000-3A-2

<U Side End Plate Assembly>

⑦ U side end plate assembly no.

VVQ1000-2A-2

<SUP/EXH block Assembly>

⑧ SUP/EXH block assembly no.

VVQ1000-PR-2-C8-□

Option

Nil	Common exhaust type
S	Built-in silencer, direct exhaust

Note) The ⑮'s fitting assembly is included.

<Replacement Parts for Manifold Block>

Replaceable Parts

No.	Part no.	Description	Material	Number
⑩	VVQ1000-80A-1	Gasket	HNBR	12
⑪	VVQ1000-80A-2-2	O-ring	HNBR	12
⑫	VVQ1000-80A-3	Clamp screw	Carbon steel	12
⑬	VVQ1000-80A-2-4	Clip	Stainless steel	12

Note) A set of parts containing 12 pcs. each is enclosed.

<Fitting Assembly>

⑭ Fitting assembly part no. (For cylinder port)

VVQ1000-50A-□

Port size

C3	Applicable tubing ø3.2
C4	Applicable tubing ø4
C6	Applicable tubing ø6
M5	With M5 thread

Note) Purchasing order is available in units of 10 pieces.

<Manifold Block Assembly>

⑧ Manifold block assembly no.

VVQ1000-1A-2-□

Port size

C3	With One-touch fitting for ø3.2
C4	With One-touch fitting for ø4
C6	With One-touch fitting for ø6
M5	M5 thread

⑮ Fitting assembly part no. (For P, R port)

VVQ1000-51A-C8

Applicable tubing ø8

Note) Purchasing order is available in units of 10 pieces.

VQC

SQ

VQ0

VQ4

VQ5

VQZ

VQD