

Series VQ1000

Body Ported

Plug Lead Unit: Flip Type

How to Order Manifold

Series

1	VQ1000
---	--------

Manifold

4	Plug lead unit/Flip
---	---------------------

Stations

01	1 station
⋮	⋮

The number of max. stations differs from kit to kit. (Refer to the table below.)

Option

Nil	None (C kit only)
D ⁽²⁾	DIN rail mounting style
K ⁽³⁾	Special wiring specifications (Except double wiring)
N	With name plate
S ⁽⁴⁾	Built-in silencer, direct exhaust

Note 1) When two or more symbols are specified, indicate them alphabetically. Example) -DNS
 Note 2) F, P, T, and S kits are DIN rail mounting styles, so include suffix -D.
 Note 3) Specify the wiring specifications in the manifold specification sheet. (Except C kit)
 Note 4) F, P, T and S kits are provided with an exhaust on one side, while C kits are with an exhaust on both sides.

Simple specials are available with SMC Simple Specials System. For details about applicable models, please contact SMC.

Kit/Electrical entry/Cable length

F kit (D-sub connector)

25P Note)

3 m

25P Note)

Side entry

Top entry

Connector entry direction				Max. 16 ⁽²⁾ stations
Top entry	Side entry	Kit F	Kit F	
U0	S0			Without cable
U1	S1			With cable (1.5 m)
U2	S2			With cable (3 m)
U3	S3			With cable (5 m)

P. 2-4-38

P kit (Flat ribbon cable connector)

26P Note)

26P Note)

Side entry

Top entry

Connector entry direction				Max. 16 ⁽²⁾ stations
Top entry	Side entry	Kit P	Kit P	
U0	S0			Without cable
U1	S1			With cable (1.5 m)
U2	S2			With cable (3 m)
U3	S3			With cable (5 m)

P. 2-4-42

T kit (Terminal block)

P. 2-4-46

Kit T 1	No. of terminals: 8, 1 row	Applicable stations 1 to 8
Kit T 2	No. of terminals: 16, 2 rows	Applicable stations 5 to 16

C kit (Connector)

P. 2-4-50

Kit C	Connector kit	Max. 16
-------	---------------	---------

S kit (Serial transmission unit)

The valve is equipped with an indicator light/surge voltage suppressor and the voltage is 24 VDC.

The dust-protected type SI unit is applicable, too. For details, please contact SMC.

P. 2-4-54

Kit S ⁽³⁾		Max. 16 ⁽²⁾ stations
0	Without SI unit	
A	With general type SI unit (Series EX300)	
B	Mitsubishi Electric Corp.: MELSECNET/mini-S3 Data Link System	
C	OMRON Corp.: SYSBUS Wire System	
D	SHARP Corp.: Satellite I/O Link System	
F1	NKE Corp.: Uni-wire System (16 output points)	
H	NKE Corp.: Uni-wire H System	

Note 1) Besides the above, F and P kits with different number of pins are available. For details, refer to page 2-4-68.
 Note 2) See page 2-4-69 for details.
 Note 3) Please consult with SMC for the following serial transmission kits: Matsushita Electric Works, Ltd.; Rockwell Automation, Inc.; SUNX Corporation; Fuji Electric Co., Ltd.; OMRON Corporation.

How to Order Valves

VQ 1 1 4 0 Y 5 L C6

Series
1 VQ1000

Type of actuation

1	2 position single (A/B)
2	2 position double (Latching) Metal seal Rubber seal
3	3 position closed center (A/B)
4	3 position exhaust center (A/B)
5	3 position pressure center (A/B)

Note) L type plug connector is used for 3 position AS.

Coil voltage

1	100 VAC (50/60 Hz)
2	200 VAC (50/60 Hz)
3	110 VAC (50/60 Hz)
4	220 VAC (50/60 Hz)
5	24 VDC
6	12 VDC

Note) The C kit is applicable to 200/220 VAC.

Function

Symbol	Specifications	DC	AC
Nil	Standard type	(1.0 W)	○ (1)
H	High pressure type	(1.5 W)	—
Y	Low wattage type	(0.5 W)	—

Note 1) For power consumption of AC type, refer to page 2-4-36.
Note 2) Except double (latching).

Seal

0	Metal seal
1	Rubber seal

For negative common specifications, refer to "Option" on page 2-4-69. Connector assembly will be required when the F, P, T, S kits add a valve. For part nos., refer to "Option" on page 2-4-69.

Electrical entry

	VQ1000
G: Grommet C kit single only. (Except AC.)	
L: L plug connector With lead wire	 With light/surge voltage suppressor
LO: L plug connector Without connector	 With light/surge voltage suppressor
M: M plug connector With lead wire	 With light/surge voltage suppressor
MO: M plug connector Without connector	 With light/surge voltage suppressor

Note) LO and MO valves are used for F, P, T and S kits. The plug connector and lead wire are attached to the manifold.

Cylinder port

Symbol	Port size
C3	With One-touch fitting for ø3.2
C4	With One-touch fitting for ø4
C6	With One-touch fitting for ø6
M5	M5 thread

Note) For inch-size One-touch fittings, refer to "Option" on page 2-4-69.

Manual override

Nil: Non-locking push type (Tool required)	B: Locking type (Tool required)	C: Locking type (Manual)
---	------------------------------------	-----------------------------

Note) A manual override for pilot valve is provided to the standard model for double type.

Manual override body side
Pilot valve
Manual override
Bore ø2.6

- VQC
- SQ
- VQ0
- VQ4
- VQ5
- VQZ
- VQD

Manifold Option

P. 2-4-59

Blanking plate assembly
VVQ1000-10A-4

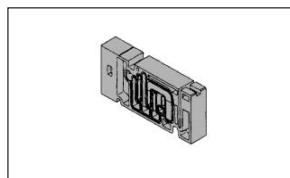

Double check block
VQ1000-FPG-□□

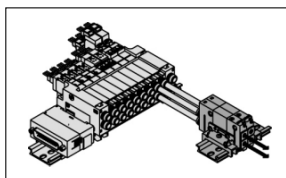

Block valve VQ140-□-□-□-□

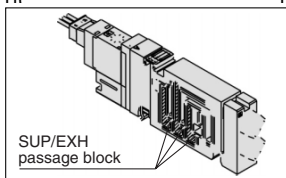

Individual SUP spacer
VVQ1000-P-4-C6

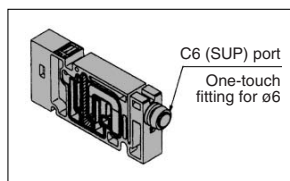

DIN rail mounting bracket
VVQ1000-57A-4

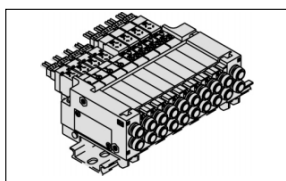

Port plug
VVQ000-58A

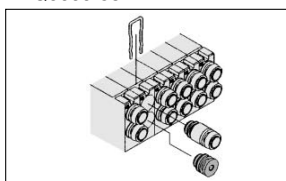

Individual EXH spacer
VVQ1000-R-4-C6

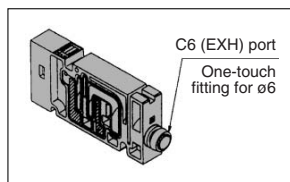

Built-in silencer, direct exhaust [-S]

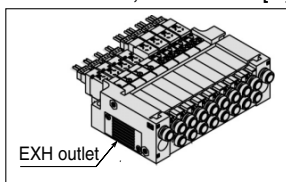

Blanking plug KQ2P-²³/₀₆

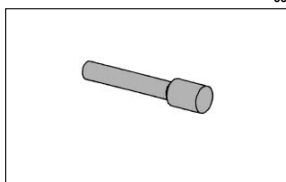

Name plate [-N4]
VVQ1000-N4-Station (1 to Max. stations)

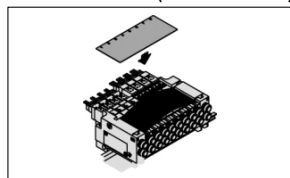

Silencer (For EXH port)
AN103-X233

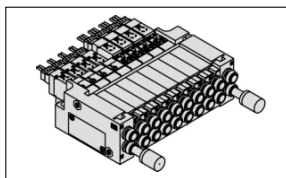

How to Order Manifold Assembly

Example

Single solenoid (24 VDC)
VQ1140-5LO-C6 (4 sets)

Double solenoid (24 VDC)
VQ1240-5LOB-C6 (4 sets)

3 m

D-sub connector cable

F kit (D-sub connector)

Manifold base (8 stations)

Cylinder port C6: With One-touch fitting for ø6

U side Spacers

VV5Q14-08FU2-D ... 1 set (F kit 8 station manifold base no.)
*VQ1140-5LO-C6 ... 4 sets (Single solenoid part no.)
*VQ1240-5LOB-C6 ... 4 sets (Double solenoid part no.)

The asterisk denotes the symbol for assembly. Prefix it to the part nos. of the solenoid valve, etc.

Please indicate manifold base type, corresponding valve, and option parts. When entry of part numbers becomes complicated, indicate on the manifold specification sheet.

• For replacement parts, refer to page 2-4-107.

Plug Lead Unit: Flip Type Series VQ0000/1000/2000

Manifold Specifications

Series	Base model	Type of connection	Porting specifications		Applicable stations ⁽²⁾	Applicable solenoid valve	5 station weight (g)	
			Port location	Port size ⁽¹⁾				
				1(P), 3(R)				4(A), 2(B)
VQ0000	VV5Q04-□□□	<ul style="list-style-type: none"> ■ F kit-D-sub connector ■ P kit-Flat cable connector ■ T kit-Terminal block ■ C kit-Individual connector ■ S kit-Serial transmission unit 	Side	C6 (ø6) Option Built-in silencer, direct exhaust	C3 (ø3.2) C4 (ø4) M5 (M5 thread)	1 to 16 stations	VQ0□40 VQ0□41	225
VQ1000	VV5Q14-□□□	<ul style="list-style-type: none"> ■ F kit-D-sub connector ■ P kit-Flat cable connector ■ T kit-Terminal block ■ C kit-Individual connector ■ S kit-Serial transmission unit 	Side	C6 (ø6) Option Built-in silencer, direct exhaust	C3 (ø3.2) C4 (ø4) C6 (ø6) M5 (M5 thread)		VQ1□40 VQ1□41	380
VQ2000	VV5Q24-□□□	<ul style="list-style-type: none"> ■ F kit-D-sub connector ■ P kit-Flat cable connector ■ T kit-Terminal block ■ C kit-Individual connector ■ S kit-Serial transmission unit 	Side	C8 (ø8) Option Built-in silencer, direct exhaust	C4 (ø4) C6 (ø6) C8 (ø8)		VQ2□40 VQ2□41	671



Note 1) Inch-size One-touch fittings are also available. For details, refer to page 2-4-69.

Note 2) See page 2-4-69 for details.

VQC

SQ

VQ0

VQ4

VQ5

VQZ

VQD

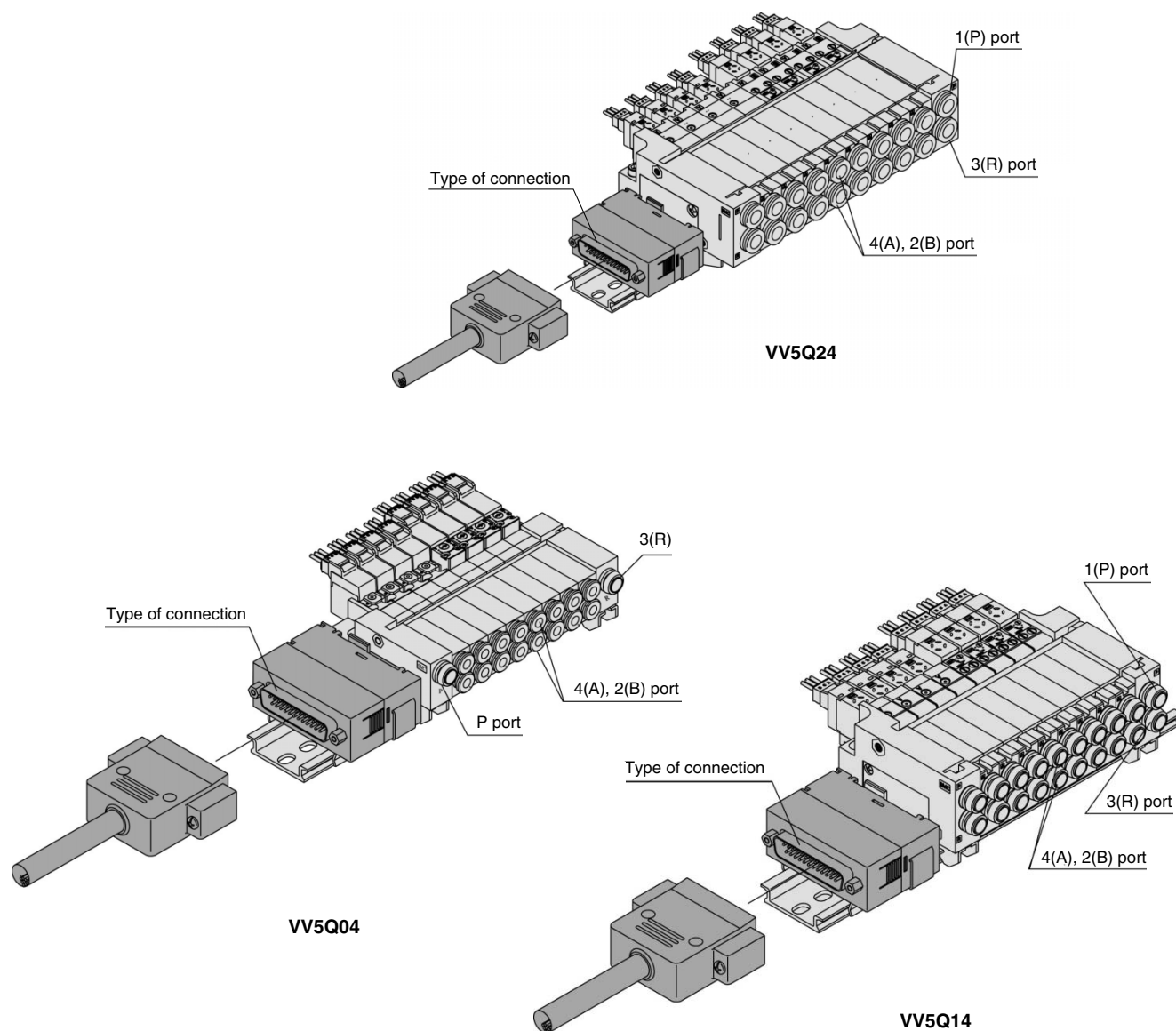

P VQ0000/1000/2000 Kit (Flat ribbon cable connector)

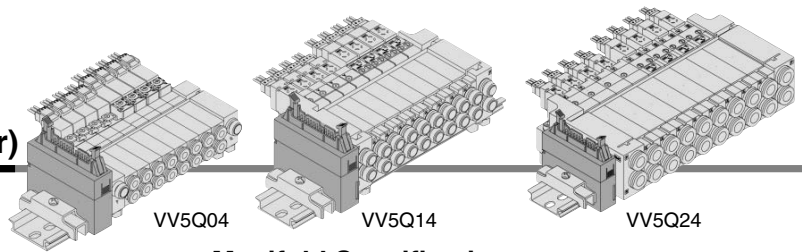

- MIL flat ribbon cable connector reduces installation labor savings for electrical connection.
- Using the connector for flat ribbon cable (26P), (10P, 16P, 20P as an option) conforming to MIL standard permits the use of connectors put on the market and gives a wide interchangeability.
- Top or side receptacle position can be selected in accordance with the available mounting space.
- Maximum stations are 16.

Manifold Specifications

Series	Porting specifications			Applicable stations
	Port location	Port size		
		1(P), 3(R)	4(A), 2(B)	
VQ0000	Side	C6	C3, C4, M5	Max. 16 stations
VQ1000	Side	C6	C3, C4, C6, M5	Max. 16 stations
VQ2000	Side	C8	C4, C6, C8	Max. 16 stations

Flat Ribbon Cable (26 pins)

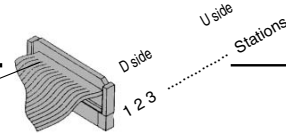

Cable assembly

AXT100-FC26-1 to 3

(Flat ribbon cable connector assembly can be ordered individually or included in a specific manifold model no. Refer to How to Order Manifold.)

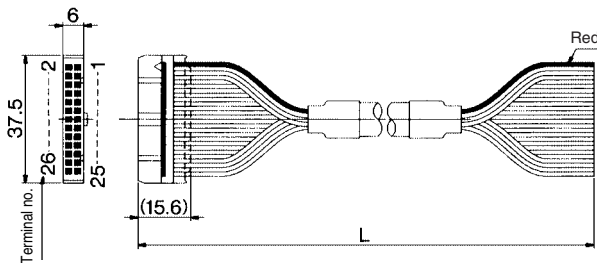

Flat Ribbon Cable Connector Assembly (Option)

Cable length (L)	Assembly part no.	Note
1.5 m	AXT100-FC26-1	Cable 26 core x 28AWG
3 m	AXT100-FC26-2	
5 m	AXT100-FC26-3	

* For other commercial connectors, use a 26 pins type with strain relief conforming to MIL-C-83503.

Connector manufacturers' example

- Hirose Electric Co., Ltd.
- Sumitomo 3M Limited
- Fujitsu Limited
- Japan Aviation Electronics Industry, Ltd.
- J.S.T. Mfg. Co., Ltd.
- Oki Electric Cable Co., Ltd.

Note) Types with 10, 16, or 20 pin are also available. For details, refer to page 2-4-69.

VV5Q14

The total number of stations is tabulated starting from station one on the D side.

Electrical wiring specifications

Flat ribbon cable connector

Terminal no.	Polarity	
1 station { SOL.A 1	(-)	(+)
SOL.B 2	(-)	(+)
2 stations { SOL.A 3	(-)	(+)
SOL.B 4	(-)	(+)
3 stations { SOL.A 5	(-)	(+)
SOL.B 6	(-)	(+)
4 stations { SOL.A 7	(-)	(+)
SOL.B 8	(-)	(+)
5 stations { SOL.A 9	(-)	(+)
SOL.B 10	(-)	(+)
6 stations { SOL.A 11	(-)	(+)
SOL.B 12	(-)	(+)
7 stations { SOL.A 13	(-)	(+)
SOL.B 14	(-)	(+)
8 stations { SOL.A 15	(-)	(+)
SOL.B 16	(-)	(+)
COM. 25	(+)	(-)
COM. 26	(+)	(-)

Note) When using the negative common specifications, use valves for negative common. (Refer to page 2-4-69.)

As the standard electrical wiring specifications, double wiring (connected to SOL. A and SOL. B) is adopted for the internal wiring of each station for 8 stations or less, regardless of valve and option types. Mixed single and double wiring is available as an option. For details, refer to page 2-4-69.

How to Order Manifold

VV5Q 1 4 - 08 P S 1 - D

Series	
0	VQ0000
1	VQ1000
2	VQ2000

Manifold	
4	Plug lead unit/Flip

Stations	
01	1 station
⋮	⋮
16	16 stations

Note) For details, refer to page 2-4-69.

Cable (Length)	
0	Without cable
1	With cable (1.5 m)
2	With cable (3 m)
3	With cable (5 m)

Connector entry direction	
U	Top entry
S	Side entry

Option	
D ⁽²⁾	DIN rail mounting style
K ⁽³⁾	Special wiring specifications (Except double wiring)
N	With name plate
S	Built-in silencer, direct exhaust (U side only)

- Note 1) When two or more symbols are specified, indicate them alphabetically. Example) -DNS
- Note 2) P kits are DIN rail mounting styles, so include suffix -D.
- Note 3) Specify the wiring specifications on the manifold specification sheet.

P VQ0000/1000/2000 Kit (Flat ribbon cable connector)

VQ1000

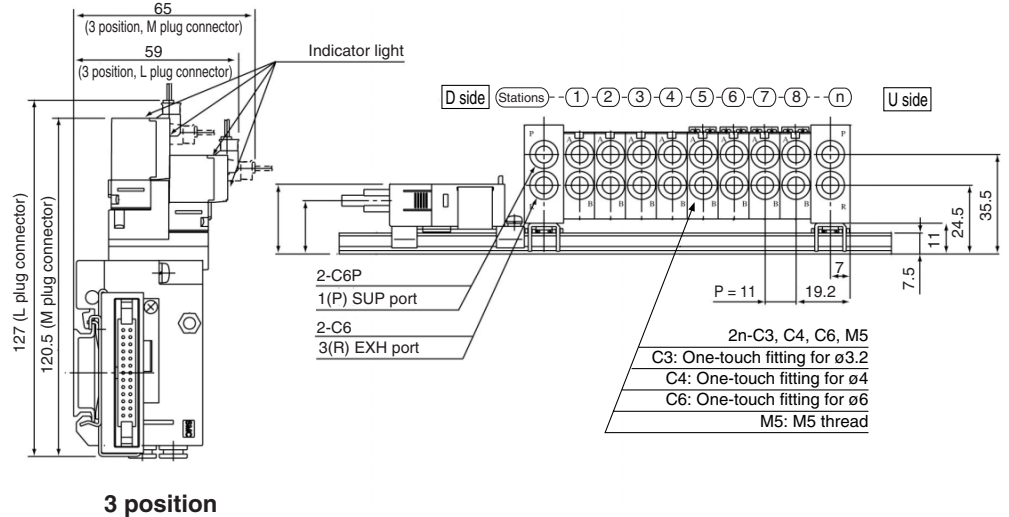
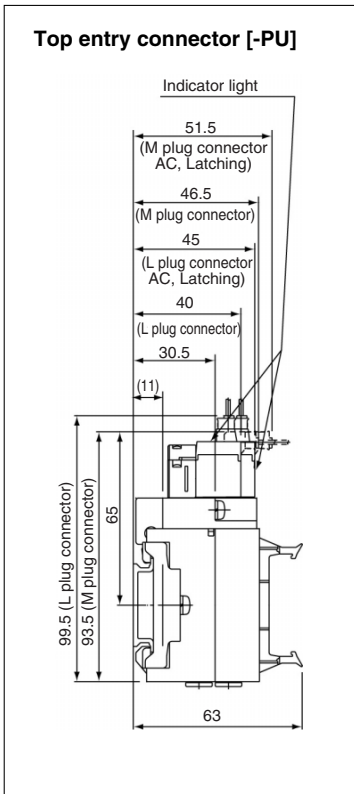
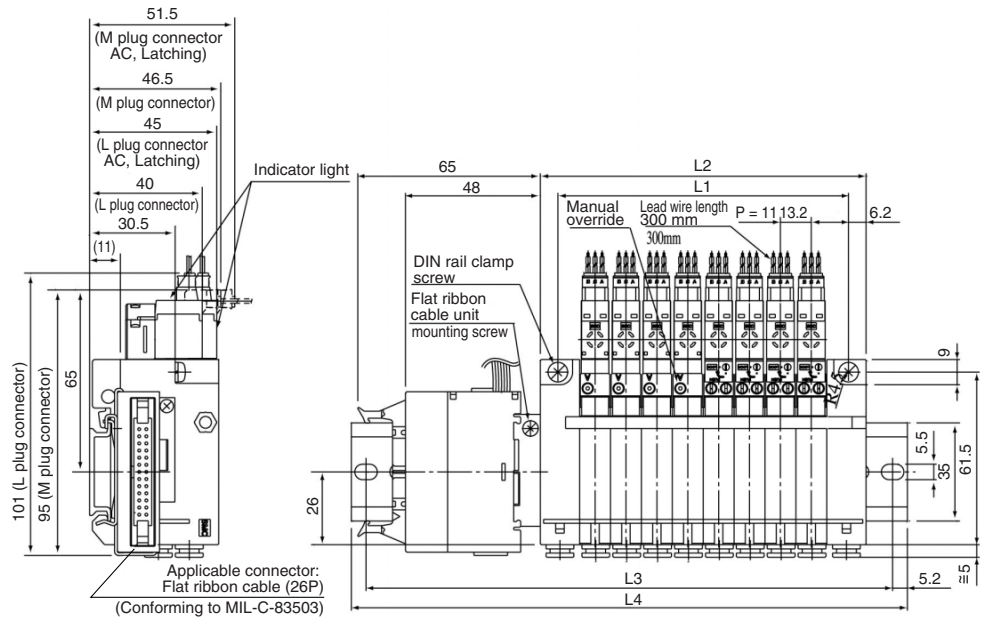

Dimensions: Side Entry Connector [-PS]

Formula $L1 = 11n + 15.5$, $L2 = 11n + 28$ n: Stations (Maximum 16 stations)

L \ n	1	2	3	4	5	6	7	8	9	10	11	12	13	14	15	16
L1	26.5	37.5	48.5	59.5	70.5	81.5	92.5	103.5	114.5	125.5	136.5	147.5	158.5	169.5	180.5	191.5
L2	39	50	61	72	83	94	105	116	127	138	149	160	171	182	193	204
L3	112.5	125	137.5	150	162.5	175	187.5	187.5	200	212.5	225	237.5	250	262.5	275	287.5
L4	123	135.5	148	160.5	173	185.5	198	198	210.5	223	235.5	248	260.5	273	285.5	298

Dimensions: Top Entry Connector [-PU]

L \ n	1	2	3	4	5	6	7	8	9	10	11	12	13	14	15	16
L3	87.5	100	112.5	125	137.5	150	162.5	162.5	175	187.5	200	212.5	225	237.5	250	262.5
L4	98	110.5	123	135.5	148	160.5	173	173	185.5	198	210.5	223	235.5	248	260.5	273

Series VQ0000/1000/2000

Manifold Option Parts for VQ0000

DIN rail mounting bracket VVQ0000-57A-4

It is used for mounting a manifold on a DIN rail. The DIN rail mounted bracket is fixed to the manifold end plate.

(The specification is the same as that for the option -D.)

1 set of DIN rail mounting bracket is used for 1 manifold (2 DIN rail mounting brackets).

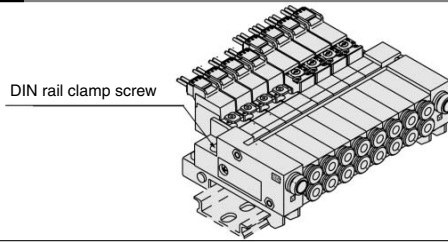

* When ordering assemblies incorporated with a manifold, add suffix -D to the manifold no.

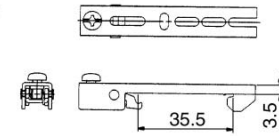

Built-in silencer, Direct exhaust [-S]

This is a type with an exhaust port atop the manifold end plate. The built-in silencer exhibits an excellent noise suppression effect.

F, P, T and S kits are provided with exhaust on one side.

Note) A large quantity of drainage generated in the air source results in exhaust of air together with drainage.

• For maintenance, refer to page 2-4-67.

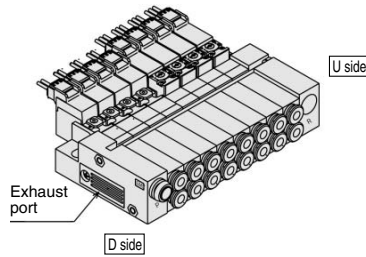

* When ordering assemblies incorporated with a manifold, add suffix -S to the manifold no.

Manifold Option Parts for VQ1000

Blanking plate assembly VVQ1000-10A-4

It is used when a blanking plate is mounted to a manifold in advance for possible valve mounting, etc.

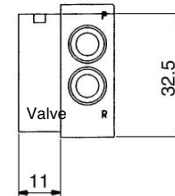
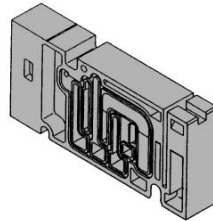

Individual SUP spacer VVQ1000-P-4-C6

When the same manifold is to be used for different pressures, individual SUP spacers are used as SUP ports for different pressures. (One station space is occupied.) Since the SUP passage on the spacer's D side is blocked in advance, it is mounted on the D side of the valve for individual supply while blocking the valve's U side. (See the application ex.)

* Specify the spacer mounting position and SUP block plate mounting position on the manifold specification sheet.

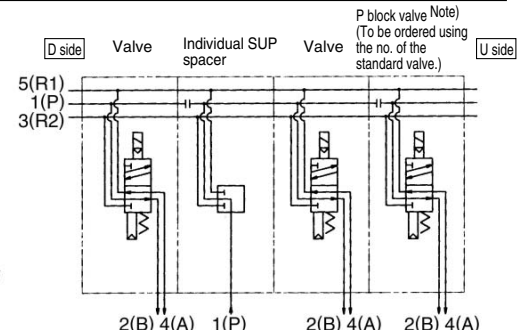
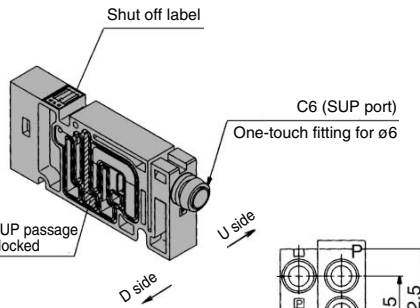

Note) P block valve is mounted in the blocking position when ordering an individual SUP spacer incorporated with a manifold. When separately ordering an individual SUP spacer, separately order a P block valve.

Individual EXH spacer VVQ1000-R-4-C6

When valve exhaust affects other stations due to the circuit configuration, this spacer is used for individual valve exhaust. (One station space is occupied.)

Since the EXH passage on the spacer's D side is blocked in advance, it is mounted on the D side of the valve for individual supply while blocking the valve's U side. (Refer to the application example.)

* Specify the spacer mounting position and EXH block plate mounting position on the manifold specification sheet.

* When the electrical entry is F, P, T, S kit, and if you choose the option with built-in silencer, no exhaust port will be supplied on the D side end plate.

In this case, install a spacer for individual EXH on the 1st station.

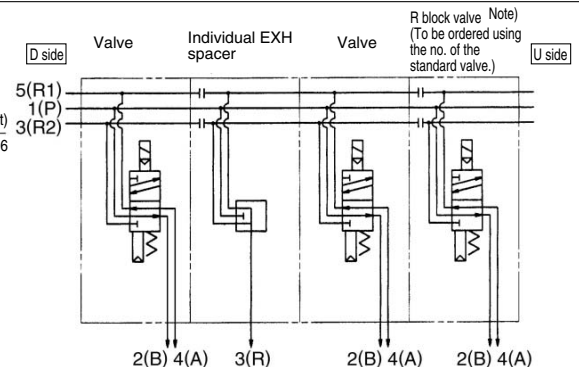
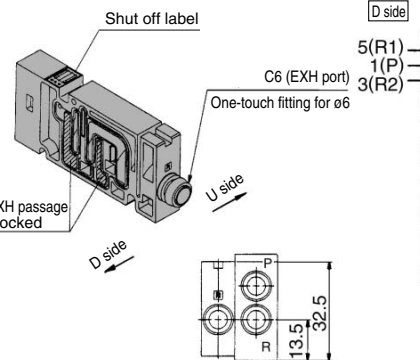

Note) R block valve is mounted in the blocking position when ordering an individual EXH spacer incorporated with a manifold. When separately ordering an individual EXH spacer, separately order an R block valve.

Plug Lead Unit: Flip Type Series VQ0000/1000/2000

Manifold Option Parts for VQ1000

Block valve

VQ1 $\frac{1}{2}$ 4[○]-□-□-□-^P/_{PR}

Valve no.
For a flip plug-in unit, block plate is built in the valve for blocking SUP and EXH passages. Since the no. is classified by the passage to be blocked, specify it by attaching the option no. to the valve no. The block valve is constructed so that D sides of SUP and EXH passages are blocked.

* Specify the number of stations on the manifold specification sheet.

<Shut off label>

When using block plates for SUP, EXH passage, indication label for confirmation of the blocking position from outside is attached. (One label for each)

* When ordering a block plate incorporated with the manifold no., a block indication label is attached to the manifold.

* Caution on using R/PR block valve If the electrical entry is selected for an option for built-in silencer when F, P, T, S kit, there will not be the exhaust port on the D side end plate. In this case, mount an individual EXH spacer for the 1st station.

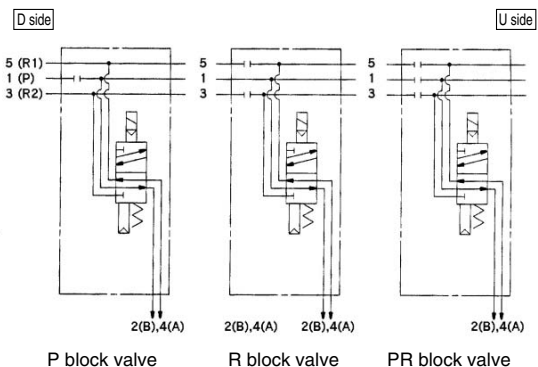
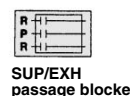
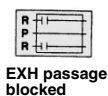
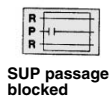
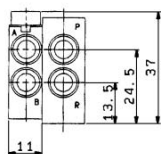
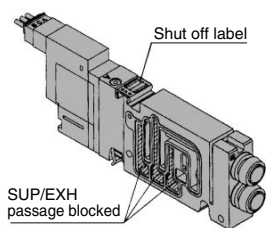

For SUP passage block	VQ1 $\frac{1}{2}$ 4 [○] -□-□-□- ^P
For EXH passage block	VQ1 $\frac{1}{2}$ 4 [○] -□-□-□- ^R
For SUP/EXH passage block	VQ1 $\frac{1}{2}$ 4 [○] -□-□-□- ^{PR}

VQC

SQ

VQ0

VQ4

VQ5

VQZ

VQD

Name plate [-N4]

VVQ1000-N4-Station (1 to Max. stations)

It is a transparent resin plate for placing a label that indicates solenoid valve function, etc. Insert it into the groove on the side of the end plate and bend it as shown in the figure.

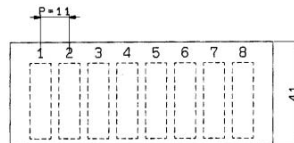
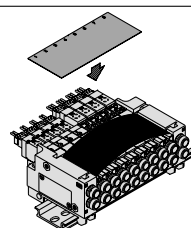

* When ordering assemblies incorporated with manifold, suffix [-N] to the manifold no.

Blanking plug

KQ2P-²³/₀₄/₀₆

It is inserted into an unused cylinder port and SUP/EXH ports. Purchasing order is available in units of 10 pieces.

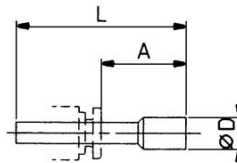
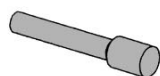

Dimensions

Applicable fittings size ϕ d	Model	A	L	D
3.2	KQ2P-23	16	31.5	5
4	KQ2P-04	16	32	6
6	KQ2P-06	18	35	8

DIN rail mounting bracket

VVQ1000-57A-4

It is used for mounting a manifold on a DIN rail. The DIN rail mounted bracket is fixed to the manifold end plate. (The specification is the same as that for the option -D.)

1 set of DIN rail mounting bracket is used for 1 manifold (2 DIN rail mounting brackets).

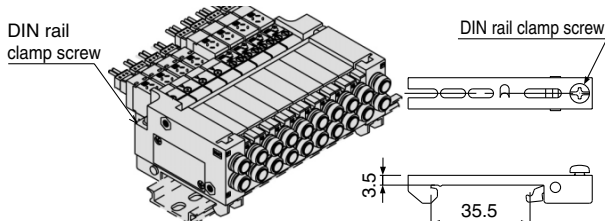

* When ordering assemblies incorporated with manifold, add suffix -D to the manifold no.

Built-in silencer, Direct exhaust [-S]

This is an exhaust port on top of the manifold end plate. The built-in silencer exhibits an excellent noise suppression effect. F, P, T and S kits are provided with exhaust on one side.

Note) A large quantity of drainage generated in the airsource results in exhaust of air together with drainage.

* For maintenance, refer to page 2-4-67.

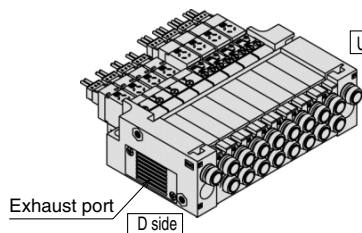

* When ordering assemblies incorporated with manifold, add suffix -S to the manifold no.

Silencer (For EXH port)

This is inserted into the centralized type EXH port (One-touch fitting).

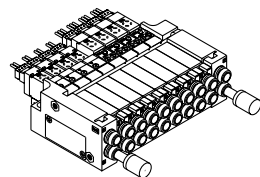
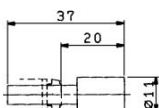

Dimensions

Series	Applicable fittings size ϕ d	Model	A	L	D	Effective area (mm ²)	Noise reduction (dB)
VQ1000	6	AN103-X233	20	37	11	7	25

Port plug

VVQ0000-58A

The plug is used to block the cylinder port when using a 4 port valve as a 3 port valve. When ordering it incorporated with a manifold, suffix A or B, the symbol of the plug port, to the valve no.

Example) VQ1140-5L-C6-A

↳ A port, Plug

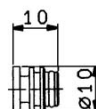
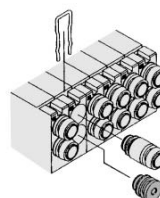

Series VQ0000/1000/2000

Manifold Option Parts

Double check block (Separated type): For VQ0000/1000 VQ1000-FPG-□□

It is used on the outlet side piping to keep the cylinder in the intermediate position for a long time. Combining the double check block with a built-in pilot type double check valve and a 3 position exhaust center solenoid valve will enable the cylinder to stop in the middle or maintain its position for a long time. The combination with a two position single/double solenoid valve will permit this block to be used for preventing the dropping at the cylinder stroke end when the SUP residual pressure is released.

Specifications

Max. operating pressure	0.8 MPa
Min. operating pressure	0.15 MPa
Ambient and fluid temperature	-5 to 50° C
Flow characteristics: C	0.60 dm ³ /(s·bar)
Max. operating frequency	180 CPM

Note) Based on JIS B 8375-1981 (Supply pressure: 0.5 MPa)

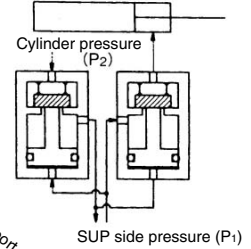
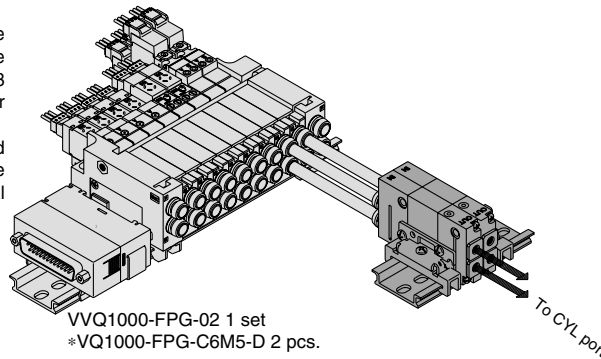

Dimensions

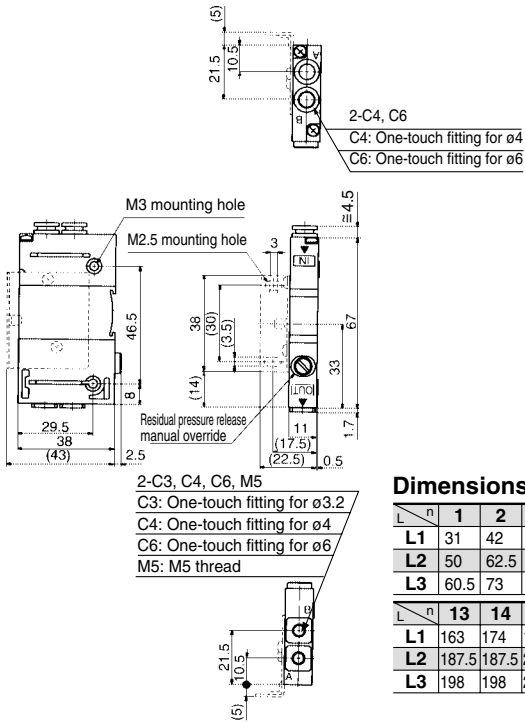

Manifold

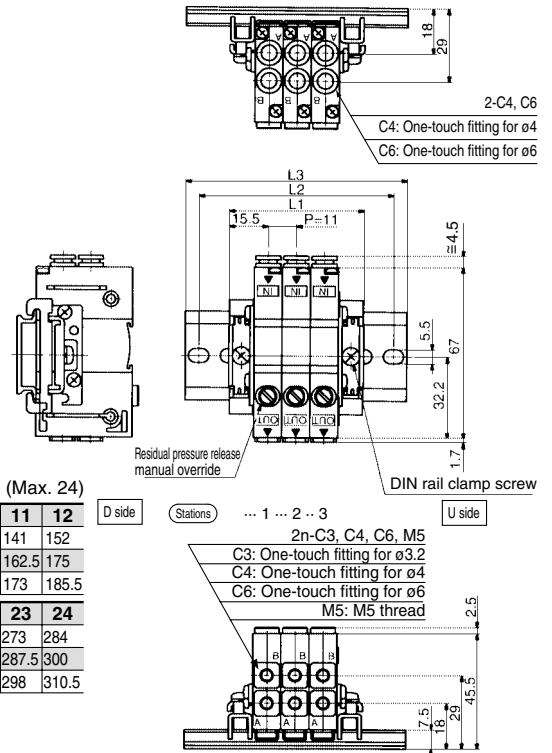

How to Order

Double check block

VQ1000-FPG-**C4** **M5** **F**

IN side port size

C4	One-touch fitting for ø4
C6	One-touch fitting for ø6

OUT side port size

M5	M5 thread
C3	One-touch fitting for ø3.2
C4	One-touch fitting for ø4
C6	One-touch fitting for ø6

Option

Nil	None
F	With bracket
D	DIN rail mounting style (For manifold)
N	Name plate

Note) When two or more symbols are specified, indicate them alphabetically. Example) -DN

Manifold

VVQ1000-FPG-**06**

Stations

01	1 station
⋮	⋮
16	16 stations

<Example>

VVQ1000-FPG-06....6 types of manifold
 *VQ1000-FPG-C4M5-D, 3 sets
 *VQ1000-FPG-C6M5-D, 3 sets } Double check block

<Example>

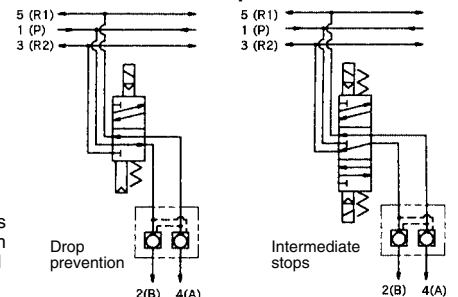

Caution

- Air leakage from the pipe between the valve and cylinder or from the fittings will prevent the cylinder from stopping for a long time. Check the leakage using neutral household detergent, such as dish washing soap. Also check the cylinder's tube gasket, piston packing and rod packing for air leakage.
- Since One-touch fittings allow slight air leakage, screw piping (with M5 thread) is recommended when stopping the cylinder in the middle for a long time.
- Combining double check block with 3 position closed center or pressure center solenoid valve will not work.
- M5 fitting assembly is attached, not incorporated into the double check block. After screwing in the M5 fittings, mount the assembly on the double check block. (Tightening torque: 0.8 to 1.2 N·m)
- If the exhaust of the double check block is throttled too much, the cylinder may not operate properly and may not stop intermediately.
- Set the cylinder load so that the cylinder pressure will be within two times that of the supply pressure.

⚠ Precautions

Be sure to read before handling. For Safety Instructions and Solenoid Valve Precautions, refer to page 2-9-2.

Light/Surge Voltage Suppressor

⚠ Caution

The lighting positions are concentrated on one side for both single solenoid and double (latching) type. In the double (latching) type, A side and B side energization are indicated by two colors which match the colors of the manual overrides.

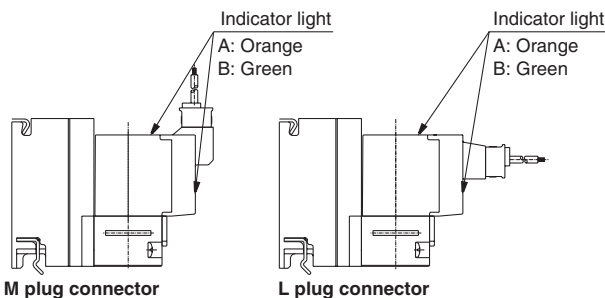
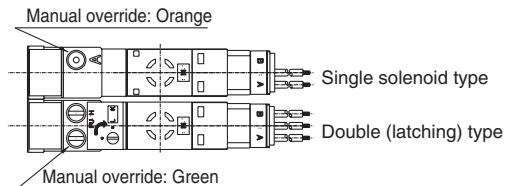

DC circuit diagram

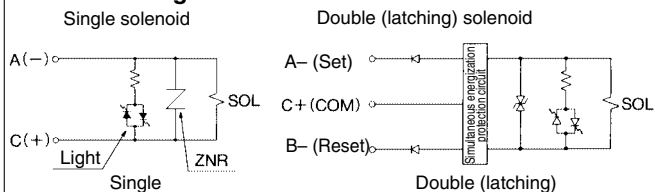

- Note 1) • A-side energization: A light (orange) illuminates. Note 3) In the case of double
 • B-side energization: B light (green) illuminates. (latching), the electromagnetic
 • Equipped with a wiring error prevention (stop valve channel is, A-(set):
 (ZNR/surge absorption diode) mechanism. P → A, B → R,
 B-(reset):
 P → B, A → R.
- Note 2) Applicable to negative COM specification models.

Double (Latching solenoid) Type

⚠ Caution

Different from the conventional double solenoid, the double type uses a latching (self-holding system) solenoid. Although the appearance is the same as the single solenoid, it is constructed so that the movable iron core in the solenoid is held in the ON position on A and B sides by instantaneous energization (20 ms or more). The usage and function is the same as the double solenoid.

<Special Cautions for Latching Solenoid>

- Select the circuit in which ON and OFF signals are not energized simultaneously.
- 20 ms energization time is necessary for self-holding.
- Avoid using the latching solenoid valves in environments where impact or collisions with the valve might occur. Also, do not use in places where strong magnetic fields are present.
- Even though the armature in the solenoid of this valve is held on to B side, ON position (Reset), verify either A side, ON position or B side, ON position by energizing prior to use.
- After manual operation, the main valve will return to its original position. Manual override on the pilot valve side can retain its switching position after manipulation.
- Please contact SMC for long-term energization applications.
- If the metal seal type goes down below the minimum operating pressure of supply air (0.1 MPa or less), the main valve will get back the home position. (B side ON position) Therefore, in the event of shutting the supply air or applying the air with being A side ON position remained, cylinder may be pulsated. In the event of manipulating the supply air, the valve's switching position has to be set in the home position side (B side ON position side).

How to Mount/Remove Solenoid Valve

⚠ Caution

<Procedure>

How to Remove

- Loosen tie-rod bolt B. (Two to four turns)
- After fully loosening the tie-rod bolt, take off bolt A upward as shown above.
- Slide the valves aside to make a 1 mm clearance between the valve to be taken off and the others. As shown above, remove the whole valve while holding up the (a) side. (Avoid rough handling of the connector.)

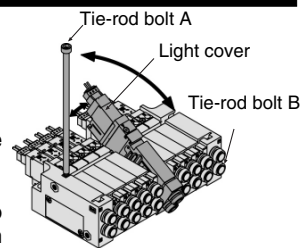

Mounting

Reverse the sequence of steps above to remount.

Tighten the tie-rod bolts with the tightening torque at the right table while using caution not to tighten the only one side unevenly.

Note) Be careful not to push on the light cover while mounting/removing the valve.

Torque Applied to Tie-rod Bolt

VQ0000	0.5 to 0.7 N·m
VQ1000	1.0 to 1.4 N·m
VQ2000	1.0 to 1.4 N·m

Double (Latching solenoid) Type

⚠ Warning

Without an electric signal for the solenoid valve the manual override is used for switching the main valve.

■ Push type (Tool required)

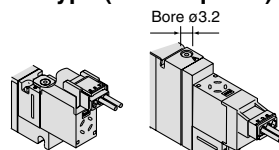

Push down on the manual override button with a small screwdriver until it stops. Release the screwdriver and the manual override will return.

VQ0000

■ Locking slotted type

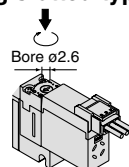

VQ1000
VQ2000

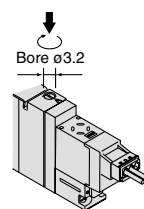

VQ1000
VQ2000

If the manual override is turned by 180° clockwise and the ► mark is adjusted to 1, then pushed in the direction of an arrow (↓), it will be locked in the ON state. If the manual override is turned by 180° counterclockwise and ► mark is adjusted to 0, locking will be released and the manual override will return.

Push down completely on the manual override button with a small screwdriver. While down, turn clockwise 90° to lock it. Turn it counterclockwise to release it.

■ Locking lever type (Option)

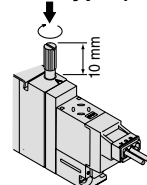

VQ1000
VQ2000

Push down completely on the manual override button with a small screwdriver. While down, turn clockwise 90° to lock it. Turn it counterclockwise to release it.

■ Manual override for double (latching) type

In the case of a double (latching) type, a manual override is provided not only on the body side but to the pilot as a standard. (VQ0000: Pilot valve only). After manual operation, the main valve of the manual on the body side returns to the position before the manual operation, however, the pilot valve manual override maintains the change-over position.

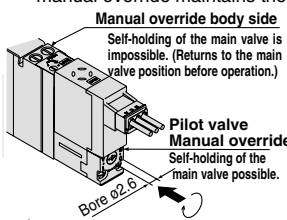

- If the manual override is turned by 180° clockwise and the ► mark is adjusted to A, then pushed in the direction of an arrow (◀), it will be back to the reset condition. (passage P → A)
- If the manual override is turned by 180° counterclockwise and the ► mark is adjusted to B, then pushed in the direction of an arrow (▶), it will be back to the reset condition. (passage P → B) (It is in the reset state at the time of shipment.)

⚠ Caution

Do not apply excessive torque when turning the locking type manual override. (0.1 N·m or less)

Plug Lead Unit: Flip Type Series VQ0000/1000/2000

Replacement of Cylinder Port Fittings

⚠ Caution

The cylinder port fittings are a cassette for easy replacement. (Except VQ1000)

The fittings are blocked by a clip inserted from the top of the valve. Remove the clip with a screwdriver to remove fittings. For replacement, insert the fitting assembly until it strikes against the inside wall and then re-insert the clip to the specified position.

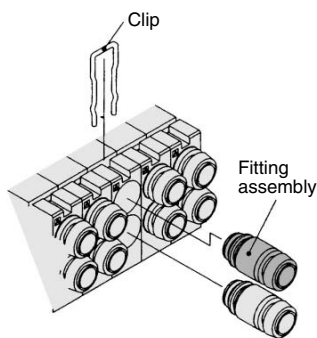

Applicable tubing O.D	Fitting assembly part no.	
	VQ1000	VQ2000
Applicable tubing ø3.2	VVQ1000-50A-C3	—
Applicable tubing ø4	VVQ1000-50A-C4	VVQ1000-51A-C4
Applicable tubing ø6	VVQ1000-50A-C6	VVQ1000-51A-C6
Applicable tubing ø8	—	VVQ1000-51A-C8

Purchasing order is available in units of 10 pieces.

Caution

1. Protect O-rings from scratches and dust to prevent air leakage.
2. The tightening torque for inserting fittings to the M5 thread assembly should be 0.8 to 1.4 N·m

Mounting/Removing from the DIN Rail

⚠ Caution

<Procedure>

How to Remove

1. Loosen the clamp screw on side (a) of the end plate on both sides.
2. Lift side (a) of the manifold base and slide the end plate in the direction of (2) shown in the figure to remove.

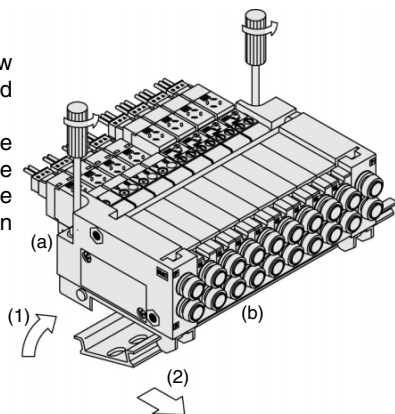

Mounting

1. Hook side (b) of the manifold base on the DIN rail.
2. Press down side (a) and mount the end plate on the DIN rail. Tighten the clamp screw on side (a) of the end plate. The proper tightening torque for screws is 0.4 to 0.6 N·m.

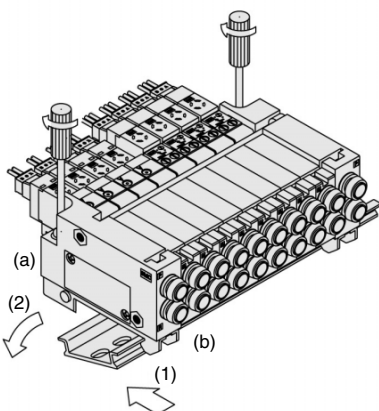

How to Calculate the Flow Rate

For obtaining the flow rate, refer to pages 2-1-8 to 2-1-11.

Built-in Silencer Replacement Element

⚠ Caution

A silencer element is incorporated in the end plate on both sides of the manifold base. A dirty and choked element may reduce cylinder speed or cause malfunction. Clean or replace the dirty element.

Element Part No.

Type	Element part no.		
	VQ0000	VQ1000	VQ2000
Built-in silencer, direct exhaust (-S)	VVQ0000-82A-4	VVQ1000-82A-4	VVQ2000-82A-4

* The minimum order quantity is 10 pcs.

Remove the cover from the side of the end plate and remove the old element with a screwdriver, etc.

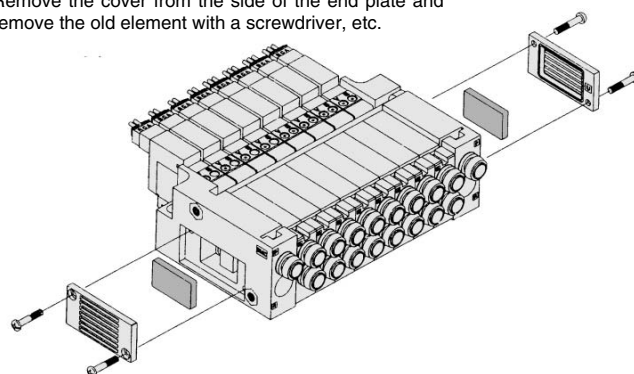

How to Use Plug Connector

⚠ Caution

Attaching and detaching connectors

To attach a connector, hold the lever and connector unit between your fingers and insert straight onto the pins of the solenoid valve so that the lever's pawl is pushed into the groove and locks.

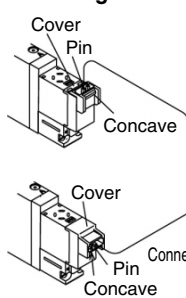

DC indicator Socket Part no. DXT170-71-1
Lead wire 0.2 to 0.33 mm²
(Max. cover diameter ø1.7 mm)

Crimping the lead wire and socket

Peel 3.2 to 3.7 mm of the tip of lead wire, enter the core wires and press contact it by a press tool. Be careful so that the cover of lead wire does not enter into the core contacting part.

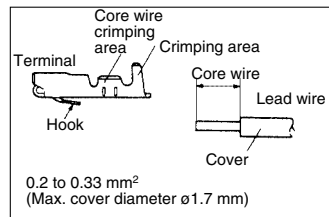

Attaching and detaching lead wires with sockets

Attaching

Insert a socket in the square hole (Indicated as +, -) of connector, push in the lead wire and lock by hanging the hook of socket to the seat of connector. (Pushing-in can open the hook and lock it automatically.) Then confirm the lock by lightly pulling on the lead wire.

Detaching

To detach a socket from a connector, pull out the lead wire while pressing the socket's hook with a stick having a thin tip (approx. 1 mm). If the socket will be used again, first spread the hook outward.

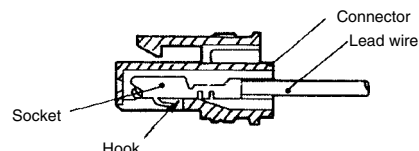

Series VQ0000/1000/2000

Option

Different Number of Connector Pins

F and P kits with the following number of pins are available. Besides the standard number (F = 25; P = 26) select the desired number of pins and cable length from the cable assembly list. Place an order for the cable assembly separately.

F kit (D-sub connector) 15 pins

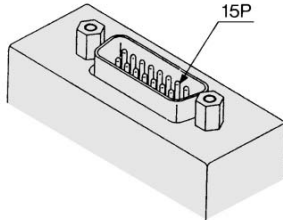

How to order manifold

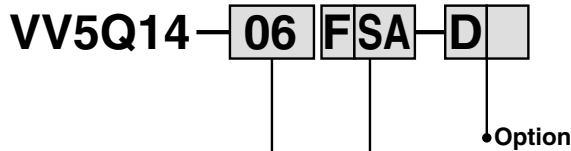

How to Order
D-sub connector, 15 pins
Connector location-Side (horizontal)
Without cable

Kit/Electrical entry

Pins	Location		Top entry		Side entry	
	Kit F	UA	Kit F	SA		
15P (Max. 7 stations)						

Wiring specifications

* In the same way as the 25-pin models (standard) the terminal no. 1 is for SOL.A at the 1st station, the terminal no. 9 for SOL.B at the 1st station, and the terminal no. 8 for COM.

P kit (Flat ribbon cable connector) 10 pins, 16 pins, 20 pins

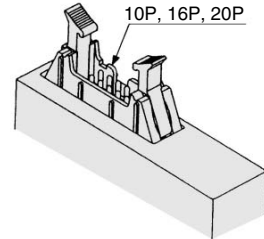

How to order manifold

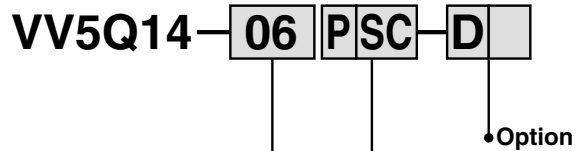

How to Order
Flat ribbon cable, 20 pins
Connector location-Side (Horizontal)
Without cable

Kit/Electrical entry

Pins	Location		Top entry		Side entry	
	Kit P	UA	Kit P	SA		
10P (Max. 4 stations)						
16P (Max. 7 stations)						
20P (Max. 8 stations)						

Wiring Specifications

* In the same way as the 26-pin models (standard) the terminal no. 1 is for SOL.A at the 1st station, the terminal no. 2 for SOL.B at the 1st station, and two pins from the max. terminal numbers are for COM.

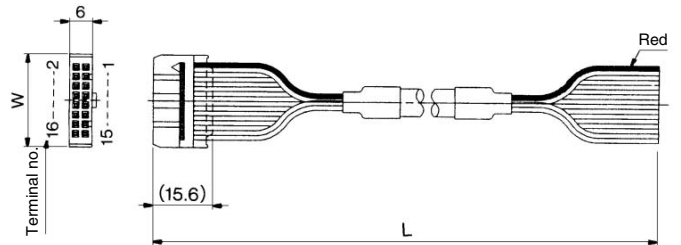

Flat Ribbon Cable Assembly

Cable length (L)	Pins	10P	16P	20P
1.5 m		AXT100-FC10-1	AXT100-FC16-1	AXT100-FC20-1
3 m		AXT100-FC10-2	AXT100-FC16-2	AXT100-FC20-2
5 m		AXT100-FC10-3	AXT100-FC16-3	AXT100-FC20-3
Connector width (W)		17.2	24.8	30

* For other commercial connectors, use a type with strain relief conforming to MIL-C-83503.

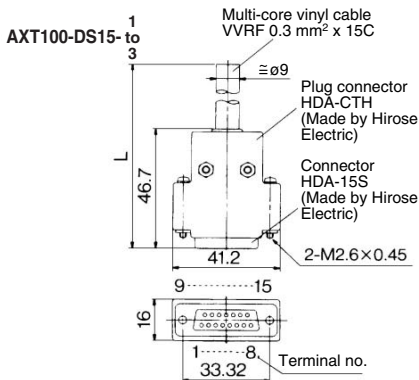

Wire Color by Terminal No. of D-sub Connector Cable Assembly

Terminal no.	Lead wire color	Dot marking
1	Black	None
2	Brown	None
3	Red	None
4	Orange	None
5	Yellow	None
6	Pink	None
7	Blue	None
8	Purple	White
9	Gray	Black
10	White	Black
11	White	Red
12	Yellow	Red
13	Orange	Red
14	Yellow	Black
15	Pink	Black

D-sub Connector Cable Assembly

Cable length (L)	Pins	15P
1.5 m		AXT100-DS15-1
3 m		AXT100-DS15-2
5 m		AXT100-DS15-3

* For other commercial connectors, use a type conforming to MIL-C-24308.

Plug Lead Unit: Flip Type Series VQ0000/1000/2000

Special Wiring Specifications

In the internal wiring of F kit, P kit, T kit and S kit, double wiring (connected to SOL. A and SOL. B) is adopted for each station regardless of the valve and option types.

Mixed single and double wiring is available as an option.

1. How to order valves

Indicate an option symbol, -K, for the manifold no. and be sure to specify the mounting position and number of stations of the single and double wiring by means of the manifold specification sheet.

Example)

VV5Q14-09FS0-D K S



Others, option symbols: to be indicated alphabetically.

2. Wiring specifications

Connector terminal numbers are connected from solenoid station 1 on the A side in the order indicated by the arrows without skipping any terminal numbers.

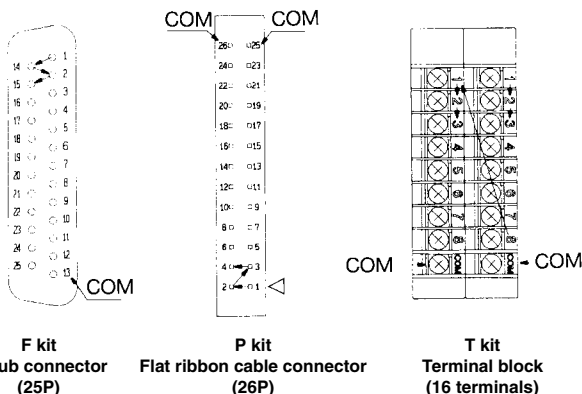

3. Max. number of stations

The maximum number of stations depends upon the number of solenoids. Assuming one for a single and two for a double, determine the number of stations so that the total number is not more than the maximum number given in the following table.

kit	F kit (D-sub connector)		P kit (Flat ribbon cable connector)				T kit (Terminal block)		S kit (Serial)
Type	F□ 25P	F□A 15P	P□ 26P	P□C 20P	P□B 16P	P□A 10P	T1	T2	S□
Max. points	Note) 16	14	Note) 16	Note) 16	14	8	8	16	16

Note) Due to the limitation of internal wiring.

Negative Common Specifications

Specify the valve model no. as shown below for negative COM specification. The standard manifold no. can be used. Please contact SMC for negative COM S kit.

How to order negative COM valves

VQ1140 N-5LO-C6

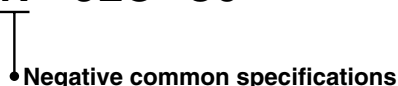

Inch-size One-touch Fittings

Refer to following model no. for inch-size One-touch fittings.

How to order manifold

VV5Q14-08FS0-DN-00T

P, R port size

VQ0000	ø1/4"
VQ1000	ø1/4"
VQ2000	ø5/16"

How to order valves

VQ1140-5M-N7

Cylinder port

Symbol	N1	N3	N7	N9
Applicable tubing O.D. (Inch)	ø1/8"	ø5/32"	ø1/4"	ø5/16"
A, B port	VQ0000	○	○	—
	VQ1000	—	○	○
	VQ2000	—	○	○

Plug Connector Assembly Model

Connector assembly will be required when the F, P, T, S kits add a valve.

Specify the type of valve and connector assembly.

Connector Assembly Part No.

Specifications		Part no.
Single (2-wire)	Positive common	AXT661-14A-F
	Negative common	AXT661-14AN-F
Double (latching) (3-wire)	Positive common	AXT661-13A-F
	Negative common	AXT661-13AN-F

Note) Lead wire length: 300 mm

Note) The parts numbers above are applicable to VQ0000/1000 (2 to 16 stations) and VQ2000 (2 to 10 stations). VQ2000 (11 to 16 stations) uses AXT661-13A(N)-F425.

VQC

SQ

VQ0

VQ4

VQ5

VQZ

VQD

Series VQ0000/1000/2000

Option

DIN Rail Mounting

Each manifold can be mounted on a DIN rail. Order it by indicating an option symbol for DIN rail mounting style, -D. In this case, a DIN rail which is approx. 30 mm longer than the manifold with the specified number of stations is attached. Besides, it is also available in the following cases.

- **When DIN rail is unnecessary (C kit only.)**
(DIN rail mounting brackets only are attached.)
Indicate the option symbol, -DO, for the manifold no.

Example)

VV5Q14-08C-DOS

Others, option symbols:
to be indicated alphabetically.

- **When using DIN rail longer than the manifold with specified number of stations**
Clearly indicate the necessary number of stations next to the option symbol, -D, for the manifold no.

Example)

VV5Q14-08FS1-D09S

DIN rail for 9 stations
Others, option symbols:
to be indicated alphabetically.

- **When changing the manifold style into a DIN rail mount**
Order brackets for mounting a DIN rail. (Refer to "Option" on pages 2-4-60, 61 and 64.)

No. VQ0000-57A4 (For VQ0000)
VQ1000-57A-4 (For VQ1000)
VQ2000-57A-4 (For VQ2000)
2 pcs. per one set

- **When ordering DIN rail only**
DIN rail no.: AXT100-DR-n

* Refer to the DIN rail dimension table for determining the length.

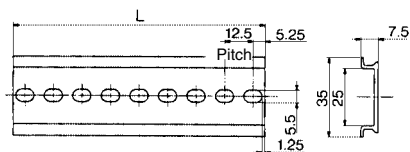

L Dimension

$$L = 12.5 \times n + 10.5$$

No.	1	2	3	4	5	6	7	8	9	10
L dimension	23	35.5	48	60.5	73	85.5	98	110.5	123	135.5
No.	11	12	13	14	15	16	17	18	19	20
L dimension	148	160.5	173	185.5	198	210.5	223	235.5	248	260.5
No.	21	22	23	24	25	26	27	28	29	30
L dimension	273	285.5	298	310.5	323	335.5	348	360.5	373	385.5
No.	31	32	33	34	35	36	37	38	39	40
L dimension	398	410.5	423	435.5	448	460.5	473	485.5	498	510.5

Series VQ

VQ1000 (VV5Q14)/Plug Lead Unit, Flip Type

(F, P, T, S kit)

* For how to increase the stations, refer to the instruction manual.

	Housing assembly and SI unit ⁽³⁾	U side end plate assembly	Valve	D side end plate assembly	Station increase parts
S kit					
P kit					
F kit					
T kit					

Note 1) S kit is composed of a flat ribbon cable housing assembly (AXT100-2-PU20) of ① SI unit and ② P kit (20 pins).

Note 2) Since no connector assembly is included, order it separately. (Refer to page 2-4-69.)

Note 3) A housing assembly is not used for a C kit.

Note 4) A DIN rail clamping bracket is attached to each.

<Housing Assembly and SI Unit>

Housing assembly and SI unit no.

No.	Manifold	Part no.	Description
① ⁽¹⁾	(SA kit)	EX330-S001	General type SI unit (Series EX300)
	(SB kit)	EX130-SMB1	SI unit for MELSECNET/MINI-S3 Data Link System (Mitsubishi Electric Corporation)
	(SC kit)	EX130-STA1	SI unit for SYSBUS Wire System (OMRON Corporation)
	(SD kit)	EX130-SSH1	SI unit for Satellite I/O Link System (SHARP Corporation)
	(SF1 kit)	EX130-SUW1	SI unit for 16 point Uni-wire System (NKE Corporation)
	(SH kit)	EX130-SUH1	SI unit for 16 point Uni-wire H System (NKE Corporation)
②	P _S ^U kit	AXT100-2-P _S ^U □ ⁽²⁾	Flat ribbon cable housing assembly □ = Number of pins: 26, 20, 16, 10
③	F _S ^U kit	AXT100-2-F _S ^U □ ⁽²⁾	D-sub connector housing assembly □ = Number of pins: 25, 15
④ ⁽³⁾	T kit	AXT100-2-TB1	Terminal block assembly (8 terminals)
⑤ ⁽³⁾	T kit	AXT100-2-TB2	Terminal block assembly (8 terminals)

Note 1) S kit is composed of a flat ribbon cable housing assembly (AXT100-2-PS20) of ① SI unit and ② P kit (20 pins). Place an order for AXT100-2-PS20 separately.

Note 2) Top/vertical entry connector for FU and PU while side (horizontal) entry connector for FS and PS.

Note 3) Since no connector assembly is included, order it separately. (Refer to page 2-4-69.)

Note 4) In the case of standard specifications and double wiring, ④ is for 1 to 4 stations and ⑤ is for 5 to 8 stations.



VQC
SQ
VQ0
VQ4
VQ5
VQZ
VQD

<D Side End Plate Assembly>

⑥ D side end plate assembly no.

VVQ1000-3A-4-□

Option

Nil: Common exhaust

S: Built-in silencer, direct exhaust (Applicable for C kit only)



Note) The ⑩'s fitting assembly is included.

<U Side End Plate Assembly No.>

⑦ U side end plate assembly no.

VVQ1000-2A-4-□

Option

Nil: Common exhaust

S: Built-in silencer, direct exhaust



Note) The ⑩'s fitting assembly is included.

<Replacement Parts>

No.	Part no.	Description	Material	Number
⑧	VVQ1000-80A-3-2	Seal	HNBR	12
⑨	VVQ1000-80A-4	Clip	Stainless steel	12



Note) A set of parts containing 12 pcs. each is enclosed.

<Fittings Assembly>

⑩ Fittings assembly part no.

VVQ1000-50A-□

Port size

C3: Applicable tubing ø3.2

C4: Applicable tubing ø4

C6: Applicable tubing ø6⁽¹⁾



Note 1) Standard SUP/EXH port is C6.

Note 2) Purchasing order is available in units of 10 pieces.

<Station Increase Parts>

No. ⁽³⁾	Part no.	Description	Material	Number ⁽¹⁾
⑪	VVQ1000-105A-4-□ ⁽²⁾	Tie-rod bolt	Carbon steel	2
⑫		Guide rod	Stainless steel	1



Note 1) Each number of replacement parts are included in one set.

Note 2) □: Number of stations (01 to 16)

Note 3) ⑪ and ⑫ are in one set.