

Series VQ1000

Body Ported

Plug Lead Unit: Cassette Type

How to Order Manifold

VV5Q1 7 - 08 F U1 - D

Series VQ1000
Manifold
7 Plug lead unit/Cassette

Stations

01	1 station
⋮	⋮

The number of max. stations differs from kit to kit. (Refer to the table below.)

Simple specials are available with SMC Simple Specials System. For details about applicable models, please contact SMC.

Option

D ⁽¹⁾	DIN rail mounting style
K ⁽²⁾	Special wiring specifications (Except double wiring)
N ⁽³⁾	With name plate

- Note 1) Since the manifold is all with DIN rail, and so suffix -D to the part number.
- Note 2) Specify the wiring specifications on the manifold specification sheet. (Except C kit)
- Note 3) Unmountable when the valve's manual override is a locking lever type.
- Note 4) When two or more symbols are specified, indicate them alphabetically.

Kit/Electrical entry/Cable length

F kit
(D-sub connector)

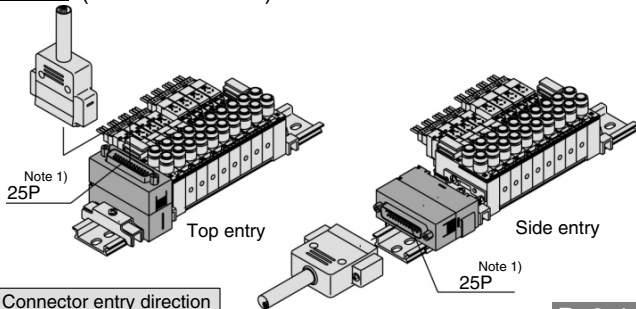

Connector entry direction				Without cable	With cable (1.5 m)	With cable (3 m)	With cable (5 m)	Max. 16 ⁽²⁾ stations
Top entry	Side entry	Kit F	Kit F					
		U0	S0					
Kit F		U1	S1					
		U2	S2					
		U3	S3					

P. 2-4-76

P kit
(Flat ribbon cable connector)

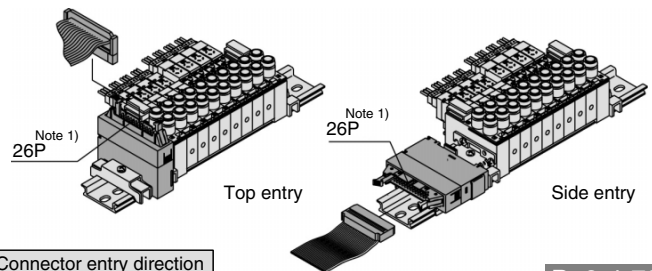

Connector entry direction				Without cable	With cable (1.5 m)	With cable (3 m)	With cable (5 m)	Max. 16 ⁽²⁾ stations
Top entry	Side entry	Kit P	Kit P					
		U0	S0					
Kit P		U1	S1					
		U2	S2					
		U3	S3					

P. 2-4-78

T kit
(Terminal block)

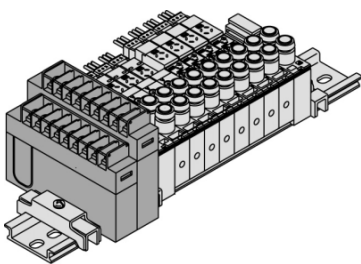

P. 2-4-80

C kit
(Connector)

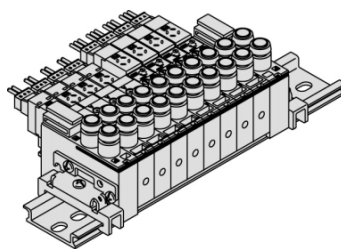

P. 2-4-82

S kit
(Serial transmission unit)

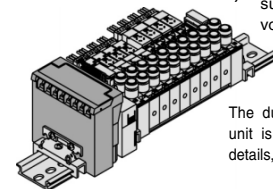

The valve is equipped with an indicator light/surge voltage suppressor and the voltage is 24 VDC.

The dust-protected type SI unit is applicable, too. For details, please contact SMC.

P. 2-4-84

Kit T	1	No. of terminals: 8, 1 row	Applicable stations 1 to 8
	2	No. of terminals: 16, 2 rows	Applicable stations 5 to 16

C	Connector kit	Max. 16
---	---------------	---------

Kit S		
0	Without SI unit	
A	With general type SI unit (Series EX300)	
B	Mitsubishi Electric Corp.: MELSECNET/mini-S3 Data Link System	
C	OMRON Corp.: SYSBUS Wire System	
D	SHARP Corp.: Satellite I/O Link System	
E	Matsushita Electric Works: MEWNET-F System	
F1	NKE Corp.: Uni-wire System (16 output points)	Max. 16 stations ⁽²⁾
G	Rockwell Automation: Allen Bradley Remote I/O (RIO) System	
H	NKE Corp.: Uni-wire H System	
J1	SUNX Corp.: S-LINK System (16 output points)	
J2	SUNX Corp.: S-LINK System (8 output points)	Max. 8
K	Fuji Electric Co.: T-LINK Mini System	
Q	DeviceNet, CompoBus/D (OMRON Corp.)	Max. 16 stations
R1	OMRON Corp.: CompoBus/S System (16 output points)	
R2	OMRON Corp.: CompoBus/S System (8 output points)	Max. 8
V	Mitsubishi Electric Corp.: CC-LINK System	Max. 16

Note 1) Besides the above, F and P kits with different number of pins are available. For details, refer to page 2-4-92.
Note 2) See page 2-4-93 for details.

How to Order Valves

VQ 1 1 7 0 Y 5 M C6

Series VQ1000

Type of actuation

- 1: 2 position single (A/B) (R1)(P/R2)
- 2: 2 position double (Latching) (A/B) Metal seal (R1)(P/R2)
- 2: 2 position double (Latching) (A/B) Rubber seal (R1)(P/R2)
- 3: 3 position closed center (A/B) (R1)(P/R2)
- 4: 3 position exhaust center (A/B) (R1)(P/R2)
- 5: 3 position pressure center (A/B) (R1)(P/R2)

Coil voltage

1	100 VAC (50/60 Hz)
2 ^{Note}	200 VAC (50/60 Hz)
3	110 VAC (50/60 Hz)
4 ^{Note}	220 VAC (50/60 Hz)
5	24 VDC
6	12 VDC

Note) 200/220 VAC models are applicable to the C kit.

Function

Symbol	Specifications	DC	AC
Nil	Standard type	(1.0 W) ○	○ ⁽¹⁾
H ⁽²⁾	High pressure type	(1.5 W) ○	—
Y ⁽²⁾	Low wattage type	(0.5 W) ○	—

Note1) For power consumption of AC type, refer to page 2-4-74.
Note2) Except double (latching).

Seal

0	Metal seal
1	Rubber seal

Note 1) For negative common specifications, refer to "Option" on page 2-4-93.
Note 2) Connector assembly will be required when the F, P, T, S kits add a valve. For model no., refer to "Option" on page 2-4-93.

Manual override

- Nil: Non-locking push type (Tool required)
- B: Locking type (Tool required)
- C: Locking type (Manual)

Electrical entry

G: Grommet (C kit only. Except double (latching) and AC.	L: L plug connector With lead wire	LO: L plug connector Without lead wire	M: M plug connector With lead wire	MO: M plug connector Without lead wire
	With light/surge voltage suppressor	With light/surge voltage suppressor	With light/surge voltage suppressor	With light/surge voltage suppressor

Note) LO and MO valves are used for F, P, T, and S kits. Plug connector and Lead wire layers are attached to the manifold.

Cylinder port

C3	With One-touch fitting for ø3.2
C4	With One-touch fitting for ø4
C6	With One-touch fitting for ø6
M5	M5 thread

Note 1) The code is L for elbow piping for all manifold stations. Example) L6: Elbow with One-touch fittings for ø6
Note 2) For inch-size One-touch fittings, refer to "Option" on page 2-4-93.

L type plug connector is used for 3 position AC.

- VQC
- SQ
- VQ0
- VQ4
- VQ5
- VQZ
- VQD

Manifold Option

P. 2-4-87

<p>Individual SUP spacer VVQ1000-P-7-C6</p> <p>C6 (SUP) port One-touch fitting for ø6 Block bushing assembly (2 pcs. attached) D side U side</p>	<p>SUP/EXH block bush assembly VVQ1000-87A-B-50</p> <p>D side U side VVQ1000-87A-B-50</p>	<p>Double Check block VQ1000-FPG-□□</p> <p>To CYL port</p>	<p>Blanking plug KQ2P-²⁵/₀₄/₀₆</p>
<p>Individual EXH spacer VVQ1000-R-7-C6</p> <p>C6 (EXH) port One-touch fitting for ø6 Block bushing assembly (4 pcs. attached) D side U side</p>	<p>Elbow fitting assembly VVQ1000-F7-L^{C3}/_{C6}</p>	<p>Silencer AN103-X233</p>	<p>How to Order Manifold Assembly</p> <p>Example</p> <p>Single solenoid (24 VDC) VQ1170-5MO-C6 (4 sets) Double (latching) solenoid (24 VDC) VQ2170-5MOD-C6 (4 sets)</p> <p>3 m D side U side D-sub connector cable F kit (D-sub connector) Manifold base (8 stations) VV5Q17-08FU2-D</p> <p>Cylinder port C6: With One-touch fitting for ø6</p> <p>VV5Q17-08FU2-D 1 set (F kit 8 station manifold base no.) *VQ1170-5MO-C6 4 sets (Single solenoid part no.) *VQ1270-5MOB-C6 ... 4 sets (Double latching solenoid part no.)</p> <p>The asterisk denotes the symbol for assembly. Prefix it to the part nos. of the solenoid valve, etc.</p> <p>Add the valve and option part number under the manifold base part number. In the case of complex arrangement, specify them on the manifold specification sheet.</p>
<p>Individual SUP/EXH spacer VVQ1000-PR-7-C6</p> <p>C6 (EXH) port One-touch fitting for ø6 C6 (SUP) port One-touch fitting for ø6 Block bushing assembly (6 pcs. attached) D side U side</p>	<p>Name plate [-N7] VVQ1000-N7-station (1 to Max. stations)</p>	<p>Port plug VVQ000-58A</p>	

• See page 2-4-91 for cylinder port fittings.
• For replacement parts, refer to page 2-4-111.

Plug Lead Unit: Cassette Type Series VQ1000

Manifold Specifications

Series	Base model	Type of connection	Porting specifications		Applicable stations ⁽²⁾	Applicable solenoid valve	5 station weight (g)	
			Port location	Port size ⁽¹⁾				
				1(P), 3(R)				4(A), 2(B)
VQ1000	VV5Q17-□□□-D	<ul style="list-style-type: none"> ■ F kit—D-sub connector ■ P kit—Flat ribbon cable connector ■ T kit—Terminal block ■ C kit—Individual connector ■ S kit—Serial transmission unit 	Top	C6 (ø6)	C3 (ø3.2) C4 (ø4) C6 (ø6) M5 (M5 thread)	1 to 16 stations	VQ1□70 VQ1□71	405



Note 1) Inch-size One-touch fittings are also available. For details, refer to page 2-4-93.
 Note 2) For details, refer to page 2-4-93.

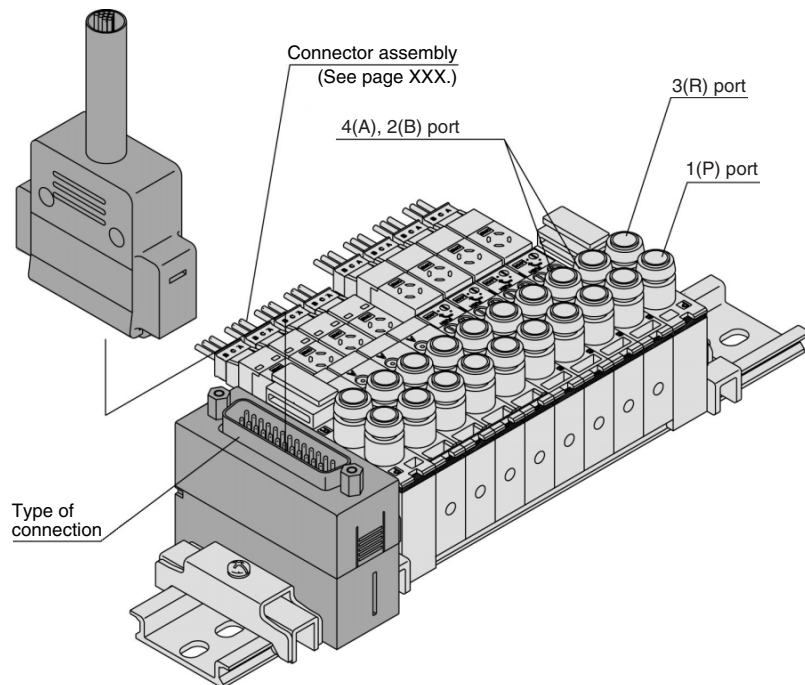

- VQC
- SQ
- VQ0**
- VQ4
- VQ5
- VQZ
- VQD

P VQ1000 Kit (Flat ribbon cable connector)

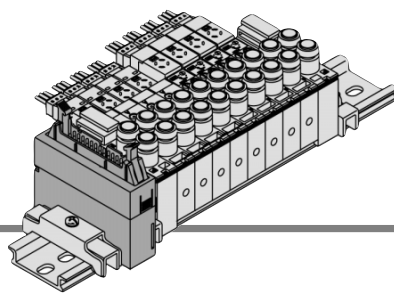

- MIL flat ribbon cable connector reduces installation labor savings for electrical connection.
- Using the connector for flat ribbon cable (26P), (10P, 16P, 20P as an option) conforming to MIL standard permits the use of connectors put on the market and gives a wide interchangeability.
- Top or side receptacle position can be selected in accordance with the available mounting space.
- Maximum stations are 16.

Manifold Specifications

Series	Porting specifications			Applicable stations
	Port location	Port size		
VQ1000	Top	1(P), 3(R)	4(A), 2(B)	Max. 16 stations

Flat Ribbon Cable (26 pins)

Cable assembly

AXT100-FC26-¹/₃
 (Flat ribbon cable connector assembly can be ordered individually or included in a specific manifold model no. Refer to How to Order Manifold.)

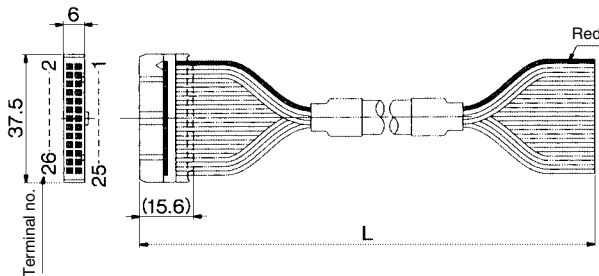

Flat Ribbon Cable Connector Assembly (Option)

Cable length (L)	Assembly part no.	Note
1.5 m	AXT100-FC26-1	Cable 26 core x 28AWG
3 m	AXT100-FC26-2	
5 m	AXT100-FC26-3	

* For other commercial connectors, use a 26 pins type with strain relief conforming to MIL-C-83503.

Connector manufacturers' example

- Sumitomo 3M Limited
- Fujitsu Limited
- Oki Electric Cable Co., Ltd.
- Japan Aviation Electronics Industry, Ltd.
- J.S.T. Mfg. Co., Ltd.

Note) Types with 10, 16, or 20 pin are also available. For details, refer to page 2-4-92.

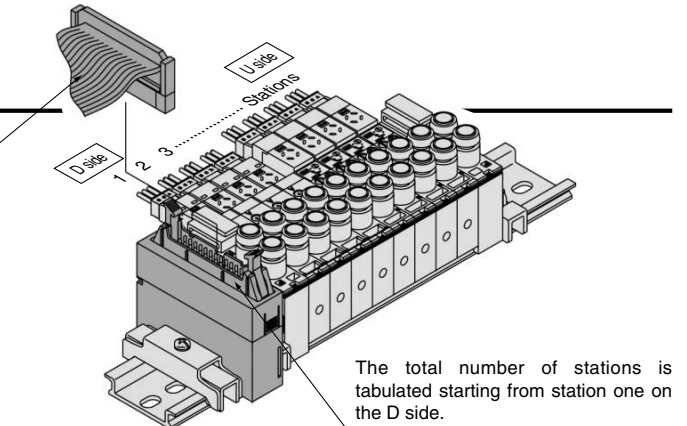

Electrical wiring specifications

Flat ribbon cable connector

Terminal no.	Polarity
26c c25	SOL.A 1 (-)
24c c23	SOL.B 2 (+)
22c c21	SOL.A 3 (-)
20c c19	SOL.B 4 (+)
18c c17	SOL.A 5 (-)
16c c15	SOL.B 6 (+)
14c c13	SOL.A 7 (-)
12c c11	SOL.B 8 (+)
10c c9	SOL.A 9 (-)
8c c7	SOL.B 10 (+)
6c c5	SOL.A 11 (-)
4c c3	SOL.B 12 (+)
2c c1	SOL.A 13 (-)
	SOL.B 14 (+)
	SOL.A 15 (-)
	SOL.B 16 (+)
	COM. 25 (-)
	COM. 26 (+)

Note) Positive common specifications Negative common specifications

Note) As the standard electrical wiring specifications, double wiring (connected to SOL. A and SOL. B) is adopted for the internal wiring of each station for 8 stations or less, regardless of valve and option types. Mixed single and double wiring is available as an option. For details, refer to page 2-4-93.

Note) When using the negative common specifications, use valves for negative common. (Refer to page 2-4-93.)

How to Order Manifold

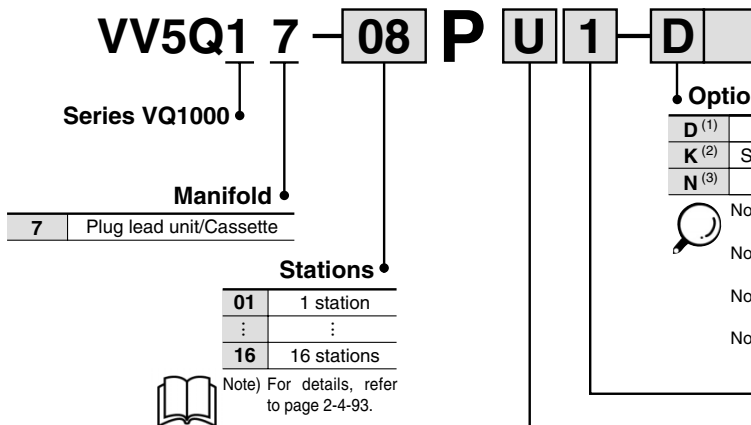

Plug Lead Unit: Cassette Type Series VQ1000

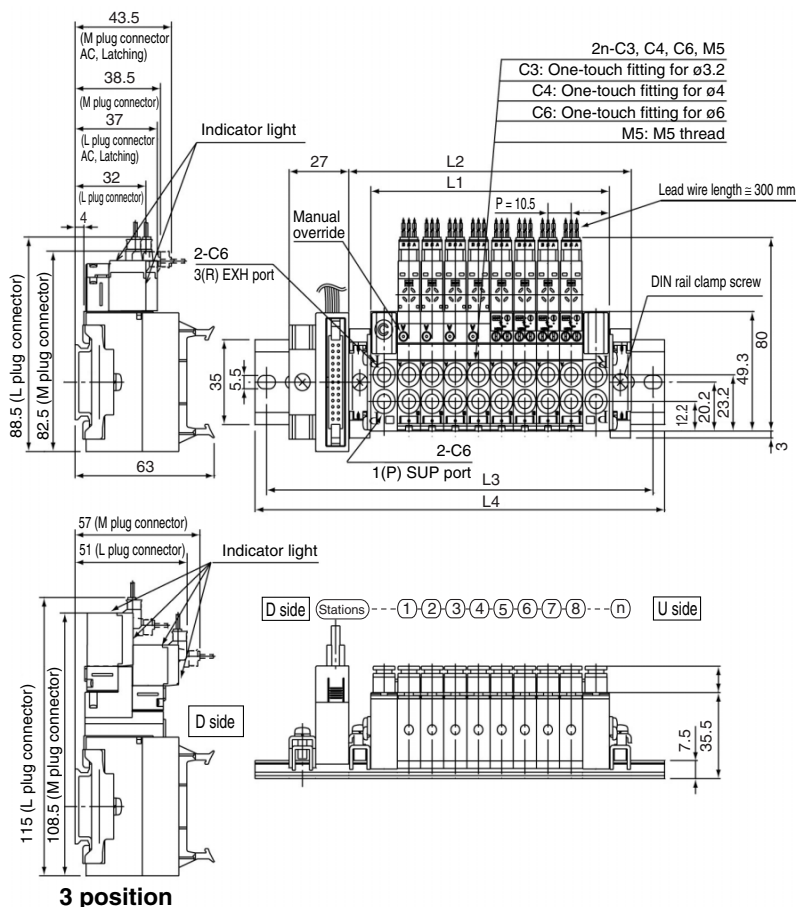
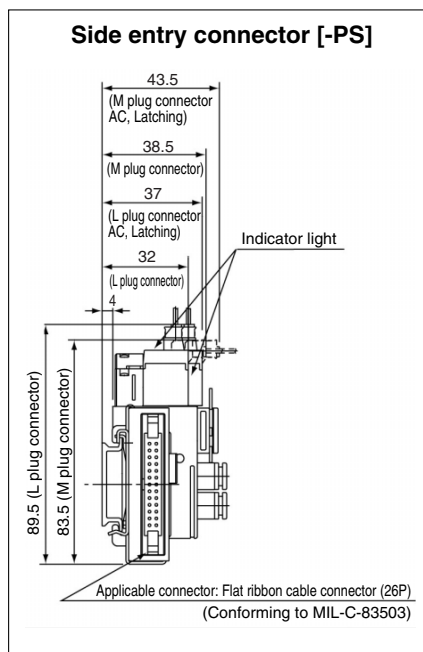

- VQC
- SQ
- VQ0
- VQ4
- VQ5
- VQZ
- VQD

Dimensions: Top Entry Connector [-PU]

L1 = 10.5n + 24, L2 = 10.5n + 44 n: Station (Maximum 16 stations)

n	1	2	3	4	5	6	7	8	9	10	11	12	13	14	15	16
L1	34.5	45	55.5	66	76.5	87	97.5	108	118.5	129	139.5	150	160.5	171	181.5	192
L2	54.5	65	75.5	86	96.5	107	117.5	128	138.5	149	159.5	170	180.5	191	201.5	212
L3	112.5	112.5	125	137.5	150	162.5	175	175	187.5	200	212.5	225	237.5	237.5	250	262.5
L4	123	123	135.5	148	160.5	173	185.5	185.5	198	210.5	223	235.5	248	248	260.5	273

Dimensions: Side Entry Connector [-PS]

n	1	2	3	4	5	6	7	8	9	10	11	12	13	14	15	16
L3	137.5	137.5	150	162.5	175	187.5	200	200	212.5	225	237.5	250	262.5	262.5	275	287.5
L4	148	148	160.5	173	185.5	198	210.5	210.5	223	235.5	248	260.5	273	273	285.5	298

How to Order Valves

VQ1 1 7 0 Y 5 MO C6

Series VQ1000

Type of actuation

1	2 position single
2	2 position double (Latching)
3 ^{Note 1}	3 position closed center
4 ^{Note 1}	3 position exhaust center
5 ^{Note 1}	3 position pressure center

Seal

0	Metal seal
1	Rubber seal

Coil voltage

1	100 VAC (50/60 Hz)
3	110 VAC (50/60 Hz)
5	24 VDC
6	12 VDC

Function

Symbol	Specifications	DC	AC
Nil	Standard type	(1.0 W)	○ ⁽¹⁾
H ⁽²⁾	High pressure type	(1.5 W)	—
Y ⁽²⁾	Low wattage type	(0.5 W)	—

Cylinder port

C3	With One-touch fitting for ø3.2
C4	With One-touch fitting for ø4
C6	With One-touch fitting for ø6
M5	M5 thread

Manual override

Nil	Non-locking push type (Tool required)
B	Locking type (Tool required)
C	Locking type (Manual)

Electrical entry

LO	L plug connector without connector
MO	M plug connector without connector

Notes:

- Note 1) The code is L for elbow piping for all manifold stations. Example) L6: Elbow with One-touch fittings for ø6
- Note 2) For inch-size One-touch fittings, refer to "Option" on page 2-4-93.
- Note 1) For power consumption of AC type, refer to page 2-4-74.
- Note 2) Except double (latching).
- Note 1) For negative common specifications, refer to "Option" on page 2-4-93.
- Note 2) Connector assembly will be required when the P kits add a valve. For model no., refer to "Option" on page 2-4-93.

How to Order Manifold Assembly

Specify the part numbers for valves and options together beneath the manifold base part number.

<Example>
 Connector kit
 VV5Q17-08PU2-D ... 1 set -Manifold base part no.
 *VQ1170-5MO-C6 ... 4 sets -Valve part no. (Stations 1 to 4)
 *VQ1270-5MOB-C6 ... 4 sets -Valve part no. (Stations 5 to 8)

Prefix the asterisk to the part nos. of the solenoid valve, etc.

Enter in order starting from the first station on the D side. Besides, when the arrangement will be complicated, fill out the Manifold Specification Sheet to instruct us.

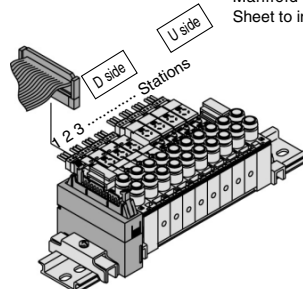

Plug Lead Unit: Cassette Type Series VQ1000

Manifold Option Parts

Individual SUP spacer VVQ1000-P-7-C6

When the same manifold is to be used for different pressures, individual SUP spacers are used as SUP ports for different pressures. (One station space is occupied.) Block both sides of the station, for which the supply pressure from the individual SUP spacer is used, with SUP block plates. (See the application ex.)

* Specify the spacer mounting position and SUP block plate mounting position on the manifold specification sheet. The block plate are used in two places for one set. (Two SUP block plates for blocking SUP station are attached to the individual SUP spacer.)

* The spacer's specification can be changed (from an individual SUP spacer to an individual EXH spacer) by changing the coupling of the fittings and bushing.

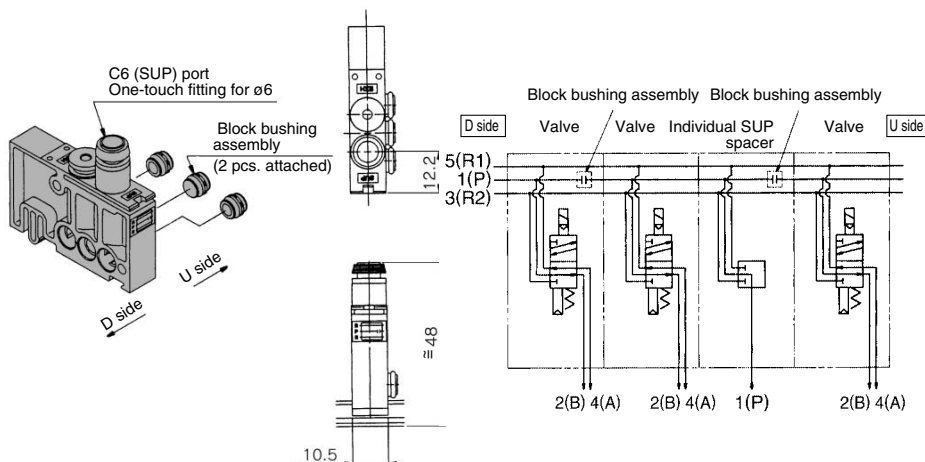

VQC

SQ

VQ0

VQ4

VQ5

VQZ

VQD

Individual EXH spacer VVQ1000-R-7-C6

When valve exhaust affects other stations due to the circuit configuration, this spacer is used for individual valve exhaust. (One station space is occupied.)

Block both sides of the individual valve EXH station.

* Specify the spacer mounting position and EXH block plate mounting position on the manifold specification sheet. The block plate are used in two places for one set. (Four EXH block plates for blocking EXH station are attached to the individual EXH spacer.)

* The spacer's specification can be changed (from an individual EXH spacer to an individual SUP spacer) by changing the coupling of the fittings and bushing.

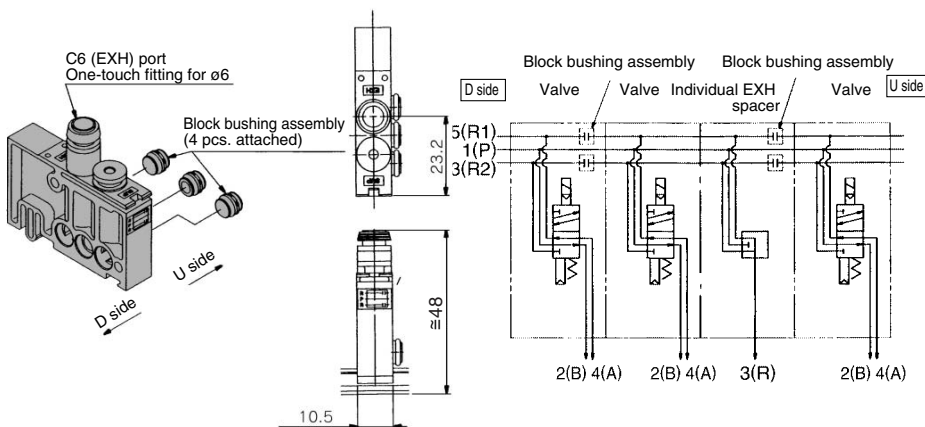

Individual SUP/EXH spacer VVQ1000-PR-7-C6

This spacer has both functions of the above individual SUP and EXH spacers. (Refer to the application example.)

* Specify the spacer mounting position and SUP/EXH block plate mounting position on the manifold specification sheet. The block plates are used in two places for one set.

(A SUP/EXH block plates for blocking SUP/EXH station are attached to the individual SUP/EXH spacer.)

* When using the spacer not for individual SUP/EXH but for improving the ability to supply/exhaust air, it is unnecessary to block the SUP/EXH passage. In this case, place an order via VVQ1000-PRA-7-C6.

* The spacer's specification can be changed by changing the coupling of the fittings and bushing.

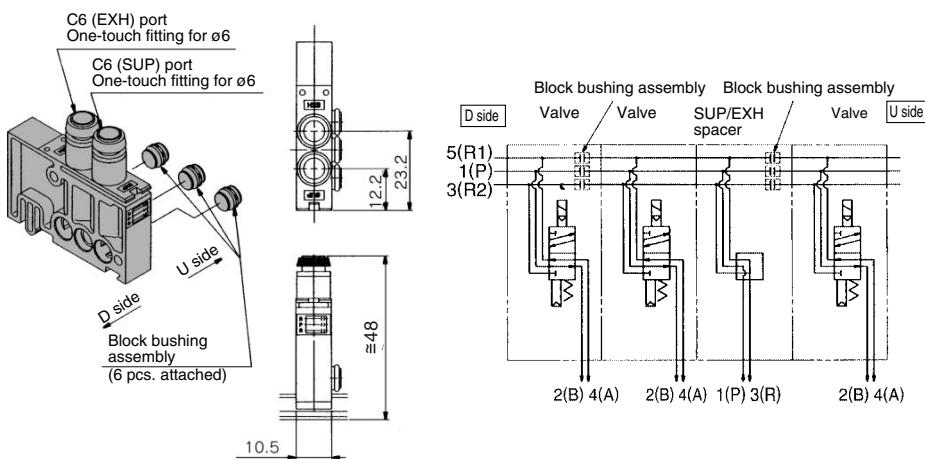

Series VQ1000

Manifold Option Parts

SUP/EXH Block bushing assembly VVQ1000-87A-B-50

<For SUP>

When one manifold is to be used for different, high and low pressures, this block bushing assembly is used between the stations under a different pressure. The block assembly is mounted on the U side of the valve's SUP passage.

* Specify the number stations on the manifold specification sheet.

<For EXH>

When a valve exhaust affects other stations due to the circuit configuration, this block bushing assembly is used between the stations whose EXH passages are to be separated each other. Since the block bushing assembly is mounted on the U side of the valve's R1 and R2 passages, two assemblies are necessary for one station.

* Specify the number stations on the manifold specification sheet.

<Shut off label>

When using block bushing assembly for SUP, EXH passage, indication label for confirmation of the blocking position from outside is attached. (One label for each)

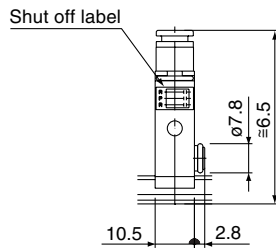
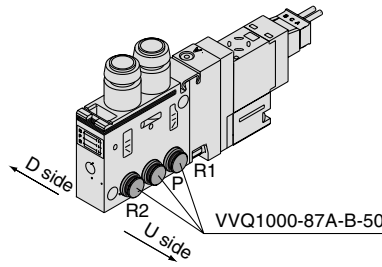

SUP passage blocked



EXH passage blocked



SUP/EXH passage blocked

* Can be included in manifold model no.

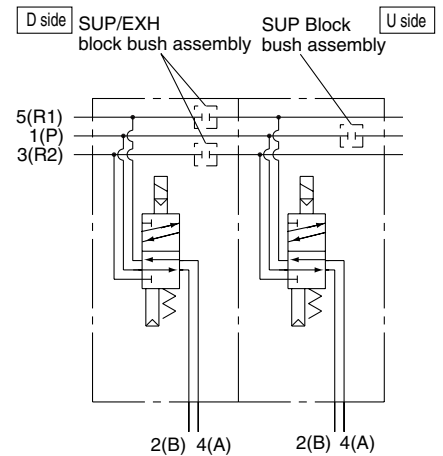

<Example>

* When ordering a block bush incorporated with the manifold, a block indication label is attached to the manifold.

Elbow fitting assembly VVQ1000-F7-L (C3, C4, C6)

It is used in a side-valve-port application.

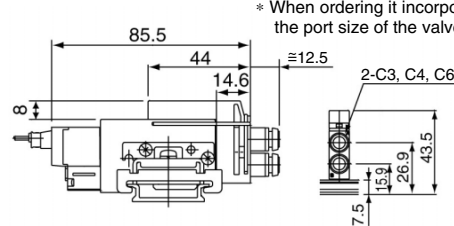
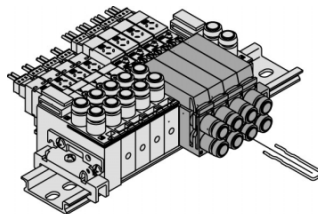

* When ordering it incorporated with a valve, the port size of the valve no. is LC.

Name plate [-N7] VVQ1000-N7-Station (1 to Max. stations)

It is a transparent resin plate for placing a label that indicates solenoid valve function, etc. Insert it into the groove on the side of the end plate and bend it as shown in the figure. Open the face plate seating when the manual override is operating.

* It is not applicable to locking manual override.

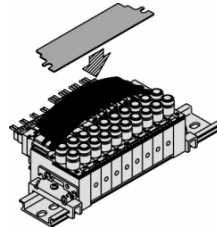

* When ordering assemblies incorporated with a manifold, suffix -N to the manifold no.

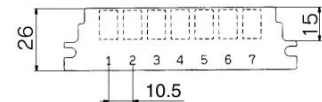

Blanking plug

KQ2P-²³₀₄₀₆

Used for unused cylinder port, SUP and EXH port. Purchasing order is available in units of 10 pieces.

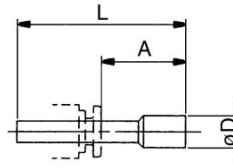
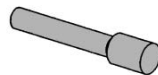

Dimensions

Applicable fittings size ̸d	Model	A	L	D
3.2	KQ2P-23	16	31.5	5
4	KQ2P-04	16	32	6
6	KQ2P-06	18	35	8

Silencer AN103-X233

This silencer is to be inserted into the EXH port (One-touch fittings) of the common exhaust type.

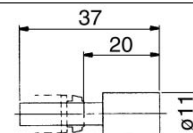
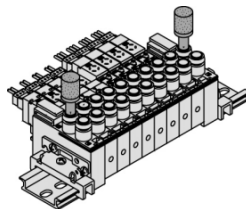

Dimensions

Series	Applicable fittings size ̸d	Model	A	L	D	Effective area (mm ²)	Noise reduction (dB)
VQ1000	6	AN103-X233	20	37	11	7	25

Port plug VVQ0000-58A

The plug is used to block the cylinder port when using a 4 port valve as a 3 port valve. When ordering it incorporated with a manifold, suffix A or B, the symbol of the plug port, to the valve no.

Example) VQ1170-5L-C6-A

└─ A port, Plug

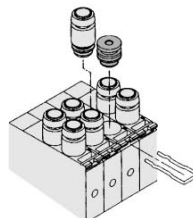

⚠ Precautions

Be sure to read before handling. For Safety Instructions and Solenoid Valve Precautions, refer to page 2-9-2.

Light/Surge Voltage Suppressor

⚠ Caution

The standard model is equipped with an indicator light and surge voltage suppressor. The lighting positions are concentrated on one side for both single solenoid type and double (latching) type. In the double (latching) type, A side and B side energization are indicated by two colors which match the colors of the manual overrides.

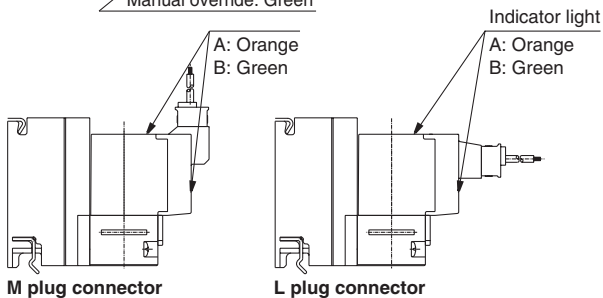
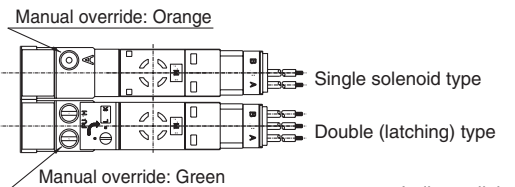

DC circuit diagram

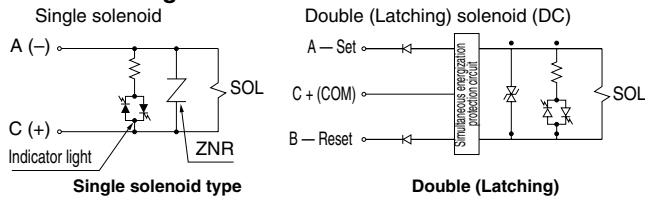

- Single solenoid type**
- Note 1) • A-side energization: A light (orange) illuminates.
 - B-side energization: B light (green) illuminates.
 - Equipped with a wiring error prevention (stop diode) mechanism.
 - Surge absorption (ZNR/surge absorption diode) mechanism.
- Note 2) Applicable to negative COM specification models.
- Double (Latching)**
- Note 3) In the case of double (latching), the electromagnetic valve channel is, A-(set): P → A, B → R
 - B-(reset): P → B, A → R

Double (Latching solenoid) Type

⚠ Caution

Different from the conventional double solenoid, the double type uses a latching (self-holding system) solenoid. Although the appearance is the same as the single solenoid, it is constructed so that the movable iron core in the solenoid is held in the ON position on A and B sides by instantaneous energization (20 ms or more). The usage and function is the same as the double solenoid type.

<Special Cautions for Latching Solenoid>

1. Select the circuit in which ON and OFF signals are not energized simultaneously.
2. 20 ms energization time is necessary for self-holding.
3. Avoid using the latching solenoid valves in environments where impact or collisions with the valve might occur.
Also, do not use in places where strong magnetic fields are present.
4. Even though the armature in the solenoid of this valve is held on to B side, ON position (Reset), verify either A side, ON position or B side, ON position by energizing prior to use.
After manual operation, the main valve will return to its original position.
5. Manual override on the pilot valve side can retain its switching position after manipulation.
6. Please contact SMC for long-term energization applications.
7. In the case of metal seal type, if the supply air goes down below the minimum operating pressure (0.1 MPa or less), the main valve will be back to the home position (B side ON position). Therefore, when the supply air is shut off or applied while leaving A side ON position, cylinder may be pulsated. The valve's switching position when the supply air is operated should be installed on the home position side (B side ON position).

Manual Override

⚠ Warning

Without an electric signal for the solenoid valve the manual override is used for switching the main valve.

■ Push type (Tool required)

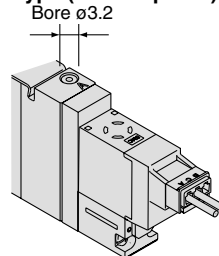

Push down on the manual override button with a small screwdriver until it stops. Release the screwdriver and the manual override will return.

■ Locking slotted type

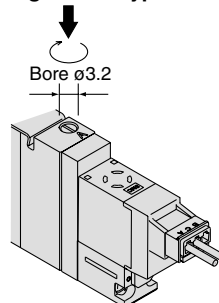

Push down on the manual override button with a small screwdriver until it stops. While down, turn clockwise by 90° to lock it. Turn it counterclockwise to release it.

■ Locking lever type (Option)

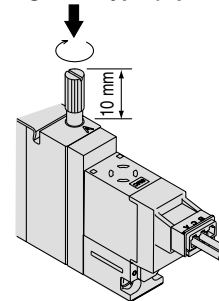

Push down completely on the manual override button with a small screwdriver. While down, turn clockwise 90° to lock it. Turn it counterclockwise to release it.

■ Manual override for double (latching) type

In case of a double (latching) type, a manual override is provided not only on the body side but to the pilot as a standard specification.

After manual operation, the main valve of the manual override on the body side returns to the position before the manual operation, however, the pilot valve manual override maintains the change-over position.

Turn before pushing.

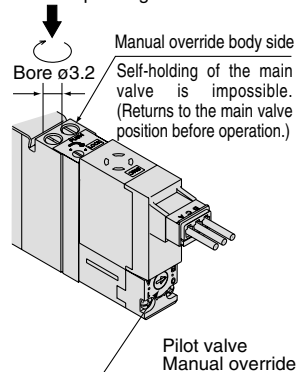

- If the manual override is turned by 180° clockwise and the ► mark is adjusted to A, then pushed in the direction of an arrow (➡), it will be back to the reset condition. (passage P → A)
- If the manual override is turned by 180° counterclockwise and the ► mark is adjusted to B, then pushed in the direction of an arrow (➡), it will be back to the reset condition. (passage P → B) (It is in the reset state at the time of shipment.)

⚠ Caution

Do not apply excessive torque when turning the locking type manual override. (0.1 N·m or less)

How to Mount/Remove Solenoid Valve

⚠ Caution

<Procedure>

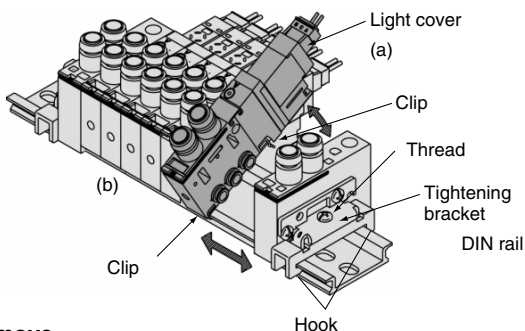

How to Remove

1. Loosen the clamp screw on one side.
2. Slightly slide a part the valve stations on both sides of the station to be removed.
3. Pull up side (a) of the valve station and remove it from the DIN rail.

How to mount

1. Take procedures 1 and 2 above to make an open space in the position for mounting a new valve station.
2. Diagonally insert the clip on the side (b) of the valve station to the DIN rail.
3. Press down on the valve station and insert the clip on the side (a) of the valve station to the DIN rail.
4. Slide the valve stations together so that there is no clearance between them. Position the clamp screw and tighten. (Proper tightening torque: 0.7 to 1.0 N·m)

Note) Be careful to keep O-ring or gallery dust free since dirt may cause air leakage.

Be sure both hooks of the bracket are fixed to the DIN rail.

Use caution not to apply force on the light cover when mounting or dismounting the valve.

Replacement of Cylinder Port Fittings

⚠ Caution

The cylinder port fittings are a cassette for easy replacement. The fittings are blocked by a clip inserted from the side of the valve. Remove the clip with a screwdriver and remove fittings. For replacement, insert the fitting assembly until it strikes against the inside wall and then reinsert the clip to the specified position.

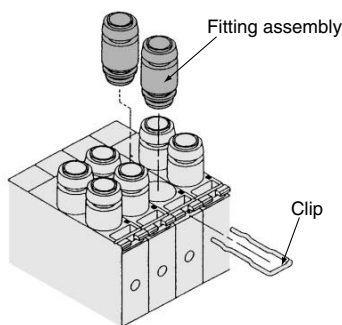

Applicable tubing O.D	Fitting assembly part no.
Applicable tubing ø3.2	VVQ1000-50A-C3
Applicable tubing ø4	VVQ1000-50A-C4
Applicable tubing ø6	VVQ1000-50A-C6

* Purchasing order is available in units of 10 pieces.

⚠ Caution

1. Protect O-rings from scratches and dust to prevent air leakage.
2. The tightening torque for inserting fittings to the M5 thread ass'y should be 0.8 to 1.4 N·m.

How to Use Plug Connector

⚠ Caution

For details, refer to page 2-4-67.

How to Calculate the Flow Rate

⚠ Caution

For obtaining the flow rate, refer to pages 2-1-8 to 2-1-11.

VQC

SQ

VQ0

VQ4

VQ5

VQZ

VQD

Option

Different Number of Connector Pins

F and P kits with the following number of pins are available besides the standard number (F = 25; P = 26). Select the desired number of pins and cable length from the cable assembly list. Place an order for the cable assembly separately.

F kit (D-sub connector) 15 pins

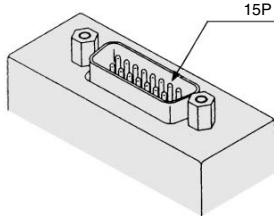

How to order manifold

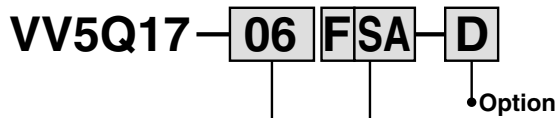

Stations

How to Order
D-sub connector, 15 pins
Connector location-Side (horizontal)
Without cable

Kit/Electrical entry

Pins	Location	Top entry		Side entry	
15 pins (Max. 14 stations)		Kit F	UA	Kit F	SA

Wiring Specifications

Like 25-pin models (standard), terminal no. 1 will be the 1st station SOL.A, and terminal no. 9 for the 1st station SOL.B. Then COM will be the terminal no. 8.

Multi-core vinyl cable VVRF 0.3 mm² x 15C

Plug connector HDA-CTH (Made by Hirose Electric)

Connector HDA-15S (Made by Hirose Electric)

2-M2.6 x 0.45

Terminal no.

Wire Color by Terminal No. of D-sub Connector Cable Assembly

Terminal no.	Lead wire color	Dot marking
1	Black	None
2	Brown	None
3	Red	None
4	Orange	None
5	Yellow	None
6	Pink	None
7	Blue	None
8	Purple	White
9	Gray	Black
10	White	Black
11	White	Red
12	Yellow	Red
13	Orange	Red
14	Yellow	Black
15	Pink	Black

D-sub Connector Cable Assembly

Cable length (L)	Pins	15P
1.5 m		AXT100-DS15-1
3 m		AXT100-DS15-2
5 m		AXT100-DS15-3

* For other commercial connectors, use a type conforming to MIL-C-24308.

P kit (Flat ribbon cable connector) 10 pins, 16 pins, 20 pins

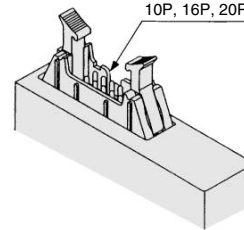

How to order manifold

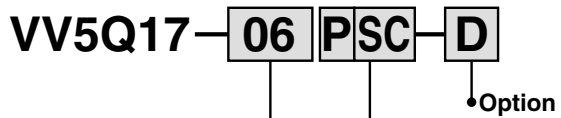

Stations

How to Order
Flat ribbon cable, 20 pins
Connector location-Side (Horizontal)
Without cable

Kit/Electrical entry

Pins	Location	Top entry		Side entry	
10 pins (Max. 8 stations)		Kit P	UA	Kit P	SA
16 pins (Max. 14 stations)			UB		SB
20 pins (Max. 16 stations)			UC		SC

Wiring Specifications

Similarly to 26-pin models (standard), the terminal no. 1 will be allocated to SOL.A of the 1st. station, and terminal no. 2 for SOL.B of the 1st. station. COM occupies 2 pins from the maximum no. of terminal.

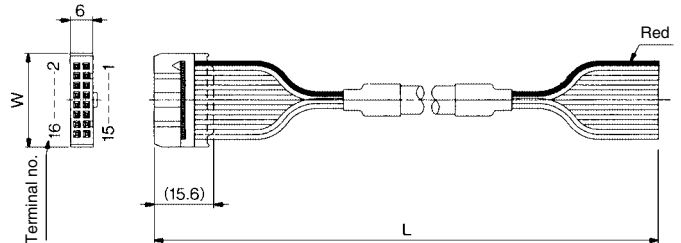

Flat Ribbon Cable Assembly

Cable length (L)	Pins	10P	16P	20P
1.5 m		AXT100-FC10-1	AXT100-FC16-1	AXT100-FC20-1
3 m		AXT100-FC10-2	AXT100-FC16-2	AXT100-FC20-2
5 m		AXT100-FC10-3	AXT100-FC16-3	AXT100-FC20-3
Connector width (W)		17.2	24.8	30

* For other commercial connectors, use a type with strain relief conforming to MIL-C-83503.

Special Wiring Specifications

In the internal wiring of F kit, P kit, J kit, G kit, T kit and S kit, double wiring (connected to SOL. A and SOL. B) is adopted for each station regardless of the valve and option types. Mixed single and double wiring is available as an option.

1. How to order valves

Indicate an option symbol, -K, for the manifold no. and be sure to specify the mounting position and number of stations of the single and double wiring by means of the manifold specification sheet.

Example)

VV5Q17-09FU0-D K S

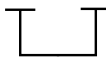

Others, option symbols: to be indicated alphabetically.

2. Wiring specifications

Connector terminal numbers are connected from solenoid station 1 on the A side in the order indicated by the arrows without shipping any terminal numbers.

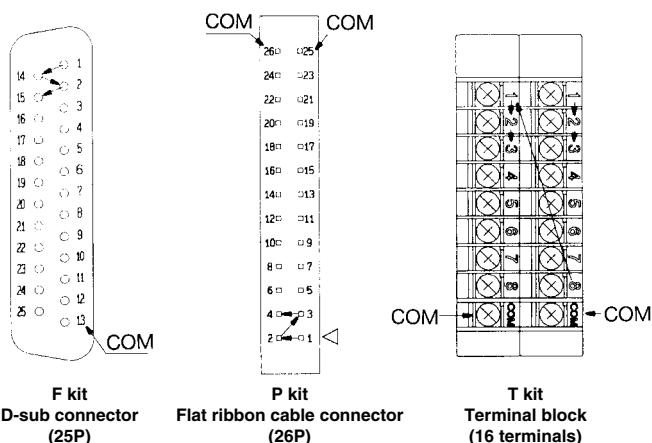

3. Max. number of stations

The maximum number of stations depends upon the number of solenoids. Assuming one for a single and two for a double, determine the number of stations so that the total number is not more than the maximum number given in the following table.

kit	F kit (D-sub connector)		P kit (Flat ribbon cable connector)				T kit (Terminal block)		S kit (Serial)
Type	F _S □ 25P	F _S A 15P	P _S □ 26P	P _S C 20P	P _S B 16P	P _S A 10P	T1	T2	S□
Max. points	Note) 16	14	Note) 16	Note) 16	14	8	8	16	16

Note) Due to the limitation of internal wiring.

Negative Common Specifications

Specify the valve model no. as shown below for negative COM specification. The standard manifold no. can be used. Please contact SMC for negative COM S kit.

How to order negative COM valves

VQ1170 N-5MO-C6



• Negative common specifications

Inch-size One-touch Fittings

Refer to following model no. for inch-size One-touch fittings.

How to order manifold
VV5Q17-08FSO-DN-00T

1(P), 3(R) port size ø1/4"

How to order valves

VQ1170-5M-N7

• Cylinder port

Symbol	N1	N3	N7
Applicable tube O.D. (Inch)	ø1/8"	ø5/32"	ø1/4"

Plug Connector Assembly Model

Connector assembly will be required when the F, P, T, S kits add a valve.

Specify the valve and connector assembly.

Connector Assembly Part No.

Specifications		Part no.
Single (2-wire)	Positive common	AXT661-14A-F
	Negative common	AXT661-14AN-F
Double (latching) (3-wire)	Positive common	AXT661-13A-F
	Negative common	AXT661-13AN-F

Note) Lead wire length: 300 mm

DIN Rail Mounting

Each manifold can be mounted on a DIN rail. Order it by indicating an option symbol for DIN rail mounting style, -D. In this case, a DIN rail which is approx. 30 mm longer than the manifold with the specified number of stations is attached. Besides, it is also available in the following cases.

• When using DIN rail longer than the manifold with specified number of stations

Clearly indicate the necessary number of stations next to the option symbol, -D, for the manifold no.

Example)

VV5Q17-08FU1-D09S

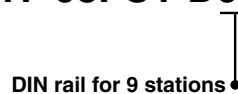

Others, option symbols: to be indicated alphabetically.

• When ordering DIN rail only

DIN rail no.: AXT100-DR-n

* Refer to the DIN rail dimension table for determining the length.

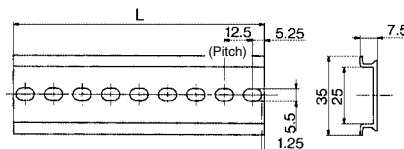

L Dimension

L = 12.5 x n + 10.5

No.	1	2	3	4	5	6	7	8	9	10
L dimension	23	35.5	48	60.5	73	85.5	98	110.5	123	135.5
No.	11	12	13	14	15	16	17	18	19	20
L dimension	148	160.5	173	185.5	198	210.5	223	235.5	248	260.5
No.	21	22	23	24	25	26	27	28	29	30
L dimension	273	285.5	298	310.5	323	335.5	348	360.5	373	385.5
No.	31	32	33	34	35	36	37	38	39	40
L dimension	398	410.5	423	435.5	448	460.5	473	485.5	498	510.5

Series VQ

VQ1000 (VV5Q17)/Plug Lead Unit, Cassette Type

(F, P, T, S kit)

* For how to increase the stations, refer to the instruction manual.

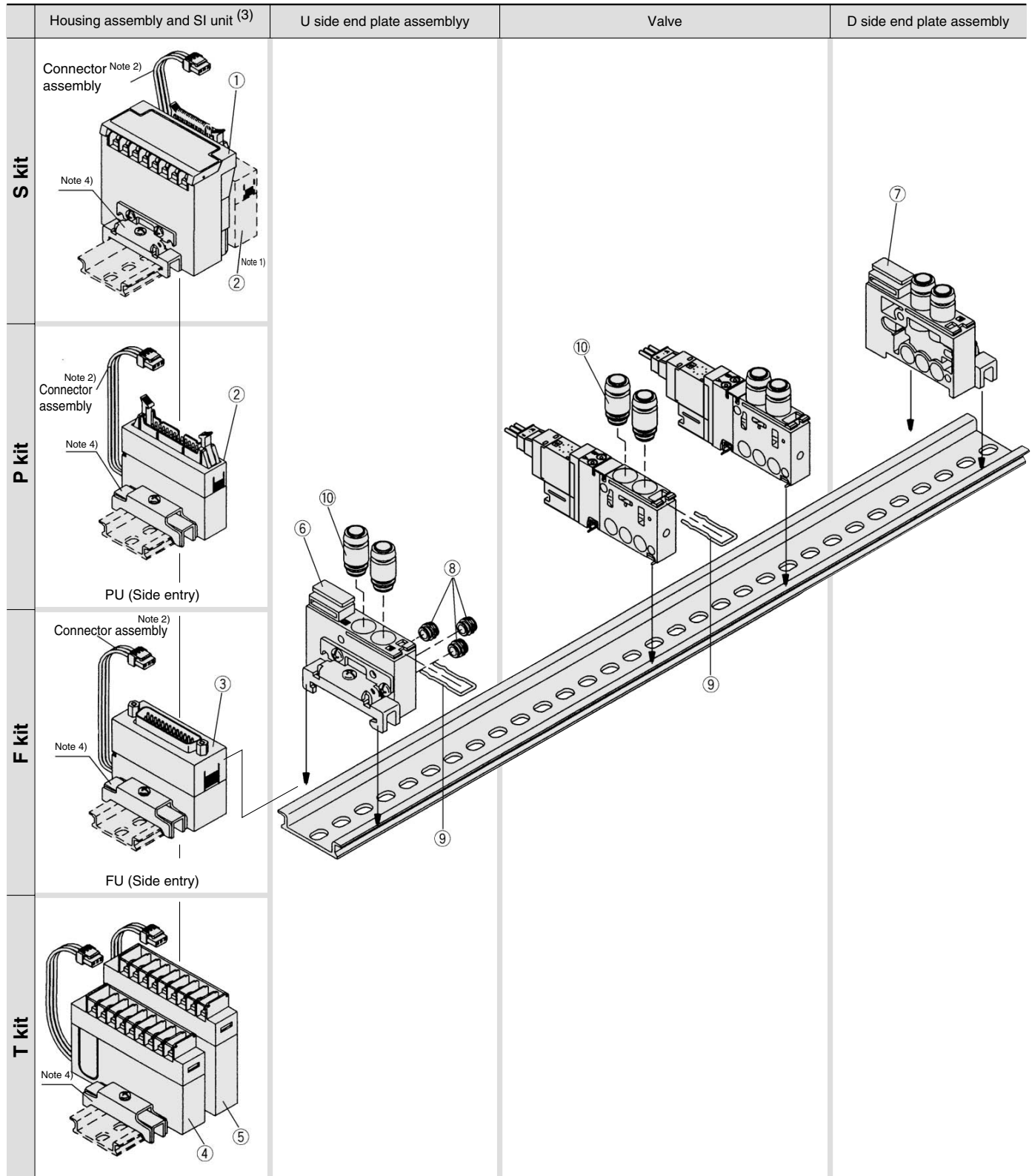

Note 1) S kit is composed of a flat ribbon cable housing assembly (AXT100-2-PU20) of ① SI unit and ② P kit (20 pins).

Note 2) Since no connector assembly is included, order it separately. (Refer to page 2-4-93.)

Note 3) A housing assembly is not used for a C kit.

Note 4) A DIN rail clamping bracket is attached to each.

<Housing Assembly and SI Unit>

Housing assembly and SI unit no.

No.	Manifold	Part no.	Description
	(SA kit)	EX321-S001(-XP)	General type SI unit (Series EX300)
	(SB kit)	EX121-SMB1(-XP)	SI unit for MELSECNET/MINI-S3 Data Link System (Mitsubishi Electric Corporation)
	(SC kit)	EX121-STA1(-XP)	SI unit for SYSBUS Wire System (OMRON Corporation)
	(SD kit)	EX121-SSH1(-XP)	SI unit for Satellite I/O Link System (SHARP Corporation)
	(SE kit)	EX121-SPA1	SI unit for MEWNET-F System (Matsushita Electric Works Ltd.)
	(SF1kit)	EX121-SUW1(-XP)	SI unit for 16 point Uni-wire System (NKE Corporation)
	(SG kit)	EX121-SAB1(-XP)	SI unit for Allen Bradley Remote I/O (RIO) System (Rockwell Automation, Inc.)
① ⁽¹⁾	(SH kit)	EX121-SUH1(-XP)	SI unit for 16 point Uni-wire H System (NKE Corporation)
	(SJ1 kit)	EX121-SSL1(-XP)	SI unit for 16 point S-LINK System (SUNX Corporation)
	(SJ2 kit)	EX121-SSL2(-XP)	SI unit for 8 point S-LINK System (SUNX Corporation)
	(SK kit)	EX121-SFU1(-XP)	SI unit for T-LINK Mini System (Fuji Electric Co.,Ltd.)
	(SQ kit)	EX121-SDN1	SI unit for DeviceNet, CompoBus/D (OMRON Corporation)
	(SR1 kit)	EX121-SCS1(-XP)	SI unit for 16 point CompoBus/S System (OMRON Corporation)
	(SR2 kit)	EX121-SCS2(-XP)	SI unit for 8 point CompoBus/S System (OMRON Corporation)
	(SV kit)	EX121-SMJ1(-XP)	Mitsubishi Electric Corporation: CC-LINK System
②	P _S ^U kit	AXT100-2-P _S ^U □ ⁽²⁾	Flat ribbon cable housing assembly □ = Number of pins: 26, 20, 16, 10
③	F _S ^U kit	AXT100-2-F _S ^U □ ⁽²⁾	D-sub connector housing assembly □ = Number of pins: 25, 15
④ ⁽³⁾	T kit	AXT100-2-TA1	Terminal block assembly (8 terminals)
⑤ ⁽³⁾	T kit	AXT100-2-TA2	Terminal block assembly (8 terminals)



Note 1) A S kit is composed of a flat ribbon cable housing assembly (AXT100-2-PS20) of ① SI unit and ② P kit (20 pins). Place an order for AXT100-2-PS20 separately. Suffix -XP for dustproof type SI unit.

Note 2) Top/vertical entry connector for FU and PU while side (horizontal) entry connector for FS and PS.

Note 3) Since no connector assembly is included, order it separately. (Refer to page 2-4-93.)

Note 4) In the case of standard specifications and double wiring, ④ is for 1 to 4 stations and ⑤ is for 5 to 8 stations.



VQC

SQ

VQ0

VQ4

VQ5

VQZ

VQD

<D Side End Plate Assembly>

⑥ D side end plate assembly no.

VVQ1000-3A-7



Note) The ⑩'s fitting assembly is included.

<U Side End Plate Assembly No.>

⑦ U side end plate assembly no.

VVQ1000-2A-7



Note) The ⑩'s fitting assembly is included.

<Replacement Parts>

No.	Part no.	Description	Material	Number
⑧	VVQ1000-80A-7-2	Bushing assembly		3
⑨	VVQ1000-80A-7-4	Clip	Stainless steel	12

<Fittings Assembly>

⑩ Fittings assembly part no.

VVQ1000-50A-□

Port size

C3: Applicable tubing ø3.2

C4: Applicable tubing ø4

C6: Applicable tubing ø6⁽¹⁾



Note 1) Standard SUP/EXH port is C6.

Note 2) Purchasing order is available in units of 10 pieces.