

Series VQ2000

Base Mounted

Plug-in Unit

How to Order Manifold

Series
2 VQ2000

Manifold
1 Plug-in unit

Cylinder port
08 C6 F U1

Kit type
L8 B4 B6 B8 LM

Option

Symbol	Option
Nil	None
B	Back pressure check valve ⁽²⁾
D	DIN rail mounting style
K	Special wiring specifications (Except double wiring) ⁽³⁾
N	With name plate
R	External pilot ⁽⁴⁾
S	Built-in silencer, direct exhaust
W	Enclosure: Dust tight/splashproof type (IP65) [T, L, S and M kits only]

Note 1) When two or more symbols are specified, indicate them alphabetically. Example) -DNR.
 Note 2) Models with a suffix "-B" have check valves for prevention of back pressure at all manifold stations. If not all stations need this check valve, specify the stations where check valves are installed by manifold specification sheet.
 Note 3) Specify the wiring specifications in the manifold specification sheet. (Except L kit)
 Note 4) Indicate "R" for the valve with external pilot.

Stations

Symbol	Port size	Symbol	Port size
C4	With One-touch fitting for ø4	L8	W/ elbow One-touch fitting ø8 for top piping
C6	With One-touch fitting for ø6	B4	W/ elbow One-touch fitting ø6 for bottom piping
C8	With One-touch fitting for ø8	B6	W/ elbow One-touch fitting ø6 for bottom piping
CM	With mixed size/with port plug ⁽¹⁾	B8	W/ elbow One-touch fitting ø8 for bottom piping
L4	W/ elbow One-touch fitting ø4 for top piping	LM	Mixed size for elbow piping
L6	W/ elbow One-touch fitting ø4 for top piping		

The maximum and minimum number of stations are varied depending on kit. (Refer to the table below.)

Note 1) Specify "Mixed size/with port plug" on the manifold specification sheet.
 Note 2) Inch-size One-touch fittings are available. For details, refer to page 2-4-179.

Simple specials are available with SMC Simple Specials System. For details about applicable models, Contact SMC.

Kit/Electrical entry/Cable length

F kit (D-sub connector)

Note 1) 25P

Connector entry direction: Top entry, Side entry

P. 2-4-130

Kit	U0	U1	U2	U3	S0	S1	S2	S3
	Without cable	With cable (1.5 m)	With cable (3 m)	With cable (5 m)				

P kit (Flat ribbon cable connector)

Note 1) 26P

Connector entry direction: Top entry, Side entry

P. 2-4-134

Kit	U0	U1	U2	U3	S0	S1	S2	S3
	Without cable	With cable (1.5 m)	With cable (3 m)	With cable (5 m)				

J kit (Flat ribbon cable connector (20P))

Note 1) 26P

Connector entry direction: Top entry, Side entry

P. 2-4-138

Kit	U0	U1	U2	U3	S0	S1	S2	S3
	Without cable	With cable (1.5 m)	With cable (3 m)	With cable (5 m)				

G kit (Flat ribbon cable connector with power supply terminal block)

Compatible only with 24 VDC valves.

Connector entry direction: Top entry

P. 2-4-142

Kit	U0	U1	U2	U3	S0	S1	S2	S3
	Without cable	With cable (1.5 m)	With cable (3 m)	With cable (5 m)				

How to Order Valves

VQ 2 1 0 0 Y 5

Series
2 VQ2000

Type of actuation

1	2 position single (A)(B) (R1)(P1)(R2)	Note A	4 position dual 3 port valve (A) (N.C) 1 (N.C)
	2 position double (A)(B) (R1)(P1)(R2)	Note B	4 position dual 3 port valve (B) (N.O) 1 (N.O)
2	Metal		
	Rubber	Note C	4 position dual 3 port valve (C) (N.C) 1 (N.O)

Enclosure
Nil: Dust-protected
W: Dusttight/Low jetproof type (IP65)

Manual override
Nil: Non-locking push type (tool required)
B: Push-locking slotted type
C: Locking type (Manual)

Light/Surge voltage suppressor
Nil: Yes
E: None
Note: Inapplicable to the S kit.

Coil voltage

1	100 VAC (50/60 Hz)
2	200 VAC (50/60 Hz)
3	110 VAC (50/60 Hz)
4	220 VAC (50/60 Hz)
5	24 VDC
6	12 VDC

Note) 200/220 VAC models are applicable to F and L kits.

Function

Symbol	Specifications	DC	AC
Nil	Standard type	(1.0 W)	Note
H	High pressure type	(1.5 W)	—
Y	Low wattage type	(0.5 W)	—

Note) For power consumption of AC type, refer to page 2-4-129.
Note) For external pilot and negative COM specifications, refer to "Option" on page 2-4-178 to 2-4-179.

Seal
0: Metal seal
1: Rubber seal

Note) For sub-plate single unit type, refer to page 2-4-165.

Note) Rubber seal type only.

How to Order Manifold Assembly

Example

Double solenoid (24 VDC)
VQ2200-5 (4 sets)

Single solenoid (24 VDC)
VQ2100-5 (3 sets)

Blanking plate
VQ2000-10A-1 (1 set)

D-sub connector
AXT100-DS25-030

F kit (D-sub connector)

Manifold base (8 stations)
VV5Q21-08C8FU2

VV5Q21-08C8FU2 ... 1 set (F kit 8 station manifold base no.)
*VQ2100-5 3 sets (Single solenoid part no.)
*VQ2200-5 4 sets (Double solenoid part no.)
*VVQ2000-10A-1 ... 1 set (Blanking plate part no.)

The asterisk denotes the symbol for assembly. Prefix it to the part nos. of the solenoid valve, etc.

Specify the part numbers for valves and options together beneath the manifold base part number. Besides, when the arrangement will be complicated, specify them by means of the manifold specification sheet.

- VQC
- SQ
- VQ0
- VQ4
- VQ5
- VQZ
- VQD

T kit (Terminal box)

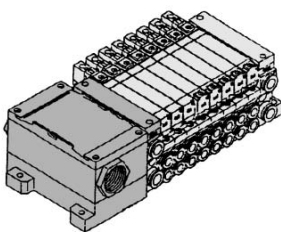

Dust tight/Low jetproof type (IP65) available P. 2-4-146

Kit T	O	Terminal block box	2 to 20 stations ⁽²⁾
-------	---	--------------------	---------------------------------

L kit (Lead wire cable)

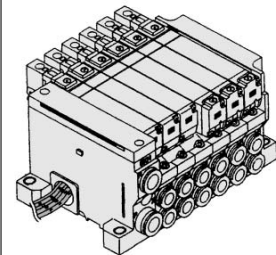

Dust tight/Low jetproof type (IP65) available P. 2-4-150

Kit L	0	With cable (0.6 m)	1 to 8 stations
	1	With cable (1.5 m)	
	2	With cable (3 m)	

S kit (Serial transmission unit)⁽⁴⁾

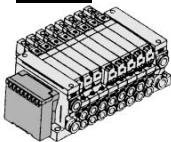

The valve is equipped with an indicator light and surge voltage suppressor, and the voltage is 24 VDC. The dusttight SI unit is available. Refer to page 2-4-154 for details. Dusttight/splashproof type (IP65) is also available. (Except SE and SG.)

P. 2-4-154

Kit S	Option	Description	Max. stations	
Kit S	O	Without SI unit	Max. 16 stations ⁽²⁾	
	A	With general type SI unit (Series EX300)		
	B	Mitsubishi Electric Corp.: MELSECNET/mini-S3 Data Link System	Max. 16 stations ⁽²⁾	
	BB ⁽⁴⁾	Mitsubishi Electric Corp.: MELSECNET/mini-S3 Data Link System (2 power supply lines)		
	C	OMRON Corp.: SYSBUS Wire System		
	D	SHARP Corp.: Satellite I/O Link System		
	E	Matsushita Electric Works: MEWNET-F System		
	F1	NKE Corp.: Uni-wire System (16 output points)		
	G	Rockwell Automation: Allen Bradley Remote I/O (RIO) System		
	H	NKE Corp.: Uni-wire H System		
	J1	SUNX Corp.: S-LINK System (16 output points)		
	J2	SUNX Corp.: S-LINK System (8 output points)		Max. 8 stations
	K	Fuji Electric Co.: T-LINK Mini System		Max. 16 stations
	Q	DeviceNet, CompoBus/D (OMRON Corp.)		
	R1	OMRON Corp.: CompoBus/S System (16 output points)		
	R2	OMRON Corp.: CompoBus/S System (8 output points)		
V	Mitsubishi Electric Corp.: CC-LINK System	Max. 16 stations		

M kit (Multi-connector)

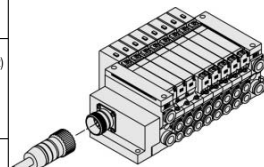

P. 2-4-162

Kit M	0	Without cable	2 to 24 stations ⁽²⁾
	1	With cable (1.5 m)	
	2	With cable (3 m)	

Note 1) Besides the above, F and P kits with different number of pins are available. Refer to page 2-4-177 for details.
 Note 2) For details, refer to page 2-4-178.
 Note 3) Refer to the pages on respective kits for IP65 type. (T, L and S kits)
 Note 4) Kits with IP65 enclosure applicable to input/output are also available. Refer to page 2-4-162 for details.

Manifold Option

Blanking plate assembly
VVQ2000-10A-1

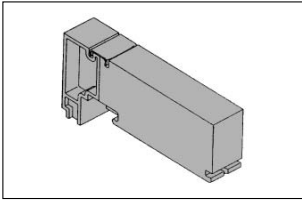

SUP block plate
VVQ2000-16A

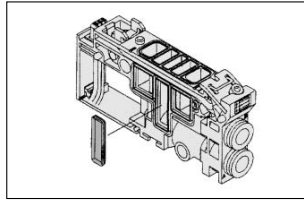

DIN rail mounting bracket [-D]
VVQ2000-57A

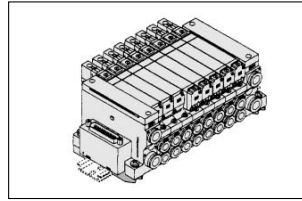

Port plug
VVQ1000-58A

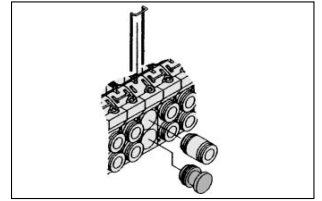

Individual SUP spacer
VVQ2000-P-1-C8

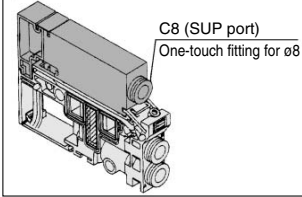

EXH block plate
VVQ2000-19A

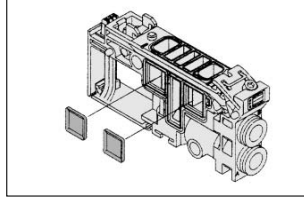

Built-in silencer,
direct exhaust [-S]

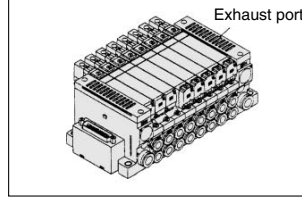

Blanking plug
KQ2P-
ø4
ø6
ø8
ø16

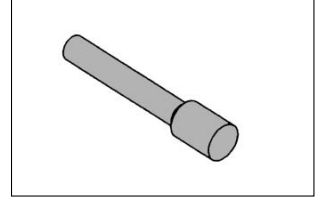

Individual EXH spacer
VVQ2000-R-1-C8

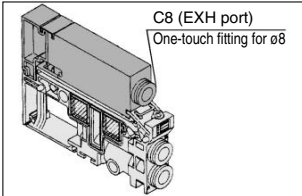

Name plate [-N]
VVQ2000-N-Station (1 to Max. stations)

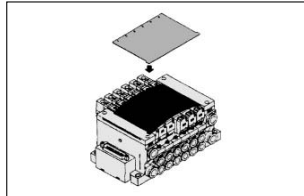

Silencer (For EXH port)
AN200-KM10

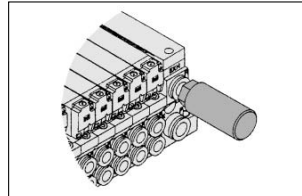

- For cylinder port fittings part no., refer to page 2-4-175.
- For replacement parts, refer to page 2-4-227.

Back pressure check valve assembly [-B]
VVQ2000-18A

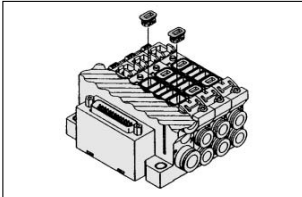

Elbow fitting assembly
VVQ2000-F-L (C4, C6, C8)

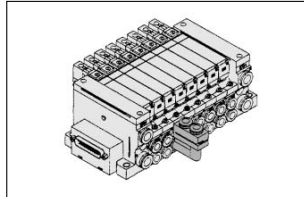

2 stations matching fitting assembly
VVQ2000-52A-C10

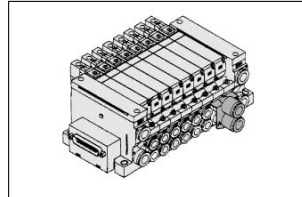

Double check block
VQ2000-FPG-□□

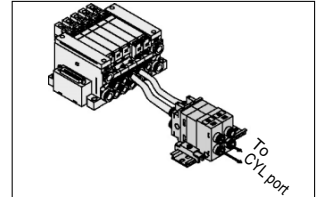

Standard Specifications

JIS Symbol

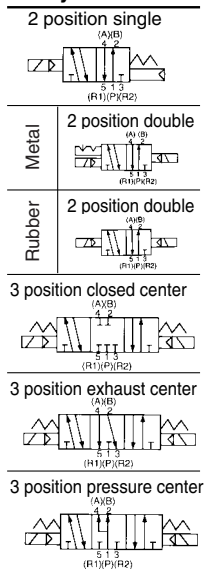

Valve specifications	Valve construction	Metal seal	Rubber seal	
	Fluid	Air/Inert gas	Air/Inert gas	
	Maximum operating pressure	0.7 MPa (High pressure type: 0.8 MPa)		
	Minimum operating pressure	Single	0.1 MPa	0.15 MPa
		Double	0.1 MPa	0.1 MPa
		3 position	0.1 MPa	0.2 MPa
	Ambient and fluid temperature	-10 to 50°C ⁽¹⁾		
	Lubrication	Not required		
	Manual override	Push type/Locking type (Tool required, Manual type) Option		
	Impact/Vibration resistance ⁽²⁾	150/30 m/s ²		
Enclosure	Dust-protected, Dust tight/Low jetproof type (IP65) ⁽⁵⁾			
Solenoid	Coil rated voltage	12, 24 VDC, 100, 110, 200, 220 VAC (50/60 Hz)		
	Allowable voltage fluctuation	±10% of rated voltage		
	Coil insulation type	Class B or equivalent		
	Power consumption (Current)	24 VDC	1 W DC (42 mA), 1.5 W DC (63 mA) ⁽³⁾ , 0.5 W DC (21 mA) ⁽⁴⁾	
		12 VDC	1 W DC (83 mA), 1.5 W DC (125 mA) ⁽³⁾ , 0.5 W DC (42 mA) ⁽⁴⁾	
		100 VAC	Inrush 1.2 VA (12 mA), Holding 1.2 VA (12 mA)	
		110 VAC	Inrush 1.3 VA (12 mA), Holding 1.3 VA (12 mA)	
200 VAC		Inrush 2.4 VA (12 mA), Holding 2.4 VA (12 mA)		
220 VAC	Inrush 2.6 VA (12 mA), Holding 2.6 VA (12 mA)			

VQC

SQ

VQ0

VQ4

VQ5

VQZ

VQD



Note 1) Use dry air to prevent condensation when operating at low temperatures.
 Note 2) Impact resistance ... No malfunction occurred when it is tested with a drop tester in the axial direction and at the right angles to the main valve and armature in both energized and de-energized states every once for each condition. (Values at the initial period)
 Vibration resistance ... No malfunction occurred in a one-sweep test between 45 and 2000 Hz. Test was performed at both energized and de-energized states in the axial direction and at the right angles to the main valve and armature. (Values at the initial period)
 Note 3) Value for high voltage type (1.5 W)
 Note 4) Value for low voltage type (0.5 W)
 Note 5) Dusttight/Low jetproof type (IP65) is available on T, L, S and M kits of VQ2000.

Manifold Specifications

Series	Base model	Type of connection	Porting specifications		Applicable stations ⁽²⁾	Applicable solenoid valve	5 station weight (g)	
			Port location	Port size ⁽¹⁾				
VQ1000	VV5Q11-□□□	<ul style="list-style-type: none"> F kit—D-sub connector P kit—Flat ribbon cable connector J kit—Flat ribbon cable connector (20P) G kit—Flat ribbon cable connector with terminal block T kit—Terminal box L kit—Lead wire cable S kit—Serial transmission unit 	Side	1(P), 3(R)	4(A), 2(B)	F, P, T kits 2 to 24 stations (J, G, S kit) 2 to 16 stations (L kit) 1 to 8 stations	VQ1□00 VQ1□01	628 (Single) 759 (Double, 3 position)
				C8 (ø8) Option (Built-in silencer, direct exhaust)	C3 (ø3.2) C4 (ø4) C6 (ø6) M5 (M5 thread)			
VQ2000	VV5Q21-□□□	<ul style="list-style-type: none"> F kit—D-sub connector P kit—Flat ribbon cable connector J kit—Flat ribbon cable connector (20P) G kit—Flat ribbon cable connector with terminal block T kit—Terminal box L kit—Lead wire cable S kit—Serial transmission unit M kit—Multi-connector 	Side	C10 (ø10) Option (Built-in silencer, direct exhaust)	C4 (ø4) C6 (ø6) C8 (ø8)	(F, P kits) 2 to 24 stations (J, G, S kit) 2 to 16 stations (L kit) 1 to 8 stations (T kit) 2 to 20 stations	VQ2□00 VQ2□01	1051 (Single) 1144 (Double, 3 position)

Note 1) Inch-size One-touch fittings are also available. For details, refer to page 2-4-179.
 Note 2) For details, refer to page 2-4-178.

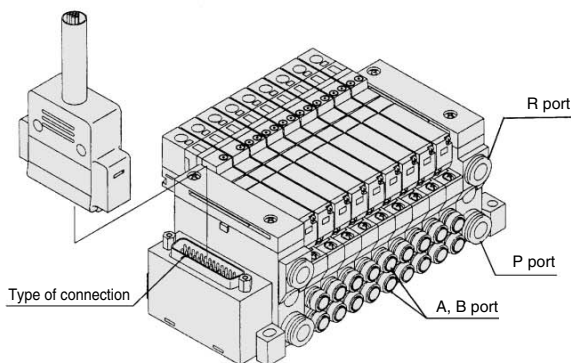

VV5Q11

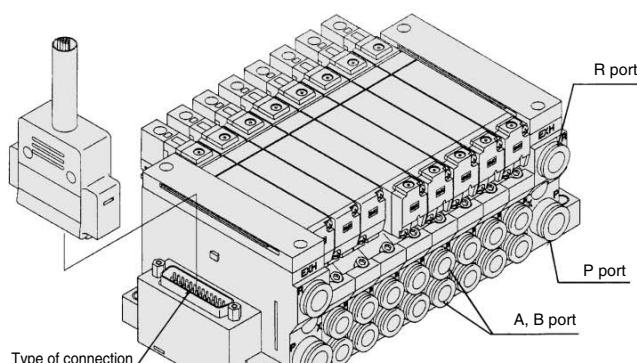

VV5Q21

P VQ1000/2000 Kit (Flat ribbon cable connector)

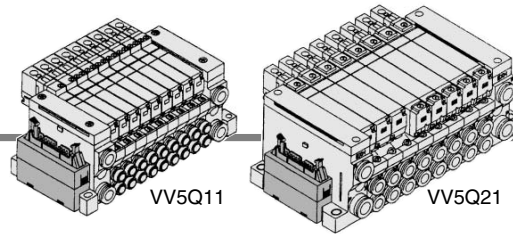

- MIL flat ribbon cable connector reduces installation labor for electrical connection.
- Using the connector for flat ribbon cable (26P) conforming to MIL standard permits the use of connectors put on the market and gives a wide interchangeability.
- Top or side receptacle position can be selected in accordance with the available mounting space.
- Maximum stations are 24.

Manifold Specifications

Series	Porting specifications		Applicable stations
	Port location	Port size	
VQ1000	Side	1(P), 3(R) 4(A), 2(B)	Max. 24 stations
VQ2000	Side	C8 C4, C6, C8	Max. 24 stations

Flat Ribbon Cable (26 pins)

AXT100-FC26-1₃
 (Flat ribbon cable connector assembly can be ordered individually or included in a specific manifold model no. Refer to How to Order Manifold.)

Flat Ribbon Cable Connector Assembly (Option)

Cable length (L)	Assembly part no.	Note
1.5 m	AXT100-FC26-1	Cable 26 core x 28AWG
3 m	AXT100-FC26-2	
5 m	AXT100-FC26-3	

* For other commercial connectors, use a 26 pins type with strain relief conforming to MIL-C-83503.

Connector manufacturers' example

- Hirose Electric Co., Ltd.
- Sumitomo 3M Limited
- Fujitsu Limited
- Japan Aviation Electronics Industry, Ltd.
- J.S.T. Mfg. Co., Ltd.
- Oki Electric Cable Co., Ltd.

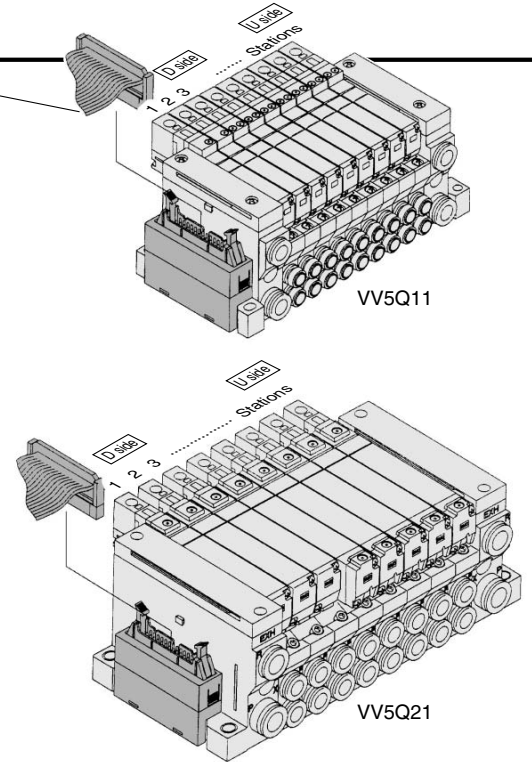

The total number of stations is tabulated starting from one on the D side.

How to Order Manifold

VV5Q 1 1-08 C6 P U 1 N

Series

1	VQ1000
2	VQ2000

Manifold

1	Plug-in unit
---	--------------

Stations

02	2 stations
⋮	⋮
24	24 stations

Connector entry direction

U	Top entry
S	Side entry

Cable (Length)

0	Without cable
1	With cable (1.5 m)
2	With cable (3 m)
3	With cable (5 m)

Cylinder port

Symbol	Port size	VQ1000	VQ2000
C3	With One-touch fitting for ø3.2	●	
C4	With One-touch fitting for ø4	●	●
C6	With One-touch fitting for ø6	●	●
C8	With One-touch fitting for ø8		●
M5	M5 thread	●	
CM	With mixed size/with port plug	●	● ⁽³⁾

Option

Symbol	Option	VQ1000	VQ2000	Note
Nil	None	●	●	
B	Back pressure check valve	●	●	(2)
D	DIN rail mounting style	●	●	
G1	1 set of regulator unit			(3)
G2	2 sets of regulator unit	●		
G3	3 sets of regulator unit			
J□	With vacuum ejector unit	●		(4)
K	Special Wiring Specifications (Not double wiring)	●	●	(5)
N	With name plate	●	●	
R	External pilot	●	●	(6)
S	Built-in silencer, direct exhaust	●	●	

- Note 1) When two or more symbols are specified, indicate them alphabetically. Example) -BRS
- Note 2) Models with a suffix "-B" have check valves for prevention of back pressure at all manifold stations. If not all stations need this check valve, specify the stations where check valves are installed by using the manifold specification sheet.
- Note 3) Specify the mounting position in the manifold specification sheet.
- Note 4) Refer to page 2-4-170 for the details of ejector mounted styles. A combination of "J" and "N" is unavailable.
- Note 5) Specify the wiring specifications in the manifold specification sheet.
- Note 6) Indicate "R" for the valve with external pilot.

Note) For details, refer to page 2-4-178.

- Note 1) Insert "L" (top piping) or "B" (bottom piping) for elbow type. Example) B6 (Elbow One-touch fittings for ø6, bottom piping.)
- Note 2) Indicate "LM" for models with elbow fittings and mixed cylinder port sizes.
- Note 3) Specify "Mixed size/with port plug" in the manifold specification sheet.
- Note 4) Inch-size One-touch fittings are available. For details, refer to page 2-4-179.

VQC

SQ

VQ0

VQ4

VQ5

VQZ

VQD

● Electrical wiring specifications

Terminal no.	Polarity
SOL.A. 1	(-) (+)
SOL.B. 2	(-) (+)
SOL.A. 3	(-) (+)
SOL.B. 4	(-) (+)
SOL.A. 5	(-) (+)
SOL.B. 6	(-) (+)
SOL.A. 7	(-) (+)
SOL.B. 8	(-) (+)
SOL.A. 9	(-) (+)
SOL.B. 10	(-) (+)
SOL.A. 11	(-) (+)
SOL.B. 12	(-) (+)
SOL.A. 13	(-) (+)
SOL.B. 14	(-) (+)
SOL.A. 15	(-) (+)
SOL.B. 16	(-) (+)
SOL.A. 17	(-) (+)
SOL.B. 18	(-) (+)
SOL.A. 19	(-) (+)
SOL.B. 20	(-) (+)
SOL.A. 21	(-) (+)
SOL.B. 22	(-) (+)
SOL.A. 23	(-) (+)
SOL.B. 24	(-) (+)
COM. 25	(+) (-)
COM. 26	(+) (-)

As the standard electrical wiring specifications, double wiring (connected to SOL. A and SOL. B) is adopted for the internal wiring of each station for 12 stations or less, regardless of valve and option types. Mixed single and double wiring is available as an option. For details, refer to page 2-4-178.

Note) When using the negative common specifications, use valves for negative common. (Refer to page 2-4-178.) For details, refer to "Option" on page 2-4-178.

How to Order Valves

VQ 1 1 0 0 Y - 5

Series

1	VQ1000
2	VQ2000

Type of actuation

1	2 position single
2	2 position double
3	3 position closed center
4	3 position exhaust center
5	3 position pressure center

Manual override

Nil	Non-locking push type (Tool required)
B	Locking type (Tool required)
C	Locking type (Manual)

Light/Surge voltage suppressor

Nil	Yes
E	None

Coil voltage

1	100 VAC (50/60 Hz)
3	110 VAC (50/60 Hz)
5	24 VDC
6	12 VDC

Function

Symbol	Specifications	DC	AC
Nil	Standard type	(1.0 W) ○	(Note) ○
H	High pressure type	(1.5 W) ○	—
Y	Low wattage type	(0.5 W) ○	—

Seal

0	Metal seal
1	Rubber seal

Note) For external pilot and negative COM specifications, refer to "Option" on pages 2-4-178 to 2-4-179.

Note) For power consumption of AC type, refer to page 2-4-129.

How to Order Manifold Assembly

Specify the part numbers for valves and options together beneath the manifold base part number.

<Example>
 Flat ribbon cable kit with 3 m cable
 VV5Q11-09C6PU2 ...1 set—Manifold base no.
 *VQ1100-52 sets—Valve part no. (Stations 1 to 2)
 *VQ1200-54 sets—Valve part no. (Stations 3 to 6)
 *VQ1300-52 sets—Valve part no. (Stations 7 to 8)
 *VVQ1000-10A-11 set—Blanking plate no. (Station 9)

Prefix the asterisk to the part nos. of the solenoid valve, etc. Write sequentially from the 1st station on the D side. When part nos. written collectively are complicated, specified by using the manifold specification sheet.

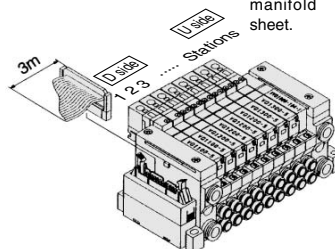

VQ2000

The broken lines indicate the DIN rail mounting style [-D] and the side entry connection [-PS].

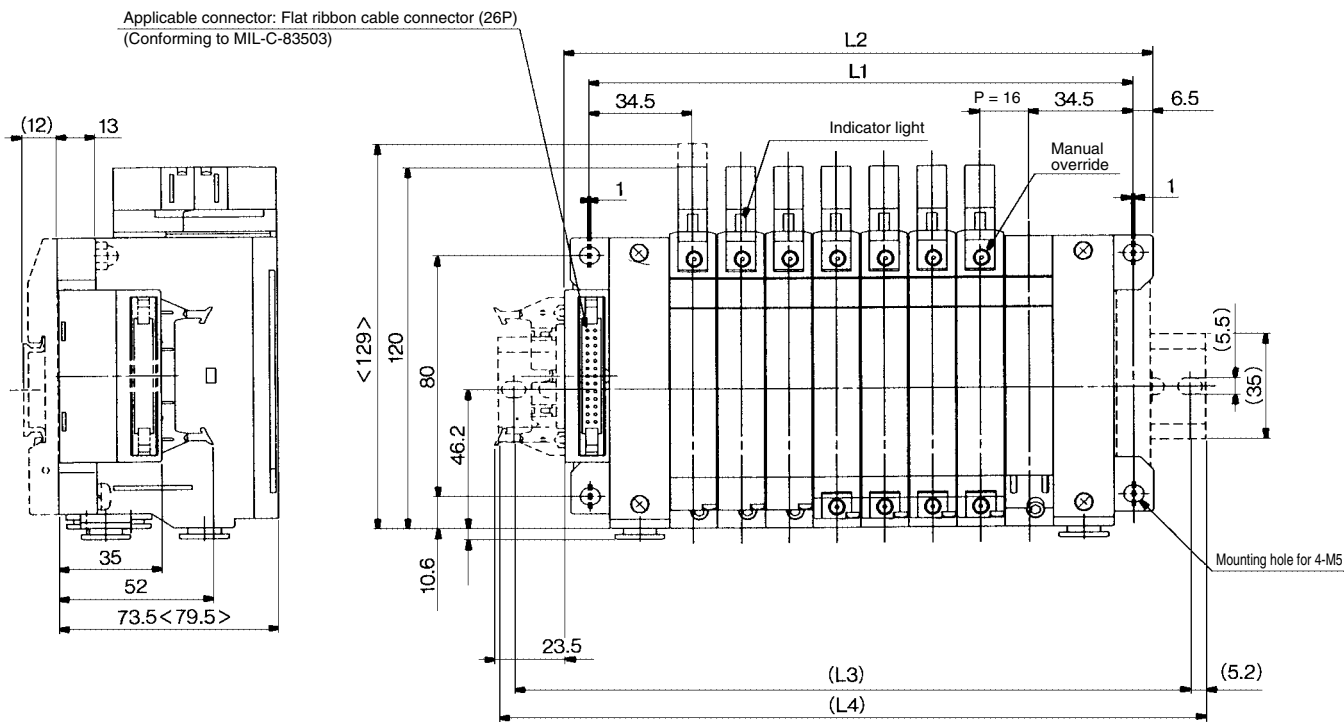

- VQC
- SQ
- VQ0**
- VQ4
- VQ5
- VQZ
- VQD

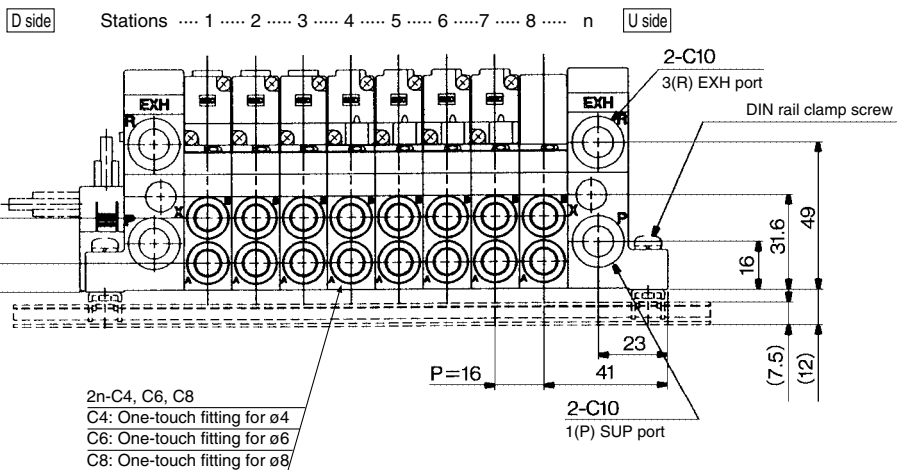

< >: AC

Dimensions

Formula L1 = 16n + 53, L2 = 16n + 68 n: Station (Maximum 24 stations)

L \ n	2	3	4	5	6	7	8	9	10	11	12	13	14	15	16	17	18	19	20	21	22	23	24
L1	85	101	117	133	149	165	181	197	213	229	245	261	277	293	309	325	341	357	373	389	405	421	437
L2	100	116	132	148	164	180	196	212	228	244	260	276	292	308	324	340	356	372	388	404	420	436	452
(L3)	125	150	162.5	175	187.5	212.5	225	237.5	262.5	275	287.5	300	312.5	337.5	350	362.5	387.5	400	412.5	425	450	462.5	475
(L4)	135.5	160.5	173	185.5	198	223	235.5	248	273	285.5	298	310.5	323	348	360.5	373	398	410.5	423	435.5	460.5	473	485.5

Series VQ2000

Manifold Option Parts for VQ2000

Blanking plate assembly VVQ2000-10A-1

It is used by attaching on the manifold block for being prepared for removing a valve for maintenance reasons or planning to mount a spare valve, etc.

JIS Symbol

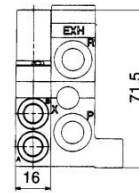
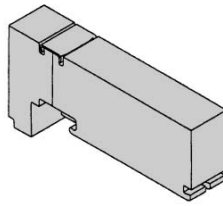

Individual SUP spacer VVQ2000-P-1-C8

When the same manifold is to be used for different pressures, individual SUP spacers are used as SUP ports for different pressures. (One station space is occupied.)

Block both sides of the station, for which the supply pressure from the individual SUP spacer is used, with SUP block plates. (Refer to the application ex.)

* Specify the spacer mounting position and SUP block plate position on the manifold specification sheet. The block plate are used in two places for one set. (Two SUP block plates for blocking SUP station are attached to the individual SUP spacer.)

* Electric wiring is connected to the position of the manifold station where the individual SUP spacer is mounted.

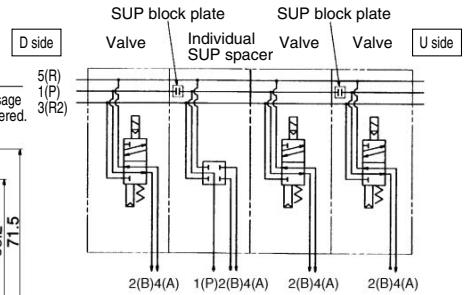
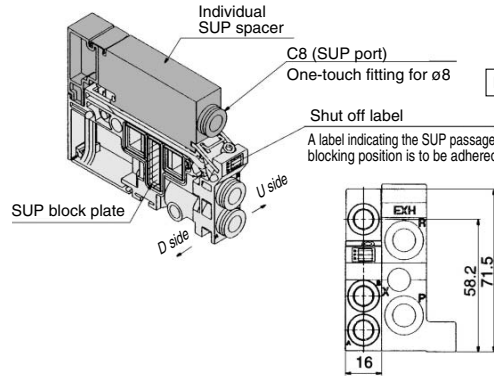

Individual EXH spacer VVQ2000-R-1-C8

When valve exhaust affects other stations due to the circuit configuration, this spacer is used for individual valve exhaust. (One station space is occupied.)

Block both sides of the individual valve EXH station. (See example)

* Specify the mounting position, as well as the EXH block base or EXH block plate position on the manifold specification sheet. The block plates are used in two places for one set. (Two EXH block plates for blocking EXH station are attached to the individual EXH spacer.)

* Electric wiring is connected to the position of the manifold station where the individual EXH spacer is mounted.

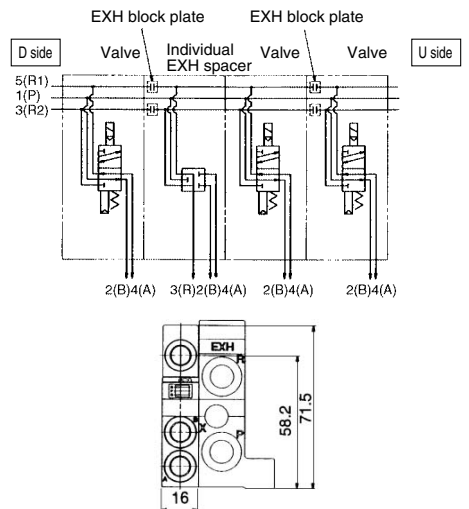
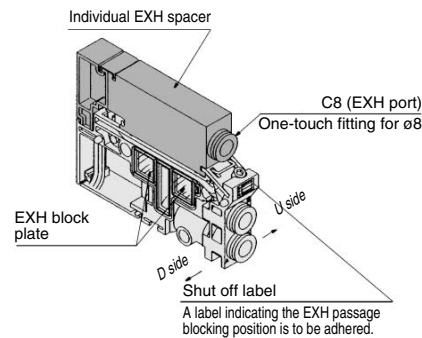

SUP block plate VVQ2000-16A

When different pressures, high and low, are supplied to one manifold, a SUP block plate is inserted between the stations under different pressures.

* Specify the number of stations on the manifold specification sheet.

<Blocking indication label>

When using block plates for SUP passage, indication label for confirmation of the blocking position from outside is attached. (One label of each)

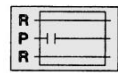
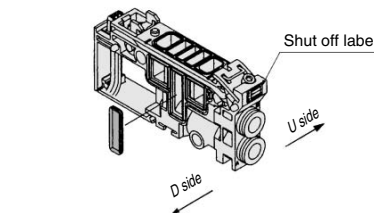

SUP passage blocked

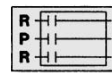

SUP/EXH passage blocked



* When ordering a block plate incorporated with the manifold no., a block indication label is attached to the manifold.

EXH block plate VVQ2000-19A

The EXH block plate is used between stations for which exhaust is desired to be divided when valve exhaust affects other stations due to the circuit configuration. It is also used in combination with an individual EXH spacer for individual exhaust.

* Specify the number of stations on the manifold specification sheet.

<Blocking indication label>

When blocking the EXH passage with an EXH block plate, an indication label for confirmation of the blocking position from outside is attached. (One label for each)

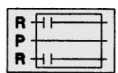
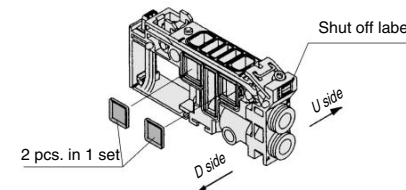

EXH passage blocked

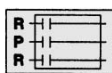

SUP/EXH passage blocked



* When ordering a block plate incorporated with the manifold no., a block indication label is attached to the manifold.

**Back pressure check valve assembly [-B]
VVQ2000-18A**

It prevents cylinder malfunction caused by other valve exhaust. Insert it into R (EXH) port on the manifold side of a valve which is affected. It is effective when a single action cylinder is used or an exhaust center type solenoid valve is used.

Note) When a check valve for back pressure prevention is desired, and is to be installed only in certain manifold stations, write clearly the part no. and specify the number of stations by using the manifold specification sheet.

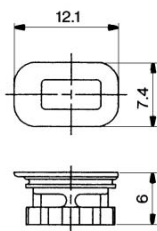
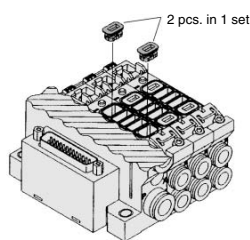

* When ordering assemblies incorporated with a manifold, add suffix "-B" to the manifold no.

- (Precautions)
1. The back pressure check valve assembly parts with a check valve structure. However, as slight air leakage is allowed for the back pressure, take care the exhaust air will not be throttled at the exhaust port.
 2. When a back pressure check valve is mounted, the effective area of the valve will decrease, by about 20%.

**Name plate [-N]
VVQ2000-N-Station (1 to Max. stations)**

It is a transparent resin plate for placing a label that indicates solenoid valve function, etc.

Insert it into the groove on the side of the end plate and bend it as shown in the figure.

• Suffix "N" to the manifold part no.

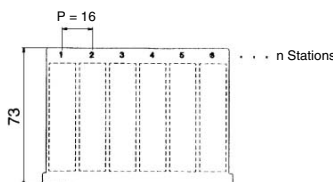
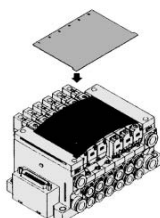

* When ordering assemblies incorporated with a manifold, add suffix "-N" to the manifold no.

Blanking plug (For One-touch fittings)

KQ2P-04
KQ2P-06
KQ2P-08

It is inserted into an unused cylinder port and SUP/EXH ports. Purchasing order is available in units of 10 pieces.

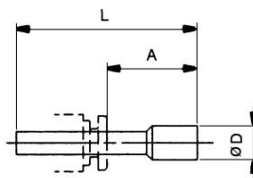
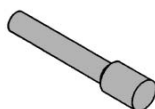

Dimensions

Applicable fittings size Ød	Model	A	L	D
4	KQ2P-04	16	32	6
6	KQ2P-06	18	35	8
8	KQ2P-08	20.5	39	10

**Port plug
VVQ1000-58A**

The plug is used to block the cylinder port when using a 4 port valve as a 3 port valve.

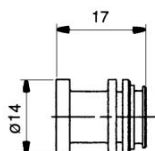
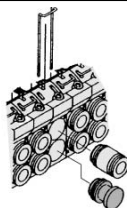

* When ordering a plug incorporated with a manifold, indicate "CM" for the port size in the manifold no., as well as, the mounting position and number of stations and cylinder port mounting positions, A and B, in the manifold specification sheet.

**DIN rail mounting bracket
VVQ2000-57A**

It is used for mounting a manifold on a DIN rail. The DIN rail mounted bracket is fixed to the manifold end plate. (The specification is the same as that for the option "-D".) 1 set of DIN rail mounting bracket is used for 1 manifold (2 DIN rail mounting brackets).

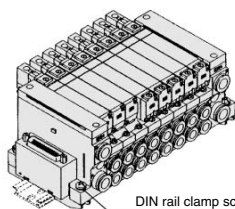

DIN rail clamp screw

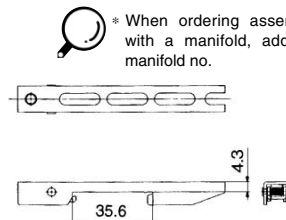

* When ordering assemblies incorporated with a manifold, add suffix "-D" to the manifold no.

Built-in silencer, Direct exhaust [-S]

This is a type with an exhaust port atop the manifold end plate. The built-in silencer exhibits an excellent noise suppression effect. (Silencing effect: 30 dB)

Note) A large quantity of drainage generated in the air source results in exhaust of air together with drainage.
● For maintenance, refer to page 2-4-176.

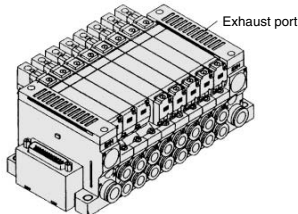

Exhaust port

* When ordering assemblies incorporated with a manifold, add suffix "-S" to the manifold no.

Silencer (For EXH port)

This silencer is to be inserted into the EXH port (One-touch fittings) of the common exhaust type.

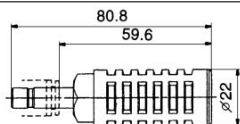

Dimensions

Series	Applicable fittings size Ød	Model	A	L	D	Effective area (mm ²) (Cv factor)	Noise reduction (dB)
VQ2000	10	AN200-KM10	59.6	80.8	22	26 (1.4)	30

**Elbow fitting assembly
VVQ2000-F-L (C4, C6, C8)**

It is used for piping that extends upward or downward from the manifold.

When installing it in part of the manifold stations, specify the assembly no. and the mounting position and number of stations by using the manifold specification sheet.

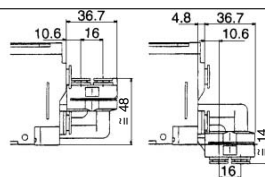

**2 stations matching fitting assembly
VVQ2000-52A-C10**

For driving a cylinder with a large bore, valves for two stations are operated to double the flow rate. This assembly for the cylinder port is used in that case.

This assembly for the cylinder port is used in that case.

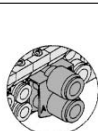

* The bore for the manifold no. is "CM". Clearly indicate the 2 station matching fitting assembly no., and specify the number of stations and positions in the manifold specification sheet.

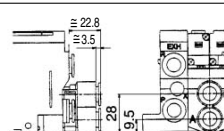

VQC

SQ

VQ0

VQ4

VQ5

VQZ

VQD

Series VQ2000

Manifold Option

Double check block (Separated type)

VQ2000-FPG-□□-□

It is used on the outlet side piping to keep the cylinder in the intermediate position for a long time. Combining the double check block with a built-in pilot type double check valve and a 3 position exhaust center solenoid valve will enable the cylinder to stop in the middle or maintain its position for a long time.

The combination with a 2 position single/double solenoid valve will prevent the dropping at the cylinder stroke end when the SUP residual pressure is released.

Specifications

Max. operating pressure	0.8 MPa
Min. operating pressure	0.15 MPa
Ambient and fluid temp.	-5 to 50°C
Flow characteristics: C	-3.0 dm ³ /(s·bar)
Max. operating frequency	180 c.p.m

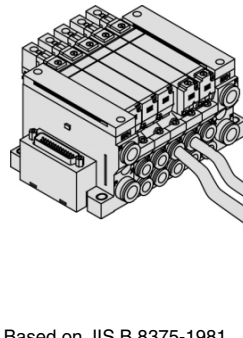

<Check valve operation principle>

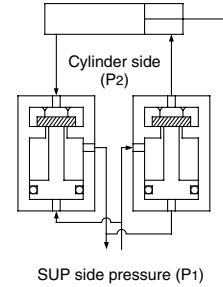

Note) Based on JIS B 8375-1981 (Supply pressure: 0.5 MPa)

Dimensions

Single unit

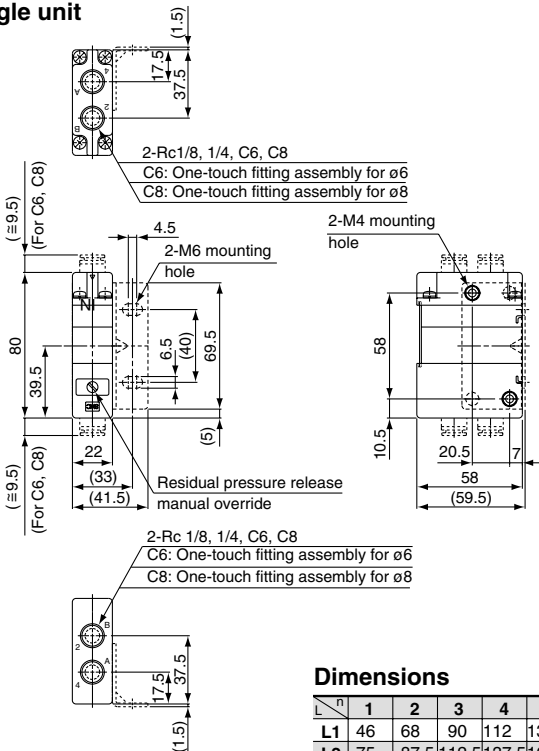

Manifold

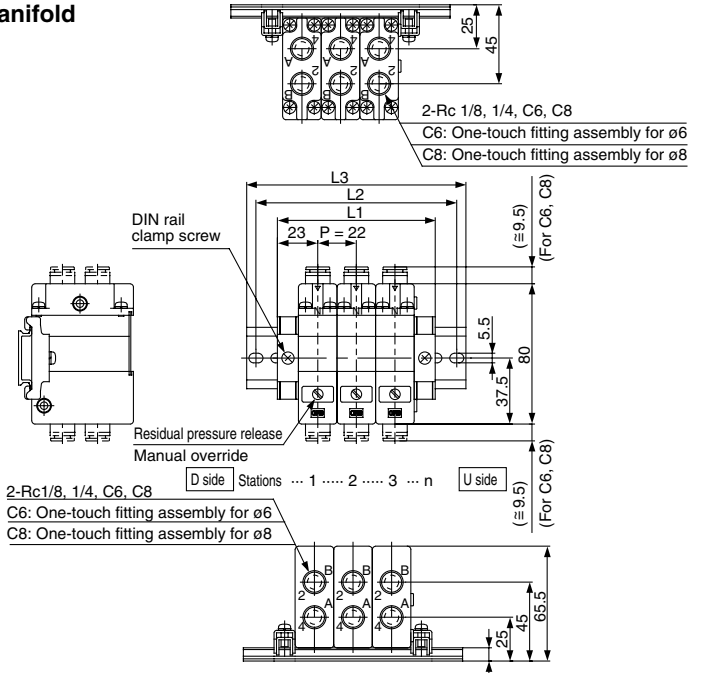

Dimensions

Formula L1 = 22n + 24 n: Station

L n	1	2	3	4	5	6	7	8	9	10	11	12	13	14	15	16
L1	46	68	90	112	134	156	178	200	222	244	266	288	310	332	354	376
L2	75	87.5	112.5	137.5	162.5	175	200	225	250	262.5	287.5	312.5	337.5	362.5	375	400
L3	85.5	98	123	148	173	185.5	210.5	235.5	260.5	273	298	323	348	373	385.5	410.5

How to Order

Double check block

VQ2000-FPG-01 01 F

IN side port size

01	Rc 1/8
02	Rc 1/4
C6	One-touch fitting for ø6
C8	One-touch fitting for ø8

OUT side port size

01	Rc 1/8
02	Rc 1/4
C6	One-touch fitting for ø6
C8	One-touch fitting for ø8

Option

Nil	None
D	DIN rail mounting style (For manifold)
F	With bracket
N	Name plate

Note) When two or more symbols are specified, indicate them alphabetically.

Manifold

VVQ2000-FPG-06

Stations

01	1 station
⋮	⋮
16	16 stations

<Ordering Example>

VVQ2000-FPG-06...6 stations manifold

*VQ2000-FPG-C6C6-D: 3 sets

*VQ2000-FPG-C8C8-D: 3 sets

Double check block

Bracket Assembly

Part no.	Tightening torque
VQ2000-FPG-FB	0.8 to 1.0 N·m

<Example>

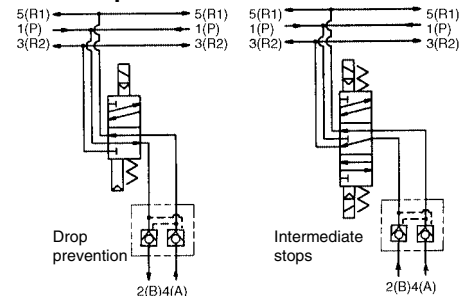

Caution

- Air leakage from the pipe between the valve and cylinder or from the fittings will prevent the cylinder from stopping for a long time. Check the leakage using neutral household detergent, such as dish washing soap. Also check the cylinder's tube gasket, piston packing and rod packing for air leakage.
- Since One-touch fittings allow slight air leakage, screw piping (with M5 thread) is recommended when stopping the cylinder in the middle for a long time.
- Combining double check block with 3 position closed center or pressure center solenoid valve will not work.

- M5 fitting assembly is attached, not incorporated into the double check block. After screwing in the M5 fittings, mount the assembly on the double check block. [Tightening torque: 0.8 to 1.2 N·m]

Connection threads	Proper tightening torque (N·m)
Rc 1/8	7 to 9
Rc 1/4	12 to 14

- If the exhaust of the double check block is throttled too much, the cylinder may not operate properly and may not stop intermediately.
- Set the cylinder load so that the cylinder pressure will be within two times that of the supply pressure.

⚠ Precautions 1

Be sure to read before handling. For Safety Instructions and Solenoid Valve Precautions, refer to page 2-9-2.

Light/Surge Voltage Suppressor

⚠ Caution

The lighting positions are concentrated on one side for both single solenoid type and double solenoid type. In the double solenoid type, A side and B side energization are indicated by two colors which match the colors of the manual overrides.

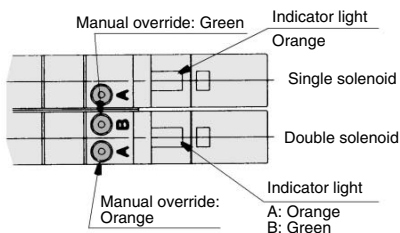

(DWG shows a VQ1000 case.)

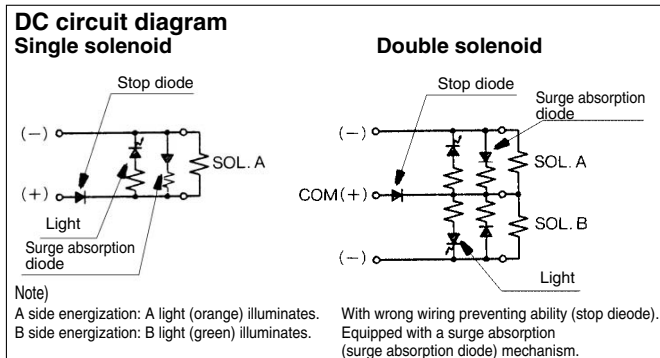

Manual Override

⚠ Warning

Without an electric signal for the solenoid valve the manual override is used for switching the main valve.

Push type is standard. (Tool required)

Option: Locking type (Tool required/Manual)

■ Push type (Tool required)

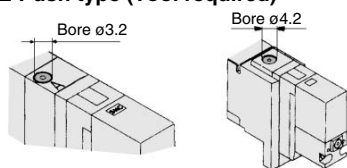

Push down on the manual override button with a small screwdriver until it stops. Release the screwdriver and the manual override will return.

■ Locking type (Tool required) <Option>

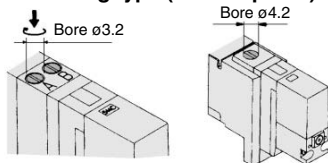

Push down on the manual override button with a small screwdriver or with your fingers until it stops. Turn clockwise by 90° to lock it. Turn it counterclockwise to release it.

■ Locking type (Manual) <Option>

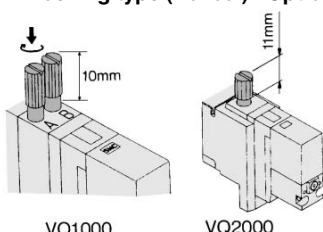

Push down on the manual override button with a small screwdriver or with your fingers until it stops. Turn clockwise by 90° to lock it. Turn it counterclockwise to release it.

⚠ Caution

Do not apply excessive torque when turning the locking type manual override. (0.1 N·m or less)

How to Mount/Remove Solenoid Valve

⚠ Caution

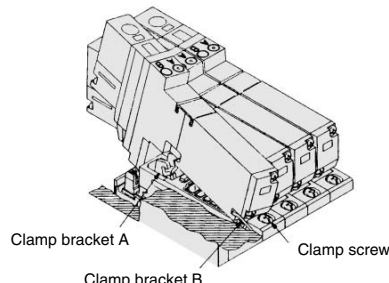

Removing

1. Loosen the clamp screw until it turns freely. (The screw is captive.)
2. Lift the coil side of the valve body while pressing down slightly on the screw head and remove it from the clamp bracket B. When the screw head cannot be pressed easily, gently press the area near the manual override of the valve.

Mounting

1. Press down on the clamp screw. → Clamp bracket A opens. Diagonally insert the hook on the valve end plate side into clamp B.
2. Press the valve body downward. (When the screw is released, it will be locked by clamp bracket A.)
3. Tighten the clamp screw. (Proper tightening torque: VQ1000, 0.25 to 0.35 N·m; VQ2000, 0.5 to 0.7 N·m.)

⚠ Caution

Dust on the sealing surface of the gasket or solenoid valve can cause air leakage.

Replacement of Cylinder Port Fittings

⚠ Caution

The cylinder port fittings are a cassette for easy replacement. The fittings are blocked by a clip inserted from the top of manifold. Remove the clip with a screwdriver to remove fittings.

For replacement, insert the fitting assembly until it strikes against the inside wall and then reinsert the clip to the specified position.

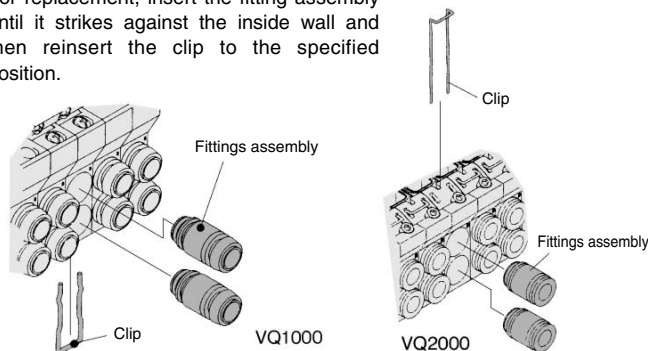

Applicable tubing O.D.	Fitting assembly part no.	
	VQ1000	VQ2000
Applicable tubing ø3.2	VVQ1000-50A-C3	—
Applicable tubing ø4	VVQ1000-50A-C4	VVQ1000-51A-C4
Applicable tubing ø6	VVQ1000-50A-C6	VVQ1000-51A-C6
Applicable tubing ø8	—	VVQ1000-51A-C8
M5	VVQ1000-50A-M5	—

* Refer to "Option" on pages 2-4-172 to 2-4-173 for other types of fittings.

⚠ Caution

1. Use caution that O-rings must be free from scratches and dust. Otherwise, air leakage may result.
2. After screwing in the fittings, mount the M5 fitting assembly on the manifold base. (Tightening torque: 0.8 to 1.2 N·m)
3. Purchasing order is available in units of 10 pieces.

⚠ Precautions 2

Be sure to read before handling. For Safety Instructions and Solenoid Valve Precautions, refer to page 2-9-2.

Mounting/Removing from the DIN Rail

⚠ Caution

Removing

1. Loosen the clamp screw on side (a) of the end plate on both sides.
2. Lift side (a) of the manifold base and slide the end plate in the direction of (2) shown in the figure to remove.

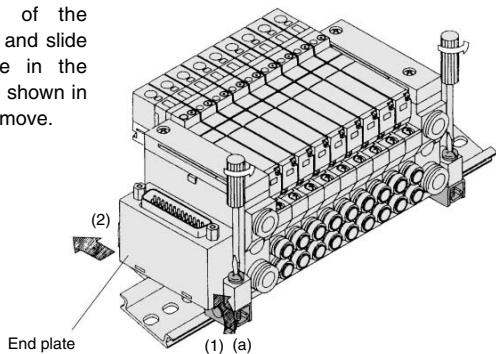

Mounting

1. Hook side (b) of the manifold base on the DIN rail.
2. Press down side (a) and mount the end plate on the DIN rail.
Tighten the clamp screw on side (a) of the end plate.
The proper tightening torque for screws is 0.4 to 0.6 N·m.

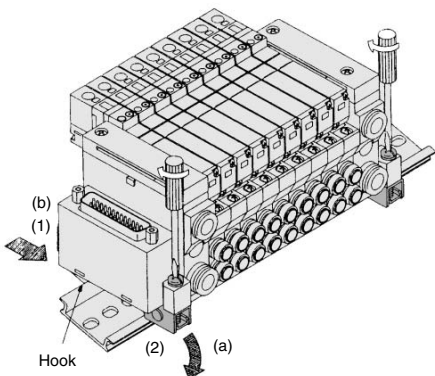

Enclosure IP65

⚠ Caution

Wires, cables, connectors, etc. used for models conforming to IP65 should also have enclosures equivalent to or of stricter than IP65.

Built-in Silencer Replacement Element

⚠ Caution

A silencer element is incorporated in the end plate on both sides of the A dirty and choked element may reduce cylinder speed or cause malfunction. Clean or replace the dirty element.

Element Part No.

Type	Element part no.	
	VQ1000	VQ2000
Built-in silencer, direct exhaust	VVQ1000-82A-1	VVQ2000-82A-1

* The minimum order quantity is 10 pcs.

Remove the cover from the top of the end plate and remove the old element with a screwdriver, etc.

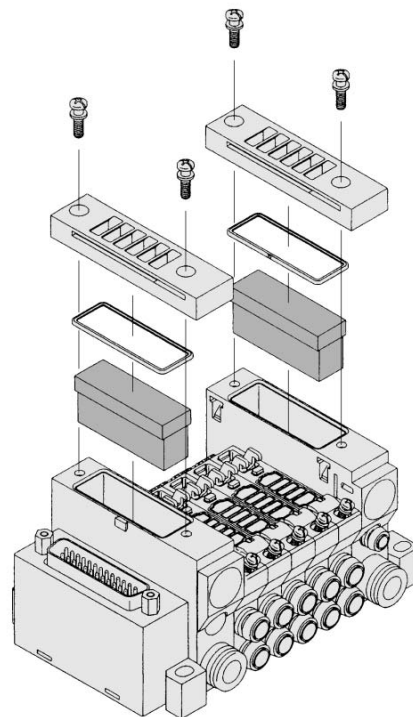

How to Calculate the Flow Rate

For obtaining the flow rate, refer to pages 2-1-8 to 2-1-11.

Option

Different Number of Connector Pins

F and P kits with the following number of pins are available besides the standard number (F = 25; P = 26). Select the desired number of pins and cable length from the cable assembly list. Place an order for the cable assembly separately.

F kit (D-sub connector) 15 pins

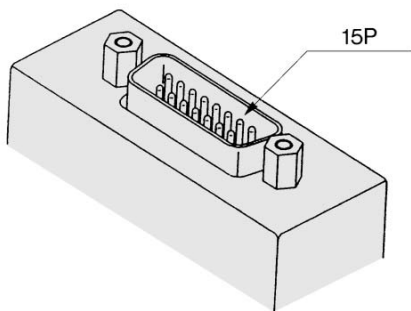

How to order manifold

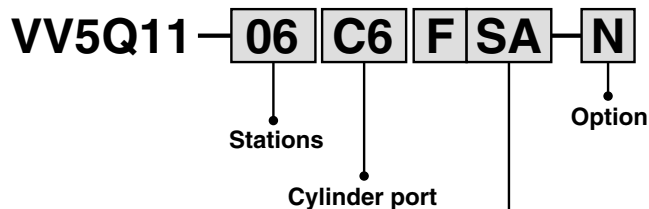

How to Order
D-sub connector, 15 pins
Connector location—Side (horizontal)
Without cable

Kit/Electrical entry

Pins	Location	Top entry		Side entry	
15P (Max. 7 stations)		Kit F	UA	Kit F	SA

Wiring Specifications

* In the same way as the 25-pin models (standard), the terminal no. 1 is for SOL.A at the 1st station, the terminal no. 9 for SOL.B at the 1st station, and the terminal no. 8 for COM.

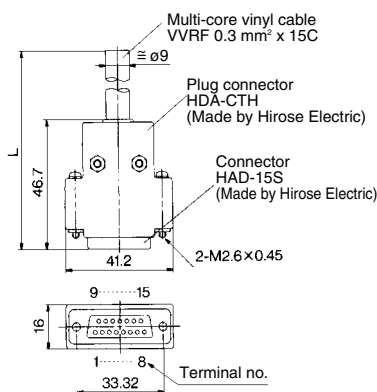

Wire Color Table by Terminal No. of D-sub Connector Cable Assembly

Terminal no.	Lead wire color	Dot marking
1	Black	None
2	Brown	None
3	Red	None
4	Orange	None
5	Yellow	None
6	Pink	None
7	Blue	None
8	Purple	White
9	Gray	Black
10	White	Black
11	White	Red
12	Yellow	Red
13	Orange	Red
14	Yellow	Black
15	Pink	Black

D-sub Connector Cable Assembly

Cable length (L)	Pins	15P
1.5 m		AXT100-DS15-1
3 m		AXT100-DS15-2
5 m		AXT100-DS15-3

* For other commercial connectors, use a type conforming to MIL-C-24308.

P kit (Flat ribbon cable connector) 10 pins, 16 pins, 20 pins

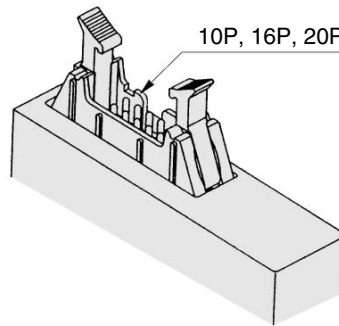

How to order manifold

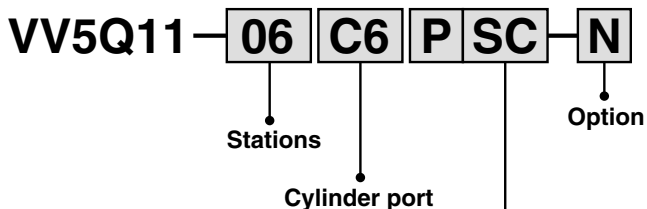

How to Order
Flat ribbon cable, 20 pins
Connector location—Side (Horizontal)
Without cable

Kit/Electrical entry

Pins	Location	Top entry		Side entry	
10P (Max. 4 stations)		Kit P	UA	Kit P	SA
16P (Max. 7 stations)			UB		SB
20P (Max. 9 stations)			UC		SC

Wiring Specifications

* In the same way as the 26-pin models (standard), the terminal no. 1 is for SOL.A at the 1st station, the terminal no. 2 for SOL.B at the 1st station, and two pins from the max. terminal numbers are for COM.

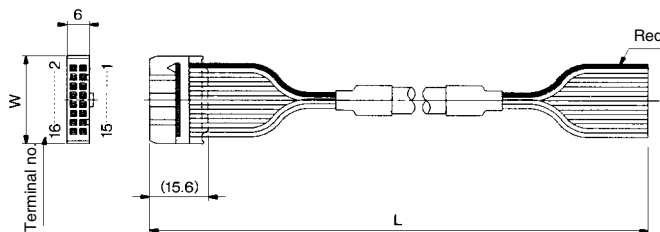

Flat Ribbon Cable Assembly

Cable length (L)	Pins	10P	16P	20P
1.5 m		AXT100-FC10-1	AXT100-FC16-1	AXT100-FC20-1
3 m		AXT100-FC10-2	AXT100-FC16-2	AXT100-FC20-2
5 m		AXT100-FC10-3	AXT100-FC16-3	AXT100-FC20-3
Connector width (W)		17.2	24.8	30

* For other commercial connectors, use a type with strain relief conforming to MIL-C-83503.

- VQC
- SQ
- VQ0
- VQ4
- VQ5
- VQZ
- VQD

Option

Special Wiring Specifications

In the internal wiring of F kit, P kit, J kit, G kit, T kit and S kit, double wiring (connected to SOL. A and SOL. B) is adopted for each station regardless of the valve and option types. Mixed single and double wiring is available as an option.

1. How to Order

Indicate an option symbol “-K”, for the manifold no. and be sure to specify the mounting position and number of stations of the single and double wiring by means of the manifold specification sheet.

Example) **VV5Q11-08C6FU1-D K S**

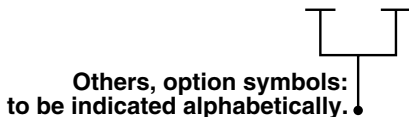

2. Wiring specifications

With the A side solenoid of the 1st station as no.1 (meaning, to be connected to no.1 terminal), without making any terminals vacant.

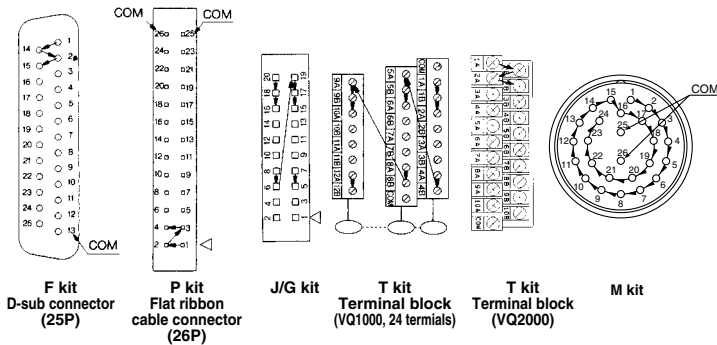

3. Max. number of stations

The maximum number of stations depends upon the number of solenoids. Assuming one for a single and two for a double, determine the number of stations so that the total number is not more than the max. number given in the following table.

Kit	F kit (D-sub connector)		P kit (Flat ribbon cable connector)				J kit (Flat ribbon cable connector)	G kit (Flat ribbon cable with terminal block)
Type	F _S ^U □ 25P	F _S ^U A 15P	P _S ^U □ 26P	P _S ^U C 20P	P _S ^U B 16P	P _S ^U A 10P	J _S ^U □ 20P	G
Max. points	24	14	24	18	14	8	16	16
Kit	T kit (Terminal block)				S kit (Serial transmission)		M kit (Circular connector)	
Type	2 rows of terminal blocks		3 rows of terminal blocks		S□		M□	
VQ1000	16		24					
Max. points	20				16		24	

Negative Common Specifications

Specify the valve model no. as shown below for negative COM specification. The manifold no. shown below is for the T and L kits. For other kits the standard manifold can be used. For negative COM S or G kit, please contact SMC.

VQ1100 N - 5

• Negative common specifications

How to order negative COM manifold

T kit:

VV5Q11-06 C6 T N - N

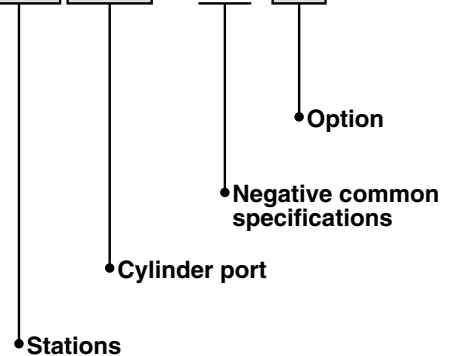

L kit:

VV5Q11-06 C6 L N 1 - N

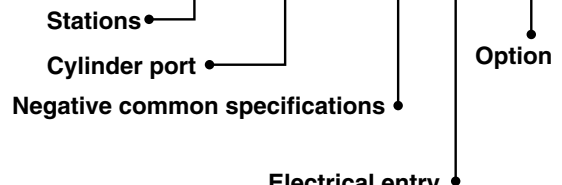

Electrical entry
Cable length

0	With cable (0.6 m)
1	With cable (1.5 m)
2	With cable (3 m)

External Pilot Specifications

When the supply air pressure is lower than the required minimum operating pressure (0.1 to 0.2 MPa) for the solenoid valve (or when the valve is used for vacuum), specify an external pilot model. Order a manifold or valve by suffixing the external pilot specification, "R".

The X-port of the manifold base is equipped with One-touch fittings for external pilot.

VQ1000: C4 (One-touch fitting for ø4)

VQ2000: C6 (One-touch fitting for ø6)

How to order manifold

VV5Q11-08C6FU1-R S

Others, option symbols:
to be indicated alphabetically.

How to order valves

VQ1100 R - 5

External pilot specifications

Note 1) When low wattage type is also desired, specify as "RY".
Note 2) In this valve pilot exhaust is connected to the EA passage of the manifold. Therefore, it is not possible to supply air from EXH port, nor vacuum from ports other than SUP port.

Inch-size One-touch Fittings

The valve with inch-size One-touch fittings is shown below.

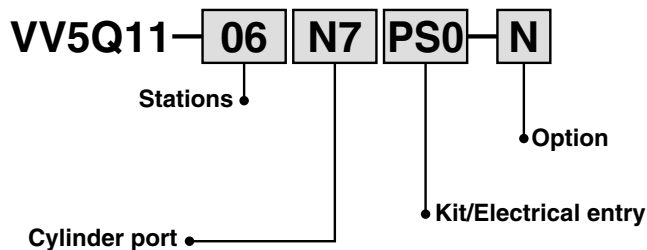

Symbol	N1	N3	N7	N9	M5T	NM
Applicable tubing O.D. (Inch)	ø 1/8"	ø 5/32"	ø 1/4"	ø 5/16"	10-32UNF (M5 thread)	Mixed
4(A), 2(B) port	VQ1000	●	●	—	●	●
	VQ2000	—	●	●	—	●

Note) When inch-size fittings are selected for the cylinder port, use inch size fittings for both P and R port.

1(P), 3(R) port size
 VQ1000 ø5/16" (N9)
 VQ2000 ø3/8" (N11)

- VQC
- SQ
- VQ0**
- VQ4
- VQ5
- VQZ
- VQD

Series VQ1000/2000

Option

DIN Rail Mounting

Each manifold can be mounted on a DIN rail. Order it by indicating a DIN rail mounting option symbol, "-D". In this case, a DIN rail which is approx. 30 mm longer than the manifold with the specified number of stations is attached.

- **When DIN rail is unnecessary**
(DIN rail mounting brackets only are attached.)
Indicate the option symbol, "-DO", for the manifold no.

Example)

VV5Q11-08C6FU1-D0S

Others, option symbols:
to be indicated alphabetically.

- **When using DIN rail longer than the manifold with specified number of stations**
Clearly indicate the necessary number of stations next to the option symbol "-D" for the manifold no.

Example)

VV5Q11-08C6FU1-D09S

DIN rail for 9 stations

Others, option symbols:
to be indicated alphabetically.

- **When changing the manifold style into a DIN rail mounting style.**
Order brackets for mounting a DIN rail. (Refer to "Option" on pages 2-4-168 and 2-4-173.)

No. VVQ1000-57A (For VQ1000)
VVQ2000-57A (For VQ2000)
2 pcs. per one set.

- **When ordering DIN rail only**
DIN rail no.: AXT100-DR-□

As for □, specify the number from the DIN rail table.
For L dimension, refer to the dimensions of each kit.

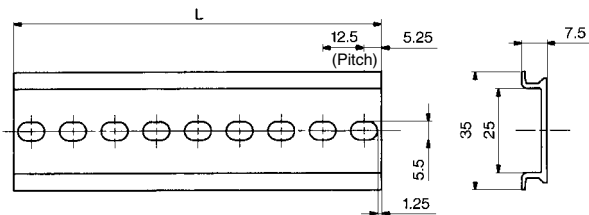

L Dimension

$$L = 12.5 \times n + 10.5$$

No.	1	2	3	4	5	6	7	8	9	10
L dimension	23	35.5	48	60.5	73	85.5	98	110.5	123	135.5
No.	11	12	13	14	15	16	17	18	19	20
L dimension	148	160.5	173	185.5	198	210.5	223	235.5	248	260.5
No.	21	22	23	24	25	26	27	28	29	30
L dimension	273	285.5	298	310.5	323	335.5	348	360.5	373	385.5
No.	31	32	33	34	35	36	37	38	39	40
L dimension	398	410.5	423	435.5	448	460.5	473	485.5	498	510.5

Series VQ

Exploded View: VQ2000/Plug-in Unit

(F, P, J, L, G, S kit)

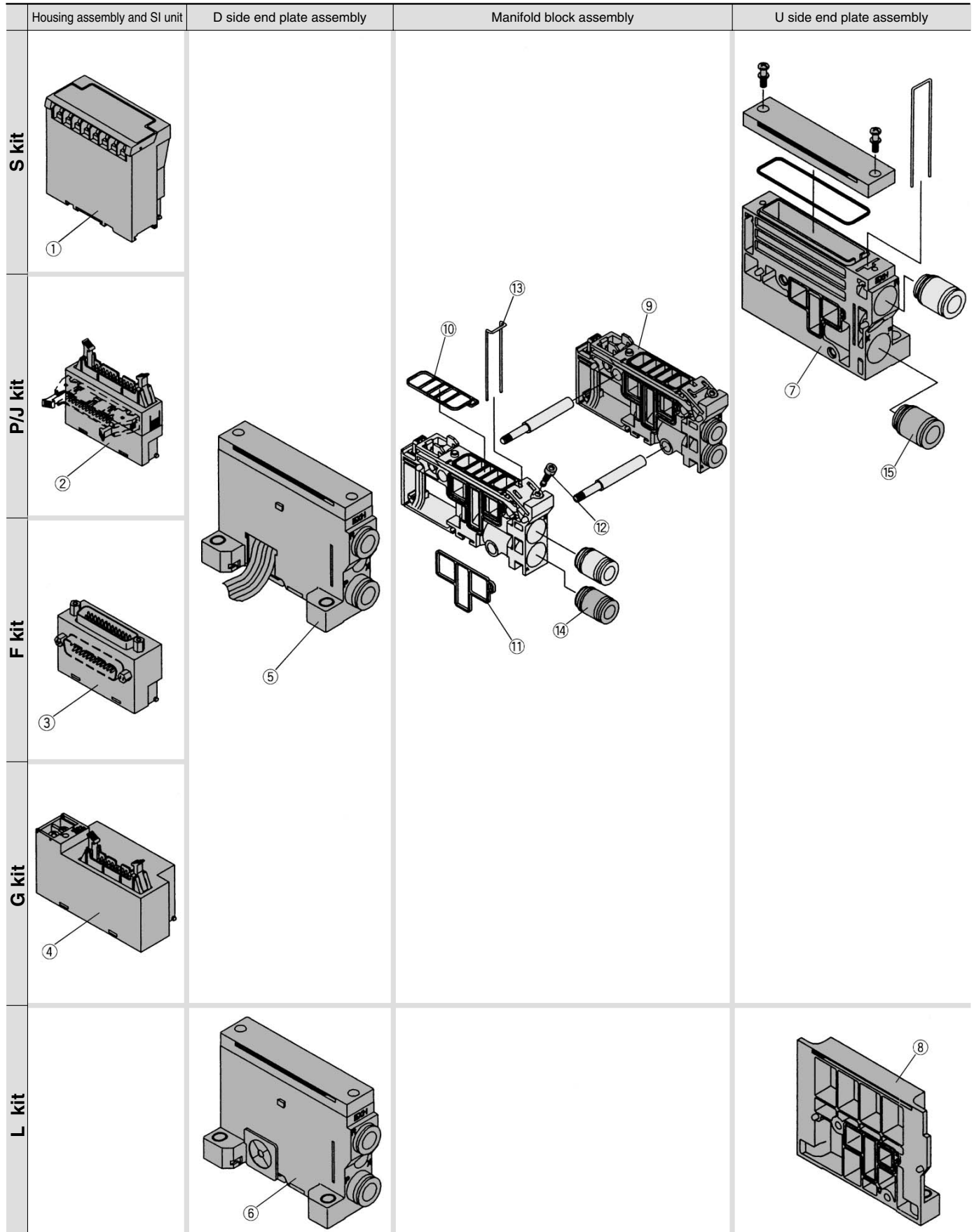

<Housing Assembly and SI Unit>

Housing assembly and SI unit no.

No.	Manifold	Part no.	Description
①	(SA kit)	EX320-S001(-XP) ⁽¹⁾ [EX323-S001] ⁽²⁾	General type SI unit (Series EX300)
	(SB kit)	EX120-SMB1(-XP) ⁽¹⁾ [EX123-SMB1] ⁽²⁾	SI unit for MELSECNET/MINI-S3 Data Link System (Mitsubishi Electric)
	(SBB kit)	[EX124-SMB1] ⁽³⁾	SI unit for MELSECNET/MINI-S3 Data Link System (2 power supply lines) (Mitsubishi Electric Corp.)
	(SC kit)	EX120-STA1(-XP) ⁽¹⁾ [EX123-STA1] ⁽²⁾	SI unit for SYSBUS Wire System (OMRON Corporation)
	(SD kit)	EX120-SSH1(-XP) ⁽¹⁾ [EX123-SSH1] ⁽²⁾	SI unit for Satellite I/O Link System (SHARP Corporation)
	(SE kit)	EX120-SPA1	SI unit for MEWNET-F System (Matsushita Electric Works, Ltd.)
	(SF1 kit)	EX120-SUW1(-XP) ⁽¹⁾ [EX123-SUW1] ⁽²⁾	SI unit for 16 point Uni-wire System (NKE Corporation)
	(SG kit)	EX120-SAB1	SI unit for Allen Bradley Remote I/O (RIO) System (Rockwell Automation, Inc.)
	(SH kit)	EX120-SUH1(-XP) ⁽¹⁾ [EX123-SUH1] ⁽²⁾	SI unit for 16 point Uni-wire H System (NKE Corporation)
	(SJ1 kit)	EX120-SSL1(-XP) ⁽¹⁾ [EX123-SSL1] ⁽²⁾	16 point S-LINK System (SUNX Corporation)
	(SJ2 kit)	EX120-SSL2(-XP) ⁽¹⁾ [EX123-SSL2] ⁽²⁾	8 point S-LINK System (SUNX Corporation)
	(SK kit)	EX120-SFU1(-XP) ⁽¹⁾ [EX123-SFU1] ⁽²⁾	T-LINK Mini System (Fuji Electric Co., Ltd.)
	(SQ kit)	EX120-SDN1 [EX124-SDN1] ⁽²⁾	SI unit for DeviceNet, CompoBus/D (OMRON Corporation)
	(SR1 kit)	EX120-SCS1(-XP) ⁽¹⁾ [EX124-SCS1] ⁽²⁾	SI unit for 16 point Compo Bus/S System (OMRON)
(SR2 kit)	EX120-SCS2(-XP) ⁽¹⁾ [EX124-SCS2] ⁽²⁾	SI unit for 8 point Compo Bus/S System (OMRON)	
(SV kit)	EX120-SMJ1(-XP) ⁽¹⁾ [EX124-SMJ1] ⁽²⁾	SI unit for CC-LINK System (2 power supply systems) (Mitsubishi Electric Corporation)	
②	P _U kit	AXT100-1-P _U □ ⁽⁴⁾	Flat ribbon cable housing assembly □ = Number of pins: 26, 20, 16, 10
	J _U kit	AXT100-1-J _U □ ⁽⁴⁾	Flat ribbon cable housing assembly
③	G kit	AXT100-1-GU20	Flat ribbon cable housing assembly with terminal block
④	F _U kit	AXT100-1-F _U □ ⁽⁴⁾	D-sub connector housing assembly □ = Number of pins: 25, 15

Note 1) Suffix "-XP" for dust-protected type SI unit.
Note 2) Dusttight/Low jetproof type (IP65)

Note 3) SBB kit is usable only for dust tight/low jetproof type (IP65).

Note 4) Top entry connector for FU and PU while side entry connector for FS and PS.

VQC

SQ

VQ0

VQ4

VQ5

VQZ

VQD

<D Side End Plate Assembly>

⑤⑥ D side end plate assembly no.

VVQ2000-3A-1-□-□

Electrical entry

Option

F	For F kit
P	For P kit
J	For J kit
L	For L kit
G	For G kit
S	For S kit

Nil	Common EXH
R ⁽¹⁾	External pilot
S ⁽¹⁾	Built-in silencer, direct exhaust



Note 1) When both options are specified, indicate as RS.

Note 2) The housing assembly and SI unit of F/P/J/G/S kit are not included.

Note 3) Separately place an order for ①, ②, ③, and ④.

For Dusttight/Low jetproof type (IP65), please consult with SMC.

<U Side End Plate Assembly>

⑦ U side end plate assembly no. (For F/P/G/S kits)

VVQ2000-2A-1-□-□

Nil	Common EXH
R	External pilot
S	Built-in silencer, direct exhaust



Note 1) The ⑤'s fitting assembly is included.

Note 2) The housing assembly and SI unit of F/P/J/G/S kit are not included.

Note 3) Separately place an order for ①, ②, ③, and ④.

For Dusttight/Low jetproof type (IP65), please consult with SMC.

⑧ U side end plate assembly no. (For L kit)

VVQ2000-2A-1-L

<Manifold Block Assembly> Tie-rod (2 pcs.) and lead wire assembly for extensions are attached

⑨ Manifold block assembly no.

VVQ2000-1A-□-□-□

Electrical entry

Port size

Enclosure

F1	F kit for 2 to 12 stations/Double wiring	C4	One-touch fitting for ø4
F2	F kit for 13 to 24 stations/Double wiring	C6	One-touch fitting for ø6
F3	F kit for 2 to 24 stations/Single wiring	C8	One-touch fitting for ø8
P1	P, J, G, S kit for 2 to 12 stations/Double wiring		
P2	P, J, G, S kit for 13 to 24 stations/Double wiring		
P3	P, J, G, S kit for 2 to 24 stations/Single wiring		
L0□	L0 kit □ Stations (1 to 8)		
L1□	L1 kit □ Stations (1 to 8)		
L2□	L2 kit □ Stations (1 to 8)		
T1	T kit for 2 to 20 stations/Double wiring		
T3	T kit for 2 to 20 stations/Single wiring		
M1	M kit for 2 to 12 stations/Double wiring		
M2	M kit for 13 to 24 stations/Double wiring		
M3	M kit for 2 to 24 stations/Single wiring		

Nil	Dusttight
W	Dusttight/Low jetproof type (IP65)

Note) F, P, J, G kits are available with "Nil" only.

M kit is available with [W] only.

S, L, T kits are selectable, depending upon the manifold type.

<Fitting Assembly>

⑭ Fitting assembly part no. (For cylinder port)

VVQ1000-51A-□

Port size



Note) Purchasing order is available in units of 10 pieces.

C4	Applicable tubing ø4
C6	Applicable tubing ø6
C8	Applicable tubing ø8

⑮ Fitting assembly part no. (For P, R ports)

VVQ2000-51A-C10

Applicable tubing ø10

Note) Purchasing order is available in units of 10 pieces.

Note) A set of parts containing 12 pcs. each is enclosed.

<Replacement Parts for Manifold Block>

Replacement Parts

No.	Part no.	Description	Material	Number
⑩	VVQ2000-80A-1	Gasket	HNBR	12
⑪	VVQ2000-80A-2	Packing	HNBR	12
⑫	VVQ2000-80A-3	Clamp screw	Carbon steel	12
⑬	VVQ2000-80A-4	Clip	Stainless steel	12