

Series VQ5000

Base Mounted Plug-in Unit

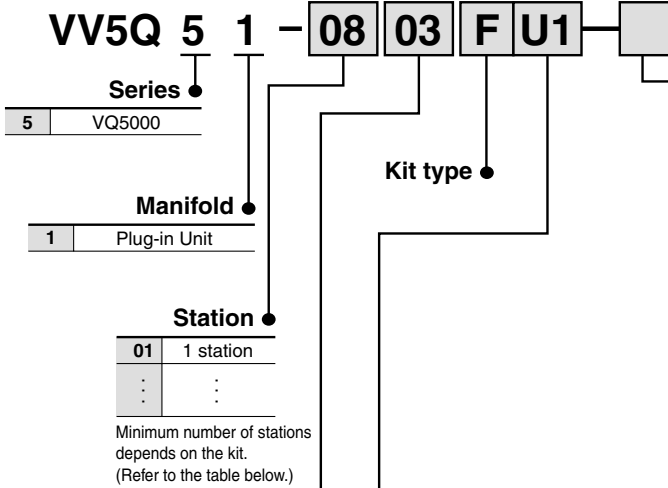

How to Order Manifold



Symbol	Option
Nil	None
CD1 ⁽²⁾	Exhaust cleaner for Rc 1: D side exhaust
CD2 ⁽²⁾	Exhaust cleaner for Rc 1 1/2: D side exhaust
CU1 ⁽²⁾	Exhaust cleaner for Rc 1: U side exhaust
CU2 ⁽²⁾	Exhaust cleaner for Rc 1 1/2: U side exhaust
K ⁽⁴⁾	Special wiring specifications (Except double wiring)
N	Name plate (T kit only)
SB ⁽³⁾	Direct exhaust with silencer box: Exhaust from both D and U sides
SD ⁽²⁾	Direct exhaust with silencer box: D side exhaust
SU ⁽²⁾	Direct exhaust with silencer box: U side exhaust
W	IP65 enclosure (except F and T1 kits)

Note 1) When two or more symbols are specified, indicate them alphabetically.
Example) -CD1K

Note 2) Combination of [CU□] and [SU□] is not possible.

Note 3) Available only with F, L and T1 kits.

Note 4) Specify the wiring specifications on the manifold specification sheet. (Except L kit)

Cylinder port

03	Rc 3/8
04	Rc 1/2
B	Bottom ported Rc 1/2
CM	Mixed ^{Note)}

Note) In case of mixed specification, indicate on the manifold specification sheet.

Kit/Electrical entry/Cable length

F kit
(D-sub connector)

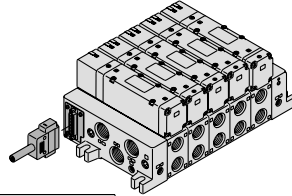

Connector entry direction				1 to 12 stations
D side	U side	Kit	Cable length	
	D0	U0	Without cable	
Kit F	D1	U1	Cable length 1.5 m	
	D2	U2	Cable length 3 m	
	D3	U3	Cable length 5 m	

L kit
(Lead wire cable)

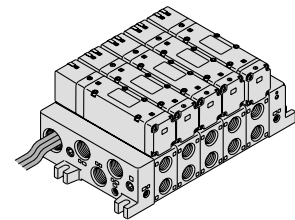

Electrical entry				1 to 12 stations
D side	U side	Kit	Cable length	
	D0	U0	Without cable	IP65 compatible
Kit L	D1	U1	Cable length 0.6 m	
	D2	U2	Cable length 1.5 m	
			Cable length 3 m	

T1 kit
(Individual terminal block kit)

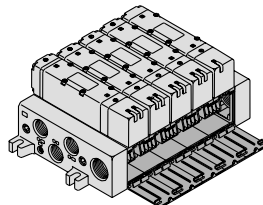

Kit T1	With terminal blocks	1 to 12 stations
--------	----------------------	------------------

T kit
(Terminal block box kit)

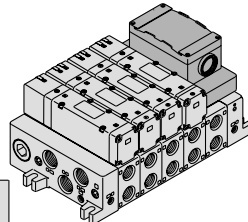

Box mounting position		IP65 compatible
D side	U side	
TD	TU	Terminal block box
		2 to 12 stations

S kit
(Serial transmission unit)

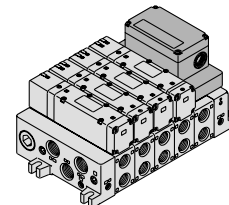

The valve voltage is 24 VDC and it is equipped with light/surge voltage suppressor.
IP65 compatible

Unit mounting position		
D side	U side	
	O	Without SI unit
	A	With general type SI unit (Series EX300)
	B	Mitsubishi Electric Corp.: MELSECNET/MINI-S3 Data Link System
	BB	Mitsubishi Electric Corp.: MELSECNET/MINI-S3 Data Link System (2 power supply systems)
	C	OMRON Corp.: SYSBUS Wire System
	D	SHARP Corp.: Satellite I/O Link System
	F1	NKE Corp.: Uni-wire System (16 output points)
	J1	SUNX Corp.: S-LINK System (16 output points)
	J2	SUNX Corp.: S-LINK System (8 output points)
	K	Fuji Electric Co.: T-LINK Mini System
	Q	DeviceNet, CompoBus/D (OMRON Corp.)
	R1	OMRON Corp.: CompoBus/S System (16 output points)
	R2	OMRON Corp.: CompoBus/S System (8 output points)
	U	JEMANET (JPCN-1)
	V	Mitsubishi Electric Corp.: CC-LINK System
	G	Rockwell Automation: Allen Bradley Remote I/O (RIO) System
	H	NKE Corp.: Uni-wire H System

2 to 12 stations

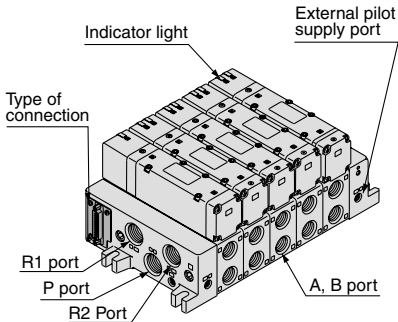

Note) The drawing shows a VV5Q51-0504FDO.

Manifold Specifications

Series	Base model	Type of connection	Porting specifications			Maximum applicable stations	Applicable solenoid valve	5 station weight (kg)
			4(A), 2(B) port location	Port size ^{Note)}				
				1(P), 5(R1), 3(R2)	4(A), 2(B)			
VQ5000	VV5Q51-□□□	<ul style="list-style-type: none"> ■ F kit—D-sub connector ■ T kit—Terminal block box ■ T1 kit—Individual terminal block kit ■ L kit—Lead wire ■ S kit—Serial transmission 	Side Bottom	Rc 3/4 Option (Direct exhaust with silencer box)	Rc 3/8 Rc 1/2 Rc 1/2	F, L, T1 kits 12 stations T kit 11 stations S kit 9 stations	VQ5L00 VQ5L01	4.1 • L kit • Not including solenoid valve weight.

Note) For details about international standard threads other than Rc threads, refer to "Option" on page 2-6-39.

Flow Characteristics at the Number of Manifold Stations (Operated individually)

Model	Passage/Stations		Station 1	Station 5	Station 10
2 position metal seal VQ5 ₂ 00	1 → 4/2 (P → A/B)	C [dm ³ /(s·bar)]	11	11	11
		b	0.24	0.24	0.24
		Cv	2.7	2.7	2.7
	4/2 → 5/3 (A/B → EA/EB)	C [dm ³ /(s·bar)]	12	12	12
		b	0.14	0.14	0.14
		Cv	2.9	2.9	2.9
2 position rubber seal VQ5 ₂ 01	1 → 4/2 (P → A/B)	C [dm ³ /(s·bar)]	12	12	12
		b	0.33	0.33	0.33
		Cv	3.4	3.4	3.4
	4/2 → 5/3 (A/B → EA/EB)	C [dm ³ /(s·bar)]	16	16	16
		b	0.33	0.33	0.33
		Cv	4.4	4.4	4.4

Note) For port size Rc 1/2

Manifold Option

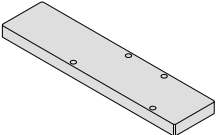
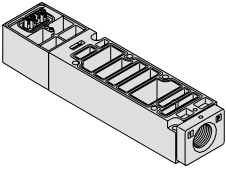
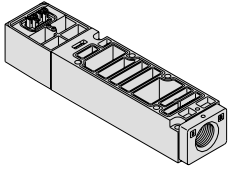
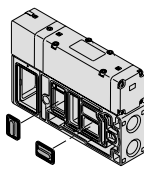
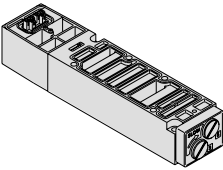
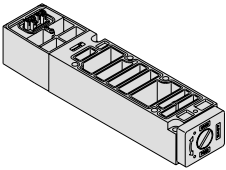
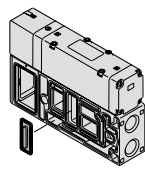
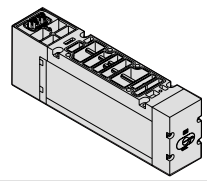
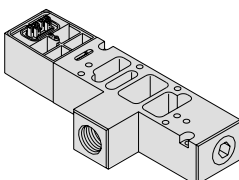
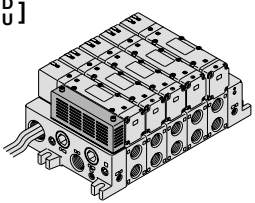
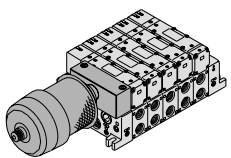
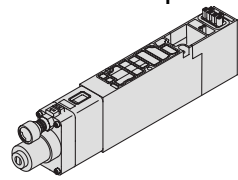
Blanking plate assembly VVQ5000-10A-1 	Individual SUP spacer VVQ5000-P-1- ⁰³ / ₀₄ 	Individual EXH spacer VVQ5000-R-1- ⁰³ / ₀₄ 	EXH block plate VVQ5000-16A-2 
Throttle valve spacer VVQ5000-20A-1 	SUP stop valve spacer VVQ5000-37A-1 	SUP block plate VVQ5000-16A-1 	Double check spacer with residual pressure release valve VVQ5000-25A-1 
Release valve spacer VVQ5000-24A-1D 	Direct exhaust with silencer box [-S _U ^D] 	For exhaust cleaner mounting [-C _U ^D □] 	Interface regulator ARBQ5000-00- ^A / _B -1 

Refer to pages 2-6-34 to 2-6-38 for detailed dimensions of each option.
For replacement parts, refer to page 2-6-43.



VQC

SQ

VQ0

VQ4

VQ5

VQZ

VQD

L Kit (Lead wire cable)

IP65 compliant

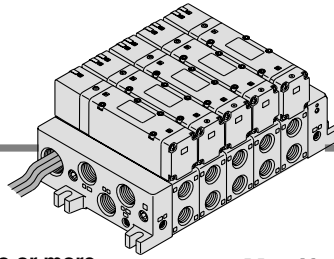

- Enclosure IP65 compliant
- Direct electrical entry type available with two or more stations.
- Electrical entry can be selected on either the U side or the D side according to the mounting orientation.
- Maximum stations are 12.

Manifold Specifications

Series	Porting specifications			Applicable stations
	4(A), 2(B) port location	Port size		
VQ5000	Side	Rc 3/4	4(A), 2(B) Rc 3/8 Rc 1/2	Max. 12 stations
	Bottom		Rc 1/2	

Wiring Specifications

Three lead wires are attached to each station regardless of the type of valve which is mounted. The red wire is for COM connection.

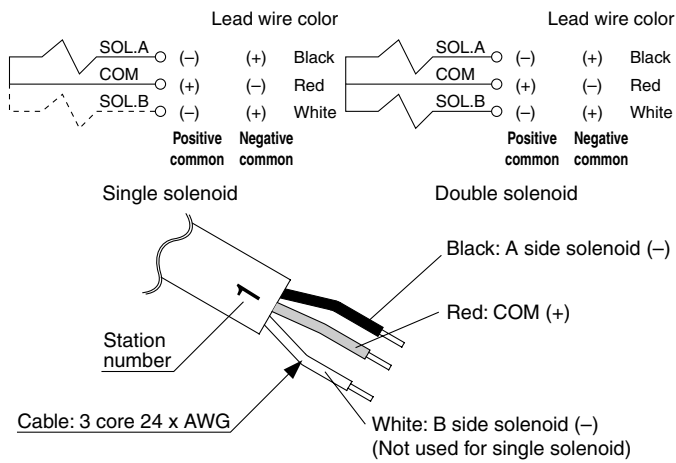

Lead Wire Assembly with Connector

Lead wire length	Part no.
0.6 m	VVQ5000-44A-8-□
1.5 m	VVQ5000-44A-15-□
3 m	VVQ5000-44A-30-□

□: Number of stations 1 to 12

For different lead wire lengths, order a lead wire assembly with connector shown in the table on the right. Note) There is no polarity. It can also be used as a negative common.

How to Order Manifold

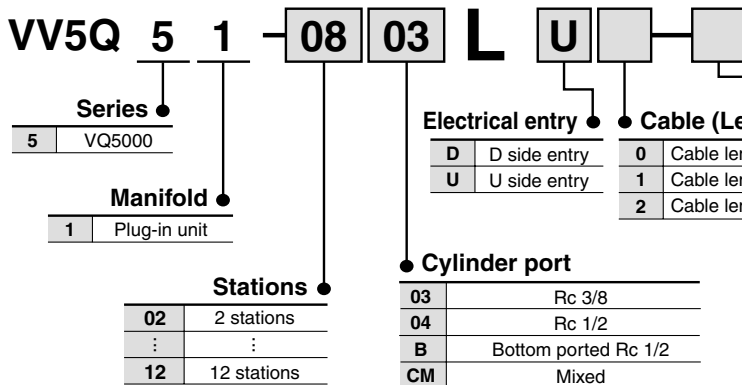

Option

Symbol	Option
Nil	None
CD1 ^{Note)}	Exhaust cleaner for Rc 1: D side exhaust
CD2 ^{Note)}	Exhaust cleaner for Rc 1 1/2: D side exhaust
CU1 ^{Note)}	Exhaust cleaner for Rc 1: U side exhaust
CU2 ^{Note)}	Exhaust cleaner for Rc 1 1/2: U side exhaust
SB	Direct exhaust with silencer box: Exhaust from both U and D sides
SD ^{Note)}	Direct exhaust with silencer box: D side exhaust
SU ^{Note)}	Direct exhaust with silencer box: U side exhaust
W	IP65 enclosure

Note) Combination of [C□□] and [S□□] is not possible.

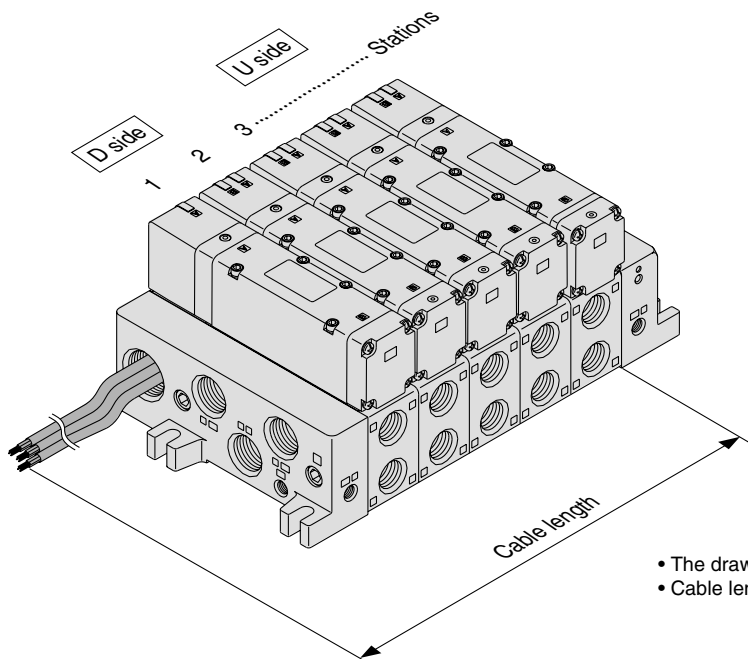

- The drawing shows the electrical entry on the D side.
- Cable length is measured from the solenoid valve body.

- VQC
- SQ
- VQ0
- VQ4
- VQ5**
- VQZ
- VQD

How to Order Valves

VQ 5 1 0 0 — **5** — — — —

Series

5	VQ5000
---	--------

Type of actuation

1	2 position single
2	2 position double
3	3 position closed center
4	3 position exhaust center
5	3 position pressure center
6	3 position double check

Seal

0	Metal seal
1	Rubber seal

Enclosure

Nil	Dusttight
W	Dusttight/Low jetproof type(IP65)

Manual override

Nil	Non-locking push type (Tool required)
B	Locking type (Tool required)

Light/Surge voltage suppressor

Nil	Yes
E	Without light, with surge voltage suppressor

Coil voltage

1	100 VAC (50/60 Hz)
2	200 VAC (50/60 Hz)
3	110 VAC (50/60 Hz)
4	220 VAC (50/60 Hz)
5	24 VDC
6	12 VDC

Function

Nil	Standard type (1 W)
Y ⁽¹⁾	Low wattage type (0.5 W)
R ⁽²⁾	External pilot

Note 1) Applicable to DC specification.
 Note 2) Refer to page 2-6-39 for details on external pilot specifications.
 Note 3) When two or more symbols are specified, indicate them alphabetically.

How to Order Manifold Assembly

Specify the part numbers for valves and options together beneath the manifold base part number.

<Example>

Lead wire kit with cable (3 m)

- VV5Q51-0503LD2 ...1 set—Manifold base part no.
- *VQ5100-52 sets—Valve part no. (Stations 1 and 2)
- *VQ5200-52 sets—Valve part no. (Stations 3 and 4)
- *VQ5300-51 set—Valve part no. (Station 5)

Prefix the asterisk to the part nos. of the solenoid valve, etc.

Enter in order starting from the first station on the D side. When entry of part numbers becomes complicated, indicate in the manifold specification sheet.

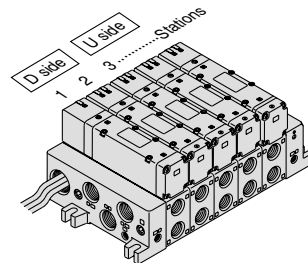

L Kit (Lead wire cable)

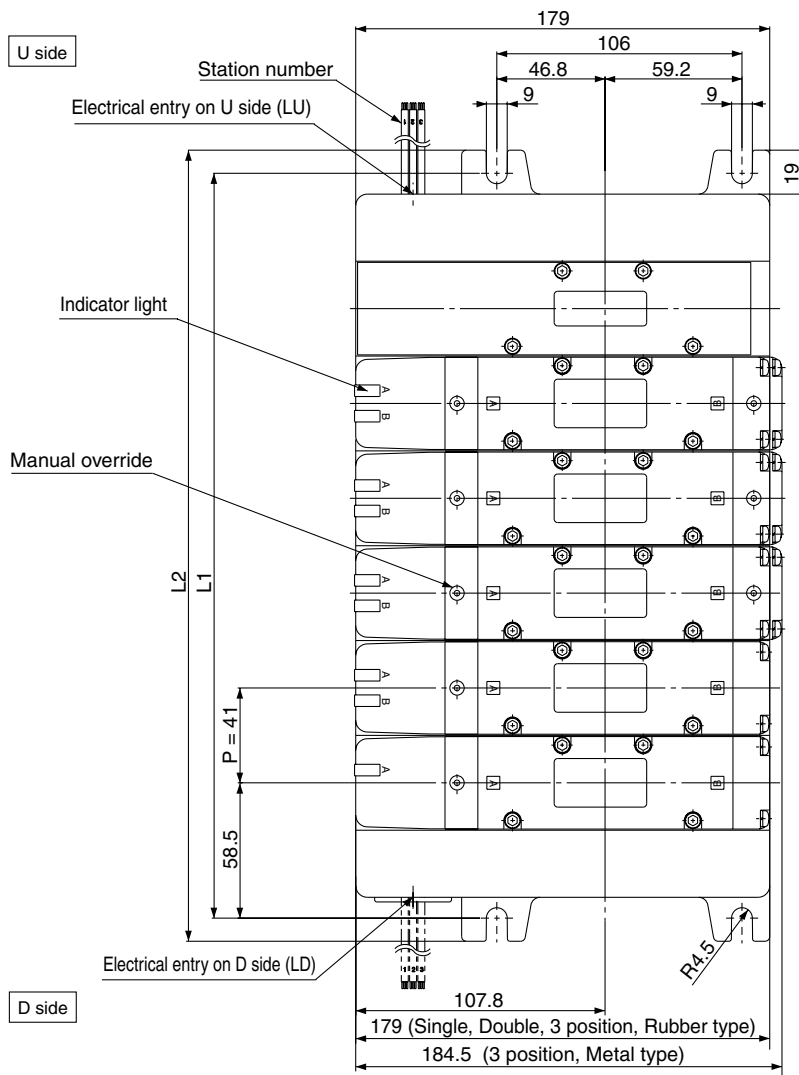
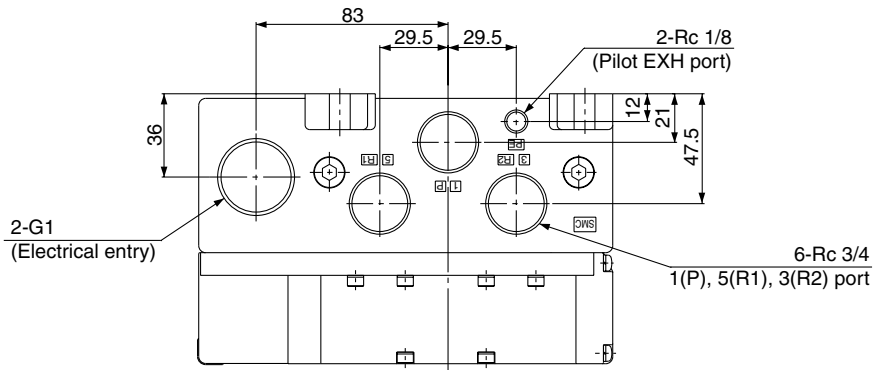

Cable length
 L₀: 600 mm
 L₁: 1500 mm
 L₂: 3000 mm

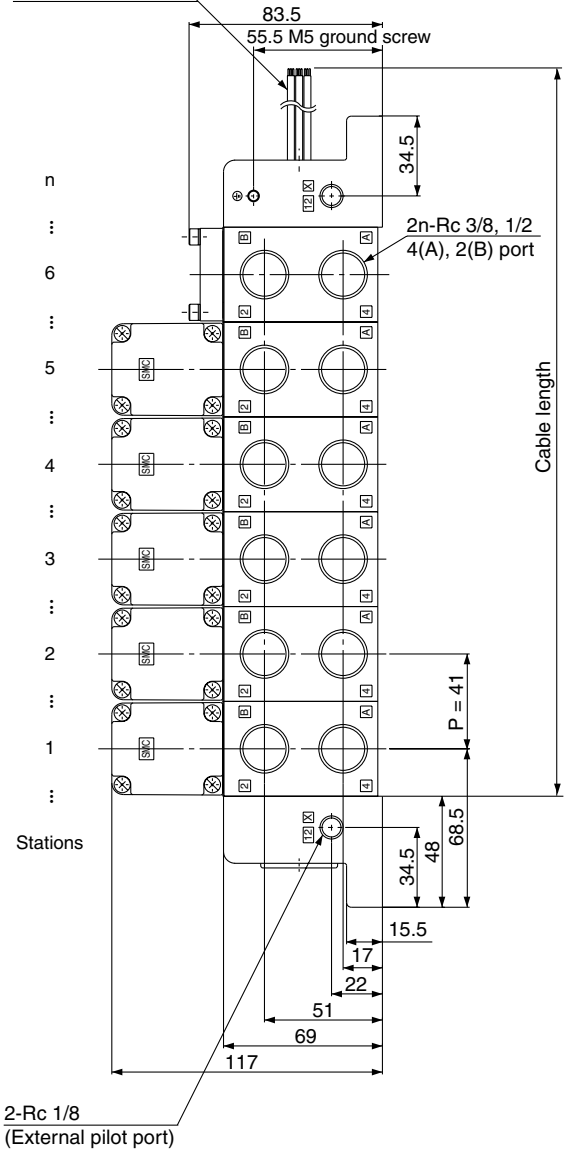

Bottom ported drawing

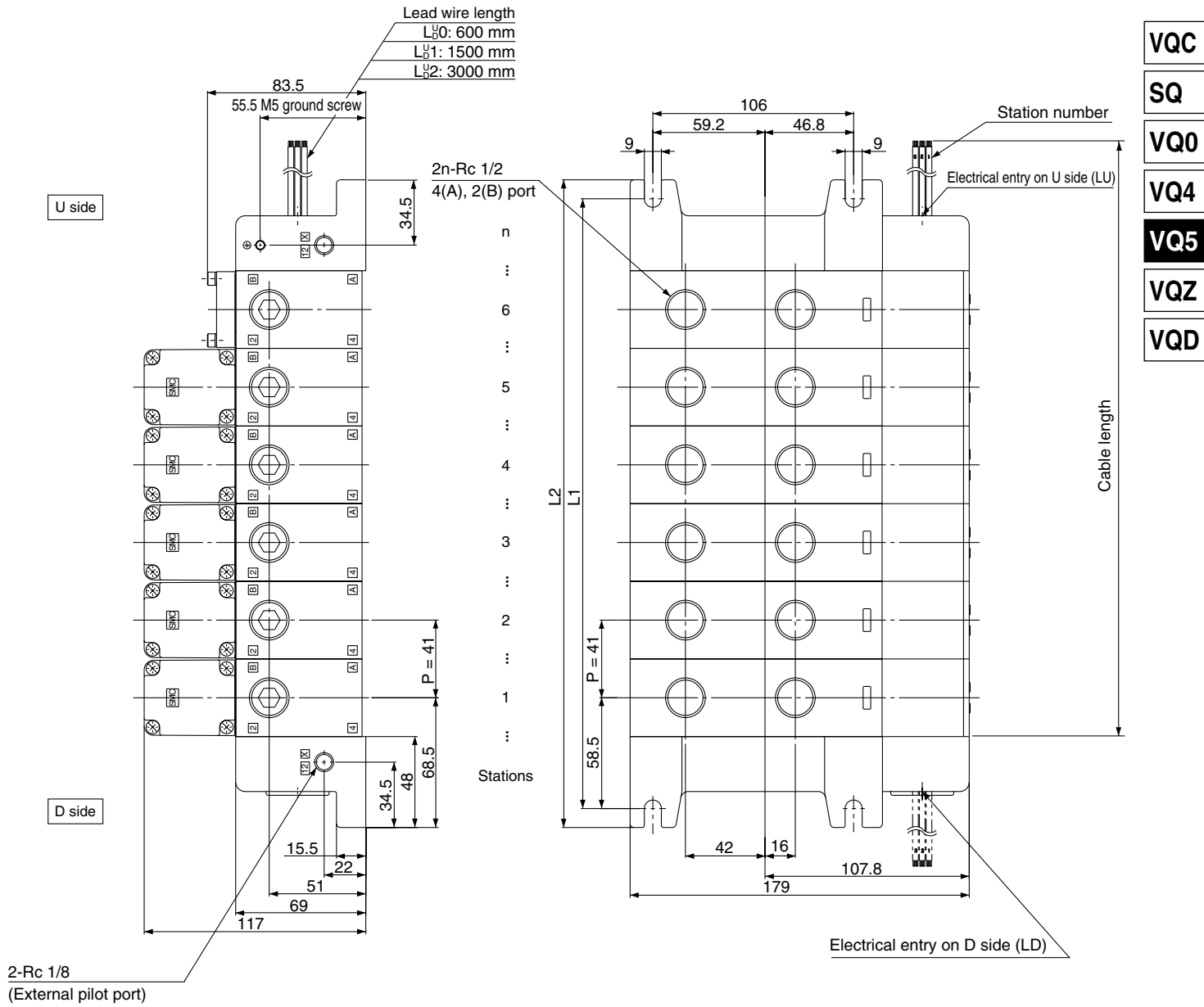

- VQC
- SQ
- VQ0
- VQ4
- VQ5**
- VQZ
- VQD

Formula: $L_1 = 41n + 76$, $L_2 = 41n + 96$
 n: Stations (Maximum 12 stations)

Dimensions

L \ n	1	2	3	4	5	6	7	8	9	10	11	12
L1	117	158	199	240	281	322	363	404	445	486	527	568
L2	137	178	219	260	301	342	383	424	465	506	547	588