

Series VQC2000 Base Mounted Plug-in Unit

How to Order Manifold

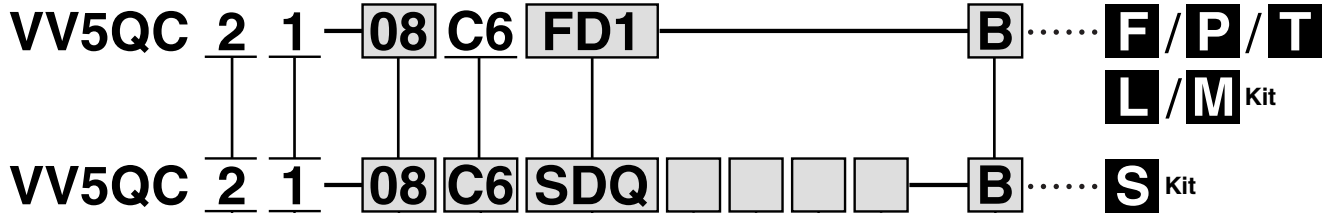

Series
2 VQC2000

Manifold model
1 Plug-in unit

Stations
01 1 station
: :
The maximum number of stations differs depending on the electrical entry.

Cylinder port size

C4	With ø4 One-touch fitting
C6	With ø6 One-touch fitting
C8	With ø8 One-touch fitting
CM	Mixed sizes and with port plug
L4	Top ported elbow With ø4 One-touch fitting
L6	Top ported elbow With ø6 One-touch fitting
L8	Top ported elbow With ø8 One-touch fitting
B4	Bottom ported elbow With ø4 One-touch fitting
B6	Bottom ported elbow With ø6 One-touch fitting
B8	Bottom ported elbow With ø8 One-touch fitting
LM	Elbow port, mixed sizes

Note 1) Indicate the size in the specification sheet in the case of "CM" and "LM".
Note 2) Symbols for inch sizes are as follows:
<For One-touch fittings>
N3: ø5/32"
N7: ø1/4"
N9: ø5/16"
NM: Mixed
The top ported elbow is LN□ and the bottom ported elbow is BN□.

Kit designation/Electrical entry/Cable length
(Refer to page 2-2-16 for detailed information on kits.)

Option

Nil	None
B	All stations with back pressure check valve Note 1)
D	With DIN rail (Rail length: Standard)
D□	With DIN rail (Rail length: Special) Note 2)
K	Special wiring specifications Note 3)
N	With name plate
R	External pilot Note 4)
S	Direct exhaust with built-in silencer Note 5)
T	Branched P and R ports on U side Note 6)

* When specifying more than one option, enter symbols in alphabetical order.
Example: -BRS
Note 1) When using the back pressure check valve for the necessary stations only, enter the back pressure check valve part no. and indicate the number of manifold stations on the specification sheet.
Note 2) For special DIN rail length, indicate "D□". (Enter the number of stations inside □.)
Example: -D08
In this case, stations will be mounted on a DIN rail for 8 stations regardless of the actual number of manifold stations. The specified number of stations must be larger than the number of stations on the manifold.
Indicate "-D0" for the option without DIN rail.
Note 3) Be sure to indicate the wiring specifications on the specification sheet.
Note 4) For external pilot option, "-R", indicate the external pilot specification "R" for the applicable valves as well.
Note 5) The built-in silencer type does not satisfy the IP67 standard.
Note 6) The SUP and EXH ports on U side are branched (toward the cylinder port and coil) with ø12 one-touch fittings for connection.

SI unit COM.

SI unit COM	EX250					EX500				EX126
	DeviceNet	PROFIBUS-DP	CC-LINK	AS-i	CANopen	DeviceNet	PROFIBUS-DP	CC-LINK	Remote I/O	CC-LINK
Nil	+COM	—	—	○	—	○	○	○	○	○
N	-COM	○	○	—	○	○	○	○	○	—

Note) Leave the box blank for the SI unit COM without SI unit (SD0).

Input block COM.
(Fill out for I/O unit only)

Nil	PNP (+) or without SI unit/input block
N	NPN (-)

Number of input blocks
(Fill out for I/O unit only)

Nil	Without SI unit/input block (SD0)
0	Without input block
1	With 1 input block
:	:
8	With 8 input blocks

Input block type
(Fill out for I/O unit only)

Nil	Without input block
1	M12, 2 inputs
2	M12, 4 inputs
3	M8, 4 inputs (3 pins)

- VQC
- SQ
- VQ0
- VQ4
- VQ5
- VQZ
- VQD

How to Order Valves

VQC 2 1 0 0 5

Series
2 VQC2000

Type of actuation

1	2 position single (A)(B) 4 2 5 1 3 (R1)(P)(R2)	A Note)	4 position dual 3 port valve (A) (A) (B) 4 4 2 5 1 3 (R1) (P) (R2) N.C (P) N.C
	2 position double (metal) (A)(B) 4 2 5 1 3 (R1)(P)(R2)	B Note)	4 position dual 3 port valve (B) (A) (B) 4 4 2 5 1 3 (R1) (P) (R2) N.O (P) N.O
2	2 position double (rubber) (A)(B) 4 2 5 1 3 (R1)(P)(R2)	C Note)	4 position dual 3 port valve (C) (A) (B) 4 4 2 5 1 3 (R1) (P) (R2) N.C (P) N.O
	3 position closed center (A)(B) 4 2 5 1 3 (R1)(P)(R2)	Note) For rubber seal type only.	
3	3 position exhaust center (A)(B) 4 2 5 1 3 (R1)(P)(R2)		
4	3 position pressure center (A)(B) 4 2 5 1 3 (R1)(P)(R2)		
5			

Manual override

Nil: Non-locking push type (Slotted)
B: Locking type (Slotted)
C: Locking type (Manual)
D: Slide locking type (Manual)

Light/Surge voltage suppressor

Nil	With
E	Without Note)

Note) Not applicable to S kit.

Coil voltage

5	24 VDC Note)
6	12 VDC

Note) S kit is only available for 24 VDC.

Function

Nil	Standard type (1 W)
K Note 1)	High pressure type (1.0 MPa)
N	Negative COM
R Note 2)	External pilot
Y	Low wattage type (0.5 W)

* When specifying more than one option, enter symbols in alphabetical order.
Note 1) For metal seal type only.
Note 2) Not applicable for dual 3 port valve.

Seal type

0	Metal seal
1	Rubber seal

Kit Designation/Electrical Entry/Cable Length

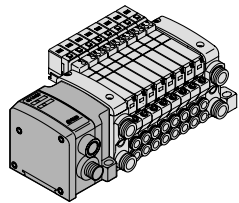
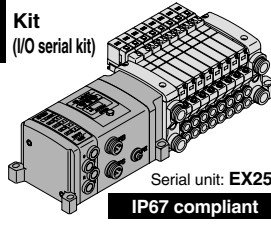
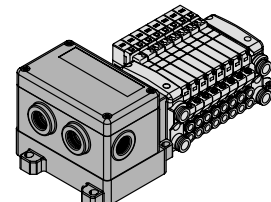
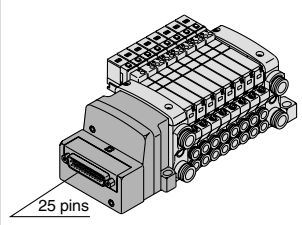
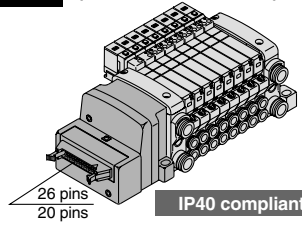
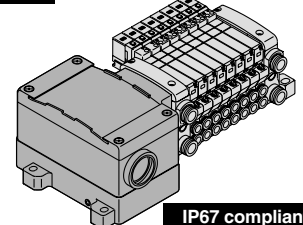
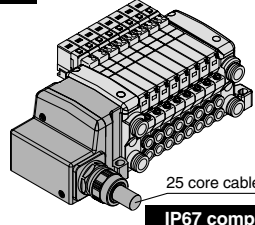
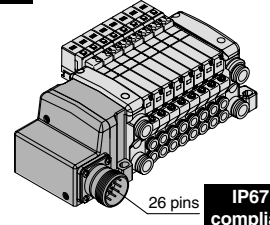
<p>S Kit (Decentralized wiring type serial kit)</p>  <p>Serial unit: EX500 IP67 compliant</p> <p>Note) A separate gateway unit and communication cable are required.</p> <table border="1"> <tr> <td>SD0</td> <td>Serial kit without SI unit</td> <td></td> </tr> <tr> <td>SDA1</td> <td>Serial kit for Remote I/O</td> <td>1 to 8 stations (16 stations)</td> </tr> <tr> <td>SDA2</td> <td>Serial kit for DeviceNet/PROFIBUS-DP/CC-LINK</td> <td></td> </tr> </table>	SD0	Serial kit without SI unit		SDA1	Serial kit for Remote I/O	1 to 8 stations (16 stations)	SDA2	Serial kit for DeviceNet/PROFIBUS-DP/CC-LINK		<p>S Kit (I/O serial kit)</p>  <p>Serial unit: EX250 IP67 compliant</p> <table border="1"> <tr> <td>SD0</td> <td>Serial kit without SI unit</td> <td></td> </tr> <tr> <td>SDY</td> <td>Serial kit for CANopen</td> <td></td> </tr> <tr> <td>SDQ</td> <td>Serial kit for DeviceNet</td> <td>1 to 12 stations (24 stations)</td> </tr> <tr> <td>SDN</td> <td>Serial kit for PROFIBUS-DP</td> <td></td> </tr> <tr> <td>SDV</td> <td>Serial kit for CC-LINK</td> <td></td> </tr> <tr> <td>SDTA</td> <td>AS-4, 8 in/out, 31 slave modes, 2 power supply systems</td> <td>1 to 4 stations (8 stations)</td> </tr> <tr> <td>SDTB</td> <td>AS-4, 4 in/out, 31 slave modes, 2 power supply systems</td> <td>1 to 2 stations (4 stations)</td> </tr> <tr> <td>SDTC</td> <td>AS-4, 8 in/out, 31 slave modes, 1 power supply systems</td> <td>1 to 4 stations (8 stations)</td> </tr> <tr> <td>SDTD</td> <td>AS-4, 4 in/out, 31 slave modes, 1 power supply systems</td> <td>1 to 2 stations (4 stations)</td> </tr> </table>	SD0	Serial kit without SI unit		SDY	Serial kit for CANopen		SDQ	Serial kit for DeviceNet	1 to 12 stations (24 stations)	SDN	Serial kit for PROFIBUS-DP		SDV	Serial kit for CC-LINK		SDTA	AS-4, 8 in/out, 31 slave modes, 2 power supply systems	1 to 4 stations (8 stations)	SDTB	AS-4, 4 in/out, 31 slave modes, 2 power supply systems	1 to 2 stations (4 stations)	SDTC	AS-4, 8 in/out, 31 slave modes, 1 power supply systems	1 to 4 stations (8 stations)	SDTD	AS-4, 4 in/out, 31 slave modes, 1 power supply systems	1 to 2 stations (4 stations)	<p>S Kit (Serial output kit)</p>  <p>Serial unit: EX126 IP67 compliant</p> <table border="1"> <tr> <td>SDVB</td> <td>Serial kit for CC-LINK</td> <td>1 to 8 stations (16 stations)</td> </tr> </table>	SDVB	Serial kit for CC-LINK	1 to 8 stations (16 stations)	<p>F Kit (D-sub connector kit)</p>  <p>25 pins</p> <p>IP40 compliant</p> <table border="1"> <tr> <td>FD0</td> <td>D-sub connector kit (25P) without cable</td> <td></td> </tr> <tr> <td>FD1</td> <td>D-sub connector kit (25P) with 1.5 m cable</td> <td>1 to 12 stations (24 stations)</td> </tr> <tr> <td>FD2</td> <td>D-sub connector kit (25P) with 3.0 m cable</td> <td></td> </tr> <tr> <td>FD3</td> <td>D-sub connector kit (25P) with 5.0 m cable</td> <td></td> </tr> </table>	FD0	D-sub connector kit (25P) without cable		FD1	D-sub connector kit (25P) with 1.5 m cable	1 to 12 stations (24 stations)	FD2	D-sub connector kit (25P) with 3.0 m cable		FD3	D-sub connector kit (25P) with 5.0 m cable	
SD0	Serial kit without SI unit																																																					
SDA1	Serial kit for Remote I/O	1 to 8 stations (16 stations)																																																				
SDA2	Serial kit for DeviceNet/PROFIBUS-DP/CC-LINK																																																					
SD0	Serial kit without SI unit																																																					
SDY	Serial kit for CANopen																																																					
SDQ	Serial kit for DeviceNet	1 to 12 stations (24 stations)																																																				
SDN	Serial kit for PROFIBUS-DP																																																					
SDV	Serial kit for CC-LINK																																																					
SDTA	AS-4, 8 in/out, 31 slave modes, 2 power supply systems	1 to 4 stations (8 stations)																																																				
SDTB	AS-4, 4 in/out, 31 slave modes, 2 power supply systems	1 to 2 stations (4 stations)																																																				
SDTC	AS-4, 8 in/out, 31 slave modes, 1 power supply systems	1 to 4 stations (8 stations)																																																				
SDTD	AS-4, 4 in/out, 31 slave modes, 1 power supply systems	1 to 2 stations (4 stations)																																																				
SDVB	Serial kit for CC-LINK	1 to 8 stations (16 stations)																																																				
FD0	D-sub connector kit (25P) without cable																																																					
FD1	D-sub connector kit (25P) with 1.5 m cable	1 to 12 stations (24 stations)																																																				
FD2	D-sub connector kit (25P) with 3.0 m cable																																																					
FD3	D-sub connector kit (25P) with 5.0 m cable																																																					
<p>P Kit (Flat ribbon cable kit)</p>  <p>26 pins 20 pins</p> <p>Note) For a 20P flat ribbon cable, the cable assembly must be ordered separately.</p> <table border="1"> <tr> <td>PD0</td> <td>Flat ribbon cable kit (26P) without cable</td> <td></td> </tr> <tr> <td>PD1</td> <td>Flat ribbon cable kit (26P) with 1.5 m cable</td> <td>1 to 12 stations (24 stations)</td> </tr> <tr> <td>PD2</td> <td>Flat ribbon cable kit (26P) with 3.0 m cable</td> <td></td> </tr> <tr> <td>PD3</td> <td>Flat ribbon cable kit (26P) with 5.0 m cable</td> <td></td> </tr> <tr> <td>PDC</td> <td>Flat ribbon cable kit (20P) without cable</td> <td>1 to 9 stations (18 stations)</td> </tr> </table>	PD0	Flat ribbon cable kit (26P) without cable		PD1	Flat ribbon cable kit (26P) with 1.5 m cable	1 to 12 stations (24 stations)	PD2	Flat ribbon cable kit (26P) with 3.0 m cable		PD3	Flat ribbon cable kit (26P) with 5.0 m cable		PDC	Flat ribbon cable kit (20P) without cable	1 to 9 stations (18 stations)	<p>T Kit (Terminal block box kit)</p>  <p>IP67 compliant</p> <table border="1"> <tr> <td>TD0</td> <td>Terminal block box kit</td> <td>1 to 10 stations (20 stations)</td> </tr> </table>	TD0	Terminal block box kit	1 to 10 stations (20 stations)	<p>L Kit (Lead wire kit)</p>  <p>25 core cable</p> <p>IP67 compliant</p> <table border="1"> <tr> <td>LD0</td> <td>Lead wire kit (25 core) 0.6 m lead wire</td> <td></td> </tr> <tr> <td>LD1</td> <td>Lead wire kit (25 core) 1.5 m lead wire</td> <td>1 to 12 stations (24 stations)</td> </tr> <tr> <td>LD2</td> <td>Lead wire kit (25 core) 3.0 m lead wire</td> <td></td> </tr> </table>	LD0	Lead wire kit (25 core) 0.6 m lead wire		LD1	Lead wire kit (25 core) 1.5 m lead wire	1 to 12 stations (24 stations)	LD2	Lead wire kit (25 core) 3.0 m lead wire		<p>M Kit (Multiple connector kit)</p>  <p>26 pins</p> <p>IP67 compliant</p> <table border="1"> <tr> <td>MD0</td> <td>Multiple connector kit (26P) without cable</td> <td></td> </tr> <tr> <td>MD1</td> <td>Multiple connector kit (26P) with 1.5 m cable</td> <td>1 to 12 stations (24 stations)</td> </tr> <tr> <td>MD2</td> <td>Multiple connector kit (26P) with 3.0 m cable</td> <td></td> </tr> <tr> <td>MD3</td> <td>Multiple connector kit (26P) with 5.0 m cable</td> <td></td> </tr> </table>	MD0	Multiple connector kit (26P) without cable		MD1	Multiple connector kit (26P) with 1.5 m cable	1 to 12 stations (24 stations)	MD2	Multiple connector kit (26P) with 3.0 m cable		MD3	Multiple connector kit (26P) with 5.0 m cable													
PD0	Flat ribbon cable kit (26P) without cable																																																					
PD1	Flat ribbon cable kit (26P) with 1.5 m cable	1 to 12 stations (24 stations)																																																				
PD2	Flat ribbon cable kit (26P) with 3.0 m cable																																																					
PD3	Flat ribbon cable kit (26P) with 5.0 m cable																																																					
PDC	Flat ribbon cable kit (20P) without cable	1 to 9 stations (18 stations)																																																				
TD0	Terminal block box kit	1 to 10 stations (20 stations)																																																				
LD0	Lead wire kit (25 core) 0.6 m lead wire																																																					
LD1	Lead wire kit (25 core) 1.5 m lead wire	1 to 12 stations (24 stations)																																																				
LD2	Lead wire kit (25 core) 3.0 m lead wire																																																					
MD0	Multiple connector kit (26P) without cable																																																					
MD1	Multiple connector kit (26P) with 1.5 m cable	1 to 12 stations (24 stations)																																																				
MD2	Multiple connector kit (26P) with 3.0 m cable																																																					
MD3	Multiple connector kit (26P) with 5.0 m cable																																																					

Manifold Option

Blanking plate assembly
VVQ2000-10A-1

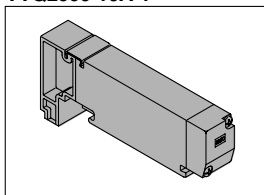

SUP block plate
VVQ2000-16A

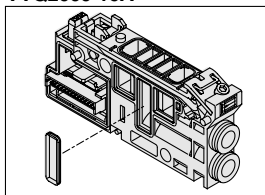

Perfect block
VVQ2000-FPG-□□

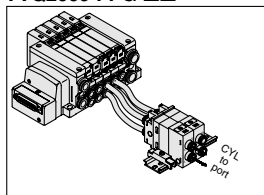

Dual flow fitting assembly
VVQ2000-52A-C10

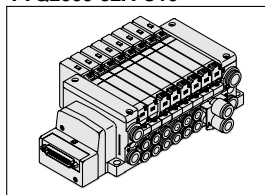

Individual SUP spacer
VVQ2000-P-1-C8

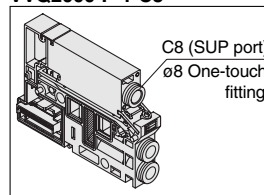

Elbow fitting assembly
VVQ2000-F-L□

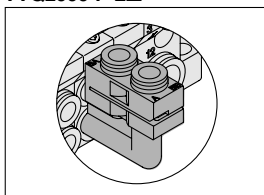

Port plug
VVQ1000-58A

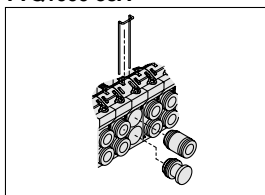

Individual EXH spacer
VVQ2000-R-1-C8

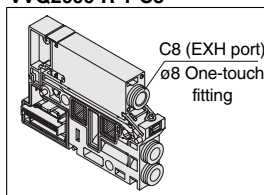

EXH block plate
VVQ2000-19A

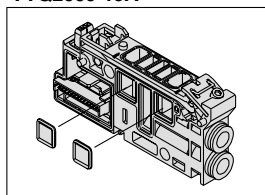

Electrical wiring specifications [-K]

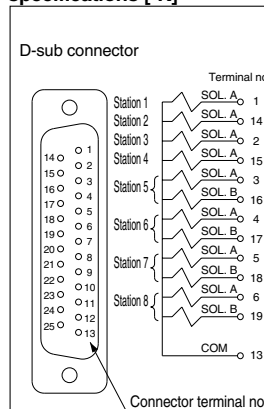

DIN rail mounting bracket [-D]
VVQ2000-57A

for (F, L, M, P, S (EX500) kit)

VVQ2000-57A-S

for (S (EX250) kit)

VVQ2000-57A-T

for (T, S (EX126) kit)

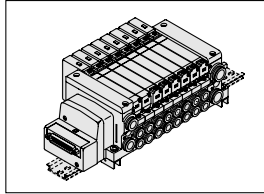

Silencer (for EXH port)
AN200-KM10

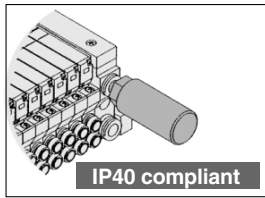

Back pressure check valve assembly [-B]
VVQ2000-18A

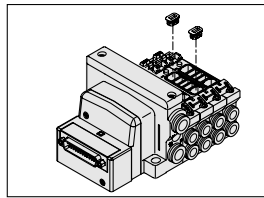

Name plate [-N]
VVQ2000-N-Stations

(1 to max. no. of stations)

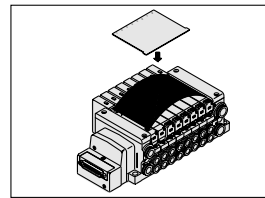

Direct EXH outlet with built-in silencer [-S]

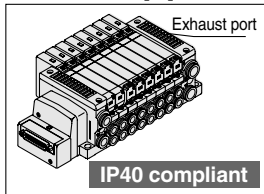

Blanking plug
KQ2P-□

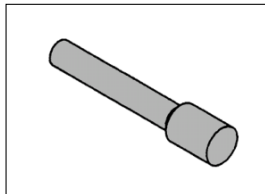

VQC

SQ

VQ0

VQ4

VQ5

VQZ

VQD

Standard manifolds are for double wiring, but mixed wiring (single and double wiring) can be specified as options.

Series VQC

Base Mounted

Plug-in Unit



JIS Symbol

2 position single

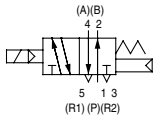

2 position double (metal)

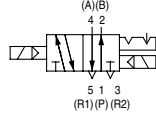

2 position double (rubber)

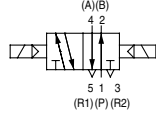

3 position closed center

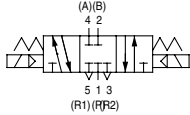

3 position exhaust center

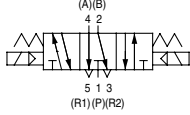

3 position pressure center

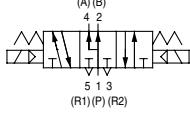

3 position exhaust center with pressure release valves

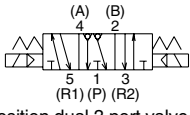

4 position dual 3 port valve (A)

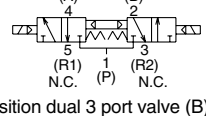

4 position dual 3 port valve (B)

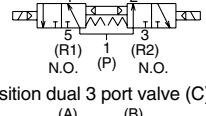

4 position dual 3 port valve (C)

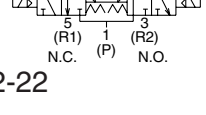

2-2-22

Model

Series	No. of solenoids	Model	Flow characteristics						Response time (ms) ^{Note 2)}		Weight (g)			
			1 → 4, 2 (P → A, B)			4, 2 → 5, 3 (A, B → R1, R2)			Standard: 1 W	Low wattage				
			C[dm ³ /(s·bar)]	b	Cv	C[dm ³ /(s·bar)]	b	Cv						
VQC1000	2 position	Single	Metal seal	VQC1100	0.70	0.15	0.16	0.72	0.25	0.18	12 or less	15 or less	64	
			Rubber seal	VQC1101	0.85	0.20	0.21	1.0	0.30	0.25	15 or less	20 or less		
		Double	Metal seal	VQC1200	0.70	0.15	0.16	0.72	0.25	0.18	10 or less	13 or less		
			Rubber seal	VQC1201	0.85	0.20	0.21	1.0	0.30	0.25	15 or less	20 or less		
	3 position	Closed center	Metal seal	VQC1300	0.68	0.15	0.16	0.72	0.25	0.18	20 or less	26 or less		78
			Rubber seal	VQC1301	0.70	0.20	0.16	0.65	0.42	0.18	25 or less	33 or less		
		Exhaust center	Metal seal	VQC1400	0.68	0.15	0.16	0.72	0.25	0.18	20 or less	26 or less		
			Rubber seal	VQC1401	0.70	0.20	0.16	1.0	0.30	0.25	25 or less	33 or less		
		Pressure center	Metal seal	VQC1500	0.70	0.15	0.16	0.72	0.25	0.18	20 or less	26 or less		
			Rubber seal	VQC1501	0.85	0.20	0.21	0.65	0.42	0.18	25 or less	33 or less		
4 position	Dual 3 port valve	Rubber seal	VQC1 ^A _C 01	0.70	0.20	0.16	0.70	0.20	0.16	25 or less	33 or less			
VQC2000	2 position	Single	Metal seal	VQC2100	2.0	0.15	0.46	2.6	0.15	0.60	22 or less	29 or less	90	
			Rubber seal	VQC2101	2.2	0.28	0.55	3.2	0.30	0.80	24 or less	31 or less		
		Double	Metal seal	VQC2200	2.0	0.15	0.46	2.6	0.15	0.60	15 or less	20 or less		
			Rubber seal	VQC2201	2.2	0.28	0.55	3.2	0.30	0.80	20 or less	26 or less		
	3 position	Closed center	Metal seal	VQC2300	2.0	0.15	0.46	2.0	0.18	0.46	29 or less	38 or less		110
			Rubber seal	VQC2301	2.0	0.28	0.49	2.2	0.31	0.60	34 or less	44 or less		
		Exhaust center	Metal seal	VQC2400	2.0	0.15	0.46	2.6	0.15	0.60	29 or less	38 or less		
			Rubber seal	VQC2401	2.0	0.28	0.49	3.2	0.30	0.80	34 or less	44 or less		
		Pressure center	Metal seal	VQC2500	2.4	0.17	0.57	2.0	0.18	0.46	29 or less	38 or less		
			Rubber seal	VQC2501	3.2	0.28	0.80	2.2	0.31	0.60	34 or less	44 or less		
4 position	Dual 3 port valve	Rubber seal	VQC2 ^A _C 01	1.8	0.28	0.46	1.8	0.28	0.46	34 or less	44 or less			
VQC4000	2 position	Single	Metal seal	VQC4100	6.2	0.19	1.5	6.9	0.17	1.7	20 or less	22 or less	230	
			Rubber seal	VQC4101	7.2	0.43	2.1	7.3	0.38	2.0	25 or less	27 or less		
		Double	Metal seal	VQC4200	6.2	0.19	1.5	6.9	0.17	1.7	12 or less	12 or less		
			Rubber seal	VQC4201	7.2	0.43	2.1	7.3	0.38	2.0	15 or less	15 or less		
	3 position	Closed center	Metal seal	VQC4300	5.9	0.23	1.5	6.3	0.18	1.6	45 or less	47 or less	280	
			Rubber seal	VQC4301	7.0	0.34	1.9	6.4	0.42	1.9	50 or less	52 or less		
		Exhaust center	Metal seal	VQC4400	6.2	0.18	1.5	6.9	0.17	1.7	45 or less	47 or less		
			Rubber seal	VQC4401	7.0	0.38	1.9	7.3	0.38	2.0	50 or less	52 or less		
		Pressure center	Metal seal	VQC4500	6.2	0.18	1.9	6.4	0.18	1.6	45 or less	47 or less		
			Rubber seal	VQC4501	7.0	0.38	1.9	7.1	0.38	2.0	50 or less	52 or less		
Perfect	Metal seal	VQC4600	2.7	—	—	3.7	—	—	55 or less	57 or less	500			
	Rubber seal	VQC4601	2.8	—	—	3.9	—	—	62 or less	64 or less				



Note 1) Values represented in this column are in the following conditions:

VQC1000: Cylinder port size C6 without a back pressure check valve

VQC2000: Cylinder port size C8 without a back pressure check valve

VQC4000: Cylinder port size Rc 3/8

Note 2) Values represented in this column are based on JIS B 8375-1981 (operating with clean air and a supply pressure of 0.5 MPa. Equipped with light/surge voltage suppressor. Values vary depending on the pressure as well as the air quality.) Values for double types are when the switch is ON.

Standard Specifications

Valve Configuration		Metal seal	Rubber seal		
Fluid		Air/Inert gas			
Valve specifications	VQC1000/2000	Max. operating pressure			
		0.7 MPa (High pressure type: 1.0 MPa) ^{Note 4)}			
		Min. operating pressure	Single	0.1 MPa	0.15 MPa
			Double	0.1 MPa	
			3 position	0.1 MPa	0.2 MPa
	4 position		—	0.15 MPa	
	VQC4000	Max. operating pressure ^{Note 3)}		1.0 MPa (0.7 MPa)	
		Min. operating pressure	Single	0.15 MPa	0.2 MPa
			Double	0.15 MPa	
	3 position	0.15 MPa	0.2 MPa		
Proof pressure		1.5 MPa			
Ambient and fluid temperature		-10 to 50°C ^{Note 1)}			
Lubrication		Not required			
Manual override		Push type/Locking type (tool required)/Locking type (Manual override) ^{Note 5)} /Slide locking type ^{Note 5)}			
Impact resistance/Vibration resistance		150/30 m/s ² ^{Note 2)}			
Enclosure		Dust proof (IP67 compliant)			
Electrical specifications	Rated coil voltage		24 VDC		
	Allowable voltage fluctuation		±10% of rated voltage		
	Coil insulation type		Equivalent to B type		
	Power consumption (Current)	24 VDC	1 W DC (42 mA), 0.5 W DC (21 mA)		
		12 VDC	1 W DC (83 mA), 0.5 W DC (42 mA)		

- VQC
- SQ
- VQ0
- VQ4
- VQ5
- VQZ
- VQD

Note 1) Use dry air to prevent condensation at low temperatures.
 Note 2) **Impact resistance:** No malfunction resulted from the impact test using a drop impact tester. The test was performed one time each in the axial and right angle directions of the main valve and armature, for both energized and de-energized states.
Vibration resistance: No malfunction occurred in a one-sweep test between 45 and 2000Hz. Test was performed in the axial and right angle directions of the main valve and armature for both energized and de-energized states.
 Note 3) Values in () are for the low wattage (0.5 W) specification.
 Note 4) Metal seal type only.
 Note 5) Only for VQC1000/2000.

Manifold Specifications

Series	Base model	Connection type	Piping specifications		Applicable stations ^{Note 2)}	Applicable solenoid valves	5 station weight (g)
			Port direction	Port size ^{Note 1)}			
VQC1000	VV5QC11-□□□	<ul style="list-style-type: none"> ■ F Kit: D-sub connector ■ P Kit: Flat cable ■ T Kit: Terminal block box ■ S Kit: Serial transmission ■ L Kit: Lead wire ■ M Kit: Multiple connector 	Side	C8 (For ø8) Options Direct outlet with built-in silencer C3 (For ø3.2) C4 (For ø4) C6 (For ø6) M5 (M5 threads)	(F, L, M and P kits) 1 to 12 stations T kit 1 to 10 stations S kit 1 to 8 stations: EX500 1 to 12 stations: EX250 1 to 8 stations: EX126	VQC1□00-5 VQC1□01-5	628 (Single) 759 (Double, 3P)
VQC2000	VV5QC21-□□□		Side	C10 (For ø10) Options Direct outlet with built-in silencer Branch type C12 (for ø12) C4 (For ø4) C6 (For ø6) C8 (For ø8)	1 to 8 stations: EX500 1 to 12 stations: EX250 1 to 8 stations: EX126	VQC2□00-5 VQC2□01-5	1051 (Single) 1144 (Double, 3P)
VQC4000	VV5QC41-□□□		Side Bottom	C8 (For ø8) C10 (For ø10) C12 (For ø12) Rc 1/4 Rc 3/8 Rc 1/4	(F, L, M and P kits) 1 to 12 stations T kit 1 to 10 stations S kit 1 to 12 stations: EX240, EX250 1 to 8 stations: EX500 1 to 8 stations: EX126	VQC4□00-5 VQC4□01-5	4150 • S kit (without unit) • Solenoid weight is not included.

Note 1) One-touch fittings in inch sizes are also available.
 Note 2) An optional specification for special wiring is available to increase the maximum number of stations.

S VQC1000/2000/4000
Kit (Serial transmission kit) for I/O IP67 compliant

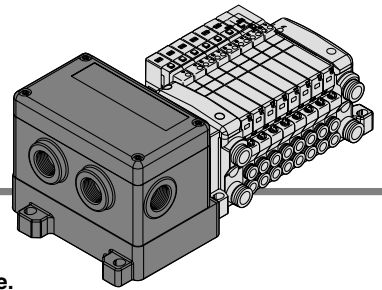

Compatible network **CC-Link**

- The serial transmission system greatly reduces connection work, minimizes wiring, and saves space.

Terminal Block Connection

Step 1. How to remove terminal block cover

Loosen the 4 mounting screws (M4) and remove the terminal block cover.

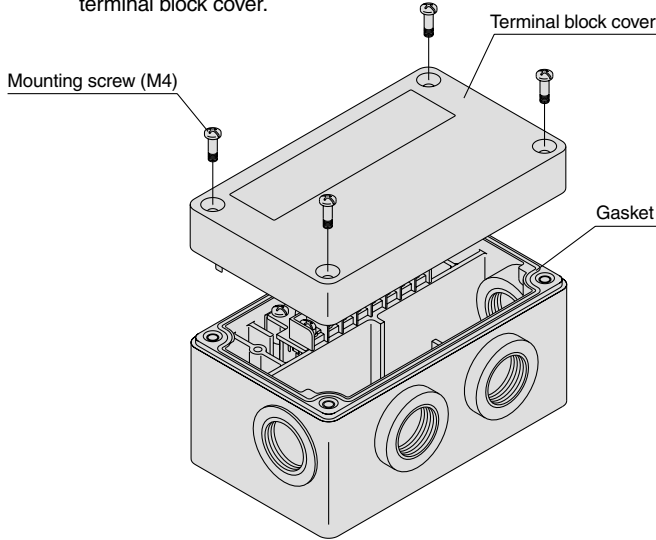

Step 2. Wire the cables according to the terminal block specifications below. Pay attention to the wire bound positions.

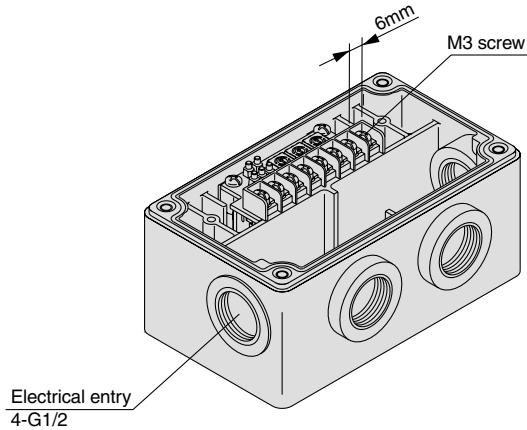

Step 3. How to replace the terminal block cover

Securely tighten the screws to the torque shown in the table below, after confirming that the gasket is installed correctly.

Proper tightening torque (N·m)
0.7 to 1.2

- Applicable crimp terminal (fork tongue type): 1.25-3S, 1.25Y-3, 1.25Y-3N, 1.25Y-3.5

* For detailed specifications and handling, refer to the operation manual provided by SMC.

Terminal Block Details

• Terminal block LED descriptions

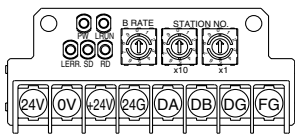

Description	Function
PW	ON when transmission power supply is ON. OFF when transmission power supply is OFF.
L RUN	ON when normal data is received.
SD	ON when data is sent.
RD	ON when data is received.
L ERR.	ON for transmission error and incorrect settings. BLINKING for change in station or transmission speed settings.

• Cable wiring

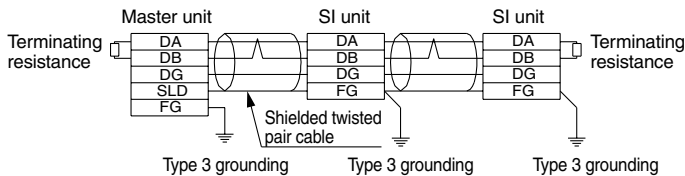

• Note

- CC-LINK System
 - Master unit: AJ61BT11
 - Master unit: A1SJ61BT11
 - Master unit: AJ61QBT11
 - Master unit: A1SJ61QBT11

- 16 outputs

VV5QC11
S Kit (Serial transmission kit: EX126)

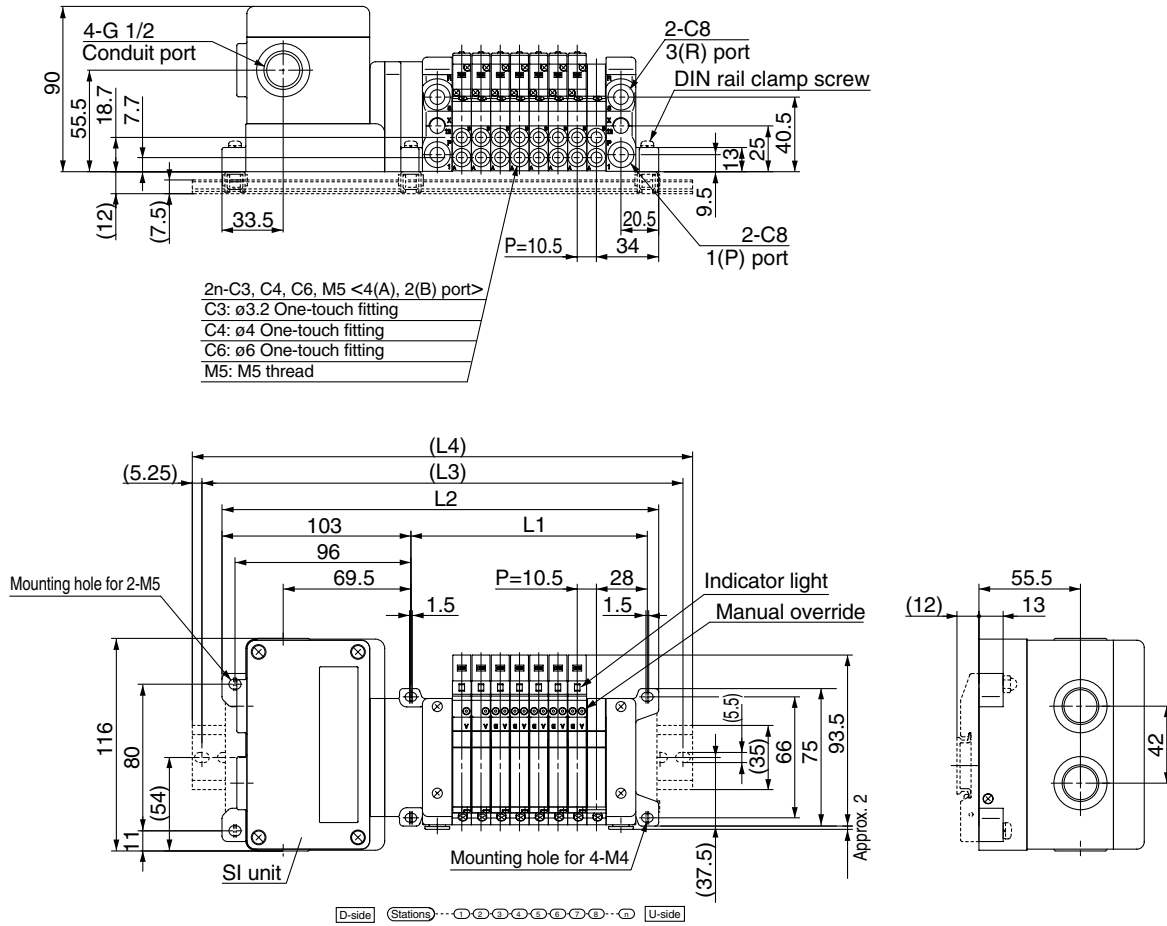

- VQC
- SQ
- VQ0
- VQ4
- VQ5
- VQZ
- VQD

L \ n	1	2	3	4	5	6	7	8	9	10	11	12	13	14	15	16
L1	55.5	66	76.5	87	97.5	108	118.5	129	139.5	150	160.5	171	181.5	192	202.5	213
L2	165	175.5	186	196.5	207	217.5	228	238.5	249	259.5	270	280.5	291	301.5	312	322.5
L3	187.5	200	212.5	212.5	225	237.5	250	262.5	275	275	287.5	300	312.5	325	337.5	337.5
L4	198	210.5	223	223	235.5	248	260.5	273	285.5	285.5	298	310.5	323	335.5	348	348

* With signal cut block, L4 is obtained by adding approximately 30 mm to L2.