

In-line Type Vacuum Ejector

Compact and Lightweight

RoHS

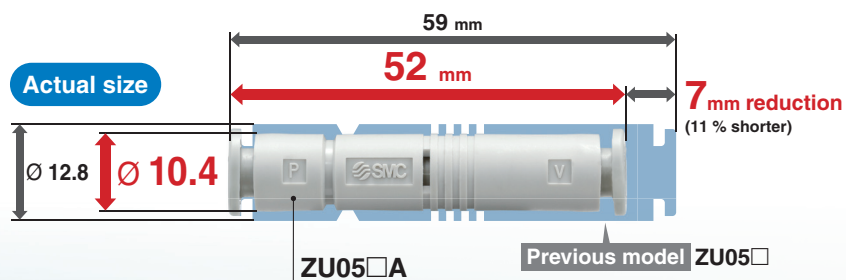

- O.D.** $\varnothing 10.4$ (Previous model $\varnothing 12.8$)
- Weight** **3.9 g** (Previous model 6.5 g)
- Overall length** **52 mm** (Previous model 59 mm)



Application Examples

For preventing pad adsorption failures from the vacuum source

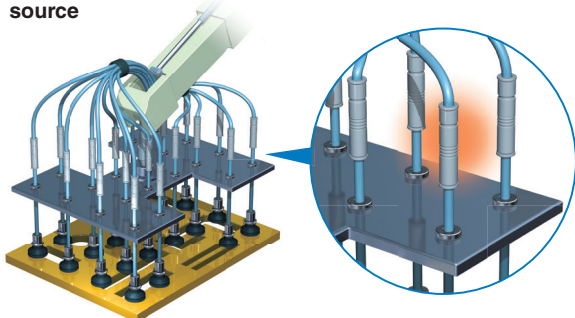

Numerous pads can be used to adsorb workpieces with holes.

For improving responsiveness by installing on flexible parts

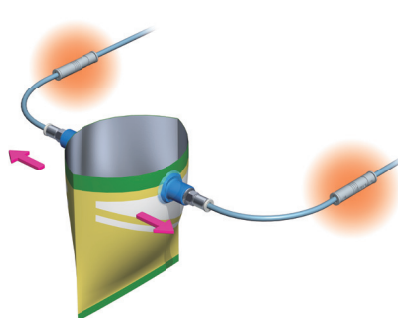

Can be used to open and close plastic bags

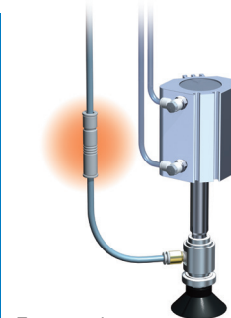

For mounting on the end of a Z-axis air cylinder

Variations

Model	Nozzle size [mm]	Standard supply pressure [MPa]	Ultimate vacuum pressure [kPa]		Maximum suction flow rate [l/min (ANR)]		Air consumption [l/min (ANR)]	Port size
			Type S	Type L	Type S	Type L		
ZU03SA	0.3	0.35	-85	—	1.8	—	3.7	Ø 4 One-touch fitting Ø 5/32"
ZU04SA	0.4		-87	—	3.2	—	7.4	
ZU05□A	0.5	0.45	-90	-48	7	13	14	Ø 6 One-touch fitting Rc1/8
ZU07□A	0.7				11	16	28	

ZU□A Series



CAT.EUS100-118B-UK

In-line Type Vacuum Ejector

ZU□A Series



How to Order

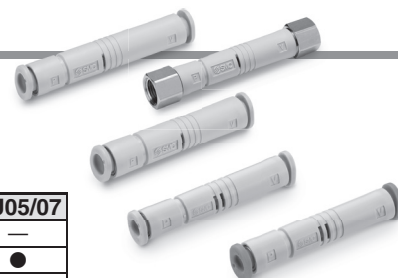

ZU05SA□

Nozzle diameter

03	0.3 mm
04	0.4 mm
05	0.5 mm
07	0.7 mm

Port size

Symbol	Port size	ZU03/04	ZU05/07
—	Ø 4 One-touch fitting	●	—
—	Ø 6 One-touch fitting	—	●
01	Rc1/8 female thread	—	●
N	Ø 5/32"	●	—

Ultimate vacuum pressure

Symbol	Ultimate vacuum pressure	ZU03/04	ZU05/07
S	-85 kPa (ZU03)/-87 kPa (ZU04)	●	—
	-90 kPa	—	●
L	-48 kPa	—	●

Symbol

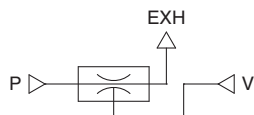

Specifications

Operating temperature range	-5 to 50 °C (No freezing)	
Fluid	Air	
Applicable tubing material	FEP, PFA, Nylon, Soft nylon, Polyurethane	
Operating pressure range	0.1 to 0.6 MPa	
Standard supply pressure	ZU03/04	0.35 MPa
	ZU05/07	0.45 MPa

Ejector Specifications^{*1}

Model	Nozzle diameter [mm]	Ultimate vacuum pressure ^{*2} [kPa]		Maximum suction flow rate ^{*2} [l/min (ANR)]		Air consumption ^{*2} [l/min (ANR)]	Weight [g]	
		Type S	Type L	Type S	Type L		One-touch connection	Screw-in connection
ZU03SA	0.3	-85	—	1.8	—	3.7	2.4	—
ZU04SA	0.4	-87	—	3.2	—	7.4		
ZU05□A	0.5	-90	-48	7	13	14	3.9	18.6
ZU07□A	0.7			11	16	28	4.3	19.1

*1 The values indicating characteristics are representative values, and may vary depending on the atmospheric pressure (weather, altitude, etc.) and measurement method.

*2 Standard supply pressure

Construction

ZU03/04

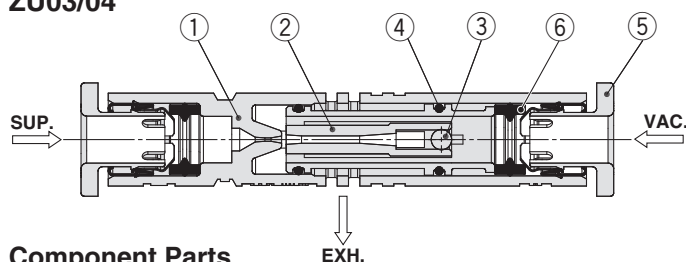

Component Parts

No.	Description	Material	Note
1	Body	Resin	
2	Diffuser	Resin	
3	Steel ball	Stainless steel	
4	O-ring	NBR	Grease applied
5	Cassette	—	
6	Seal	NBR	Grease applied

ZU05/07

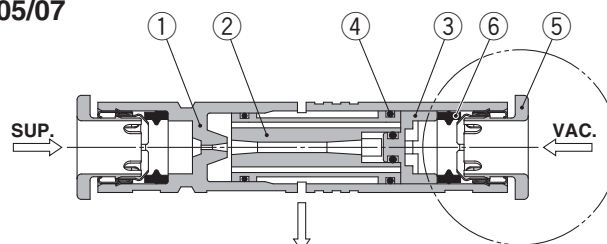

Component Parts

No.	Description	Material	Note
1	Body	Resin	
2	Diffuser	Resin	Type S: White, Type L: Black
3	Cap	Resin	
4	O-ring	NBR	Grease applied
5	Cassette	—	
6	Seal	NBR	Grease applied
7	Screw-in stud	Brass	Electroless nickel plating

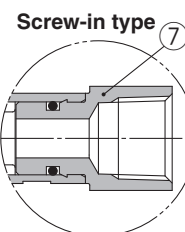

Exhaust Characteristics/Flow Rate Characteristics (Representative Value)

(Flow rate characteristics: Standard supply pressure)

ZU03SA

Exhaust Characteristics

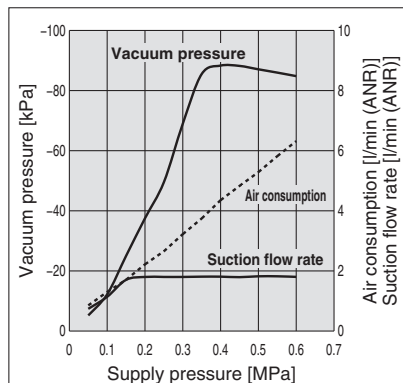

Flow Rate Characteristics (0.35 MPa)

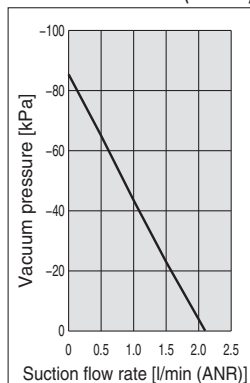

ZU04SA

Exhaust Characteristics

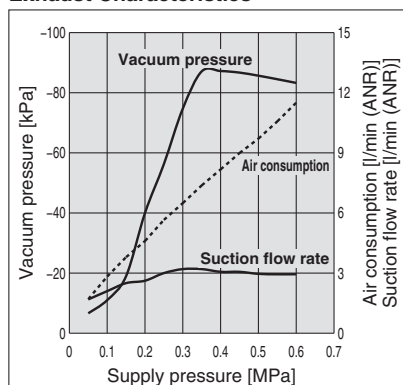

Flow Rate Characteristics (0.35 MPa)

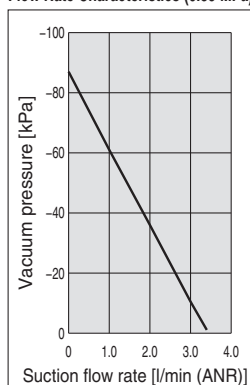

ZU05SA

Exhaust Characteristics

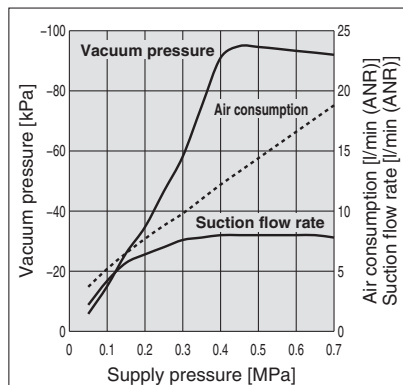

Flow Rate Characteristics (0.45 MPa)

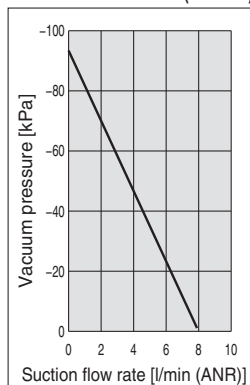

ZU05LA

Exhaust Characteristics

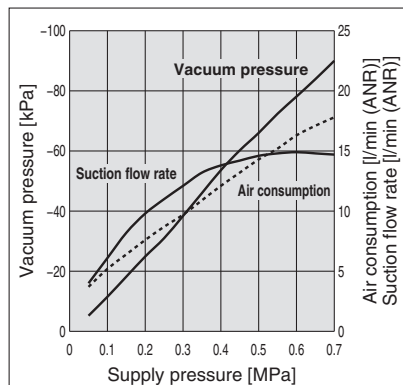

Flow Rate Characteristics (0.45 MPa)

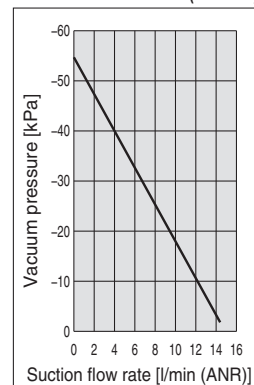

ZU07SA

Exhaust Characteristics

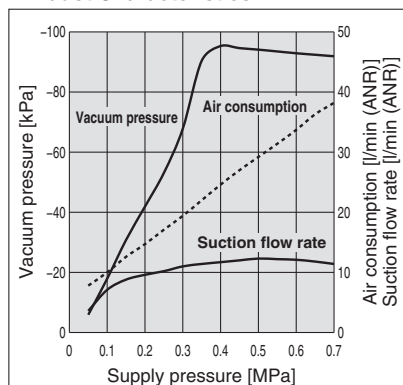

Flow Rate Characteristics (0.45 MPa)

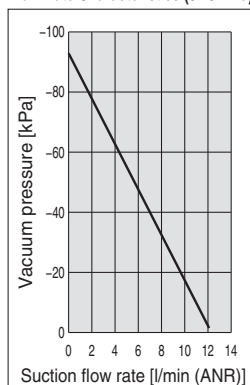

ZU07LA

Exhaust Characteristics

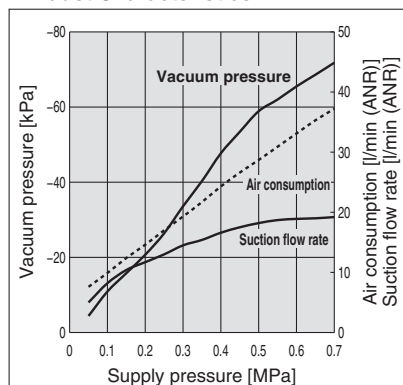

Flow Rate Characteristics (0.45 MPa)

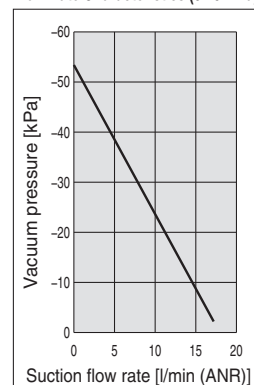

ZU□A Series

Dimensions

ZU03/04

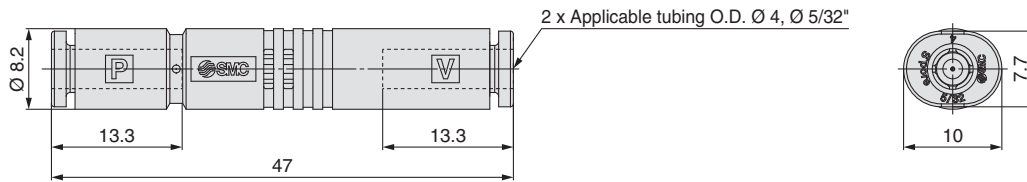

ZU05/07

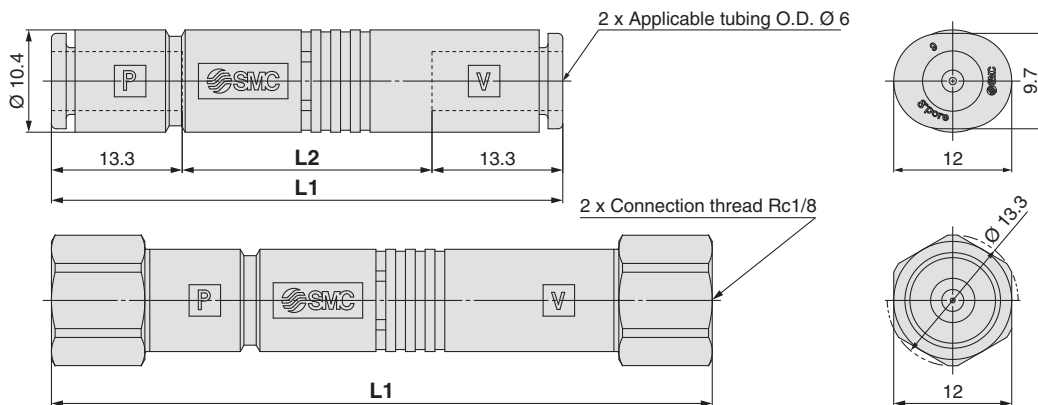

One-touch Connection

Model	L1	L2
ZU05□A	52	25.4
ZU07□A	59	32.4

Screw-in Connection

Model	L1
ZU05□A01	67.2
ZU07□A01	74.2

⚠ Specific Product Precautions

Be sure to read this before handling the products. Refer to the back cover for safety instructions. For vacuum equipment precautions, refer to the "Handling Precautions for SMC Products" and the "Operation Manual" on the SMC website: <https://www.smc.eu>

Mounting

⚠ Caution

1. When the product is mounted in between piping, the piping on both the P port side and the V port side should be adequately supported in order to avoid any unnecessary load from the piping being applied to the product.

Failure to do so may lead to performance issues or damage to the body of the product.

When mounting the product, please do not block the exhaust port at the centre of the body as this may cause performance issues.

Piping

⚠ Caution

1. Piping diameter

The piping diameter we recommend for each port is the same as that of the standard size One-touch fitting. If the piping diameter is reduced, it may lead to an insufficient flow of supply air, a reduction in suction flow, or a reduction in the ultimate vacuum pressure.

Model Selection

⚠ Caution

1. Supply valve

Select a supply valve which can provide a sufficient flow rate with ejector air consumption taken into account. If the flow rate of the supply valve is insufficient, it may lead to vacuum failure. The selected supply valve should have a C factor of at least that shown in the table below.

Minimum C Factor of a Supply Valve

Model	C [dm ³ /(s·bar)]
ZU03	0.04
ZU04	0.08
ZU05	0.12
ZU07	0.23

Air Supply



⚠ Caution

1. Quality of supply air

Use clean compressed air as the fluid. (Air quality class 2:4:3, 2:5:3, or 2:6:3 as specified in ISO 8573-1:2010 is recommended.) If any impurities enter the product, vacuum performance might be reduced due to the deterioration of the air passage or clogging of the exhaust system.

Safety Instructions

These safety instructions are intended to prevent hazardous situations and/or equipment damage. These instructions indicate the level of potential hazard with the labels of “Caution,” “Warning” or “Danger.” They are all important notes for safety and must be followed in addition to International Standards (ISO/IEC)*1, and other safety regulations.

-  **Caution:** Caution indicates a hazard with a low level of risk which, if not avoided, could result in minor or moderate injury.
-  **Warning:** Warning indicates a hazard with a medium level of risk which, if not avoided, could result in death or serious injury.
-  **Danger:** Danger indicates a hazard with a high level of risk which, if not avoided, will result in death or serious injury.

- *1) ISO 4414: Pneumatic fluid power – General rules relating to systems.
- ISO 4413: Hydraulic fluid power – General rules relating to systems.
- IEC 60204-1: Safety of machinery – Electrical equipment of machines. (Part 1: General requirements)
- ISO 10218-1: Manipulating industrial robots - Safety. etc.

Warning

1. The compatibility of the product is the responsibility of the person who designs the equipment or decides its specifications.

Since the product specified here is used under various operating conditions, its compatibility with specific equipment must be decided by the person who designs the equipment or decides its specifications based on necessary analysis and test results. The expected performance and safety assurance of the equipment will be the responsibility of the person who has determined its compatibility with the product. This person should also continuously review all specifications of the product referring to its latest catalogue information, with a view to giving due consideration to any possibility of equipment failure when configuring the equipment.

2. Only personnel with appropriate training should operate machinery and equipment.

The product specified here may become unsafe if handled incorrectly. The assembly, operation and maintenance of machines or equipment including our products must be performed by an operator who is appropriately trained and experienced.

3. Do not service or attempt to remove product and machinery/equipment until safety is confirmed.

1. The inspection and maintenance of machinery/equipment should only be performed after measures to prevent falling or runaway of the driven objects have been confirmed.
2. When the product is to be removed, confirm that the safety measures as mentioned above are implemented and the power from any appropriate source is cut, and read and understand the specific product precautions of all relevant products carefully.
3. Before machinery/equipment is restarted, take measures to prevent unexpected operation and malfunction.

4. Contact SMC beforehand and take special consideration of safety measures if the product is to be used in any of the following conditions.

1. Conditions and environments outside of the given specifications, or use outdoors or in a place exposed to direct sunlight.
2. Installation on equipment in conjunction with atomic energy, railways, air navigation, space, shipping, vehicles, military, medical treatment, combustion and recreation, or equipment in contact with food and beverages, emergency stop circuits, clutch and brake circuits in press applications, safety equipment or other applications unsuitable for the standard specifications described in the product catalogue.
3. An application which could have negative effects on people, property, or animals requiring special safety analysis.
4. Use in an interlock circuit, which requires the provision of double interlock for possible failure by using a mechanical protective function, and periodical checks to confirm proper operation.

Limited warranty and Disclaimer/ Compliance Requirements

The product used is subject to the following “Limited warranty and Disclaimer” and “Compliance Requirements”. Read and accept them before using the product.

Limited warranty and Disclaimer

1. The warranty period of the product is 1 year in service or 1.5 years after the product is delivered, whichever is first.*2) Also, the product may have specified durability, running distance or replacement parts. Please consult your nearest sales branch.
2. For any failure or damage reported within the warranty period which is clearly our responsibility, a replacement product or necessary parts will be provided. This limited warranty applies only to our product independently, and not to any other damage incurred due to the failure of the product.
3. Prior to using SMC products, please read and understand the warranty terms and disclaimers noted in the specified catalogue for the particular products.

*2) Vacuum pads are excluded from this 1 year warranty.

A vacuum pad is a consumable part, so it is warranted for a year after it is delivered. Also, even within the warranty period, the wear of a product due to the use of the vacuum pad or failure due to the deterioration of rubber material are not covered by the limited warranty.

Compliance Requirements

1. The use of SMC products with production equipment for the manufacture of weapons of mass destruction (WMD) or any other weapon is strictly prohibited.
2. The exports of SMC products or technology from one country to another are governed by the relevant security laws and regulations of the countries involved in the transaction. Prior to the shipment of a SMC product to another country, assure that all local rules governing that export are known and followed.

Caution

1. The product is provided for use in manufacturing industries.

The product herein described is basically provided for peaceful use in manufacturing industries.

If considering using the product in other industries, consult SMC beforehand and exchange specifications or a contract if necessary.

If anything is unclear, contact your nearest sales branch.

Caution

SMC products are not intended for use as instruments for legal metrology.

Measurement instruments that SMC manufactures or sells have not been qualified by type approval tests relevant to the metrology (measurement) laws of each country. Therefore, SMC products cannot be used for business or certification ordained by the metrology (measurement) laws of each country.

Safety Instructions

Be sure to read “Handling Precautions for SMC Products” (M-E03-3) before using.

SMC Corporation (Europe)

Austria	☎+43 (0)2262622800	www.smc.at	office@smc.at	Lithuania	☎+370 5 2308118	www.smc.lt	info@smc.lt
Belgium	☎+32 (0)33551464	www.smc.be	info@smc.be	Netherlands	☎+31 (0)205318888	www.smc.nl	info@smc.nl
Bulgaria	☎+359 (0)2807670	www.smc.bg	office@smc.bg	Norway	☎+47 67129020	www.smc-norge.no	post@smc-norge.no
Croatia	☎+385 (0)13707288	www.smc.hr	office@smc.hr	Poland	☎+48 222119600	www.smc.pl	office@smc.pl
Czech Republic	☎+420 541424611	www.smc.cz	office@smc.cz	Portugal	☎+351 226166570	www.smc.eu	postpt@smc.smces.es
Denmark	☎+45 70252900	www.smc.dk.com	smc@smcdk.com	Romania	☎+40 213205111	www.smcromania.ro	smcromania@smcromania.ro
Estonia	☎+372 6510370	www.smc.ee	smc@smcpneumatics.ee	Russia	☎+7 8127185445	www.smc-pneumatik.ru	info@smc-pneumatik.ru
Finland	☎+358 207513513	www.smc.fi	smc@smc.fi	Slovakia	☎+421 (0)413213212	www.smc.sk	office@smc.sk
France	☎+33 (0)164761000	www.smc-france.fr	info@smc-france.fr	Slovenia	☎+386 (0)73885412	www.smc.si	office@smc.si
Germany	☎+49 (0)61034020	www.smc.de	info@smc.de	Spain	☎+34 945184100	www.smc.eu	post@smc.smces.es
Greece	☎+30 210 2717265	www.smc-hellas.gr	sales@smc-hellas.gr	Sweden	☎+46 (0)86031200	www.smc.nu	post@smc.nu
Hungary	☎+36 23513000	www.smc.hu	office@smc.hu	Switzerland	☎+41 (0)523963131	www.smc.ch	info@smc.ch
Ireland	☎+353 (0)14039000	www.smc-pneumatics.ie	sales@smc-pneumatics.ie	Turkey	☎+90 212 489 0 440	www.smc-pneumatik.com.tr	info@smc-pneumatik.com.tr
Italy	☎+39 0292711	www.smc-italia.it	mailbox@smc-italia.it	UK	☎+44 (0)845 121 5122	www.smc.uk	sales@smc.uk
Latvia	☎+371 67817700	www.smc.lv	info@smc.lv				

SMC CORPORATION Akihabara UDX 15F, 4-14-1, Sotokanda, Chiyoda-ku, Tokyo 101-0021, JAPAN Phone: 03-5207-8249 FAX: 03-5298-5362

1st printing XO printing XO 00 Printed in Spain

Specifications are subject to change without prior notice and any obligation on the part of the manufacturer.