

# Wireless System

New



## Usable even in welding environments

Noise resistance	High-speed connection	Communication response
------------------	-----------------------	------------------------

Uses the 2.4 GHz ISM frequency band  
Frequency hopping: Every 5 ms

From power supply ON to start of communication:

**Min. 250 ms**\*1 \*1 For wireless slave

Signal response time: **5 ms**

Communication cables not required	Number of I/O points	Compatible protocol
-----------------------------------	----------------------	---------------------

Reduced wiring work, space, and cost  
Minimized disconnection risk

Max. 1280 inputs/1280 outputs  
(Registration and communication of up to 127 slave units is possible.)

EtherNet/IP™

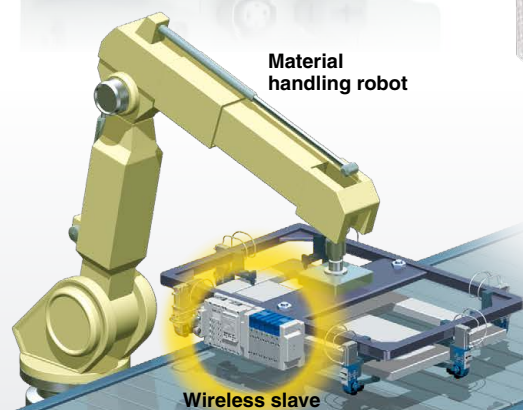

Material handling robot

Wireless slave



Wireless master



Spot welding

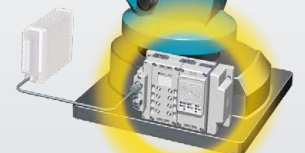

Wireless slave



Wireless master unit



Wireless slave unit

### Countries in which wireless is supported

This product cannot be used in countries where wireless is not supported. (For details → p. 22)

Country	Standard
Japan	(Japanese radio law)
EU	(CE marking/RE Directive)
USA	(FCC)

## EX600-W Series



CAT.E02-28A

# Provide safe and reliable communication

## Uses the 2.4 GHz ISM frequency band

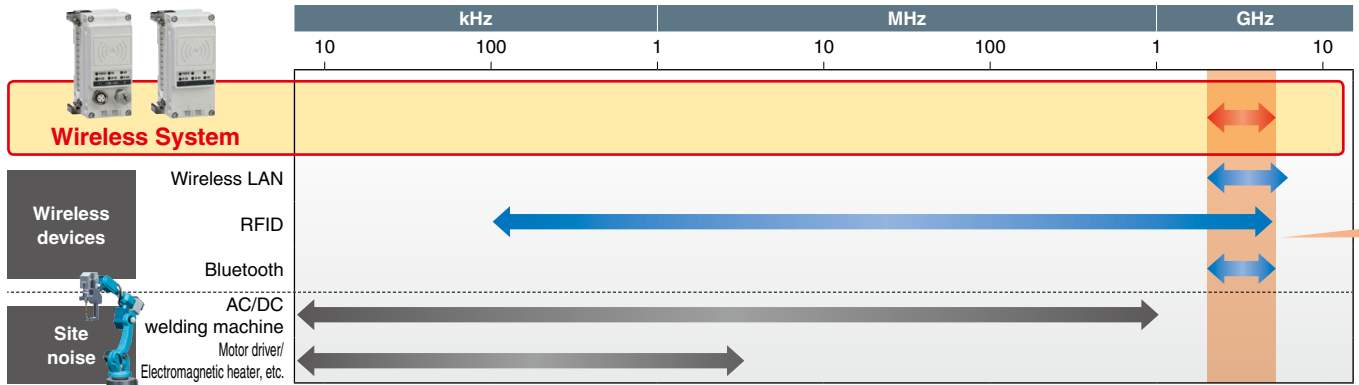

\* ISM (Industrial, Scientific and Medical) radio bands: Radio bands reserved for the use of radio frequency energy for industrial, scientific and medical purposes.

## Provide stable communication

### Communications using various forms of radio wave propagation

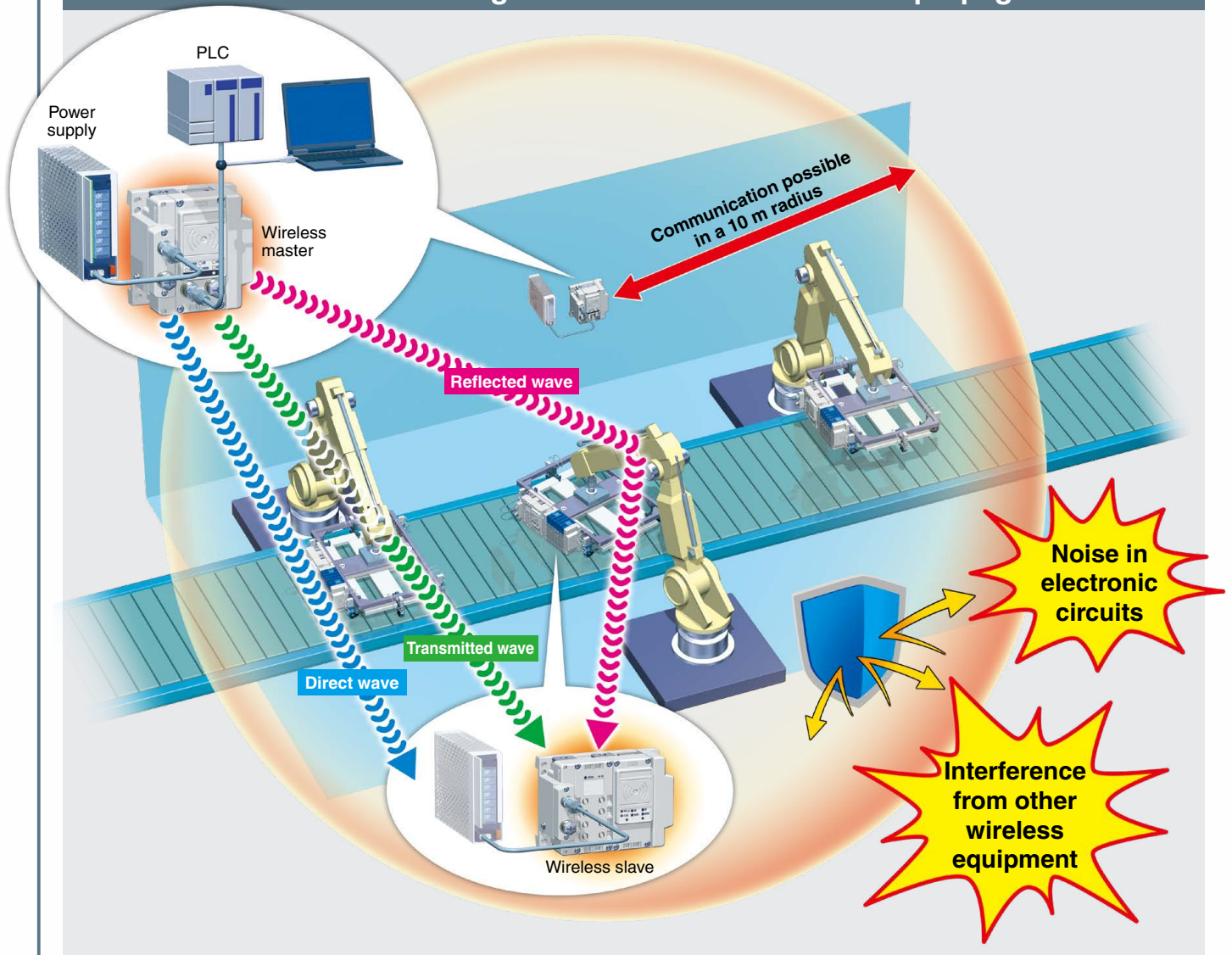

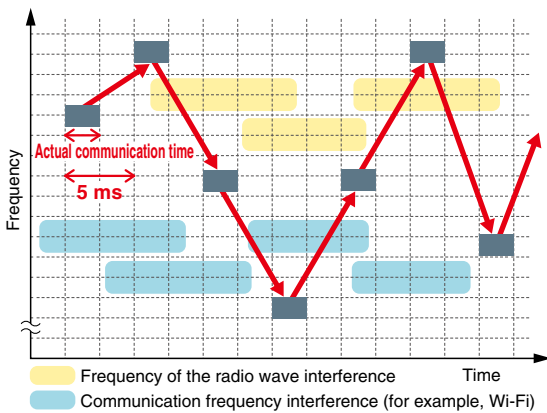

## Frequency hopping: Every 5 ms

A stable wireless environment is established using an original protocol which is not affected by interference. Interference from other wireless equipment is prevented.

### Frequency Hopping

The communication technology rapidly changes frequency (hopping), to prevent interference from other wireless equipment. When the frequency of Wi-Fi and other wireless communications compete, or radio wave interference is present, then other frequencies are used for communication. For details, refer to technical data on page 22.

## High security using encryption

Unauthorized access from outside is prevented by using data encryption.

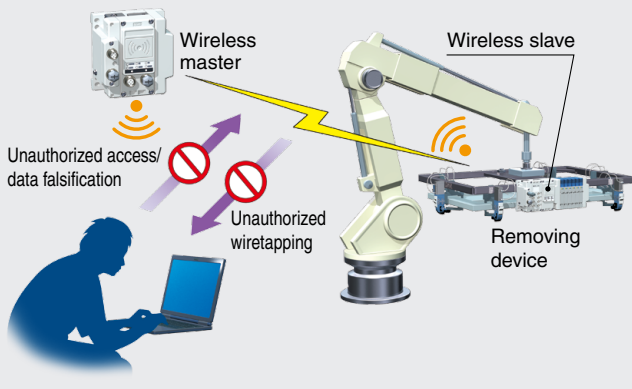

## Point-to-Multipoint communication

Registration and communication of up to 127 wireless slave units is possible.



- \* 1 to 15 units are recommended for simultaneous operation
- \* It is possible to install multiple wireless masters in the same area

## Wireless communication status can be monitored.

### <Monitoring the slave communication status>

The wireless system connection can be monitored during operation according to the diagnostic data.

The installation location can be ascertained according to the intensity level of the radio wave received by the unit display.

### [Diagnostic data]

- \* When communication from the slave cannot be received.
- \* When communication retry has exceeded the upper limit (32 times).

### [Unit display]

For wireless master	W-SS (Radio wave receiving intensity (For communication from wireless slave to wireless master))	
<input type="radio"/> PWR(W) <input type="radio"/> NS <input type="radio"/> MS <input type="radio"/> W-SS <input type="radio"/> W-NS <input type="radio"/> W-MS <input checked="" type="radio"/> LINK / ACT <input checked="" type="radio"/> 2	<input checked="" type="radio"/> Green LED is ON.	Received power level of all slaves is 3.
	<input type="radio"/> Green LED flashes. (1 Hz)	There are connected slaves with received power level 2.
	<input checked="" type="radio"/> Green LED flashes. (2 Hz)	There are connected slaves with received power level 1.
	<input type="radio"/> Red LED flashes.	No wireless slaves connected.
	<input type="radio"/> OFF	Wireless slave unit is not registered.

For wireless slave	W-SS (Radio wave receiving intensity (Communication from wireless master to wireless slave))	
<input type="radio"/> PWR(W) <input type="radio"/> NS <input type="radio"/> MS <input type="radio"/> W-SS <input type="radio"/> W-NS <input type="radio"/> W-MS <input type="radio"/> LINK / ACT <input type="radio"/> 2	<input checked="" type="radio"/> Green LED is ON.	Received power level is 3.
	<input type="radio"/> Green LED flashes. (1 Hz)	Received power level is 2.
	<input checked="" type="radio"/> Green LED flashes. (2 Hz)	Received power level is 1.
	<input type="radio"/> Red LED flashes.	Wireless communication is not connected.
	<input type="radio"/> OFF	Wireless master unit is not registered.

- \* A received radio wave intensity level of 1 means the intensity is weak. Add a wireless master so that the wave intensity becomes level 3 or 2. Alternatively remove the obstacle between the master and slave, or reduce the distance between the master and slave.

### <Communication status can be downloaded by a PC>

By connecting the wireless master to a PC, it is possible to view log files which show the number of retries or the received radio wave intensity. Log files are accessed by using a web browser to connect to the built-in WEB server. The wireless environment and installation location can be optimized by checking the number of retries and received radio wave intensity.



Web screen example

The log files showing the number of retries or the received radio wave intensity, can be downloaded in the form of a CSV file.

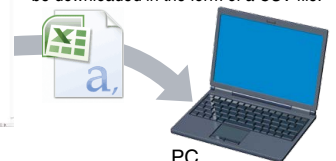

PC



## Wiring material cost and installation man-hours can be reduced.

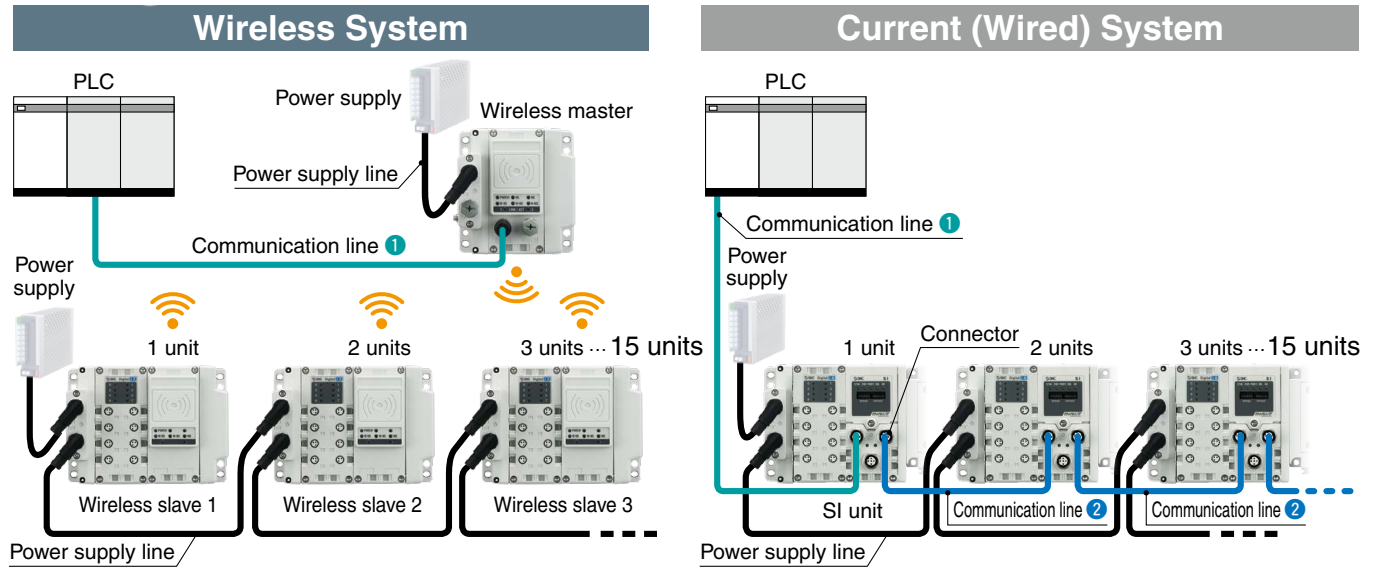

SI unit: Comparison when 15 units are connected	Number of communication devices	Communication line		Communication connectors required
		①	②	
Wireless system	Wireless master: 1 unit Wireless slave: 15 units	1 line (Connector at one end)	—	1 place
Current (Wired)	SI unit: 15 units	1 line (Connector at one end)	14 lines (Connector at both ends)	29 places

## Interchangeability maintained

Connection interchangeability between EX600 series SI units is maintained.

Replacement of wireless and wired systems is possible.

\* Maximum I/O of wireless master/slave unit is limited to 128 points.



## NFC contactless communication

(NFC: Near Field Communication)

Settings are possible using an NFC reader/ writer and setting software.  
(Some items can be set when there is no power supplied)

- Write IP address to the master
- Set the I/O points for the system and unit
- Pairing of the master and slave
- IO monitoring

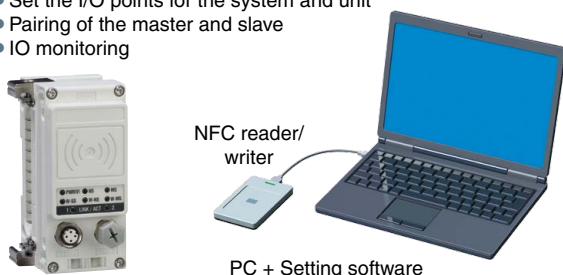

## Configuration File

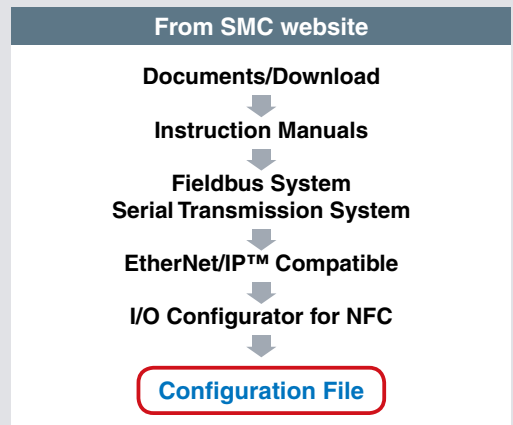



## Application Examples

### Tool change

- Communication cable is not necessary for moving parts.
- Minimized disconnection risk
- Shorter time for establishing communication (startup time)

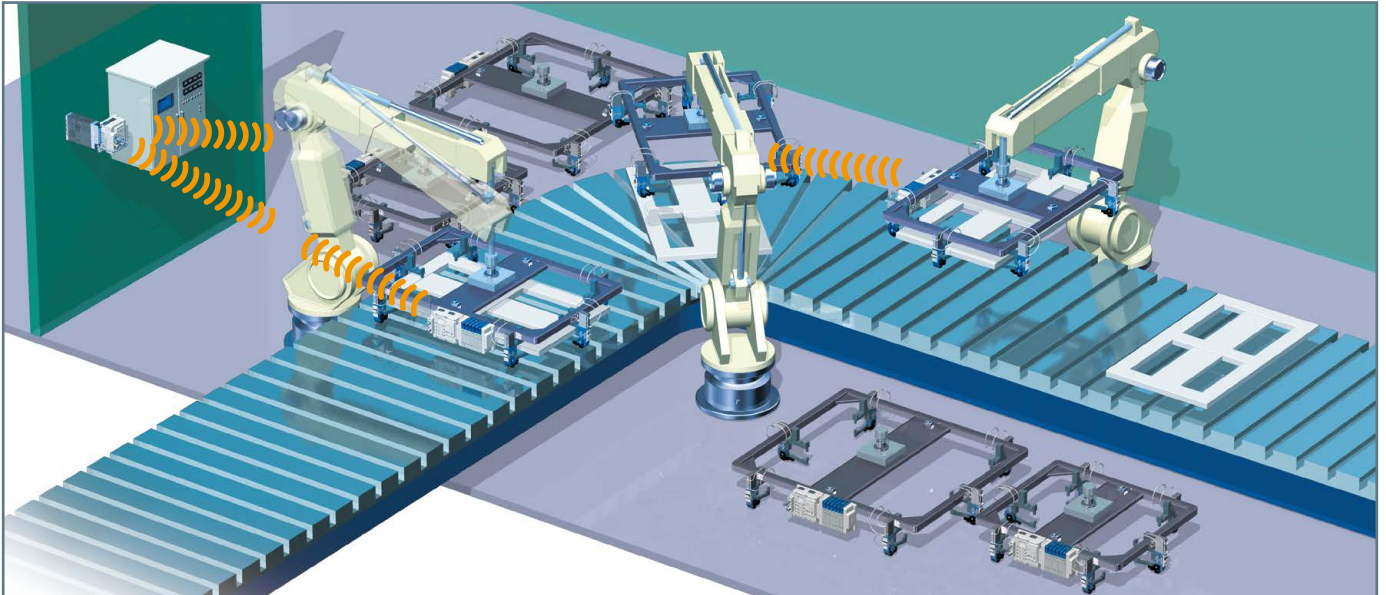

### Rotary table

- Minimized disconnection risk
- Smaller diameter communication cable/tubing

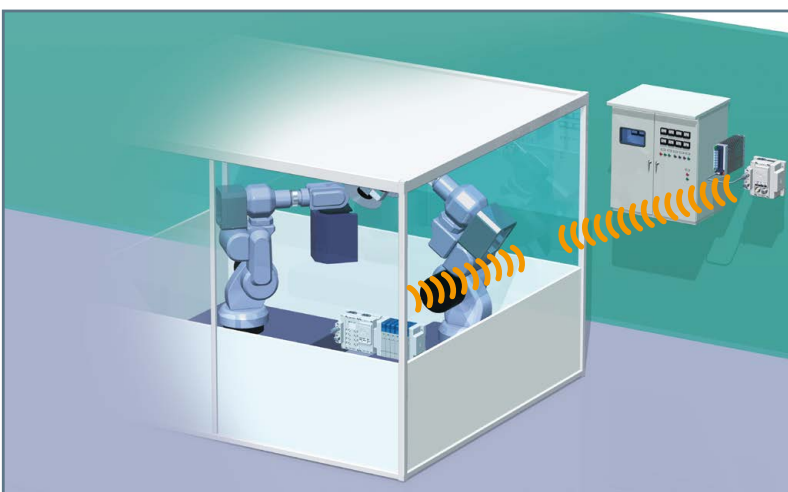
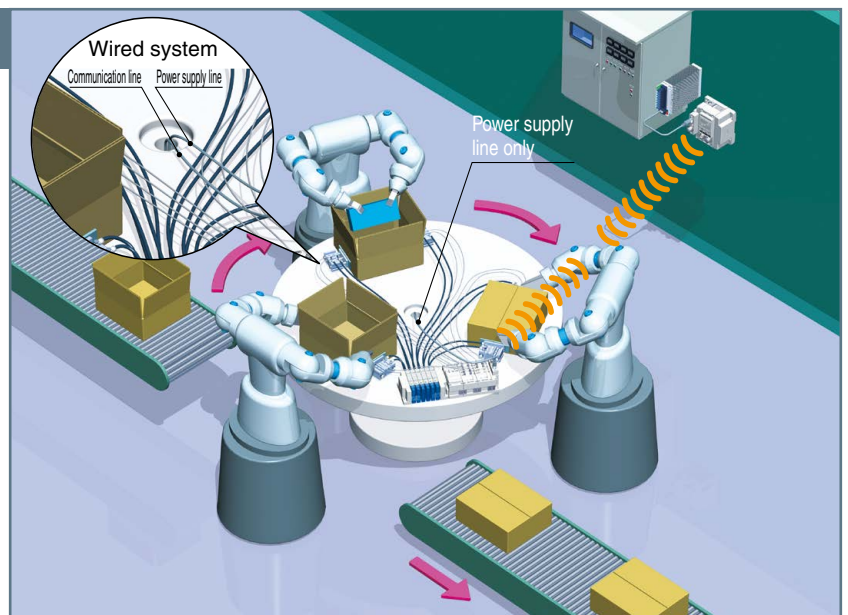

### Blocking of radio waves

\* The radio waves must not be blocked by nearby conductive objects such as metal enclosures or covers.

## System Examples

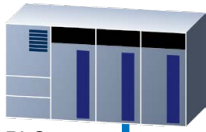

PLC

Fieldbus **EtherNet/IP™**

### Setting/Monitor tool

Initial setting/monitoring/  
pairing are possible.

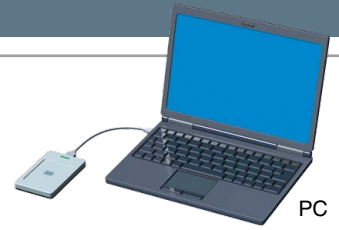

PC

## Wireless Network

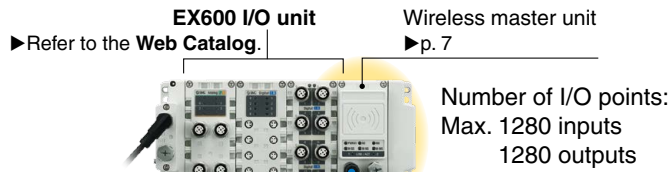

### Combination Example ①

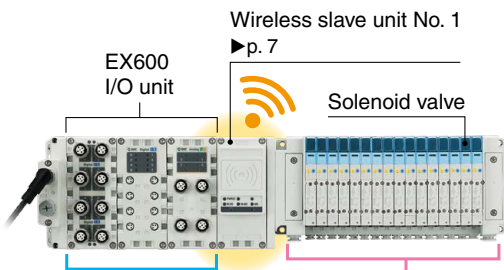

### Combination Example ②

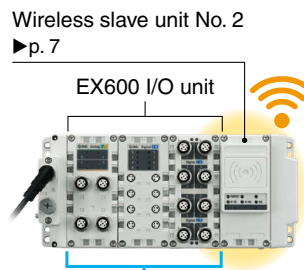

### Combination Example ③

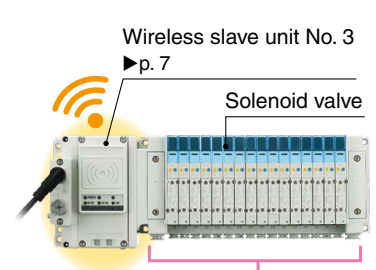

### Other products

Pressure switch, flow switch, auto switch, and other switches  
(proximate sensor, photoelectric switch, limit switch, etc.)



### Various actuators



## Applicable Manifold Solenoid Valves

**SY Series (IP67)**



**SV Series (IP67)**



**S0700 Series (IP40)**



**VQC Series (IP67)**



# CONTENTS

## Wireless System *EX600-W Series*



Wireless master unit



Wireless slave unit



### How to Order

Wireless Unit .....	p. 7
Digital Input Unit .....	p. 7
Digital Output Unit .....	p. 7
Digital Input/Output Unit .....	p. 7
Analog Input Unit .....	p. 8
Analog Output Unit .....	p. 8
Analog Input/Output Unit .....	p. 8
End Plate (D side) .....	p. 8
End Plate (U side) .....	p. 8

<b>Ordering Example of the Master Unit</b> .....	p. 9
--	------

<b>Ordering Example of the Slave Unit</b> .....	p. 9
---	------

### Specifications

Wireless Master Unit .....	p. 10
Wireless Slave Unit .....	p. 11
End Plate (D side) .....	p. 11

<b>Dimensions</b> .....	p. 12
-------------------------	-------

<b>LED Display</b> .....	p. 15
--------------------------	-------

Technical Data .....	p. 22
----------------------	-------

Important .....	p. 22
-----------------	-------

Safety Instructions .....	Back Cover
---------------------------	------------

### Accessories

① End Plate Bracket .....	p. 17
② Valve Plate .....	p. 17
③ Reinforcing Brace .....	p. 17
④ Seal Cap .....	p. 17
⑤ Marker .....	p. 18
⑥ Communication Cable with Connector/ Communication Connector .....	p. 18
⑦ Power Supply Cable with M12 Connector (A-coded) .....	p. 19
⑦ Power Supply Cable with M12 Connector (B-coded) .....	p. 20
⑧ Power Supply Cable with 7/8 Inch Connector/ Power Supply Connector .....	p. 21



# Wireless System EX600-W Series



## How to Order

### SI Unit

**EX600-W EN 1**

Wireless compatible

SI unit

Symbol	Specifications	Note
<b>EN</b>	Wireless master unit	For EtherNet/IP™
<b>SV</b>	Wireless slave unit	—

Output type

Symbol	Specifications
<b>1</b>	PNP
<b>2</b>	NPN



Wireless master unit

Wireless slave unit

### Digital Input Unit

**EX600-DX P D**

Input type

Symbol	Description
<b>P</b>	PNP
<b>N</b>	NPN

Number of inputs and Connector

Symbol	Number of inputs	Connector
<b>B</b>	8 inputs	M12 connector (5 pins) 4 pcs.
<b>C</b>	8 inputs	M8 connector (3 pins) 8 pcs.
<b>D</b>	16 inputs	M12 connector (5 pins) 8 pcs.
<b>E</b>	16 inputs	D-sub connector (25 pins)
<b>F</b>	16 inputs	Spring type terminal block (32 pins)

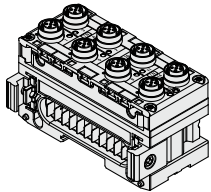

\* For specifications, refer to the Fieldbus system EX600 series in the [Web Catalog](#).

### Digital Output Unit

**EX600-DY P B**

Output type

Symbol	Description
<b>P</b>	PNP
<b>N</b>	NPN

Number of outputs and Connector

Symbol	Number of outputs	Connector
<b>B</b>	8 outputs	M12 connector (5 pins) 4 pcs.
<b>E</b>	16 outputs	D-sub connector (25 pins)
<b>F</b>	16 outputs	Spring type terminal block (32 pins)

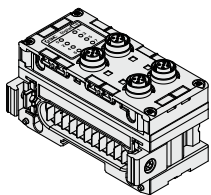

\* For specifications, refer to the Fieldbus system EX600 series in the [Web Catalog](#).

### Digital Input/Output Unit

**EX600-DM P F**

Input/Output type

Symbol	Description
<b>P</b>	PNP
<b>N</b>	NPN

Number of inputs/outputs and Connector

Symbol	Number of inputs	Number of outputs	Connector
<b>E</b>	8 inputs	8 outputs	D-sub connector (25 pins)
<b>F</b>	8 inputs	8 outputs	Spring type terminal block (32 pins)

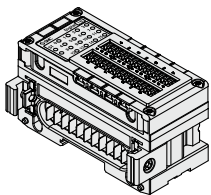

\* For specifications, refer to the Fieldbus system EX600 series in the [Web Catalog](#).

**How to Order**

**Analog Input Unit**

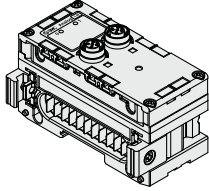

**EX600-AX A**

Analog input

Number of input channels and Connector

Symbol	Number of input channels	Connector
<b>A</b>	2 channels	M12 connector (5 pins) 2 pcs.

\* For specifications, refer to the Fieldbus system EX600 series in the **Web Catalog**.

**Analog Output Unit**

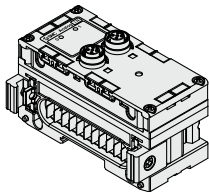

**EX600-AY A**

Analog output

Number of output channels and Connector

Symbol	Number of output channels	Connector
<b>A</b>	2 channels	M12 connector (5 pins) 2 pcs.

\* For specifications, refer to the Fieldbus system EX600 series in the **Web Catalog**.

**Analog Input/Output Unit**

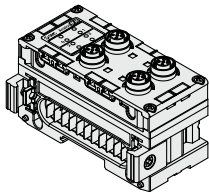

**EX600-AM B**

Analog input/output

Number of input/output channels and Connector

Symbol	Number of input channels	Number of output channels	Connector
<b>B</b>	2 channels	2 channels	M12 connector (5 pins) 4 pcs.

\* For specifications, refer to the Fieldbus system EX600 series in the **Web Catalog**.

**End Plate (D side)**

**EX600-ED 2-2**

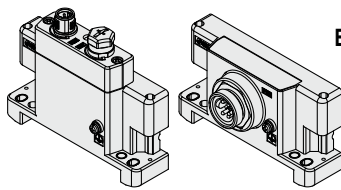

For M12

For 7/8 inch

End plate

End plate mounting position: D side

Power supply connector

Symbol	Power supply connector	Specifications
<b>2</b>	M12 (5 pins) B-coded	IN
<b>3</b>	7/8 inch (5 pins)	IN
<b>4</b>	M12 (4/5 pins) A-coded*1	IN/OUT
<b>5</b>	M12 (4/5 pins) A-coded*1	IN/OUT

\*1 The pin layout for "4" and "5" pin connector is different. Refer to the dimensions on page 14.

Mounting method

Symbol	Description	Note
<b>Nil</b>	Without DIN rail mounting bracket	—
<b>2</b>	With DIN rail mounting bracket	For SV, S0700, VQC series
<b>3</b>	With DIN rail mounting bracket	For SY series

\* When the end plate (U side) is used, the symbol for the mounting method must be the same as the D side.

**End Plate (U side)**

**EX600-EU 1-2**

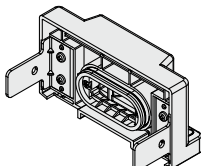

End plate

End plate mounting position: U side

Specifications

Symbol	Specifications
<b>1</b>	Waterproof cover

Mounting method

Symbol	Description
<b>Nil</b>	Without DIN rail mounting bracket
<b>2</b>	With DIN rail mounting bracket

\* When the end plate (D side) is used, the symbol for the mounting method must be the same as the U side.

# EX600-W Series

## Ordering Example of the Master Unit

**Master unit: Without valve manifold and input/output unit**

EX600-ED4	1 set
EX600-WEN1	1 set
EX600-EU1	1 set

· Products should be ordered separately and assembled by the customer.

**Manifold with master unit: With input/output unit**

SS5Y3-10S6WE72-05B-C6	(Type 10 5-station manifold base, Wireless EtherNet/IP™)
Negative common, M12 connector IN/OUT pin arrangement 1, I/O unit: 2 stations	
* SY3100-5U1	3 sets (2-position single part no.)
* SY3200-5U1	2 sets (2-position double part no.)
* EX600-DXPD	1 set I/O unit part no. (Stations 1)
* EX600-DYPB	1 set I/O unit part no. (Stations 2)

→ The asterisk denotes the symbol for the assembly. Prefix it to the part numbers of the valve, etc.

· For details, refer to the catalog of each valve series.

## Ordering Example of the Slave Unit

**Slave unit: Without valve manifold and with input/output unit**

EX600-ED4	1 set
EX600-DXPD	1 set
EX600-DYPB	1 set
EX600-WSV1	1 set
EX600-EU1	1 set

· Products should be ordered separately and assembled by the customer.

**Manifold with slave unit: With input/output unit**

SS5Y3-10S6WS72-05B-C6	(Type 10 5-station manifold base, Wireless slave)
Negative common, M12 connector IN/OUT pin arrangement 1, I/O unit: 2 stations	
* SY3100-5U1	3 sets (2-position single part no.)
* SY3200-5U1	2 sets (2-position double part no.)
* EX600-DXPD	1 set I/O unit part no. (Stations 1)
* EX600-DYPB	1 set I/O unit part no. (Stations 2)

→ The asterisk denotes the symbol for the assembly. Prefix it to the part numbers of the valve, etc.

· For details, refer to the catalog of each valve series.



## Specifications

### Wireless Master Unit: EX600-WEN□

Item		Specifications	
EtherNet/IP™ communication	Communication protocol	EtherNet/IP™ (Conformance test version: Composit 12)	
	Transmission medium (cable)	Standard Ethernet cable (CAT5 or higher, 100BASE-TX)	
	Communication speed	10 Mbps/100 Mbps	
	Communication method	Full duplex/Half duplex	
	Configuration file	EDS file*1	
	IP address setting	Manual/BOOTP, DHCP	
	Device information	Vendor ID: 7 (SMC Corp.) Device type: 12 (Communication Adaptor) Product code: 186	
	Topology	Star, Bus, Ring (DLR), Line, Tree	
	QuickConnect™ function	Applicable	
	DLR function	Applicable	
Web server function	Applicable		
Wireless communication	Protocol	SMC original protocol (SMC encryption)	
	Radio wave type (spread)	Frequency Hopping Spread Spectrum (FHSS)	
	Frequency	2.4 GHz (2403 to 2481 MHz)	
	Number of frequency channels	79 ch (Bandwidth: 1.0 MHz)	
	Communication speed	250 kbps	
	Communication distance	10 m (Depending on the operating environment)	
	Radio Law certificate	Japanese radio law (Japan), RE (EU*2), FCC (USA)	
Electrical	For control/input (US1)	Power supply voltage	24 VDC ±10%
		Current consumption	150 mA or less
	For output (US2)	Power supply voltage	24 VDC ±10%
		Max. supply current	4 A
Input/Output	Number of inputs	System input size	Max. 1280 points together with the registered slave units
		Input size	Max. 128 points (increase or decrease by 16 points)
	Number of outputs	System output size	Max. 1280 points together with the registered slave units
		Output size	Max. 128 points (increase or decrease by 16 points)
	Analog input/output	AD refresh time	10 ms or less (the input connected to the master unit)
		DA refresh time	10 ms or less (the output connected to the master unit)
	Valve output	Output type	EX600-WEN1: Source/PNP (-COM) EX600-WEN2: Sink/NPN (+COM)
		Number of outputs	Max. 32 points (0/8/16/24/32 points)
		Connected load	Solenoid valve with surge voltage suppressor of 24 VDC and 1.5 W or less (manufactured by SMC)
Number of slave units connected		Max. 127 units (0/15/31/63/127 units)	
Number of connected EX600 I/O units		Max. 9 EX600 series I/O units (I/O = 128. I/O above 128 cannot be recognized.)	
General	Enclosure		IP67 equivalent (with manifold assembled)
	Ambient temperature (Operating temperature)		-10 to +50°C
	Ambient temperature (Storage temperature)		-20 to +60°C
	Ambient humidity		35 to 85% RH (No condensation)
	Withstand voltage		500 VAC for 1 minute between external terminals and metallic parts
	Insulation resistance		10 MΩ or more (500 VDC between external terminals and metallic parts)
	Standards		CE marking, RoHS compliant
	Weight		300 g
NFC communication*3	Communication standard		ISO/IEC14443B (Type-B)
	Frequency		13.56 MHz
	Communication speed		20 to 100 kHz (I2C)
	Communication distance		Up to 1 cm

\*1 The configuration file can be downloaded from the SMC website: <http://www.smcworld.com>

\*2 Austria, Belgium, Bulgaria, Croatia, Czech Republic, Denmark, Estonia, Finland, France, Germany, Greece, Hungary, Ireland, Italy, Latvia, Lithuania, Netherlands, Norway, Poland, Portugal, Romania, Slovakia, Slovenia, Spain, Sweden, Switzerland, U.K., Turkey

\*3 The NFC communication RFID tag of the 13.56 MHz passive type

#### ■ Trademark

EtherNet/IP™ is a trademark of ODVA.

# EX600-W Series

## Specifications

### Wireless Slave Unit: EX600-WSV□

Item		Specifications	
Electrical	For control/input (US1)	Power supply voltage	24 VDC ±10%
		Current consumption	70 mA or less
	For output (US2)	Power supply voltage	24 VDC ±10%
		Max. supply current	4 A
Input/Output	Number of inputs	Input size	Max. 128 points (increase or decrease by 16 points)
	Number of outputs	Output size	Max. 128 points (increase or decrease by 16 points)
	Valve output	Output type	EX600-WSV1: Source/PNP (–COM) EX600-WSV2: Sink/NPN (+COM)
		Number of valve manifold connections	Max. 32 points (0/8/16/24/32 points)
		Connected load	Solenoid valve with surge voltage suppressor of 24 VDC and 1.5 W or less (manufactured by SMC)
	AD/DA refresh time		0.1/0.2/0.5/1/2/5/10/30/60 s*2
	Number of connected EX600 I/O units		Max. 9 EX600 I/O units (I/O = 128. I/O above 128 cannot be recognized.)
Wireless communication	Protocol		SMC original protocol (SMC encryption)
	Radio wave type (spread)		Frequency Hopping Spread Spectrum (FHSS)
	Frequency		2.4 GHz (2403 to 2481 MHz)
	Number of frequency channels		79 ch (Bandwidth: 1.0 MHz)
	Communication speed		250 kbps
	Communication distance		10 m (Depending on the operating environment)
	Radio Law certificate		Japanese radio law (Japan), RE (EU*1), FCC (USA)
General	Enclosure		IP67 equivalent (with manifold assembled)
	Ambient temperature (Operating temperature)		–10 to +50°C
	Ambient temperature (Storage temperature)		–20 to +60°C
	Ambient humidity		35 to 85% RH (No condensation)
	Withstand voltage		500 VAC for 1 minute between external terminals and metallic parts
	Insulation resistance		10 MΩ or more (500 VDC between external terminals and metallic parts)
	Standards		CE marking, RoHS compliant
	Weight		280 g
NFC communication*3	Communication standard		ISO/IEC14443B (Type-B)
	Frequency		13.56 MHz
	Communication speed		20 to 100 kHz (12C)
	Communication distance		Up to 1 cm

\*1 Austria, Belgium, Bulgaria, Croatia, Czech Republic, Denmark, Estonia, Finland, France, Germany, Greece, Hungary, Ireland, Italy, Latvia, Lithuania, Netherlands, Norway, Poland, Portugal, Romania, Slovakia, Slovenia, Spain, Sweden, Switzerland, U.K., Turkey

\*2 Varies depending on the wireless communication status and the surrounding environment.

\*3 The NFC communication RFID tag of the 13.56 MHz passive type

### End Plate (D side): EX600-ED4/5-□

Item		Specifications	
Electrical	Connector type	PWR IN	M12 plug, 4-pin
		PWR OUT	M12 socket, 5-pin
	Rated voltage	Power supply for output	24 VDC +10%/–5%
		Power supply for control/input	24 VDC ±10% (the power supply for the unit is shut off at 17 V or less)
	Rated current	Power supply for output	Max. 4 A
		Power supply for control/input	Max. 4 A
General	Enclosure		IP67 (with manifold assembled)
	Withstand voltage		500 VAC for 1 minute (between FE and external terminals)
	Insulation resistance		10 MΩ or more (500 VDC between FE and external terminals)
	Ambient temperature	Operating	–10 to +50°C
		Stored/Transported	–20 to +60°C
	Ambient humidity		35% to 85% RH (No condensation)
Standards		CE marking, RoHS compliant	

\* For the EX600-ED2/3-□, refer to the Fieldbus system EX600 series in the **Web Catalog**.

**Dimensions**

**Wireless master unit: EX600-WEN**

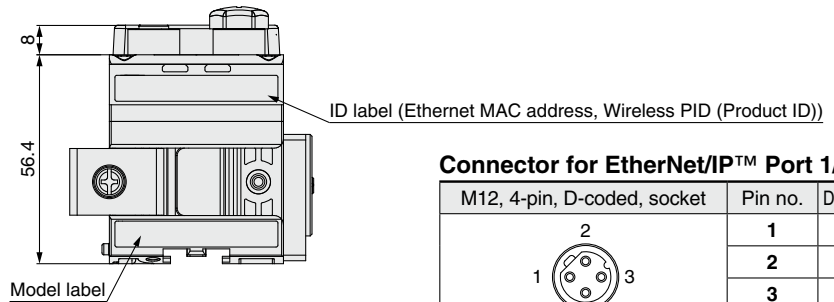
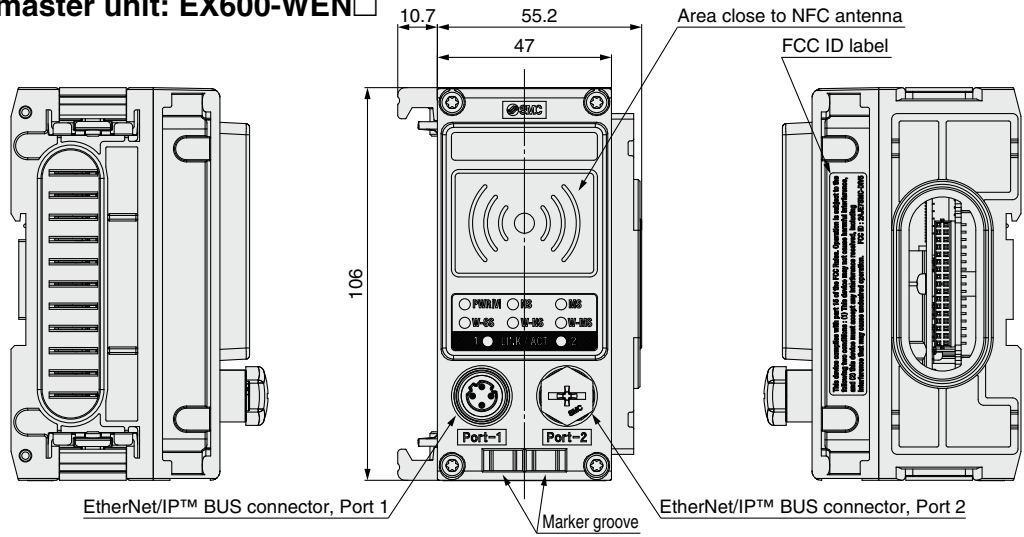

**Connector for EtherNet/IP™ Port 1/Port 2**

M12, 4-pin, D-coded, socket	Pin no.	Description
	1	Tx+
	2	Rx+
	3	Tx-
	4	Rx-

**Wireless slave unit: EX600-WSV**

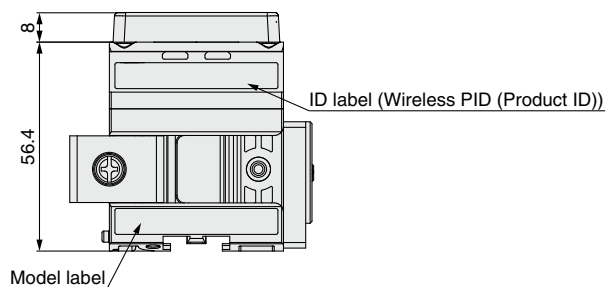
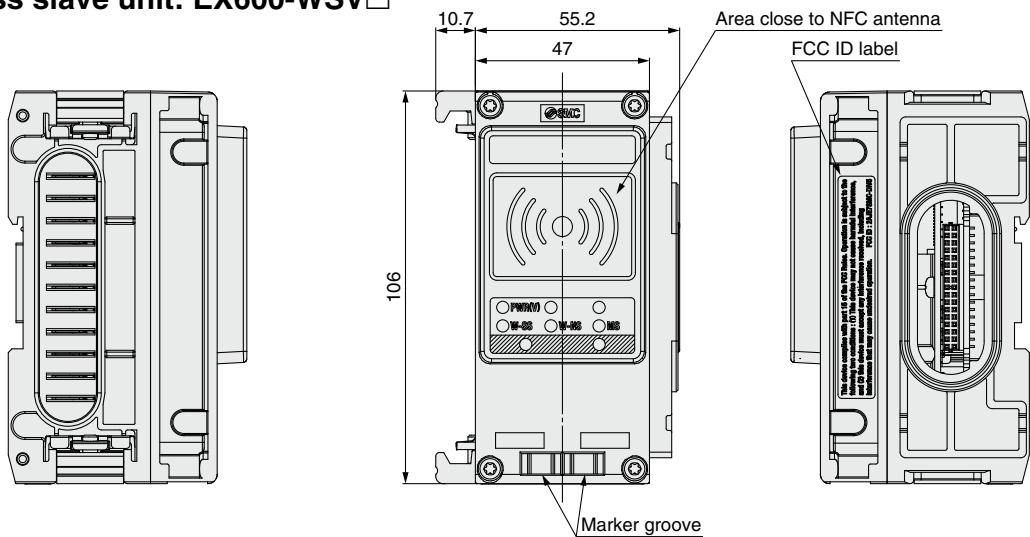



# EX600-W Series

## Dimensions

### End plate (D side)

#### EX600-ED2

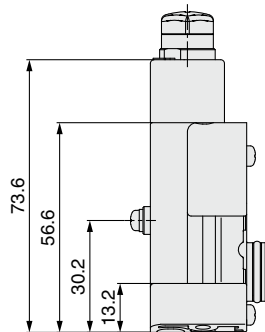
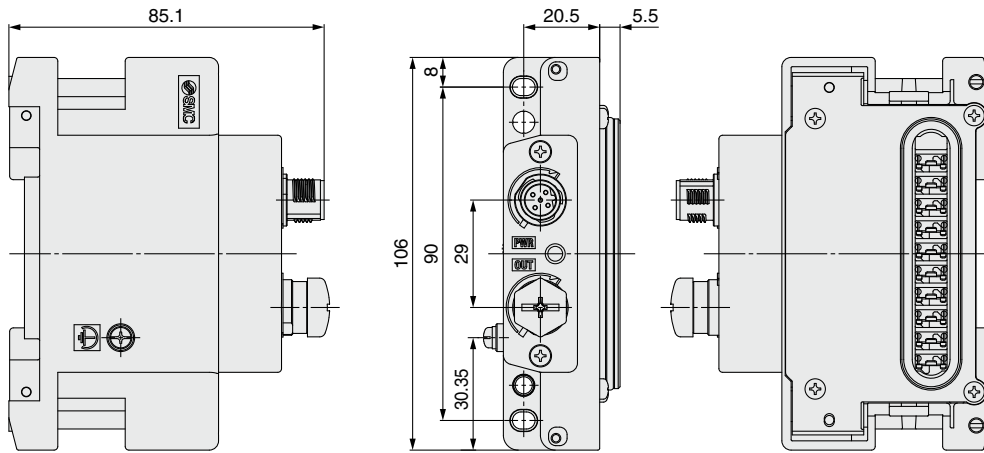

#### Power supply connector PWR: M12 5-pin plug, B-coded

Configuration	Pin no.	Description
	1	24 V (for output)
	2	0 V (for output)
	3	24 V (for control/input)
	4	0 V (for control/input)
	5	FE

#### EX600-ED3

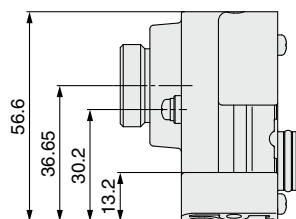
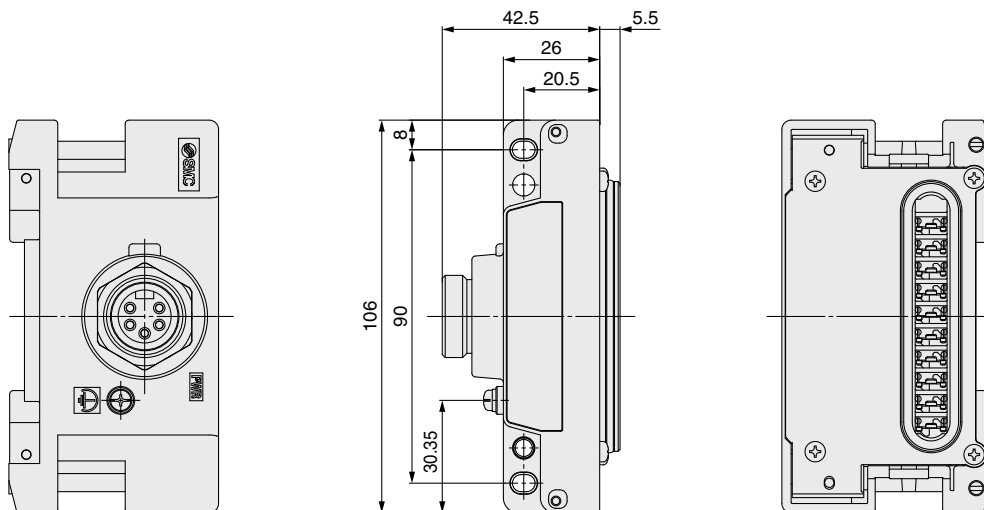

#### Power supply connector PWR: 7/8 inch 5-pin plug

Configuration	Pin no.	Description
	1	0 V (for output)
	2	0 V (for control/input)
	3	FE
	4	24 V (for control/input)
	5	24 V (for output)

**Dimensions**

**End plate (D side)**

**EX600-ED4/5**

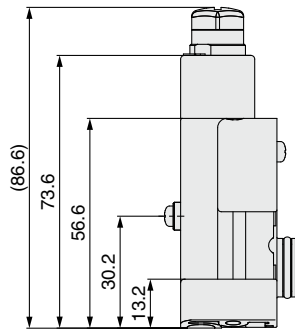
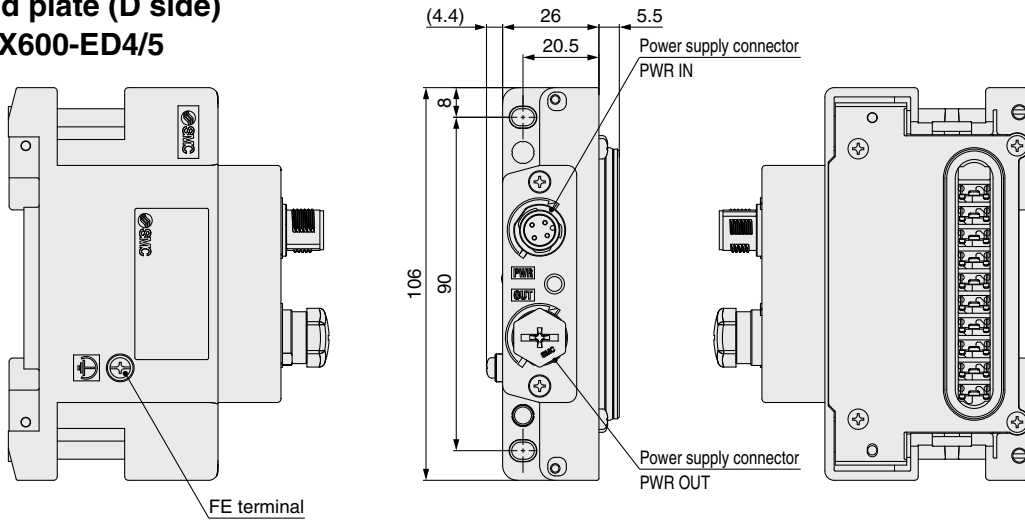

**Power supply connector PWR IN: M12 4-pin plug, A-coded**

Configuration	EX600-ED4 (Pin arrangement 1)		EX600-ED5 (Pin arrangement 2)	
	Pin no.	Description	Pin no.	Description
	1	24 V (for control/input)	1	24 V (for output)
	2	24 V (for output)	2	0 V (for output)
	3	0 V (for control/input)	3	24 V (for control/input)
	4	0 V (for output)	4	0 V (for control/input)

**Power supply connector PWR OUT: M12 5-pin socket, A-coded**

Configuration	EX600-ED4 (Pin arrangement 1)		EX600-ED5 (Pin arrangement 2)	
	Pin no.	Description	Pin no.	Description
	1	24 V (for control/input)	1	24 V (for output)
	2	24 V (for output)	2	0 V (for output)
	3	0 V (for control/input)	3	24 V (for control/input)
	4	0 V (for output)	4	0 V (for control/input)
	5	Unused	5	Unused

**End plate (U side)**

**EX600-EU1**

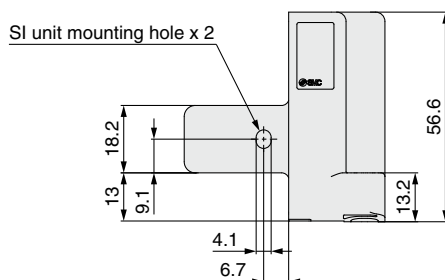
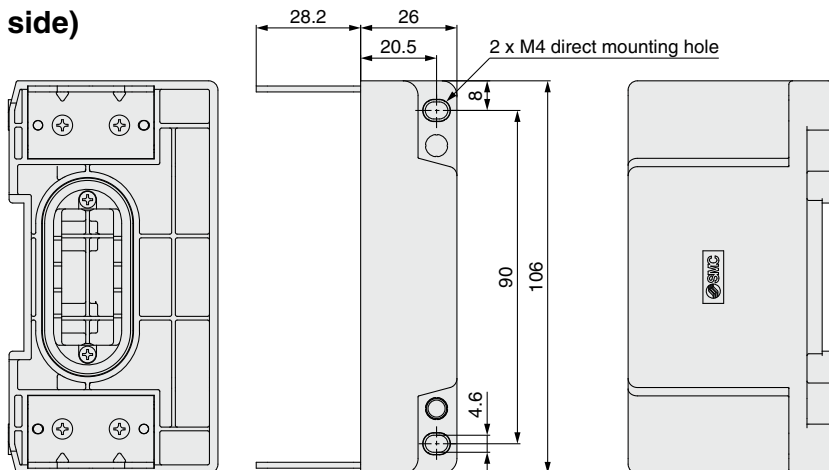

# EX600-W Series

## LED Display

### Wireless master unit EtherNet/IP™ communication specifications

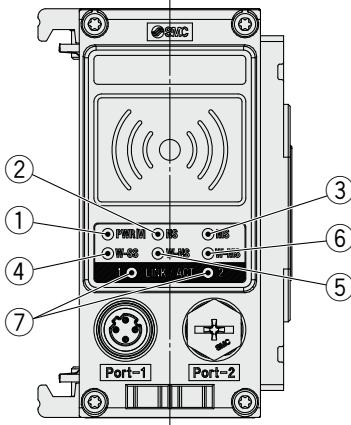

No.	LED name	Function	Color of LED	Operation
1	PWR (V)	Power supply voltage for output (US2)	Green LED is ON.	Power supply voltage for output (US2) is normal.
			Red LED flashes.	Power supply voltage for output (US2) is abnormal. (Indication only. The product can be operated.)
			OFF	Power supply for control and input (US1) is not supplied.
2	NS	EtherNet/IP™ connection status	Green LED is ON.	EtherNet/IP™ communication is established.
			Green LED flashes.	EtherNet/IP™ communication is not established.
			Red LED flashes.	EtherNet/IP™ communication time out
			Red LED is ON.	Duplicated IP addresses are detected.
			OFF	IP address not set
3	MS	Wireless master module system status	Green LED is ON.	Wireless master module is normal.
			Green LED flashes.	EtherNet/IP™ communication is not connected.
			Red LED flashes.	Restorable error is detected. (LED flashes when one diagnostic information item or more is detected.) <ul style="list-style-type: none"> <li>· Abnormal power supply voltage level for control and input</li> <li>· Excessive I/O setting inputs/outputs</li> <li>· Analog I/O upper set limit exceeded</li> <li>· Analog I/O upper and lower limit exceeded</li> <li>· Abnormal number of slave connections</li> <li>· Error in communication between units</li> <li>· EX600 I/O unit detects diagnostic information</li> <li>· Valve diagnostic information detected</li> </ul>
			Red LED is ON.	Non-restorable error is detected. (e.g. Hardware failure)
			OFF	Power supply for control and input (US1) is not supplied.
4	W-SS	Radio wave receiving intensity (For communication from wireless slave to wireless master)	Green LED is ON.	Received power level of all slaves is 3.
			Green LED flashes. (1 Hz)	There are connected slaves with received power level 2.
			Green LED flashes. (2 Hz)	There are connected slaves with received power level 1.
			Red LED flashes.	No wireless slaves connected.
			OFF	Wireless slave unit is not registered.
5	W-NS	Wireless communication connection status	Green LED is ON.	All wireless slave units are connected correctly.
			Green LED flashes.	There are unconnected wireless slave units.
			Red LED flashes.	All wireless slave units are unconnected.
			Red LED is ON.	All wireless slave units are unconnected. (Non-restorable error in wireless communication)
			Red/Green	Wireless communication connection is under construction. (Pairing)
			Orange LED is ON.	Forced output mode
			OFF	Wireless slave unit is not registered.
6	W-MS	Wireless slave module connection system status	Green LED is ON.	Wireless slave module is normal.
			Red LED flashes.	Restorable error is detected. (LED flashes when one diagnostic information item or more is detected.) <ul style="list-style-type: none"> <li>· Abnormal power supply voltage level for control and input (US1)</li> <li>· Abnormal power supply voltage level for output (US2)</li> <li>· Excessive I/O setting inputs/outputs</li> <li>· Analog I/O upper set limit exceeded</li> <li>· Analog I/O upper and lower limit exceeded</li> <li>· Error in communication between units</li> <li>· EX600 I/O unit detects diagnostic information</li> <li>· Valve diagnostic information detected</li> </ul>
			Red LED is ON.	Non-restorable error is detected. (e.g. Hardware failure)
			OFF	No wireless slave unit connected.
			Green LED is ON.	Link, No Activity (100 Mbps)
7	LINK/ACT1 LINK/ACT2	Communication status of EtherNet/IP™ ports 1 and 2  100 Mbps: Green 10 Mbps: Orange	Green LED is ON.	Link, No Activity (100 Mbps)
			Green LED flashes.	Link, Activity (100 Mbps)
			Orange LED is ON.	Link, No Activity (10 Mbps)
			Orange LED flashes.	Link, Activity (10 Mbps)
			Red LED is ON.	IP address has been duplicated.
			OFF	EtherNet/IP™ is not connected.

**LED Display**

**Wireless slave unit**

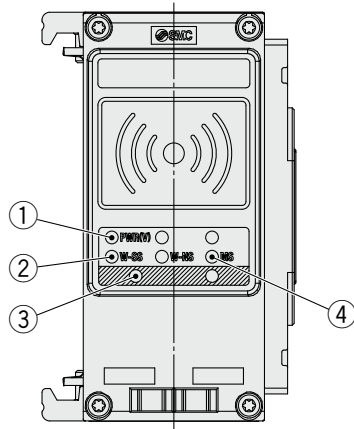

No.	LED name	Function	Color of LED	Operation
1	PWR (V)	Power supply voltage for output (US2)	Green LED is ON.	Power supply voltage for output (US2) is normal.
			Red LED flashes.	Power supply voltage for output (US2) is abnormal. (Indication only. The product can be operated.)
			OFF	Power supply for control and input (US1) is not supplied.
2	MS	Wireless slave module system status	Green LED is ON.	Wireless slave module is normal.
			Red LED flashes.	Restorable error is detected. (LED flashes when one diagnostic information item or more is detected.) · Abnormal power supply voltage level for control and input · Excessive I/O setting inputs/outputs · Analog I/O upper set limit exceeded · Analog I/O upper and lower limit exceeded · Error in communication between units · EX600 I/O unit detects diagnostic information · Valve diagnostic information detected
			Red LED is ON.	Non-restorable error is detected. (e.g. Hardware failure)
			OFF	Power supply for control and input (US1) is not supplied.
3	W-SS	Radio wave receiving intensity (Communication from wireless master to wireless slave)	Green LED is ON.	Received power level is 3.
			Green LED flashes, (1 Hz)	Received power level is 2.
			Green LED flashes, (2 Hz)	Received power level is 1.
			Red LED flashes.	Wireless communication is not connected.
			OFF	Wireless master unit is not registered.
4	W-NS	Wireless communication connection status	Green LED is ON	Wireless slave is connected correctly.
			Red LED flashes.	No wireless slaves connected.
			Red LED is ON.	No wireless slaves connected (Non-restorable error in wireless communication)
			Red/Green	Wireless communication connection is under construction. (Pairing)
			Orange LED is ON.	Forced output mode
OFF	Wireless master unit is not registered.			



# EX600-W Series

# Accessories (Optional Parts)

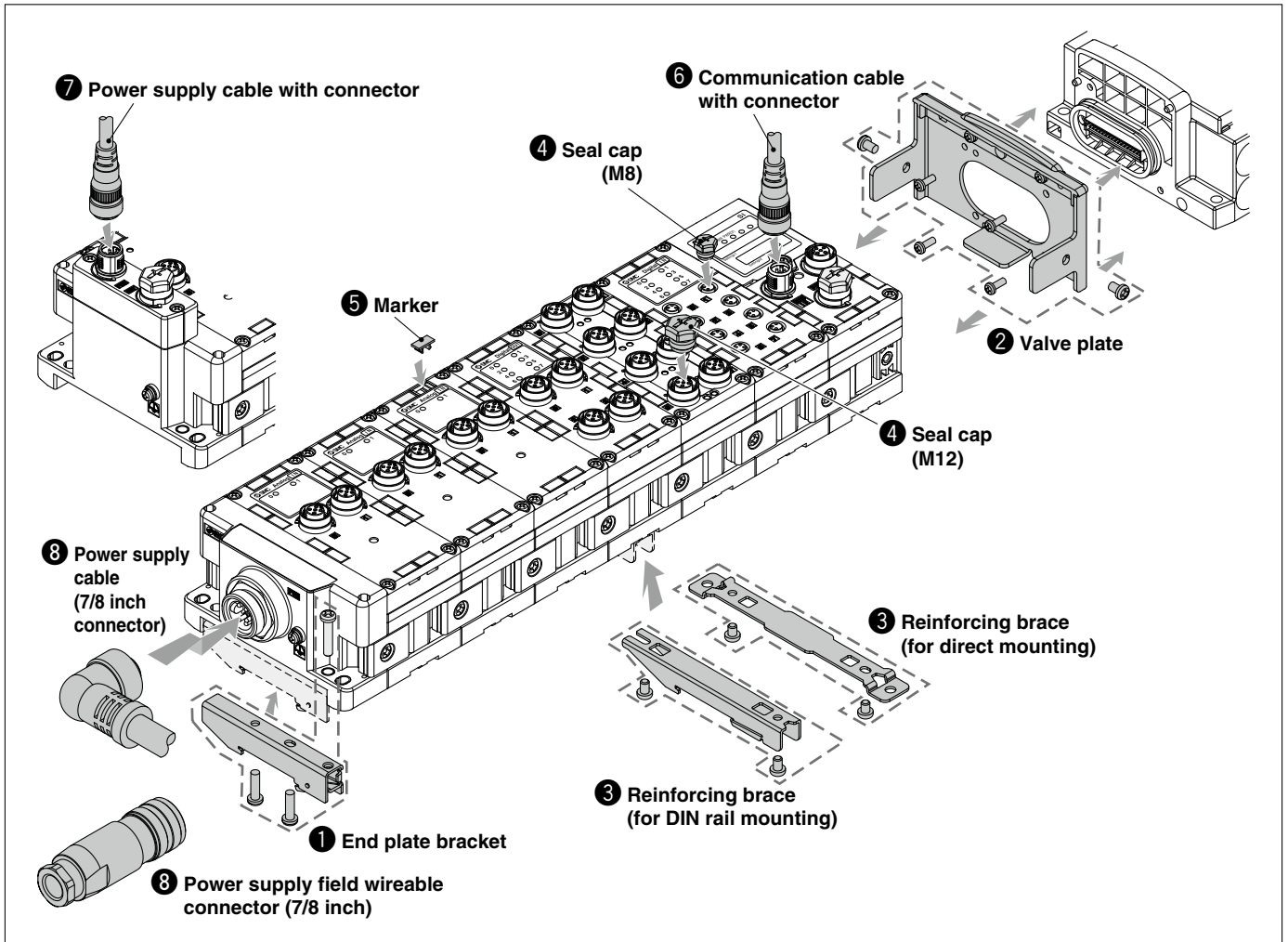

## 1 End Plate Bracket

This bracket is used for the end plate of DIN rail mounting.

### EX600-ZMA2

#### Enclosed parts

Round head screw (M4 x 20) 1 pc.  
P-tight screw (4 x 14) 2 pcs.



### EX600-ZMA3

(Specialized for the SY series)

#### Enclosed parts

Round head screw with washer (M4 x 20) 1 pc.  
P-tight screw (4 x 14) 2 pcs.

## 3 Reinforcing Brace

This bracket is used on the bottom of the unit at the intermediate position for connecting 6 units or more.

\* Be sure to attach this bracket to prevent connection failure between the units caused by deflection.

### For direct mounting

#### EX600-ZMB1

#### Enclosed parts

Round head screw (M4 x 5) 2 pcs.



### For DIN rail mounting

#### EX600-ZMB2

#### Enclosed parts

Round head screw (M4 x 6) 2 pcs.



## 2 Valve Plate

### EX600-ZMV1

#### Enclosed parts

Round head screw (M4 x 6) 2 pcs.  
Round head screw (M3 x 8) 4 pcs.



### EX600-ZMV2

(Specialized for the SY series)

#### Enclosed parts

Round head screw (M4 x 6) 2 pcs.  
Round head screw (M3 x 8) 4 pcs.



## 4 Seal Cap (10 pcs.)

Be sure to mount a seal cap on any unused I/O connectors. Otherwise, the specified enclosure cannot be maintained.

For M8  
EX9-AWES



For M12  
EX9-AWTS



**5 Marker (1 sheet, 88 pcs.)**

The signal name of I/O device and each unit address can be entered and mounted on each unit.

**EX600-ZT1**

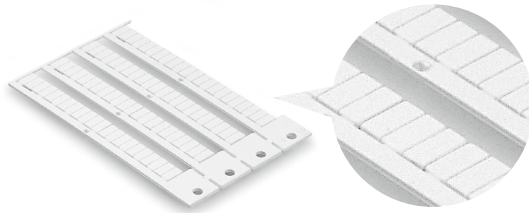

**6 Communication Cable with Connector/Communication Connector**

Cable with M12 ↔ RJ-45 connector

**EX9-AC 020 EN-PSRJ (Plug/RJ-45 connector)**

● Cable length (L)

<b>010</b>	1000 mm
<b>020</b>	2000 mm
<b>030</b>	3000 mm
<b>050</b>	5000 mm
<b>100</b>	10000 mm



**Plug connector pin arrangement**  
D-coded

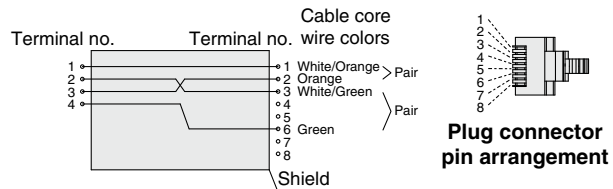
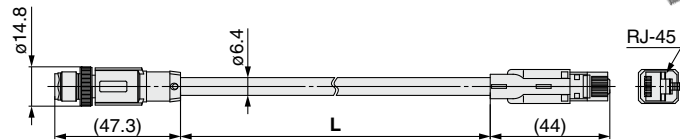

**Plug connector pin arrangement**

Connections (Straight cable)

Item	Specifications
<b>Cable O.D.</b>	ø6.4 mm
<b>Nominal cross section</b>	0.14 mm <sup>2</sup> /AWG26
<b>Wire diameter</b>	0.98 mm
<b>Min. bending radius</b>	26 mm (Fixed)

Cable with connector

**PCA-1446566 (Plug)**

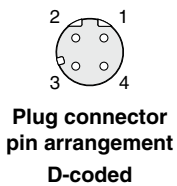
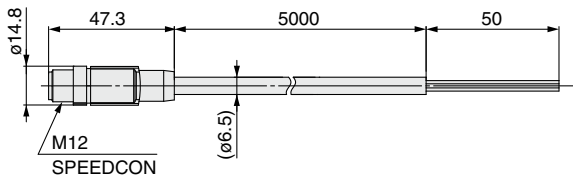

**Plug connector pin arrangement**  
D-coded

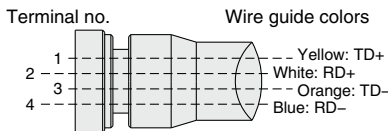

Connections

Item	Specifications
<b>Cable O.D.</b>	ø6.5 mm
<b>Nominal cross section</b>	AWG22
<b>Wire diameter (Including insulator)</b>	1.5 mm
<b>Min. bending radius</b>	45.5 mm

Field wireable connector

**PCA-1446553**

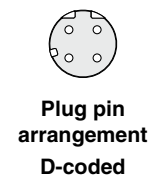
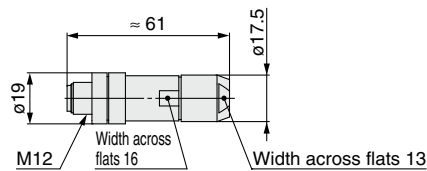

**Plug pin arrangement**  
D-coded

Terminal no.	Wire guide colors
1	Orange/White
2	Green/White
3	Orange
4	Green

Applicable Cable

<b>Cable O.D.</b>	4.0 to 8.0 mm
<b>Wire gauge (Stranded wire cross section)</b>	0.14 to 0.34 mm <sup>2</sup> /AWG26 to 22

\* The table above shows the specifications for the applicable cable. Adaptation for the connector may vary on account of the conductor construction of the electric wire.

# EX600-W Series

## ⑦ Power Supply Cable with M12 Connector (A-coded)

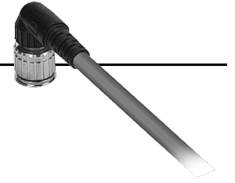

EX500-AP **050** - **S**

● Cable length (L)

<b>010</b>	1000 mm
<b>050</b>	5000 mm

● Connector specification

<b>S</b>	Straight
<b>A</b>	Angle

### Straight connector type

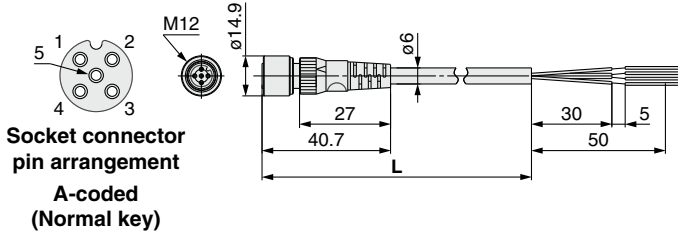

Item	Specifications
Cable O.D.	ø6 mm
Nominal cross section	0.3 mm <sup>2</sup> /AWG22
Wire diameter (Including insulator)	1.5 mm
Min. bending radius	40 mm (Fixed)

### Angle connector type

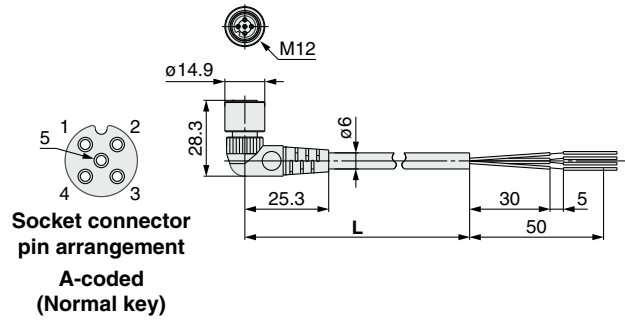

Item	Specifications
Cable O.D.	ø6 mm
Nominal cross section	0.3 mm <sup>2</sup> /AWG22
Wire diameter (Including insulator)	1.5 mm
Min. bending radius	40 mm (Fixed)

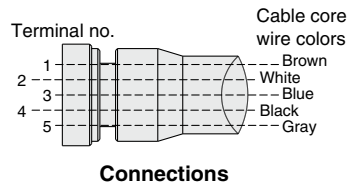

### SPEEDCON

PCA- **1401804**

● Cable length (L)

<b>1401804</b>	1500 mm
<b>1401805</b>	3000 mm
<b>1401806</b>	5000 mm

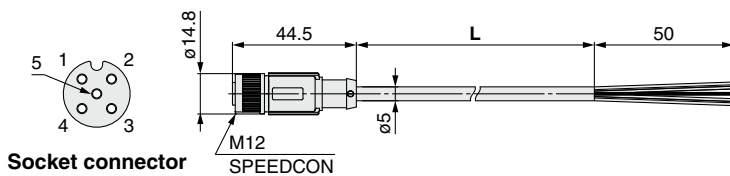

Item	Specifications
Cable O.D.	ø5 mm
Nominal cross section	0.3 mm <sup>2</sup> /AWG22
Wire diameter (Including insulator)	1.27 mm
Min. bending radius	21.7 mm (Fixed)

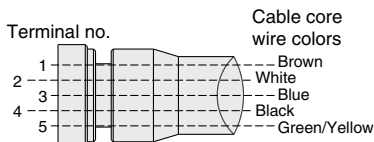

PCA- **1557769**

● Cable length (L)

<b>1557769</b>	3000 mm
----------------	---------

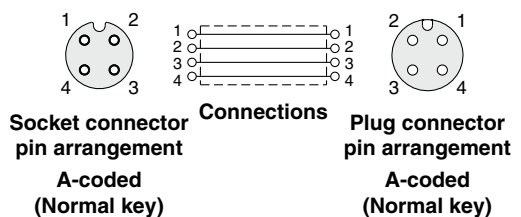
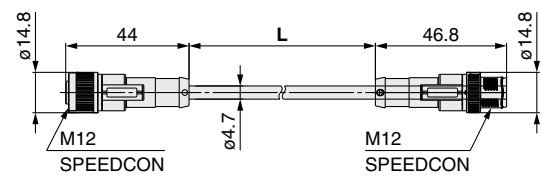

Connections

**7 Power Supply Cable with M12 Connector (B-coded)**

**SPEEDCON**

**PCA-1564927**

● **Socket specification, Cable length (L)**

<b>1564927</b>	Straight 2 m
<b>1564930</b>	Straight 6 m
<b>1564943</b>	Angle 2 m
<b>1564969</b>	Angle 6 m

**Straight connector type**

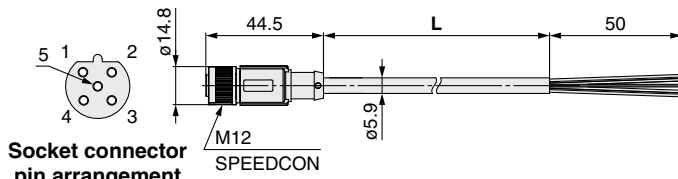

**Socket connector pin arrangement B-coded (Reverse key)**

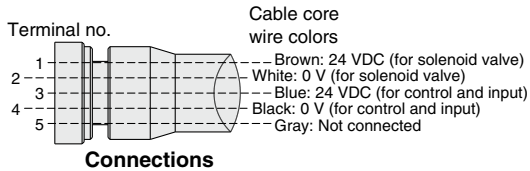

**Angle connector type**

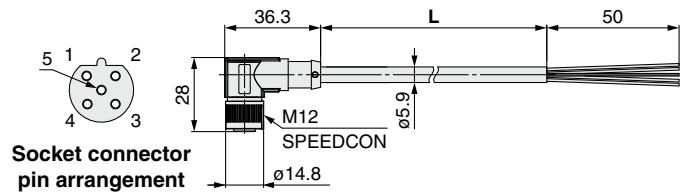

**Socket connector pin arrangement B-coded (Reverse key)**

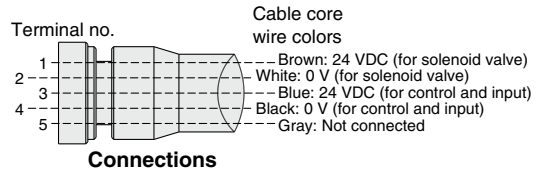



# EX600-W Series

## ⑧ Power Supply Cable with 7/8 Inch Connector/Power Supply Connector

PCA-1558810

### Specifications

Symbol	Cable length (L)	Connector specification
1558810	2000	Straight
1558823	6000	Straight
1558836	2000	Right angle
1558849	6000	Right angle

### Straight connector type

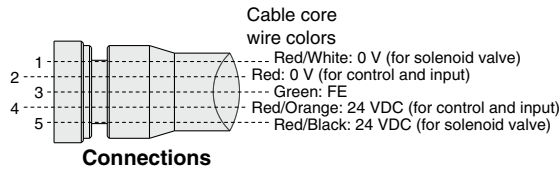
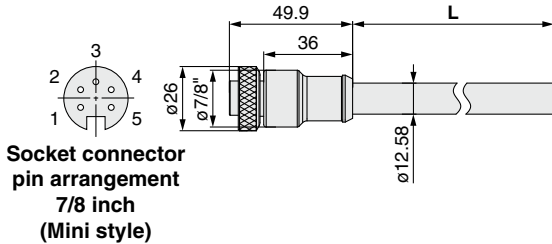

### Angle connector type

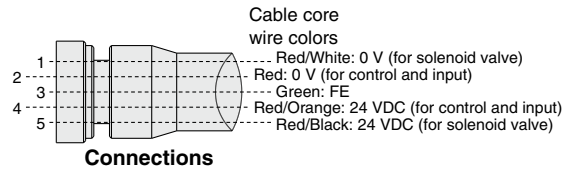
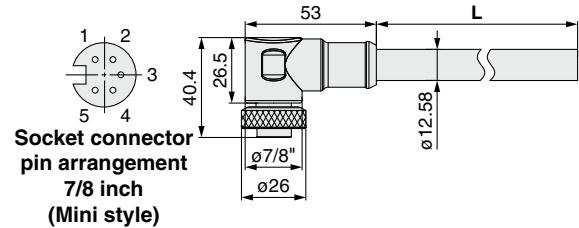

## Field wireable connector

PCA-1578078

### Specifications

Symbol	Connector specification
1578078	Plug
1578081	Socket

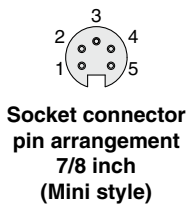
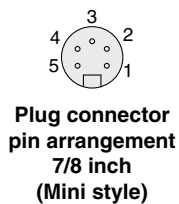
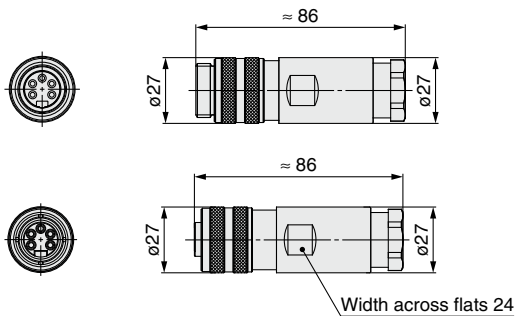

Terminal no.	Wire guide colors
1	Red/White
2	Red
3	Green
4	Red/Orange
5	Red/Black

### Applicable Cable

Cable O.D.	12.0 to 14.0 mm
Wire gauge (Stranded wire cross section)	0.34 to 1.5 mm <sup>2</sup> /AWG22 to 16

\* The table above shows the specifications for the applicable cable. Adaptation for the connector may vary on account of the conductor construction of the electric wire.

\* For further information on cables and connectors, refer to the M8/M12 connector PCA series in the **Web Catalog**.

# EX600-W Series

## Technical Data

### Frequency Hopping (FHSS: Frequency Hopping Spread Spectrum)

A communication technology that uses spread spectrum transmission with frequency hopping to rapidly switch the frequency. Because the frequency rapidly changes all the time, this communication method is resistant to radio wave interference due to reflections or noise from other wireless equipment, while ensuring a high level of data security. Multiple systems can be installed in the same area, and it is a suitable technology for point-to-multipoint communication.

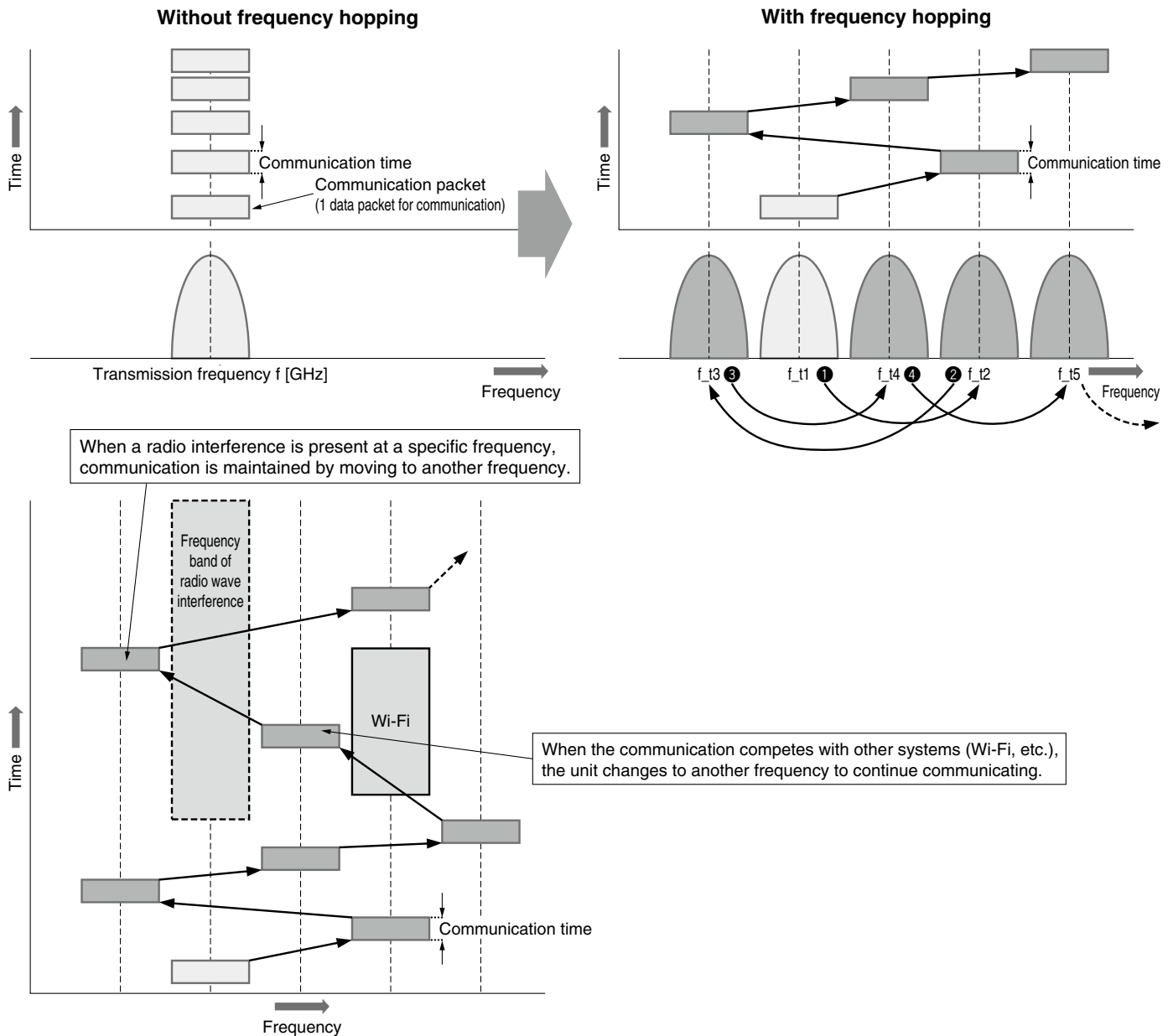



#### <Important>

- The product is certified as a wireless equipment in accordance with the Radio Act and the certificate of Technical Standard Conformity has been obtained. Customers do not need to apply for a license to use this equipment. Be sure to comply with the following precautions.
  - Do not disassemble or modify the product. Disassembly and modification are prohibited by law.
  - This product is for use in Japan, European countries (Austria, Belgium, Bulgaria, Croatia, Czech Republic, Denmark, Estonia, Finland, France, Germany, Greece, Hungary, Ireland, Italy, Latvia, Lithuania, Netherlands, Norway, Poland, Portugal, Romania, Slovakia, Slovenia, Spain, Sweden, Switzerland, U.K., Turkey), and the U.S. For use in other countries, please contact SMC.
- This product communicates by radio waves, and the communication may stop instantaneously due to ambient environments and operating methods. SMC will not be responsible for any secondary failure which may cause an accident or damage to other devices or equipment.
- When several units are installed closely to each other, slight interference may occur due to the characteristics of the wireless product.
- Do not use this product close to any equipment which may cause malfunction due to radio waves from this product.
- The communication performance is affected by the ambient environment, so please perform the communication testing before use.

## Safety Instructions

These safety instructions are intended to prevent hazardous situations and/or equipment damage. These instructions indicate the level of potential hazard with the labels of “**Caution**,” “**Warning**” or “**Danger**.” They are all important notes for safety and must be followed in addition to International Standards (ISO/IEC)\*1), and other safety regulations.

 **Caution:** **Caution** indicates a hazard with a low level of risk which, if not avoided, could result in minor or moderate injury.

 **Warning:** **Warning** indicates a hazard with a medium level of risk which, if not avoided, could result in death or serious injury.

 **Danger:** **Danger** indicates a hazard with a high level of risk which, if not avoided, will result in death or serious injury.

\*1) ISO 4414: Pneumatic fluid power – General rules relating to systems.  
ISO 4413: Hydraulic fluid power – General rules relating to systems.  
IEC 60204-1: Safety of machinery – Electrical equipment of machines.  
(Part 1: General requirements)  
ISO 10218-1: Manipulating industrial robots – Safety.  
etc.

### Warning

#### 1. The compatibility of the product is the responsibility of the person who designs the equipment or decides its specifications.

Since the product specified here is used under various operating conditions, its compatibility with specific equipment must be decided by the person who designs the equipment or decides its specifications based on necessary analysis and test results. The expected performance and safety assurance of the equipment will be the responsibility of the person who has determined its compatibility with the product. This person should also continuously review all specifications of the product referring to its latest catalog information, with a view to giving due consideration to any possibility of equipment failure when configuring the equipment.

#### 2. Only personnel with appropriate training should operate machinery and equipment.

The product specified here may become unsafe if handled incorrectly. The assembly, operation and maintenance of machines or equipment including our products must be performed by an operator who is appropriately trained and experienced.

#### 3. Do not service or attempt to remove product and machinery/equipment until safety is confirmed.

1. The inspection and maintenance of machinery/equipment should only be performed after measures to prevent falling or runaway of the driven objects have been confirmed.
2. When the product is to be removed, confirm that the safety measures as mentioned above are implemented and the power from any appropriate source is cut, and read and understand the specific product precautions of all relevant products carefully.
3. Before machinery/equipment is restarted, take measures to prevent unexpected operation and malfunction.

#### 4. Contact SMC beforehand and take special consideration of safety measures if the product is to be used in any of the following conditions.

1. Conditions and environments outside of the given specifications, or use outdoors or in a place exposed to direct sunlight.
2. Installation on equipment in conjunction with atomic energy, railways, air navigation, space, shipping, vehicles, military, medical treatment, combustion and recreation, or equipment in contact with food and beverages, emergency stop circuits, clutch and brake circuits in press applications, safety equipment or other applications unsuitable for the standard specifications described in the product catalog.
3. An application which could have negative effects on people, property, or animals requiring special safety analysis.
4. Use in an interlock circuit, which requires the provision of double interlock for possible failure by using a mechanical protective function, and periodical checks to confirm proper operation.

### Caution

#### 1. The product is provided for use in manufacturing industries.

The product herein described is basically provided for peaceful use in manufacturing industries.  
If considering using the product in other industries, consult SMC beforehand and exchange specifications or a contract if necessary.  
If anything is unclear, contact your nearest sales branch.

### Limited warranty and Disclaimer/ Compliance Requirements

The product used is subject to the following “Limited warranty and Disclaimer” and “Compliance Requirements”.

Read and accept them before using the product.

#### Limited warranty and Disclaimer

1. The warranty period of the product is 1 year in service or 1.5 years after the product is delivered, whichever is first.\*2)  
Also, the product may have specified durability, running distance or replacement parts. Please consult your nearest sales branch.
2. For any failure or damage reported within the warranty period which is clearly our responsibility, a replacement product or necessary parts will be provided.  
This limited warranty applies only to our product independently, and not to any other damage incurred due to the failure of the product.
3. Prior to using SMC products, please read and understand the warranty terms and disclaimers noted in the specified catalog for the particular products.

##### \*2) Vacuum pads are excluded from this 1 year warranty.

A vacuum pad is a consumable part, so it is warranted for a year after it is delivered.  
Also, even within the warranty period, the wear of a product due to the use of the vacuum pad or failure due to the deterioration of rubber material are not covered by the limited warranty.

#### Compliance Requirements

1. The use of SMC products with production equipment for the manufacture of weapons of mass destruction (WMD) or any other weapon is strictly prohibited.
2. The exports of SMC products or technology from one country to another are governed by the relevant security laws and regulations of the countries involved in the transaction. Prior to the shipment of a SMC product to another country, assure that all local rules governing that export are known and followed.

### Caution

#### SMC products are not intended for use as instruments for legal metrology.

Measurement instruments that SMC manufactures or sells have not been qualified by type approval tests relevant to the metrology (measurement) laws of each country. Therefore, SMC products cannot be used for business or certification ordained by the metrology (measurement) laws of each country.

## Safety Instructions

Be sure to read the “Handling Precautions for SMC Products” (M-E03-3) and “Operation Manual” before use.