

# Digital Valve Controller

New



- Can be used for rotary and linear actuators
- SIL 2 certified by TÜV (Acc. to IEC 61508)
- Equipped with self-diagnostics
- Equipped with fail safe function (fully closed/fully open)
- Compatible with HART communication
- Optional specifications
  - Arctic temperature specifications:  $-53$  to  $85^{\circ}\text{C}$
  - Limit switch
  - Position transmitter (in HART only)
  - Remote type



Standard: IP66/NEMA 4X enclosure

Flameproof (Ex d): IP66/NEMA 4X enclosure



ND7100 Series



ND7200 Series

## ND7000 Series

## ▶ Key Features

- Benchmark control performance on rotary and linear valves
- Reliable and robust design
- The rugged cover protects the unit from environmental hazards and external abuse
- Easy commissioning and operation
- Safety; SIL 2 certified by TÜV (Acc. to IEC 61508)
- Language selection: English, German and French
- Local/remote operation
- Remote mounting (option)
- Equipped with self-diagnostics  
Self-diagnostics/Deviation trend/Counters/Extended off-line tests



## ▶ Minimized process variability

- Linearisation of the valve flow characteristics
- Excellent dynamic and static control performance
- Fast response to control signal change
- Accurate internal measurements

## ▶ Easy installation and configuration

- Can be used for linear and rotary valves, double and single acting actuators
- Simple fast calibration and configuration using Local User Interface (LUI) using DTM/EDD in a remote location using DCS asset management tools
- Low power consumption enables installation to all common control systems

## ▶ Mounting on actuators and valves

- Mounted on single and double acting actuators
- Both rotary and linear valves
- Ability to attach options to electronics and mechanics later
- One-point calibration feature enables mounting without disturbing the process

## ▶ Open solution

- The ND7000 can be freely interfaced with software and hardware from a variety of manufacturers. Using this open architecture allows the ND7000 to be integrated with other field devices to give higher controllability.
- FDT and EDD based multi-vendor support configuration
- Support files for ND7000 are available at the following website: [www.metso.com/valves](http://www.metso.com/valves)

## ▶ Product reliability

- Designed to operate in harsh environmental conditions
- Rugged modular design
- Excellent temperature characteristics
- Vibration and impact tolerant
- IP66 enclosure
- Protected against humidity
- Wear resistant and sealed components
- Contact less position measurement

## ► Technical Description

The ND7000 is a 4 to 20 mA powered microcontroller-based digital valve controller. The device contains a Local User Interface (LUI) enabling local configuration. The powerful 32-bit microcontroller controls the valve position.

The measurements include:

- Input signal
- Valve position with contactless sensor
- Actuator pressures, 2 independent measurements
- Supply pressure
- Spool valve position
- Device temperature

Local User Interface (LUI) enables real time awareness of control parameters in the device at a glance.

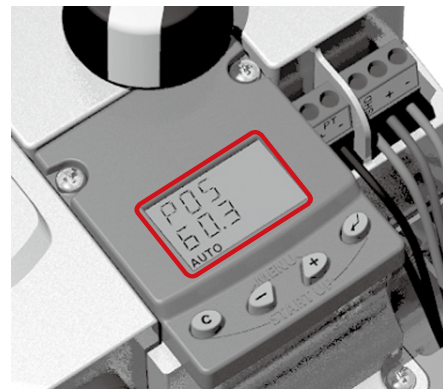

## Self-diagnostics

Self-diagnostics guarantees that all measurements operate correctly.

After connections of electric signal and pneumatic supply the ① micro controller ( $\mu C$ ) reads the input signal, ② position sensor ( $\alpha$ ), ③ pressure sensors ( $P_s, P_1, P_2$ ) and ④ spool position sensor (SPS).

⚠ A difference between input signal and ② position sensor ( $\alpha$ ) measurement is detected by control algorithm inside the ①  $\mu C$ .

The ①  $\mu C$  calculates a new value for ⑤ prestage (PR) coil current based on the information from the input signal and from the sensors. The changed current to the PR changes the pilot pressure to the spool valve. Reduced pilot pressure moves the spool and the ⑥ actuator pressures change accordingly.

⚠ The spool opens the flow to the driving side of the double diaphragm actuator and opens the flow out from the other side of the ⑥ actuator.

The increasing pressure will move the diaphragm piston. The ⑥ actuator and feedback shaft rotate. The ② position sensor ( $\alpha$ ) measures the rotation for the ①  $\mu C$ . The  $\mu C$  using control algorithm modulates the ⑤ PR-current from the steady state value until the new position of the ⑥ actuator, according to the input signal, is reached.

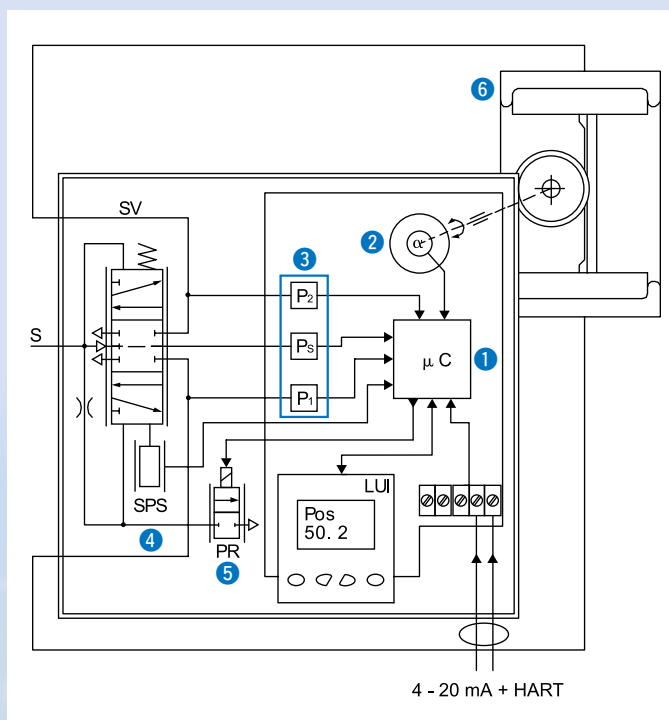

## Offline Test

ND7000 diagnostics includes four Offline Tests. The test results can be compared with earlier tests.

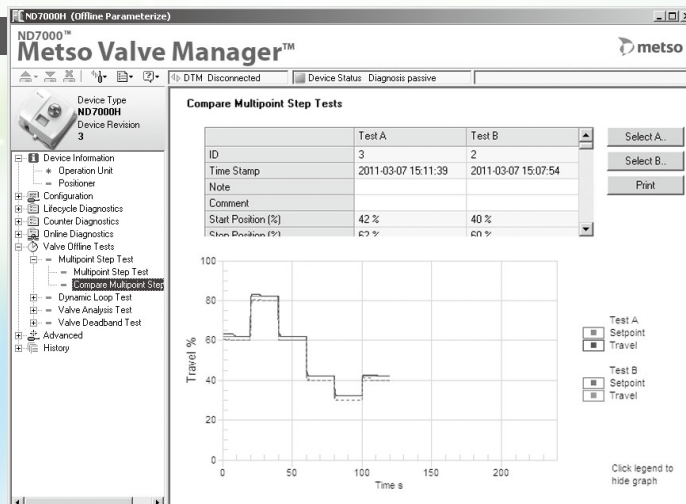

# ND7000 Series

## Specifications

### General

Loop powered, no external power supply required.  
Suitable for rotary and linear valves.  
Actuator connections in accordance with VDI/VDE 3845 and IEC 60534-6 standards.  
Action: Double or single acting  
Travel range: Linear; 10 to 120 mm  
Rotary; 45 to 95°  
Measurement range; 110° with freely rotating feed-back shaft

### Environmental influence

Standard temperature range: -40 to 85°C  
Arctic temperature range: -53 to 85°C  
Influence of temperature on valve position: 0.5%/10°C  
Influence of vibration on valve position:  
Less than 1% under 2G 5 to 150 Hz  
1G 150 to 300 Hz  
0.5G 300 to 2000 Hz

### Enclosure

	ND7100	ND7200
Material	Anodised aluminum alloy and polymer composite	Anodised aluminum alloy and tempered glass
Protection class	IP66, NEMA 4X	
Air connection port	G1/4	NPT1/4
Electrical connection port	M20 x 1.5	
Weight	1.8 kg	3.4 kg

\* Mechanical and digital position indicator visible through main cover.

### Supply air

Supply pressure: 0.14 to 0.8 MPa  
Effect of supply pressure on valve position:  
Less than 0.1% at 10% difference in inlet pressure  
Air quality : Acc. to ISO 8573-1  
Solid particles : Class 5 (3 to 5 µm filtration is recommended)  
Humidity : Class 1 (dew point 10°C below minimum temperature is recommended)  
Oil class : 3 (or less than 1 ppm)  
Capacity with 0.4 MPa supply:  
93 L/min(ANR) (spool valve 2)  
201 L/min(ANR) (spool valve 3)  
634 L/min(ANR) (spool valve 6)  
Consumption with 0.4 MPa supply in steady state position:  
< 9.9 L/min(ANR) (spool valve 2 and 3)  
< 17 L/min(ANR) (spool valve 6)

### Electronics

HART  
Supply power : Loop powered, 4 to 20 mA  
Minimum signal : 3.6 mA  
Current max : 120 mA  
Load voltage : Up to 9.7 VDC/20 mA (corresponding 485 Ω)  
Voltage : Max. 30 VDC  
Polarity protection : -30 VDC  
Over current protection: Active over 35 mA

### Performance with moderate constant-load actuators

Dead band: ≤ 0.1% F.S.  
Hysteresis: < 0.5% F.S.

### Local User Interface (LUI) functions

- Local control of the valve
- Monitoring of valve position, target position, input signal, temperature, supply and actuator pressure difference
- Guided-startup function
- LUI may be locked remotely to prevent unauthorized access
- Calibration: Automatic/manual, manual linearization, One-point calibration
- Control configuration: Aggressive, fast, optimum, stable, maximum stability
- Configuration of the control valve  
Rotation: Valve rotation clockwise or counter-clockwise to close  
Dead Angle  
Low cut-off, cut-off safety range (default 2%)  
Positioner fail action, open/close  
Signal direction: Direct/reverse acting  
Actuator type, double/single acting  
Valve type, rotary/linear  
Language selection: English, German and French

### Position transmitter (optional)

Output signal : 4 to 20 mA (galvanic isolation; 600 VDC)  
Supply voltage : 12 to 30 VDC  
Resolution : 16 bit/0.244 µA  
Linearity : Less than 0.05% F.S.  
Temperature effect: Less than 0.35% F.S.  
External load : Max. 0 to 780 Ω  
Max. 0 to 690 Ω for intrinsically safe

## Specifications

### Approvals and Electrical Values, HART

Certificate	Approval	Electrical values
<b>ATEX</b>		
ND_X VTT 09 ATEX 033X VTT 09 ATEX 034X EN 60079-0: 2009/2012 EN 60079-11: 2012 EN 60079-26: 2007 EN 60079-31: 2008 EN 60079-0: 2009/2012 EN 60079-11: 2012 EN 60079-15: 2010 EN 60079-31: 2008	II 1G Ex ia IIC T6...T4 Ga II 1D Ex ta IIIC T90°C Da II 2 G Ex ib IIC T6...T4 Gb II 2 D Ex tb IIIC T90°C Db II 1G Ex ia IIC T6...T4 Ga	Input: $U_i \leq 28 \text{ V}$ , $I_i \leq 120 \text{ mA}$ , $P_i \leq 1 \text{ W}$ , $C_i \leq 22 \text{ nF}$ , $L_i \leq 53 \mu\text{H}$ Output: $U_o \leq 28 \text{ V}$ , $I_o \leq 120 \text{ mA}$ , $P_o \leq 1 \text{ W}$ , $C_o \leq 22 \text{ nF}$ , $L_o \leq 53 \mu\text{H}$
	II 3 G Ex nA IIC T6...T4 Gc II 3 D Ex tc IIIC T90°C Dc	Input: $U_i \leq 30 \text{ V}$ , $I_i \leq 152 \text{ mA}$ Output: $U_o \leq 30 \text{ V}$ , $I_o \leq 152 \text{ mA}$
	II 3 G Ex ic IIC T6...T4 Gc II 3 D Ex tc IIIC T90°C Dc	Input: $U_i \leq 30 \text{ V}$ , $I_i \leq 152 \text{ mA}$ , $P_{\text{max}} = \text{device limits itself}$ , $C_i \leq 22 \text{ nF}$ , $L_i \leq 53 \mu\text{H}$
		Output: $U_o \leq 30 \text{ V}$ , $I_o \leq 152 \text{ mA}$ , $P_{\text{max}} = \text{device limits itself}$ , $C_o \leq 22 \text{ nF}$ , $L_o \leq 53 \mu\text{H}$
ND_E1 SIRA 11 ATEX 1006X EN 60079-0: 2009 EN 60079-1: 2007 EN 60079-31: 2009	II 2 G Ex d IIC T6...T4 Gb II 2 D Ex tb IIIC T80°C...T105°C Db	Input: $U_i \leq 30 \text{ V}$ Output: $U_o \leq 30 \text{ V}$ , $P_{\text{max}} = \text{device limits itself}$
<b>IECEX</b>		
ND_X IECEX VTT 10.0004X IECEX VTT 10.0005X IEC 60079-0: 2007/2011 IEC 60079-11: 2011 IEC 60079-26: 2006 IEC 60079-31: 2008 IEC 60079-0: 2007/2011 IEC 60079-11: 2011 IEC 60079-15: 2010 IEC 60079-31: 2008	Ex ia IIC T6...T4 Ga Ex ta IIIC T90°C Da Ex ib IIC T6...T4 Gb Ex tb IIIC T90°C Db	Input: $U_i \leq 28 \text{ V}$ , $I_i \leq 120 \text{ mA}$ , $P_i \leq 1 \text{ W}$ , $C_i \leq 22 \text{ nF}$ , $L_i \leq 53 \mu\text{H}$ Output: $U_o \leq 28 \text{ V}$ , $I_o \leq 120 \text{ mA}$ , $P_o \leq 1 \text{ W}$ , $C_o \leq 22 \text{ nF}$ , $L_o \leq 53 \mu\text{H}$
	Ex nA IIC T6...T4 Gc Ex tc IIIC T90°C Dc	Input: $U_i \leq 30 \text{ V}$ , $I_i \leq 152 \text{ mA}$ Output: $U_o \leq 30 \text{ V}$ , $I_o \leq 152 \text{ mA}$
	Ex ic IIC T6...T4 Gc Ex tc IIIC T90°C Dc	Input: $U_i \leq 30 \text{ V}$ , $I_i \leq 152 \text{ mA}$ , $P_{\text{max}} = \text{device limits itself}$ , $C_i \leq 22 \text{ nF}$ , $L_i \leq 53 \mu\text{H}$ Output: $U_o \leq 30 \text{ V}$ , $I_o \leq 152 \text{ mA}$ , $P_{\text{max}} = \text{device limits itself}$ , $C_o \leq 22 \text{ nF}$ , $L_o \leq 53 \mu\text{H}$
ND_E1 IECEX SIR 11.0001X IEC 60079-0: 2011 IEC 60079-1: 2007 IEC 60079-31: 2008	Ex d IIC T6...T4 Gb Ex tb IIIC T80°C...T105°C Db	Input: $U_i \leq 30 \text{ V}$ Output: $U_o \leq 30 \text{ V}$ , $P_{\text{max}} = \text{device limits itself}$
<b>INMETRO</b>		
ND_Z NCC 12.0793 X NCC 12.0794 X ABNT NBR IEC 60079-0: 2008 (2011) ABNT NBR IEC 60079-11: 2009 ABNT NBR IEC 60079-26: 2008 (2009) ABNT NBR IEC 60079-27: 2010 ABNT NBR IEC 60079-0: 2008 (2011) ABNT NBR IEC 60079-11: 2009 IEC 60079-15: 2010 ABNT NBR IEC 60079-27: 2010 ABNT NBR IEC 60529: 2009	Ex ia IIC T4/T5/T6 Ga Ex ia IIC T4/T5/T6 Gb	Input: $U_i \leq 28 \text{ V}$ , $I_i \leq 120 \text{ mA}$ , $P_i \leq 1 \text{ W}$ , $C_i \leq 22 \text{ nF}$ , $L_i \leq 53 \mu\text{H}$ Output: $U_o \leq 28 \text{ V}$ , $I_o \leq 120 \text{ mA}$ , $P_o \leq 1 \text{ W}$ , $C_o \leq 22 \text{ nF}$ , $L_o \leq 53 \mu\text{H}$
	Ex nA IIC T4/T5/T6 Gc	Input: $U_i \leq 30 \text{ V}$ , $I_i \leq 152 \text{ mA}$ Output: $U_o \leq 30 \text{ V}$ , $I_o \leq 152 \text{ mA}$
	Ex ic IIC T4/T5/T6 Gc	Input: $U_i \leq 30 \text{ V}$ , $I_i \leq 152 \text{ mA}$ , $P_{\text{max}} = \text{device limits itself}$ , $C_i \leq 22 \text{ nF}$ , $L_i \leq 53 \mu\text{H}$ Output: $U_o \leq 30 \text{ V}$ , $I_o \leq 152 \text{ mA}$ , $P_{\text{max}} = \text{device limits itself}$ , $C_o \leq 22 \text{ nF}$ , $L_o \leq 53 \mu\text{H}$
ND_E5 NCC 12.0795 X ABNT NBR IEC 60079-0: 2008 (2011) ABNT NBR IEC 60079-1: 2009 (2011) ABNT NBR IEC 60079-31: 2011 ABNT NBR IEC 60529: 2009	Ex d IIC T4/T5/T6 Gb Ex tb IIIC T100°C Db IP66	Input: $U_i \leq 30 \text{ V}$ Output: $U_o \leq 30 \text{ V}$ , $P_{\text{max}} = \text{device limits itself}$
<b>Japanese Ex-d Certification</b>		
ND_E4	II 2 G Ex d IIC T6 Gb II 2 D Ex tb IIIC T80°C Db	Input: $U_i \leq 30 \text{ V}$ Output: $U_o \leq 30 \text{ V}$ , $P_{\text{max}} = \text{device limits itself}$





## How to Order

**ND7 1 03 H X T V02 /K05 -CG5-AR**

Digital Valve Controller

1 2 3 4 5 6 7

8 • Branded Model for SMC

9 Additional Accessories\*1  
(Refer to page 7 for details.)

### 2 Series Code

Series 7000 digital valve controller with universal shaft and attachment face according to standard VDI/VDE 3845.

### 3 Enclosure

1	Standard IP66/NEMA 4X enclosure.
2	Flameproof (Ex d) IP66/NEMA 4X enclosure.

\*1 The part numbers of 9 additional accessories are not included on the product name plate.

### 5 Communication/Input Signal Range

4 to 20 mA, HART communication. Supply voltage 30 VDC.  
Load voltage: Up to 9.7 VDC at 20 mA corresponding to 485 Ω (maximum voltage drop).

### 4 Spool Valve

	Spool Valve	Pneumatic Connections (S, C1, C2)
02	Low capacity. Stroke volume of actuator < 1 L.	G1/4 (ND7100) NPT1/4 (ND7200)
03	Medium capacity. Stroke volume of actuator 1 to 3 L.	G1/4 (ND7100) NPT1/4 (ND7200)
06	High capacity. Stroke volume of actuator > 3 L.	G1/4 (ND7100) NPT1/4 (ND7200)

### 6 Approvals for Hazardous Areas

<b>N</b>	No approvals for hazardous areas. M20 x 1.5 conduit entry. Temperature range: -40 to 85°C. Not applicable to 3 sign "2".	<b>E1</b>	<b>ATEX and IECEx certifications:</b> II 2 G Ex d IIC T6...T4 Gb II 2 D Ex tb IIIC T80°C...T105°C Db Temperature range: T4: -40 to 85°C T5: < 75°C T6: < 60°C Not applicable to 3 sign "1". M20 x 1.5 conduit entry.
<b>N7</b>	N7 No approvals for hazardous areas. Like N, but this is with Russian language machine plate. Not applicable to 3 sign "2".		
<b>X</b>	<b>ATEX and IECEx certifications:</b> II 1 G Ex ia IIC T6...T4 Ga II 1 D Ex ta IIIC T90°C Da II 2 G Ex ib IIC T6...T4 Gb II 2 D Ex tb IIIC T90°C Db Temperature range: T4: -40 to 80°C T5: < 65°C T6: < 50°C	<b>E4</b>	<b>Japanese Ex-d certification:</b> II 2 G Ex d IIC T6 Gb II 2 D Ex tb IIIC T80°C Db Temperature range: T6: < 60°C Not applicable to 3 sign "1". A cable gland approved by IECEx is required. Select an appropriate cable gland from additional accessories for positioners (accessory CG43 or CG44). CG43: NPT1/2 conduit entry and cable entry adapter CG44: G1/2 conduit entry and cable entry adapter
	II 3 G Ex nA IIC T6...T4 Gc II 3 D Ex tc IIIC T90°C Dc II 3 G Ex ic IIC T6...T4 Gc II 3 D Ex tc IIIC T90°C Dc Temperature range: T4: -40 to 85°C T5: < 75°C T6: < 60°C M20 x 1.5 conduit entry.		
<b>X7</b>	<b>ATEX and IECEx certifications:</b> Like X, but this is with Russian language machine plate. Check details of marking from X	<b>E5</b>	<b>INMETRO certifications:</b> Ex d IIC T4/T5/T6 Gb Ex tb IIIC T100°C Db IP66 Temperature range: T4: -40 to 85°C T5: < 75°C T6: < 60°C Not applicable to 3 sign "1". M20 x 1.5 conduit entry.
<b>Z</b>	<b>INMETRO certifications:</b> Ex ia IIC T4/T5/T6 Ga Ex ia IIC T4/T5/T6 Gb Ex nA IIC T4/T5/T6 Gc Ex ic IIC T4/T5/T6 Gc M20 x 1.5 conduit entry. Not applicable to 3 sign "2".	<b>E7</b>	<b>ATEX and IECEx certifications:</b> Like E1, but this is with Russian language machine plate. Check details of marking from E1

### 7 Options of Valve Controller

<b>Nil</b>	None	<b>R</b>	Remote mounting Applicable to 3 sign "1" only. Applicable to 6 sign "N" and "N7". * Not applicable to limit switch. Requires always external position measurement. For rotary actuator see accessories type code. Output values for: HART Uo (Voc) = 3.53 V, Io (Isc) = 12.6 mA, Po = 11.1 mW, Co (Ca) = 10 nF, Lo (La) = 10 μH
<b>T</b>	Internal 2-wire (passive) position transmitter. Analog position feedback signal, output 4 to 20 mA, supply voltage 12 to 30 VDC, external load resistance 0 to 780 Ω. <b>ND7_HXT, ND7_HZT:</b> II 1 G Ex ia IIC T6...T4 Ga II 1 D Ex ta IIIC T90°C Da II 2 G Ex ib IIC T6...T4 Gb II 2 D Ex tb IIIC T90°C Db Ui ≤ 28 V, Ii ≤ 120 mA, Pi ≤ 1 W, Ci ≤ 22 nF, Li ≤ 53 μH, external load resistance 0 to 690 Ω. <b>ND7_HXT, ND7_HZT:</b> II 3 G Ex nA IIC T6...T4 Gc II 3 D Ex tc IIIC T90°C Dc Ui ≤ 30V, Ii ≤ 152 mA  II 3 G Ex ic IIC T6...T4 Gc II 3 D Ex tc IIIC T90°C Dc Ui ≤ 30 V, Ii ≤ 152 mA, Pmax = device limits itself, Ci ≤ 22 nF, Li ≤ 53 μH, external load resistance 0 to 780 Ω.		
		<b>C</b>	Arctic temperature option. Temperature range: -53 to 85 °C Applicable to 3 sign "2". Applicable to 6 sign "X", "X7", "E1" and "E7". * Limit switch may limit the temperature range

### 8 Limit Switch Type

<b>Nil</b>	None
<b>/I02</b>	P+F; NJ2-12GK-SN, 2-wire type, DC; > 3 mA; < 1 mA, NAMUR NC Temperature range: -40 to 85°C Not applicable to 6 sign "E4". Usable up to SIL3 acc. to IEC61508 * In safety-related applications the sensor must be operated with a qualified fail safe interface, such as P+F KFD2-SH-EX1.
<b>/I41</b>	P+F; NJ4-12GK-SN, 2-wire type, DC; > 3 mA; < 1 mA, NAMUR NC Temperature range: -50 to 85°C Applicable to 6 sign "N", "N7", "X", "X7", "E1" and "E7". * That device may limit temperature range.
<b>/K05</b>	Omron D2VW-5, 3 A to 250 VAC, 0.4 A to 125 VDC, 5 A to 30 VDC. Temperature range: -40 to 85°C Not applicable to 6 sign "X", "X7", "Z" and "E4".

# ND7000 Series

Additional accessory symbol: When more than one accessory is required, indicate in ascending numerical order from 1) to 8).

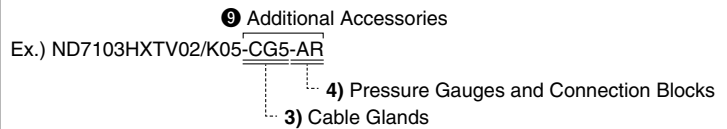

\*1 The part numbers of 9) additional accessories are not included on the product name plate.

## 9) Additional Accessories

### 1) Filter Regulator

Nil	None
-KS	Filter regulator for supply air Nominal filtration rating 5 μm Pressure gauge, scale bar, psi, kPa, kg/cm <sup>2</sup> , basic material: brass, nickel plated, housing stainless steel, glycerine filled Temperature range -40 to 82°C KS option includes a thread nipple NPT1/4" to NPT1/4" between filter regulator and positioner which is suitable with ND7100 and ND7200 positioner options A3 and A5 (NPT1/4 air connection). Supply air connector in the filter regulator is female 1/4".
-K1S	Filter regulator for supply air Nominal filtration rating 5 μm Pressure gauge, scale bar, psi, kPa, kg/cm <sup>2</sup> , basic material: brass, nickel plated, housing stainless steel, glycerine filled Temperature range -40 to 82°C K1S option includes a thread nipple NPT1/4" to G1/4" between filter regulator and positioner which is suitable with ND7100 positioner and with option A1 (G1/4 air connection). Supply air connector in the filter regulator is female 1/4".

### 2) Conduit Entry Nipples

Nil	None
-CE07	NPT1/2 conduit entry nipples M20 x 1.5/NPT1/2 (ND7100)
-CE08	R1/2 (PF1/2) conduit entry nipples M20 x 1.5/R1/2 (ND7100)
-CE09	NPT1/2 conduit entry nipples Brass M20 x 1.5/NPT1/2, Exd approved (ND7200) Not applicable to 6) sign "E4".

### 3) Cable Glands

Not to be used together with conduit entry nipples (CE\_) or connection plugs (P\_).

Nil	None
-CG5	M20 x 1.5 grey/plastic, IP66 (Not applicable to 9) sign "2".)
-CG6	M20 x 1.5 blue/plastic, IP66, Ex e (Not applicable to 9) sign "2".)
-CG43	Conduit entry and cable entry adapter for ND7200 M20 (male thread)/NPT1/2 (female thread) SS Ex d II C Ex db II C Gb, IP66
-CG44	Conduit entry and cable entry adapter for ND7200 M20 (male thread)/G1/2 (female thread) SS Ex d II C Ex db II C Gb, IP66

### 4) Pressure Gauges and Connection Blocks

Nil	None
-A1*1	Pressure gauges, scale 0-12 bar, psi, kPa, kg/cm <sup>2</sup> , basic material: brass, nickel plated, housing stainless steel, oil filled Temperature range: -40 to 85°C/-40 to 185°F Pneumatic connection block, material: AISiMg, anodized grey, connections G1/4 (S, C1, C2), only for ND7100.
-A1B*1	Same as A1 but includes two pressure gauges with G1/4 (S, C2) connections Only for use with the single-acting type, only for ND7100.
-A3*1	Pressure gauges, scale 0-12 bar, psi, kPa, kg/cm <sup>2</sup> , Basic material: brass, nickel plated, housing stainless steel, oil filled Temperature range: -40 to 85°C/-40 to 185°F Pneumatic connection block, material: AISiMg, anodized grey, connections NPT1/4 (S, C1, C2), also converts ND71_ connections to NPT1/4
-A3B*1	Same as A3 but includes two pressure gauges with NPT1/4 (S, C2) connections, also converts ND71_ connections to NPT1/4 Only for use with the single-acting type.
-A5	Pneumatic connection block, converts ND71_ connections to NPT1/4 Material: AISiMg, anodized grey Connections NPT1/4 (S, C1, C2), only for ND7100.
-D3*1	Non oil filled, dry pressure gauges, scale 0-12 bar, psi, kPa, kg/cm <sup>2</sup> , Basic material: brass, nickel plated, housing stainless steel Temperature range: -40 to 85°C/-40 to 185°F Pneumatic connection block, material: AISiMg, anodized grey, connections NPT1/4 (S, C1, C2), also converts ND71_ connections to NPT1/4
-D3B*1	Same as D3 but includes two pressure gauges with NPT1/4 (S, C2) connections, also converts ND71_ connections to NPT1/4 Only for use with the single-acting type.
-AR	Pressure gauges, scale 0.1-1.2 MPa, basic material: brass, nickel plated, housing stainless, glycerin filled Temperature range: -50 to 85°C/-67 to 185°F Pneumatic connection block, material: AISiMg, connections Rc1/4 (S, C1, C2)
-ARB	Same as AR but includes two pressure gauges with Rc1/4 (S, C2) connections Only for use with the single-acting type.

\*1 Under the New Measurement Law, products for overseas use only (SI unit type for use in Japan)



## 5) Connection Plugs

Not to be used together with conduit entry nipples (CE\_) or cable glands (CG\_).

<b>Nil</b>	None
<b>-P1H</b>	ND7100 (HART): Connection plug according to M20 x 1.5/DIN 43650A (ISO 4400) Not applicable to <b>6</b> sign "X" and "X7".

## 6) Driver Sets (Connection Fitting)

Driver sets including the needed parts when assembling ND7000 on rotary actuators with VDI/VDE 3845 attachment face or Neles standard mounting faces. Select the correct driver set according to the actuator and the pneumatic connections of valve controller or gauge block when applicable.

\* Earlier the DS04 was delivered with bareshaft positioners as default. This practice is no longer valid, the needed driver set must be ordered as an accessory.

<b>Nil</b>	None
<b>-DS01</b>	Driver set for ND7100 on actuators with VDI/VDE3845 attachment face Set includes the G1/4 plug for single acting actuators. The driver set should also be applied with all ND7/9 with gauge blocks A1, A1B, A2 or A6.
<b>-DS02</b>	Driver set for ND7200 on actuators with VDI/VDE 3845 attachment face Set includes the NPT1/4 plug for single acting actuators. The driver set should also be applied with all ND with gauge blocks A3, A3B, A5, A7 or A10.
<b>-DS04</b>	General driver set for ND7100/7200 on actuators with VDI/VDE 3845, actuators of Neles E Series, or actuators with Neles standard attachment face (e.g. when replacing NE7/NP7 or ND800 with S2 shaft). Earlier default driver set. The set includes the NPT1/8, NPT1/4, and G1/4 plugs needed when used with a single acting actuator or flush mounted on an E Series actuator.

## 7) 3rd Party Mounting Sets

Mounting sets between the ND7000 valve controllers and linear actuators, including bracket and ball joint based feedback system.

\* Sets are including the pneumatic plugs needed when used with single acting actuators.  
All available mounting sets listed in [http://www2.stonel.com/utilities/metso/mkdbase\\_open.htm](http://www2.stonel.com/utilities/metso/mkdbase_open.htm)

<b>Nil</b>	None
<b>-MS01</b>	Mounting set for linear actuators, attachment face according to IEC 60534-6, stroke length 10 to 55 mm
<b>-MS02</b>	Mounting set for linear actuators, attachment face according to IEC 60534-6, stroke length 55 to 120 mm
<b>-MS03</b>	Mounting set for Masoneilan 87/88 actuators, sizes 6 to 23 Stroke length 12 to 64 mm

## 8) Remote Mounting Accessories

<b>Nil</b>	
<b>-RR01</b>	ND remote mount rotary sensor QNCOK05HDM
<b>-RR02</b>	ND remote mount rotary sensor QNCAK05HDM
<b>-RC01</b>	Cable assembly remote mount sensor cable 1.2 m, straight connector
<b>-RC02</b>	Cable assembly remote mount sensor cable 3.0 m, angle connector
<b>-RC03</b>	Cable assembly remote mount sensor cable 30 m, angle connector

# ND7000 Series

## Countries and Regions Where ND7000 Series Products are Available

### Countries Where Products are Available

ND7000 series products are only available in the countries and regions listed below. For details, contact your nearest sales branch.



#### Europe



**1 Austria**  
**SMC Austria GmbH**  
 Girakstrasse 8, AT-2100 Korneuburg, Austria  
 URL <http://www.smc.at>



**2 Belgium**  
**SMC Belgium N.V./S.A**  
 Temesselei 232, 2160 Wommelgem, Belgium  
 URL <http://www.smc-pneumatics.be>



**3 Finland**  
**SMC Automation Oy**  
 PB72, 02231, Espoo, Finland  
 URL <http://www.smc.fi>



**4 Germany**  
**SMC Deutschland GmbH**  
 Boschring 13-15, 63329 Egelsbach, Germany  
 URL <http://www.smc.de>



**5 Italy**  
**SMC Italia S.p.A.**  
 Via delle Donne Lavoratrici, 20861 Brugherio (MB)  
 URL <http://www.smcitalia.it>



**6 Netherlands**  
**SMC Nederland B.V.**  
 De Ruyterkade 120, NL-1011 AB Amsterdam, the Netherlands  
 URL <http://www.smc.nl>



**7 Russia**  
**SMC Pneumatik LLC**  
 Business center, building 3, 15 Kondratjevskij prospect, St.Petersburg, Russia, 195197  
 URL <http://www.smc-pneumatik.ru/>



**8 Spain**  
**SMC España SA**  
 Zuazobidea 14, 01015 Vitoria, Spain  
 URL <http://www.smc.eu>



**9 Sweden**  
**SMC Automation AB**  
 Ekhagsvägen 29-31, SE-141 71 Segeltorp, Sweden  
 URL <http://www.smc.nu>



**10 U.K.**  
**SMC Pneumatics (U.K.) Ltd.**  
 Vincent Avenue, Crownhill, Milton Keynes, Buckinghamshire MK8 0AN, United Kingdom  
 URL <http://www.smc-pneumatics.co.uk/>



**11 Brazil**  
**SMC Automação do Brasil Ltda.**  
 Av. Piraporinha, 777 Barro Planalto, São Bernardo do Campo São Paulo, Brazil  
 URL <http://www.smcbr.com.br>



**12 Chile**  
**SMC Corporation (Chile), S.A.**  
 Av. La Montana, #1115 P. Norte km. 16.5 Parque Industrial Valle Grande, Lampa, Santiago, Chile  
 URL <http://www.smcchile.cl>



**13 Mexico**  
**SMC Corporation (Mexico), S.A. de C.V.**  
 Carr. Silao-Trejo K.M. 2.5 S/N Predio San Jose del Durazno C.P. 36100, Silao, Gto. Mexico  
 URL <http://www.smc.com.mx>



**14 Peru**  
**SMC Corporation Peru S.A.C.**  
 AV.Argentina 2078 -Lima-Lima-Peru.  
 URL <http://www.smcperu.com>



**15 Australia**  
**SMC Corporation (Australia) Pty Ltd**  
 14-18 Hudson Avenue, Castle Hill, Sydney, New South Wales 2154, Australia  
 URL <http://www.smcworld.com/en-jp/>



**16 China <Beijing / Shanghai Area>**  
**SMC (China) Co., Ltd.**  
 A2, XingSheng Street, BDA, Beijing, 100176 P.R. China  
 URL <http://www.smc.com.cn>



**17 China <Guangzhou Area>**  
**SMC Automation (Guangzhou) Ltd.**  
 2, Dongming Road 3, Science Park Guangzhou Hi-Tech Industrial Development Zone, Guangzhou, P.R.China  
 URL <http://www.smcgz.com.cn>



**18 India**  
**SMC Corporation (India) Pvt. Ltd.**  
 A-4, Sector-88, Noida-201 305 India  
 URL <http://www.smc.in>



**19 Japan**  
**SMC Corporation**  
 Akihabara UDX 15F, 4-14-1, Sotokanda, Chiyoda-ku, Tokyo, Japan  
 URL <https://www.smcworld.com>



**20 New Zealand**  
**SMC Corporation (NZ) Limited**  
 5 Pacific Rise Mt Wellington Auckland 1060, New Zealand (P O Box 62-226, Sylvia Park, Auckland, 1644)  
 URL <http://www.smcworld.com/en-jp/>



**21 Taiwan**  
**SMC Automation (Taiwan) Co., Ltd.**  
 No.16, Lane 205, Nansan Rd., Sec.2, Luzhu-Dist. Taoyuan-City, Taiwan  
 URL <http://www.smc.com.tw>





**22 Thailand**  
**SMC Thailand Ltd.**  
 134/6 Moo 5, Tiwanon Road, Bangkadi Amphur, Muang, Patumthani 12000, Thailand  
 URL <http://www.smcthai.co.th>

\* The names of countries listed in each area are alphabetically indexed.

As of September 2019

# ND7000 Series

# Comparison of Specifications

Model		ND7000 Series	ND9000 Series
Product name		Digital Valve Controller	Intelligent Valve Controller
Item			 Refer to the <b>Web Catalog</b> for details.
Input current		4 to 20 mA DC	
Min. operating current		3.6 mA DC	
Supply pressure		0.14 to 0.8 MPa	
Valve type (Standard stroke)	Linear	10 to 120 mm	10 to 120 mm
	Rotary	45 to 95°	45 to 95°
Actuator type	Single acting	Can be used for both types	Can be used for both types
	Double acting	Can be used for both types	Can be used for both types
Stroke/Opening feedback type		Mechanical joint	
Performance	Hysteresis	< 0.5% F.S.	
	Dead band	≤ ±0.1% F.S.	
	Coefficient of temperature	≤ 0.5% F.S./10°C	
	Output flow (Supply pressure: 0.4 MPa)	93 L/min (ANR) (Spool valve 02)	
		201 L/min (ANR) (Spool valve 03)	
		634 L/min (ANR) (Spool valve 06)	
	Air consumption (Supply pressure: 0.4 MPa)	< 9.9 L/min (ANR) (Spool valves 02 and 03)	
< 17 L/min (ANR) (Spool valve 06)			
Ambient and fluid temperatures		-40 to 85°C	
Exterior covering enclosure		IP66, NEMA 4X	
Low-temperature specification		○ (-53 to 85°C)	○ (-53 to 85°C)
Safety integrity level (IEC 61580)	SIL	SIL 2	SIL 2
Explosion proof construction (Option)	Intrinsically safe explosion-proof	○	○
	Explosion-proof	○	○
Transmission	HART	●	●
	Profibus PA	—	○
	FOUNDATION fieldbus	—	○
Limit switch		○	○
Position transmitter (in HART only)		○	○
Remote type		○	○
Self-diagnostics		●	● (Advanced)
Fail safe (fully closed/fully open)		●	●
Corrosion resistant	Stainless steel enclosure	—	● (ND93 series)
	Stainless steel body/ Polymer composite cover	—	● (ND94 series)
Air connection port	Rc1/4 female thread	○ (Adapter)	○ (Adapter)
	NPT1/4 female thread	● (ND72 series)	● (ND92, ND93, ND94 series)
	G1/4 female thread	● (ND71 series)	● (ND91 series)
Electrical connection port	M20 female thread	●	●
	NPT1/2 female thread	○ (In compliance with explosion-proof specifications)	○ (In compliance with explosion-proof specifications)
	G1/2 female thread	○ (In compliance with explosion-proof specifications)	○ (In compliance with explosion-proof specifications)
Weight		1.8 kg Standard/Intrinsically safe explosion-proof (ND71 series) 3.4 kg Flameproof (ND72 series)	1.8 kg Standard/Intrinsically safe explosion-proof (ND91 series) 3.4 kg Flameproof (ND92 series) 8.6 kg Stainless steel enclosure (ND93 series) 5.6 kg Stainless steel body/Polymer composite cover (ND94 series)

●: Standard ○: Option

## Safety Instructions

These safety instructions are intended to prevent hazardous situations and/or equipment damage. These instructions indicate the level of potential hazard with the labels of “**Caution**,” “**Warning**” or “**Danger**.” They are all important notes for safety and must be followed in addition to International Standards (ISO/IEC)\*1), and other safety regulations.

 **Caution:** **Caution** indicates a hazard with a low level of risk which, if not avoided, could result in minor or moderate injury.

 **Warning:** **Warning** indicates a hazard with a medium level of risk which, if not avoided, could result in death or serious injury.

 **Danger:** **Danger** indicates a hazard with a high level of risk which, if not avoided, will result in death or serious injury.

\*1) ISO 4414: Pneumatic fluid power – General rules relating to systems.  
ISO 4413: Hydraulic fluid power – General rules relating to systems.  
IEC 60204-1: Safety of machinery – Electrical equipment of machines.  
(Part 1: General requirements)  
ISO 10218-1: Manipulating industrial robots – Safety.  
etc.

### Warning

#### 1. The compatibility of the product is the responsibility of the person who designs the equipment or decides its specifications.

Since the product specified here is used under various operating conditions, its compatibility with specific equipment must be decided by the person who designs the equipment or decides its specifications based on necessary analysis and test results. The expected performance and safety assurance of the equipment will be the responsibility of the person who has determined its compatibility with the product. This person should also continuously review all specifications of the product referring to its latest catalog information, with a view to giving due consideration to any possibility of equipment failure when configuring the equipment.

#### 2. Only personnel with appropriate training should operate machinery and equipment.

The product specified here may become unsafe if handled incorrectly. The assembly, operation and maintenance of machines or equipment including our products must be performed by an operator who is appropriately trained and experienced.

#### 3. Do not service or attempt to remove product and machinery/equipment until safety is confirmed.

1. The inspection and maintenance of machinery/equipment should only be performed after measures to prevent falling or runaway of the driven objects have been confirmed.
2. When the product is to be removed, confirm that the safety measures as mentioned above are implemented and the power from any appropriate source is cut, and read and understand the specific product precautions of all relevant products carefully.
3. Before machinery/equipment is restarted, take measures to prevent unexpected operation and malfunction.

#### 4. Contact SMC beforehand and take special consideration of safety measures if the product is to be used in any of the following conditions.

1. Installation on equipment in conjunction with atomic energy, railways, air navigation, space, shipping, vehicles, military, medical treatment, combustion and recreation, or equipment in contact with food and beverages, emergency stop circuits, clutch and brake circuits in press applications, safety equipment or other applications unsuitable for the standard specifications described in the product catalog.
2. An application which could have negative effects on people, property, or animals requiring special safety analysis.
3. Use in an interlock circuit, which requires the provision of double interlock for possible failure by using a mechanical protective function, and periodical checks to confirm proper operation.

## Limited warranty and Disclaimer/ Compliance Requirements

The product used is subject to the following “Limited warranty and Disclaimer” and “Compliance Requirements”. Read and accept them before using the product.

### Limited warranty and Disclaimer

**Scope of Warranty:** Warranty shall be granted for non-conformity of the Company's product (“Product”) to the relevant specifications. Any such non-conformity resulting from wear of expendable parts resulting from the Customer's normal use thereof, or from the Customer's inappropriate, insufficient or inexperienced maintenance or from the Customer's inappropriate storage, installation, use, operation or the like, or from the Customer's modification or the like are excluded from warranty.

**Period of Warranty:** One (1) year from the commencement of use by the Customer or one year and half (1.5) from the delivery of the Product; whichever expires earlier.

**Claiming Procedures:** If the Customer determines that the Product is non-conforming, the Customer shall immediately notify the Company. If the notice does not arrive at the Company within two (2) weeks from the date of expiration of the relevant warranty period, the Customer's rights to warranty is forfeited. Even in the case where the notice arrives within the period prescribed above, liability for any damage arising from any delay of the notice shall be borne by the Customer.

**Remedies:** If any non-conformity is actually found in the Product as a result of an inspection made by the Company, the Company shall, upon consultation, repair or replace the Product. The Company will not accept any other claims (such as monetary compensation).

**Related Expenses:** Where the Product is eligible for warranty, shipment expenses therefor shall be borne by the Company. Regardless of whether or not the Product is eligible for warranty, expenses for removal and installation incurred in relation to replacement of the Product shall be borne by the Customer.

**Limitation of Liability:** Even if any legal liability in whichever form other than the warranties set forth above arises in respect of the Company, the Company's scope of liability shall be limited as follows:

- The Company shall be held liable only to the extent that the relevant liability is caused by its act or omission due to its negligence.
- The Company's liability shall not exceed the amount of direct damages incurred by the Customer in respect of the Product, and the Company shall not be held liable for any indirect, contingent, consequential or punitive damage.
- The Company's liability shall not exceed the amount of the sales price of the Product.
- The Company shall not be held liable for any damage caused to the nuclear energy, space or aviation business, for any damage due to any force majeure events including war, terrorist activities or natural disasters, or for compliance with safety regulations or environmental regulations that is beyond the scope of business of the Company.

### Compliance Requirements

1. The use of SMC products with production equipment for the manufacture of weapons of mass destruction (WMD) or any other weapon is strictly prohibited.
2. The exports of SMC products or technology from one country to another are governed by the relevant security laws and regulations of the countries involved in the transaction. Prior to the shipment of a SMC product to another country, assure that all local rules governing that export are known and followed.

### Caution

**SMC products are not intended for use as instruments for legal metrology.** Measurement instruments that SMC manufactures or sells have not been qualified by type approval tests relevant to the metrology (measurement) laws of each country. Therefore, SMC products cannot be used for business or certification ordained by the metrology (measurement) laws of each country.

## Safety Instructions

Be sure to read the “Handling Precautions for SMC Products” (M-E03-3) and “Operation Manual” before use.