



Operation Manual

High Speed Pilot Operated
Solenoid Valve

PRODUCT NAME

DXT1215

MODEL/ Series

SMC Corporation

Contents

Contents	1
Safety Instructions	2,3
Design/Selection	4,5
Mounting	5
Piping	5
Wiring	6
Lubrication	6
Air Supply	6
Operating Environment	7
Maintenance	7
Specific Product Precautions	8
Valve Construction	9
Trouble shooting	10,11



Safety Instructions

These safety instructions are intended to prevent hazardous situations and/or equipment damage. These instructions indicate the level of potential hazard with the labels of “Caution,” “Warning” or “Danger.” They are all important notes for safety and must be followed in addition to International Standards (ISO/IEC)*1), and other safety regulations.

*1) ISO 4414: Pneumatic fluid power -- General rules relating to systems.

ISO 4413: Hydraulic fluid power -- General rules relating to systems.

IEC 60204-1: Safety of machinery -- Electrical equipment of machines .(Part 1: General requirements)

ISO 10218: Manipulating industrial robots -Safety.

etc.



Caution

Caution indicates a hazard with a low level of risk which, if not avoided, could result in minor or moderate injury.



Warning

Warning indicates a hazard with a medium level of risk which, if not avoided, could result in death or serious injury.



Danger

Danger indicates a hazard with a high level of risk which, if not avoided, will result in death or serious injury.



Warning

1. The compatibility of the product is the responsibility of the person who designs the equipment or decides its specifications.

Since the product specified here is used under various operating conditions, its compatibility with specific equipment must be decided by the person who designs the equipment or decides its specifications based on necessary analysis and test results.

The expected performance and safety assurance of the equipment will be the responsibility of the person who has determined its compatibility with the product.

This person should also continuously review all specifications of the product referring to its latest catalog information, with a view to giving due consideration to any possibility of equipment failure when configuring the equipment.

2. Only personnel with appropriate training should operate machinery and equipment.

The product specified here may become unsafe if handled incorrectly.

The assembly, operation and maintenance of machines or equipment including our products must be performed by an operator who is appropriately trained and experienced.

3. Do not service or attempt to remove product and machinery/equipment until safety is confirmed.

1. The inspection and maintenance of machinery/equipment should only be performed after measures to prevent falling or runaway of the driven objects have been confirmed.

2. When the product is to be removed, confirm that the safety measures as mentioned above are implemented and the power from any appropriate source is cut, and read and understand the specific product precautions of all relevant products carefully.

3. Before machinery/equipment is restarted, take measures to prevent unexpected operation and malfunction.

4. Contact SMC beforehand and take special consideration of safety measures if the product is to be used in any of the following conditions.

1. Conditions and environments outside of the given specifications, or use outdoors or in a place exposed to direct sunlight.

2. Installation on equipment in conjunction with atomic energy, railways, air navigation, space, shipping, vehicles, military, medical treatment, combustion and recreation, or equipment in contact with food and beverages, emergency stop circuits, clutch and brake circuits in press applications, safety equipment or other applications unsuitable for the standard specifications described in the product catalog.

3. An application which could have negative effects on people, property, or animals requiring special safety analysis.

4. Use in an interlock circuit, which requires the provision of double interlock for possible failure by using a mechanical protective function, and periodical checks to confirm proper operation.



Safety Instructions

Caution

The product is provided for use in manufacturing industries.

The product herein described is basically provided for peaceful use in manufacturing industries.

If considering using the product in other industries, consult SMC beforehand and exchange specifications or a contract if necessary.

If anything is unclear, contact your nearest sales branch.

Limited warranty and Disclaimer/Compliance Requirements

The product used is subject to the following “Limited warranty and Disclaimer” and “Compliance Requirements”.

Read and accept them before using the product.

Limited warranty and Disclaimer

1. The warranty period of the product is 1 year in service or 1.5 years after the product is delivered, whichever is first. *2)

Also, the product may have specified durability, running distance or replacement parts. Please consult your nearest sales branch.

2. For any failure or damage reported within the warranty period which is clearly our responsibility, a replacement product or necessary parts will be provided.

This limited warranty applies only to our product independently, and not to any other damage incurred due to the failure of the product.

3. Prior to using SMC products, please read and understand the warranty terms and disclaimers noted in the specified catalog for the particular products.

*2) Vacuum pads are excluded from this 1 year warranty.

A vacuum pad is a consumable part, so it is warranted for a year after it is delivered.

Also, even within the warranty period, the wear of a product due to the use of the vacuum pad or failure due to the deterioration of rubber material are not covered by the limited warranty.

Compliance Requirements

1. The use of SMC products with production equipment for the manufacture of weapons of mass destruction (WMD) or any other weapon is strictly prohibited.

2. The exports of SMC products or technology from one country to another are governed by the relevant security laws and regulation of the countries involved in the transaction. Prior to the shipment of a SMC product to another country, assure that all local rules governing that export are known and followed.

Caution

SMC products are not intended for use as instruments for legal metrology.

Measurement instruments that SMC manufactures or sells have not been qualified by type approval tests relevant to the metrology (measurement) laws of each country.

Therefore, SMC products cannot be used for business or certification ordained by the metrology (measurement) laws of each country.



Be sure to read this before handling products.

Design/Selection

⚠ Warning

1. Confirm the specifications.

Products represented in this operation manual are designed only for use in compressed air systems. Do not operate at pressures, temperatures, etc., beyond the range of specifications, as this can cause damage or malfunction. We do not guarantee against any damage if the product is used outside of the specification range.

2. Actuator drive

When an actuator, such as a cylinder, is to be driven using a valve, take appropriate measures (such as the installation of a cover or the restricting of access to the product) to prevent potential danger caused by actuator operation.

3. Holding pressure

Since valves are subject to air leakage, they cannot be used for applications such as holding pressure in a pressure vessel.

4. Not suitable for use as an emergency shutoff valve, etc.

The valves listed in this operation manual are not designed for safety applications such as an emergency shutoff valve. If the valves are used in such applications, additional safety measures should be adopted.

5. Release of residual pressure

For maintenance and inspection purposes install a system for releasing residual pressure.

6. Ventilation

Provide ventilation when using a valve in a confined area, such as in a closed control panel. For example, install a ventilation opening, etc., in order to prevent pressure from increasing inside of the confined area and to release the heat generated by the valve.

7. Extended periods of continuous energization

- If a valve will be continuously energized for an extended period of time, the temperature of the valve will increase due to the heat generated by the coil assembly. This will likely adversely affect the performance of the valve and any nearby peripheral equipment.

Therefore, if the valve is to be energized for periods of longer than 30 minutes at a time or if during the hours of operation the energized period per day is longer than the de-energized period, we advise using a valve with specifications listed below.

- Pilot operated: A 0.4 W or lower valve, such as the SY series, or a valve with a power-saving circuit
- Direct operated: A continuous duty type valve such as the VK series or the VT series

If conflicting instructions are given in the "Specific Product Precautions" or on the "How to Order Valves" page, give them priority.

8. Do not disassemble the product or make any modifications, including additional machining.

Doing so may cause human injury and/or an accident.

9. Resumption after a long period of holding time

When resuming operation after a long period of holding time, there are cases in which, regardless of whether the product is in an ON or OFF state, there is a delay in the initial response time due to adhesion. Conducting several cycles of running-in operation will solve this problem. Please consider implementing this before resumption.

⚠ Caution

1. Leakage voltage

Take note that the leakage voltage will increase when a resistor is used in parallel with a switching element or when a C-R circuit (surge voltage suppressor) is used for protecting a switching device because of the leakage voltage passing through the C-R circuit. The suppressor residual leakage voltage should be kept below 3% of rated voltage.

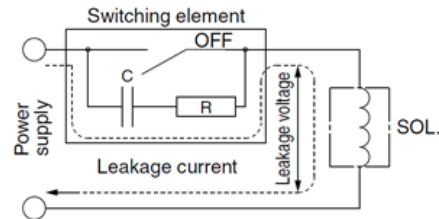

2. Valves with a power-saving circuit (PWM circuit built-in type)

Valves with a power-saving circuit (PWM circuit built-in type) perform the high-speed switching operation with the PWM control circuit inside the valve after the rated power has been applied for approx. 5 ms to reduce the power consumption. The problems shown below may occur in this type of valve due to the switch or drive circuit system by the PWM control. Be sure to check the operation with the customer's machine sufficiently when selecting the product.

1) The valve does not turn ON.

1. If chattering occurs in the switching signal, the valve will enter a power-saving state before turning ON and may not turn ON correctly. Please be especially caution when the valve is driven by a mechanical relay or the like.
2. If a filter, etc., is connected between the power supply and the PWM circuit built-in type valve, the current necessary to drive the valve lowers due to the effects of the filter, and then the valve may not turn ON correctly

2) The valve does not turn OFF. If the PWM circuit built-in type valve is driven by the photo coupler, the photo coupler cannot turn OFF and the valve is kept in an ON state. Therefore, take great care when using the photo coupler built-in SSR (solid state relay) or drive circuit.

3. Surge voltage suppressor

- 1) The surge voltage suppressor built into the valve is intended to protect the output contacts so that the surge generated inside valve does not adversely affect the output contacts. Therefore, if an overvoltage or overcurrent is received from an external peripheral device, the surge voltage protection element inside the valve is overloaded, causing the element to break. In the worst case, the breakage causes the electric circuit to enter short-circuit status. If energizing continues while in this state, a large current flows. This may cause secondary damage to the output circuit, external peripheral device, or valve, and may also cause a fire. So, take appropriate protective measures, such as the installation of an overcurrent protection circuit in the power supply or a drive circuit to maintain a sufficient level of safety.
- 2) If a surge protection circuit contains nonstandard diodes, such as Zener diodes or varistor, a residual voltage that is in proportion to the protective circuit and the rated voltage will remain. Therefore, take into consideration the surge voltage protection of the controller. In the case of diodes, the residual voltage is approximately 1 V.



3-5-Port Solenoid Valves Precautions 2

Be sure to read this before handling products.

Design/Selection

⚠ Caution

- 4. Operation in low temperature conditions**
It is possible to operate a valve in extreme temperatures, as low as -10°C . Take appropriate measures to avoid the freezing of drainage, moisture, etc., in low temperatures.
- 5. Operation for air blowing**
Please be caution about the pressure drop for using the solenoid valve as air blowing. It may cause malfunction or operation non-conformance due to pressure drop.
- 6. Mounting orientation**
The mounting orientation is universal.
- 7. Initial lubrication of main valve**
The initial lubricant (Grease) has already been applied to the main valve.
Please consult with SMC, as there are some standard valve products that use fluorine grease for food processing equipment (NSF H-1).
- 8. For the pilot EXH. (PE) port**
If the solenoid valve's pilot EXH (PE) port is restricted extremely or blocked, abnormal operation of the solenoid valve may occur.

Mounting

⚠ Warning

- 1. Operation manual**
Install the products and operate them only after reading the operation manual carefully and understanding its contents. Also, keep the manual where it can be referred to as necessary.
- 2. Ensure sufficient space for maintenance activities.**
When installing the products, allow access for maintenance and inspection.
- 3. Tighten threads with the proper tightening torque.**
When installing the products, follow the listed torque specifications.
- 4. If air leakage increases or equipment does not operate properly, stop operation.**
Check mounting conditions when air and power supplies are connected. Initial function and leakage tests should be performed after installation.
- 5. Painting and coating**
Warnings or specifications printed on or affixed to the product should not be erased, removed, or covered up. Please consult with SMC before applying paint to resinous parts, as this may have an adverse effect due to the solvent in the paint.

Piping

⚠ Caution

- 1. Refer to the Fittings and Tubing Precautions for handling One-touch fittings.**
- 2. Preparation before piping**
Before piping is connected, it should be thoroughly blown out with air (flushing) or washed to remove chips, cutting oil, and other debris from inside the pipe
- 3. Winding of sealant tape**
When screwing piping or fittings into ports, ensure that chips from the pipe threads or sealing material do not enter the piping. Also, if sealant tape is used, leave 1 thread ridge exposed at the end of the threads.

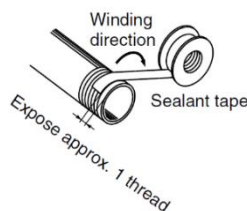

4. Connection of piping and fittings

When screwing piping or fittings into the valve, tighten them as follows.

- 1) For a fitting with sealant R or NPT, first, tighten it by hand, then use a suitable wrench to tighten the hexagonal portion of the body an additional two or three turns. For the tightening torque, refer to the table below.

Connection thread size(R,NPT)	Proper tightening torque(N·m)
1/8	3 to 5

- 2) If the fitting is tightened with excessive torque, a large amount of sealant will seep out. Remove the excess sealant.
- 3) Insufficient tightening may cause seal failure or loosen the threads.
- 4) For reuse
 - (1) Normally, fittings with a sealant can be reused up to 2 to 3 times.
 - (2) To prevent air leakage through the sealant, remove any loose sealant stuck to the fitting by blowing air over the threaded portion.
 - (3) If the sealant no longer provides effective sealing, wind sealing tape over the sealant before reusing. Do not use any form of sealant other than the tape type of sealant.
 - (4) Once the fitting has been tightened, backing it out to its original position often causes the sealant to become defective. Air leakage will occur.
- 5) When using a fitting other than an SMC fitting, follow the instructions given by the fitting manufacturer.
Follow the fitting maker instructions.

5. Uni thread fittings

- 1) First, tighten the threaded portion by hand, then use a suitable wrench to tighten the hexagonal portion of the body further at wrench tightening angle shown below. For the reference value for the tightening torque, refer to the table below.

Connection Female Thread:Rc,NPT

Uni thread size	Wrench tightening angle after tightened by hand (deg)	Tightening torque (N·m)
1/8	30 to 60	3 to 5

Connection Female Thread:G

Uni thread size	Wrench tightening angle after tightened by hand (deg)	Tightening torque (N·m)
1/8	30 to 60	3 to 5

- 2) The gasket can be reused up to 6 to 10 times. It can be replaced easily when it has sustained damage. A broken gasket can be removed by holding it and then turning it in the same direction as loosening the thread. If the gasket is difficult to remove, cut it with nippers, etc. In such a case, use caution not to scratch the seat face because the seat face of the fitting's 45° gasket is the sealing face.

6. Piping to products

When piping to a product, refer to the operation manual to avoid mistakes regarding the supply port, etc



5-Port Solenoid Valves Precautions 3

Be sure to read this before handling products.

Wiring

Warning

1. **The solenoid valve is an electrical product. For safety, install an appropriate fuse and circuit breaker before use.**

Caution

1. **Applied voltage**
When electric power is connected to a solenoid valve, be careful to apply the proper voltage. Improper voltage may cause malfunction or coil damage.
2. **Check the connections.**
Check if the connections are correct after completing all wiring.
3. **External force applied to the lead wire**
If an excessive force is applied to the lead wire, this may cause faulty wiring. Take appropriate measures so that a force of 30 N or more is not applied to the lead wire.

Lubrication

Warning

1. **Lubrication**
 - 1) The valve has been lubricated for life by the factory and does not require any further.
 - 2) If a lubricant is used in the system, use class 1 turbine oil (no additives), ISO VG32. For details about lubricant manufacturers' brands, refer to the SMC website. Additionally, please contact SMC for details about class 2 turbine oil (with additives) ISO VG32. Once lubricant is utilized within the system, since the original lubricant applied within the product during manufacturing will be washed away, please continue to supply lubrication to the system. Without continued lubrication, malfunctions could occur. If turbine oil is used, refer to the Safety Data Sheet (SDS) of the oil.
2. **Lubrication amount**
If the lubrication amount is excessive, the oil may accumulate inside the pilot valve, causing malfunction or response delay. So, do not apply a large amount of oil. When a large amount of oil needs to be applied, use an external pilot type to put the supply air on the pilot valve side in the non-lube state. This prevents the accumulation of oil inside the pilot valve.

Air Supply

Warning

1. **Type of fluids**
Please consult with SMC when using the product in applications other than compressed air.
2. **When there is a large amount of drainage**
Compressed air containing a large amount of drainage can cause the malfunction of pneumatic equipment. An air dryer or water separator should be installed upstream from filters.
3. **Drain flushing**
If condensation in the drain bowl is not emptied on a regular basis, the bowl will overflow. This may cause the malfunction of pneumatic equipment. If the drain bowl is difficult to check and remove, the installation of a drain bowl with an auto drain option is recommended.

For compressed air quality, refer to the SMC Best Pneumatics No. 6 catalog.

4. **Use clean air.**

Do not use compressed air that contains chemicals, synthetic oils that include organic solvents, salt, corrosive gases, etc., as it can cause damage or malfunction.

Caution

1. **When extremely dry air is used as the fluid, degradation of the lubrication properties inside the equipment may occur, resulting in reduced reliability (or reduced service life) of the equipment. Please consult with SMC.**
2. **Install an air filter.**
Install an air filter upstream near the valve. Select an air filter with a filtration size of 5 µm or smaller.
3. **Take measures to ensure air quality, such as by installing an aftercooler, air dryer, or water separator.**
Compressed air that contains a large amount of drainage can cause the malfunction of pneumatic equipment, such as valves. Therefore, take appropriate measures to ensure air quality, such as by providing an aftercooler, air dryer, or water separator.
4. **If an excessive amount of carbon powder is present, install a mist separator on the upstream side of the valve.**
If excessive carbon dust is generated by the compressor, it may adhere to the inside of a valve and cause it to malfunction.

For compressed air quality, refer to the SMC Best Pneumatics No. 6 catalog.



5-Port Solenoid Valves Precautions 4

Be sure to read this before handling products.

Operating Environment

Warning

1. Do not use in an atmosphere containing corrosive gases, chemicals, sea water, water, water steam, or where there is direct contact with any of these.
2. Products with IP67 enclosures (based on IEC60529) are protected against dust and water. However, these products cannot be used in water.
3. Products compliant with IP67 satisfy the product specifications when mounted properly. Be sure to read the precautions for each product.
4. Do not use in an environment where flammable gas or explosive gas exists. Usage may cause a fire or explosion. The products do not have an explosion proof construction.
5. Do not use in a place subject to heavy vibration and/or shock.
6. The valve should not be exposed to prolonged sunlight. Use a protective cover. Note that the valve is not for outdoor use.
7. Remove any sources of excessive heat.
8. If it is used in an environment where there is possible contact with oil, weld spatter, etc., exercise preventive measures.
9. When the solenoid valve is mounted in a control panel or it's energized for a long period of time, make sure the ambient temperature is within the specifications of the valve.

Caution

1. **Temperature of ambient environment**
Use the valve within the range of the ambient temperature specification of each valve. In addition, pay attention when using the valve in environments where the temperature changes drastically.
2. **Humidity of ambient environment**
 - When using the valve in environments with low humidity, take measures to prevent static.
 - If the humidity rises, take measures to prevent the adhesion of water droplets on the valve.

Maintenance

Warning

1. **Perform maintenance and inspection according to the procedures indicated in the operation manual.**
If handled improperly, human injury and/or malfunction or damage of machinery and equipment may occur.
2. **Removal of equipment, and supply/exhaust of compressed air**
Before components are removed, first confirm that measures are in place to prevent workpieces from dropping, run-away equipment, etc. Then, cut off the supply air and electric power, and exhaust all air pressure from the system using the residual pressure release function.
When the equipment is operated after remounting or replacement, first confirm that measures are in place to prevent the lurching of actuators, etc. Then, confirm that the equipment is operating normally.
3. **Low-frequency operation**
Valves should be operated at least once every 30 days to prevent malfunction. (Use caution regarding the air supply.)
4. **Manual override**
When a manual override is operated, connected equipment will be actuated.
Operate only after safety is confirmed.
5. **If the volume of air leakage increases or the valve does not operate normally, do not use the valve. Perform periodic maintenance on the valve to confirm the operating condition and check for any air leakage.**

Caution

1. **Drain flushing**
Remove drainage from the air filters regularly.
2. **Lubrication**
In the case of rubber seals, once lubrication has been started, it must be continued.
Use class 1 turbine oil (with no additives), VG32. If other lubricant oil is used, it may cause a malfunction. Please contact SMC for information on the suggested class 2 turbine oil (with additives), VG32.



DXT1215 Series

Specific Product Precautions

Be sure to read this before handling products.

Environment

Warning

Do not use the valves in atmospheres in which corrosive gases, chemicals, sea water, water, or water vapor are present or where there is direct contact with any of these.

Manual Override

Warning

The manual override is used for switching the main valve regardless of the valve's electric signal. As the connected actuator will start confirm that it is safe to do beforehand.

Non-locking push type

Push the manual override button all the way down.

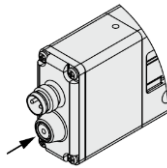

Installation

Caution

Even if the inlet pressure is within the operating pressure range, when the piping diameter is restricted due to size reduction of the supply port (P), the flow will be insufficient. In such cases, the valve will not switch completely and the cylinder may malfunction.

Surge Voltage Suppressor

With power-saving circuit(PWM circuit built-in type, non-polar type)

The power consumption has been reduced to approx. 1/4 of the startup power by eliminating the need for electrical current for holding. (Effective after being energized for more than 5 ms when the 24 VDC rated voltage is applied)

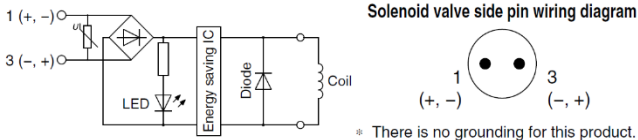

Operating principle

The circuit shown above reduces power consumption by eliminating the need for electrical current for holding in order to save energy. Refer to the electrical power waveform shown in the graph on the right.

<Power-saving electric waveform>

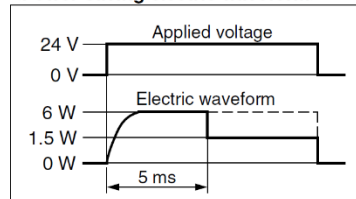

Residual voltage of the surge voltage suppressor

If a diode surge voltage suppressor is used, there will be a residual voltage of approx. 1V. Pay attention to the surge voltage protection on the controller side.

M8 Connector Type

Connector cable

The connector cable for M8 connectors can be ordered as follows.

How to Order

1. To order a solenoid valve and the connector cable at the same time (The connector cable will be included in the shipment of the solenoid valve.)

DXT1215T-5W□U-01□(-X1)

• Cable length [mm]

Ex. 1) Cable length: 300 mm

DXT1215T-5W1U-01□(-X1)

• Symbol for electrical entry

Symbol	Cable length [mm]
1	300
2	500
3	1000
4	2000
5	3000
6	4000
7	5000

2. To order only the connector cable

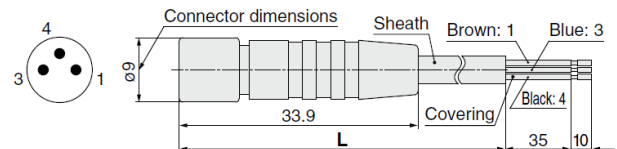

Cable length (L)	Part no.
300 mm	V100-49-1-1
500 mm	V100-49-1-2
1000 mm	V100-49-1-3
2000 mm	V100-49-1-4
3000 mm	V100-49-1-5
4000 mm	V100-49-1-6
5000 mm	V100-49-1-7

Sheath O.D.	ø3.4 mm
Cover diameter	ø1.16 mm
Conductor area	0.16 mm ²

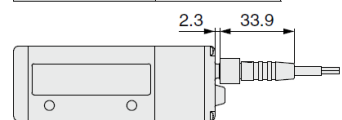

Recommended M8 Connector Angle Type



Cable length	PHOENIX CONTACT	
	Product no.	Order No.
1.5 m	SAC-3P-1,5-PUR/M 8FR	1669738
3 m	SAC-3P-3,0-PUR/M 8FR	1669741
5 m	SAC-3P-5,0-PUR/M 8FR	1669631
10 m	SAC-3P-10,0-PUR/M 8FR	1694169

Caution Phoenix Contact products should be ordered directly from the manufacturer or from its distributors.

Caution

- The M8 connector type is IP67 compliant (according to IEC 60529) and protected against dust and water. However, it cannot be used under water. Select an SMC connector cable (V100-49-1-□) or an FA sensor type connector with M8 threaded 3-pin specifications conforming to Nippon Electric Control Equipment Association Standard NECA4202 (IEC 60947-5-2).
- Do not use a tool to mount the connector as this may damage it. Only tighten the connector by hand. (0.4 to 0.6 N·m)
- The application of excessive force on the cable connector will result in it no longer being able to satisfy the IP67 requirements. Please use caution and refrain from applying any force of 30 N or greater on the connector.

Failure to satisfy the IP67 requirements may result if using connectors other than those shown above or if the connector is insufficiently tightened.

Valve Construction

2-position single

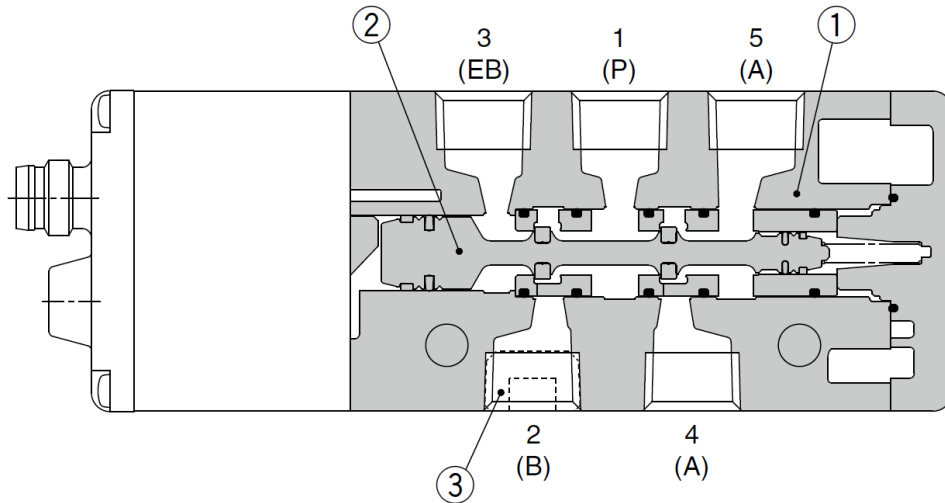

2-position single
Standard 5-port
specification

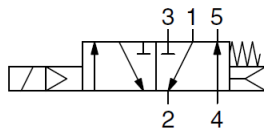

Made to Order
3-port specification
(-X1)

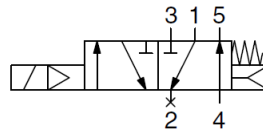

* The 3-port specification is a specification with the 2(B) port plugged and closed.
The 3(EB) port should be kept open for pilot exhaust.

Component Parts

No.	Description	Material
1	Body	Aluminum die-casted
2	Spool assembly	Aluminum/FKM
3	Plug (For the -X1)	Steel

TROUBLE SHOOTING

Trouble	For valve non-conformance, take following countermeasures referring to trouble.	Possible cause	Countermeasures
Malfunction No air changeover.	The valve operates when the manual override button is pushed? <div style="text-align: right; margin-top: 10px;"> No → </div>	1) Operation failure or sticking of the main valve. ● Foreign matter from the piping and air source got caught in the main valve, causing a malfunction. ● Malfunction occurred due to sticking such as swelling of the rubber part of the main valve.	- Replace the valve. - Clean the air supply. - If incorrect oil has been used for lubrication, remove the oil by air blow. - If there is a large amount of condensate or condensate cannot be removed completely, mount an auto drain or install a dryer and replace the valve.
	Yes	2) Pressure drop Air source pressure is reduced and minimum operating pressure of the valve was not reached, causing an operation failure.	- Adjust the pressure within the specification range for the valve.
		3) Excessive oil supply Due to excessive lubrication, oil accumulated inside the valve, causing malfunction.	- Reduce the amount of lubrication to the amount at which the oil does not splash from the exhaust port [5/3 (EA/EB)].
	Energized? Is valve switched? <div style="text-align: right; margin-top: 10px;"> No → </div>	1) Non-conformance of electric system - Incorrect wiring - Fuse blown out, lead wire broken - Incorrect contact at the contact and connection - Sequencer non-conformance - Supply voltage insufficient	- Check all parts and replace the part, if necessary. - Check the supply voltage.
	Yes	2) Drop of supply voltage Operation failure of the valve due to voltage drop.	- Check the supply voltage. Take corrective action if voltage drop is confirmed.
		3) Non-conformance of the installed pilot valve - Broken wire in the coil or burnout (High supply voltage, incorrect coil specification, entry of water)	- Replace the valve. - Protect the valve especially the coil to prevent being exposed to water.
		1) Leakage current Operation failure of the valve occurred due to residual voltage. (Valve is not turned OFF)	- Check the residual voltage. - Keep the residual voltage at 3% of the rated voltage or less.
		2) Non-conformance of the installed pilot valve - Foreign matter is caught in the moving part of the valve (or pilot valve). - Swelling of rubber parts inside the valve (or pilot valve)	- Clean the air supply. - Eliminate foreign matter with air blow. - Replace the valve when actions above do not improve the condition.

Trouble	For valve non-conformance, take following countermeasures referring to trouble.	Possible causes	Countermeasures
Response failure Valve and actuator become slow.	The valve is slow. Actuators including cylinder become slow.	<p>1) Leakage current When the valve is turned off, it became slow due to the residual voltage.</p> <p>2) Clogging of the filter and silencer Filter or silencer is clogged, or exhaust port [5/3 (EA/EB)] is blocked.</p> <p>3) Operation failure or sticking of the main valve. Foreign matter from the piping and air source got caught in the main valve of the valve, causing a delay. Malfunction occurred due to sticking such as swelling of the rubber part of the main valve.</p>	<p>-Check the residual voltage. -Keep the residual voltage at 3% of the rated voltage or less.</p> <p>- Replace the filter. - Replace the silencer. - Do not block the valve exhaust port.</p> <p>- Replace the valve. - Check for abnormalities in devices other than valves. - Clean the air supply. - If incorrect oil has been used for lubrication, remove the oil by air blow. - If there is a large amount of condensate or condensate cannot be removed completely, mount an auto drain or install a dryer and replace the valve.</p>
Air leakage	Air leakage from output [2(B),4(A)] port and exhaust [5 (EA),3(EB)] port.	<p>1) Internal air leakage increased because foreign matter get caught in the main valve.</p> <p>2) Sealing failure of the actuator (cylinder)</p>	<p>- Replace the valve. - Clean the air supply.</p> <p>- Refer to the operation manual of the actuator for details.</p>

If the countermeasures above are not effective, there may be a trouble with the valve. Stop using the valve immediately.

If any of the examples below are applicable, there may be an internal trouble with the valve. Stop using the valve immediately.

- ① It was used with a voltage other than the rated voltage.
- ② The supplied oil was not the specified type.
- ③ Lubrication was stopped during operation. OR lubrication was interrupted temporarily.
- ④ Severe impact was applied.
- ⑤ Foreign matter such as condensate or dust has entered into the product.
- ⑥ Other than the cases mentioned above, any usage which falls under the precautions in this operation manual.

※ If the product has failed, then please return the valve without any modifications.

Revision history

SMC Corporation

4-14-1, Sotokanda, Chiyoda-ku, Tokyo 101-0021 JAPAN

Tel: + 81 3 5207 8249 Fax: +81 3 5298 5362

URL <http://www.smcworld.com>

Note: Specifications are subject to change without prior notice and any obligation on the part of the manufacturer.
© 2019 SMC Corporation All Rights Reserved

No.DOC1003125