



# Operation Manual

PRODUCT NAME

SI Unit  
(PROFIsafe compatible)

MODEL / Series / Product Number

*EX260-FPS1*

**SMC Corporation**

## Original Instructions

### IMPORTANT

This product is intended to be used in applications requiring the safe removal of the electrical energising supply to manifold mounted pneumatic valves. It is the user's responsibility to determine if this product is suitable for the intended application and to specify the arrangement of the pneumatic valves appropriately to achieve the required safety function

This manual is only valid for the EX260-FPS1 with the following hardware and firmware versions.

- Firmware version (FW): 1.0.x (x is a number 0 or more)
- Hardware version (HW): 03 or higher

# Contents

IMPORTANT	1
Safety Instructions	3
1. For your safety	10
1.1. General safety notes	10
1.2. Electrical safety	11
1.3. Safety of the machine or system	11
1.4. Directive and standards	12
1.5. Documentation	12
1.6. Abbreviations used	12
2. Product Summary	13
2.1. Features	13
2.2. Parts and description	14
2.3. Safe power supply (output)	15
2.4. Block diagram	15
3. Installation	16
3.1. Mounting	16
3.2. Wiring	17
4. Commissioning	21
4.1. Configuration	21
4.2. Diagnostics parameter	21
4.3. Safe valve power module	22
4.4. PROFIsafe parameter	22
4.5. Valves (32coils) module	23
4.6. 1 Byte feedback information about the valve output status	23
5. Specifications	24
6. Indication and setting	26
6.1. LED indicators	26
6.2. Production label	29
6.3. PROFIsafe address switch	29
7. Accessories	30
7.1. Seal cap	30
8. Dimensions	31
9. Troubleshooting	32
9.1. Troubleshooting	32
9.2. Acknowledgment and restart	35
Appendix A: Glossary for PROFIsafe	36
Appendix B: Parameters for PROFIsafe	38
Appendix C: Checklists	39
Appendix D: Safety Characteristics	44
Appendix E: EX260-FPS Timing Values	45
Appendix F: Failure modes	46



# Safety Instructions

These safety instructions are intended to prevent hazardous situations and/or equipment damage. These instructions indicate the level of potential hazard with the labels of "Caution", "Warning" or "Danger". They are all important notes for safety and must be followed in addition to International Standards (ISO/IEC)\*1), and other safety regulations.

\*1) ISO 4414: Pneumatic fluid power -- General rules relating to systems.

ISO 4413: Hydraulic fluid power -- General rules relating to systems.

IEC 60204-1: Safety of machinery -- Electrical equipment of machines. (Part 1: General requirements)

ISO 10218: Manipulating industrial robots -Safety.

etc.



## Caution

**Caution** indicates a hazard with a low level of risk which, if not avoided, could result in minor or moderate injury.



## Warning

**Warning** indicates a hazard with a medium level of risk which, if not avoided, could result in death or serious injury.



## Danger

**Danger** indicates a hazard with a high level of risk which, if not avoided, will result in death or serious injury.

## Warning

### 1. The compatibility of the product is the responsibility of the person who designs the equipment or decides its specifications.

Since the product specified here is used under various operating conditions, its compatibility with specific equipment must be decided by the person who designs the equipment or decides its specifications based on necessary analysis and test results.

The expected performance and safety assurance of the equipment will be the responsibility of the person who has determined its compatibility with the product.

This person should also continuously review all specifications of the product referring to its latest catalog information, with a view to giving due consideration to any possibility of equipment failure when configuring the equipment.

### 2. Only personnel with appropriate training should operate machinery and equipment.

The product specified here may become unsafe if handled incorrectly.

The assembly, operation and maintenance of machines or equipment including our products must be performed by an operator who is appropriately trained and experienced.

### 3. Do not service or attempt to remove product and machinery/equipment until safety is confirmed.

1. The inspection and maintenance of machinery/equipment should only be performed after measures to prevent falling or runaway of the driven objects have been confirmed.

2. When the product is to be removed, confirm that the safety measures as mentioned above are implemented and the power from any appropriate source is cut, and read and understand the specific product precautions of all relevant products carefully.

3. Before machinery/equipment is restarted, take measures to prevent unexpected operation and malfunction.

### 4. Contact SMC beforehand and take special consideration of safety measures if the product is to be used in any of the following conditions.

1. Conditions and environments outside of the given specifications, or use outdoors or in a place exposed to direct sunlight.

2. Installation on equipment in conjunction with atomic energy, railways, air navigation, space, shipping, vehicles, military, medical treatment, combustion and recreation, or equipment in contact with food and beverages, emergency stop circuits, clutch and brake circuits in press applications, safety equipment or other applications unsuitable for the standard specifications described in the product catalog.

3. An application which could have negative effects on people, property, or animals requiring special safety analysis.

4. Use in an interlock circuit, which requires the provision of double interlock for possible failure by using a mechanical protective function, and periodical checks to confirm proper operation.



# Safety Instructions

## Caution

### **1. The product is provided for use in manufacturing industries.**

The product herein described is basically provided for peaceful use in manufacturing industries. If considering using the product in other industries, consult SMC beforehand and exchange specifications or a contract if necessary. If anything is unclear, contact your nearest sales branch.

## **Limited warranty and Disclaimer/Compliance Requirements**

The product used is subject to the following "Limited warranty and Disclaimer" and "Compliance Requirements".

Read and accept them before using the product.

### **Limited warranty and Disclaimer**

#### **1. The warranty period of the product is 1 year in service or 1.5 years after the product is delivered, whichever is first.\*2)**

Also, the product may have specified durability, running distance or replacement parts. Please consult your nearest sales branch.

#### **2. For any failure or damage reported within the warranty period which is clearly our responsibility, a replacement product or necessary parts will be provided.**

This limited warranty applies only to our product independently, and not to any other damage incurred due to the failure of the product.

#### **3. Prior to using SMC products, please read and understand the warranty terms and disclaimers noted in the specified catalog for the particular products.**

**\*2) Vacuum pads are excluded from this 1 year warranty.**

A vacuum pad is a consumable part, so it is warranted for a year after it is delivered.

Also, even within the warranty period, the wear of a product due to the use of the vacuum pad or failure due to the deterioration of rubber material are not covered by the limited warranty.

### **Compliance Requirements**

#### **1. The use of SMC products with production equipment for the manufacture of weapons of mass destruction (WMD) or any other weapon is strictly prohibited.**

#### **2. The exports of SMC products or technology from one country to another are governed by the relevant security laws and regulation of the countries involved in the transaction. Prior to the shipment of a SMC product to another country, assure that all local rules governing that export are known and followed.**

## Caution

### **SMC products are not intended for use as instruments for legal metrology.**

Products that SMC manufactures or sells are not measurement instruments that are qualified by pattern approval tests relating to the measurement laws of each country.

Therefore, SMC products cannot be used for business or certification ordained by the measurement laws of each country.

## Operator

- ◆ This operation manual has been written for those who have knowledge of machinery and apparatus that use pneumatic equipment and have full knowledge of assembly, operation and maintenance of such equipment.
- ◆ Please read this operation manual carefully and understand it before assembling, operating or providing maintenance to the product.

### ■ Precautions

#### **Danger**

- After maintenance is complete, perform appropriate functional inspections.  
Stop operation if the equipment does not function properly.  
Safety cannot be assured in the case of unexpected malfunction.

#### **Warning**

- Do not operate the product outside of the specifications.  
Do not use for flammable or harmful fluids.  
Fire, malfunction, or damage to the product can result.  
Verify the specifications before use.
- Do not operate in an atmosphere containing flammable or explosive gases.  
Fire or an explosion can result.  
This product is not designed to be explosion proof.
- If using the product in an interlocking circuit:
  - Provide a double interlocking system, for example a mechanical system.
  - Check the product regularly for proper operation.Otherwise malfunction can result, causing an accident.
- The following instructions must be followed during maintenance:
  - Turn off the power supply.
  - Stop the air supply, exhaust the residual pressure and verify that the air is released before performing maintenance.Otherwise an injury can result.

## **Caution**

- Provide grounding to assure the noise resistance of the Serial System.  
Individual grounding should be provided close to the product with a short cable.

### ■ NOTE

- Follow the instructions given below when designing, selecting and handling the product.
  - The instructions on design and selection (installation, wiring, environment, adjustment, operation, maintenance, etc.) described below must also be followed.
    - \* Product specifications
      - Use the specified voltage.  
Otherwise failure or malfunction can result.
      - Reserve a space for maintenance.  
Allow sufficient space for maintenance when designing the system.
      - Do not remove any nameplates or labels.  
This can lead to incorrect maintenance, or misreading of the operation manual, which could cause damage or malfunction to the product.  
It may also result in non-conformity to safety standards.
    - Product handling
      - \* Installation
        - Do not drop, hit or apply excessive shock to the fieldbus system.  
Otherwise damage to the product can result, causing malfunction.
        - Tighten to the specified tightening torque.  
If the tightening torque is exceeded the mounting screws may be broken.  
IP67 protection cannot be guaranteed if the screws are not tightened to the specified torque.
        - Never mount a product in a location that will be used as a foothold.  
The product may be damaged if excessive force is applied by stepping or climbing onto it.

#### \*Wiring

- Avoid repeatedly bending or stretching the cables, or placing heavy load on them.  
Repetitive bending stress or tensile stress can cause breakage of the cable.
- Wire correctly.  
Incorrect wiring can break the SI Unit.
- Do not perform wiring while the power is on.  
Otherwise damage to the fieldbus system and/or I/O device can result, causing malfunction.
- Do not route wires and cables together with power or high voltage cables.  
Otherwise the fieldbus system and/or I/O device can malfunction due to interference of noise and surge voltage from power and high voltage cables to the signal line.  
Route the wires (piping) of the fieldbus system and/or I/O device separately from power or high voltage cables.
- Confirm proper insulation of wiring.  
Poor insulation (interference from another circuit, poor insulation between terminals, etc.) can lead to excess voltage or current being applied to the SI Unit, causing damage.
- Take appropriate measures against noise, such as using a noise filter, when the fieldbus system is incorporated into equipment.  
Otherwise noise can cause malfunction.

#### \*Environment

- Select the proper type of protection according to the environment of operation.  
IP67 protection is achieved when the following conditions are met.
  - (1) Connectors that are not used must be closed with covering caps.
  - (2) All covering caps must be screwed down correctly after wiring and setting has been completed.
  - (3) Apply the recommended tightening torque and all manifold parts must be installed correctly.If using in an environment that is exposed to water splashes, please take measures such as using a cover.  
If the product is to be used in an environment containing oils or chemicals such as coolant or cleaning solvent, even for a short time, it may be adversely affected (damage, malfunction etc.).
- Do not use in a place where the product could be splashed by oil or chemicals.  
If the product is to be used in an environment containing oils or chemicals such as coolant or cleaning solvent, even for a short time, it may be adversely affected (damage, malfunction etc.).
- Do not use the product in an environment where corrosive gases or fluids could be splashed.  
Otherwise damage to the product and malfunction can result.
- Do not use in an area where surges are generated.  
If there is equipment which generates a large amount of surge (solenoid type lifter, high frequency induction furnace, motor, etc.) close to the fieldbus system, this may cause deterioration or breakage of the internal circuit of the fieldbus system. Avoid sources of surge generation and crossed lines.
- When a surge-generating load such as a relay or solenoid is driven directly, use an fieldbus system with a built-in surge absorbing element.  
Direct drive of a load generating surge voltage can damage the fieldbus system.
- The product is CE marked, but not immune to lightning strikes. Take measures against lightning strikes in the system.
- Prevent foreign matter such as remnant of wires from entering the fieldbus system to avoid failure and malfunction.
- Mount the product in a place that is not exposed to excessive vibration or impact.  
Otherwise failure or malfunction can result.
- Do not use the product in an environment that is exposed to temperature cycle.  
Heat cycles other than ordinary changes in temperature can adversely affect the inside of the product.
- Do not expose the product to direct sunlight.  
If using in a location directly exposed to sunlight, shade the product from the sunlight.  
Otherwise failure or malfunction can result.
- Keep within the specified ambient temperature range.  
Otherwise malfunction can result.
- Do not operate close to a heat source, or in a location exposed to radiant heat.  
Otherwise malfunction can result.



**\*Adjustment and Operation**

- Set the switches by using a sharp-pointed screwdriver etc.

Caution: Ensure the tool does not damage the switches during this process.

- Perform settings suitable for the operating conditions.

Caution: Incorrect settings can cause operation failure and unexpected actuator behaviour

- Please refer to the PLC manufacturer's manual etc. for details of programming and addresses.

For the PLC protocol and programming refer to the relevant manufacturer's documentation.

**\*Maintenance**

- Turn off the power supply, stop the supplied air, exhaust the residual pressure and verify the release of air before performing maintenance.

There is a risk of unexpected malfunction.

- Perform regular maintenance and inspections.

There is a risk of unexpected malfunction.

- After maintenance is complete, perform appropriate functional inspections.

Stop operation if the equipment does not function properly.

Otherwise safety is not assured due to an unexpected malfunction or incorrect operation.

- Do not use solvents such as benzene, thinner etc. to clean the SI unit.

They could damage the surface of the body and erase the markings on the body.

Use a soft cloth to remove stains.

For heavy stains, use a cloth soaked with diluted neutral detergent and fully squeezed, then wipe up the stains again with a dry cloth.

# Fieldbus System/ Industrial IoT Cybersecurity

In recent years, factories have introduced industrial IoT, building up complex networks of production machines. These systems may be subject to a new threat, cyberattack. To protect the industrial IoT from cyberattacks, it is important to take multiple measures (multi-layer protection) for IoT devices, networks and clouds.

For this purpose, SMC recommends that the following measures are always taken into consideration. For further details of the following measures, please see security information published by your local country security agencies.

## 1. Do not connect the devices via a public network.

- If you unavoidably need to access the device or cloud via a public network, ensure to use a secure, private network such as VPN.
- Do not connect an office IT network and factory IoT network.

## 2. Build a firewall to prevent a threat from entering the device and system.

- Set up a router or firewall at network boundaries to allow minimum required communications.
- Disconnect from the network or turn off the device, if no continuous connection is required.

## 3. Physically block an access to unused communication ports or disable them.

- Inspect regularly each port if any unnecessary device is connected to the network system.
- Operate necessary services (SSH, FTP, SFTP, etc.) only.
- Set a transmission range of the device using a wireless LAN or other radio system to the minimum required and use only devices approved according to the radio act in the country concerned.
- Install a device generating radio waves in such place as there is no interference from indoor or outdoor.

## 4. Set up a secure communication method such as data encryption.

- Encrypt data in every environment, including IoT networks, secure gate-way connections, for secure communications.

## 5. Grant access permissions by user accounts and limit the number of users.

- Regularly review accounts and delete all unused accounts or permissions.
- Establish an account lockout system to block an access to the account for a certain period if log-in fails more than the given threshold.

## 6. Protect passwords.

- Change the default password when you first use the device or system.
- Choose a long password (minimum 8 characters) using a mix of different letters and characters to make the password more secure and harder to hack.

## 7. Use the latest security software.

- Install antivirus software on all computers to detect and remove viruses.
- Keep the antivirus software up to date.

## 8. Use the latest version of the device and system software.

- Apply patches to keep the OS and applications up to date.

## 9. Monitor and detect abnormalities in the network.

- Keep monitoring the network for any abnormalities to take a prompt measure and issue an alert if any abnormality is detected. Install an intrusion detection system (IDS) and intrusion prevention system (IPS).

## 10. Delete data from devices when disposed of.

- Before disposing of any IoT devices, delete stored data or physically destruct media to prevent any misuse of the data.

# 1. For your safety

## Purpose of this manual

This user manual provides information about how the SI Unit works, its operating and connection elements, and its parameter settings.

## Validity of the user manual

This user manual is valid for the EX260-FPS1 in the version indicated on the inner cover page, as well as for the same or later versions if replaced with the devices of the same type.

## 1.1. General safety notes

### **WARNING: Risk of injury**

Depending on the application, inappropriate use of the SI Unit may result in serious injury.

- Observe all the safety notes and warning instructions provided in this section and elsewhere in this user manual.

### 1.1.1. Qualified personnel

Within the context of this user manual, qualified personnel are persons who, because of their education, experience and instruction, and their knowledge of relevant standards, regulations, accident prevention, and service conditions, have been authorized to carry out any required operations, and who are able to recognize and avoid any possible dangers.

Furthermore, knowledge of the following topics and SI Units is required:

- Non-safety-related target system (e.g. PROFINET)
- PROFIsafe
- Components used
- EX260-FPS1 SI Unit range
- Operation of the software tools
- Safety regulations in the field of application

In the context of the use of the PROFIsafe system, the following operations must only be carried out by qualified personnel:

- Planning
- Configuration, parameterization, programming
- Installation, commissioning, servicing
- Maintenance, decommissioning

### 1.1.2. Documentation

Observe all information in this user manual and the accompanying documents: refer to [Section 1.5 "Documentation"](#).

### 1.1.3. Safety of personnel and equipment

The safety of personnel and equipment can only be assured if the SI Unit is used correctly: refer to [Section 1.4.1 "Intended use"](#).

### 1.1.4. Error detection

Depending on the wiring and the parameterization, the SI Unit detects errors within the safety equipment.

### 1.1.5. Do not carry out any repairs or modifications

It is prohibited for the user to carry out repair work or make modifications to the SI Unit. The housing must not be opened. The SI Unit is protected against tampering by means of security labels. The security label is damaged in the event of unauthorized repairs or opening of the housing. In this case, the correct operation of the safety product can no longer be ensured.

In the event of an unrecoverable error, send the product to SMC or contact SMC immediately.

### 1.1.6. Mismatching and polarity reversal of connections

Take care to avoid the mismatching, polarity reversal or tampering of connections.

## 1.2. Electrical safety

### **⚠ WARNING: Loss of safety function/hazardous shock currents**

Incorrect installation can result in the loss of the safety function as well as hazardous shock currents.

- Observe the notes on electrical safety.
- Plan the products used and their installation in the system according to the specific requirements.
- Recheck plants and systems retrofitted with PROFIsafe.

#### **1.2.1. Direct/indirect contact**

Protection against direct and indirect contact according to EN61010-2-201 must be ensured for all components connected to the system. In the event of an error, hazardous voltages must not occur (single-fault tolerance).

Measures required:

- Using power supply units with safe isolation (SELV or PELV).
- Decoupling circuits, for any connConfiguration is defective, or initial commissioning has action to circuits which are not SELV or PELV circuits using photocouplers, relays, and other components which meet the requirements of safe isolation.

#### **1.2.2. Power supply units for 24 V supply**

Only use power supply units that are SELV or PELV according to EN 61010-2-201

Under and over voltage detection is included in this product. Outside of the nominal range 19 to 33 VDC will result in error conditions.

The power supply unit must have a minimum current capability of 5 A.

#### **1.2.3. Insulation rating**

When selecting the equipment, please take into consideration the transient and surge voltages, which may occur during operation.

The SI Unit is designed for use with connecting cables that are less than 30 m long and do not go outside of a building. If these requirements are not met, then external measures must be taken to protect the unit. (reference immunity requirements of EN 61131-2)

## 1.3. Safety of the machine or system

The machine/system manufacturer and the operator are responsible for the safety of the machine or system and the application in which the machine or system is used.

#### **1.3.1. Draw up and implement a safety concept**

In order to use the SI Unit, a safety concept is required for your machine or system. This includes a hazard and risk analysis as well as a test report (checklist) for validating the safety function: refer to [Section 1.4 "Directive and standards"](#) and refer to ["Appendix C: Checklists"](#).

The target safety integrity level (SIL according to IEC 61508, SILCL according to EN 62061 or performance level and category according to EN ISO 13849-1) is ascertained on the basis of the risk analysis. The safety integrity level ascertained determines how to connect and parameterize the SI Unit within the safety function.

#### **1.3.2. Validate hardware and parameterization**

Carry out a validation every time you make a safety-related modification to your overall system.

Use your test report to ensure that:

- The safe products are connected to the correct actuators.
- The variables have been linked to the safe actuators correctly.

## 1.4. Directive and standards

The standards to which the SI Unit conforms are listed in the certificate issued by the approval body and in the EC declaration of conformity.

### 1.4.1. Intended use

The EX260-FPS1 is designed exclusively for use in a PROFIsafe system and fulfils the PROFINET guidelines as defined by PI (PNO). It can only perform its tasks in the system if it is used according to the specifications in this document.

Only use the SI Unit according to the defined technical data and ambient conditions: refer to [Section 5 "Specifications"](#).

## 1.5. Documentation

### 1.5.1. Correctness and availability of documentation

Always use the latest documentation for this product. Changes or additions to documentation can be found on the Internet (refer to: [www.smcworld.com](http://www.smcworld.com)).

### 1.5.2. PROFIsafe user manuals:

- For the safe controller used
- For the failsafe PROFIsafe I/O modules used
- For PROFIsafe system function blocks

Observe the information on PROFINET, and PROFIsafe which is available on the Internet (refer to: [www.profisafe.net](http://www.profisafe.net)).

## 1.6. Abbreviations used

Table 1-1 Abbreviations for safety requirements

Abbreviation	Meaning	Standard	Example
SIL	Safety integrity level	IEC 61508	SIL 2, SIL3
SILCL	SIL claim limit	EN 62061	SIL CL 3
Cat.	Category	EN ISO 13849-1	Cat. 2, Cat. 4
PL	Performance level	EN ISO 13849-1	PL d, PL e

Table 1-2 General Abbreviations

Abbreviation	Meaning
PELV	Protective extra-low voltage according to EN 61140
SELV	Separated extra-low voltage according to EN 61140

Explanations of terms and abbreviations used in the context of PROFIsafe: refer to ["Appendix A: Glossary for PROFIsafe"](#).

## 2. Product Summary

### 2.1. Features

#### SI Unit

The SI (Serial Interface) Unit represents a PROFIsafe on PROFINET IO-device for SMC pneumatic valves. It can be used to implement a safety function for the directly connected valves and has the following properties:

- Designed for use in safety systems up to SIL 3 according to EN 61508.
- Designed for use in safety systems up to SIL CL3 according to EN 62061.
- Designed for use in safety systems up to Category 3, Performance level (PL) e according to EN ISO 13849.
- One safe power supply switch for solenoid valves.
- IP67 protection.
- Two M12 connectors (4-pin socket, D-coded) for PROFINET IO connection and one M12 connector (4-pin plug, A-coded) for power supply.
- Up to 32 solenoid valves outputs.
- Integrated diagnostic and protection function.
- Galvanically isolated power supplies.
- Factory Reset function supported. After a factory reset, the unit needs to be powered off and on again.

#### Corresponding solenoid valve manifolds

- SY series SY3000, SY5000, SY7000
- JSY series JSY1000, JSY3000, JSY5000

## 2.2. Parts and description

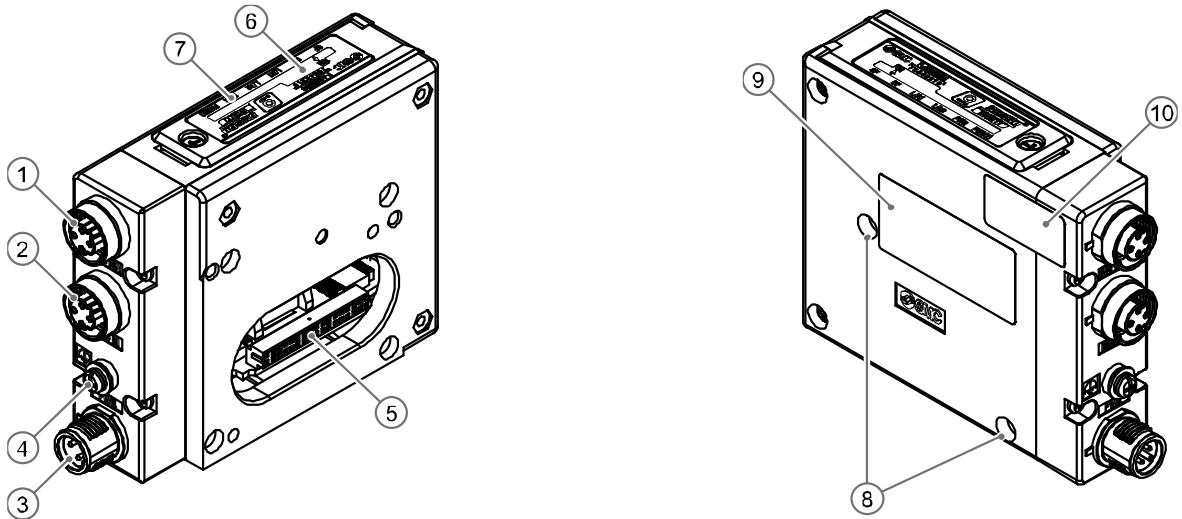

No.	Components	Function
1	PROFINET connection (BUS OUT)	PROFINET connection for Port 2 M12 4-pin socket, D-coded
2	PROFINET connection (BUS IN)	PROFINET connection for Port 1 M12 4-pin socket, D-coded
3	Power supply connection	Power supply for valves and power supply for logic of the SI unit M12 4-pin plug, A-coded
4	FE terminal	Functional Earth terminal M3 screw
5	Output connector	Output connection for valve manifold
6	F-Address switch under the switch cover	An eight-bit DIP-Switch is provided for the safety address setting
7	LED indicators	LED display to indicate the status of SI Unit
8	Mounting hole	Mounting hole for connection to the valve manifold
9	Production label	Production label indicates the SI Unit information, MAC address and so on
10	Security label	To prevent hardware modification

### Accessories

Components	Function
Hexagon socket head cap screw	2 pcs. M3 x 30 screw for connection to the valve manifold
Seal cap	1 pc. seal cap for unused fieldbus interface connector

Fig. 2-1 Description of parts on the SI Unit and accessories

## 2.3. Safe power supply (output)

The SI Unit has 1 safe digital output which can be used for valve power supply.

### Safe state

The safety function of this product is to remove the electrical energising supply to the attached pneumatic valves. This will be done on demand by the appropriate PROFIsafe command or on the detection of a fault by the internal diagnostics.

## 2.4. Block diagram

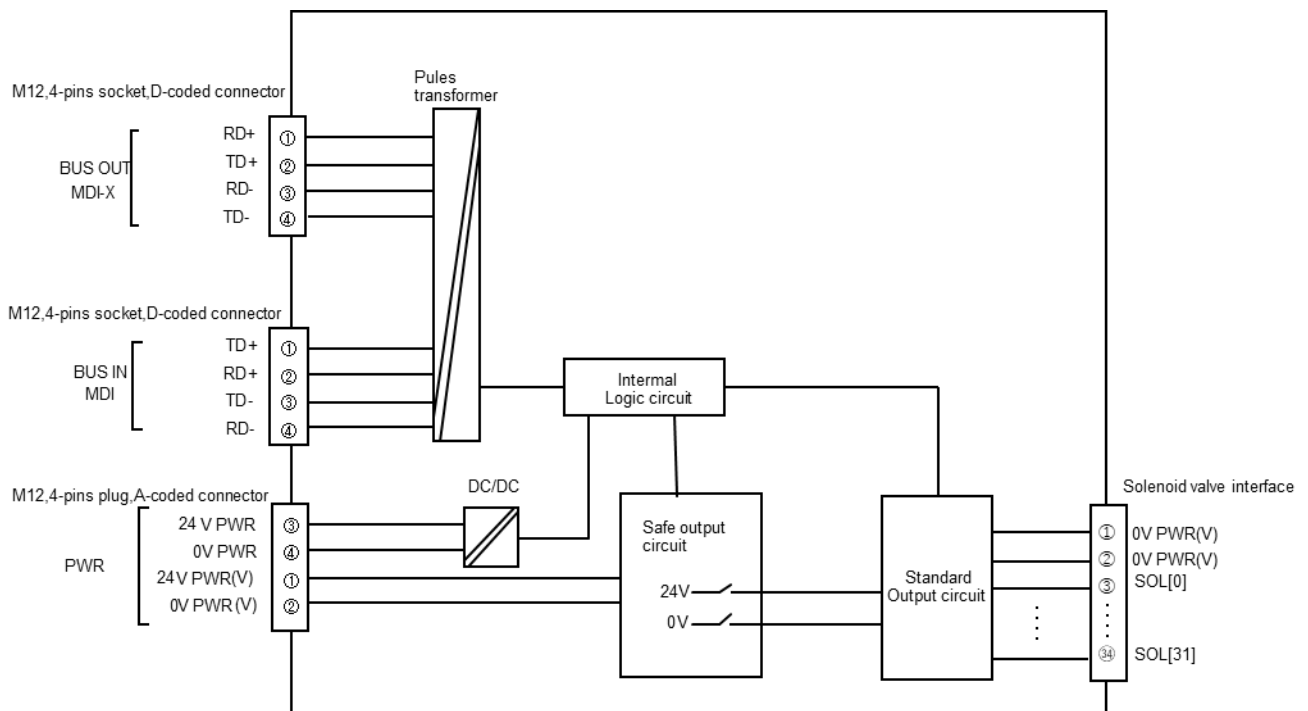

Fig. 2-2 Block diagram of the EX260-FPS1



## 3. Installation

### 3.1. Mounting

#### ⚠ Caution

For a protection rating of IP67 to be ensured, apply the recommended tightening torque.

#### 3.1.1. Valve manifold connection

Connect the valve manifold with the 2 screws on the SI Unit. (Hexagonal socket wrench size 2.5)

Note:

Tighten the screws while holding the SI unit and the valve manifold so that there is no gap between them.

Tighten the screws with the tightening torque specified.

(Tightening torque: 0.6 Nm)

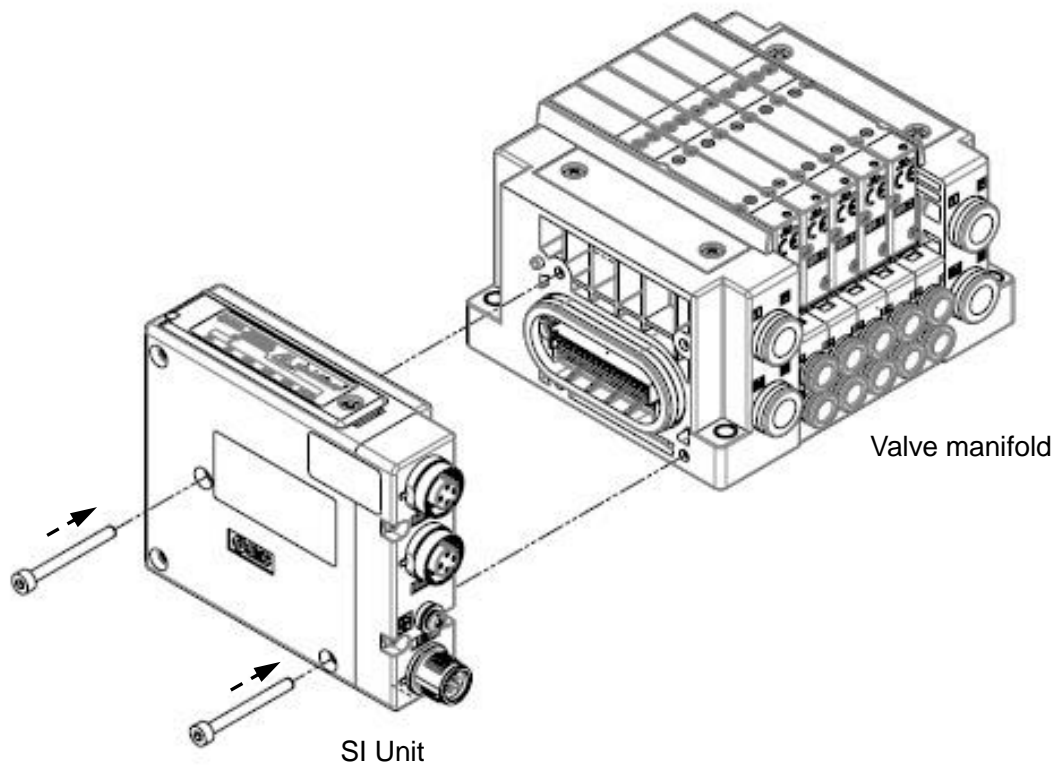

Fig. 3-1 Valve manifold connection

### 3.1.2. Valve manifold mounting

The SI Unit does not have any holes for mounting purposes.  
Refer to the relevant valve manifold catalogue for mounting details.

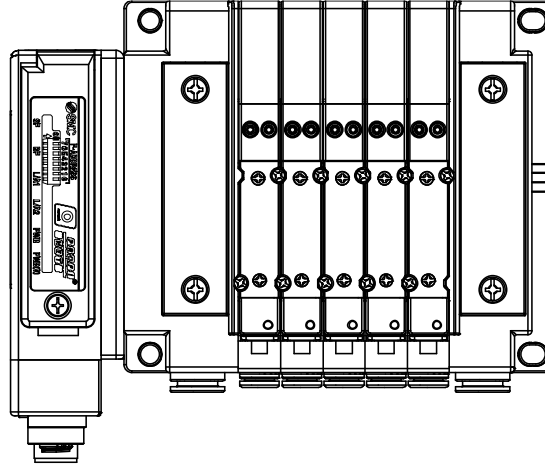

Fig. 3-2 Top view of the valve manifold (SY3000 series)

## 3.2. Wiring

### ⚠ Caution

To prevent damage, all supply voltages to the SI Unit must be turned off (i.e. de-energized) before the modules are installed or removed.

Connect the functional earth cable, the PROFINET cables and the power cable.

- ① M12 connector, PROFINET connection BUS OUT (Port2), Port type: MDI-X
- ② M12 connector, PROFINET connection BUS IN (Port1), Port type: MDI
- ③ M3, Functional Earth (FE) terminal screw (torque = 0.6 Nm)
- ④ M12 connector, Power supply connection

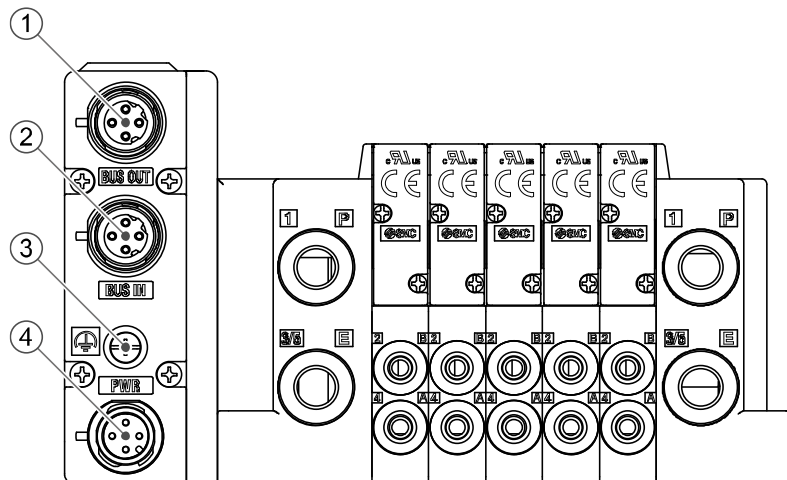

Fig. 3-3 Connectors and FE terminal identification

### 3.2.1. PROFINET/Power connection

The SI Unit has two PROFINET communication connectors. If only one connector is used, cover the unused connector with a seal cap so that the protection rating of IP67 is maintained.

#### ⚠ Caution

- Seal caps must be fitted to all unused bus connector ports to ensure an IP67 rating.
- IP67 rating must be maintained to guarantee PROFIsafe functionality.
- For reasons of EMC a secure connection to the cable shield must be established on the M12 PROFINET connectors (BUS IN/OUT).
- Power and PROFINET cables must be installed correctly.
- The 24 V supply for logic (PWR connector) and the 24 V supply for the valves (PWR(V) connector) should be protected with an external fuse.
- All external supplies should have the 0 V connected to functional earth according to EN 60204-1.
- A functional earth cable must be connected to the M3 terminal.
- If this product is connected using power cables that are more than 30 m long or go outside of a building then external protection devices should be added to protect against electrical surge damage.

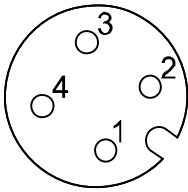

M12 4-pin plug  
A-coded connector(PWR)

Pin	Remarks
1	24 V (PWR(V))
2	0 V (PWR(V))
3	24 V (PWR)
4	0 V (PWR)

Fig. 3-4 Pin allocations of Power connectors

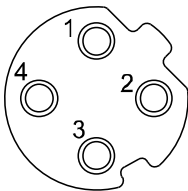

M12 4-pin socket  
D-coded connector  
(BUS IN/OUT)

Pin	(BUS IN) Port1 Port type: MDI		(BUS OUT) Port2 Port type: MDI-X	
	Remarks	Description	Remarks	Description
1	TD+	Transmit data+	RD+	Receive data+
2	RD+	Receive data+	TD+	Transmit data+
3	TD-	Transmit data-	RD-	Receive data-
4	RD-	Receive data-	TD-	Transmit data-

Fig. 3-5 Pin allocations of PROFINET communication connectors

Note:

When the autonegotiation function is disabled, you must use the correct network cable, refer to Fig 3-6, 3-7, 3-8.

Auto crossover function is not available when the autonegotiation function is disabled.

Auto crossover function shall be capable of switching over their twisted pair ports automatically between MDI and MDI-X pin assignment.

Port Connection	Usable Cable
BUS IN (MDI) to BUS OUT (MDI-X)	Patch cable
BUS IN (MDI) to BUS IN (MDI)	Crossover cable
BUS OUT (MDI-X) to BUS OUT (MDI-X)	Crossover cable

Fig. 3-6 Usable cable when autonegotiation function is disabled

The following figure shows two different cable wiring.

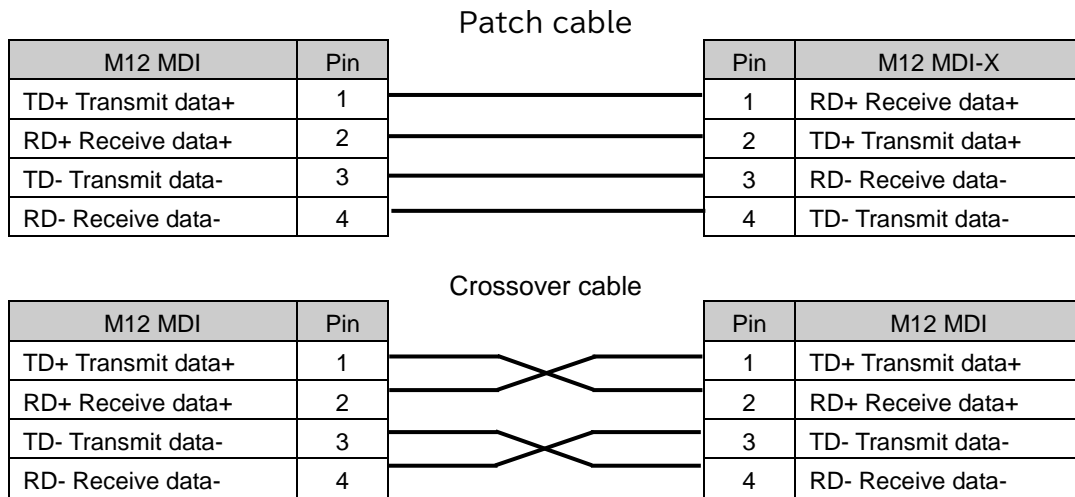
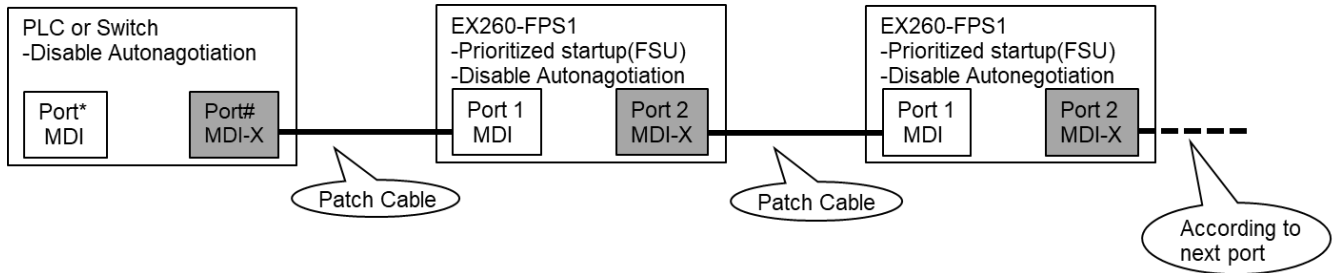

Fig. 3-7 Patch and Crossover Cable details

### Case 1



### Case 2

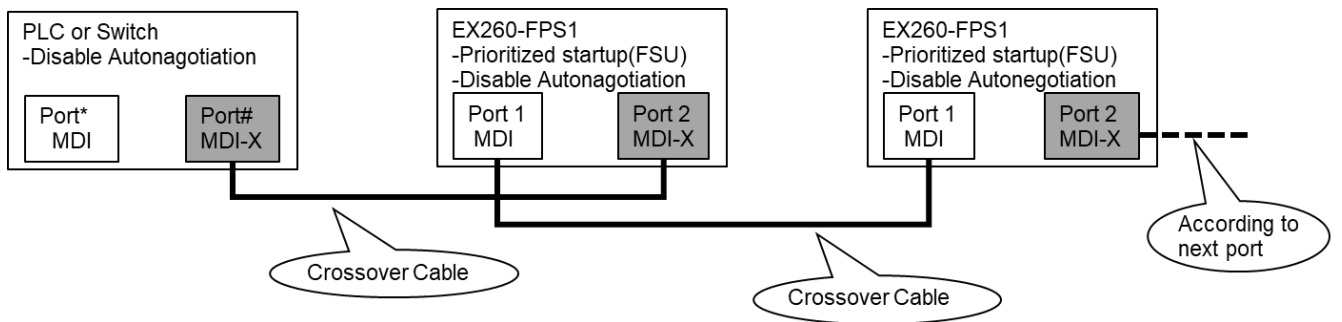

Fig. 3-8 Connection examples when autonegotiation function is disabled

#### 3.2.2. FE terminal

The SI Unit must be connected to FE (Functional Earth) to divert electromagnetic interference. Connect a grounding cable from the FE terminal screw on the SI Unit to the nearest functional earth point. The grounding cable should be as thick and short as reasonably possible.

## 4. Commissioning

### 4.1. Configuration

#### 4.1.1. GSD file and symbol files

In order to configure the SI Unit with your PROFIsafe controller software the appropriate GSD file is required. The GSD file contains all of necessary information to configure the SI Unit on your PROFIsafe controller software.

In order to represent the SI Unit in your PROFIsafe controller software the appropriate symbol files are required.

Current GSD file and symbol files name are as follows.

- GSD file: GSDML-V2.35-SMC-EX260-FPS-\*\*\*\*\*.xml
- Symbol file: GSDML\_0083\_EX260\_FPS.bmp

#### 4.1.2. Modules

EX260-FPS1 consists of the following modules.

Table 4-1 Overview of modules for EX260-FPS1

Module name	Occupied bytes		Allowable slot	Note
	Inputs	Outputs		
Safe valve power	4	5	1 (Fixed)	<a href="#">Refer to Section 4.3, Section 4.4</a>
Valves (32coils)	-	4	2 (Fixed)	<a href="#">Refer to Section 4.5</a>
1 Byte feedback information about the valve output status	1	-	2 (optional) insert to sub-slot	<a href="#">Refer to Section 4.6</a>

### 4.2. Diagnostics parameter

The SI Unit has the following module parameters.

Table 4-2 Diagnostics parameters

Parameters	Range of values	Default	Meaning
Logic power PWR supervision	Enable Disable	Enable	When this parameter is enabled, the system generates a diagnostics event if it detects that PWR is outside the permissible voltage range.
Valve power PWR(V) supervision	Enable Disable	Enable	When this parameter is enabled, the system generates a diagnostics event if it detects that PWR(V) is outside the permissible voltage range.

#### **⚠ WARNING:**

- If safe PWR(V) monitoring is required for the application or if PWR(V) diagnostic is disabled on the device PWR(V) failures must be managed externally by other means.
- If PWR(V) is entered lockout state, make sure valve outputs disable before PWR(V) is restarted, otherwise valves may operate causing unintended start up.

### 4.3. Safe valve power module

The SI Unit occupies 4 bytes of input data and 5 bytes output data for safety output and PROFIsafe communication.

The “Safe valve power” module has PROFIsafe parameters as defined in [Section 4.4](#).

Table 4-3 Details of “Safe valve power” module

	Byte	Description	Explanation
Inputs	0...3	Reserved for PROFIsafe communication container specified by PROFIsafe	-
Outputs	0	bit 0: Safe power supply (safety output) of PWR(V) for the valve	0: OFF, 1: ON
		bit 1..7: Reserved	Fixed 0
	1...4	Reserved for PROFIsafe communication container specified by PROFIsafe	-

### 4.4. PROFIsafe parameter

The “Safe valve power” module has the following PROFIsafe parameters.

Table 4-4 Details of PROFIsafe parameter

Parameter	Range	Default	Remarks
F_SIL	SIL3	SIL3	Static, Cannot change
F_CRC_Length	3-Byte-CRC	3-Byte-CRC	Static, Cannot change
F_Block_ID	0	0	Static, Cannot change
F_Par_Version	1	1	Static, Cannot change
F_Source_address	Automatic	1	Static
F_Destination_address	1 to 255	-	Static
F_WD_Time	10 to 10,000 ms	150 ms	Static
F_Par_CRC	Automatic	-	Static, Cannot change

Refer to [Appendix B](#) for details of all F-parameters.

## 4.5. Valves (32coils) module

The SI Unit occupies 4 bytes of output data for valves. The order of valve coils starts at the SI Unit from left to right.

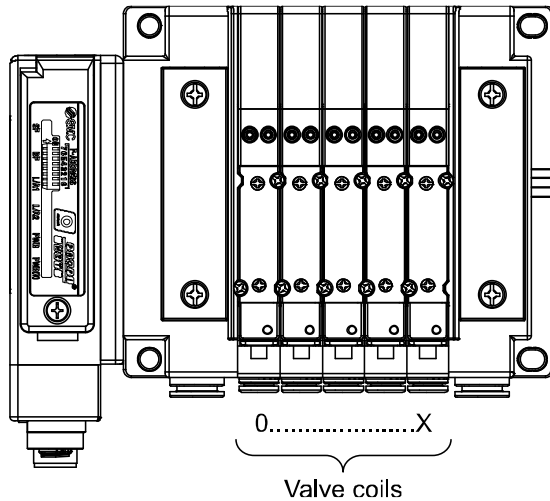

Byte	Output data
0	Valve coils 0-7
1	Valve coils 8-15
2	Valve coils 16-23
3	Valve coils 24-31

Fig. 4-1 The process data for valves

## 4.6. 1 Byte feedback information about the valve output status

The SI unit can provide the status of the Safe power supply (safety output) as digital input data on I/O mapping. To use this function, add the module (1 Byte feedback information about the valve output status) to sub-slot of slot 2 in your PROFIsafe controller software. Refer to [Section 4.1.2](#).

Table 4-5 Details of “1 Byte feedback information about the valve output status” module

Bit	Description	Explanation
0	Status of safe output	0: OFF, 1: ON
1	Status of the status bit in bit0	0: invalid, 1: valid
2..7	Reserved	Fixed to 0



## 5. Specifications

Table 5-1 EX260-FPS1 specifications

Item		Description
<b>General</b>		
Dimensions (W x L x H) mm		28.2 x 102.4 x 78.0
Weight		200 g or less
Housing material		PBT
Rated voltage		24 VDC
Supply interruption for no loss of function		1 ms and less
Protection class		IP67 (when fully installed or fitted with protective cover) (complies with IEC 60529)
Insulation resistance		10 Mega ohms or more between FE and other terminals. (500 VDC is given between FE and all accessible terminals) IEC 61131-2
Ambient temperature		Operation: -10 °C to 50 °C Storage: -20 °C to 60 °C
Ambient humidity		35% to 85% RH (non-condensing)
Atmospheric pressure		Operation: 80 kPa to 108 kPa (under 2000 m) Storage: 66 kPa to 108 kPa (under 3500 m)
Vibration resistance		10 Hz to 57 Hz (constant amplitude) 0.75 mm 57 Hz to 150 Hz (constant acceleration) 49 m/s <sup>2</sup> 2 hours for each direction X, Y and Z EN 60068-2-6
Impact resistance		147 m/s <sup>2</sup> is given 3 times for each direction X, Y and Z EN 60068-2-27
Operating environment		No corrosive gas
<b>Electrical</b>		
PWR For logic	Operating voltage	24 VDC +20%/-15%
	Under voltage detection	Detected: < approx. 19 VDC
	Under voltage lockout	< approx. 16 VDC
	Over voltage detection	> approx. 33 VDC
	Over voltage lockout (fuse blown)	> approx. 40 VDC
	Internal current consumption at 24 VDC	0.2 A or less
PWR(V) For valves	Operating voltage	24 VDC +20%/-15%
	Under voltage detection	Detected: < approx. 19 VDC
	Under voltage lockout	< approx. 16 VDC
	Over voltage detection	> approx. 33 VDC
	Over voltage lockout (fuse blown)	> approx. 40 VDC
	Max. current	1.3 A
	Voltage drop to valve supply	Max. 1.2 V at 24 VDC
Protection against polarity reversal		Yes (PWR and PWR(V))
Galvanic isolation		Yes (between PWR and PWR(V))

Table 5-1 EX260-FPS1 specifications (continued)

Solenoid valve	
Output type	PNP (negative common)
Max. number of solenoid valves	32
Connected load	Solenoid valve with surge voltage suppressor of 24 VDC and 0.95 W or less (manufactured by SMC)
Applicable valve series	SY series SY3000, SY5000, SY7000 JSY series JSY1000, JSY3000, JSY5000
Over current protection	Yes
Over current detection	Yes
Fieldbus	
Bus protocol	PROFIsafe V2.4, PROFINET V2.34
Fast Start Up	Yes
Media Redundancy Protocol	Yes
Shared Device	Yes
Conformance class 3	Yes (Only for IRT switch function)
Vendor ID	0083h
Device ID	000Ch
GSD file	GSDML-V2.35-SMC-EX260-FPS-*****.xml
Certifications	
EMC directive	Yes, 2014/30/EU, EN 61131-2, EN 61131-6
Machinery directive	Yes, 2006/42/EC, EN 62061, EN ISO 13849
RoHS	2011/65/EU, EN50581: 2012
TUV Certification	Yes, IEC 61508, EN 62061, EN ISO 13849
PROFINET & PROFIsafe	Yes
UL/cUL	Yes, E209424

## 6. Indication and setting

### 6.1. LED indicators

The LED indicators are arranged on the SI Unit as shown in the illustration below.

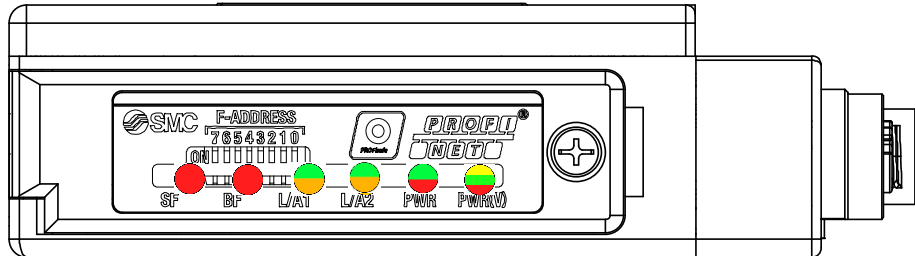

















Designation	Description	Colour		
SF	System fault	Red 		
BF	Bus fault	Red 		
L/A1	A combination of Link LED and Act LED Connection via PROFINET on BUS IN, and Data exchange on BUS IN	Green 	Orange 	
L/A2	A combination of Link LED and Act LED Connection via PROFINET on BUS OUT, and Data exchange on BUS OUT	Green 	Orange 	
PWR	Supply for the logic	Green 	Red 	
PWR(V)	Supply for the valves	Green 	Yellow 	Red 

Fig. 6-1 LED indicators

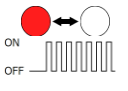

### 6.1.1. SF and BF indicators

Table 6-1 SF and BF indicators

SF	BF	Meaning
OFF 	OFF 	No fault (The SI Unit is currently exchanging data with the controller without errors)
	Flash 	Faulty or no connect message frame (although the SI Unit is physically connected to an Ethernet) <ul style="list-style-type: none"> <li>• Configuration is defective, or initial commissioning has not been completed</li> <li>• Device name is different from the programmed setting</li> <li>• The GSD file is not correct</li> <li>• The Controller is defective</li> </ul>
---	ON 	No physical connection on both PROFINET communication connector
Flashing at 2 Hz 	---	PROFIsafe communication is not established due to the following reason(s) <ul style="list-style-type: none"> <li>• No safe communication</li> <li>• The SI unit is not parameterized by the Safe controller</li> <li>• The parameterization is not acceptable</li> <li>• The F-address is not matched</li> </ul>
Flashing at 0.5 Hz 	---	The Safe controller requests operator acknowledgment
ON 	---	The following diagnostic event(s) occurred <ul style="list-style-type: none"> <li>• Power supply is not present or is outside the permissible voltage range.</li> <li>• Over voltage lockout safe state entered</li> <li>• At least one valve coil has a short circuit</li> <li>• Self-test has failed and a power reset is required</li> <li>• The PLC mode is stop</li> </ul>



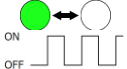

### 6.1.2. L/A indicator

Table 6-2 L/A indicator

L/A	Meaning
Green ON 	Connection via Ethernet to the SI Unit via BUS IN/OUT But no transmission or reception of Ethernet telegrams on BUS IN/OUT
Orange ON or Flashing Green/Orange 	Connection via Ethernet to the SI Unit via BUS IN/OUT Transmission or reception of Ethernet telegrams on BUS IN/OUT
OFF 	No physical connection to the port
Green Flashing 	Received "Flash Once" request







### 6.1.3. PWR indicator

Table 6-3 PWR indicator

PWR	PWR voltage	Meaning
OFF 	<16 V	PWR is not present
Green Flashing 	16 V...19 V	PWR is below the permissible voltage range.
Green ON 	19 V...33 V	PWR is present
Red Flashing 	33 V...40 V	PWR is above the permissible voltage range.

### 6.1.4. PWR(V) indicator

Table 6-4 PWR(V) indicator

PWR(V)	PWR(V) voltage	Safe power supply status	Meaning
Yellow ON 	<16 V	Not active	<ul style="list-style-type: none"> <li>●PWR(V) is not present or below the permissible voltage range</li> <li>●Safe power supply (safety output) for the valve is not active</li> </ul>
Yellow Flash 			
Green Flashing 	16 V...19 V	Active	<ul style="list-style-type: none"> <li>●PWR(V) is below the permissible voltage range</li> <li>●Safe power supply (safety output) for the valve is active</li> </ul>
Green ON 			
Yellow/Green Flashing 	19 V...33 V	Not active	<ul style="list-style-type: none"> <li>●PWR(V) is present</li> <li>●Safe power supply (safety output) for the valve is not active</li> </ul>
Red/Yellow Flashing 	33 V...40 V		

## 6.2. Production label

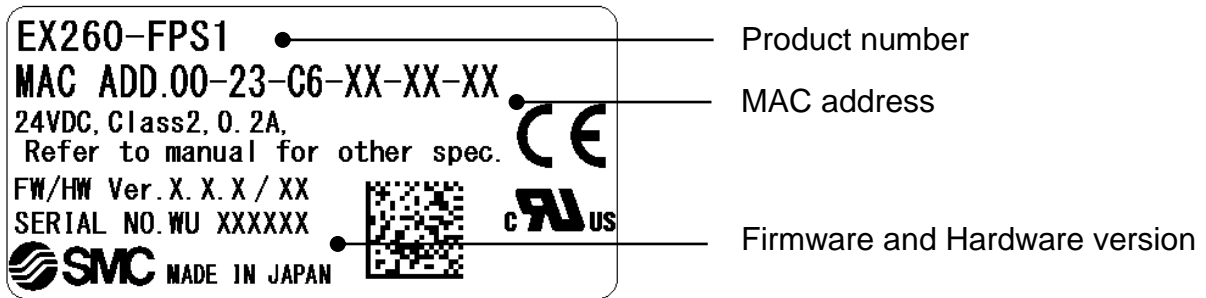

- Firmware version (FW): 1.0.x (X is a number 0 or more)
- Hardware version (HW): 03 and higher
- 

Fig. 6-2 Production label

## 6.3. PROFIsafe address switch

An eight-bit DIP-Switch is provided for the F\_Address of PROFIsafe. The switch setting is only checked at power-up. Any changes made during operation are ignored and may lead to problems during the next power-up sequence

Using the DIP switches:

- Unscrew the cover and hinge it upwards.
- The DIP switches can be adjusted with a small flat-blade screwdriver.
- Tighten the cover again, making sure that the seals are positioned correctly. (torque = 0.3 Nm)

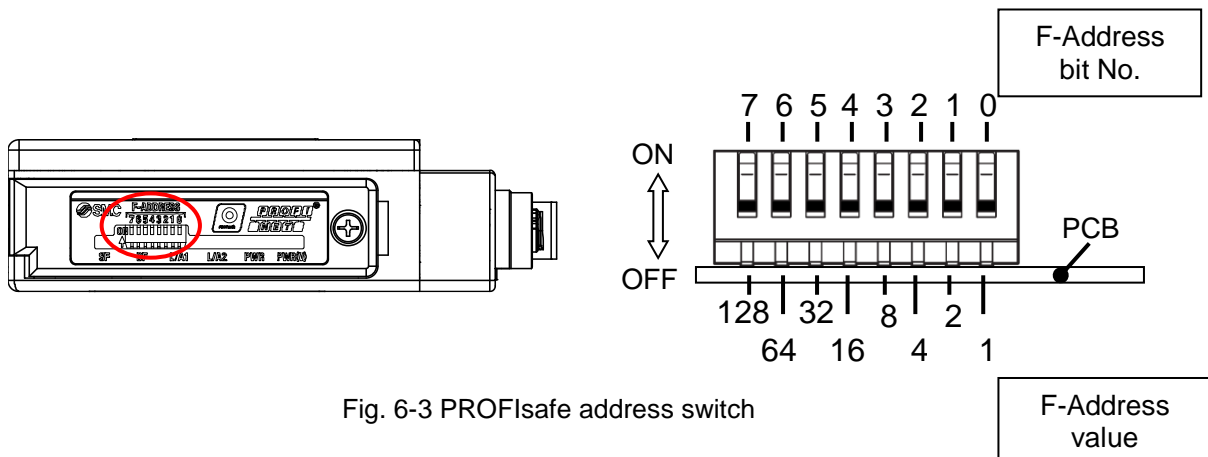

Fig. 6-3 PROFIsafe address switch

Note:

- The F-Address bit numbering shown on the label has priority over any numbers printed on the DIP switch.
- The default state (factory setting) for this DIP switch is all OFF.

## 7. Accessories

### 7.1. Seal cap

Seal caps can be used with the EX260-FPS1.  
Mount the seal cap in the unused M12 socket connector.  
IP67 is satisfied by using the seal cap properly.

Model No.: EX9-AWTS  
(M12 connector for socket 10 pieces)

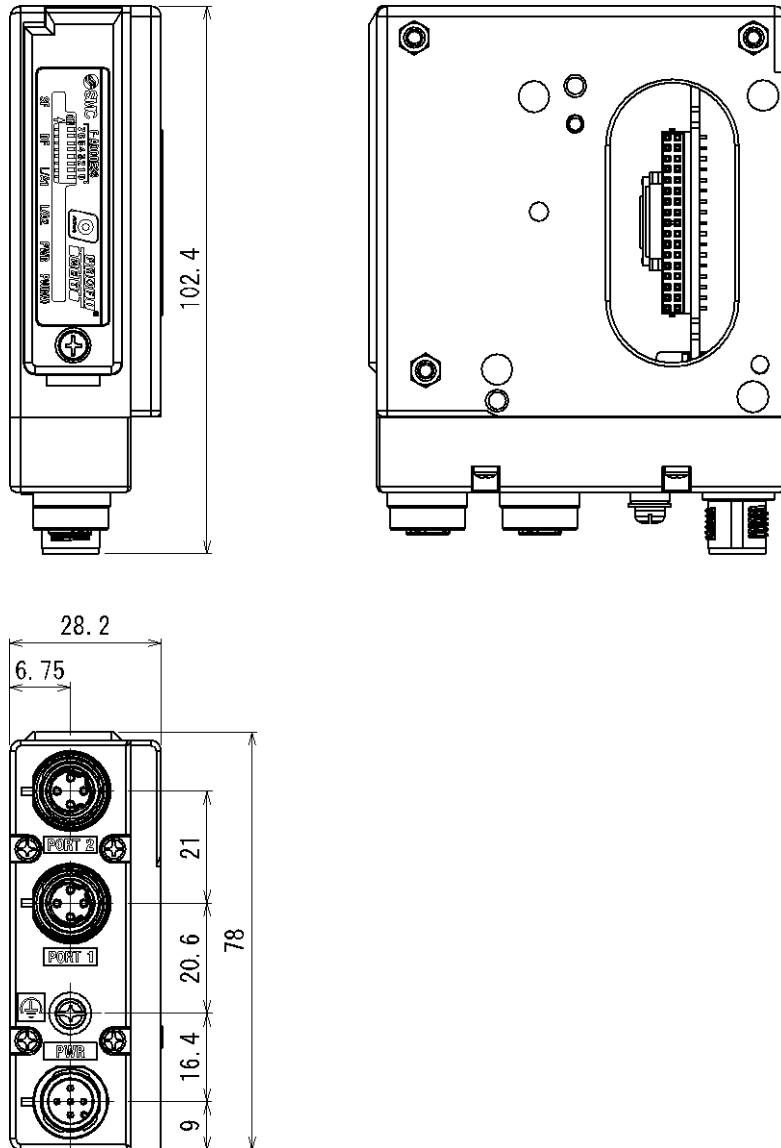

Fig. 7-1 EX9-AWTS

Note:  
Tighten the seal caps to the tightening torque specified (0.2 Nm).

## 8. Dimensions

The following figure shows the dimensions of EX260-FPS1.





## 9. Troubleshooting

### 9.1. Troubleshooting

Table 9-1 Troubleshooting for network communication



No.	Problem	Possible cause	Remedy
1	L/A indicator is OFF	No physical connection to Ethernet network	<ul style="list-style-type: none"> <li>●Check the cable connection</li> <li>●Check network settings</li> </ul>
		Auto-negotiation not successful	
2	L/A indicator is Green ON 	Connection via Ethernet is OK, but no connection to the PROFINET Controller (no PROFINET Controller available on the Ethernet)	<ul style="list-style-type: none"> <li>●Check network settings</li> <li>●Check PROFINET controller is active</li> </ul>
3	BF indicator is Red ON 	No physical connection on both PROFINET communication connector	<ul style="list-style-type: none"> <li>●Check the cable connection</li> <li>●Check network settings</li> <li>●Check the L/A indicators</li> </ul>
		Auto-negotiation not successful	
4	BF indicator is Red flashing 	The SI Unit is connected to the Ethernet network, but the following problem has occurred	---
		<ul style="list-style-type: none"> <li>●The SI Unit is not connected to the PROFINET Controller</li> </ul>	<ul style="list-style-type: none"> <li>●Check the cable connection</li> <li>●Check network settings</li> <li>●Check PROFINET controller is active</li> </ul>
		●Configuration is defective	Check the configuration
		●Device name is not correct	Check the Device names
		●The GSD file is not correct	Check the GSD file
		●The PROFINET Controller is defective	Check the PROFINET Controller

Table 9-2 Troubleshooting for diagnostic events

No.	Problem	Possible cause	Remedy
1	SF indicator is Red ON 	Power supply is outside the specified voltage range	<ul style="list-style-type: none"> <li>●Check the PWR and PWR(V) indicators</li> <li>●Check the power supply and supply voltage level</li> </ul>
		The SI Unit entered high voltage safe status	●Check the power supply voltage level and remedy.
		At least one valve coil has a short circuit	Check the solenoid valves for any short circuit
		Self-test has failed	<ul style="list-style-type: none"> <li>●Reset the power supply</li> <li>●Check the diagnostic message</li> </ul>
		The PROFINET Controller is defective	●Check the PLC mode

Table 9-2 Troubleshooting for diagnostic events(continued)

No.	Problem	Possible cause	Remedy
2	SF indicator is Red flashing at 2Hz 	No safe communication	Check the PROFIsafe configuration and F-Address switch
		The SI Unit is not parameterized by the Safe controller	Check the PROFIsafe configuration
		The parameterization is not acceptable	Check the configuration
		The F-Address is not matched	Check the PROFIsafe configuration and F-Address switch
3	SF indicator is Red flashing at 0.5Hz 	The safe controller requests operator acknowledgment for the SI Unit	<ul style="list-style-type: none"> <li>●Check the diagnostic message</li> <li>●Reintegrate the SI Unit</li> </ul>

Table 9-3 Troubleshooting for PWR for operation



No.	Problem	Possible cause	Remedy
1	PWR indicator is OFF	Incorrect wiring	<ul style="list-style-type: none"> <li>●Check the cable</li> <li>●Check the wiring and pin assignment</li> </ul>
		PWR is not present	Check the power supply and supply voltage level
		Fuse blown by over voltage protection (>40 V)	<ul style="list-style-type: none"> <li>●Check the power supply voltage level.</li> <li>●Replace with a new unit.</li> </ul>
2	PWR indicator is Green flashing 	PWR is lower than the permissible level	Check the power supply voltage level
3	PWR indicator is Red flashing 	PWR is higher than the permissible level	Check the power supply voltage level

Table 9-4 Troubleshooting for PWR(V) for valves

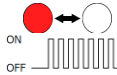
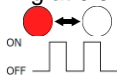



No.	Problem	Possible cause	Remedy
1	PWR(V) indicator is OFF	Power supply voltage for PWR is not present	Check the power supply and supply voltage level
		Incorrect wiring	<ul style="list-style-type: none"> <li>●Check the cable</li> <li>●Check the wiring and pin assignment</li> </ul>
		Fuse blown by over voltage protection (> 40 V)	<ul style="list-style-type: none"> <li>●Check the power supply voltage level.</li> <li>●Replace with a new unit.</li> </ul>
2	PWR(V) indicator is Yellow ON 	Incorrect wiring	<ul style="list-style-type: none"> <li>●Check the cable</li> <li>●Check the wiring and pin numbers</li> </ul>
		PWR(V) is not present	Check the power supply voltage level
3	PWR(V) indicator is Yellow flash 	PWR(V) is lower than the permissible level	<ul style="list-style-type: none"> <li>●Check the power supply voltage level</li> <li>●Turn on the Safe power supply (safety output)</li> </ul>
4	PWR(V) indicator is Green flash 		Check the power supply voltage level
5	PWR(V) indicator is Yellow/Green flashing 	Safe power supply (safety output) for the valve is not active	Turn on the Safe power supply (safety output)
6	PWR(V) indicator is Red/Yellow flashing 	PWR is higher than the permissible level	Check the power supply voltage level

Table 9-5 Troubleshooting for valve operation

No.	Problem	Possible cause	Remedy
1	Valve cannot be Turned ON	No PROFINET and PROFIsafe communication	Check the LEDs
		Safe power supply (safety output) for the valve is not active	Turn on the Safe power supply (safety output)
		The safe controller requests operator acknowledgment for the SI Unit	<ul style="list-style-type: none"> <li>●Check the diagnostic message</li> <li>●Reintegrate the SI Unit</li> </ul>
		PWR or/and PWR(V) is not present or lower than the permissible level	<ul style="list-style-type: none"> <li>●Check the power supply and supply voltage level</li> <li>●Check the PWR and PWR(V) LED indicator</li> </ul>
		Connection between the SI Unit and valve manifold is defective	Check the connection between the SI Unit and valve manifold
		The SI Unit and valve output type(PNP/NPN) do not match	Check the output type(PNP/NPN) the SI Unit and valves.
		Self-test has failed	<ul style="list-style-type: none"> <li>●Reset the power supply</li> <li>●Check the diagnostic message</li> </ul>
		Valve has failed programming	Replace the valve Check the program

## 9.2. Acknowledgment and restart

- Remove the cause of the error
- Acknowledge the diagnostic message
- Parameterization errors cannot be acknowledged. In this case, proceed as follows:
  - Check the parameterization
  - Adapt the parameterization
  - Download the new data record

For instructions on error acknowledgment, refer to the documentation for the controller used.

### **⚠ WARNING: Hazardous machine state/unintentional machine startup**

The acknowledgment of an error can result in a hazardous state as well as unintentional machine startup since the safe input is immediately returned to the operating state.

- Before acknowledging an error you must make sure that acknowledgment will not cause the machine to switch to a hazardous state.
- When planning the machine or system, make sure that acknowledgment is only possible when the danger zone is visible.

### **⚠ WARNING: Unintentional machine startup**

Startup /restart following power up and when there is no longer a demand of the safety function can result in unintentional machine startup.

Please note that:

- If you do not want the machine to restart automatically, configure the safety logic accordingly.
- If PWR(V) is enters the lockout state, make sure valve outputs are disabled before PWR(V) is restarted, otherwise valves may operate causing unintended start up.

## Appendix A: Glossary for PROFI-safe

A definition of PROFI-safe terms is also provided in the PROFI-safe profile.

### CRC

Cyclic Redundancy Check

A cyclic redundancy check is used to verify the validity of the process data contained in the safety telegram, check whether the assigned address books are correct, and verify the safety-related parameters. This value is part of the safety telegram.

### Consecutive number

Method for ensuring that the safe data is transmitted completely and in the correct order.

### F-Parameter

(According to PROFI-safe system description, Version 09, November 2007)

F-Parameters contain information for adapting the PROFI-safe layer to customer specifications and for checking the parameterization by means of a separate method (diverse). The main F-Parameters are:

#### **F\_Source/Destination\_Address (F-Address for short)**

The F-Source address is combined with the F-destination address to generate a 'Codename' to identify the communication relationship between two devices. The technology part of the F-Device compares the value with the address switch locally or with an assigned F-Address in order to check the authenticity of the connection.

#### **F\_WD\_Time**

Specifies the millisecond value for the watchdog timer. The timer monitors the time that elapses until the next valid PROFI-safe message is received.

#### **F\_SIL**

Indicates the SIL that the user can expect from the relevant F-Device. It is compared with the manufacturer's specification that is stored locally.

#### **F\_iPar\_CRC**

A checksum that is calculated from all i-Parameters of the technology-specific part of the F-Device.

#### **F\_Par\_CRC**

A CRC signature, which is created via all F-Parameters and ensures error-free transmission of the F-Parameters.

### F-CPU

Failsafe controller, safe controller

### F\_Destination\_Address

F-Parameter; PROFI-safe destination address; address of the safe module (refer to also ["F-Parameter"](#))

### F-I/O device

Failsafe I/O device, safe input and/or output modules

Modules with integrated safety functions, which are approved for safety-related operation.

## **F-Slave**

Failsafe slave

## **F\_Source\_Address**

F-Parameter, PROFIsafe source address; address of the safe controller (Refer to also ["F-Parameter"](#))

## **F-System**

Failsafe system

A failsafe system is a system that remains in the safe state or immediately enters a safe state when specific failures occur.

## **i-Parameter**

Individual safety parameters of a module

## **Passivation**

If the safety module (F-I/O device) detects an error, it switches the affected channel or all channels of the module to the safe state. The channels are passivated. The detected errors are indicated at the safe controller.

For a safe input module when the F-System is passivated, instead of the process values present at the safe inputs, "0" substitute values are provided for the safety program.

For a safe output module when the F-System is passivated, instead of the output values provided by the safety program, "0" substitute values are transferred to the safe outputs.

## **PI**

PROFIBUS & PROFINET International

## **PNO**

Profibus Nutzerorganization e.V

## **PROFIsafe**

Safety-related bus profile based on PROFIBUS DP or PROFINET. The profile defines the communication between a safety program and the safe I/O device (F-I/O device) in a safe system (F-System).

## **PROFIsafe address**

Each safe module has a PROFIsafe address. Set this address on the safety module (F-I/O device) via DIP switches and then configure it in the configuration tool for the safe controller.

## **PROFIsafe monitoring time**

Monitoring time for safety-related communication between the safe controller (F-CPU) and safe I/O device (F-I/O device).

This time is parameterized in the F\_WD\_Time F-Parameter.

## **Short circuit**

Signal is either short circuited to another signal or 0 V.

# Appendix B: Parameters for PROFI-safe

## F-parameters



The values indicated in italics in Table are preset by the system and cannot be modified manually.

Table B-1 Overview of the F-Parameters for the module

F-Parameter	Default value	Description
F_SIL	SIL 3	<p>Safety integrity (SIL according to IEC61508) of the module.</p> <div style="border: 1px solid black; padding: 5px; display: inline-block;"> <p>Safety functions up to SIL 3 can be achieved with the module. The safety integrity level that can actually be achieved depends on the parameterization, the structure of the sensor, and the cable installation: Refer to <a href="#">Section 4.4. "PROFI-safe parameter"</a>.</p> </div>
F_CRC_Length	3 byte CRC	This parameter transmits the length of the CRC2 code to be expected in the safety telegram to the safe controller.
F_Block_ID	0	Parameter block type identification. 0: the parameter block of the F-Parameters does not contain the F_iPar_CRC parameter.
F_Par_Version	1	Version number of the F-Parameter block. 1: valid for V2 mode.
F_Source_Address	1	The parameter uniquely identifies the PROFI-safe source address (controller address). The address is assigned automatically.
F_Destination_Address	-	PROFI-safe destination address (address of the safe module). The address has to be set to correct value in configuration software and at device (DIP switch). Ensure each individual device is assigned a unique address. Make sure that the value set under F_Destination_Address is the same as the value that you have set via the 8-pos. DIP switch. <a href="#">Refer to section 6.3 "PROFI-safe address switch"</a> . Value range: 1 ... 255
F_WD_Time	150	Monitoring time in the module. A valid current safety telegram must arrive from the safe controller during the monitoring time. Otherwise the module enters the safe state. The selected monitoring time must be sufficiently high for telegram delays to be tolerated by the communication, but still ensure a sufficiently fast error response in the event of an error (e.g., interruption in communication). Value range: 10 ... 10000, in 1 ms increments Unit: ms
F_Par_CRC	-	A CRC signature, which is calculated automatically via all F-Parameters and ensures error-free transmission of the F-Parameters.

## i-Parameters

There are no i-parameters in this product

## Appendix C: Checklists

The checklists listed in this section provide support when carrying out the following tasks on the SI unit: planning, assembly and electrical installation, commissioning, parameterization, and validation.

These checklists may be used as planning documentation and/or as verification to ensure the steps in the specified phases are carried out carefully.

Archive the completed checklists to use as reference for recurring tests.

The checklists do not replace the validation, initial commissioning, and regular testing performed by qualified personnel.

The following section of a checklist shows an example of a completed checklist.

Table C-1 Example of a checklist

Checklist				
Device type/equipment identification		EX260-FPS1		
Version: HW/SW	01/1.1.1	Date	2017-July-1st	
Creator	John Smith	Test engineer	Jane Brown	
Remark	System XXX has been checked for engine hood production			
No.	Requirement (mandatory)	Yes		Remark
X				
No.	Requirement (Optional)	Yes	No	Remark
Y				

### Key

#### Equipment identification:

Enter the device type and/or the equipment identification for the relevant module.

#### Version:

HW/FW enter the hardware and firmware version of the module as shown on the label on the SI Unit.

For details of the label on the SI Unit, refer to [Section 6.2. "Production label"](#).

#### Date:

Enter the date on which you began to fill in this checklist.

#### Creator:

Enter the name of the person creating this checklist.

#### Test engineer:

Enter the name of the test engineer.

#### Remark:

Enter a remark, if necessary.

#### Requirement (mandatory):

These requirements must be met for a safety application, in order to complete the relevant phase using the checklist.

#### Requirement (optional):

These requirements are optional. For points that are not met, please enter an appropriate remark in the relevant field.



Table C-2 Planning

Checklist for planning the use of the module				
Device type/equipment identification				
Version: HW/FW		Date		
Creator		Test engineer		
Remark				
No.	Requirement (mandatory)	Yes		Remark
1	Has the current user manual for this product been used as the basis for planning?			Revision:
2	Are the valve manifold and selected valves approved for connection to the module (according to the technical data and parameterization options?)			
3	Has the voltage supply been planned according to the specifications for the protective extra-low voltage (PELV) or safety extra-low voltage (SELV)?			
4	Has the power supply of PWR and PWR(V) from respective power supply units been planned?			
5	Is external protection for the module planned (according to the specifications in this user manual for supply voltage PWR and PWR(V))			
6	Are measures planned to prevent simple manipulation of PWR and PWR(V)?			
7	Are measures planned to prevent connectors being mixed up?			
8	Are requirements for the actuators and cable installation specified according to the SIL/SILCL/Cat./PL to be achieved?			
9	Are the specifications for the parameterization defined?			
10	Are test intervals specified for testing the shutdown capability of the valves, if this is required to achieve a SIL/SILCL/Cat./PL?			
11	Has it been ensured that any person intentionally starting hazardous movements can only do so with a direct view of the danger zone?			
12	Does the planned use correspond to the intended use?			
13	Are the ambient conditions in conformity with the technical data?			
14	Have test intervals been defined?			
15	Has the switch-off delay for stop category 1 been observed in the calculation of the total response time for the machine/system?			
No.	Requirement (optional)	Yes	No	Remark
16	Have specifications for assembly and electrical installation been defined (e.g., EPLAN) and communicated to the relevant personnel?			
17	Have specifications for commissioning been defined and communicated to the relevant personnel?			
		Date		Signature (creator)
		Date		Signature (test engineer)

Table C-3 Assembly and Electrical Installation

Checklist for Assembly and Electrical Installation of the module				
Device type/equipment identification				
Version: HW/FW		Date		
Creator		Test engineer		
Remark				
No.	Requirement (mandatory)	Yes		Remark
1	Was assembly completed according to the specifications (specifications from the planning phase or according to the user manual)?			
2	Are all unused ports fitted with a seal cap?			
3	Do the cable cross sections and installation correspond to the specifications?			
4	Does the connection technology correspond to the specifications in the technical data and in the relevant user manual?			
No.	Requirement (optional)	Yes	No	Remark
5	Is the PROFINET/PROFIsafe address set correctly according to the specifications?			
		Date		Signature (creator)
		Date		Signature (test engineer)

Table C-4 Commissioning and Parameterisation

Checklist for commissioning and parameterization of the module				
Device type/equipment identification				
Version: HW/FW		Date		
Creator		Test engineer		
Remark				
No.	Requirement (mandatory)	Yes		Remark
1	Was commissioning completed according to the specifications (specifications from the planning phase or according to the user manual)?			
2	During commissioning, is it ensured that any person intentionally starting hazardous movements can only do so with a direct view of the danger zone?			
3	Are all parameters parameterized for the outputs and is the F_WD_Time set correctly?			
4	If PWR(V) diagnostics parameter is disable is a suitable countermeasure used?			
No.	Requirement (optional)	Yes	No	Remark
5	Have safety distances that must be observed been calculated according to the response and delay times implemented/?			
		Date		Signature(creator)
		Date		Signature (test engineer)

Table C-5 Validation

Checklist for validation			
Device type/equipment identification			
Version: HW/FW		Date	
Creator		Test engineer	
Remark			
No.	Requirement (optional)	Yes	Remark
1	Have all the mandatory requirements for the "Planning" checklist been met?		
2	Have all the mandatory requirements for the "Assembly and electrical installation" checklist been met?		
3	Have all the mandatory requirements for the "Commissioning and parameterization" checklist been met?		
4	Does the parameterization of the safe outputs correspond to the version and the actual connection of the controlled device?		
5	Has the assignment of the valves to the outputs and the variables of the safe application program been tested(online status in PROFIsafe controller software)?		
6	Has a function test been performed to check all safety functions, in which the module is involved?		
7	Have measures been taken to achieve a specific Cat.?		
8	Do all cables correspond to the specifications?		
9	Does the power supply correspond to the specifications for the protective extra-low voltage (PELV) or safety extra-low voltage (SELV)?		
10	Have the voltage supply of PWR and PWR(V) from a power supply unit been correctly implemented?		
11	Is external protection of the module implemented (according to the specifications in this user manual for supply voltage PWR and PWR(V))?		
12	Have measures been taken to prevent simple manipulation?		
13	Are the requirements for the valves and cable installation observed according to the SIL/SILCL/Cat./PL?		
14	Are test intervals specified for testing the shutdown capability of the actuators, if this is required to achieve a SIL/SILCL/Cat./PL?		
15	Has it been ensured that any person intentionally starting hazardous movements can only do so with a directly view of the danger zone?		
		Date	Signature (creator)
		Date	Signature (test engineer)

## Appendix D: Safety Characteristics

Item	Operation	Value
SFF		>90%
HFT Hardware Fault tolerance		1
PFH Probability of dangerous failure per hour		<1 FIT
Hardware classification		Type B
Safety Level		SIL3 / PL e
Mission Time		20 years

## Appendix E: EX260-FPS Timing Values

### Typical timing values of SMC EX260-FPS1

Reaction time for safety function	: < 6 ms
Non safe valve output delay	: 2 ms
single fault diagnostic detection time	: < 15 min
Device acknowledge time (DAT)	: <= 10 ms

For calculating/determining the response time (safety function response time – SFRT) please look at the user manual of the used safe profinet controller.

Operating delay time of the valves is not considered

## Appendix F: Failure modes

The function of the product is to safely control the switching off of the attached pneumatic valves. Hazards and harmful events that could compromise this function need to be responded to as defined below.

No	Failure	Cause	Detected by	Action
1	High voltage PWR or PWR(V)	External power supply fault	Power supply monitor circuit	Turn off supply to valves by safety switches, report by diagnostics, show on diagnostic LED and inhibit turn on.
2	Low voltage PWR or PWR(V)	External power supply fault	Power supply monitor circuit	Report by diagnostics and show on PWR / PWR(V) diagnostic LED only if enabled.
3	Low lockout voltage PWR(V)	External power supply fault	Power supply monitor circuit	Turn off supply to valves by safety switches. If enabled report by diagnostics and show on diagnostic LED.
	Low lockout voltage PWR	External power supply fault	Power supply monitor circuit	Full system shutdown, safety switches off.
4	Failure of high side switch	Internal component failure	Routine test pulse	Turn off supply to valves by low side switch. Report fault by diagnostics, show on diagnostic LED, and inhibit turn on.
5	Failure of low side switch	Internal component failure	Routine test pulse	Turn off supply to valves by high side switch. Report fault by diagnostics, show on diagnostic LED, and inhibit turn on.
6	Excess temperature	External environment condition	Temperature sensor	Turn off supply to valves by safety switches. Report fault by diagnostics, show on diagnostic LED, and inhibit turn on.
7	PROFINET communication fault	<ul style="list-style-type: none"> <li>●External cable</li> <li>●PLC failure</li> <li>●Communication failure</li> </ul>	PROFINET controller	Turn off supply to valves by safety switches, show on diagnostic LED, and inhibit turn on.
8	Single processor fault	Internal component failure	Mutual monitoring processor	Turn off supply to valves by safety switches, show on diagnostic LED, and inhibit turn on.
9	Valve overcurrent/short circuit	External component failure	Output driver	Turn off supply to valves by safety switches. Report fault by diagnostics, show on diagnostic LED, and inhibit turn on.
10	Reverse supply protection	External installation error	Polarity diode	No function and no supply to valves.

### In addition:

- The device goes into the Fail-safe state if it detects a fault. In Fail-safe state the output is "Off".
- The communication between the PROFIsafe controllers and the EX260-FPS1 is diagnosed continuously.
- The state of two redundant output switches are diagnosed during power-up, and periodically during the runtime.

#### Revision history

##### Revision A

Add the "Original Instructions" in page 2.  
Change the design in Fig. 6-2.

##### Revision B

X222 & FPS2 versions removed, note added about connection of FE to M3 terminal, high voltage threshold changed from 32 V to 33V, HW version updated to 03, product label updated, anti-tamper label added, power supply current rating added, yellow deleted from L/A & PWR LED descriptions. [October 2020]

## SMC Corporation

4-14-1, Sotokanda, Chiyoda-ku, Tokyo 101-0021 JAPAN

Tel: + 81 3 5207 8249 Fax: +81 3 5298 5362

URL <https://www.smcworld.com>

Note: Specifications are subject to change without prior notice and any obligation on the part of the manufacturer.

© 2018-2020 SMC Corporation All Rights Reserved



No.EX※※-OMU1006-B