



Operation Manual

THERMO-CON

Model No.

*HEC001-W5**

*HEC003-W5**

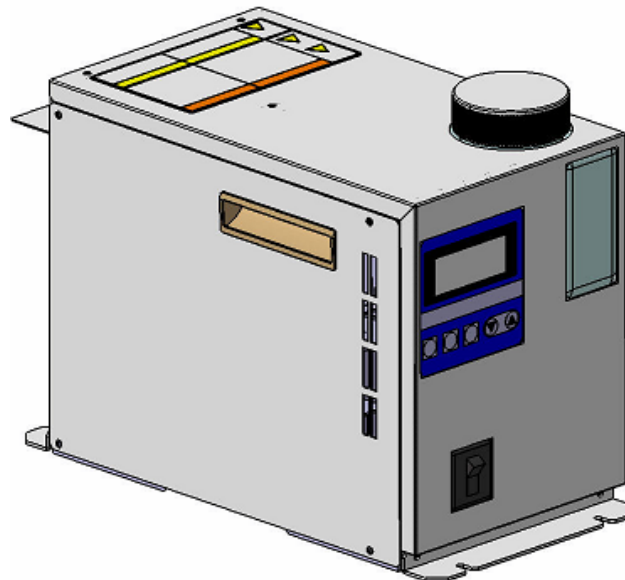

Keep this manual available at all times.

Preface

Thank you very much for purchasing SMC Thermo-con (herein referred to as the “product”).

This manual describes the operation of the product. Please use this manual for efficient and long use of this unit. Be sure to read this manual efficiently for your deep understanding of overview and safety of this unit before installation or carrying out the relevant operations of this unit. Especially, you need to follow the instructions about “Danger”, “Warning” and “Caution”.

Packaged items

Upon receipt of the ordered product, immediately check that the following components have been included.

No.	Item	Qty.
1	Product	1
2	Power supply cable	1
3	Foot	2
4	Operation Manual	1

*The shape of each part can be checked in “4.1 Description of Parts”.

Warning and Precautions on Handling

- 1) Be sure to read these Warnings and Precautions before installation or operation of the product.
- 2) This manual provides explanations of the installation and operation of this product. Only those who have a thorough understanding of the operating procedures and who have basic knowledge and skills in handling industrial equipment are qualified to perform installation and operation.
- 3) The contents of this manual and the related documents supplied with this product shall be neither regarded as provision of a contract nor utilized to correct or modify any existing agreements, commitments and relations.
- 4) Copying, duplicating or transferring any part or the entire manual without the prior permission of SMC is strictly prohibited.
- 5) This product has been developed for physical, chemical, and industrial facility applications. When it is used for applications that require the consideration additional safety precautions, e.g., for medical devices, investigate the safety needs for the application at the customer’s site before use.

<Contact>

If you have any questions or are unclear about any of the content of this manual, please contact the following department.

Product Development Div. 6, Engineering Headquarters
Japan Technical Center, SMC Corporation,
Address: 4-2-2 Kinunodai, Tsukubamirai-city, Ibaraki-ken, 300-2493

TEL: +81 297-52-6666
FAX: +81 297-20-5007
E-mail: kaihatsu_6_g3@smcjpn.co.jp

Note: The contents of this manual are subject to change without

Contents

1 SAFETY INSTRUCTIONS -----	1-1
1.1 BEFORE USING THE THERMO-CON -----	1-1
1.1.1 SAFETY TRAINING -----	1-1
1.1.2 IDENTIFICATION OF “DANGER”, “WARNING”, “CAUTION” AND “NOTE” -----	1-1
1.2 “WARNING” LABEL AND “CAUTION” LABEL -----	1-3
1.2.1 THE POSITION OF ATTACHED “WARNING” LABEL AND “CAUTION” LABEL -----	1-3
1.3 PRECAUTIONS FOR RUNNING -----	1-4
1.3.1 FOR SAFETY -----	1-4
1.3.2 SAFETY INTERLOCK -----	1-5
2 CAUTION ON INSTALLATION -----	2-1
2.1 ENVIRONMENT -----	2-1
2.2 INSTALLATION -----	2-2
2.3 MOUNTING -----	2-3
2.4 PIPING -----	2-4
2.5 QUALITY OF RADIATING WATER -----	2-4
3 UNIT OVERVIEW -----	3-1
3.1 METHOD OF DISPLAYING MODEL -----	3-1
3.2 MANUFACTURING YEARS METHOD OF DISPLAY -----	3-1
3.3 MODEL No. LABEL -----	3-2
3.4 APPEARANCE -----	3-3
3.5 OPERATING PRINCIPLES -----	3-4
3.5.1 CONSTRUCTION AND PRINCIPLE OF THERMOELECTRIC MODULE -----	3-4
3.5.2 CONSTRUCTION OF TEMPERATURE CONTROLLING DEVICE -----	3-5
3.5.3 ELECTRICAL DIAGRAM -----	3-6
3.6 FUNCTIONS -----	3-7
3.6.1 AUTO TUNING -----	3-7
3.6.2 OFFSET FUNCTION -----	3-7

3.6.3 LEARNING CONTROL FUNCTION-----	3-7
3.6.4 EXTERNAL TUNE CONTROL FUNCTION-----	3-7
3.6.5 TEMPERATURE SENSOR FINE CONTROL FUNCTION-----	3-7
3.6.6 SETTING VALUE MEMORY FUNCTION-----	3-8
(FUNCTION THAT BACKS UP WITH EEPROM)-----	3-8
3.6.7 SERIAL COMMUNICATION FUNCTION-----	3-8
3.6.8 UPPER/ LOWER TEMPERATURE LIMIT ALARM FUNCTION-----	3-8
3.6.9 WARNING OF OUTPUT INTERRUPTION-----	3-8
4 NAMES AND FUNCTIONS OF COMPONENTS-----	4-1
4.1 DESCRIPTION OF PARTS-----	4-1
4.2 OPERATION PANEL-----	4-2
4.3 DISPLAY-----	4-3
4.4 RESERVOIR CAP-----	4-3
5 SPECIFICATIONS-----	5-1
5.1 SPECIFICATIONS OF HEC001-----	5-1
TABLE5-1 SPECIFICATIONS OF HEC001-----	5-1
5.2 SPECIFICATIONS OF HEC003-----	5-2
TABLE5-2 SPECIFICATIONS OF HEC003-----	5-2
5.3 PERFORMANCE CHART-----	5-3
5.3.1 PERFORMANCE OF HEC001-----	5-3
1) COOLING CAPACITY-----	5-3
2) HEATING CAPACITY-----	5-3
3) PRESSURE LOSS OF RADIATING WATER-----	5-3
5.3.2 PERFORMANCE OF HEC003-----	5-3
1) COOLING CAPACITY-----	5-3
2) HEATING CAPACITY-----	5-3
3) PRESSURE LOSS OF RADIATING WATER-----	5-3
5.3.3 PERFORMANCE OF PUMP CAPACITY-----	5-3

1) PUMP CAPACITY(COMMON TO HEC001 AND 003)	5-3
6 PREPARATION FOR OPERATION	6-3
6.1 PIPING	6-3
6.1.1 PREPARATION FOR RADIATING WATER	6-3
6.1.2 PREPARATION FOR RECIRCULATING FLUID	6-3
6.2 WIRING	6-3
6.2.1 POWER SUPPLY	6-3
6.2.2 CIRCUIT BREAKER	6-3
6.2.3 GROUNDING	6-3
6.2.4 AVOIDANCE OF PARALLEL WIRING	6-3
6.2.5 CONNECTION OF VARIOUS CONNECTORS AND POWER SUPPLY CABLE	6-3
6.3 CHECK• REPAIR	6-3
6.3.1 DAILY CHECK	6-3
6.3.2 CHECK AFTER SEISMIC VIBRATION AND IMPACT	6-3
6.3.3 REPAIR AND MAINTENANCE	6-3
6.3.4 ABANDONMENT	6-3
7 OPERATION	7-3
7.1 START OF OPERATION	7-3
7.1.1 CONFIRMATION BEFORE OPERATION	7-3
7.1.2 SETTING OF VALUES	7-3
7.1.3 CAUTIONS FOR OPERATION CONTROL	7-3
7.2 HOW TO OPERATE	7-3
7.3 SETTING MODE, LEVEL 1	7-3
7.3.1 HOW TO ENTER AND RETURN	7-3
7.3.2 AVAILABLE MODE IN LEVEL 1	7-3
7.4 SETTING MODE, LEVEL 2	7-3
7.4.1 HOW TO ENTER AND RETURN	7-3
7.4.2 AVAILABLE MODE IN LEVEL 2	7-3

7.5 SETTING MODE, LEVEL 3	7-3
7.5.1 HOW TO ENTER AND RETURN	7-3
7.5.2 AVAILABLE MODE IN LEVEL 3	7-3
7.6 DETAIL OF SETTING MODE LEVEL	7-3
7.6.1 SETTING MODE, LEVEL 1	7-3
7.6.2 SETTING MODE, LEVEL 2	7-3
7.6.3 SETTING MODE, LEVEL 3	7-3
7.6.4 POWER SUPPLY OFF	7-3
8 ALARM	8-3
8.1 HOW TO IDENTIFY ALARM	8-3
8.2 ALARM INDICATION	8-3
8.3 HOW TO RESET ALARM	8-3
8.4 ALARM CODE LIST	8-3
8.5 TROUBLESHOOTING	8-3
9 APPENDIX	9-3
9.1 SIGNAL AND STYLE OF CONNECTORS	9-3
9.2 POWER SUPPLY CABLE	9-3
9.3 CALCULATION OF DEW POINT (FROM PSYCHROMETRIC CHART)	9-3
9.4 APPLICABLE STANDARD/REGULATION	9-3
9.4.1 OVERSEAS STANDARD	9-3
9.4.2 WHEN THE PRODUCT IS EXPORTED,	9-3

Figure List

Abbreviations

Abbreviation (The order of ABC)	Meaning
AC	Alternating Current
AT	Auto Tuning
DC	Direct Current
EPDM	Ethylene Propylene Diene Monomer
ERR	Error
IEC	International Electrotechnical Commission
LCD	Liquid Crystal Display
PE (Electricity)	Protective Earth
PE (Material)	Polyethylene
PID	Proportional, Integral, Differentiate
PPS	Polyphenylene Sulfide
PV	Process Value
RET	Return
RD	Received Data
SEL	Select
SER (No.)	Serial (No.)
SG	Signal Ground
SUS	Special Use Stainless steel
SV	Setting Value
Temp.	Temperature
TD	Transmitted Data
WRN	Warning

*GALDEN and FluorinertTM are a trade mark of Solvay Solexis Inc. and 3M respectively.

*The and TM symbols indicating trade marks have been omitted from the text.

1 Safety Instructions

1.1 Before using the Thermo-con

This chapter is dedicated for safety during interaction with the product.

The product is operated at high voltage.

Therefore, not only those who operate the unit, but those who are in charge of service and who work nearby the product should read carefully and thoroughly understand descriptions related to safety in this manual before starting the work.

1.1.1 Safety training

This manual is not a general manual for safety and hygiene education that safety and hygiene tutors are supposed to conduct.

Anyone working with or near the product should be fully trained in recognition of the danger inherent to the product and the related safety countermeasures.

A manager is responsible for strict compliance to the safety standard in whole system, but individual person in charge of operation and maintenance should take responsibility for the daily work and should consider the safety of the working location and environment.

Operators and maintenance personnel responsible should ensure the safety of workshops and their environment before starting work.

Training concerning the product should take place after the sufficient training on safety. The training must not be carried without consideration to safety.

1.1.2 Identification of “Danger”, “Warning”, “Caution” and “Note”

The notifications given in this operation manual aim to assure the safe and correct operation of the product to prevent injury of operators or damage to the product. The notifications are grouped into four categories, “Danger”, “Warning”, “Caution”, and “Note”, which indicate the severity of the hazard and damage and also the degree of emergency. All notifications contain critical matter on safety, so they shall be carefully observed.

DANGER, WARNING, CAUTION and NOTE signs are in order according to severity (DANGER> WARNING> CAUTION> NOTE).

Table1-1 Division of DANGER, WARNING, CAUTION, and NOTE







 <p>DANGER</p>	<p>DANGER indicates a hazard with a high level of risk which, if not avoided, will result in death or serious injury.</p>
 <p>WARNING</p>	<p>WARNING indicates a hazard with a medium level of risk which, if not avoided, could result in death or serious injury.</p>
 <p>CAUTION</p>	<p>CAUTION indicates a hazard with a low level of risk which, if not avoided, could result in minor or moderate injury.</p>
<p>NOTE</p>	<p>These paragraphs highlight knowledges which is recommended to be known to avoid mistakes that likely to happen during operation. Also anything that might damage the unit or performance of product for checking is described.</p>

Table1-2 Meaning of symbols

Symbol	Meaning
	<p>Attention, consult accompanying documents</p>
	<p>Caution, risk of electric shock</p>
	<p>Caution, handling of heavy object may affect human body. It should be handled by two or more workers.</p>

1.2 “Warning” label and “Caution” label

This product is provided with “Warning” labels and “Caution” labels to inform the operator of hazards related to the product. Check the contents and position of all labels before starting the work.

⚠WARNING

**Read all warning and caution labels carefully and keep them in mind.
Do not peel off or rub warning and caution labels.
Confirm locations of any warning and caution labels.**

1.2.1 The position of attached “Warning” label and “Caution” label

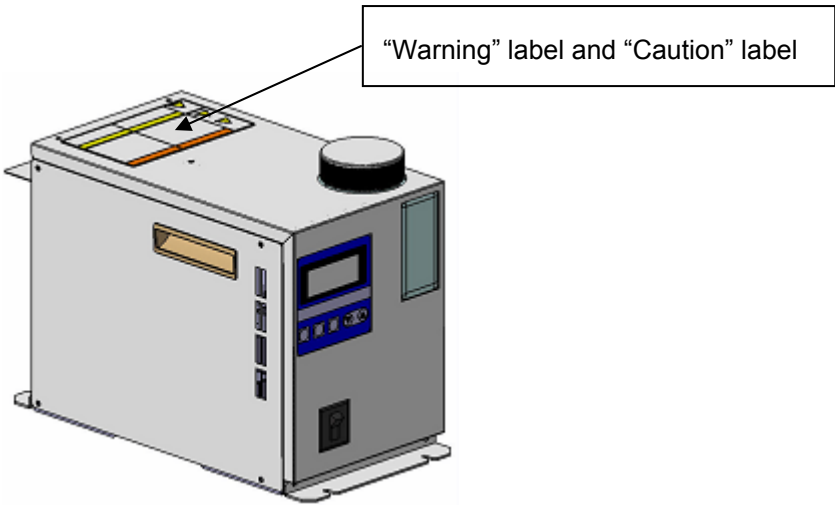

Fig. 1-1 position of label



Fig. 1-2 Detail of “Warning” label and “Caution” label

1.3 Precautions for running

1.3.1 For safety

⚠ WARNING

The product shall be handled only by trained personnel only. Transportation, installation and maintenance including dangerous work shall be done by persons who have full knowledge and experience on the product and the system. Cover panels of the product shall be opened only by qualified service technicians or qualified personnel.

⚠ WARNING

Do not disassemble or retrofit the product.

⚠ WARNING

If any chemicals are added to the recirculating fluid, such as algaecides be sure to read the MSDS for that fluid to understand a protection gear and first-aid action before operation.

⚠ WARNING

If abnormal conditions, such as abnormal noise or smoke, or water leakage appeared, take the following actions:

- Shut down power.
 - Stop water radiating water supply
 - Contact an authorised SMC dealer for repair
-

⚠ CAUTION

Please do not use devices that generate electromagnetic radiation such as cellular phones near the product. There is a possibility that the product malfunctions.

1.3.2 Safety Interlock

This is a function to protect personnel, to restrict operation, that may cause damage to the product or facility, and to remove dangers related to safety.

This unit has several interlock functions, which activate when dangerous operation or condition occurs to stop operation and make it safe.

▲DANGER

During operation or maintenance of the product, do not disable the interlock function of any device. Otherwise unexpected personnel injury or damage to the product may occur.

▲DANGER

When turning on/off the power observe the procedure. Otherwise unexpected malfunction or danger may occur.

When maintaining, cleaning or in case of emergency, turn off the power source.

After identifying a problem be sure to check the cause and take necessary countermeasures before turning on the power.

Table1-3 Safety interlock list (Part 1)

No.	Description	Part	Cause
1	Overheat in Heat Exchanger	Thermostat	Detects abnormal heat in heat exchanger.
2	Switching power supply failure	Internal circuit	Detects abnormal current, voltage, temperature or fan failure.
3(Note)	Low recirculating fluid level	Level sensor	Detects low level of recirculating fluid in the reservoir.
4	Detection of breakage of temp. sensor	Controller internal circuit	Detects breakage and short circuit of temp. sensor and cables.
5	Excessive temp. increase	Controller internal circuit	Detects temp. input value not less than 70 °C.
6	Excessive temp. decrease	Controller internal circuit	Detects temp. input value not more than 0 °C.
7	Abnormal output (Overload)	Controller internal circuit	Works when temp. change is smaller than over load detection temp.(selected between 0.1 to 9.9 °C) even if 100% output continues during overload detection time (selected between 0 to 99min.) When 0 is set, the alarm doesn't arise.
8(Note)	Low recirculating fluid flow	Flow switch	Alarm alerts when the flow rate of the recirculating liquid is decreased.

Table1-4 Safety interlock list (Part 2)

No.	Description	Condition of unit	Indication	How to reset
1	Overheat in Heat Exchanger	Shuts off power supply to the Heat exchanger, Pump.	Error indication on display. (ERR14)	Restart power supply
2	Switching power supply failure	Shuts off power supply to the Heat exchanger, Pump.	Error indication on display. (ERR11)	Restart power supply
3(Note)	Low recirculating fluid level	Shuts off power supply to the Heat exchanger, Pump.	Error indication on display. (ERR20)	Restart power supply
4	Detection of breakage of temp. sensor	Shuts off power supply to the Heat exchanger, Pump.	Error indication on display. (ERR17)	Restart power supply
5	Excessive temp. increase	Shuts off power supply to the Heat exchanger, Pump.	Error indication on display. (ERR12)	Restart power supply
6	Excessive temp. decrease	Shuts off power supply to the Heat exchanger, Pump.	Error indication on display (ERR13)	Restart power supply
7	Abnormal output (Overload)	The unit continues to operate.	Error indication on display (ERR15)	Restart power supply
8	Breakage of external temp. sensor	The unit continues to operate by normal control mode.	Error indication on display (ERR18)	Restart power supply
9(Note)	Low recirculating fluid flow	Shuts off power supply to the Heat exchanger, Pump	Error indication on display. (ERR16)	Restart power supply

Note) Here becomes the content of the option.

2 Caution on Installation

▲WARNING

Pay special attention to the safety of all personnel when installing and transporting the product.

▲CAUTION

The product is heavy, be careful when installing or moving the product.

▲CAUTION

Only trained personnel can perform work such as installation, transportation and maintenance of the product.

2.1 Environment

The product shall be installed in an environment that meets the following requirements:

- 1) Where the product is not exposed to water, oil or any chemical spills.
- 2) Where the product is installed horizontally in a stable position
- 3) Where the product is not exposed to corrosive or flammable gas. (The unit is not explosion proof.)
- 4) Where the ambient temperature range is between 10 to 35°C and the relative humidity range is between 35 to 80%. No dew condensation is allowed on the unit. Information about dew condensation is shown on “9.3 Calculation of Dew Point”.
- 5) Where the product is not exposed to noise sources (such as discharging equipment, large relay and thyristor).
- 6) Where there is enough space between power supply cable and communication cable of the product and power cables of other equipments.
- 7) Where the product is not exposed to strong electrical or magnetic emissions.
- 8) Where the power supply and ground connections can be made correctly.
- 9) Where the product is not exposed to materials such as silicone, which may generate harmful gas.
- 10) Where the product is not outdoors or in a place with the direct sunshine or heat radiation.
- 11) Where the product is at an altitude of more than 2000 meters.

2.2 Installation

- Fluid leakage from the thermo-con can affect peripheral equipment. Install a drain pan at the bottom of the place where the thermo-con is installed to catch the fluid leakage and prevent this problem.
Also, provide a way of detecting fluid leakage, such as a leak sensor, with the drain pan so that an alarm will be generated in the case of leakage.
- It is not necessary to reserve a space for ventilation specifically. Set up the thermo-con with sufficient space for moving it in and out for installation and maintenance. Bear in mind that there should be enough ventilation to prevent the ambient temperature from increasing.

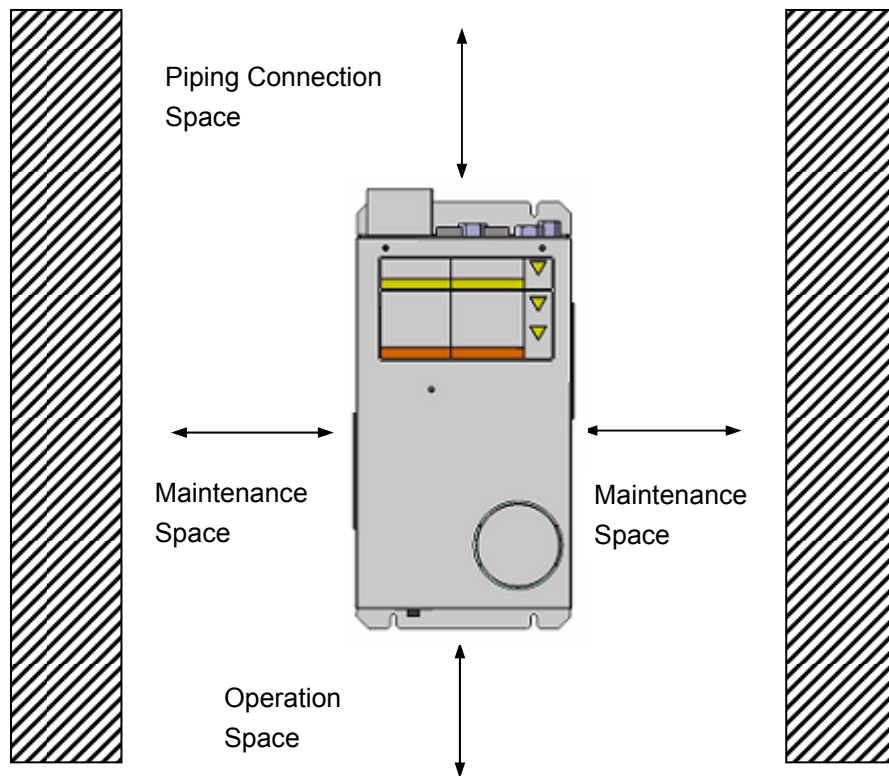

Fig. 2-1 Installation environment

2.3 Mounting

The product should be mounted as follows.

- 1) A fixing foot is prepared for the Thermo-con (accessory). Mount it on the Thermo-con body before use.
 Remove the 2pcs of screws on the front and back of the Thermo-con respectively, and mount the attached foot.
 Tighten those screws with the torque of 1.5Nm when installing it on the Thermo-con body.

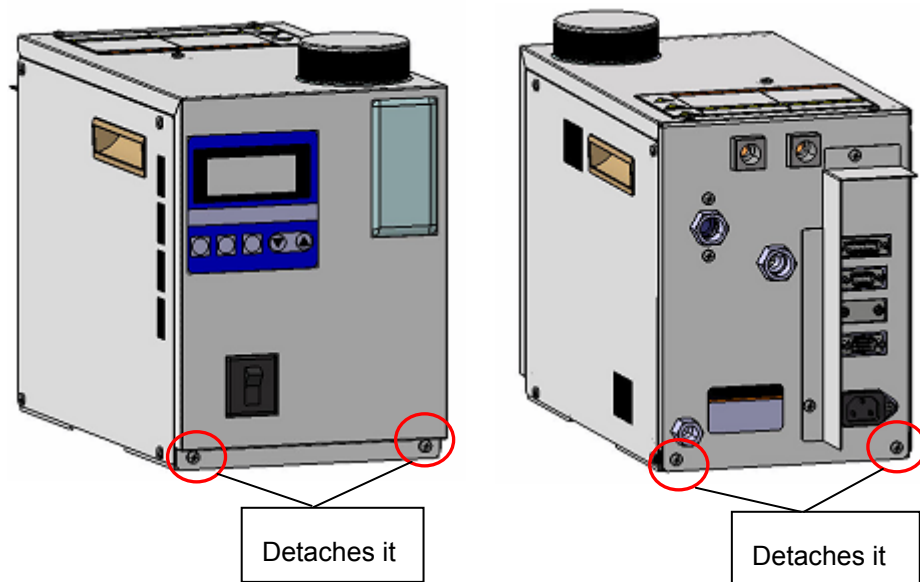

Fig. 2-2 Foot mounting screws

- 2) Then tighten M4 screws (bolts) or equivalent into 4 holes sized to 5mm on the parts marked with arrow for mounting.

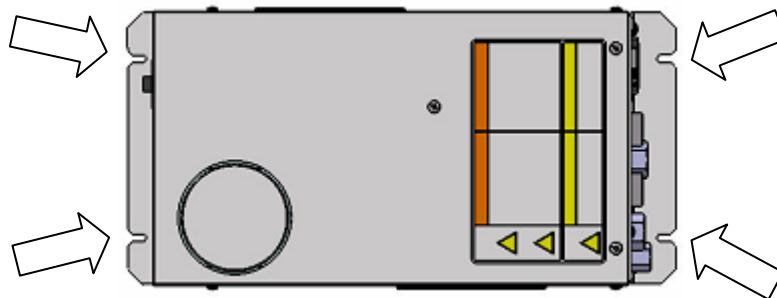

Fig2-3 Mounting

▲ CAUTION

Be sure to correctly tighten all screws the required torque.

2.4 Piping

- 1) Ensure the flow rate of the recirculating fluid is as high as possible to maintain the temperature stability. Therefore, the length of the external piping should be minimized and internal diameter should be as large as possible. Piping must have sufficient strength for the maximum discharge pressure of the recirculating circuit.
- 2) Likewise, if a tube is bent or multiple elbow fittings are used, the piping resistance will increase and the flow rate will decrease. If the flow rate falls below 2L/min, the temperature stability will decrease.
- 3) If installing a tank externally, only a sealed tank should be used. Do not use an open tank.

▲ CAUTION

Ensure that the INLET and OUTLET for recirculating and radiating water are connected correctly. If any valves are used ensure that they do not restrict the flow, otherwise low flow may cause an alarm.

2.5 Quality of Radiating Water

▲ CAUTION

Use water that satisfies the quality standards shown below for radiating water. If other liquids are used, the product could be damaged and leak fluid, resulting in electrical shock or earth leakage.

Table 2-1 Quality standard for fresh water (tap water)

	Item	Standard value
Quality item	pH (25°C)	6.5 to 8.2
	Electric conductivity (25°C) (μS/cm)	100 to 800
	Chloride ion (mgCl-/L)	200 or less
	Sulphate ion (mgSO ₄ ²⁻ /L)	200 or less
	Acid consumption (pH4.8) (mgCaCO ₃ /L)	100 or less
	Total hardness (mgCaCO ₃ /L)	200 or less
	Calcium hardness (mgCaCO ₃ /L)	150 or less
	Ion silica (mgSiO ₂ /L)	50 or less
	Iron (mgFe/L)	1.0 or less
	Copper (mgCu/L)	0.3 or less
	Sulphide ion (mgS ²⁻ /L)	None detected
	Ammonium ion (mgNH ₄ ⁺ /L)	1.0 or less
	Residual chlorine (mgCl/L)	0.3 or less
	Free carbon (mgCO ₂ /L)	4.0 or less

3 Unit overview

3.1 Method of displaying model

H E C 00* - W 5 * - ***

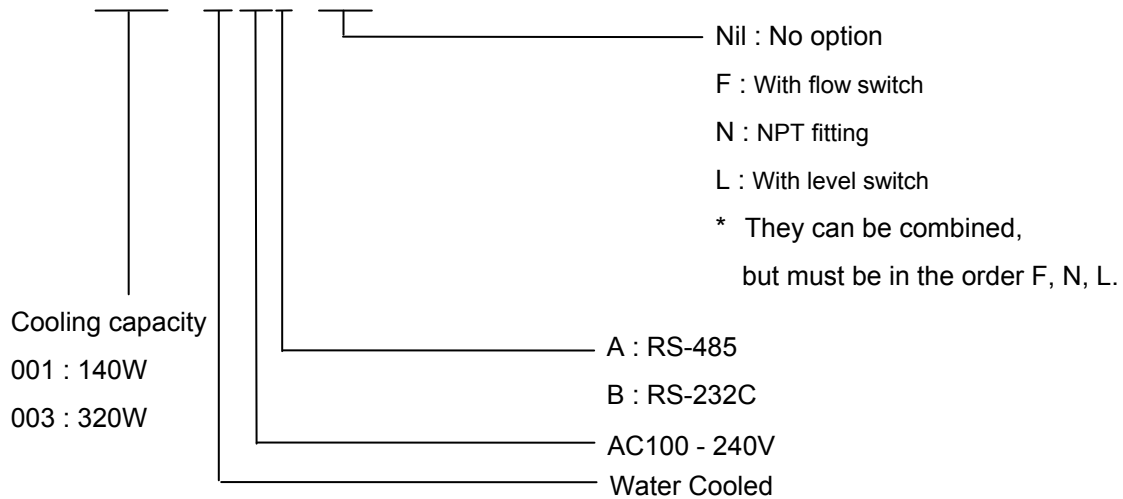

3.2 Manufacturing years method of display

SERIAL No. M Q - 0001

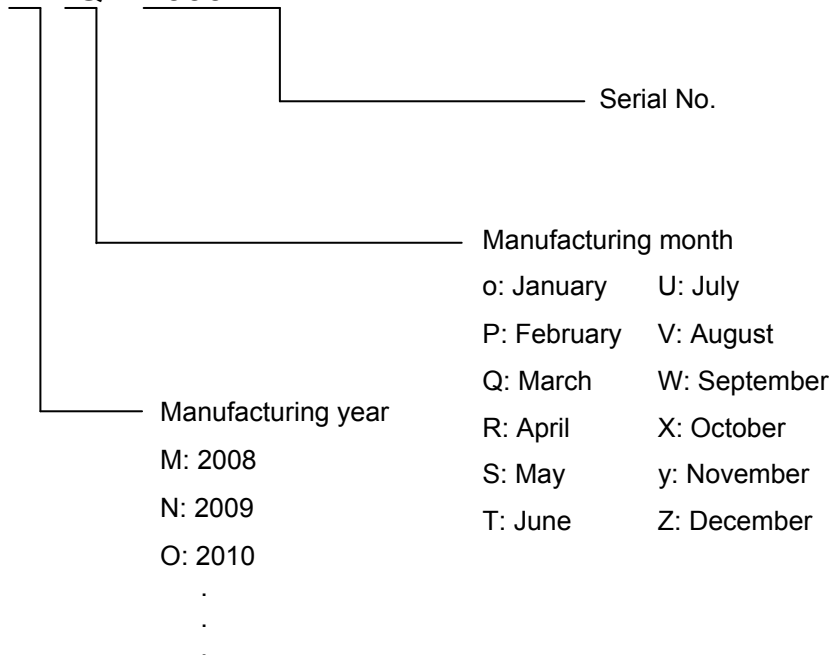

3.3 Model No. label

A model No. label is attached to the unit in the position shown below.

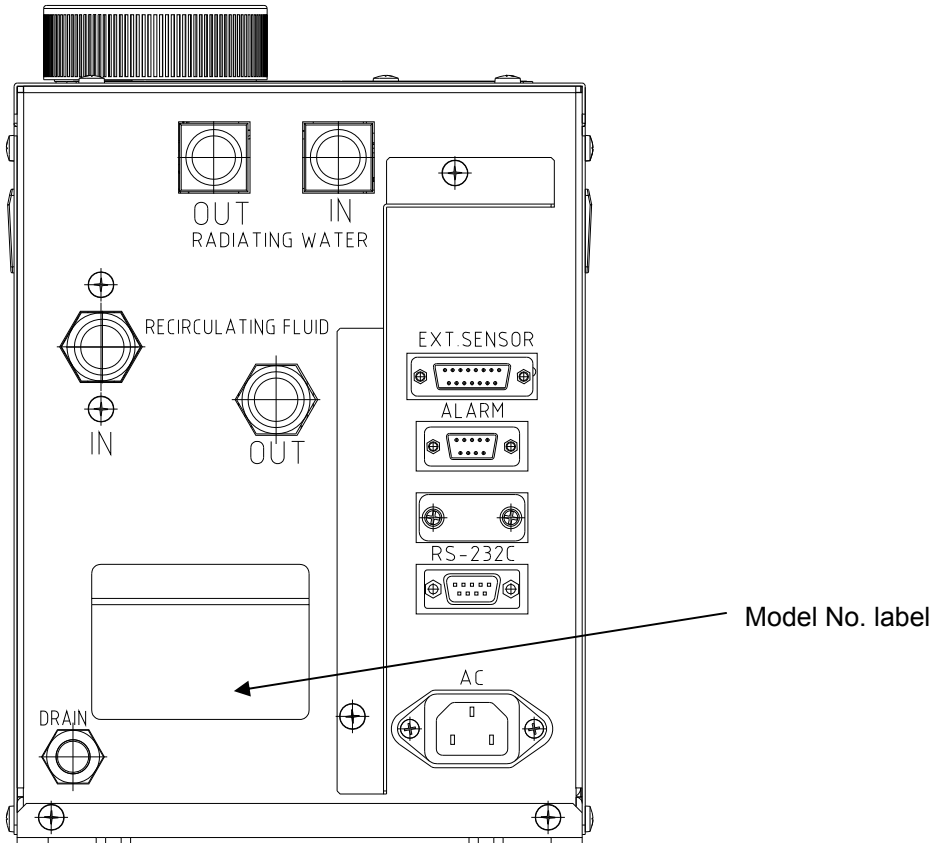

Fig.3-1 Position of Model No. label

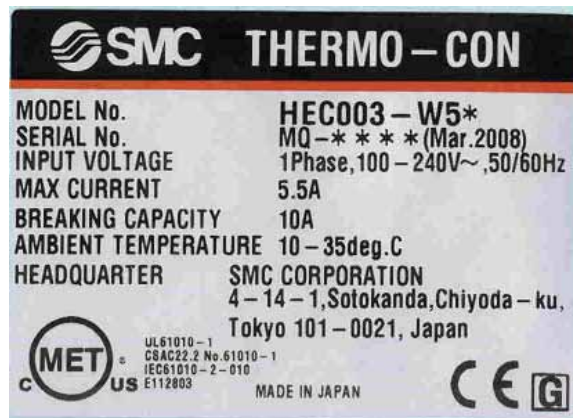

Fig.3-2 Legend of Model No. label

3.4 Appearance

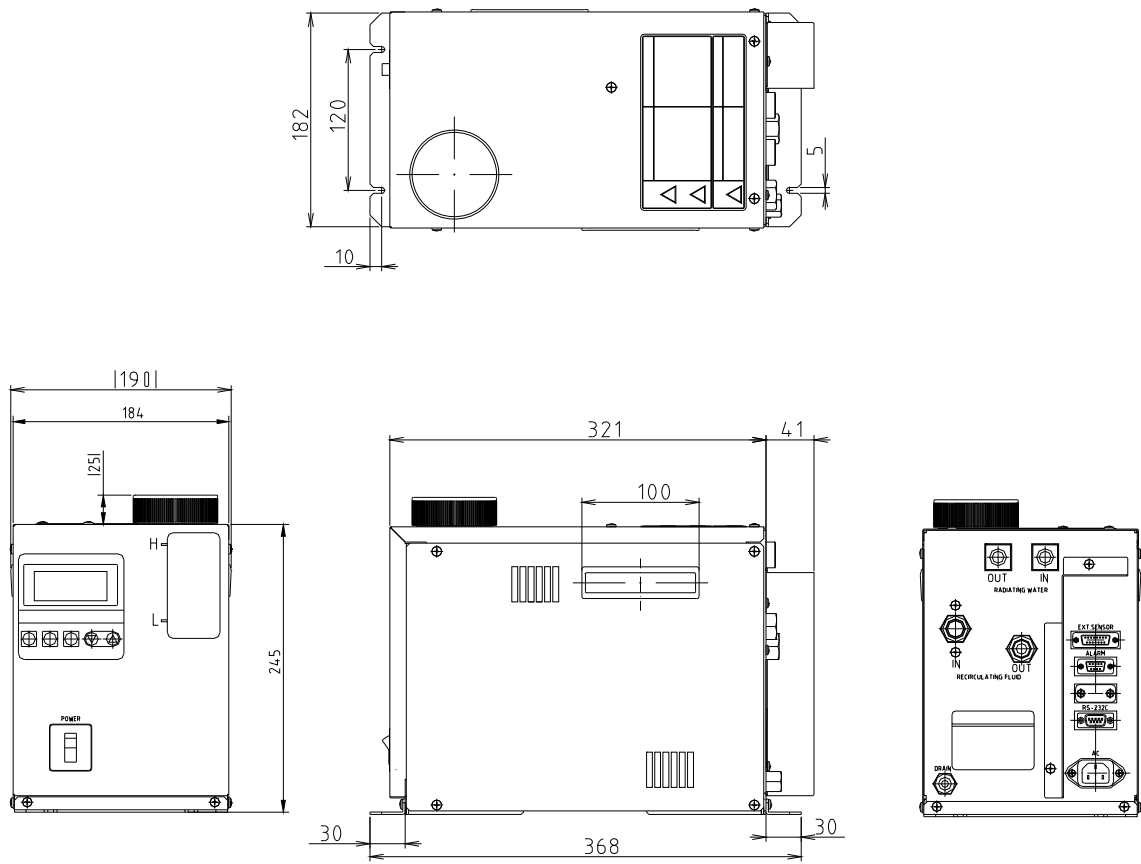

Fig.3-3 Outside drawings of HEC

3.5 Operating Principles

The operating principle of the product is explained below

3.5.1 Construction and Principle of Thermoelectric Module

The product controls the temperature of the recirculating fluid using thermoelectric modules (Peltier Modules).

A thermoelectric module (electronic cooling and heating element) is a device consisting of multiple semiconductor elements. It can perform cooling and heating using direct electric current, by placing the elements in series for electric purposes and in parallel for thermal purposes.

When two different electric conductors or semiconductors elements are connected in an electrical circuit and direct current is passing through them, thermal energy absorption or generation of the Joule effect is seen at the connecting metal junctions. This is called Peltier effect. If P-type and N-type semiconductor elements are connected in an electrical circuit using metal connections, as shown in the figure below, and direct current is passed through this circuit, heat absorption and radiation is seen at the connecting metal junctions. This effect is reversible. Heat absorption and radiation occurs in the opposite direction when the current direction is reversed. Therefore, if the heat at the high temperature side is handled efficiently, a continuous heat pumping from low temperature side to high temperature side can be realized. With this principle, the N-type semiconductor has an electron stream flowing in the opposite direction to the current and the P-type semiconductor has a “hole” stream flowing in the same direction as the current. These electron and “hole” streams move heat from one surface to another.

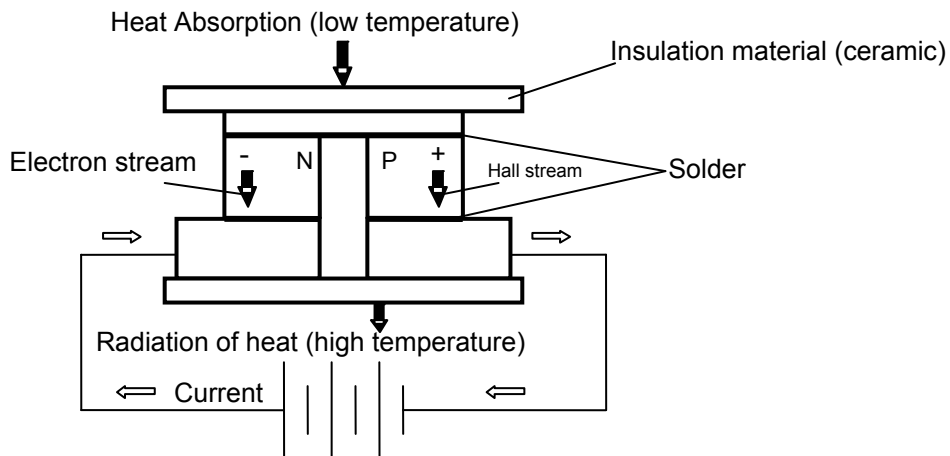

Fig. 3-4 Construction and principle of thermoelectric module

3.5.2 Construction of temperature controlling device

Several thermoelectric modules are installed in a heat exchanger.

Radiating water flows on one side of the thermoelectric module, and recirculating fluid flows on the other side of the thermoelectric module.

DC output transmitted from a switching power supply is connected to the thermoelectric module, and a controller controls the DC output from the switching power supply. This control is based on the signal sent from the temperature sensor that is mounted on the outlet of the heat exchanger, achieving an accurate temperature control of the recirculating fluid.

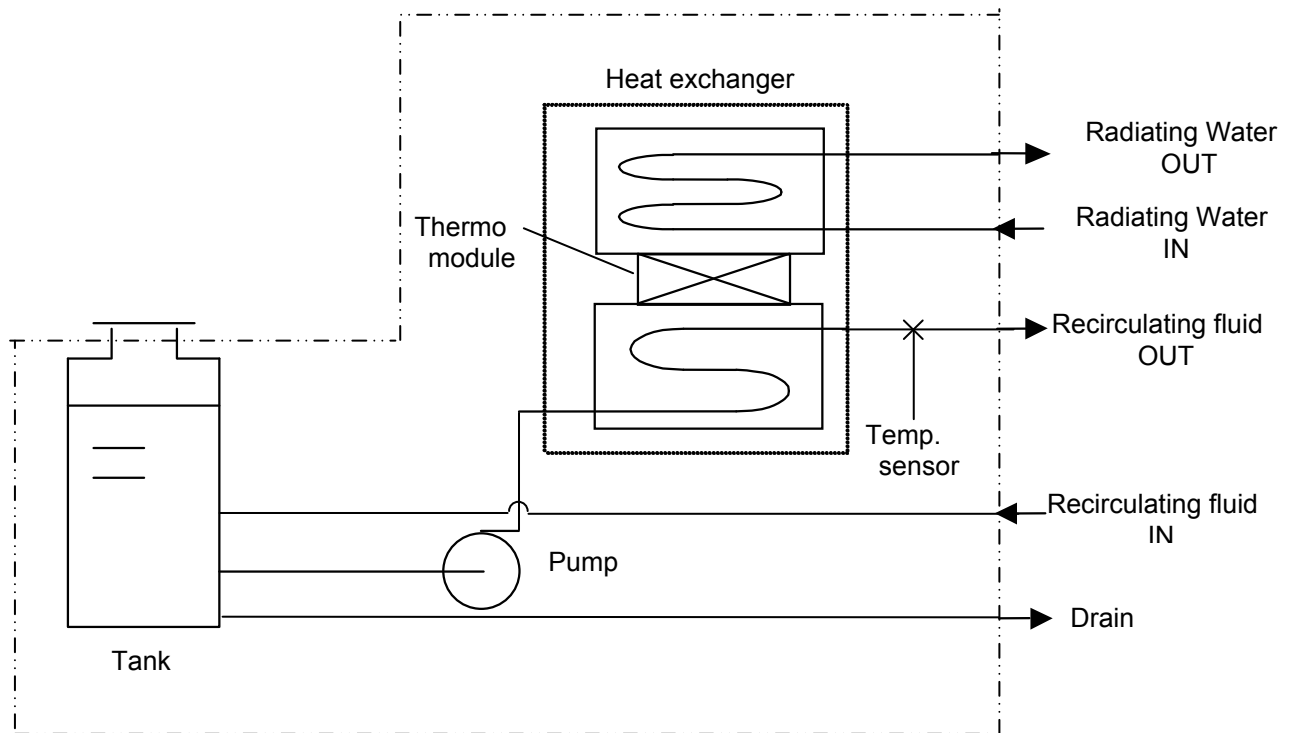

Fig. 3-5 Recirculating fluid and Radiating water circuit

3.5.3 Electrical diagram

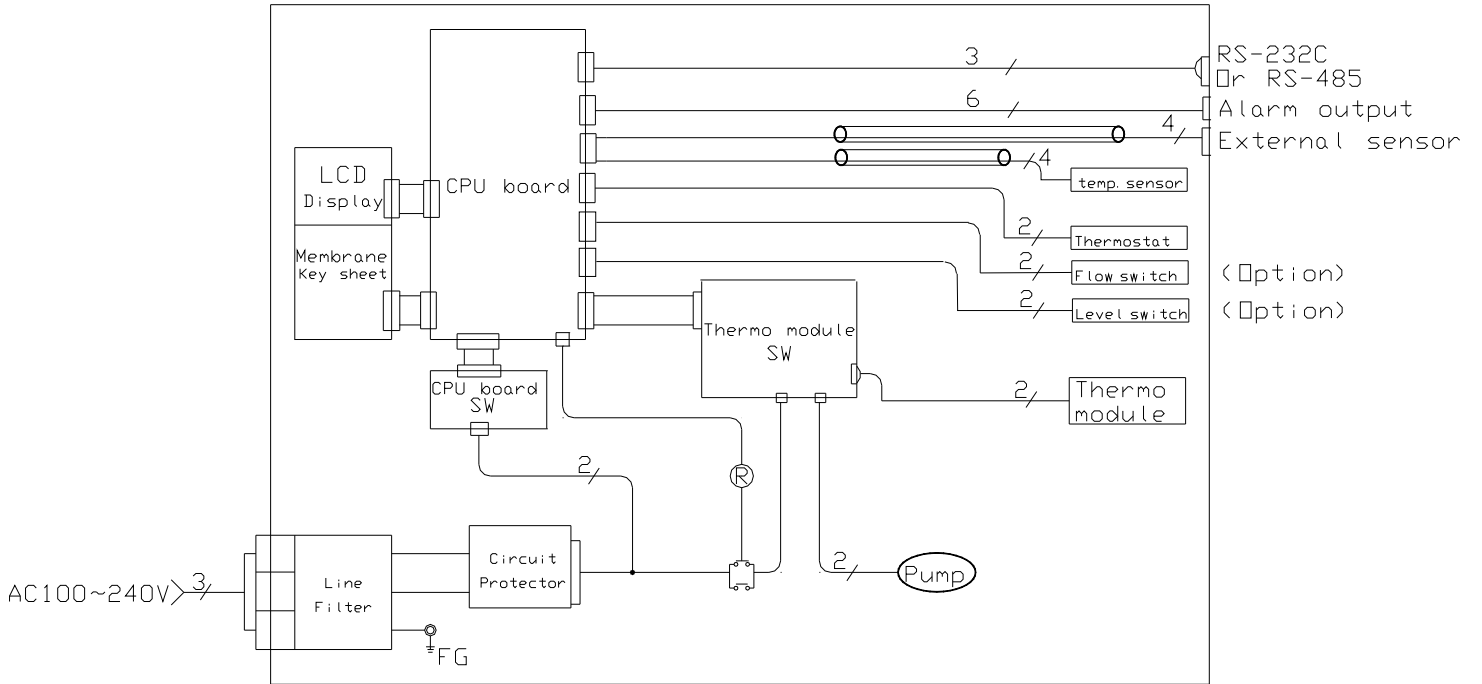

Fig.3-6 Electrical diagram

3.6 Functions

3.6.1 Auto tuning

This function sets the values necessary for the control system such as PID (proportional band, integral time, derivative time and ratio of cooling/ heating gain) automatically.

*Depending on piping and other conditions, sometimes auto tuning cannot be controlled properly even if it is finished correctly.

e.g.>> The target temperature is not achieved. Hunting occurs.

In that case, return to the default value or set PID constants manually referring to the following table.

Table 3-1 Setting of PID

No.	Problem	Setting
1	It is far from the target temperature	(1) Check the Heating/Cooling Ratio is 50 or more. If it is less than 50, correct it to 50 or more.
		(2) If the value of PB range and I Constant is too large, it takes a long time to achieve the target temperature.
2	Hunting (temperature fluctuation) occurs.	(1) The value of PB range might be too small. Increase PB range. At that time, ARW Range should be approx. 1.1 times as PB Range.
		(2) The value of I Constant might be too small. Increase I Constant.

3.6.2 Offset function

This function controls the temperature slide by an offset value from set point temperature. The range of offset is -9.99 to 9.99 °C. When the recirculating fluid is carried to the target object, a certain deviation occurs between the temperature before the object and the setting temperature of the product due to the influence of ambient temperature on the piping. In this case, if the deviation is input as the offset value, the temperature of recirculating fluid just before the object can match with setting value.

Internal sensor value for alarm does not include the offset value.

3.6.3 Learning control function

This function lets the product measure the temperature of recirculating fluid flowing before temperature target object by an external temperature sensor and adjusts the offset function automatically to the set value at a certain sampling interval. The external temperature sensor needs to be prepared separately by the customer.

3.6.4 External tune control function

This function makes the temperature of recirculating fluid consistent to the external (ambient) temperature all the times. This function lets the product measure the temperature from a temperature sensor mounted in the customer preferred location, then it adjusts the temperature of the fluid automatically to the temperature detected by the sensor. The separate temperature sensor needs to be prepared separately by the customer.

3.6.5 Temperature sensor fine control function

This is a function to finely control the measurement temperature of the control sensor within the range of -9.99 to 9.99 °C separate from offset function. Control sensor can be corrected by inputting difference (calibration value) between temperature of standard and that of control sensor.

Internal sensor value for alarm includes the fine control value.

Internal sensor value for alarm = Internal sensor value – Fine control value

3.6.6 Setting value memory function

(Function that backs up with EEPROM)

This function backs up all the manually set values to nonvolatile memory (EEPROM). Even if the power is turned off the set values are saved and will be restored at power on.

3.6.7 Serial Communication Function

This function allows the product to communicate with a host computer or your system by serial communication that conforms to the standards of RS-485 and RS-232C.

Communication is possible with the cable length of 500m for RS-485 and 15m for RS 232C. Communication allows a host computer to set and monitor operating conditions of up to 16 products (with RS-485).

The communications function allows the following actions:

- Read and change the set point temperature
- Read the control sensor value
- Read the alarm status
- Read and set the offset value

In cases when using communication, a separate “Communication Specifications” is available for more details.

3.6.8 Upper/ Lower Temperature Limit Alarm Function

This function raises an alarm when temperature of the recirculating fluid is out of allowable upper and lower range. When the alarm is raised, WRN is indicated on LCD. If recirculating fluid temperature returns to within allowable upper/ lower range, this alarm is automatically canceled. The allowable upper and lower range of temperature can be set between 0.1 and 10 °C.

3.6.9 Warning of output interruption

This function raises alarm and stop operation safely when a critical error detected (However, operation continues in case of **ERR** 15 and **ERR** 18.). When a alarm is detected, the display shows **ERR** and a alarm number. At the same time, the alarm is transmitted to alarm output connector with volt-free contact. This warning cannot be removed unless the power is turned off once and supplied again.

4 Names and Functions of Components

4.1 Description of Parts

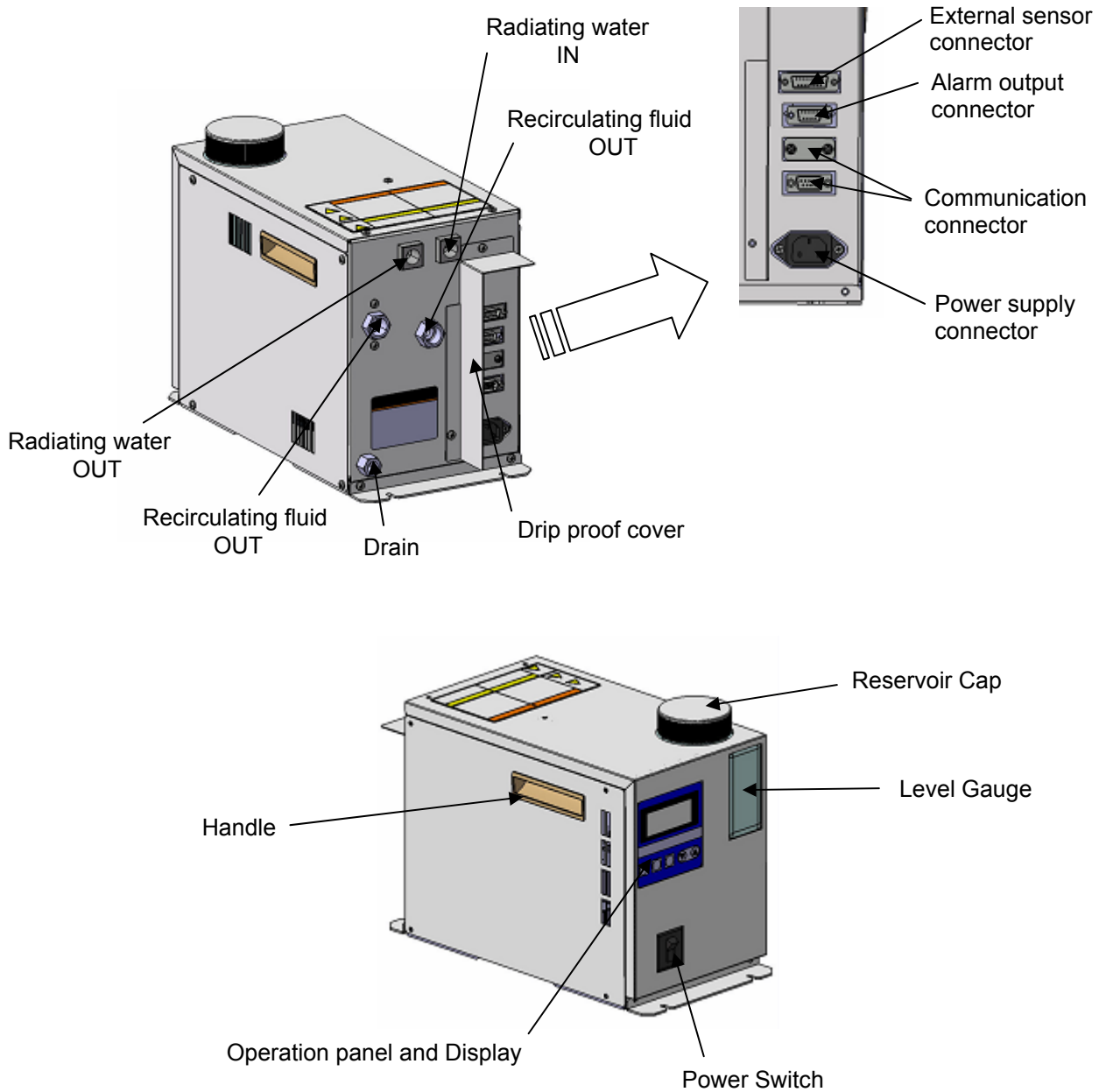

Fig.4-1 Components of HEC

Table 4-1 Function of Components

Description	Function
Operation panel and display	Various displays are shown and settings are input.
Power Switch (circuit protector)	Turns the power supply of the product on and off.
Level gauge	It displays liquid level of the internal tank.
Reservoir cap	This is a screwed type cap. Remove it when supplying the water
Radiating water IN	Radiating water inlet port. Port Size -----Rc3/8
Radiating water OUT	Radiating water outlet port. It is the same size as the inlet port.
Recirculating fluid IN	Recirculating water inlet port. Port Size -----Rc3/8
Recirculating fluid OUT	Recirculating water outlet port. It is the same size as the inlet port.
Drain	This is an exhaust port of the tank. Port Size -----Rc1/4
Power supply connector (AC)	Connector for the single phase AC (AC100 to 240V) power supply. A power supply cable is connected here.
External sensor connector (EXT.SENSOR)	To use learning control function, an external sensor must be connected.
Alarm output connector (ALARM)	Connector for the upper/lower temperature limit alarm and output cut-off alarm. A relay contact is open or close when these alarms are output.
Communication connector	Connector for communication with RS-485 and RS-232C.
Drip proof cover	This is a cover to prevent the radiating water and recirculating fluid dripping over the electrical connections. It can be removed.

4.2 Operation panel



Fig.4-2 Operation panel

4.3 Display

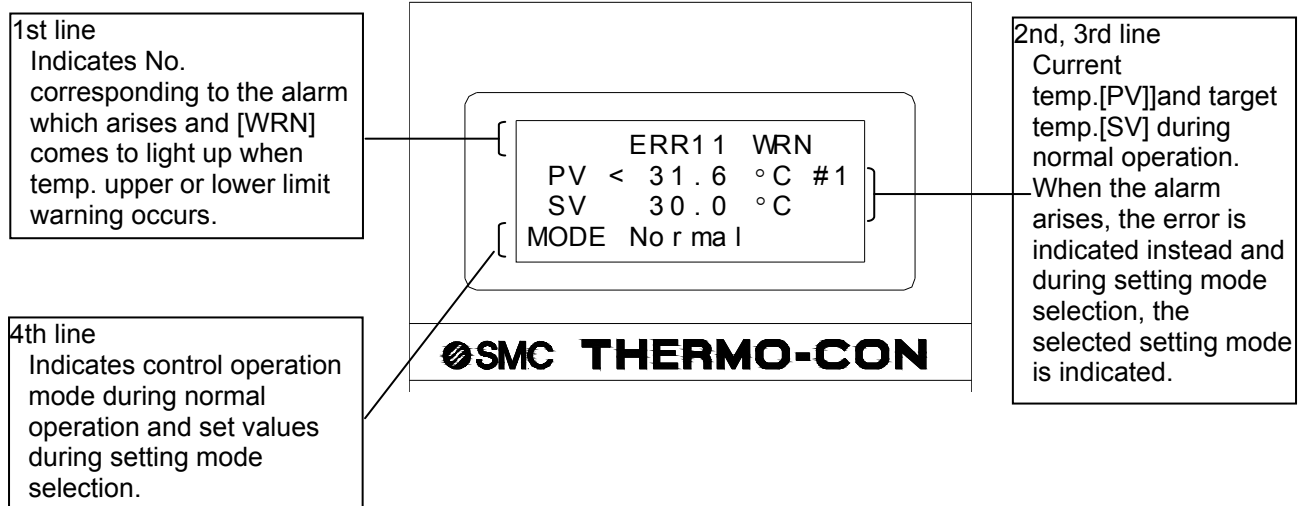

Fig.4-3 Display

4.4 Reservoir Cap

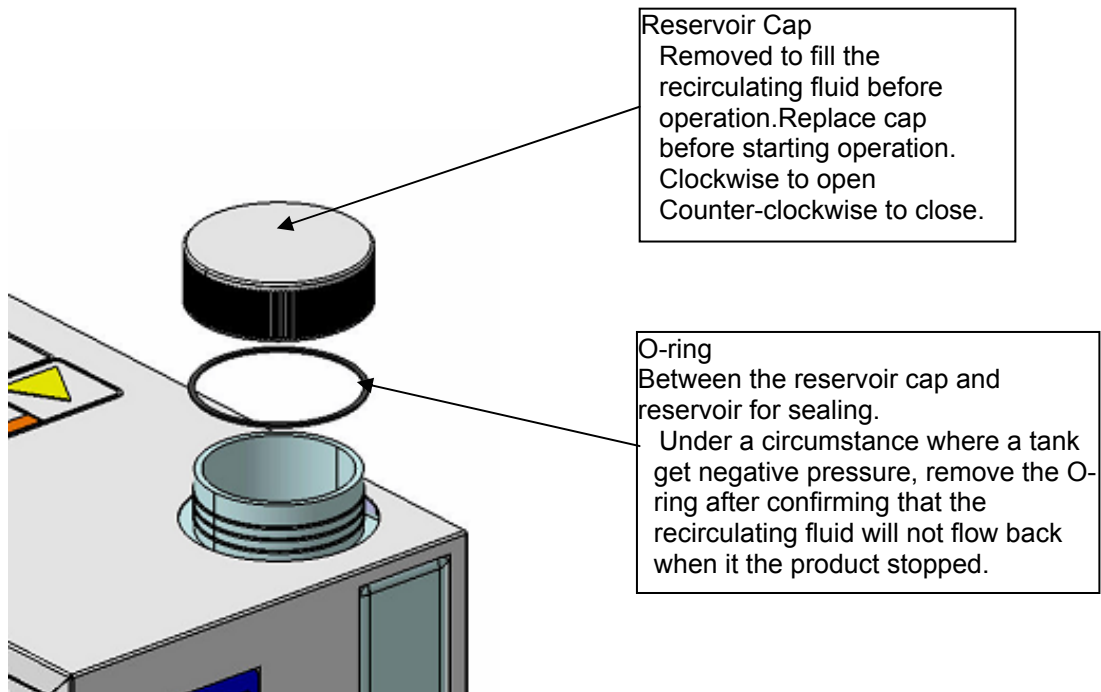

Fig.4-4 Reservoir Cap

5 Specifications

5.1 Specifications of HEC001

Table5-1 Specifications of HEC001

Type	HEC001-W5A	HEC001-W5B
Communication	RS-485	RS-232C
Set temp. range	10.0 to 60.0 °C	
Measured temp. range	-9.9 to 99.9 °C	
Ambient environment	Temp. : 10 to 35 °C Humidity : 35 to 85%RH(No dew condensation)	
Storage environment	Temp. : -20 to 60 °C Humidity : 35 to 85%RH(No dew condensation)	
Setting accuracy	±0.2 °C at max. (including sensor accuracy)	
Control accuracy (Note 1)	Within ±0.03 °C	
Cooling capacity (Note 2)	140W	
Heating capacity (Note 2)	410W	
Radiating water (Note 5)	Flow rate : 3 to 7L/min Temp. : 10 to 35 °C (no dew condensation)	
Recirculating fluid	Water and ethylene glycol up to 20%wt	
Max. operating pressure	Radiating water : 1MPa Recirculating fluid : 0.1MPa	
Wetted material	Radiating water : SUS304 Recirculating fluid : PPE, PPSglass10%, Aluminaceramic, Carbon ,EPDM,SUS303,SUS304,PE,PP,NBR	
Connection fitting	Recirculating fluid : Rc3/8 Radiating water : Rc3/8 Drain : Rc1/4	
Power supply	Single phase AC100V(3.5A) to 240V(1.5A)±10%, 50/60Hz	
Inrush current	40A MAX	
Overcurrent protection	10A Circuit Protector	
Insulation resistance	50MΩ more	
Main functions	Auto tuning, Off-set, Sensor fine adjustment, Serial communication Temp. upper and lower limit alarm, Output cutoff alarm,	
Input operation Indication	Membrane keysheet LCD operation display panel (with a back light)	
Temp.sensor (Note3)	Platinum resistive temperature detecting sensor,(Pt100Ω, 3-wire type)	
Dimensions (Note4)	Width184 x Height245 x Length321mm	
Reservoir capacity :approx.	Approx.1.2L	
Painting color	Urban white	
Weight	Approx. 12kg	
Limitation of poisonous substance	RoHS compliant product	
Option	F(With flow switch), N(NPT fitting), L(With level switch)	

5.2 Specifications of HEC003

Table5-2 Specifications of HEC003

Type	HEC003-W5A	HEC003-W5B
Communication	RS-485	RS-232C
Set temp. ranngae	10.0 to 60.0 °C	
Measured temp. range	-9.9 to 99.9 °C	
Ambient environment	Temp. : 10 to 35 °C Humidity : 35 to 85%RH(No dew condensation)	
Storage environment	Temp. : -20 to 60 °C Humidity : 35 to 85%RH(No dew condensation)	
Setting accuracy	±0.2 °C at max. (including sensor accuracy)	
Control accuracy (Note 1)	Within ±0.03 °C	
Cooling capacity (Note 2)	320W	
Heatingcapacity (Note 2)	770W	
Radiating water (Note 5)	Flow rate : 3 to 7L/min Temp. : 10 to 35 °C (no dew condensation)	
Recirculating fluid	Water and ethylene glycol up to 20%wt	
Max. operating pressure	Radiating water : 1MPa Recirculating fluid : 0.1MPa	
Wetted material	Radiating water : SUS304 Recirculating fluid : PPE, PPSglass10%, Aluminaceramic, Carbon ,EPDM,SUS303,SUS304,PE,PP,NBR	
Connection fitting	Recirculating fluid : Rc3/8 Radiating water : Rc3/8 Drain : Rc1/4	
Power supply	Single phase AC100V(5.5A) to 240V(2.5A)±10%, 50/60Hz	
Inrush current	40A MAX	
Overcurrent protection	10A Circuit Protector	
Insulation resistance	50MΩ more	
Main functions	Auto tuning, Off-set, Sensor fine adjustment, Serial communication Temp. upper and lower limit alarm, Output cutoff alarm,	
Input operation	Membrane keysheet	
Indication	LCD operation display panel (with a back light)	
Temp.sensor (Note3)	Platinum resistive temperature detecting sensor,(Pt100Ω, 3-wire type)	
Dimensions (Note4)	Width184 x Height245 x Length321mm	
Reservoir capacity :approx.	Approx.1.2L	
Painting color	Urban white	
Weight	Approx. 13kg	
Limitation of poisonous substance	RoHS compliant product	
Option	F(With flow switch), N(NPT fitting), L(With level switch)	

Note1) The value in the load stable state where turbulence does not exist.

Note2) Conditions that radiating water temperature is at 20°C, radiating water flow rate is at 5 L/min, setting temperature is at 20°C and ambient temperature is at 20°C

Note3) External sensor should be prepared by customers.

Note4) Reservoir cap, Handle, Drip proof cover, connector are not included.

Note5) If radiating water is poured excluding the range of the specification, the noise and the vibration are generated. Moreover, radiating water might become a high temperature.

5.3 Performance chart

Values on performance chart are not guaranteed values but representative values. The values used for consideration should not be at the very limit for the safety.

5.3.1 Performance of HEC001

1) Cooling capacity

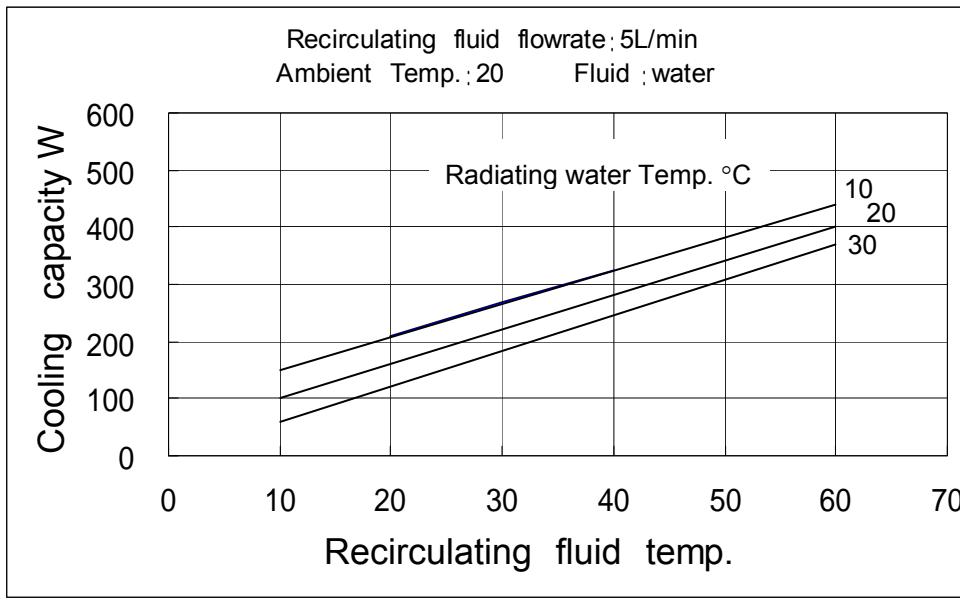

Fig. 5-1 Cooling capacity

*The Radiating water flow rate of 1L/min is for reference.

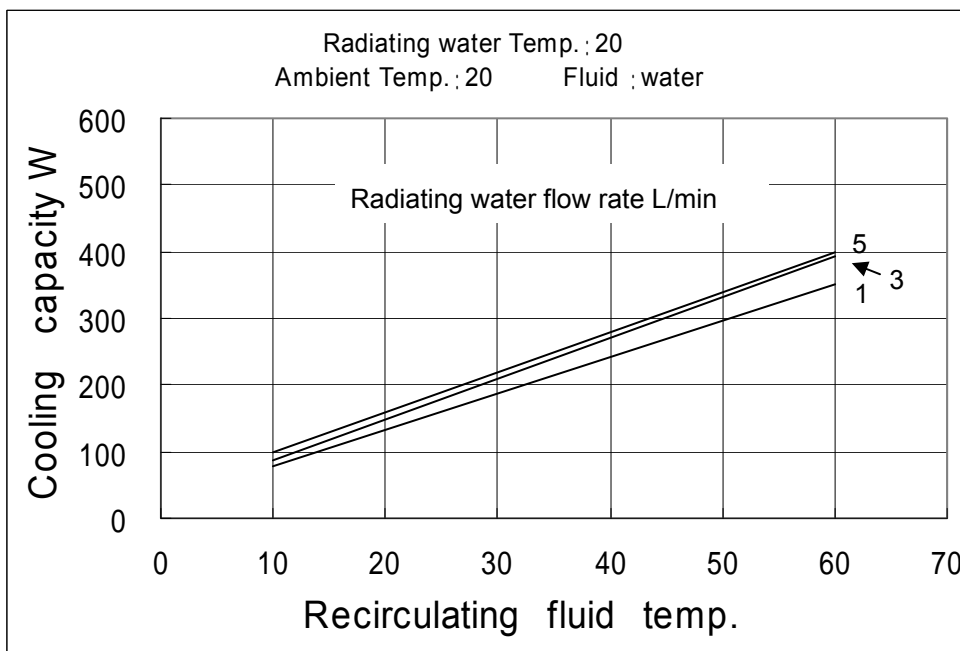

Fig. 5-2 Cooling capacity

2) Heating capacity

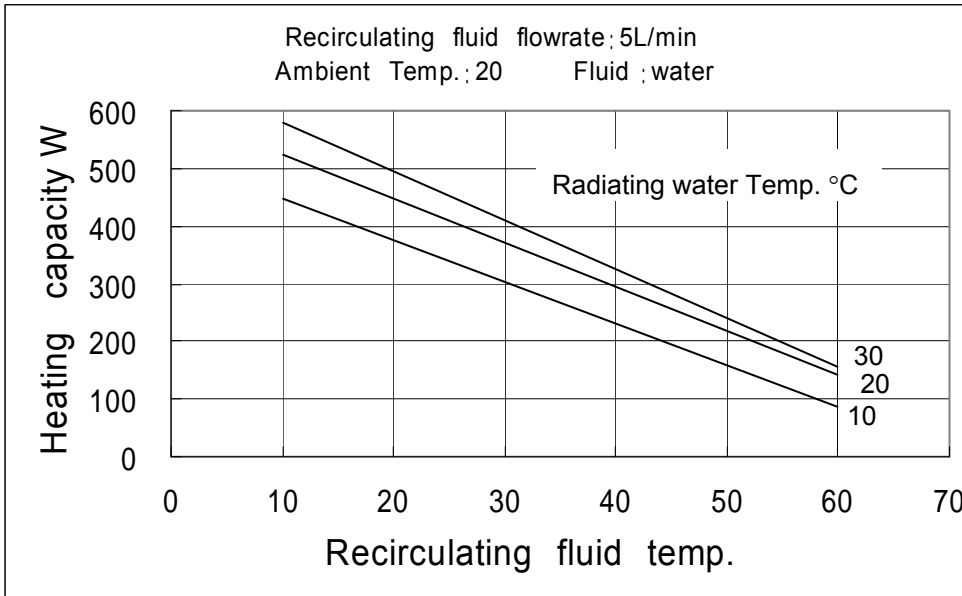

Fig. 5-3 Heating capacity

*The Radiating water flow rate of 1L/min is for reference.

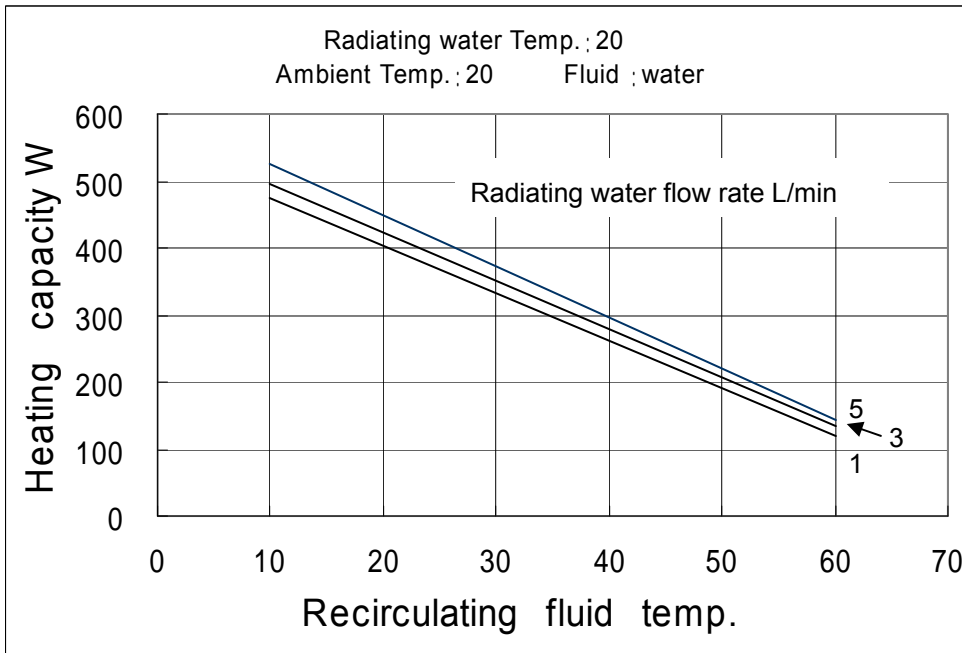

Fig. 5-4 Heating capacity

3) Pressure loss of radiating water

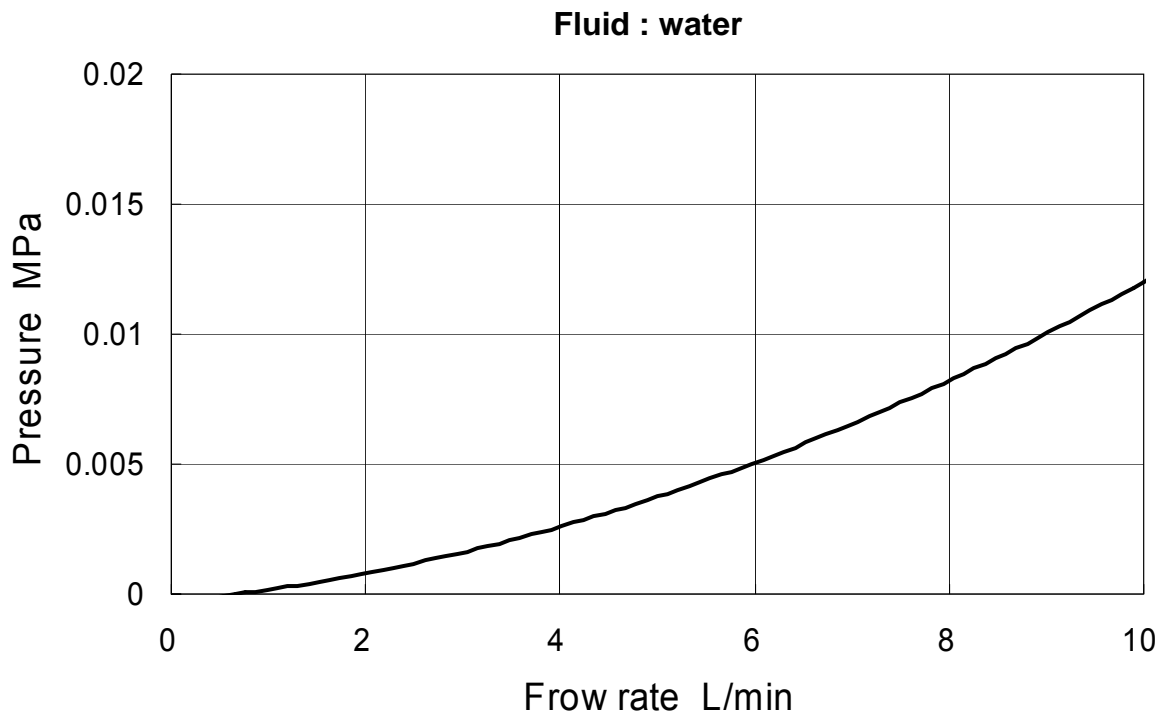

Fig. 5-5 Pressure loss

5.3.2 Performance of HEC003

1) Cooling capacity

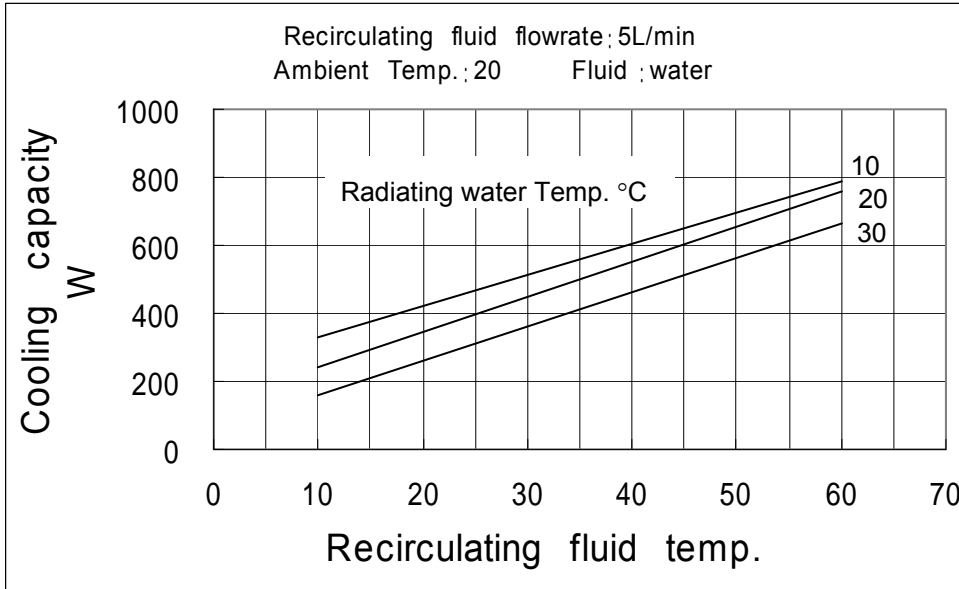

Fig. 5-6 Cooling capacity

*The Radiating water flow rate of 1L/min is for reference.

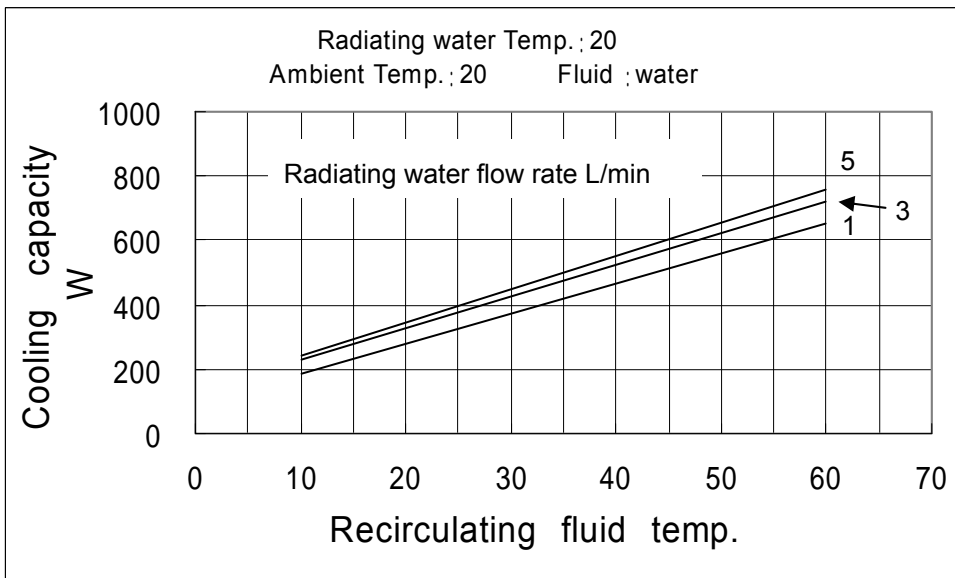

Fig. 5-7 Cooling capacity

2) Heating capacity

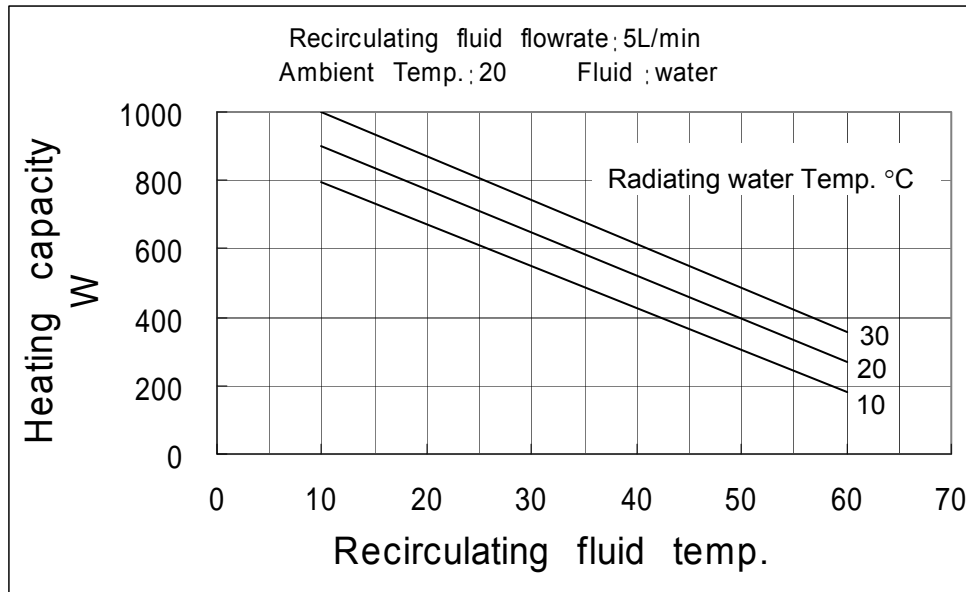

Fig. 5-8 Heating capacity

*The Radiating water flow rate of 1L/min is for reference.

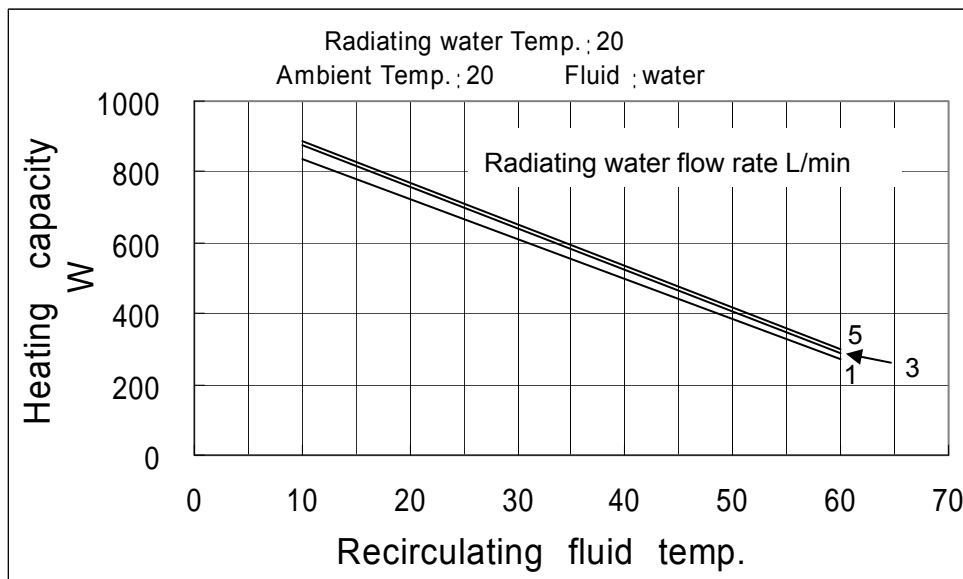

Fig. 5-9 Heating capacity

3) Pressure loss of radiating water

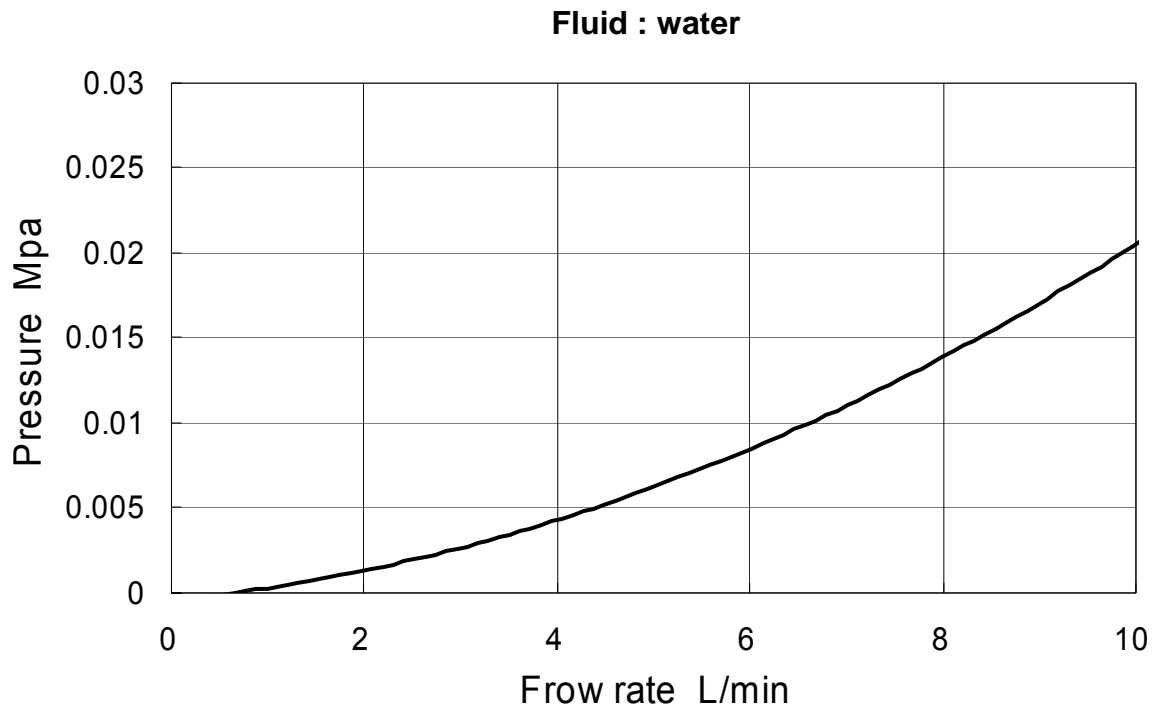

Fig. 5-10 Pressure loss

5.3.3 Performance of Pump capacity

1) Pump capacity(Common to HEC001 and 003)

The pressure on Y axis stands for discharge pressure of recirculating fluid from Thermo-con.

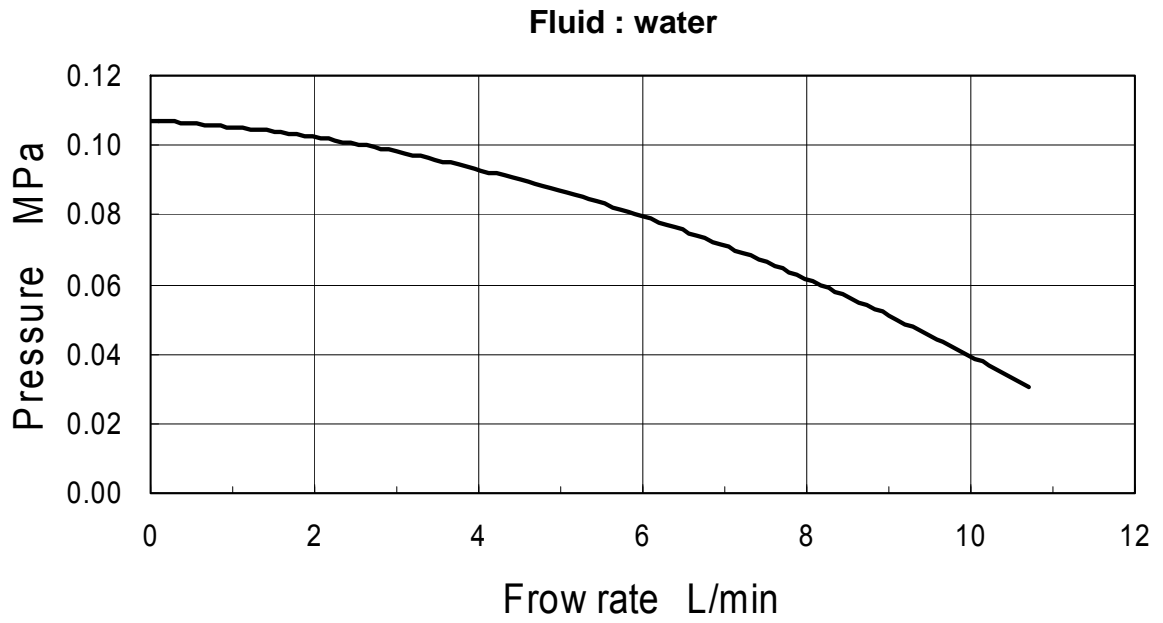

Fig. 5-11 Pump capacity

6 Preparation for Operation

6.1 Piping

6.1.1 Preparation for radiating water

The piping for radiating water is connected as below.

- 1) Connect fittings to the ports marked [RADIATING WATER IN] and [RADIATING WATER OUT] at the rear side of the equipment. (the same fittings should be used for IN and OUT)
[Port size ---3/8]
- 2) When connecting a fitting to the port, hold the port a wrench to protect the port on the product from directly receiving the force created by the tightening the fittings.
[Tightening torque --- 22 to 24Nm]
- 3) Apply the following flow rate of radiating water.
3L/min - 7L/min
When the flow rate of the radiating water is not enough, cooling capacity will decrease. Also, when the flow rate is extremely small, alarm (ERR14) may occur and the temperature of the radiating water might be extremely high. If resin tubing is used for piping under these circumstances, the tubing may be softened and break. Therefore, be sure to cool the radiating water and flow the radiating water with the correct flow rate.

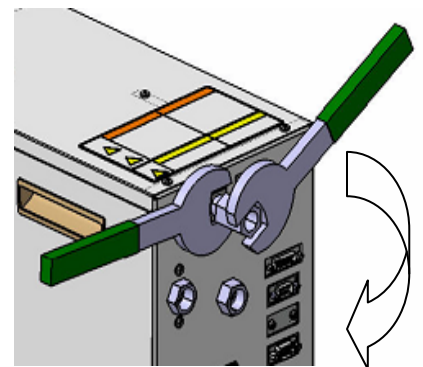
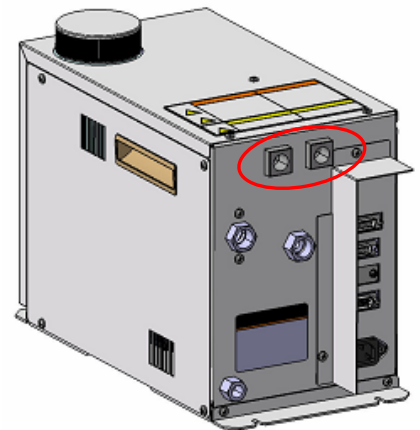

▲ CAUTION

Use fresh water such as tap water for the radiating water. If radiating water is circulated, control the quality of the radiating water to prevent corrosion of the wetted material. For quality standards for the radiating water, refer to “2.5 Quality of Radiating Water.”

▲ CAUTION

Keep the radiating water temperature between 10 and 35°C. (No dew condensation)
Note that the cooling and heating capacity is changing depending on radiating water temperature. Also, if lower-temperature radiating water is supplied, dew may condense in the product and the equipment could be damaged. Keep the radiating water temperature above the atmospheric pressure dew point. To find the dew point, refer to “9.3 Calculation of Dew Point Temperature (from a psychrometric chart).”

▲ CAUTION

The maximum operating pressure is 1.0MPa.

Do not attach a valve at the outlet of radiating water port. Otherwise, water hammer can occur and damage the product.

6.1.2 Preparation for recirculating fluid

The piping for recirculating fluid is connected as below.

- 1) Connect fittings to the ports marked [RECIRCULATING FLUID IN] and [RECIRCULATING FLUID OUT] and [DRAIN] at the rear side of the equipment. (the same fittings should be used for IN and OUT)

- (1) [Port size Rc 3/8]
- (2) [Drain Rc1/4]

- 2) A plug is mounted on DRAIN port for recirculating fluid. When the piping for drain is connected, remove this plug beforehand.
Drain the recirculating fluid before performing any maintenance.

- 3) When connecting a fitting to the port, hold the port a wrench to protect the port on the product from directly receiving the force created by the tightening the fittings.

- (1) [Tightening torque --- 22 to 24 Nm]
- (2) [Drain ----12 to 14 Nm]

- 4) Take off the reservoir cap of the product.

Fill the recirculating fluid for the reservoir.

The inlet of the reservoir is not so large and there is a possibility of spillage of recirculating fluid. Pay attention when filling the recirculating fluid. Stop the filling once the level of fluid reaches "H" level.

Turn on the power switch to fill the piping with the fluid.

When the external piping is filled with the recirculating fluid, the level of the reservoir lowers and low recirculating fluid alarm (ERR20) arises accordingly. Then, turn off the power supply once again.

Repeat the step from 5 to 7 until ERR20 alarm doesn't appear any more. Then, replace the cap on the reservoir and tighten it securely.

Keep the fluid level between H and L of the level indicator.

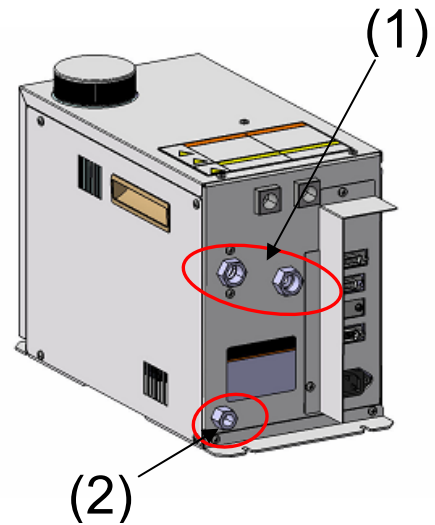

▲ DANGER

Never touch the power switch with wet hands to avoid electrical shock.

▲ CAUTION

GALDEN (Solvay Solexis) and Fluorinert (3M) can't be used with this product.

▲ CAUTION

Take enough care not to spill water over the case when filling the reservoir. When it is spilt by mistake, wipe it off immediately and supply the power after it has dried. If this procedure is neglected, it may cause failure of the product.

▲ CAUTION

If the power switch is turned on without recirculating fluid, the pump can be activated.

▲ CAUTION

The maximum operating pressure of the recirculating fluid is 0.1MPa. If pressure goes over this limit, water may leak from the tank and piping inside the thermo-con.

▲ CAUTION

An operation at higher ambient temperature or temperature up/down (heating/cooling) cycle shall be avoided. The lifetime of the pump and Thermo-electric modules is shortened.

▲ CAUTION

If the external piping length is too long, the built-in reservoir tank could have negative pressure resulting in deformation and crack on tank. The built-in reservoir tank is made of plastic and must be use at more than - 0.02MPa.

▲ CAUTION

Once the plug is removed from the drain port, the leakage from it is possible. Therefore, seal it with PTFE seal tape etc. and ensure there is no leakage from it before operation.

▲ CAUTION

When DI water is used as recirculating fluid, static electricity occurred by the flow friction may damage or malfunction the unit. To eliminate the static electricity, use metal for the piping material and grounding wire should be connected if necessary.

▲ CAUTION

The level of the tank should be checked once a day and kept within the appropriate range (H to L). The level may go down due to evaporation of the recirculating fluid. When the level goes lower than "L" level, it may affect the performance or damage the installed pump. Operate the unit with the correct fluid level in the tank.

▲ CAUTION

Select piping length and size in order to have a recirculating fluid flow more than 2L/min. If the flow is less than 2L/min the temperature stability will be poor. The product may be damaged from continually changing between cooling and heating.

6.2 Wiring

6.2.1 Power supply

The power supply shall be connected with supplied power supply cable.
Before wiring confirm the power supply at factory has enough capacity and the voltage is within specified value (with reference to electrical specifications of the power supply). This product is provided with a power supply cable. The power supply cable shall be connected properly in accordance with Chapter 9 "Power Supply Cable".

⚠ CAUTION

Do not bend, pull or bind the power supply cable with a strong force. It may damage the power supply cord or potentially cause electric shock or fire.

6.2.2 Circuit Breaker

For the power source, install a breaker with a rated breaking capacity of 5kA or more.

6.2.3 Grounding

Be sure to provide protective ground, which must be class D for Japan (ground resistance of 100ohm or less). PE line of the power supply cable is available for grounding. Do not hold the ground in common with the ones for equipment which generates strong electromagnetic noise or high frequency.

⚠ CAUTION

If the fluid with high resistivity such as DI water is used as the circulating fluid, static electricity will be generated due to the flow friction. As both Thermo-con and the customer's machines might be charged by this static electricity, ground wire shall be connected to eliminate static electricity.

6.2.4 Avoidance of Parallel Wiring

Avoid connecting a signal line such as for communications or external sensor or alarm in the same route as or in parallel to a power line or high voltage line.

6.2.5 Connection of Various Connectors and Power Supply Cable

- 1) Ensure that the power source and the power supply of the product is turned off before connecting the various connector and power supply cable.
- 2) When an external temperature sensor is connected, connect the sensor with a shield cable. Use a platinum resistant temperature sensor (Pt100Ω, 3-wiring type, class A, 2mA)
- 3) Connect the host to this product with a twisted pair shield cable when applying communication function.
- 4) For alarm output, connect it with a twisted pair cable.

6.3 Check·Repair

The following checks shall be performed before operation.

6.3.1 Daily check

- 1) Indication of display panel: Check temperature condition and confirm whether or not the alarm occurs.
- 2) Check the recirculating fluid is not contaminated. Once the fluid is contaminated, it may degrade the performance or shorten the life time. When water is used, it's recommended that anti-alga agent should be used or replace the recirculating fluid about once a month as alga or bacteria deteriorates the recirculating fluid.
- 3) Confirm there is no leakage of recirculating fluid or no bending or crush of the piping of recirculating fluid.
- 4) Confirm there is no abnormal sound or smell or abnormal heating of the case.

▲ CAUTION

Operation of the pump with the plenty of air left in the piping for prolonged period may cause the pump to break. Exhaust the air enough from the piping before starting operation of the pump.

▲ CAUTION

Do not perform operation under the condition which lowers the flow rate significantly, such as closing the valve. Other wise, the temperature might be beyond control.

▲ CAUTION

The product is damaged if the operation with temperature fluctuation is continued for long time. Please set the PID value again by using auto-tuning function.

▲ CAUTION

The tank has negative pressure (air sucking sound can be heard when the lid is loosened) during operation. If the operation is continued in such conditions, the tank may be broken. If the tank has negative pressure, remove the packing at the lid of the tank, and make it an open tank. Before removing the packing, ensure that that fluid will not overflow out of the tank due to back flow after stopping operation.

6.3.2 Check after seismic vibration and impact

- 1) Piping: Confirm there is no defect including disconnection in piping.
- 2) Electrical wiring: Confirm there is disconnection of the connector from the cable.
- 3) Mounting condition: If the Thermo-con is mounted for operation, confirm the Thermo-con is mounted securely.
- 4) Recirculating fluid: Confirm there is no leakage.
- 5) Others: Confirm there is no abnormal sound or smell or abnormal heating of the case.

6.3.3 Repair and maintenance

The repair and maintenance services of this unit are performed only at our factory. The service requiring a trip regardless of inside and outside of Japan is not provided. When returning the product for repair or maintenance service, discharge all the fluid inside the Thermo-con in order to avoid fluid leakage during transportation, and seal it.

Additionally, it is recommended to prepare spare units to minimize downtime due to those repair and maintenance services.

⚠WARNING

Drain the fluid from Thermo-con when it is returned for the repair and maintenance service. If the fluid is left inside, an accident and damage can result during transportation.

6.3.4 Abandonment

Contact an industrial waste disposal company for disposal of the product.

7 Operation

This chapter describes the detailed information on how to operate.

7.1 Start of operation

7.1.1 Confirmation before operation

- 1) Confirm that the recirculating fluid has reached a L level
- 2) Supply radiating water.
- 3) Confirm that there is no incorrect wiring of the connected cables and turn on the power supply of the unit.
- 4) When power is turned on, software version is indicated on display panel for approx. 1 sec. (Ex. : 1.0)

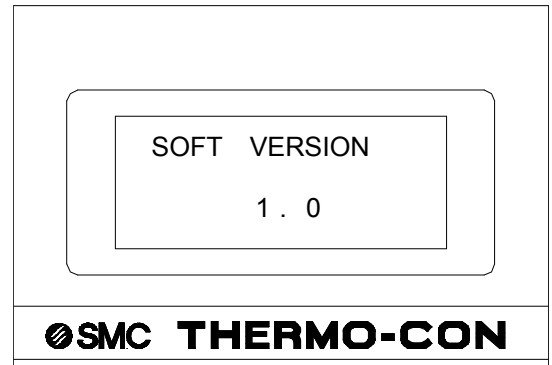

7.1.2 Setting of values

When the product has been found to start operating normally set the values such as temperature. Once the value is set, it will remain set even if the power supply is turned off.

⚠ CAUTION

Be sure to operate the operation and display panel by finger. Using tools such as a screwdriver, pen, or pencil may damage the panel.

NOTE

When the set value is changed, it takes 3 seconds for the change to be saved to EEPROM.

7.1.3 Cautions for Operation Control

- 1) Wait at least 30 min. after the power supply is turned on before operating the external equipment to allow the product to reach stable conditions.
- 2) If an alarm occurs during operation, refer to section 8 for troubleshooting.

⚠ WARNING

Do not operate the product without the external panels fitted. Contact with inside of the product may cause injury or electric shock.

⚠ CAUTION

If lower-temperature radiating water is supplied, dew may condense in the product and the equipment could be damaged. Keep the temperature of the radiating water above the atmospheric pressure dew point.

⚠ CAUTION

Please do not use devices that generate electromagnetic radiation such as cellular phones near the product. There is a possibility that the product malfunctions.

7.2 How to operate

1. The different 3 levels are available depending on the content, which needs to be set.

Level 1 : Used normally and setting of target temp. and offset are included. (Refer to 7.3.)

Level 2 : Used at maintenance and initial setting. Setting of controller PID is included. (Refer to 7.4.)

Level 3 : Used rarely for the purpose other than initial setting and communication setting is included. (Refer to 7.5)

2. [SEL] key

Used to show the item, which needs to be changed in selected mode level.

3. [∇ Δ] key (up/down key)

Used to change the value of the item shown by [SEL] key.

4. [RET] key

Used to fix the value changed by [∇ Δ]key. Press once again to return to current temp. indication.

5. [AT] key

Used to start auto tuning in auto tuning mode (control operation mode : 2). When pressed during auto tuning, the auto tuning is stopped.

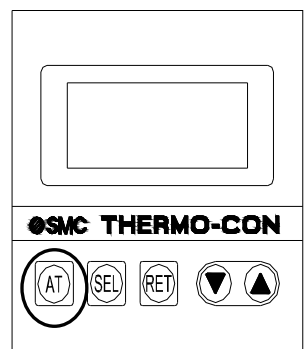
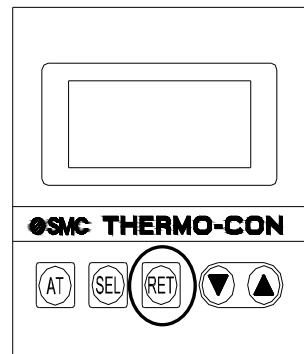
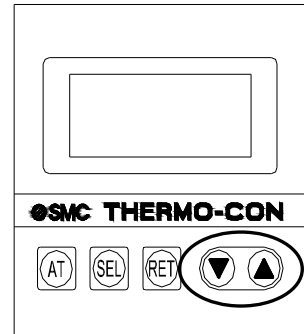
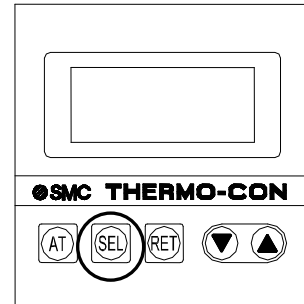
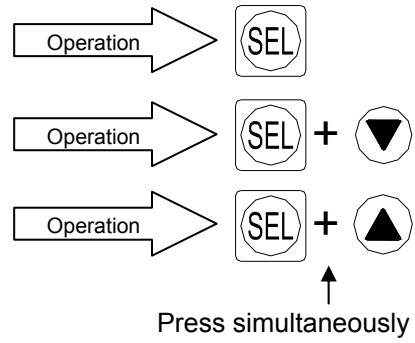

7.3 Setting Mode, Level 1

The method to enter to and return from setting mode Level 1 and which mode can be set in the level are explained below.

7.3.1 How to enter and return

Press [SEL] key while power is turned on. Then, the indication on [MODE] is changed depending on the number of press and the data in the indicated mode can be set. To return to current temperature indication, press [RET] key twice.

NOTE

When no input is done within 1 minute regardless of setting mode, the current temperature indication is returned automatically.

7.3.2 Available mode in Level 1

The mode which can be set in setting mode Level 1 is as shown on Table 7-1. The mode available in Level 1 is supposed to be used in normal operation including target temp. and offset.

⚠ CAUTION

The inputted data is written in EEPROM and memorized after the power supply is turned off. The writing can be done up to 1 million times.

Table7-1 Available mode in Level 1

No.	Modes	Setting contents	Setting range (Min. increment)	Default
1	Target Temp. (No indication on display)	Sets target temp. for control.	10.0 to 60.0 °C (0.1 °C) [Standard specification]	25.0
2	Control Operation	Selects control operation mode from those shown below. 0 : Pump stop(No control) 1 : Normal(normal control operation) 2 : AT(auto tuning) 3: Learn (learning control) 4: External (external tune control)	0,1,2,3,4	1
3	External Sensor Sampling Cycle	Sets sampling cycle for learning control or external tune control. (Not indicated during normal control.)	10 to 999sec (1sec)	180
4	Offset Value	Indicates the offset value of the recirculating fluid temperature used as reference value by the controller (SV + Offset).	-9.99 to 9.99 °C (0.01 °C)	0.00
5	Allowable Upper Temp. Range	Sets upper limit of temp. range which causes the warning to arise.	0.1 to 10.0 °C (0.1 °C)	1.5
6	Allowable Lower Temp. Range	Sets lower limit of temp. range which causes the warning to arise.	0.1 to 10.0 °C (0.1 °C)	1.5
7	High Temp. Cutoff	Sets upper limit of temp. which the internal temp. sensor detects and judges the unit should be shut off.	11.0 to 70.0 °C (0.1 °C)	70.0
8	Low Temp. Cutoff	Sets lower limit of temp. which the internal temp. sensor detects and judges the unit should be shut off.	0.0 to 59.0 °C (0.1 °C) [Standard specification]	0.0

* How to return default value: Turn on the power supply with pressing [SEL] and [RET] keys, At this time, the settings of Level 2 and Level 3 are also reset.

7.4 Setting mode, Level 2

The method to enter to and return from setting mode Level 2 and which mode can be set in the level are explained below.

7.4.1 How to enter and return

Press [SEL] and [▽] keys at the same time while power is turned on. Then, the indication on [MODE] is changed depending on the number of press and the data in the indicated mode can be set. To return to current temp. indication, press [RET] key twice.

NOTE

When no input is done within 1 minute regardless of setting mode, the current temperature indication is returned automatically.

7.4.2 Available mode in Level 2

The mode, which can be set in setting mode Level 2, is as shown on Table 7-2. The mode available in Level 2 is supposed to be used normally for initial setting and maintenance and control PID is included.

NOTE

The inputted data is written in EEPROM and memorized after the power supply is turned off. The writing can be done up to 1 million times.

Table7-2 Available mode in Level 2

No.	Modes	Setting contents	Setting range (Min. increment)	Default
1	Fine Control of Internal Sensor	Sets the fine adjusting value to calibrate the internal temp. sensor.	-9.99 to 9.99 °C (0.01 °C)	0.00
2	Fine Control of External Sensor	Sets the fine adjusting value to calibrate the external temp. sensor available optionally.	-9.99 to 9.99 °C (0.01 °C)	0.00
3	PB Range	Sets PB (Proportional Band) range used for PID control.	0.3 to 9.9 °C (0.1 °C)	0.6
4	ARW Range	Sets integral operation range of PID control. ARW: Anti Reset Windup	0.3 to 9.9 °C (0.1 °C)	1.0
5	I Constant	Sets integral time used for PID control.	1 to 999sec (1sec)	150
6	D Constant	Sets differential time used for PID control. When 0 is set, differential operation is not made.	0.0 to 99.9sec (0.1sec)	0.0
7	Heating/Cooling Ratio	Sets output ratio of cooling to heating to compensate difference of gain between them.	10 to 999% (1%)	200
8	Overload Judging Temp. Range	Sets the temp. range for judgment of overload (accompanying abnormal output alarm ERR15).	0.1 to 9.9 °C (0.1 °C)	0.2
9	Overload Judging Time	Sets time for judgment of overload (accompanying abnormal output alarm ERR15). When 0 is set, the alarm doesn't arise.	0 to 99min (1min)	10
10	Output Ratio	Shows output ratio of thermo module by 1%. The prefix symbol "-" stands for cooling and no prefix stands for heating.	-100 to 100% (1%)	-
11	Upper/Lower Temp. Alarm Sequence	Determines whether or not temp. upper/lower limit alarm is output when power is turned on. On : Output Off : Not output	On,Off	Off

* How to return default value: Turn on the power supply with pressing [SEL] and [RET] keys. At this time, the settings of Level 1 and Level 3 are also reset.

7.5 Setting mode, Level 3

The method to enter to and return from setting mode Level 3 and which mode can be set in the level are explained below.

7.5.1 How to enter and return

Press [SEL] and [Δ] keys at the same time while power is turned on. Then, the indication on [MODE] is changed depending on the number of press and the data in the indicated mode can be set. To return to current temp. indication, press [RET] key twice.

NOTE

When no input is done within 1 minute regardless of setting mode, the current temperature indication is returned automatically.

7.5.2 Available mode in Level 3

The mode, which can be set in setting mode Level 3, is as shown on Table 7-3. The mode available in Level 3 is supposed not to be used normally for the purpose other than initial setting and the setting related to communication is included.

NOTE

The inputted data is written in EEPROM and memorized after the power supply is turned off. The writing can be done up to 1 million times.

Table7-3 Available mode in Level 3

No.	Modes	Setting contents	Setting range (Min. increment)	Default
1	Unit Number	Sets the unit No. used. This is applicable only when multiple Thermo-con is used.	0 to F (Hex decimal)	0
2	Baud Rate	Sets baud rate for communication.	600,1200,2400,4800 9600,19200b/s	1200
3	Parity Bit	Sets parity bit for communication. Without : No parity Odd : Odd Even : Even	Without, Odd, Even	Without
4	Data Length	Sets data length for communication.	7Bits, 8Bits	8
5	Stop Bit	Sets stop bit for communication.	1Bit, 2Bits	1

* How to return default value: Turn on the power supply with pressing [SEL] and [RET] keys. At this time, the settings of Level 1 and Level 2 are also reset.

7.6 Detail of setting mode level

The each setting mode level is explained below in detail.

7.6.1 Setting mode, Level 1

1. Indication of current temperature [PV]

Indication range: -9.9 to 99.9 °C

Min. increment: 0.1 °C

Indicated content: #1 Temperature detected by
internal temp.
sensor

#2 Temperature detected by external
temp. sensor

```
P V < 23.0 °C # 1
S V    25.0 °C
MODE
```

(When the external sensor is not connected, “HHHH” would be indicated.)

#1 and #2 change when [Δ] or [▽] is pressed.

```
P V < 23.0 °C # 2
S V    25.0 °C
MODE
```

2. Target temperature (no indication on display)

Setting range : 10.0 to 60.0 °C

Min. increment : 0.1 °C

Indicated content : [SV] : Target temp.(Ex. : 25.0 °C)

Function : Sets target temperature

```
P V    23.0 °C # 1
S V < 25.0 °C
MODE
```

3. Control Operation

Setting range : 0,1,2,3,4

Indicated content : Number and description of control
operation mode.(Ex. : 1:Normal)

Function : Selects control operation mode from
those shown below

- 0 : Stop of control (Pump Stop)
- 1 : Normal (normal control operation)
- 2 : AT (auto tuning)
- 3 : Learning control (Learn)
- 4 : External tune control (External)

```
Control
Operation
MODE < 1 : Normal
```

When a learning control and an external tuning control are selected, measurement temperature (#2) of an external temperature sensor is displayed.

When an external tuning control is selected, the target temperature is changed at any time. When the control mode changes from external tune mode to normal mode, the target temperature returns to the previous value.

<How to perform auto tuning>

- 1) Select “2” in control operation.
- 2) Press [AT] key to light up “AT” indicator. The auto tuning starts.
- 3) To stop auto tuning, press [AT] key again. (“AT” indicator goes off.)
- 4) When auto tuning is finished, “AT” indicator goes off. If the auto tuning is not finished within 20min, [ERR19] (AT error) arises.
- 5) If the auto tuning fails, change the PID values to the set values at the time of shipment from factory or input the optimum values.

4. External sensor sampling cycle setting mode
 Setting range: 10 to 999sec
 Min. increment: 1sec
 Indicated content: External sensor sampling cycle
 (Ex.: 180sec)
 Function: Sets sampling cycle of external sensor for learning control or external tune control.

```
External Sensor
Sampling Cycle
MODE< 180 sec
```

5. Offset Value
 Setting range : -9.99 to 9.99 °C
 Min. increment : 0.01 °C
 Indicated content : Offset value(Ex. : -0.15 °C)
 Function : It allows the change of the difference between the controller reference value and set value by offset.
 For example, if -0.15 °C is set here, the actual reference temperature for control is lower than the indicated SV by 0.15 °C.

```
Offset Value
MODE< -0.15 °C
```

6. Allowable Upper Temp. Range
 Setting range : 0.1 to 10.0 °C
 Min. increment : 0.1 °C
 Indicated content : Temp. from target to upper limit
 (Ex.: 1.5 °C)
 Function : Sets upper limit of temp. where the warning arises. The difference between target temp. and upper limit temp. should be input. Therefore, if the target temp. is 23.0 °C and 1.5 °C is set in this item, the warning [WRN] arises when temp. exceeds 24.5 °C.

```
Allowable Upper
Temp. Range
MODE< 1.5 °C
```

7. Allowable Lower Temp. Range
 Setting range : 0.1 to 10.0 °C
 Min. increment : 0.1 °C
 Indicated content : Temp. from target to lower limit
 (Ex. : 1.5 °C)
 Function : Sets lower limit of temp. where the warning arises. The difference between target temp. and lower limit temp. should be input. Therefore, if the target temp. is 23.0 °C and 1.5 °C is set in this item, the warning [WRN] arises when temp. lowers 21.5 °C.

```
Allowable Lower
Temp. Range
MODE< 1.5 °C
```

8. High Temp. Cutoff
 Setting range : 11.0 to 70.0 °C
 Min. increment : 0.1 °C
 Indicated content : High temp. cutoff by internal temp. sensor (Ex. : 70.0 °C).
 Function : Sets upper limit of temp. at which the internal temp. sensor detects and judges the unit should be shut off. When the temp. set in this item is reached, the alarm [ERR12] arises.

```
High Temp.
Cutoff
MODE< 70.0 °C
```

9. Low Temp. Cutoff

Setting range : 0.0 to 59.0 °C

Min. increment : 0.1 °C

Indicated content : Low temp. cutoff by internal temp. sensor (Ex. : 0.0 °C)

Function : Sets lower limit of temp. at which the internal temp. sensor detects and judges the unit should be shut off. When the temp. set in this item is reached, the alarm [ERR13] arises.

```
Low Temp. Cutoff
MODE< 0.0 °C
```

7.6.2 Setting mode, Level 2

1. Fine Control of Internal Sensor

Setting range : -9.99 to 9.99 °C

Min. increment : 0.01 °C

Indicated content : Fine adjusting value for internal temp. Sensor (Ex. : -0.07 °C)

Function : Sets the fine adjusting value to calibrate the internal temp. sensor. If -0.07 °C is set in this item, the reading of temp. sensor is higher by 0.07 °C and actually, the temp. is controlled to lower one by 0.07 °C.

```
Fine Control of
Internal Sensor
MODE< -0.07 °C
```

2. Fine Control of External Sensor

Setting range : -9.99 to 9.99 °C

Min. increment : 0.01 °C

Indicated content : Fine adjustment value for external temp. sensor(Ex. : 0.05 °C)

Function : Sets the fine adjusting value to calibrate the external temp. sensor if it is mounted optionally. If 0.05 °C is set in this item, the reading of temp. sensor is lower by 0.05 °C and actually, the temp. is controlled to higher one by 0.05 °C.

```
Fine Control of
External Sensor
MODE< 0.05 °C
```

3. PB Range

Setting range : 0.3 to 9.9 °C

Min. increment : 0.1 °C

Indicated content : PB range(Ex. : 0.6 °C)

Function : Sets PB (Proportional Band) range used for PID control.

```
PB Range
MODE< 0.6 °C
```

4. ARW Range

Setting range : 0.3 to 9.9 °C

Min. increment : 0.1 °C

Indicated content : ARW range (Ex.: 1.0 °C)

Function : Sets integral operation range of PID control. If this value is set less than PB range, the set temperature can't be achieved. Therefore set it above PB range.

```
ARW Range
MODE< 1.0 °C
```

ARW: Anti Reset Windup

5. I Constant

Setting range : 1 to 999sec

Min. increment : 1sec

Indicated content : I constant(Ex. : 150sec)

Function : Sets integral time used for PID control.

```
I Constant
MODE< 150 sec
```

6. D Constant

Setting range : 0.0 to 99.9sec
 Min. increment : 0.1sec
 Indicated content : D constant(Ex. : 0.0sec)
 Function : Sets differential time used for PID control.
 When 0 is set, this function becomes invalid.

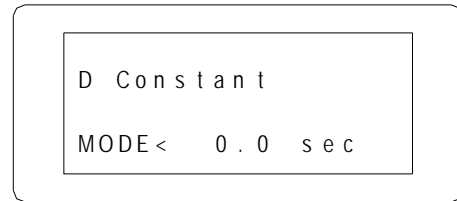

7. Heating/Cooling Ratio

Setting range : 10 to 999%
 Min. increment : 1%
 Indicated content : Heating/cooling gain ratio(Ex. : 200%)
 Function: Sets output ratio of cooling to heating to compensate difference of gain between them.

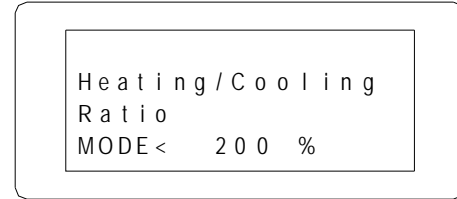

8. Overload Judging Temp. Range

Setting range : 0.1 to 9.9 °C
 Min. increment : 0.1 °C
 Indicated content : Overload judging temp. range
 (Ex. : 0.2 °C)
 Function : Sets the temp. range for judgment of product overload (accompanying abnormal output alarm ERR15).

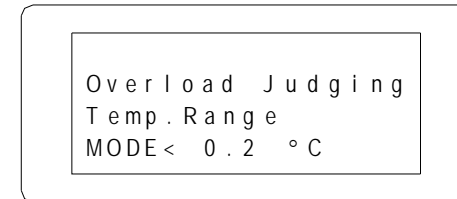

9. Overload Judging Time

Setting range : 0 to 99min
 Min. increment : 1min
 Indicated content : Overload judging time(Ex. : 10min)
 Function : Sets time for judgment of product overload (accompanying abnormal output alarm ERR15). When 0 is set, the alarm doesn't arise.

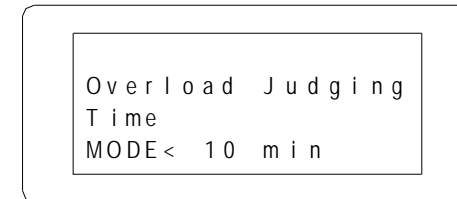

10. Output indication mode [Output Ratio]

Setting range : -100 to 100%
 Min. increment : 1%
 Indicated content: Thermo module output ratio (Ex.: -73%)
 Function: Indicates Thermo module output ratio with increment of 1%. "+" is not indicated but "+" means heating and "-" means cooling.

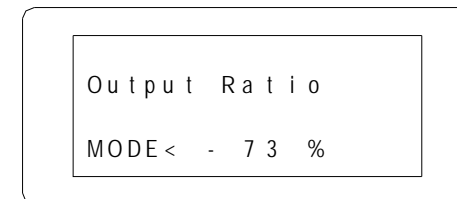

11. Upper/Lower Temp. Alarm Sequence

Setting range : On, Off
 Indicated content : Use of temp. upper/lower limit alarm Sequence (Ex. : Off)
 Function : Determines whether or not temp. upper/lower limit alarm is output when power is turned on.

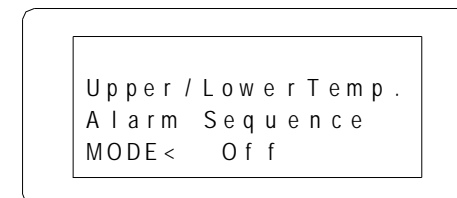

On : Output

Off : Not output (Alarm for high and low temperature limit is not detected until the temperature reaches the target temperature after the power is supplied.)

7.6.3 Setting mode, Level 3

1. Unit Number

Setting range : 0 to F (Hex decimal)

Indicated content : Unit number (Ex. : 0)

Function : Sets unit number used. This item is applicable only when multiple units are used.

Unit Number

MODE < 0

2. Baud Rate

Setting range : 600, 1200, 2400, 4800, 9600, 19200b/s

Indicated content : Baud rate (Ex. : 1200b/s)

Function : Sets baud rate for communication.

Baud Rate

MODE < 1200 b / s

3. Parity Bit

Setting range : Without (no parity), Odd, Even

Indicated content : Parity bit (Ex. : Without)

Function : Sets parity bit for communication.

Parity Bit

MODE < Without

4. Data Length

Setting range : 7Bits, 8Bits

Indicated content : Data length(Ex. : 8Bits)

Function : Sets data length for communication.

Data Length

MODE < 8 Bits

5. Stop Bit

Setting range : 1Bit, 2Bits

Indicated content : Stop bit(Ex. : 1Bit)

Function : Sets stop bit for communication.

Stop Bit

MODE < 1 Bit

7.6.4 Power supply OFF

The power switch is turned off.

▲ CAUTION

When the power supply is restarted after turned off once, keep time interval at least 3sec. The restart of supply within that interval may break the unit.

8 Alarm

This chapter explains the various alarms that the product has.

8.1 How to Identify Alarm

The alarm is identified as shown on the following table.

Table8-1 Alarm information

No.	Condition	After Alarm Occurrence
1	Power supply on	After indication of the software version, the error No. [ERR**] starts blinking and then a description of the error is displayed, and [MODE], "Shut Off" is shown. (“Continuity” is shown instead when ERR15 and ERR18 occurs because the product continues to operate.)
2	Normal operation	The value of PV and SV disappear and instead, the error No. [ERR**] starts blinking and the a description of the error is displayed, and [MODE], "Shut Off" is shown. (“Continuity” is shown instead when ERR15 and ERR18 occurs because the product continues to operate.)
3	Set value input	Even during input of a setting, the error No. [ERR**] starts blinking on the upper line. After input (pressing [RET] key to set), a description of the error is displayed (see Fig.8-1).
4	Temp. upper/lower limit alarm occurrence	The value of PV and SV and the indication of [MODE] remain but also [WRN] lights up. After the error is reset, the indication of [WRN] disappears.

8.2 Alarm indication

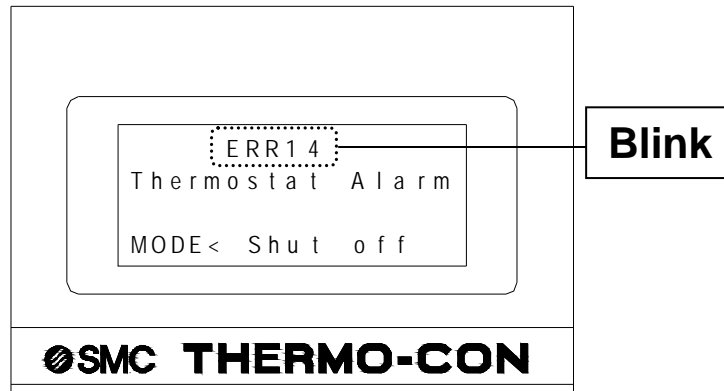

Fig.8-1 Alarm indication in the event ERR14 arises

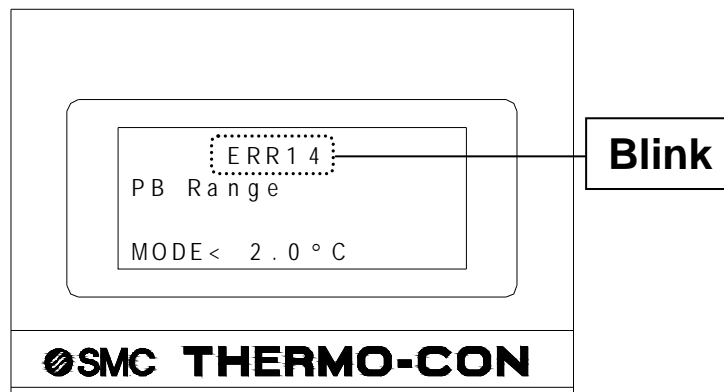

Fig.8-2 Alarm indication in the event ERR14 arises during PB range setting input

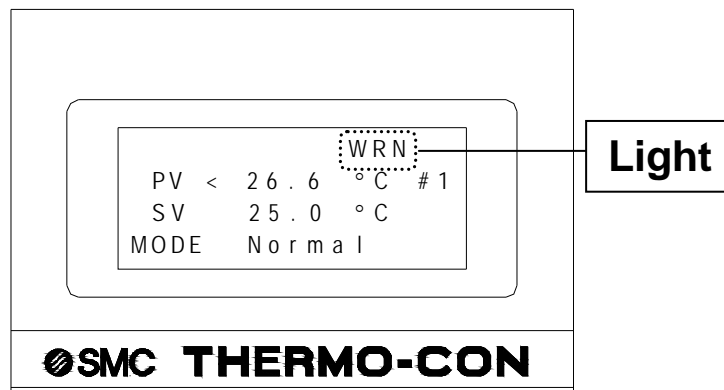

Fig.8-3 Alarm indication in the event temp. upper and lower limit arises

8.3 How to reset alarm

The alarm can be reset in the following manner.

Table8-2 Reset of alarm

No.	Alarm code	Description	Manner of reset
1	ERR00	CPU hung-up	Restart the power supply.
2	ERR01	CPU check failure	In this case if the alarm can't be reset, repair is required.
3	ERR03	Backup data error	Initialization of EEPROM or restart the power supply.
	ERR04	EEPROM wiring error	In this case if the alarm can't be reset, repair is required.
4	Others		Removal of possible cause and restart the power supply. In this case if the alarm can't be reset, repair is required.

8.4 Alarm code list

The alarm has individual code sent from controller as listed below.

Table8-3-1 Alarm code list (Part1)

Code	Description	Contents
WRN	Temp. upper/lower limit	Condition : Fluid temp. is out of limit range. After alarm occurrence: The product continues operating and returns normal condition if the temperature goes back within range. Indication : [WRN] indicator lamp lights up.(Fig8-3)
ERR00	CPU hung-up	Condition : CPU hung-up due to noise etc. After alarm occurrence: The product and communication stop. Indication: [Hung-up of CPU]
ERR01	CPU check failure	Condition: The data of CPU can't be read correctly when the power supply is turned on. After alarm occurrence: The product and communication stop. Indication : [CPU Check Failure]
ERR03	Back-up data error	Condition: The contents of back-up data can't be read correctly when power is turned on. After alarm occurrence: The product and communication stop. Indication: [Back-up Data Error]
ERR04	EEPROM writing error	Condition: EEPROM doesn't allow writing of data. After alarm occurrence: The product and communication stop. Indication: [EEPROM Writing Error]

* When [WRN: Temp. upper/lower limit alarm] occurs, alarm is output to alarm output connector (Temperature alarm) by the relay contacts.

* When [ERR00-ERR20] occurs, alarm is output to alarm output connector (Output cutoff alarm) by the relay contacts. Refer to (9-1 Signal of connector)

Table8-3-2 Alarm code list (Part2)

Code	Description	Contents
ERR11	DC power supply failure	Condition: Switching power supply has a problem (The fan stops and temperature is excessively high.) or Thermo-module is short-circuited. After alarm occurrence: The product (temp. control, pump) stops. Indication: [DC Power Voltage Failure]
ERR12	High temp. cutoff.	Condition: Fluid temp. goes higher than high temp. cutoff setting. Default: 70.0 °C (Standard specification) After alarm occurrence : The product (temp. control, pump) stops. Indication: [Internal Sensor Value is High]
ERR13	Low temp. cutoff.	Condition: Fluid temp. goes lower than low temp. cutoff setting. Default: 0.0 °C After alarm occurrence: The product (temp. control, pump) stops. Indication: [Internal Sensor Value is Low]
ERR14	Thermostat Alarm	Condition: The thermostat is operated due to failure of fan or pump, etc. Thermostat working temp. : 60+/-5 °C (at radiating water side) 90+/-5 °C (at recirculating fluid side) After alarm occurrence: The product (temp. control, pump) stops. Indication: [Thermostat Alarm]
ERR15	Abnormal output	Condition: Temperature change is less than overload judging temp. range even by 100% output for overload judging time period due to application of unacceptable heat load or broken of Thermo-module. Default: 0.2 °C 10min After alarm occurrence: The product continues to operate and output failure alarm is shown. Indication: [Output Failure Alarm]
ERR16 (Note1)	Flow Alarm	Condition: The flow rate of the re-circulating fluid is low. After alarm occurrence: Stops controlling and operation of the pump Indication: [Flow Alarm]
ERR17	Disconnection of internal temp. sensor	Condition: The internal temp. sensor is disconnected or not mounted. After alarm occurrence: The product (temp. control, pump) stop. Indication: [Cutoff/Short of Internal Sensor]
ERR18	Disconnection of external temp. sensor	Condition: The external temp. sensor is disconnected or not mounted. (This condition is detected only in learning control or external tune control.) After alarm occurrence: The product continues controlling at normal control. Indication: [Cutoff/Short of External Sensor]
ERR19	Abnormal auto tuning	Condition: The auto tuning could not finish within 20min. After alarm occurrence: The product (temp. control, pump) stop. Indication: [AT Failure]
ERR20 (Note1)	Low liquid level Alarm	Condition: The level of recirculating fluid in the reservoir is low. After alarm occurrence: The product (temp. control, pump) stop. Indication: [Low Liquid Level Alarm]

* Internal sensor value for alarm is the value that fine control value is decreased from internal sensor value and offset value is not included.

* Internal sensor value from alarm = [Internal sensor value] - [Internal sensor fine control value]

Note1) This part is available as an option.

8.5 Troubleshooting

Troubleshooting methods when the alarm appears is explained as follows.

Table8-4-1 Troubleshooting (Part1)

Code	Reason for alarm setting	Cause
ERR00	(1) High level noise on the power line, ground line or temp. sensor line.	(1) Move the product to an environment with little noise, turn ON the power supply. If there is no alarm, it was caused by noise. Please consult with us.
ERR01	(1) High level noise on the power line, ground line or temp. sensor line.	(1) Move the product to an environment with little noise, turn ON the power supply. If there is no alarm, it was caused by noise. Please consult with us..
ERR03	(1) The EEPROM data was destroyed by high level noise.	(1) Move the product to an environment with little noise, turn ON the power supply. If there is no alarm, it was caused by noise. Please consult with us.
ERR04	(1) Controller EEPROM data has been corrupted due to high-level noise. (2) Writing frequency to EEPROM exceeds product guarantee value (1,000,000 times).	(1)(2)Request a repair if the alarm can't be reset.
ERR11	(1) DC output voltage of product is reduced. (2) Voltage sag happens.	(1) Check the power voltage is 100 to 240VAC (2) If voltage sag lasts over specified value of 50msec, the output of DC power supply reduces and the alarm occurs. Ensure that voltage sag does not happen.
ERR12	(1) Internal temp. sensor value exceeds the high temp. cutoff temperature. (2) Flow rate of recirculating fluid is zero.	(1) Check the set value for high temp. cutoff and confirm the temperature reaches this value. (2) If the flow rate of the recirculating fluid is zero, the temperature of recirculating fluid can't be detected and might increase. Confirm the flow of recirculating fluid isn't stopped by valves etc.
ERR13	(1) Internal temp. sensor value is lower than low temp. cutoff temperature. (2) Flow rate of recirculating fluid is zero.	(1) Check the set value for low temp. cutoff and confirm the temperature reaches this value. (2) If the flow rate of the recirculating fluid is zero, the temperature of recirculating fluid can't be detected and might increase. Confirm the flow of recirculating fluid isn't stopped by valves etc.

Table8-4-2 Troubleshooting (Part2)

Code	Reason for alarm setting	Cause
ERR14	(1) Radiating water temp is high or flow rate is not enough. (2) Flow rate is zero. (3) The pump fails.	(1) Decrease radiating water temp. and increase a flow rate. (2)(3) If flow rate of recirculating fluid is zero, the temperature of recirculating fluid can't be measured and the temperature of heat exchanger may increase. Ensure the recirculating fluid is allowed to flow.
ERR15	(1) Cooling or heating capacity overload. (2) Volume of recirculating fluid system is too large.	(1) If PV temp. changes when the set temp. is raised and down, it causes overload. (2) If the volume of recirculating fluid system is too large, the change of temperature takes a long time. In this case, change overload judging time setting to avoid the this alarm.
ERR16 (Note1)	(1) The flow rate of the re-circulating fluid is 1 +/- 0.5L/min. or less. (2) The Thermo-controller is faulty.	(1) Investigate why the flow rate of the re-circula fluid is low and take countermeasures (2) Replace the Thermo-controller with a new one, and check if it is broken. SMC can repair faulty controllers.
ERR17	High level noise entered the temp. sensor line.	Check if temperature is fluctuated due to the noise. Please consult us if it is caused by noise.
ERR18	The external temp. sensor is not mounted.	For learning control or external tune control, be sure to mount the external temp. sensor.
ERR19	Capacity of recirculating fluid is too large.	Adjust PID value (proportional band, ARW value, integral time and derivative time) of setting mode Level 2 by hand.
ERR20 (Note1)	(1) Fluid level of reservoir is not enough. (2) Fluid is leaking.	(1) Refill fluid. (2) Check all fluid connections connected with the product.

Note1) This part is available as an option.

9 Appendix

This chapter includes information about the connections for the product and a method for calculating the dew point.

9.1 Signal and style of connectors

The type and signals used of each connector that are on the product are shown in the table below.

Table9-1 Signals and Type of Connectors

Description	No.	Signal		Style and Part No.
Power supply connector	1	AC100 to 240V		 IEC60320 C14
	2	AC100 to 240V		
	3	PE		
Communication connector		RS-232C	RS-485	 D-Sub 9pin(Socket) Fixed screw : M2.6
	1	Unused	BUS+	
	2	RD	BUS-	
	3	TD	Unused	
	4	Unused	Unused	
	5	SG	SG	
	6-9	Unused	Unused	

Table9-2 Signal and style of connectors

Description	No.	Signal	Style and part No.
Alarm Output connector	1	Output Cutoff Alarm a contact (OPEN During Alarm)	 <p data-bbox="979 790 1182 853">D-Sub 9pin (Pin) Fixed screw : M2.6</p>
	2	Output Cutoff Alarm Common	
	3	Output Cutoff Alarm b contact (CLOSE During Alarm)	
	4,5	Unused	
	6	Temperature Alarm a contact (OPEN During Alarm)	
	7	Temperature Alarm Common	
	8	Temperature Alarm b contact (CLOSE During Alarm)	
	9	Unused	
	External temperature sensor connector	1,2	
3		Resistance Bulb Terminal A	
4		Resistance Bulb Terminal B	
5		Resistance Bulb Terminal B	
6-14		Unused	
15		FG	

9.2 Power Supply Cable

Table 9-3 Power Supply Cable

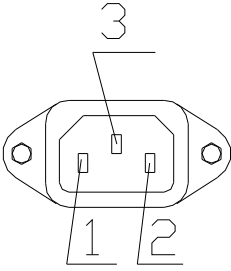
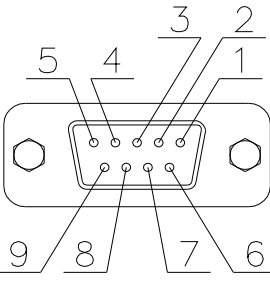
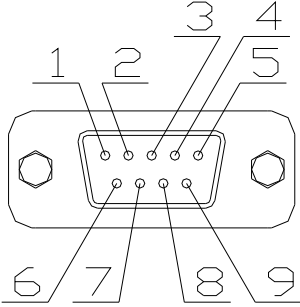
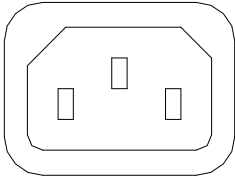
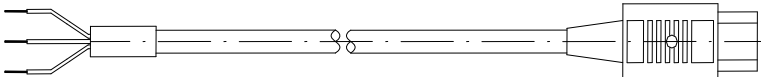
Description	Specifications
Connector	<p>IEC60320 C13</p> <p>Rating Voltage: 250V (VDE) (UL)</p> <p>Rating Current: 10A (VDE) 15A (UL)</p> 
Cable	<p>Rating Voltage: VDE 300/500V UL • CSA 600V</p> <p>AWG14-3</p> <p>Color: Black AC100 to 240V Green/Yellow PE</p>  <p>Power supply cable 2000mm (attachment)</p>

▲ CAUTION

Do not use the included power supply cable for any purposes other than connection to this product.

9.3 Calculation of dew point (from psychrometric chart)

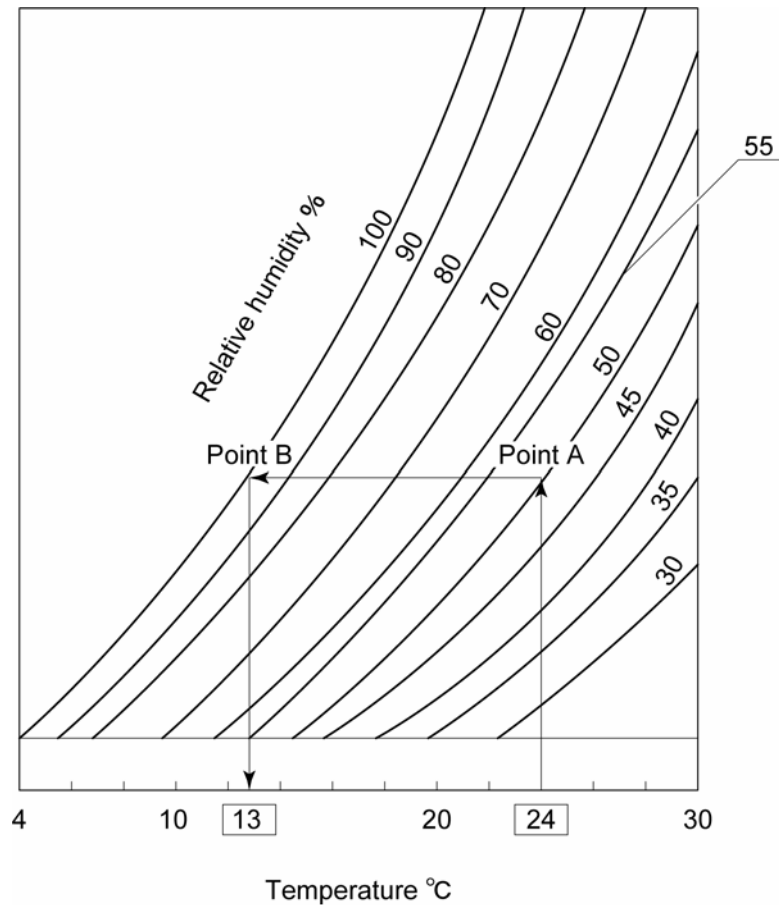

Fig.9-1 Moisture air diagram

- 1) Measure the ambient temperature and relative humidity.
- 2) Plot the ambient temperature on the horizontal axis (Ex. 24 °C), and then draw a perpendicular line.
- 3) Find the intersection (A) of the curve, which is equal to relative humidity (Ex. 50%).
- 4) Draw a line from point (A) parallel to horizontal axis, and find the intersection (B) of the curve for 100% relative humidity.
- 5) Draw a perpendicular line from the intersection at point (B) down to the horizontal axis and read the Dew Point Temperature. (13 °C in this case.)

* Therefore, moisture in the air starts to condensate when the air temperature becomes lower than this temperature.

9.4 Applicable standard/regulation

9.4.1 Overseas standard

The Thermo-con complies with the following standard.

- ◇ CE : EMC 2004/108/EC
Low Voltage Directive 2006/95/EC
- ◇ UL<MET> : UL61010-1
- ◇ SEMI : S2-0706, F47-0200

9.4.2 When the product is exported,

strictly follow the laws required by the Ministry of Economy, Trade and Industry (Foreign Exchange and Foreign Trade Control Law).

SMC Corporation URL <http://www.smcworld.com>

Specifications are subject to change without prior notice and any obligation the part of the manufacturer.

Phone: +81 3 5207 8249 Fax: +81 3 5298 5362 Email: soudansitsu@smcjp.co.jp

2011 SMC Corporation All Rights Reserved