



Operation Manual

PRODUCT NAME

CLAEAN AIR MODULE

MODEL / Series / Product Number

LLB Series

SMC Corporation

Contents

| | | |
|-----|---|--------|
| 1. | Safety Instructions | P3~4 |
| 2. | Clean Air Module / Precautions | P5~6 |
| 3. | Specific Product Precautions | P7~10 |
| 4. | Variations | P11 |
| 5. | Specifications | P12~13 |
| 6. | Flow-rate Characteristics | P14 |
| 7. | Digital Flow Switch Output Specifications | P15 |
| 8. | Functions | P16 |
| 9. | Additional Module Procedure | P17 |
| 10. | Element Replacing Procedure | P18 |



Safety Instructions

These safety instructions are intended to prevent hazardous situations and/or equipment damage. These instructions indicate the level of potential hazard with the labels of “Caution,” “Warning” or “Danger.”

They are all important notes for safety and must be followed in addition to International Standards (ISO/IEC)*1), and other safety regulations.

*1) ISO 4414: Pneumatic fluid power -- General rules relating to systems.

ISO 4413: Hydraulic fluid power -- General rules relating to systems.

IEC 60204-1: Safety of machinery -- Electrical equipment of machines .(Part 1: General requirements)

ISO 10218-1992: Manipulating industrial robots -Safety.

etc.



Caution

Caution indicates a hazard with a low level of risk which, if not avoided, could result in minor or moderate injury.



Warning

Warning indicates a hazard with a medium level of risk which, if not avoided, could result in death or serious injury.



Danger

Danger indicates a hazard with a high level of risk which, if not avoided, will result in death or serious injury.

Warning

1. The compatibility of the product is the responsibility of the person who designs the equipment or decides its specifications.

Since the product specified here is used under various operating conditions, its compatibility with specific equipment must be decided by the person who designs the equipment or decides its specifications based on necessary analysis and test results.

The expected performance and safety assurance of the equipment will be the responsibility of the person who has determined its compatibility with the product.

This person should also continuously review all specifications of the product referring to its latest catalog information, with a view to giving due consideration to any possibility of equipment failure when configuring the equipment.

2. Only personnel with appropriate training should operate machinery and equipment.

The product specified here may become unsafe if handled incorrectly.

The assembly, operation and maintenance of machines or equipment including our products must be performed by an operator who is appropriately trained and experienced.

3. Do not service or attempt to remove product and machinery/equipment until safety is confirmed.

1. The inspection and maintenance of machinery/equipment should only be performed after measures to prevent falling or runaway of the driven objects have been confirmed.

2. When the product is to be removed, confirm that the safety measures as mentioned above are implemented and the power from any appropriate source is cut, and read and understand the specific product precautions

of all relevant products carefully.

3. Before machinery/equipment is restarted, take measures to prevent unexpected operation and malfunction.

4. Contact SMC beforehand and take special consideration of safety measures if the product is to be used in any of the following conditions.

1. Conditions and environments outside of the given specifications, or use outdoors or in a place exposed to direct sunlight.

2. Installation on equipment in conjunction with atomic energy, railways, air navigation, space, shipping, vehicles, military, medical treatment, combustion and recreation, or equipment in contact with food and beverages, emergency stop circuits, clutch and brake circuits in press applications, safety equipment or other applications unsuitable for the standard specifications described in the product catalog.

3. An application which could have negative effects on people, property, or animals requiring special safety analysis.

4. Use in an interlock circuit, which requires the provision of double interlock for possible failure by using a mechanical protective function, and periodical checks to confirm proper operation.



Safety Instructions

Caution

1. The product is provided for use in manufacturing industries.

The product herein described is basically provided for peaceful use in manufacturing industries. If considering using the product in other industries, consult SMC beforehand and exchange specifications or a contract if necessary. If anything is unclear, contact your nearest sales branch.

Limited warranty and Disclaimer/Compliance Requirements

The product used is subject to the following “Limited warranty and Disclaimer” and “Compliance Requirements”.

Read and accept them before using the product.

Limited warranty and Disclaimer

1. The warranty period of the product is 1 year in service or 1.5 years after the product is delivered, whichever is first.*2)

Also, the product may have specified durability, running distance or replacement parts. Please consult your nearest sales branch.

2. For any failure or damage reported within the warranty period which is clearly our responsibility,

a replacement product or necessary parts will be provided.

This limited warranty applies only to our product independently, and not to any other damage incurred due to the failure of the product.

3. Prior to using SMC products, please read and understand the warranty terms and disclaimers

noted in the specified catalog for the particular products.

***2) Vacuum pads are excluded from this 1 year warranty.**

A vacuum pad is a consumable part, so it is warranted for a year after it is delivered.

Also, even within the warranty period, the wear of a product due to the use of the vacuum pad or failure due to the deterioration of rubber material are not covered by the limited warranty.

Compliance Requirements

1. The use of SMC products with production equipment for the manufacture of weapons of mass destruction(WMD) or any other weapon is strictly prohibited.

2. The exports of SMC products or technology from one country to another are governed by the relevant security laws and regulation of the countries involved in the transaction. Prior to the shipment of a SMC product to another country, assure that all local rules governing that export are known and followed.



LLB Series Clean Air Module / Precautions 1

Be sure to read this before handling the products.
Refer to back page 50 for Safety Instructions and pages 6 to 8 for Air Preparation Equipment Precautions.

Design and Selection

Warning

1. Confirm the specifications.

Give careful consideration to the operating conditions such as the application, fluid and environment, and use within the operating ranges specified in this catalog.

2. Ensure sufficient space for maintenance activities.

Provide space required for maintenance.

3. Fluid pressure range

Supplied fluid pressure must be within the operating pressure range specified in the catalog.

Mounting

Warning

1. If air leakage increases or equipment does not operate properly, stop operation.

After mounting is completed, confirm that it has been done correctly by performing a suitable function test and leakage test.

Operating Environment

Warning

1. Do not operate under the conditions listed below due to a risk of malfunction.

In locations having corrosive gases, organic solvents, and chemicals, or in locations in which these elements are likely to adhere to the equipment.

In locations in which salt water, water, or water vapor could come in contact with the equipment.

In locations that are exposed to direct sunlight. (Shield the equipment from sunlight to prevent its resin material from ultraviolet ray degradation or overheating.)

In locations that have a heat source and poor ventilation. (Shield the equipment from heat sources to protect it from softening degradation due to radiated heat.)

In locations that are exposed to shocks and vibrations.

In locations with high humidity or a large amounts of dust.

2. When the product is used for blowing, use caution to prevent the work from being damaged by entrained air from the surrounding area.

When the compressed air is used for air blow, the exhausted air from the blow nozzle may have taken in airborne foreign matter (such as solid particle, fluid particle) from the surrounding air. The foreign matter will be sprayed on the work, and the airborne foreign matter may adhere to it. Therefore, use caution for the surrounding environment.

Recommended Pneumatic Circuit

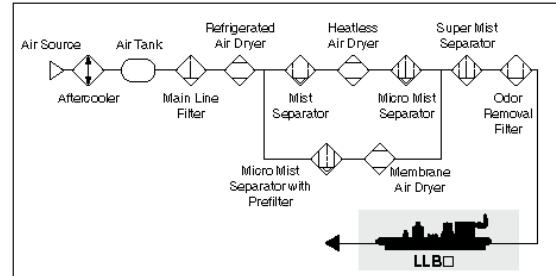

3. ISO compressed air quality class

The class regarding the cleanliness of compressed air (solid particles, moisture and oil) stipulated by ISO 8573-1:1991 (JIS B8392-1:2000)

| Quality class | Maximum particle size (μm) | Minimum pressure dew point (°C) | Maximum oil concentration (mg/m ³) |
|---------------|----------------------------|---------------------------------|--|
| 1 | 0.1 | -70 | 0.01 |
| 2 | 1 | -40 | 0.1 |
| 3 | 5 | -20 | 1.0 |
| 4 | 15 | 3 | 5 |
| 5 | 40 | 7 | 25 |
| 6 | — | 10 | — |

Notation system

Example) Solid particle size: 0.1 μm

Pressure dew point: 3°C

Oil concentration: 0.1 mg/m³

With the above conditions, notation of the quality class is 1, 4, 2.



LLB Series Clean Air Module / Precautions 2

Be sure to read this before handling the products.

Refer to back page 50 for Safety Instructions and pages 6 to 8 for Air Preparation Equipment Precautions.

Piping

Caution

1. Preparation before piping

Before piping is connected, it should be thoroughly blown out with air (flushing) or washed to remove chips, cutting oil and other debris from inside the pipe.

Install piping so that it does not apply pulling, pressing, bending or other forces on the module unit.

2. Be certain that sealing material does not enter the piping.

When connecting pipes, fittings, etc., be sure that chips from the pipe threads and sealing material do not enter the module. Any dust or scale residing in the piping can cause malfunction or failure. Furthermore, when sealant tape is used, leave 1.5 to 2 thread ridges exposed at the end of the threads.

3. Use fittings with resin threads for the connection of fittings to the IN and OUT ports.

Using fittings with metal threads could damage the ports.

Tightening Torque for Thread

| Size | Release torque (N·m) | Tightening torque (N·m) | Tightening guide (Thread rotation number) |
|------|----------------------|-------------------------|---|
| LLB3 | 2 to 3 | 0.5 to 1 | 2 to 3 rotations |
| LLB4 | 8 to 9 | 2 to 3 | 3 to 4 rotations |

4. Connect tubing to the IN and OUT one-touch fittings in accordance with the precautions for one-touch fittings.

Other Tube Brands

Caution

1. When tubing of brands other than SMC's are used, verify that the tubing O.D. satisfies the following accuracy;

- 1) Polyolefin tubing: Within ± 0.1 mm
- 2) Polyurethane tubing: Within $+0.15$ mm, within -0.2 mm
- 3) Nylon tubing: Within ± 0.1 mm
- 4) Soft nylon tubing: Within ± 0.1 mm

Do not use tubing which does not meet these outside diameter tolerances. It may not be possible to connect them, or they may cause other trouble, such as air leakage or the tube pulling out after connection.

The recommended tube for the clean fitting is polyolefin tube. Other tubes can satisfy the performance in terms of leakage, tensile strength, etc., but impair the cleanliness. Note this point for use.



LLB Series

Specific Product Precautions 1

Be sure to read this before handling the products.

Refer to back page 50 for Safety Instructions and pages 6 to 8 for Air Preparation Equipment Precautions.

Precautions on Digital Flow Switch

Design and Selection

Warning

1. Operate the switch only within the specified voltage.

Use of the switch outside the range of the specified voltage can cause not only malfunction and damage of the switch but also electrocution and fire.

2. Do not exceed the maximum allowable load specification.

A load exceeding the maximum load specification can cause damage to the switch.

3. Do not use a load that generates surge voltage.

Although surge protection is installed in the circuit at the output side of the switch, damage may still occur if a surge is applied repeatedly. When a surge generating a load such as a relay or solenoid is directly driven, use a type of switch with a built-in surge absorbing element.

4. The switch does not have explosion proof structure, so do not use flammable gas. Otherwise, fire may occur.

5. Monitor the internal voltage drop of the switch.

When operating below a specified voltage, it is possible that the load may be ineffective even though the pressure switch function is normal. Therefore, the formula below should be satisfied after confirming the minimum operating voltage of the load.

$$\frac{\text{Supply voltage} - \text{Internal voltage drop of switch}}{\text{Minimum operating voltage of load}} >$$

6. Use the switch within the specified flow rate measurement and operating pressure.

Operating beyond the specified flow rate and operating pressure can damage the switch.

Caution

1. Data of the flow switch will be stored even after the power is turned off.

Input data will be stored in EEPROM so that the data will not be lost after the flow switch is turned off. (Data can be rewritten for up to one million times, and data will be stored for up to 20 years.)

2. The accumulated flow rate is reset when power is turned off.

Mounting

Warning

1. Hold the body of the switch when handling.

The tensile strength of the lead wire with connector is 49N. Applying a greater pulling force on it can cause a malfunction. When handling, hold the body of the switch – do not dangle it from the wire.

2. Do not use until you can verify that equipment can operate properly.

Following mounting, repair, or retrofit, conduct suitable function tests after piping and power connections have been made.

3. Never mount a switch in a place that will be used as a scaffold during piping.

Damage may occur if an excessive load is applied to the switch.

Mounting

Warning

4. Be sure to allow straight pipe length that is minimum 8 times the port size for the inlet side of the switch piping.

When abruptly reducing the size of piping or when there is a restriction such as a valve on the inlet side, the pressure distribution in the piping changes and makes accurate measurement impossible.

Wiring

Warning

1. Verify the color and terminal number when wiring.

Incorrect wiring can cause the switch to be damaged and malfunction. Verify the color and the terminal number in the operation manual when wiring.

2. Avoid repeatedly bending or stretching the lead wire.

Repeatedly applying bending stress or stretching force to the lead wire will cause it to break.

3. Confirm proper insulation of wiring.

Make sure that there is no faulty wiring insulation (contact with other circuits, ground fault, improper insulation between terminals, etc.). Damage may occur due to excess current flow into a switch.

4. Do not wire in conjunction with power lines or high voltage lines.

Wire separately from power lines and high voltage lines, avoiding wiring in the same conduit with these lines. Control circuits including switches may malfunction due to noise from these other lines.

5. Do not allow loads to short circuit.

Although switches indicate excess current error if loads are short circuited, all incorrect wiring connections (power supply polarity, etc.) cannot be protected. Take precautions to avoid incorrect wiring.

Operating Environment

Warning

1. Never use in the presence of explosive gases.

The switches do not have an explosion proof rating. Never use in the presence of an explosive gas as this may cause a serious explosion.

2. Mount switches in locations where there is no vibration greater than 98 m/s², or impact greater than 490 m/s².

3. Do not use in an area where surges are generated.

When there are units that generate a large amount of surge in the area around pressure switches, (e.g., solenoid type lifters, high frequency induction furnaces, motors, etc.) this may cause deterioration or damage to the switches' internal circuitry. Avoid sources of surge generation and crossed lines.



LLB Series Specific Product Precautions 2

Be sure to read this before handling the products.

Refer to back page 50 for Safety Instructions and pages 6 to 8 for Air Preparation Equipment Precautions.

Precautions on Digital Flow Switch

Operating Environment

⚠ Warning

4. Switches are not equipped with surge protection against lightning.

Flow switches are CE compliant; however, they are not equipped with surge protection against lightning. Lightning surge protection measures should be applied directly to system components as necessary.

5. Avoid using switches in an environment where the likelihood of splashing or spraying of liquids exists.

Switches are dustproof and splashproof; however, avoid using in an environment where the likelihood of heavy splashing or spraying of liquids exists.

6. Use the switch within the specified fluid and ambient temperature range.

The fluid temperature and ambient temperature ranges are 5 to 45°C, but the accuracy warranted range is 15 to 35°C. Take measures to prevent frozen fluid when using in low temperatures, since this may cause damage to the switch and lead to a malfunction. The installation of an air dryer is recommended to eliminate condensate and moisture. Never use the switch in an environment where there are drastic temperature changes even when these temperatures are within the specified temperature range.

Maintenance

⚠ Warning

1. Perform periodical inspections to ensure proper operation of the switch.

Unexpected malfunctions may cause possible danger.

2. Take precautions when using the switch for an interlock circuit.

When a pressure switch is used for an interlock circuit, devise a multiple interlock system to prevent trouble or malfunctioning, verify the operation of the switch and interlock function on a regular basis.

3. Do not make any modifications to the product.

Measured Fluid

⚠ Warning

1. The fluids that the switch can measure accurately are nitrogen and clean air.

Please note that accuracy cannot be guaranteed when other fluids are used.

2. Never use flammable fluids.

The flow velocity sensor heats up to approximately 150°C.

Others

⚠ Warning

1. Since switch output remains OFF while a message is displayed after the power is turned on, start measurement after a value is displayed.

2. Perform settings after stopping control systems.

When the switch's initial setting and flow rate setting are performed, output maintains the condition prior to the settings.

3. Do not apply excessive rotational force to the display unit.

The integrated type display unit can rotate 90°. If more rotation is required, a separate display unit is available as special order.

4. Be certain to turn on the power when the flow rate is at zero.

Allow an interval of 10 minutes after turning on the power, as there are some changes in the display.

5. Flow rate unit

Switch measures at mass flow rates without being influenced by temperature and pressure. The switches use L/min as the flow rate indicator unit, in which the volumetric flow is substituted for mass flow at 0°C and 101.3 kPa (NOR). The volumetric flow rate at 20°C, 101.3 kPa, and 65%RH (ANR) can be displayed.

Detection Principle of Digital Flow Switch for Air

A heated thermistor is installed in the passage, and fluid absorbs heat from the thermistor as it is introduced to the passage. The thermistor's resistance value increases as it loses heat. Since the resistance value increase ratio has a uniform relationship to the fluid velocity, the fluid velocity can be detected by measuring the resistance value. To further compensate the fluid and ambient temperature, the temperature sensor is also built into the switch to allow stable measurement within the operating temperature range.

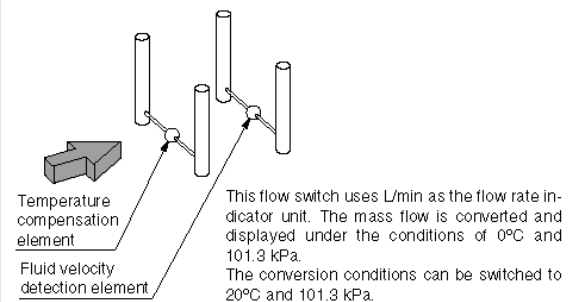



LLB Series Specific Product Precautions 3

Be sure to read this before handling the products.

Refer to back page 50 for Safety Instructions and pages 6 to 8 for Air Preparation Equipment Precautions.

Precautions on Regulator

Pressure Adjustment

⚠ Warning

1. Do not use any tool to operate the pressure regulator knob.

Using a tool to operate the pressure regulator knob may cause breakage. Operate the knob by hand.

⚠ Caution

1. Adjust pressure after unlocking the pressure regulator knob.

If the pressure regulator knob does not rotate, it is locked. Pull up on the pressure regulator knob once to unlock it. Rotating the knob forcibly may break the knob.

After adjusting pressure, lock the knob. Press down on the knob to lock.

2. Adjust pressure by increasing the pressure.

If pressure is adjusted by decreasing the pressure, pressure cannot be set correctly. Rotating the knob clockwise increases the outlet pressure, and rotating the knob counterclockwise decreases the pressure.

3. As this is a non-relief type regulator, rotating the knob counterclockwise does not decrease pressure.

The non-relief type regulator does not decrease outlet pressure even if it is rotated counterclockwise unless the fluid at the outlet side is consumed.

If the knob is rotated forcibly, the knob may break.

If pressure setting is too high, consume fluid at the outlet side once to decrease the outlet pressure to the necessary set pressure or less, and set the pressure again.

4. Check the inlet pressure.

The setting of the outlet pressure should be 85% or less of the inlet pressure. If the inlet pressure is low, pressure cannot be set correctly.

5. Do not operate fluid which contains solid matter.

Otherwise, this may cause malfunction.

6. Oscillation (beat) may occur with some operating conditions even if the operation is within specification. Contact SMC for that case.

Precautions on ON/OFF Valve

Precautions

⚠ Warning

1. The maximum operating pressure and back pressure must be within the specified range.

⚠ Caution

1. Valve leakage

Valve leakage of 1 cm³/min or less (at pneumatic pressure) can happen when shipped from factory.

2. Product with flow adjuster can cause oscillation with some operating conditions if operating flow rate is very small, so examine the flow rate, pressure, and piping conditions carefully before operating.

3. For flow adjustment with flow adjuster, adjust the flow rate by opening the knob gradually from the fully closed state.

Turning the adjusting knob counterclockwise opens the valve. Do not apply excessive force to the knob around the fully open or closed state. Otherwise, the orifice seat can be deformed or the adjusting knob screw can be broken. It is fully closed when shipped from factory.

4. Have a trial run before operation if the valve is not used for long periods of time.

5. Pay attention to the lever operating direction and handling of the lever.

Piping

⚠ Caution

1. Tighten with the tightening torque below for pilot port.

Tightening Torque for Operating Port

| Operating port | Torque (N·m) |
|----------------|---|
| M5 | After tightening by hand, tighten additional 1/6 rotation with a tightening tool. |
| Rc, NPT 1/8 | 0.8 to 1.0 |

2. Use the pilot ports and sensor (respiration) port as follows.

| | PA port | PB port | Sensor (respiration) port |
|---------------|----------------|----------------|---------------------------|
| N.C. | Pressurization | Respiration | Respiration |
| N.O. | Respiration | Pressurization | Respiration |
| Double acting | Pressurization | Pressurization | Respiration |

For N.C. and N.O. type, the port which is not pressurized should be open to atmosphere. If air intake to and exhaust from the valve is not preferable due to ambient atmosphere or dust, install piping to the valve so that the valve can intake/exhaust air at the proper place.

Air Supply for Operation

⚠ Warning

1. Use clean air.

If the compressed air is contaminated with chemicals, synthetic oil including organic solvent, salt, corrosive gas, etc., it may lead to the breakdown or malfunction of the equipment.



LLB Series Specific Product Precautions 4

Be sure to read this before handling the products.

Refer to back page 50 for Safety Instructions and pages 6 to 8 for Air Preparation Equipment Precautions.

Precautions on Restrictor

Precautions

Warning

1. Restrictor cannot be used as a stop valve, which requires zero leakage. It is tolerant to some extent of leakage as a specification.

2. Check the number of rotations of the needle valve.

It does not rotate further because it has a drop-out prevention mechanism. Check the number of needle rotations. Rotating the needle too much may cause damage.

Precautions on Filter

Installation

Warning

1. Air equipment which is mounted on the outlet side may generate dust.

If air equipment is installed on the outlet side, the equipment may generate dust, and it will be a factor to deteriorate cleanliness. Examine the position to install air equipment.

2. Set operating flow rate within the specified range.

[Specified range]

LLB3: 100 L/min (ANR) or less

LLB4: 500 L/min (ANR) or less

If the operating flow rate is out of the specified range, it will cause functional deterioration and breakage.

3. The filter should be installed in a place where pulsation does not occur.

4. This product cannot operate compressed air which contains fluid such as water and oil.

- For the air source for this product, install a dryer, mist separator, micro mist separator, super mist separator, odor removal filter, etc.
- Generally, compressed air contains following particle contaminants:
[Example of particle contaminants contained in compressed air]
 - Moisture (Condensate)
 - Dust in atmospheric air
 - Deteriorated oil exhausted from the compressor
 - Solid foreign matter such as rust or oil in the piping

5. Flush air into the piping for cleaning before installing the product.

To decrease the affect of dust from a connection, also flush air into the piping before using the product for the first time and when replaced.

Maintenance

Warning

1. When removing the product, exhaust the air and ensure the air is released to atmosphere before removing it.

2. When the element comes to the end of its life, immediately replace it with a new filter or replacement element.

Service life of element

1) After 1 year of usage has elapsed.

2) When the set flow rate is not achieved even if it has been less than 1 year since operation started.

Operating Environment

Warning

1. Do not operate under the conditions listed below due to a risk of malfunction.

- In locations having corrosive gases, organic solvents, and chemicals, or in locations in which these elements are likely to adhere to the equipment.
- In locations in which salt water, water, or water vapor could come in contact with the equipment.
- In locations that are exposed to direct sunlight. (Shield the equipment from sunlight to prevent its resin material from ultraviolet ray degradation or overheating.)
- In locations that have a heat source and poor ventilation. (Shield the equipment from heat sources to protect it from softening degradation due to radiated heat.)
- In locations that are exposed to shocks and vibrations.
- In locations with high humidity or a large amounts of dust.





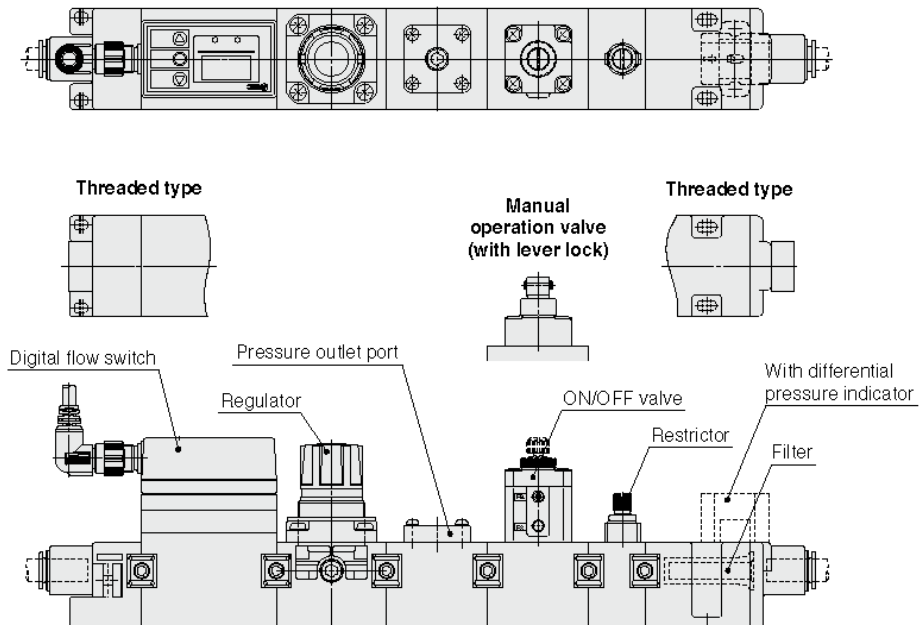

2. When the product is used for blowing, use caution to prevent the work from being damaged by entrained air from the surrounding area.

When the compressed air is used for air blow, the exhausted air from the blow nozzle may have taken in airborne foreign matter (such as solid particle, fluid particle) from the surround air. The foreign matter will be sprayed on the work, and the airborne foreign matter may adhere to it. Therefore, use caution for the surrounding environment.

Variations



Variations

| Flow switch P□  | Regulator R  | Regulator + Pressure outlet port R1  | ON/OFF valve V (V1/V2)  | Restrictor S  | Filter F (F1)  | Weight (kg) | |
|--|---|--|--|--|---|-------------|------|
| | | | | | | LLB3 | LLB4 |
| ● | — | — | — | — | ● | 0.36 | 0.84 |
| ● | ● | — | — | — | ● | 0.52 | 1.18 |
| ● | — | — | ● | — | ● | 0.47 | 1.10 |
| ● | — | — | — | ● | ● | 0.41 | 1.09 |
| ● | — | — | ● | ● | ● | 0.52 | 1.35 |
| ● | ● | — | ● | — | ● | 0.63 | 1.44 |
| ● | ● | — | — | ● | ● | 0.57 | 1.44 |
| ● | — | ● | — | — | ● | 0.59 | 1.36 |
| ● | ● | — | ● | ● | ● | 0.61 | 1.70 |
| ● | — | ● | — | ● | ● | 0.57 | 1.61 |
| ● | — | ● | ● | — | ● | 0.63 | 1.62 |
| ● | — | ● | ● | ● | ● | 0.76 | 1.87 |
| — | ● | — | — | — | ● | 0.33 | 0.90 |
| — | ● | — | — | — | ● | 0.39 | 1.15 |
| — | ● | — | ● | — | ● | 0.44 | 1.16 |
| — | ● | — | ● | ● | ● | 0.50 | 1.41 |
| — | — | ● | — | — | ● | 0.41 | 1.07 |
| — | — | ● | — | ● | ● | 0.46 | 1.32 |
| — | — | ● | ● | — | ● | 0.52 | 1.33 |
| — | — | ● | ● | ● | ● | 0.51 | 1.71 |
| — | — | — | ● | — | ● | 0.28 | 0.82 |
| — | — | — | ● | ● | ● | 0.34 | 1.07 |
| — | — | — | — | ● | ● | 0.23 | 0.81 |
| — | — | — | — | — | ● | 0.19 | 0.49 |

Specifications

| Model | LLB3 | LLB4 |
|-------|------|------|
|-------|------|------|

Clean Air Module Common Specifications

| | | | |
|---|-------------------------------|---|-----------------------|
| Fluid | | Clean air, Ne gas (Inlet air conditions: equivalent to ISO 8573-1 and Quality Class 1.4.1-1.6.1) <small>Note 3)</small> | |
| Maximum operating pressure | | 0.7 MPa | |
| Set pressure | | 0.05 to 0.4 MPa | |
| Withstand pressure | | 1.0 MPa | |
| Fluid temperature | | 5°C to 45°C (No freezing) | |
| Ambient temperature | | * The guaranteed display of digital flow switch ranges between 15 to 35°C. | |
| Flow range <small>Note 1)</small> | | 5 to 100 L/min (ANR) | 50 to 500 L/min (ANR) |
| Nominal filtration rating <small>Note 2)</small> | | 0.01 μm (Filtration efficiency 99.99%) | |
| Fluid contact space | | Grease-free, Silicone-free | |
| Material | Body | PBT | |
| | Module connection seal | FKM | |
| | One-touch fitting seal | EPDM | |

Note 1) The maximum flow rate varies depending on set pressure. Refer to "Flow Rate Characteristics" for detail.

Note 2) According to SMC measurement conditions.

Note 3) Refer to page 344 "Operating Environment."

Digital Flow Switch Unit Specifications

| | | | | |
|--|-----------------------|--|--|--|
| Detection type | | Heat type | | |
| Measured flow range | | 5 to 100 L/min | 50 to 500 L/min | |
| Minimum unit setting | | 1 L/min | 5 L/min | |
| Accumulated pulse flow rate exchange value (Pulse width: 50 [ms]) | | 1 L/pulse | 5 L/pulse | |
| Accumulated flow range | | 0 to 999999 L | | |
| Linearity | | ±5% F.S. or less (15 to 35°C: Based on 25°C) | | |
| Repeatability | | ±2% F.S. or less | | |
| Temperature characteristics | | ±5% F.S. or less (15 to 35°C: Based on 25°C) | | |
| Specifications | Switch output | Maximum load current | 80 mA | |
| | | Maximum applied voltage | 30 VDC (at NPN output) | |
| | | Internal voltage drop | NPN output: 1 V or less (at 80 mA), PNP output: 1.5 V or less (at 80 mA) | |
| | Analog output | Voltage output | Output voltage 1 to 5 V Allowable load resistance 100 kΩ or more | |
| | | Current output | Output current 4 to 20 mA | |
| | | | Allowable load resistance 300 Ω or less (12 VDC), 600 Ω or less (24 VDC) | |
| Status LED's | | Lights up when output is turned ON, OUT1: Green; OUT2: Red (OUT1 only for analog output) | | |
| Response time | | 1 S or less | | |
| Power supply voltage | | 12 to 24 VDC (Ripple ±10% or less) | | |
| Current consumption | | 160 mA or less | 170 mA or less | |
| Withstand voltage | | 1000 VAC for 1 min. between external terminal and case | | |
| Insulation resistance | | 50 MΩ or more (500 VDC measured via megohmmeter) between external terminal and case | | |
| Noise resistance | | 1000 Vp-p, Pulse width 1 μs, Rise time 1 ns | | |
| Lead wire | | Lead wire with connector | | |
| Enclosure | | IP65 | | |
| Fluid contact space material | Mesh | Stainless steel | | |
| | Sensor housing | PBT | | |
| | Sensor | Lead glass (exempted from the RoHS application) | | |
| | | PtIr | | |
| | | FeNi | | |

Regulator Unit Specifications

| | | |
|-------------------------------------|------------|-----|
| Relief mechanism | Non-relief | |
| Fluid contact space material | Diaphragm | FKM |

ON/OFF Valve Unit Specifications

| | | | |
|---|-----------|--------------------------------------|------|
| Pilot pressure (ON/OFF valve operating pressure) | | 0.4 to 0.5 MPa | |
| Back pressure | | 0.4 MPa or less | |
| Valve type | | N.C. | |
| Orifice size | | 4 mm | 8 mm |
| Cv factor | | 0.35 | 1.7 |
| Fluid contact space material | Diaphragm | PTFE | |
| Valve leakage | | 1 cm ³ /min (ANR) or less | |

Specifications

| Model | | LLB3 | LLB4 |
|---|--|-----------------|-----------------------|
| Restrictor Unit Specifications | | | |
| Cv factor | | 0.28 | 1.4 |
| Number of needle rotations | | 8 rotations | 10 rotations |
| Fluid contact space material | Needle | Stainless steel | |
| Filter Unit Specifications | | | |
| Normal filtration rating <small>Note 1)</small> | 0.01 μm (Filtration efficiency 99.99%) | | |
| Element withstand differential pressure <small>Note 2)</small> | 0.5 MPa | | |
| Flow capacity | Up to 100 L/min (ANR) | | Up to 500 L/min (ANR) |
| Fluid contact space material | Filter case | PC | |
| | Hollow fiber | PP | |
| | Potting | PU | |

Note 1) According to SMC measurement conditions.

Note 2) This means that the element will not break at 0.5 MPa. Refer to "Installation" of Specific Product Precautions prior to use.

Component Parts

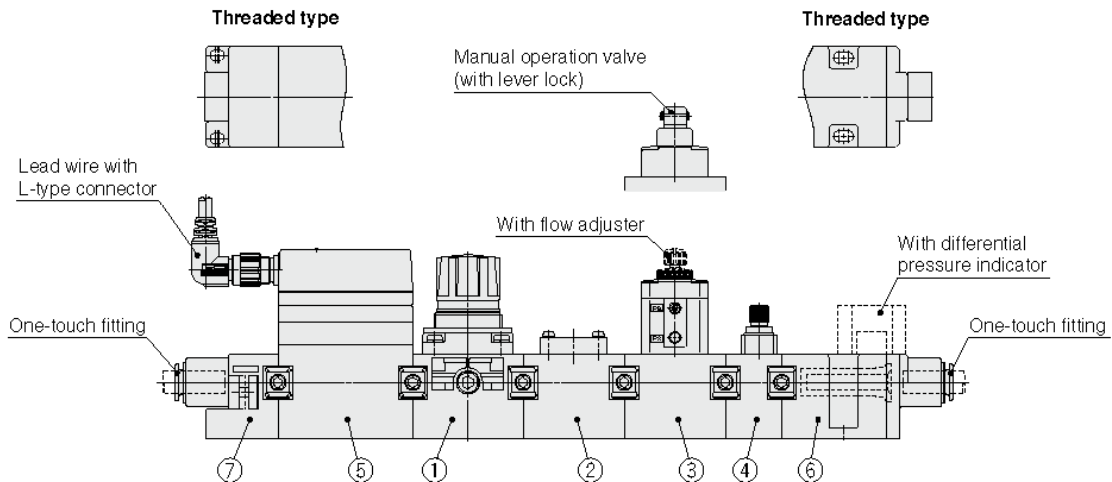

| No. | Description | Individual part no. | | Note | |
|-----|--|---|------------|---|------------------------|
| | | LLB3 | LLB4 | | |
| 1 | Clean regulator assembly | — | LVB4-1 | — | |
| 2 | Pressure outlet port assembly | — | LVB4-2 | — | |
| 3 | ON/OFF valve assembly/ Air operated valve | Without flow adjuster | LVB4-3 | — | |
| | ON/OFF valve assembly/Manual operation valve | With flow adjuster | LVB4-3-1 | — | |
| 4 | Restrictor assembly | — | LVB4-4 | — | |
| 5 | Digital flow switch assembly | 5 to 100 L/min | — | With L-type connector With lead wire (3 m) | |
| | | 50 to 500 L/min | LVB4-6-□ | | |
| 6 | Clean air filter assembly | With ø10 One-touch fitting | LVB3-7-2 | With One-touch fitting | |
| | | Rc 1/4 | LVB3-7-3 | Threaded type | |
| | | NPT 1/4 | LVB3-7-4 | Threaded type | |
| | | With ø10 One-touch fitting, with differential pressure indicator | LVB3-7-2-1 | LVB4-7 (Filter body only) | With One-touch fitting |
| | | Rc 1/4, with differential pressure indicator | LVB3-7-3-1 | | Threaded type |
| | | NPT 1/4, with differential pressure indicator | LVB3-7-4-1 | | Threaded type |
| 7 | End plate assembly | Replacement element | SFD-EL101 | — | |
| | | With ø10 One-touch fitting | LVB3-8-2 | — | |
| | | Rc 1/4 | LVB3-8-3 | — | |
| | | NPT 1/4 | LVB3-8-4 | — | |
| | | With ø12 One-touch fitting | — | LVB4-8-1 | With One-touch fitting |
| | | Rc 3/8 | — | LVB4-8-2 | Threaded type |
| | | NPT 3/8 | — | LVB4-8-3 | Threaded type |

* Each module has 2 connecting brackets.

Flow Rate Characteristics

LLB3-1-P1R1VSF: Standard (100 L/min)

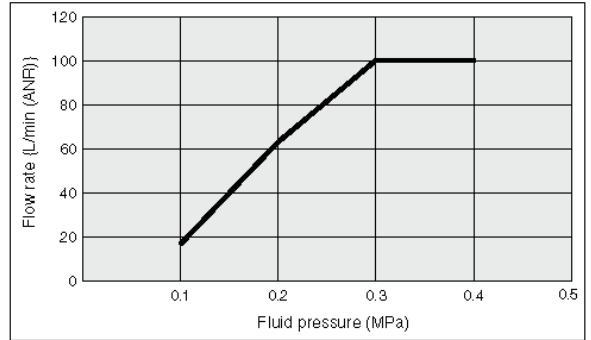
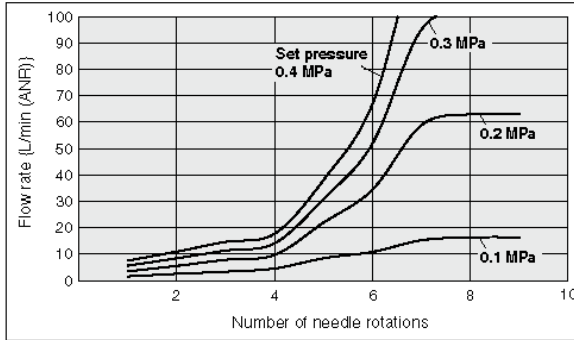

LLB4-1-P1R1VSF: High Flow Type (500 L/min)

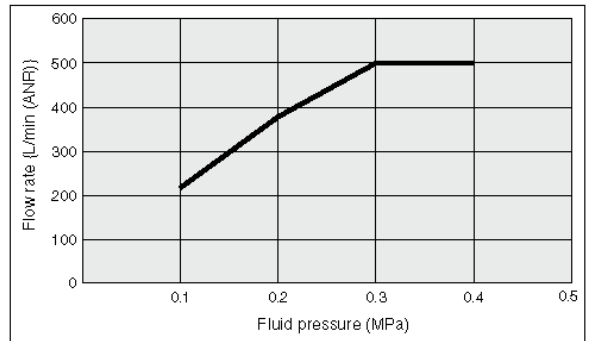
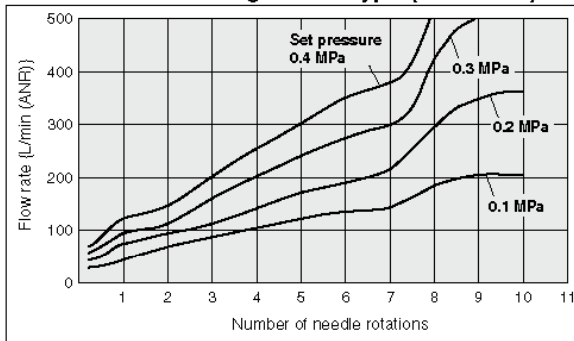

<Test Conditions>

Model: LLB3-1-P1R1VSF and LLB4-1-P1R1VSF

Supplied pressure: 0.5 MPa

Pressure setting condition and measured position: Pressure is set by turning the regulator knob with ON/OFF valve turned off.
 Pressure is measured at the pressure outlet port.

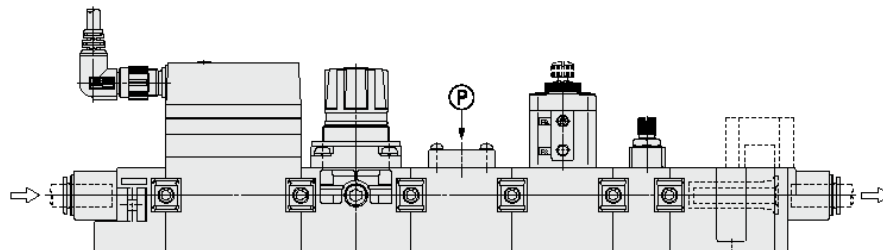

Digital Flow Switch Output Specifications

• Analog output

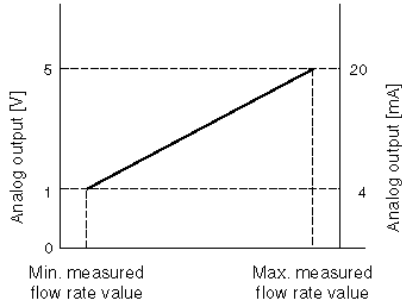

Flow Rate Range by Type

| Model | Normal condition (L/min) [nor] | | Standard condition (L/min) [ANR] | |
|-------|----------------------------------|----------------------------------|----------------------------------|----------------------------------|
| | Minimum measured flow rate range | Maximum measured flow rate range | Minimum measured flow rate range | Maximum measured flow rate range |
| LLB3 | 5 | 100 | 5 | 107 |
| LLB4 | 50 | 500 | 55 | 535 |

• Connector pin numbers

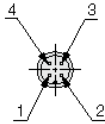

| Pin no. | Pin description |
|---------|-----------------|
| 1 | DC (+) |
| 2 | Analog output |
| 3 | DC (-) |
| 4 | OUT1 |

• Internal circuits and wiring examples

NPN open collector 2 outputs LLB□-□-**P3**□□□F (F1)

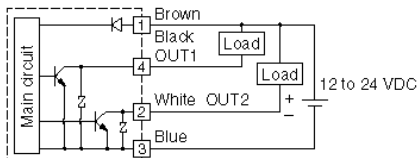

Max. 30 V, 80 mA
Internal voltage drop 1 V or less

PNP open collector 2 outputs LLB□-□-**P4**□□□F (F1)

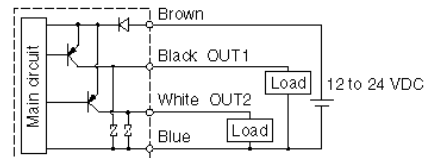

Max. 80 mA
Internal voltage drop 1.5 V or less

NPN open collector 1 output + Analog output LLB□-□-**P1**□□□F (F1)

LLB□-□-**P5**□□□F (F1)

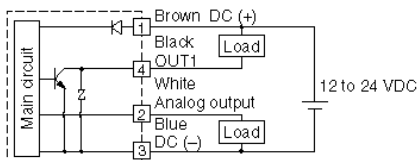

P1: Analog output 1 to 5 V
Allowable load resistance 100 kΩ or more
P5: Analog output 4 to 20 mA
Allowable load resistance 300 Ω or less (12 VDC),
600 Ω or less (24 VDC)

PNP open collector 1 output + Analog output LLB□-□-**P2**□□□F (F1)

LLB□-□-**P6**□□□F (F1)

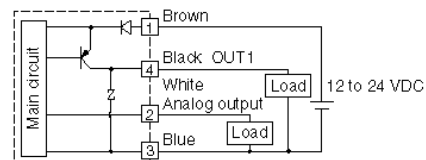

P2: Analog output 1 to 5 V
Allowable load resistance 100 kΩ or more
P6: Analog output 4 to 20 mA
Allowable load resistance 300 Ω or less (12 VDC),
600 Ω or less (24 VDC)

Functions

Refer to the operation manual for how to set and to operate.

Flow rate selection display

Real-time flow rate and accumulated flow rate can be selected. Up to 999999 of flow rate value can be accumulated.
The accumulated flow rate is reset when power is turned off.

Flow rate conversion

Normal condition {0°C, 101.3 kPa, Dry air} or standard condition (ANR) {20°C, 101.3 kPa, 65% RH} can be selected.

Flow rate confirmation display

This function allows the accumulated flow rate confirmation when real-time flow rate is selected, and the real-time flow rate confirmation when accumulated flow rate is selected.

Key lock

This function prevents incorrect operations such as changing the set value accidentally.

Error correction

| LED display | Contents | Solution |
|-------------|--|---|
| Er 1 | A current of more than 80 mA is flowing to OUT1. | Check the load and wiring for OUT1. |
| Er 2 | A current of more than 80 mA is flowing to OUT2. | Check the load and wiring for OUT2. |
| Er 4 | The setting data has changed for whatever reasons. | Perform the RESET operation, and reset all data again. If the setting does not return to the factory setting, inspection needs to be performed by SMC. |
| --- | The flow rate is over the flow rate measurement range. | Reduce the flow rate until it is within the flow rate measurement range, using an adjustment valve. |

Output types

Real-time switch output, accumulated switch output, or accumulated pulse output can be selected as an output type.

Real-time switch output

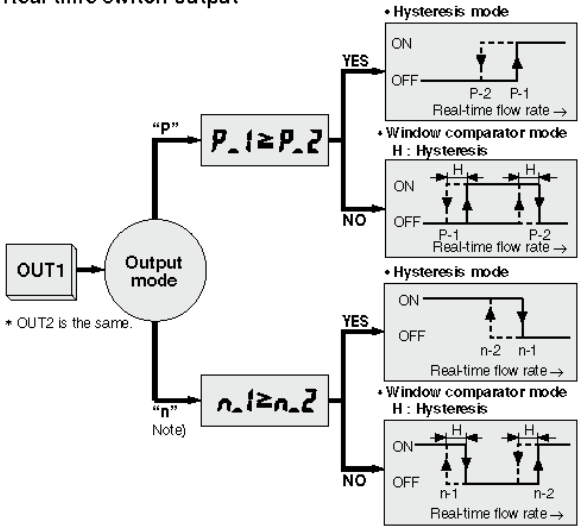

Note) Output mode is set to inverted output when shipped from factory.

Accumulated switch output

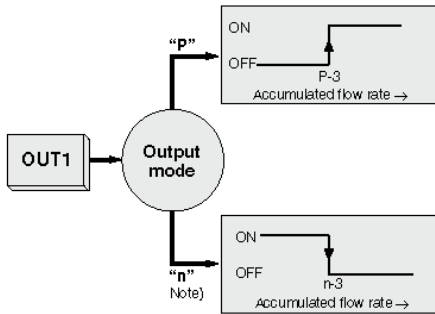

Note) Output mode is set to inverted output when shipped from factory.

Accumulated pulse output

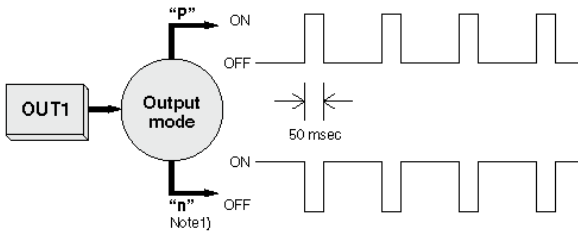

Note 1) Output mode is set to inverted output when shipped from factory.
Note 2) Refer to the specifications of display unit for the flow rate value per pulse.

Additional Module Procedure

LLB3

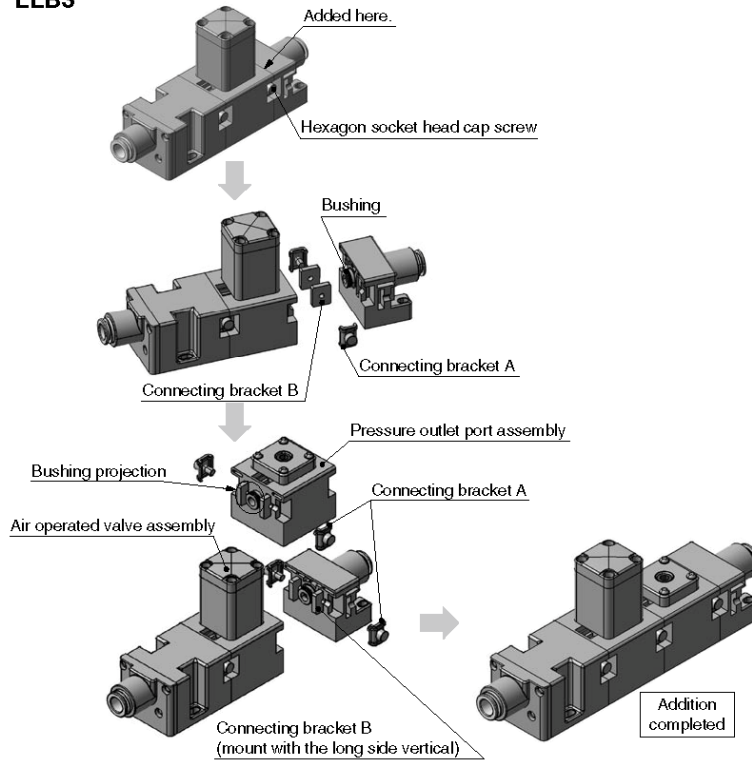

Example: Addition of the pressure outlet port assembly (LVB3-2)

- ① Loosen two hexagon socket head cap screws at the position where the clean air module is added, and remove the connecting bracket A.
- ② After removing the connecting bracket A, separate the forward and backward blocks from each other.
Note) Do not lose the connecting bracket A.
- ③ Check that the connecting brackets B (at two positions) are attached, and insert the bushing projection of the pressure outlet port assembly into the indent of the air operated valve assembly. Similarly, insert the end plate assembly into the pressure outlet port assembly.
- ④ Mount the connecting bracket A, and tighten the hexagon socket head cap screw with the following torque.
Tightening torque: 1.0 to 1.4 N·m

LLB4

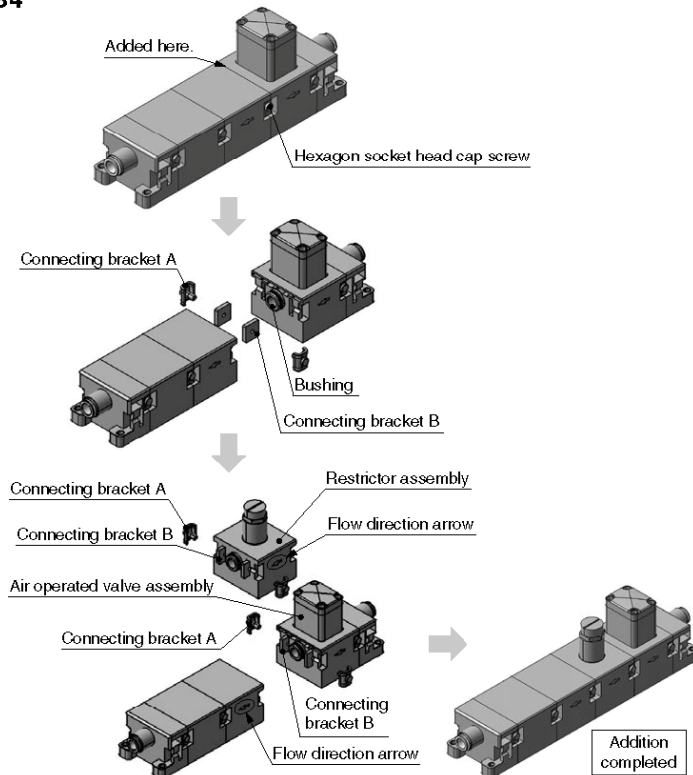

Example: Addition of the restrictor assembly (LVB4-4)

- ① Loosen two hexagon socket head cap screws at the position where the clean air module is added, and remove the connecting bracket A.
- ② After removing the connecting bracket A, separate the forward and backward blocks from each other.
Note) Do not lose the connecting bracket A.
- ③ Check that the connecting brackets B (at two positions) are attached, and assemble the restrictor assembly on the groove of the block with care as to the direction of the restrictor assembly. Similarly, connect the air operated valve assembly to the restrictor assembly.
Note) The arrow on the module and the arrow on the block must point in the same direction.
- ④ Mount the connecting bracket A, and tighten the hexagon socket head cap screw with the following torque.
Tightening torque: 1.6 to 2.0 N·m

Element Replacing Procedure

LLB3

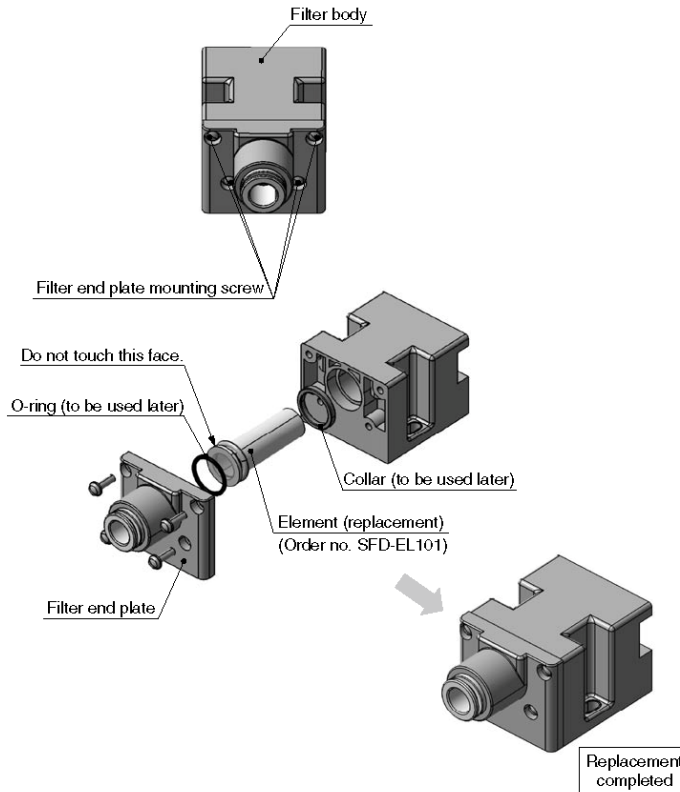

- ① Loosen the four filter end plate mounting screws on the clean air module.
- ② After removing the filter end plate, take out the element.
Note) Do not lose the collar and O-ring.
- ③ Assemble a new element on the filter body.
- ④ Mount the filter end plate, and tighten the screws with the following torque.
Tighten the screws diagonally so that torque can be given to the screws evenly.
Tightening torque: 0.45 to 0.55 N·m
- ⑤ After replacing the elements, flush air before operation.

LLB4

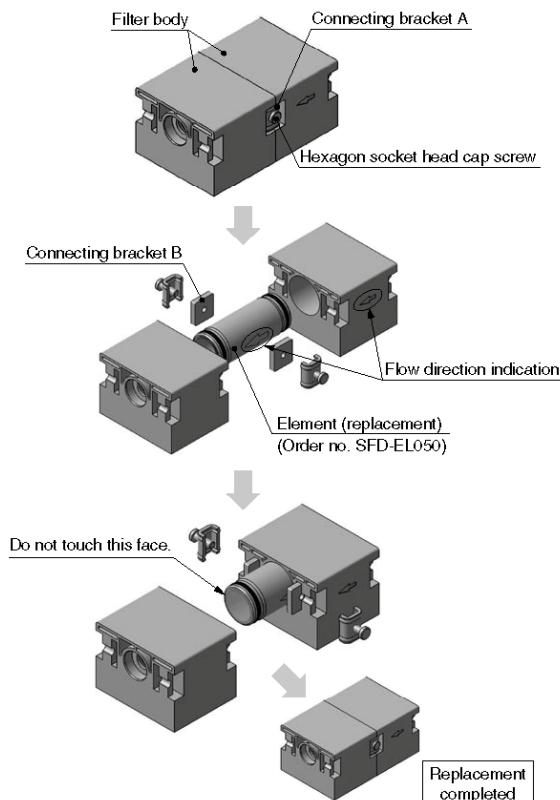

- ① Remove the clean air filter from the clean air module.
+ Refer to the additional module procedure on page 342 for removal.
- ② Loosen two hexagon socket head cap screws and remove the connecting bracket A.
- ③ After removing the connecting bracket A, open the filter body, and take out the element.
Note) Do not lose the connecting bracket.
- ④ Assemble a new element on the filter body.
Note) The arrow on the element and the arrow in the filter body must point in the same direction.
- ⑤ Check that two connecting brackets B are attached to the filter body, and assemble the filter body to the groove of the block.
- ⑥ Mount the connecting bracket A on the assembled filter body, and tighten the hexagon socket head cap screw with the following torque.
Tightening torque: 1.6 to 2.0 N·m
- ⑦ After replacing the elements, flush air before operation.

| Revision history |
|--|
| A: Creating a new chart by changing specifications |

SMC Corporation

4-14-1, Sotokanda, Chiyoda-ku, Tokyo 101-0021 JAPAN

Tel: + 81 3 5207 8249 Fax: +81 3 5298 5362

URL <http://www.smcworld.com>

Note: Specifications are subject to change without prior notice and any obligation on the part of the manufacturer.

© 2018 SMC Corporation All Rights Reserved